



Presented to the
LIBRARY *of the*
UNIVERSITY OF TORONTO

FROM THE LIBRARY
OF
WILLIAM T. FEE

THE NEW
INTERNATIONAL
ENCYCLOPÆDIA

EDITORS

DANIEL COIT GILMAN, LL. D.

PRESIDENT OF JOHNS HOPKINS UNIVERSITY (1876-1901)

PRESIDENT OF CARNEGIE INSTITUTION

HARRY THURSTON PECK, PH. D., L. H. D.

PROFESSOR IN COLUMBIA UNIVERSITY

FRANK MOORE COLBY, M. A.

LATE PROFESSOR OF ECONOMICS

IN NEW YORK UNIVERSITY

VOLUME XIV

NEW YORK
DODD, MEAD AND COMPANY

1903

11524

Copyright, 1903
BY DODD, MEAD AND COMPANY
All rights reserved

ME
5
11524

ILLUSTRATIONS IN VOLUME XIV.

COLORED PLATES

	FACING PAGE
FISHES OF THE PHILIPPINES	22
PIGEONS	128
POISONOUS PLANTS	272
PORCELAIN—I.	370
PORCELAIN—II.	372
FRENCH POSTER	422
ABORIGINAL POTTERY, UNITED STATES	440
DOMESTIC FOWLS	446

MAPS

PHILADELPHIA	2
PHILIPPINE ISLANDS	20
PITTSBURG	188
PORTO RICO	390
PORTUGAL.	400
PRINCE EDWARD ISLAND	516
PRUSSIA	606
QUEBEC	718
QUEENSLAND	726
RAINFALL	790
RHODE ISLAND	1028

ENGRAVINGS

PHILADELPHIA	4
PHILIPPINE ISLANDS	24
PIGEONS	130
PINES	150
PINES	152
PISA	174
PISTOLS AND REVOLVERS	180
PLECTOGNATH FISHES	230
PLOVERS	240
PNEUMATIC TOOLS	258
POLYCLITUS AND PRAXITELES	332
POMPEII	346
POPLARS	366
POPPY AND PEPPER TREE	368
PORCUPINES AND HEDGEHOGS	374
POTTER, PAUL ("The Bull")	438
PRINTING—BOOK AND MAGAZINE PRESSES	524

	FACING PAGE
PRINTING—DOUBLE OCTUPLE NEWSPAPER PRESS	526
PSYCHOLOGICAL APPARATUS	626
PSYCHOLOGICAL APPARATUS	628
PTERIDOPHYTES	634
PUEBLO OF ZUNI INDIANS	646
PUMPING MACHINERY	662
PUMPING MACHINERY	664
PYRAMIDS	690
RAILS, GALLINULES, AND JACANA	770
RAPIHAEL ("Sistine Madonna")	822
RATTLESNAKES	836
RAUCH (Statue of Frederick the Great)	838
RAYS AND SKATES	844
RECRUITMENT	880
REDWOOD	892
REMBRANDT ("The Syndics of the Drapers")	942
RENI, GUIDO ("Aurora")	954

KEY TO PRONUNCIATION.

ā	as in ale, fate. Also see ǎ , below.	D	as in the Spanish Almodovar, <i>pulgada</i> , where it is nearly like <i>th</i> in English <i>then</i> , this.
ā	“ “ senate, chaotic. Also see ǎ , below.	g	“ “ go, get.
ā	“ “ glare, care.	G	“ “ the German Landtag, and <i>ch</i> in <i>Feuerbach</i> , <i>buch</i> ; where it is a guttural sound made with the back part of the tongue raised toward the soft palate, as in the sound made in clearing the throat.
ā	“ “ am, at.	H	as <i>j</i> in the Spanish <i>Jijona</i> , <i>g</i> in the Spanish <i>gila</i> ; where it is a fricative somewhat resembling the sound of <i>h</i> in English <i>hue</i> or <i>y</i> in <i>yet</i> , but stronger.
ā	“ “ arm, father.	hw	“ <i>wh</i> in which.
ā	“ “ ant, and final <i>a</i> in <i>America</i> , <i>armada</i> , etc. In rapid speech this vowel readily becomes more or less obscured and like the neutral vowel or a short <i>u</i> (ǔ).	K	“ <i>ch</i> in the German <i>ich</i> , <i>Albrecht</i> , and <i>g</i> in the German <i>Arensberg</i> , <i>Mecklenburg</i> ; where it is a fricative sound made between the tongue and the hard palate toward which the tongue is raised. It resembles the sound of <i>h</i> in <i>hue</i> , or <i>y</i> in <i>yet</i> ; or the sound made by beginning to pronounce a <i>k</i> , but not completing the stoppage of the breath. The character K is also used to indicate the rough aspirates or fricatives of some of the Oriental languages, as of <i>kh</i> in the word <i>Khan</i> .
a	“ “ final, regal, where it is of a neutral or obscure quality.	n	as in <i>sinker</i> , longer.
a	“ “ all, fall.	ng	“ “ sing, long.
a	“ “ eve.	N	“ “ the French <i>bon</i> , <i>Bourbon</i> , and <i>m</i> in the French <i>Etampes</i> ; where it is equivalent to a nasalizing of the preceding vowel. This effect is approximately produced by attempting to pronounce ‘onion’ without touching the tip of the tongue to the roof of the mouth. The corresponding nasal of Portuguese is also indicated by N , as in the case of <i>São Antão</i> .
æ	“ “ elate, evade.	sh	“ “ shine, shut.
æ	“ “ end, pet. The characters ě , ā , and ǎ are used for ä in German, as in <i>Gärtner</i> , <i>Gräfe</i> , <i>Hähnel</i> , to the values of which they are the nearest English vowel sounds. The sound of Swedish ä is also indicated by ě .	th	“ “ thrust, thin.
ě	“ “ fern, her, and as <i>i</i> in <i>sir</i> . Also for ö , oe , in German, as in <i>Göthe</i> , <i>Goethe</i> , <i>Ortel</i> , <i>Oertel</i> , and for <i>eu</i> and <i>oeu</i> in French, as in <i>Neufchâtel</i> , <i>Crêvecœur</i> ; to which it is the nearest English vowel sound.	TH	“ “ then, this.
e	“ “ agency, judgment, where it is of a neutral or obscure quality.	zh	as <i>z</i> in <i>azure</i> , and <i>s</i> in <i>pleasure</i> . An apostrophe ['] is sometimes used to denote a glide or neutral connecting vowel, as in <i>tā'b'l</i> (<i>table</i>), <i>kāz'm</i> (<i>chasm</i>).
i	“ “ ice, quiet.		Otherwise than as noted above, the letters used in the respellings for pronunciation are to receive their ordinary English sounds.
i	“ “ quiescent.		When the pronunciation is sufficiently shown by indicating the accented syllables, this is done without respelling; as in the case of very common English words, and words which are so spelled as to insure their correct pronunciation if they are correctly accented. See the article on PRONUNCIATION .
i	“ “ ill, fit.		
ī	“ “ old, sober.		
ō	“ “ obey, sobriety.		
ō	“ “ orb, nor.		
ō	“ “ odd, forest, not.		
o	“ “ atom, carol, where it has a neutral or obscure quality.		
oi	“ “ oil, boil, and for <i>eu</i> in German, as in <i>Feuerbach</i> .		
oo	“ “ food, fool, and as <i>u</i> in <i>rude</i> , <i>rule</i> .		
ou	“ “ house, mouse.		
ū	“ “ use, mule.		
ū	“ “ unite.		
ū	“ “ cut, but.		
ū	“ “ full, put, or as <i>oo</i> in <i>foot</i> , <i>book</i> . Also for ü in German, as in <i>München</i> , <i>Müller</i> , and <i>u</i> in French, as in <i>Buchez</i> , <i>Budé</i> ; to which it is the nearest English vowel sound.		
û	“ “ urn, burn.		
y	“ “ yet, yield.		
B	“ “ the Spanish <i>Habana</i> , <i>Cordoba</i> , where it is like a <i>v</i> made with the lips alone, instead of with the teeth and lips.		
ch	“ “ chair, cheese.		

Digitized by the Internet Archive
in 2009 with funding from
Ontario Council of University Libraries

THE NEW INTERNATIONAL ENCYCLOPÆDIA

P**HILADELPHIA** (Lat., from Gk. *Φιλαδέλφεια*, *Philadelphēia*, named in honor of Attalus Philadelphus). A city of Asia Minor, now called Alashehr (the 'reddish city,' from the color of the hillsides in the rear), situated in the valley which runs inward from the Gulf of Smyrna, about 75 miles east by south of Smyrna (Map: Turkey in Asia, C 3). The city was founded in the second century B.C. It lay on the trade routes from the interior to the coast and assumed a position of commercial importance. Its name was changed at different times, as shown by the coins of Roman emperors, and it was a point of considerable importance in the political affairs of the Province of Asia. Philadelphia was the head of a district in which Christian churches were established very early, since messages were sent to it in the Book of Revelation (iii. 7-13). Little is known concerning the number or size of these churches. Philadelphia bore a conspicuous part in later history, figuring as a bulwark against the Turks. See ALASHEHR.

PHILADELPHIA. The chief city of Pennsylvania, and the third city in population and importance of the United States, co-extensive with Philadelphia County, having an area of 129.5 square miles. It is situated in the southeastern corner of the State, at the confluence of the Schuylkill with the Delaware, about 50 miles from the mouth of the Delaware and 100 miles from the Atlantic Ocean, in latitude 39° 57' N. and longitude 75° 9' W. It is distant from New York by rail 90 miles, from Washington 132, and from Chicago 822.

The climate of Philadelphia is considerably milder in winter and warmer in summer than that of the central and western cities of the State. The mean temperature for January is 32.3°, and for July 76.2°. The heat during July and August is often very intense, the temperature rising sometimes above 100°. The average annual rainfall in the city is about 44 inches, slightly heavier than that of New York.

DESCRIPTION. William Penn founded the city on the narrow neck of land, some two miles wide, lying between the Delaware and Schuylkill

ivers. Disregarding his plan for a simultaneous growth of the city backward from each river, the early settlers preferred to remain near the Delaware, along which occurred the first north and south expansion of the city. It was not until the beginning of the nineteenth century that the westward growth of the city reached Broad Street, the half-way line to the Schuylkill. From this time on the city has grown more rapidly, extending southward to the junction of the two rivers, westward far beyond the Schuylkill to Cobb's Creek, and northward in two main branches, the easternmost following the Delaware to Poquessing Creek, eighteen miles from the southern limit, and the westerly through the suburban region stretching ten miles along the Wissahickon—a tributary of the Schuylkill. In the western and northern sections of the city large areas of open country still exist. From the dike-protected lowlands of the south, five feet below the average high tide, the city rises gradually to heights of 443 feet in the hilly regions of the northwest. The general plan of the streets is determined by the east and west direction of Market Street, the main business thoroughfare, 100 feet wide, which runs directly west from the Delaware, a distance of six miles, separating the city for the purpose of street numbering into north and south divisions; and by Broad Street, 113 feet wide and 12 miles long, which at City Hall Square intersects Market at right angles. The main portion of the city is laid out with great regularity, the numbered streets running parallel with Broad, and the named streets with Market. The regularity of the general plan is broken, however, in the portion east of the Schuylkill, by Ridge and Germantown avenues, which intersect diagonally the streets north of Market, and by Passyunk and Moyamensing avenues, south of Market Street; in West Philadelphia, Lancaster Avenue, north, and Woodland Avenue, south of Market Street, act in a similar manner, though in this and in other outlying sections there is, in general, less attempt to follow strictly the regularity of the older portions of the city. There are more than 1560 miles of streets, of which

some 900 miles are paved with brick, stone, or asphalt, 225 macadamized, and the remainder unpaved. The mileage of sewers is 951 and of water mains 1319. The street railways (employing the overhead trolley system, and in 1902 carrying 325,801,963 passengers) have a total mileage of 475, and the steam railroads of 360. At the present time (1903) there is under construction a subway system of four tracks from the Delaware to the Schuylkill, with an elevated extension along Market Street from the Schuylkill to the city line. Twelve public and twelve railroad bridges cross the Schuylkill, and one railroad bridge the Delaware; and among these are some of the finest structures of the kind in the country.

It is possible to characterize with tolerable accuracy the various sections of Philadelphia. The business life centres around Market Street. The portion north and south of this thoroughfare bordering the Delaware is devoted to wholesale trade, shipping, and warehouses; from Third Street to Eighth, Market, Chestnut, and Walnut may be designated as the financial and banking centre of the city; these streets, with Arch, from Eighth to City Hall, form the great retail shopping section, where are found the great department stores. The large office buildings cluster about the City Hall, at the junction of Broad and Market Streets, in the vicinity of which are also found the Pennsylvania and Reading depots and the Baldwin Locomotive Works. Westward from the City Hall, Market Street is lined by smaller wholesale and retail establishments; while beyond the Schuylkill, Lancaster and Woodland avenues dispute its supremacy in retail trade. The northeastern section, comprising Kensington and Frankfort, and certain portions of the northwest section form the chief textile centre of the city; the northeast section at Port Richmond is also the location of Cramp's ship-yards. The southern portion, east of the Schuylkill, is devoted to general manufactures and to transportation.

The residential portions of the city seem to be as clearly divided by Market Street as are the business interests. South of that thoroughfare, on Chestnut, Walnut, and Spruce streets, centring about Rittenhouse Square, is the aristocratic residential section of the city. North of Market the upper portion of Broad Street, with portions of other streets between it and the Schuylkill, forms another important residence area. North of this comes the residential section occupied largely by textile operatives. South of Market and extending a few blocks below Lombard is the section occupied by the foreign and colored elements, with the former, consisting largely of Italians and Hebrews, grouped to the east of Broad, and the negroes between Broad and the Schuylkill. In this region are located most of the slums of the city, though the peculiarities of the building plan permit them to exist in the rear of the best residential sections. West of the Schuylkill, Market Street continues to divide West Philadelphia into two distinct residential portions; for the northern the character is largely determined by the proximity of the main freight yards of the Pennsylvania Railroad, whose employees, together with employees from the downtown business district, constitute the bulk of its population. The southern is a

more pretentious residence district, with many notable residences and with an academic air imparted to it by the presence of the University of Pennsylvania. Especially noted for their villas and gardens are the attractive suburbs of Germantown and Chestnut Hill; and in the general beauty of its numerous suburban sites Philadelphia is unsurpassed by any city of the world.

By its name Philadelphia suggests its distinctive title "The City of Brotherly Love;" its early history renders especially appropriate that of "the Quaker City;" but none more truly characterizes it than that of "The City of Homes." Of 323,783 buildings of all kinds (1903), 298,144 are dwelling houses, with an average of 4.5 persons per dwelling, and with 22 per cent. owned by the occupants. There are 800 church buildings, 474 schools, public and private, and 247 buildings used for charitable and benevolent purposes. In the older portions there are many survivals of the long blocks of red brick houses, with white marble steps and trimmings, that early gave Philadelphia the neat appearance for which it is still famous. In the newer portions red brick is still the principal building material, and the residences are commonly built in long blocks of houses of four or more similarly arranged rooms, each separated from its neighbors by a brick party-wall, and varying in size with the width of the street. On some of the larger streets the houses are built in pairs, instead of blocks, but the arrangement of the separate houses is the same. There is, however, a more welcome variety in styles of architecture than formerly, and various kinds of building stone, along many streets, are beginning to break the monotony of the customary brick, while in the better suburbs the residences are almost wholly of stone or wood. In general, Philadelphia, in its homes and parks, may be said to retain to a greater degree than any other large American city the finer qualities of its early town life and to combine with these the best features of modern industrial development.

BUILDINGS. Adherence to an early architectural idea has made Philadelphia one of the last of large American cities to favor tall buildings. Very recently, however, a group of tall structures has sprung up in the vicinity of the 'Public Buildings,' as Philadelphians designate their City Hall. This immense structure, begun in the early 70's, and covering 4½ acres, accommodates all the municipal and county officers, and the State and county courts. It is a marble edifice, of modern French Renaissance style, 90 feet high, rising in corner pavilions to 161 feet, in central pavilions to 203 feet, and in the tower surmounted by a colossal statue of Penn 37 feet high and weighing 53,348 pounds) to a height of 547 feet 11¼ inches. The building, inclosing a large central court, measures 486 feet 6 inches by 470 feet, and in it are 634 rooms, with a floor space of 14½ acres. In the tower are four great clock dials, each with a minute hand eleven feet long and weighing 225 pounds, and regulated by a vibration and temperature proof clock 143 feet below. The cost of the Public Buildings up to December 31, 1902, was \$24,344,350, of which some \$18,250,000 was for construction proper.

Among the important Federal buildings located within the city are the new United States Mint, on Spring Garden Street, one of the largest and most completely equipped in the world; the Post



Office Building, bounded by Market, Chestnut, Tenth and Ninth, occupying the site of the first President's Mansion and the subsequent home of the University of Pennsylvania; the Custom House, on Chestnut Street near the Delaware, modeled after the Parthenon, and erected in 1819-24 for the Second United States Bank; the Arsenal, below South Street near the Schuylkill; and at the southern end of Broad Street, the large League Island Navy Yard. Of the historic buildings the most important are the familiar Independence Hall and Carpenter's Hall on Chestnut Street, inseparably associated with the early Continental and Federal Congresses; the Betsy Ross House on Arch Street, where the first American flag was made; the Old Swedes (1700) and Old Christ (1727) churches of Revolutionary fame; and the first United States Mint, on Seventh Street below Market. The Pennsylvania Historical Society, one of the strongest organizations of its kind in the country, has an elegant building at Thirteenth and Locust streets.

Now that Philadelphia has adopted the modern steel frame building (with a careful regulation of height, however), its recent business structures will compare favorably in size and importance with those of any other American city. Among the leading office buildings may be mentioned the Land Title Annex (319 feet high); the pioneer Betz Building; the Real Estate Trust Building; the Arcade Building, and the Commonwealth Trust Building—all grouped around the City Hall; and the Real Estate Title and Trust Company Building, the Drexel Building, the Bullitt Building, and the Provident Building—notable structures of the financial area. In this vicinity, also, is the Philadelphia Contributionship 'Hand in Hand,' the oldest fire insurance company in America, of whose directorship Franklin was an early member. The Pennsylvania Railroad station, with a train shed over 700 feet long, and the Reading Terminal, a handsome railroad station, approached like that of the Pennsylvania Railroad by a viaduct, are notable railway terminals and office headquarters. Of newspaper buildings the most prominent are those of *The North American* (22 stories), *The Record*, and *The Public Ledger*. Of semi-public organizations the Stock Exchange is housed in the remodeled Merchants' Exchange Building; the Bourse Building is the home of the Board of Trade, the Trades League, and other trade organizations; and the Commercial Museum, supported by municipal, State, and Federal appropriations, and devoted to the encouragement of foreign commerce, especially with Spanish America, is located temporarily on Fourth Street, pending the erection of a permanent structure in West Philadelphia, on the site of the Exposition of 1899. Philadelphia has many important hotels, among the most elegant and commodious of which may be mentioned the Walton and the new Bellevue-Stratford, both on Broad Street near City Hall.

With structures representing interests that are not strictly utilitarian Philadelphia is well supplied. The Masonic and Odd Fellows' temples, on North Broad Street, rank with the best society structures on the continent. The Young Men's Christian Association Building on Fifteenth Street, that of the Young Women's Christian Association on Arch street, the Crozier Building of the Baptist Publication Society, the Witherspoon Building, with the publication

rooms, general offices, and historical museum of the Presbyterian Church (North), represent in highest perfection the application of modern business methods to religious work. In addition to the historic churches already mentioned, the most important edifices are the Roman Catholic Cathedral, the Kenneth Israel Synagogue, and the Baptist Temple of North Broad Street, Holy Trinity (Protestant Episcopal) on Rittenhouse Square, the Arch Street (Methodist Episcopal), the First Presbyterian and the Tabernacle Presbyterian and the Friends' Meeting House on Arch Street—the Quaker Westminster of America. Of educational institutions the University of Pennsylvania, Drexel Institute, the new Boys' High School, Girard College with its early Grecian structures, and the Roman Catholic High School are architecturally of importance.

PARKS. The system embraces about 4000 acres. Public interest has been aroused of late in the development also of parkways. William Penn expressed the desire to make Philadelphia a 'greene country towne,' and his surveyor Holme placed on the plan, near its four angles, rectangular open spaces, now Logan (northwest), Rittenhouse (southwest) Franklin (northeast), and Washington (southeast) squares, containing an aggregate of 28½ acres. These, together with Central Square, the site of the original water-works, but now of City Hall, formed a cherished precedent. In 1903 there were under the care of the Bureau of City Property more than 50 small parks and plots containing over 600 acres. The largest was League Island Park (300 acres), contiguous to the League Island Navy Yard. In Independence Square the Declaration of Independence was read to the populace. Penn Treaty Square marks the site of the great elm under which, according to tradition, the founder made his famous compact with the Indians. In Logan Square was held in the summer of 1864 the great Sanitary Fair. Bartram's Garden (27 acres), on the banks of the Schuylkill, was the first botanical garden in the New World. Its noteworthy arboreal collection has been preserved.

The city's greatest pleasure ground is Fairmount Park, rich in natural beauties. The Schuylkill divides it into East Park, with over 633 acres, and West Park, with 1323 acres. Along the Wissahickon is the Wissahickon Valley extension of 1010 acres. The acquisition in 1812 of five acres on Morris's Hill, the original Fair Mount, for water-works and park purposes, led to the formation of the park. To this were added areas of woodland, and country seats, the Lansdowne estate of Governor John Penn, Eaglesfield, Sweet Briar, and Solitude; the Belmont home of Judge Peters of the Supreme Court, where Washington, Franklin, Jefferson, Lafayette, and others visited; Mount Pleasant, the residence of Benedict Arnold; George's Hill (83 acres), presented by Jesse and Rebecca George; Strawberry Mansion, Lemon Hill, Ormiston, and Edgely. The miniature Letitia House, built by William Penn for his discontented daughter, was transported from the city. The Zoological Gardens are maintained by private subscription, admission receipts, and municipal appropriations contingent upon the free admission of school children. The Centennial Exposition of 1876 brought many noteworthy structures into the park, the most important that remain being Horticultural Hall, with a fine exotic collection, and Memorial Hall,

where are exhibited the Wiltach Art Collection and the display of the Pennsylvania Museum and School of Industrial Art. A trolley line, below grade, eight miles long, extends to the chief points of attraction. A speedway, one mile in length, is being completed. The Schuylkill is frequently the scene of regattas, and there are handsome stone boat houses on its eastern bank.

Many fine monuments have been placed in the park. The Washington Monument by Siemering of Berlin is the most imposing. Funds for its erection were provided by the Society of the Cincinnati, the subscriptions, begun in 1819, aggregating \$250,000 when the monument was unveiled in May, 1897. It stands at the Green Street entrance, the termination of the Park Boulevard. This thoroughfare, projected in 1903, is to be 160 feet wide from City Hall to Logan Square, and thence 300 feet wide to the park. In the same year was authorized the construction of the Torresdale Boulevard, 300 feet wide and 15 miles long, from North Broad Street to Torresdale. Of note are the statues of Lincoln, Garfield, Grant, Meade, Humboldt, Schiller, Goethe, Columbus, Joan of Arc, Witherspoon, and Father Matthew; and the Catholic Total Abstinence Union Fountain, and the Smith Memorial Arch. Grant's Cabin, occupied as headquarters at City Point, is here preserved. In the city proper are comparatively few works of art, the most important being statues of Washington in front of Independence Hall, of Franklin on the post-office pavement, and of McClellan and Reynolds on City Hall Plaza.

The Wissahickon Valley, a deep wooded ravine, which has been left almost in its original wild state, is of interest for its memories and legends of Indian braves and mystic German monks who made it their retreat. The first paper mill in America was erected on its banks in 1690. In Fairmount Park there are 20 small streams, several lakes, and more than 150 springs; over 66 miles of drives, 10 of bridle paths, and 40 of smaller roads. The boundary line is 30 miles long. The entire cost approximates \$7,000,000, and \$3,500,000 has been expended in permanent improvements.

The Laurel Hill cemeteries are contiguous to the park. In the city are numerous burial places, many of historic associations.

EDUCATIONAL INSTITUTIONS AND LIBRARIES. At the close of 1902 there were in the city six higher schools, including a high school for boys, conferring degrees of A.B. and B.S., and a school of pedagogy; a high school, a commercial high school, and a normal school for girls; and two manual training schools. There were also one school of industrial art, one elementary manual training school, one observation and practice school, five special schools for backward children and truants (under the compulsory education law), twelve cooking schools, and grammar, primary, and kindergarten schools, making the total of city institutions 420, with 229 male and 3537 female teachers, and an attendance of 158,473, of which 5800 were in the higher schools. The general course of study falls under no classification, but is the result of development. Foreign languages are taught only in the higher schools. There is some special and experimental manual training for seventh and eighth grade boys, and cooking and sewing instruction for sixth, seventh, and eighth

grade girls. Through private bequest and municipal legislation there are available 358 free scholarships in the University of Pennsylvania, Bryn Mawr, Lehigh University, and various medical, art, and scientific colleges. Night and summer vacation schools are conducted.

At the head of the higher educational institutions is the University of Pennsylvania (q.v.). Philadelphia is a centre of medical education, its prominent medical colleges being that of the University of Pennsylvania, Jefferson, Hahnemann, Medico-Chirurgical, Polyclinic, and Woman's (founded in 1850), the first chartered medical college for women in the world to confer the degree of M.D. The Pennsylvania and Philadelphia dental colleges (the oldest and the best of their kind) and the Philadelphia College of Pharmacy are largely attended. The art schools of the Pennsylvania Academy also are the oldest in the country. The School of Industrial Art and the School of Design for Women are well known. Bryn Mawr College (q.v.), near Philadelphia, is one of the foremost women's institutions of the United States. The Drexel Institute, founded and endowed with \$2,000,000 by A. J. Drexel, offers at a small cost courses in art, sciences, and industrial training. Other leading institutions are the Franklin and Spring Garden Institutes, Temple College, Episcopal Academy, the seminaries of the Protestant Episcopal, Lutheran, and Roman Catholic churches, La Salle and Saint Joseph's Colleges, and the Roman Catholic High School, the Methodist Episcopal Collegiate Institute for Girls, numerous schools of the Society of Friends, including the William Penn Charter (1701), the first chartered school in the country, the Cheltenham Military Academy, and the Germantown Academy (1760). The Williamson Free School of Mechanical Trades, established under a bequest of \$2,500,000 by the late I. V. Williamson, offers complete trade courses and supports students free of cost. Philadelphia is noted for its associations and institutions for the promotion and diffusion of science and learning, and the encouragement of art. Among these are the Philadelphia Academy of Natural Sciences (q.v.), the Franklin Institute (q.v.), the American Philosophical Society, the American Academy of Political and Social Science, the Historical Society of Pennsylvania, the Zoological Society, the Numismatic and Antiquarian Society, the Pennsylvania Academy of Fine Arts, and the Wagner Institute.

The Free Library, now in temporary quarters, founded in 1891, on bequests of George S. Pepper and others, is maintained by appropriations made by City Councils. In the central and 14 branch libraries are over 250,000 volumes. A gift by Andrew Carnegie of \$50,000 for each of thirty additional branches with halls for public gatherings (conditional upon their maintenance by the city), and an appropriation of \$1,000,000 for a permanent central building, provided by a loan approved by popular vote, are awaiting expenditure. The Library Company's collection, begun in 1731 by Benjamin Franklin and his associates of the 'Junto,' formed the first subscription library in America. Its 200,000 volumes include many of extreme rarity. The Ridgway Branch, an excellent example of pure Greek architecture, contains one of the most valuable reference lists in the United States. Other important libraries



CITY HALL

PHILADELPHIA



INDEPENDENCE HALL



of the 100 in the city are the Mercantile (1821), general circulation and reference; Carpenters' Company (1736), architecture and building; Friends' (1742); American Philosophical Society (1743); Academy of Natural Sciences; Franklin Institute, scientific; Hurst, law; College of Physicians; University of Pennsylvania, Apprentices', Pennsylvania, Presbyterian, and Baptist Historical societies; Drexel Institute; and the H. Josephine Widener Branch of the Free Library, with a valuable collection of reference works.

HOSPITALS AND OTHER INSTITUTIONS. The municipal charities are the hospitals for the Indigent and for the Insane, General Hospital, and the Municipal Hospital (contagious diseases). The Pennsylvania Hospital, founded in 1751, through the efforts of Franklin, and maintained entirely by private subscription, is the oldest institution of the kind in America. The religious denominations maintain institutions, among them being Saint Agnes', Saint Mary's, and Saint Joseph's hospitals (Roman Catholic); Episcopal, Methodist, Presbyterian, Jewish, Saint Luke's (Baptist), and German (Lutheran) hospitals. Large hospitals are connected with the University, and Jefferson, Medico-Chirurgical, Polyclinic, Hahnemann, and Woman's Medical colleges. Other important charities are the Rush and Phipps hospitals for consumptives, the Gynceean, Orthopaedic, Wills Eye, and Maternity hospitals. There are more than 100 dispensaries, homes, asylums, orphanages, etc. The College Settlement, Society for Organizing Charity, Working Women's Guilds, Flower, Fruit, and Ice Mission, various children's aid, protection, and country week associations do good work. The city maintains numerous public baths, which were patronized in 1902 by 4,453,000 persons.

Girard College, founded by Stephen Girard, who at his death in 1830 gave \$2,000,000 for construction and the greater portion of his \$5,000,000 estate for endowment, supports and educates annually over 1600 orphans. The residuary fund now amounts to \$16,500,000. The Citizens' Permanent Relief Committee has relieved thousands of distressed in all parts of the world, over \$5,000,000 having been distributed since 1879. The Mayor is president. The penal institutions are the Eastern State Penitentiary, the House of Refuge (boys and girls), the House of Correction (adults), and Moyamensing and Holmesburg County prisons.

THEATRES AND CLUBS. The drama in America began in Philadelphia, a company being organized in 1749. The first permanent playhouse in the city was built in 1766; a portion of its walls still stands. The Walnut Street Theatre is the oldest in the country. At Locust and Eighth streets stands the Musieal Fund Hall, where Malibran, Jenny Lind, and Ole Bull appeared. Other important playhouses are Keith's New Theatre, the Garrick, the South Broad, the Chestnut Street, the Grand and Chestnut Street opera houses, and the Auditorium. The Academy of Music, with a capacity of 2900, is used for large public gatherings.

Leading clubs are the Union League, with a handsome brownstone building, Philadelphia, Manufacturers', Mercantile, Rittenhouse, Markham, Columbia, University, Penn, the Art, installed in a beautiful Renaissance structure of Pompeian brick and Indiana limestone, Sketch,

Lawyers' Clover, Five o'Clock, Maennerchor, Franklin, Country, Pen and Pencil, Philadelphia Yacht, and the New Century and Acorn (women's).

COMMERCE AND MANUFACTURES. The industrial development of Philadelphia has been greatly aided by the favorable location of the city for commerce, and especially by its proximity to raw materials. The city has the advantage of superior railroad facilities. The great Pennsylvania Railroad system, with 10,484 miles of owned and leased lines, and the Philadelphia and Reading Railway, with \$140,000,000 capital and 1457 miles of track, terminate and have home offices near the City Hall. The Pennsylvania lines give Philadelphia more direct communication with the productive Middle West than is enjoyed by any other Atlantic port. The general offices of the Lehigh Valley Railroad are in the city. The Baltimore and Ohio enters where Chestnut Street crosses the Schuylkill. The tracks of the Pennsylvania are nearly all elevated or below grade, the Baltimore and Ohio below, and the Reading partly above, partly below, but mainly at grade. The Delaware River admits of the entrance of ocean vessels, and is navigable the entire length of the city's frontage, 18 miles. Work is now in progress to deepen the river to 30 feet. The Schuylkill River is navigable eight miles for vessels of light draught and is being dredged to a depth of 22 feet. The general export and import interests, including the Port Richmond coal wharves, are located mainly on the Delaware. Eleven transatlantic lines enter the port.

Early in the nineteenth century Philadelphia was first among United States ports in foreign commerce, but its relative importance declined, until in 1901 it ranked fourth. The imports for that year were valued at \$48,043,443, and the exports at \$79,354,025. In 1901, 158 sailing vessels, with an aggregate of 115,779 tons, and 950 steam vessels, of 1,807,623 tons, entered the port. The pipe lines of the Standard Oil Company from the wells in the northwest section of the State terminate at Point Breeze, on the Schuylkill, and oil is one of the largest and most valuable shipments of the port. In 1901 the exports of illuminating mineral oil amounted to 207,111,311 gallons, valued at \$12,323,961. The exports of corn for the same year amounted to \$12,633,467, one-seventh of the total for the country. Wheat and flour are also exported extensively. In 1901, 37,833 head of cattle were shipped, and there were also considerable exports of meat and meat products. Coal and copper are other important exports. The largest import is sugar, amounting in 1901 to a value of over \$15,500,000. Imports of unmanufactured silk were valued at over \$8,000,000. Among other leading imports are goat skins, fabrics, bananas, etc.

Philadelphia is a great manufacturing centre, ranking third in the United States in value of products. Of 15 selected industries in the census year 1900, it was first in one (leather), second in two (cigars and cigarettes, and women's factory clothing), and third in six. The value of the total output was \$732,137,957. This was nearly double the corresponding figure for 1880, but the greater part of the increase was made in the decade 1880-90. The manufacture of foundry and machine shop products is most important, amounting in 1900 to \$38,372,971. In this industry Philadel-

phia has a special advantage, owing to its proximity to abundant resources of coal and iron. It is noted particularly for the manufacture of locomotives, the Baldwin Locomotive Works, on North Broad Street, having a yearly capacity of 1500. For years Philadelphia has been the foremost shipbuilding centre in the country. Many warships of the United States and also a number for foreign governments have been built at the Cramp shipyard, which occupies some 52 acres in the Port Richmond section. These two establishments are not only the leading ones of Philadelphia, but each excels, in its own line, for the country at large. In the total manufacture of textiles also the city ranks first (though not for any one branch), the value of the principal textiles produced in 1900 being as follows: Woolen goods, \$18,340,012; worsted goods, \$16,242,250; cotton goods, \$15,723,654; hosiery and knit goods, \$13,040,905; silk and silk goods, \$4,531,794. The output of the sugar and molasses refining industry was valued at over \$36,000,000; the output of clothing, \$28,000,000; of carpets and rugs, nearly \$22,000,000; of leather, nearly \$20,000,000; and of liquors, over \$12,000,000.

GOVERNMENT. The executive branch of the government is of a dual nature, consisting of county and municipal departments. The municipal form of government is provided for by the Bullitt Bill, act of June 1, 1885, amended April, 1903, the basic elements of which are concentration of authority in the mayor and the distinction between the executive and legislative functions. The executive departments are: Public Safety, which includes bureaus of police, fire, electricity, corrections, boiler inspection, building inspection, and city property; Public Works, which includes bureaus of water, highways, gas, lighting, street cleaning, surveys, ice boats, and filtration (temporary); Law, Education, Public Health and Charities, Receiver of Taxes, City Comptroller, and City Treasurer (exofficio County Treasurer), and Supplies. The mayor, who is elected every four years and is ineligible for succession, appoints directors of the Departments of Public Works, Safety, Health, and Supplies, subject to confirmation by Select Council. Directors appoint chiefs of bureaus and other employees under civil service requirements. The receiver of taxes, city treasurer, city comptroller, and city solicitor are elected by popular suffrage. The Department of Education consists of 42 comptrollers, appointed by the judges of the Courts of Common Pleas. The Sinking Fund Commission consists of the mayor, city comptroller, and one member elected by Councils. The commissioners of Fairmount Park and members of the Board of Revision of Taxes, and the Board of City Trusts, in charge of Girard College and Estate and minor trusts, are also appointed by the courts. Sixteen port wardens are elected by the Councils. The county officials are commissioners in charge of elections, etc., treasurer, recorder of deeds, register of wills, clerk of the Court of Quarter Sessions, coroner, sheriff, and district attorney. The legislative function is exercised by Select and Common Councils, the former consisting of one member from each of 42 wards, the latter of one member for every 4000 voters. Select Councilmen serve three years, and Common Councilmen, two, without pay. The veto power is vested in the mayor, a three-fifths vote enacting over it. The judiciary consists of police magis-

trates (limited civil and preliminary criminal actions); judges of the Courts of Common Pleas (civil), who are also judges of the Courts of Quarter Sessions (criminal); and the judges of the Orphans' Court (estates). The Superior and Supreme Courts of Pennsylvania and the United States District and United States Circuit Courts sit in the city.

The city has leased its gas-works for a maximum period of 30 years, expiring December 31, 1927. Electric lighting is supplied by a private corporation. The water-works are under municipal ownership. A system of slow sand filtration is being installed, and in August, 1903, when upward of \$17,000,000 was involved in contracts, it was over half finished and in partial operation. The complete works, with a daily capacity of 300,000,000 gallons, are estimated to cost \$26,000,000.

FINANCES. The city's receipts for 1902 were \$33,520,729. The important items were: taxes, \$16,793,680; gas, \$486,491; State appropriation (1901-02) for schools and teachers' annuities, \$316,000; loans negotiated, \$6,915,000; personal property tax, \$1,249,332; permits, fees, etc., \$7,400,000, including water rents, \$3,422,000, liquor licenses, \$1,766,000, and premiums on loans, \$581,000; interest, \$365,000. The expenditures were \$34,605,948; the largest item was \$25,904,693 for municipal departments and bureaus; of this amount schools received \$4,186,000; police, \$3,565,000; fire, \$1,124,000; water, \$6,511,000; highways, \$2,109,000; street cleaning, \$1,238,000. Other large disbursements were: interest on funded debt, \$1,404,036; several sinking funds, \$1,727,787; loans redeemed, \$680,000; mandamuses, \$1,456,105. The general cash balance on January 1, 1903, was \$17,166,865. The gross debt at the same date was \$59,361,845; the city loans held by the sinking fund amounted to \$6,645,300, leaving a net city debt of \$52,716,545; the total assets were \$29,132,473, not including the real estate owned by the city, valued at \$64,520,994. The assessed real estate valuation, as estimated in August, 1903, for 1904, was \$1,160,392,710. Under the law the debt is limited to 7 per cent. All permanent loans after the 2 per cent. point has been exceeded must be authorized by a vote of the people.

POPULATION. The population in 1900 was 1,293,697, Philadelphia ranking third among American cities. Since 1854 no territory has been added to the municipal limits. The percentage of increase from 1880 to 1890 was 23.58, and from 1890 to 1900, 23.57. Fifty-four and seven-tenths per cent. of the white population is of foreign parentage, but native whites of foreign birth comprise 32 per cent. of the entire population. The negroes numbered 28,940 in 1900; Chinese, Japanese, and Indians, 1277. The largest classes of European descent are German, Irish, English, and Italian. French, Greeks, Armenians, Russians, Bohemians, and Poles are present in much lesser numbers. Though some tendency to congregate is shown, there are few well-defined foreign colonies. In 1800 the population of Philadelphia was 28,522; in 1820, 63,802; in 1840, 93,665; in 1860, 563,529; in 1880, 847,170; in 1890, 1,046,964.

HISTORY. The first settlement (called Wicaco) within the present limits of Philadelphia was made in 1636 by a company of Swedes sent out by the Government of Queen Chris-

tina. On October 7, 1681, Captain William Markham, Deputy Governor for William Penn, arrived with a small company, and started an English settlement here, which in July of the following year was laid out and called Philadelphia, 'the city of brotherly love.' In 1683 a company of Germans, invited hither by Penn, arrived and settled at Germantown, within the present city limits. In 1684, immigration having been rapid from the start, there were 300 houses and more than 2500 inhabitants. The majority of the early settlers were Friends, and their influence, combined with that of the Germans, predominated for many years and greatly affected the course of Pennsylvania's history. Penn returned to England in 1684, and did not revisit the city until 1699, when he found a population of 4500, and 700 houses. He chartered the city in 1701, and thereafter frequent controversies arose between the people and the Penn family over proprietary privileges, especially as regards taxation of the Penn lands. The first English school was opened in 1683. Franklin's *Pennsylvania Gazette* began publication in 1729 and the *Pennsylvania Journal and Weekly Advertiser* was started in 1742. In 1741 the city, then having 1621 taxable citizens, was divided into ten wards. In 1723 Benjamin Franklin, who, next to Penn, exerted the greatest influence in the history of the city, came to Philadelphia. In 1747, during King George's war with the French and Indians, the publication of his *Plain Truth* roused a spirit of military enthusiasm, a force of 10,000 was raised in Pennsylvania, and a battery was erected below the city, on the site of the present United States Navy Yard. In 1751 the first line of packets to New York was established, followed in 1756 by a stage line. Under Franklin's influence, in 1747 the merchants of Philadelphia sent a ship to discover the Northwest Passage. In 1755 a militia bill was passed, and Franklin became colonel of the city regiment.

From 1763 to 1774 Philadelphia was prominent in resisting British aggression, though the Loyalist party was strong, and most of the Friends opposed warfare; and here most of the important official events of the Revolution took place. In 1773 (October 17), during the excitement over the expected arrival of the tea ships, the people met in mass meeting and passed resolutions which, on November 5th, were readopted at Boston. The first Continental Congress met in Carpenter's Hall, September 5, 1774; the second met May 10, 1775, in the State House; and there, on June 15th, Washington was appointed commander-in-chief of the Continental army. In 1776 Congress met for the third time in the State House, and there, on July 4th, the Declaration of Independence was adopted. Philadelphia was held by the British from September 27, 1777, to June 18, 1778, and during this period, while the American army was at Valley Forge, was the scene of much gayety. On May 18, 1778, the famous entertainment called the *Mischianza* (q.v.), was given in honor of General Howe, who was about to depart for Europe. On October 4, 1777, the battle of Germantown (q.v.) was fought. On May 2, 1787, delegates from the different States assembled here, and, after almost four months of debate behind closed doors, adopted a Constitution for the United States, September 17th. On March 11, 1789, the city received a new charter from the Legislature. Epidemics of

yellow fever in 1793 and 1798 caused great loss of life, at least 4000 dying in the former year and almost 5000 out of the 30,000 who remained in the city in the latter.

During the latter part of the eighteenth century and the early part of the nineteenth Philadelphia was the most important city in America. The historian McMaster says of it in 1784: "The city was then the greatest in the country. No other could boast of so many streets, so many houses, so many people, so much renown;" and Liancourt describes it in 1800 as "not only the finest city in the United States, but . . . one of the most beautiful cities of the world." Philadelphia was the capital of Pennsylvania from 1683 until 1799, the seat of the Federal Government from 1790 to 1800, and the monetary centre of the country until 1836. (See BANK, BANKING.) For many years, also, it was the intellectual and literary centre of the country. Here were published the first newspaper in the middle colonies, *American Weekly Mercury* (1719); the first secular magazine in North America, *Ein geistliches Magazin* (1764); the first daily newspaper in the United States, the *Pennsylvania Packet* (1784); the first American edition of the Bible in German (1743), and in English (1781), and the first religious weekly, *Religious Remembrancer* (1813). The most popular of the early American magazines—the *Port Folio* and the *Analectic*—were also published here.

Philadelphia took the lead in the early anti-slavery movement, the first formal protest against slavery in this country being made by four Germans of Germantown in 1688, the first Abolition convention being held here January 1, 1794, on the invitation of the Pennsylvania Abolition Society, and the American Anti-Slavery Society being founded here, until the leadership of Garrison, in 1833. In 1812 the water-works at Fairmount were begun and were finished in 1815. In 1832 nearly 1000 deaths resulted from Asiatic cholera. In May, 1838, an anti-Abolitionist mob destroyed Pennsylvania Hall, in which an Abolitionist meeting had been just held. In 1844 occurred the anti-Catholic riots, arising from the demand of the Catholics to be permitted to use the Douai instead of the King James Bible in the public schools. The anti-Catholics, or 'Native Americans,' burned Saint Michael's and Saint Augustine's churches, and caused much loss of life before they were put down by the militia. Gas was introduced in 1836, and the first telegraph line was established in April, 1846. On February 2, 1854, a consolidation act was passed by the Legislature, extending the city limits to the county boundaries, and uniting under one municipal government all the outlying districts, known as Southwark, Northern Liberties, Kensington, Spring Garden, Moyamensing, Penn. Richmond, West Philadelphia, and Belmont; also the boroughs of Germantown, Manayunk, and other townships. Philadelphia took an active part in the Civil War, and raised more than \$1,000,000 by a sanitary fair in 1864. The centenary of American independence was celebrated in 1876 by the Centennial Exposition; the bi-centennial of the landing of William Penn in 1882; and the centennial of the signing of the Constitution in 1887.

BIBLIOGRAPHY. Hazard (editor), *Watson's Annals* (Philadelphia, 1884); Scharf and West-

cott, *History of Philadelphia, 1609-1884* (ib., 1884); Allinson and Penrose, *Philadelphia, 1684-1887* (ib., 1887); Trades League, *The Book of Philadelphia, 1894* (ib., 1894); Repplier, *Philadelphia, the Place and the People* (New York, 1895); Young, *Memorial History* (ib., 1895); Fisher, *The Making of Pennsylvania* (Philadelphia, 1896); id., *Chapters in Pennsylvania, Colony and Commonwealth* (ib., 1897); Rhoades, *The Story of Philadelphia* (New York, 1900); King, *Philadelphia and Notable Philadelphians* (ib., 1902).

PHILADELPHIA ACADEMY OF NATURAL SCIENCES. An association founded in 1812 for the purpose of furthering the study of the natural sciences and encouraging original investigation in the various fields of physical research. It is the oldest organization in the United States devoted to the encouragement of natural science. Its museum is especially rich in ornithological specimens and fossils, while its collection of shells is the finest in the world. The Jessup foundation provides gratuitous training for a number of young investigators. The society has published a *Journal* since 1817 and its *Proceedings* since 1841.

PHILADELPH'US (Neo-Lat., from Gk. *φιλᾶδελφος*, *philadelphos*, sort of flowering shrub, perhaps jasmine; named in honor of Ptolemy Philadelphus, King of Egypt). A genus of shrubs of the natural order Saxifragaceæ. Several species are natives of the southern Atlantic and Pacific States and Japan. *Philadelphus inodorus* grows in the mountains from Virginia southward. *Philadelphus grandiflorus* grows in lower ground in the same region. *Philadelphus hirsutus* grows in Tennessee and North Carolina. *Philadelphus Gordonianus* and *Philadelphus Lewisii* are natives of the Pacific Coast States. The most common and best representative of the genus, however, is *Philadelphus coronarius*, the common mock orange or syringa, much cultivated in gardens. Its native country is not known, but it was probably brought from Japan to Southern Europe, where it appears to be indigenous. It has erect branches, oblong ovate leaves, which when crushed have very much the odor and taste of cucumbers. Its cream-colored flowers, borne in large clusters, are well known for their exceeding fragrance.

PHILÆ (Lat., from Gk. *φιλᾶ*, Coptic *Pilâ-kêh*, the corner, extremity, i.e. of Egypt). A celebrated island in the Nile, just above the First Cataract, in latitude 24° 1' N. It is a small granite rock, about 1000 feet long by 500 feet broad, and is covered with ancient buildings of great architectural value and interest. By the Arabs it is called *Geziret Anas el-Wogûd*, 'The island of Anas el-Wogûd,' from the name of the hero of a tale in the *Thousand and One Nights*, the scene of which is laid here. Philæ is not mentioned in the Egyptian inscriptions before the time of Nectanebo II., who constructed the oldest of the buildings that now remain, though it is reasonably certain that a temple existed there in earlier times. The island was especially devoted to the worship of the goddess Isis, but Osiris, Hathor, Khnum, Satet, and other divinities were also worshiped there. In later times, when the cult of Isis had spread through the Greek and Roman world, many pilgrims of foreign nationality visited the shrine of the goddess at Philæ, and her

worship was maintained there long after heathenism had been banished from other parts of Egypt. The great temple of Isis was built by Ptolemy Philadelphus and his successor, Euergetes I., but additions and embellishments were made by other Ptolemies and by several of the Roman emperors. The approach to the temple is formed by the dromos, a long open space, flanked on its eastern and western sides by colonnaded walks. At the southern end is the hall of Nectanebo II., built about n.c. 350, and near it to the right is the ruined temple of the Nubian deity Arnuphis (Ar-hes-nofer). Starting from this temple, the eastern colonnade runs northward to the small temple of Imhotep (Asklepios), and terminates near a gate built by Ptolemy Philadelphus and adorned with reliefs by that monarch and by the Emperor Tiberius. The western colonnade is pierced by a number of windows which give a fine view over the river. It runs along a fine stone quay of ancient construction. At the northern end of the dromos stands the great pylon of Nectanebo II., leading into the outer court, on the eastern side of which are a number of chambers, built for the use of the priests, while on the western side is the birth-house, commemorating the birth of Horus. Among the reliefs and inscriptions upon the walls of the latter building is a copy in hieroglyphic and demotic of the text of the Rosetta stone (q.v.). At the upper end of the outer court is a second pylon, which gives entrance to the inner court leading to a columned hall, and from this, through a succession of smaller halls and chambers, lies the way to the sanctuary of the goddess Isis and her son Harpocrates (q.v.). In an upper story is a room decorated with scenes from the myth of Osiris (q.v.). The temple is decorated throughout with sculptures and reliefs which are well preserved and are richly colored. West of the temple of Isis, near the river, are a gate built by the Emperor Hadrian and the temple of Harendotes (Egyptian *Har-nez-yotf*, 'Horus the avenger of his father'). On the eastern side of the island is the small temple of Hathor built by Ptolemy Philometor and Euergetes II., and near it, close to the river bank, is a beautiful pavilion resting upon light and graceful columns and richly adorned with reliefs. On the northern end of the island, among the ruins of the ancient city of Philæ, are the remains of the old Roman city gate, of the temple of Augustus, and of a Coptic church. It was expected (1903) that the great dam at Assuan would so raise the level of the Nile at Philæ as to submerge the island. Consult: *Description de l'Égypte* (Paris, 1820-30); Lepsius, *Reiseberichte aus Aegypten* (Leipzig, 1855); Edwards, *A Thousand Miles Up the Nile* (London, 1877); Dümichen, *Geschichte des alten Aegyptens* (Berlin, 1878); Mariette, *Monuments of Upper Egypt* (London, 1877); id., *Voyage dans la Haute-Égypte* (Paris, 1893); Baedeker, *Aegypten* (4th ed., Leipzig, 1897). See Plate accompanying article EGYPTIAN ART.

PHILANDER. A Dutch knight in Ariosto's *Orlando Furioso*, who made love to Gabrina, the wife of his host. His name is used as the synonym of a male coquette in various plays, and is the origin of the verb to philander.

PHILANTHROPY (Lat. *philanthropia*, from Gk. *φιλανθρωπία*, love of humanity, from *φίλανθρωλος*).

πῶς, *philanthropos*, loving humanity, from *φιλεῖν*, *philein*, to love + *ἄνθρωπος*, *anthrōpos*, man). In German educational history, a term applied to the theories of a group of men who based their educational theories upon Rousseau. At the head of these was Basedow, who founded an institution, the Philanthropinum, at Dessau in 1774. The only survival of the movement is Salzmann's institution at Schnepfenthal in Gotha, founded in 1784. See BASEDOW.

PHILARET, *ἱεὶλά-ρέτ* (VASILI FEODOROVITCH DROSDOFF) (1783-1867). Metropolitan of Moscow. He was born at Kolonna; became a priest in 1808 and in 1812 was made rector of the Theological Academy of Saint Petersburg. In 1817 he became Bishop of Revel, in 1819 Archbishop of Tver and a member of the Holy Synod. In 1820 he was transferred to Yaroslav and in 1821 to Moscow. He was appointed Metropolitan of Moscow in 1825. He was noted for learning and eloquence, and drew up the manifesto which led to the abolition of serfdom. He prepared a longer and a shorter catechism, both of which were adopted and promulgated by the Holy Synod in 1839, and the former is considered the most authoritative doctrinal standard of the Græco-Russian Church. Both catechisms have been translated into English by Blackmore in *The Doctrine of the Russian Church* (London, 1845); Blackmore's translation of the longer catechism is reprinted in Schaff, *The Creeds of Christendom*, vol. ii., pp. 445-542. There has also been published a volume of Philaret's *Select Sermons* in English translation (London, 1873), with brief biography. He began a translation of the New Testament into Russian, which was completed after his death.

PHILASTER, OR, LOVE LIES A-BLEEDING. A tragedy by Beaumont with some assistance from Fletcher. G. C. Macauley considers it the work of Beaumont alone. It was printed probably in 1608, and printed in 1620. Several versions were produced, one as late as 1764.

PHILATELIC ASSOCIATION (from Gk. *φίλος*, *philos*, loving, from *φιλεῖν*, *philein*, to love + *ἀτέλης*, *ateles*, free of tax, prepaid, from *α-*, not + *τέλος*, *telos*, tax, duty), AMERICAN. A national society of postage stamp collectors, founded in 1885, meeting annually in such cities as may be selected, and having local branch societies in New York, Chicago, Pittsburg, and Saint Paul. It has a membership of nearly six hundred, and its objects are to bring together those interested in philately, and to study that subject with the help of exhibitions of collections.

PHILATELIC SOCIETY OF LONDON. An English association of collectors of postage stamps, founded in London in 1869, the first of its kind. Its objects are the study of postage stamps, their history and manufacture, the detection of forgeries, the exhibition of stamps, and the publication of works on these subjects. The membership includes many collectors in the English colonies and on the Continent. The society has conducted two international philatelic exhibitions. It has also published expensive volumes on the stamps of great Britain, of the British colonies, of India and Ceylon, and of Africa, and issues its proceedings in the *Monthly Journal*.

PHILATELY. See POSTAGE STAMPS.

PHILBRICK, JOHN DUDLEY (1818-86). An American educator, born in Deerfield, N. H. He graduated at Dartmouth in 1842 and afterwards taught in Boston for ten years. In 1853 he became principal of the Connecticut Normal School, and in 1855 superintendent of schools in that State. From 1857 to 1874 and again from 1876 to 1878 he was superintendent of the Boston public schools. He was sent to the Vienna Exposition of 1873 as educational commissioner from Massachusetts, and acted as a member of the international jury. After his return he became president of the National Teachers' Association and was officer of many educational societies. He prepared a valuable report on the *City School Systems in the United States* (published by the United States Bureau of Education in 1885) and edited the Connecticut *Common School Journal*, and the *Massachusetts Teacher*.

PHILELPHUS. The Latinized form of the name of the Italian humanist Francesco Filelfo (q.v.).

PHILEMON (Lat., from Gk. *Φιλήμων*) (c.361-263 B.C.). A Greek comic poet. He was a native of Soli, in Cilicia, or of Syracuse, in Sicily. He resided chiefly in Athens, but for a time also in Alexandria at the Court of Ptolemy Philadelphus. He and Menander were the two representative poets of the Attic New Comedy. Philemon gained more prizes than Menander, perhaps through bribery of the judges. Posterity, however, reversed the decision, and Menander and Homer were the two favorite poets of later Greece. Of the 97 comedies which Philemon left, 57 are known to us from titles and fragments, while two at least, the *Εμπορος* and *Θησαυρός*, are preserved in Plautus's adaptations, the *Mercator* and *Trinummus*; and it is also probable that Plautus's *Mostellaria* follows Philemon's *Φόσμα*. The fragments are published by Koch, *Comicorum Atticorum Fragmenta*, vol. ii. (Leipzig, 1886).

PHILEMON. A dear friend of the Apostle Paul, to whom he wrote the letter which is now preserved in the New Testament under Philemon's name. From this letter it appears that he was a rich man who probably lived at Colossæ, owned slaves, was noted for his hospitality, and had become a Christian under Paul's influence. There are legendary accounts of Philemon's later accession to the Bishopric of Colossæ and of his martyrdom there under the Emperor Nero.

PHILEMON, EPISTLE TO. One of the Epistles of the New Testament and the only letter of Paul written to an individual on a purely private matter which has been preserved. In it Paul appeals to his friend Philemon in behalf of Onesimus, a fugitive slave, who, under the influence of Paul, had become a convert to the Christian faith. This fugitive Paul sends back to his master with a letter praying for the culprit's pardon and even hinting at emancipation. The letter was, almost without doubt, written from Rome, some time after Paul's arrival there in the spring of A.D. 59. The most significant value of the letter is its bearing upon the question of human slavery. The practice is not condemned, but the new doctrine of the brotherhood of man is emphasized as in the Colossian and Ephesian letters, written at the same time. Consult: Eliott, *Philippians, Colossians, and Philemon* (Andover, 1865); Lightfoot, *Colossians and Philemon*

(1876); Soden in *Hand-Commentar zum Neuen Testament*, vol. iii. (Freiburg, 1893); Moule, *Colossians and Philemon* (*Cambridge Bible for Schools and Colleges*, Cambridge, 1894); Vincent, *Philippians and Philemon* (*International Critical Commentary*, New York, 1897); Maclaren, *Colossians and Philemon* (*Expositor's Bible*, New York, 1903).

PHILEMON AND BAUCIS. According to a myth related by Ovid in his *Metamorphoses*, a pair of poor Phrygian peasants, Jupiter and Mercury, wandering through Phrygia in human form, were hospitably entertained by them, when all the neighborhood had turned the wanderers from their doors. On going away the gods took them with them to a neighboring mountain, whence they saw their village covered with a flood, but their own cottage changed into a splendid temple. Jupiter permitted them to make any request they chose, but they only asked to be servants of his temple and to die at the same time. Therefore in their extreme old age the gods transformed Philemon into an oak, Baucis into a linden, which long stood in front of the temple, and were honored by the people. The story, which has been much elaborated by Ovid, contains two elements common in popular tales: the rescue from a flood by divine interposition and the reward for hospitality to supernatural visitors in disguise. The vitality of the legend in Phrygia seems emphasized by the experience of Paul and Barnabas at Lystra (Acts xiv.).

PHILETAS (Lat., from Gk. Φιλάτας) OF COS. A Greek grammarian and poet who lived about the close of the fourth century B.C., tutor to Ptolemy II. Philadelphus of Alexandria. His poems, which were chiefly elegies devoted to the praises of his mistress, Bannis, were ranked next to those of Callimachus by the Alexandrian critics, and were imitated by Propertius. He wrote also epics and grammatical treatises. The scanty fragments that remain have been published by Bach (1829). Consult Weber, *Elegischen Dichtern des Hellenen* (Frankfurt, 1826).

PHILHARMONIC SOCIETIES (from Gk. φιλεῖν, *philein*, to love + ἁρμονία, *harmonia*, harmony). Organizations formed for the cultivation of orchestral music. The four most important are those of London, New York, Vienna, and Berlin.

LONDON. This is the oldest association of orchestral performers in England. In 1813 a number of music-lovers founded the Philharmonic Society and the first concert was given March 8th of that year. According to the constitution only concerted pieces were to be performed; all soli and concertos were excluded. But when a little later some of the members formed quartets the society ceased to perform chamber-music at its concerts and restricted itself to instrumental works for orchestra. In 1820 the term *conductor* (q.v.) appears for the first time upon the programmes, and it designated the person at the piano. After 1821 the conductor stood before the orchestra and directed by means of a baton. Since 1869 the organization has published analytical programmes for its concerts, at which the most eminent instrumental and vocal artists of their time have appeared.

NEW YORK. The Philharmonic is the oldest per-

manent orchestral association in New York. It was founded in 1842, the first concert taking place December 7th of that year. From the beginning it consisted of professional musicians only. As an educational factor the Philharmonic Society has been of greater importance in the musical life of America than any other organization, with the possible exception of the Boston Handel and Haydn Society. (See **CHORAL SOCIETIES**.) Up to 1865 various members of the orchestra acted as conductors. Beginning with that year a conductor for the season was chosen, the first being Carl Bergmann, who directed the concerts until 1876. After Dr. Damrosch had been conductor for one season, Theodore Thomas held the post from 1877 to 1890. This eminent director was succeeded by Anton Seidl. From 1898 to 1902 Emil Paur was conductor, and this period was marked by the production of an unusual number of new works, especially of the Neo-German school. In 1902 Walter Damrosch was conductor. The orchestra numbers over one hundred performers. Eight concerts take place on Saturday nights, each being preceded on Friday afternoons by a public rehearsal, which, in reality, is a regular concert, having its own list of subscribers.

VIENNA. The society, known as *Philharmonische Gesellschaft*, was founded in 1842 by Otto Nicolai, at that time conductor at the Imperial Opera. As the *Gesellschaft der Musikfreunde* (q.v.) was fast degenerating, there was a positive need of an organization that would give artistic performances. The first concert of the new society took place November 27, 1842, and the venture immediately met with great favor and financial success. The programmes consisted generally of two symphonies with smaller works. Instrumental solos, however, were not permitted. When Nicolai accepted a position in Berlin in 1847 the *Philharmonische Gesellschaft* almost came to an end. In fact, no concerts were given from 1850 to 1854. Then Carl Eekert reorganized the orchestra, and in 1860 the energetic Otto Dessoff succeeded in bringing the orchestra to a high degree of perfection. Since then the *Philharmonische Concerte* have stood always for musical progress. The conductor in 1902 was Hans Richter, under whose leadership the society has established its reputation as one of the foremost orchestral institutions of the world.

BERLIN. The Berlin Philharmonic Society was founded by Edward Rietz (1802-32). This orchestra at first consisted of about forty instruments, but the number was subsequently increased and the organization now ranks with the best orchestras of Europe. Its concerts are given in the 'Philharmonie.' An innovation is its series of popular concerts given three times a week during the winter.

PHILHELLENES, fil-hél'lénz (from Gk. φιλέλλην, *philhellén*, friend of the Greeks, from φιλεῖν, *philein*, to love + Ἑλλήν, *Hellén*, Greek). A name given to the friends of the Greeks in their struggle for independence. They were constituted into associations for the purpose of receiving and distributing gifts in aid of those engaged in the contest. The members came from all countries, including such men as Byron, King Louis I. of Bavaria, and a body of volunteers who fought for the Greeks under the leadership of General Normann-Ehrenfels.

PHILIDOR (1726-95). A famous French chess-player also known as a composer. His real name was François André Danican.

PHILINTE, *félicité*. A character in Molière's *Misanthrope*, whose easy tolerance of the shortcomings of his fellows sets him in strong contrast to his friend Alceste.

PHILIP (Lat. *Philippus*, from Gk. *Φίλιππος*, Philip, loving horses, from *φίλειν*, *philein*, to love + *ἵππος*, *hippos*, horse), **THE APOSTLE**. One of the more prominent of the twelve disciples of Jesus. He was a fellow-townsmen of Andrew and Peter and had been with them a follower of John the Baptist before he was called directly to become a disciple of Christ (John i. 43-44). When the company of the Twelve was definitely made up Philip became evidently one of their leading spirits, for his name stands in the lists at the head of the second of the three groups of four into which the Twelve are commonly divided. He does not figure extensively, however, in the records of the ministry of Jesus. His work after the death of Christ is involved in great confusion with that of Philip the Evangelist by the traditions. There are two apocryphal works bearing his name, the *Journeyings of Philip the Apostle* and the *Acts of Philip*. They are of slight historical value, however. Tradition of the safer sort assigns his labors to the region of Hierapolis in Asia Minor. The manner of his death and its date are both unknown.

PHILIP, THE EVANGELIST. One of those chosen by the first Christian church in Jerusalem to be the stewards of its charity to the widows and poor (Acts vi. 5). After exercising this office for a time he was engaged in missionary activity, which began after the death of Stephen. His initial work was among the Samaritans (Acts viii. 4-5). This was the first step outward from the limits of a Jewish cult for the new Christian faith. A second step in the process of widening the field was taken when Philip gave baptism to an Ethiopian eunuch (Acts viii. 26-40). Philip finally settled in the region of Cæsarea, on the coast of the Mediterranean, where he was found by Paul, who was entertained at his house (Acts xxi. 8). Tradition is not clear concerning his life after this, although there is pretty general agreement that he died a natural death at Tralles.

PHILIP II. (B.C. 382-336). King of Macedonia and father of Alexander the Great. He was born at Pella and was the youngest son of Amyntas II. and Eurydice. When a youth he was taken by Pelopidas as a hostage to Thebes, where he lived several years. After the murder of his eldest brother, Alexander, by Ptolemy Alorites, he was appointed by his brother Perdiccas, when the latter, having slain Ptolemy, came to the throne, to the governorship of a separate district of the country. About B.C. 359 Perdiccas was slain in battle, while fighting with the Illyrians, and Philip assumed the government as guardian of his young nephew, Amyntas, the son of Perdiccas; but he soon set aside Amyntas and took the crown himself. At this time Macedonia was attacked on one side by the Illyrians, Pannonians, and other tribes, and on the other by the Athenians, while within she was torn by the dissensions of several pretenders to the throne; but, buying off the Thracians, who were supporting the pretender Pau-

sanias; conciliating the Athenians, who had taken up the cause of another pretender, Argæus; killing or otherwise disposing of the remaining pretenders, and defeating in battle the threatening tribes, Philip in less than two years firmly established himself on his throne. Henceforward his policy was one of aggression, and the Greek towns on the coast of Macedonia were the first objects of attack. Amphipolis, Pydna, and Potidæa, Athenian possessions or allies on the coast of Macedonia, were the earliest places to fall into his hands. He then secured possession of the rich and valuable gold mines of Thrace, together with the town of Crenides, which he enlarged and called by the name of Philippi. These victories had all been obtained before 355; in 354 he took Methone, on the Thermaic Gulf, after a long siege, in the course of which he lost an eye, and then advanced into Thessaly, to aid the Aleuadæ against Lycophron, the tyrant of Phæræ. Defeating the force that was sent to oppose him, he established his supremacy throughout Thessaly and advanced as far south as the pass of Thermopylæ. The pass being guarded by a strong force of Athenians, who had been aroused by the eloquent warnings of Demosthenes, he returned and directed his arms against Thrace, where he succeeded in establishing his ascendancy. In 349 he began his attacks on the Chalcidian cities, and in 347 completed the conquest of the Chalcidic peninsula by taking the city of Olynthus. In 346 he succeeded in gaining a further foothold in Greece, being called in by the Thebans to assist in the Sacred War against the Phocians. All the towns of Phocis, twenty-two in number, together with the pass of Thermopylæ, surrendered to Philip without resistance. The place which the Phocians had occupied in the Amphictyonic Council was transferred to him, and he was appointed, jointly with the Thebians and Thessalians, president of the Pythian games. In the following years he was again in Thrace, endeavoring to bring the cities in that country under his rule. He was unsuccessful in his attempt on Perinthus and Byzantium, and then turned his attention once more to the northern tribes. In B.C. 339 he was again invited into Greece, this time by the Amphictyonic Council, to take charge of the army that was to oppose the Locrians. Alarmed at his continued successes and his entrance into Greece, the Athenians formed a coalition with Thebes and other Greek States to oppose his advance, but the united army was utterly defeated at the battle of Chæronea in 338. This battle marks the end of Greek independence; Philip was now master of Greece. He at once began preparations for the invasion of Persia on a grand scale, and in 377, deputies from all the different States of Greece except Sparta assembling at Corinth, he was chosen commander-in-chief of the Greek forces. In the midst of his preparations, however, he was assassinated at Egæ by a youth of noble blood named Pausanias, while attending a celebration in honor of the marriage of his daughter with Alexander of Epirus (B.C. 336). The motive for the deed, as stated by Aristotle, was private resentment for neglect on Philip's part to punish Attalus for a gross insult offered to Pausanias.

PHILIP III. A king of Macedonia. See **ARRHIDEUS**.

PHILIP V. (n.c. 237-179). King of Macedonia, son of Demetrius II. and grandson of Antigonus Gonatas. He succeeded his uncle Antigonus Doston in 220. The first part of his reign was disturbed by the contentions of the Ætolian and Achaean Leagues; taking part with the latter, he conducted the war for several campaigns with ability and success. This war was called the Social War, and was concluded in 217, by the Peace of Naupactus. In 216-215 Philip was induced by the successes of Hannibal in Italy to conclude an offensive and defensive alliance with Carthage, the price of which was to be the Roman possessions in Hlyria and the help of Carthage in his Grecian wars. The war which followed (214-205) is known as the First Macedonian War; at no time in the course of it did Philip render Hannibal any effective aid, and for the first three years the war was conducted on both sides with lack of energy. In 214 the Roman general, M. Valerius Leuinus, compelled Philip to raise the siege of Apollonia, and in 211 Rome organized against Macedon a coalition of Greek States with the Ætolian League at the head. Peace was concluded in 205 without material gain on either side. In 204 Philip made a bargain with Antiochus III. to divide between them certain of the dominions of the youthful King of Egypt, Ptolemy Epiphanes. This interference of Philip in the East precipitated the Second Macedonian War with Rome, which began in 200 and was brought to a close by the battle of Cynoscephale in 197. In this battle the Macedonian army was utterly defeated by Titus Quintius Flaminius; Philip was compelled to relinquish his conquests in Europe and Asia, to surrender his fleet, and to pay an indemnity of a thousand talents; Macedonia became an ally, subject to the control of Rome. Philip died in 179, and was succeeded by his son Perseus. Consult: Draysen, *Geschichte des Hellenismus* (2d ed., Gotha, 1877-78); Freeman, *History of Federal Government* (2d ed., New York, 1893); Mahaffy, *Alexander's Empire* (New York, 1888).

PHILIP I. (c.1052-1108). King of France from 1060 to 1108. He was the eldest son of King Henry I. and Anne of Russia. Until 1066, when Philip came of age, his mother and his uncle, Baldwin V. of Flanders, were regents. In the various contests of his great feudatories, to whom belonged William I. of England as Duke of Normandy, Philip often intervened successfully, so that the royal domain was increased until it extended from the valley of the Seine to the valley of the Loire, and also included Bourges. About 1071 Philip married Bertha, step-daughter of Count Robert of Holland. Though a son was born to them in 1081 (later Louis VI.), and afterwards a daughter, Philip nevertheless repudiated his wife in 1092, and began to live with Bertrada, the wife of Count Fulk of Anjou. The result was a continuous strife between the Papacy and the King. In 1095, at the Council of Clermont, Urban II. excommunicated Philip, though Bertha had died in 1094. This excommunication was raised after Philip had promised to put Bertrada away, but renewed in 1097, when he relapsed. In 1105, after Bertrada had died, he was released from the ban. Consult Luchaire, *Louis VI. le Gros* (Paris, 1890).

PHILIP II., or **PHILIP AUGUSTUS** (1165-1223). King of France from 1180 to 1223. He

was the son of Louis VII. and Adèle of Champagne, and was born on August 21, 1165. He was crowned on November 1, 1179, during the life of his father, succeeded him in 1108, and proved one of the greatest monarchs of the Capetian dynasty. In 1181 he made war upon the Count of Flanders and in 1185 forced him to surrender the districts of Vermandois and Amiénois. In 1182 he drove the Jews out of his territories and confiscated all their wealth. In 1187 the English attempt to conquer Languedoc caused a war, in which Philip was aided by the sons of Henry II. (q.v.). After the accession (1189) of Richard to the English throne, Philip and he set out together on the Third Crusade (1190), but quarreled while wintering in Sicily, and their dissensions continuing, Philip, after a sojourn of three and a half months in Syria, set out on his return to France, after taking a solemn oath to respect the integrity of Richard's dominions. No sooner, however, had he returned than he entered into an arrangement for the partition of Richard's territories in France with his unworthy brother, John. Some acquisitions were made, but Richard's return thwarted the calculations of the conspirators, and a war immediately commenced between the two monarchs, in which Philip had at one and the same time to defend his territories against the English and the counts of Champagne, Boulogne, Brittany, and Hainault, who attacked them on all sides. Richard died in 1199; but on the appeal of the Barons of Poitou to Philip, as John's overlord, the war soon recommenced against John (q.v.). The English provinces in France were attacked by the combined French and Bretons, and Normandy, Poitou, Maine, Anjou, and Touraine were annexed to France. In the years 1213 and 1214 Philip waged war against Flanders and thus caused a coalition to be formed by Otho IV. (q.v.) of Germany, John of England, and the Count of Flanders. Philip defeated the allies in 1214 at Bouvines (q.v.). During the rest of his reign Philip was occupied in consolidating his new possessions, and took no part in the war against the Albigenses. In general Philip was in alliance with the Church and the great cities. His first wife was Isabella of Hainault, the mother of Louis VIII.; he next married Ingeborg of Denmark, but repudiated her in 1196 to marry Agnes of Meran. For this he was excommunicated and France was placed under an interdict. Philip yielded in 1200 and took back Ingeborg. He improved and embellished Paris, built many churches and other institutions, encouraged commercial associations, and gave the first charter to the University of Paris. He fortified many of the chief towns, including the capital. He died at Mantes, July 14, 1223. Philip was the first monarch under whom France attained a commanding position in Europe. Consult: Cartellieri, *Philip II., August* (Leipzig, 1899); Luchaire, *Philippe Auguste* (Paris, 1881).

PHILIP III., **L'HARDI**, i.e. the Bold (1245-85). King of France from 1270 to 1285. He was the son of Louis IX., and had his father's piety, but not his ability. He was an unimportant man personally, but his reign is noted on account of the rise of the lawyers as a class of royal advisers. Consult Langlois, *Le règne de Philippe III. le Hardi* (Paris, 1887).

PHILIP IV., THE FAIR (1268-1314). King of France from 1285 to 1314. He succeeded his father, Philip III. During his reign, which was of exceeding importance for the development of the French monarchy, he had three prominent advisers, Pierre Flotte, William of Nogaret, and Enguerrand of Marigny, who, being all taken from the rising legal class, were known as *légistes*. The event which stands out most prominently in this reign was the conflict with the Papacy under Boniface VIII. (q.v.). The French government sought to tax the clergy, whereupon Boniface interfered and issued the bull *Clericis laicos* in 1296, ordering the clergy to refuse obedience to the King. Boniface, it is true, gave way at once when a decree was issued forbidding the exportation of metals from France, the effect of which would have been to cut off a large portion of the Papal revenue, but the success of the Jubilee at Rome in 1300 induced Boniface to believe that he would find sufficient support in a struggle with Philip IV., and hence when in 1301 Bernard Saisset, Bishop of Pamiers, a Papal representative in France, was arrested there, Boniface issued his famous bull *Unam sanctam*. This set forth the highest Papal pretensions, and was a challenge to all monarchs of Europe. Philip, in order to be certain of support, summoned for the first time in the history of France the States-General. In 1303 while Boniface was at Anagni he was suddenly captured by William of Nogaret, and, though released the following day, he died soon after as a result of the shock. After the short rule of Benedict XI., Philip obtained in 1305 the election of his adherent, the Archbishop of Bordeaux, to the Papal chair, as Clement V. In 1309 the Pope took up his residence at Avignon, and until 1378 the Papacy was entirely under French influence, this being the period of the so-called Babylonish Captivity. See PAPACY.

On account of the increased expenditures of the monarchy, due to its greater extension and enlarged duties, it was found more and more difficult to carry on the government with the old revenues alone. A temporary expedient was found by compelling Clement V. to condemn the wealthy Templars and deliver their property over to the French King. Philip early in his reign had difficulties with Edward I. of England. In 1294 he took possession of Guienne, Edward's territory, and in 1297 attacked Guy, Count of Flanders, who had supported the English monarch. Boniface VIII. brought about a truce in 1298, and Guienne was restored to Edward. When, however, Guy of Flanders appeared in Paris in 1300 to submit, Philip cast him into prison. His officials treated the wealthy Flemish cities so harshly that they revolted under Peter of Koninck. Philip's army was decisively defeated at Courtrai (q.v.) in 1302, and in 1305 he made peace, restoring Flanders to the son of Count Guy, the latter having died in prison.

Scholars have long disputed concerning the true character of Philip. On the one hand he has been represented as an avaricious, scheming monarch; on the other as a mild man, who was completely in the hands of bold counselors. But concerning the results of his reign there is no question. Feudalism was suppressed, and the power of the Crown vastly extended. In order to meet the financial needs of the State, the taxes were increased, the Jews persecuted, and their

property confiscated; and when these means were insufficient, the coinage was debased. Consult: Boutaric, *La France sous Philippe le Bel* (Paris, 1861); Funck-Brentano, *Philippe le Bel et la Flandre* (ib, 1896); Jully, *Philippe le Bel* (ib., 1869).

PHILIP V., LE LONG, i.e. the Tall (c.1294-1322). King of France from 1316 to 1322. He was the second son of Philip IV., and on the death of his brother, Louis X., was made Regent, as the Queen was with child. Her son died four days after birth and Philip proclaimed himself King (1316). Many opposed him, supporting the claims of his niece, the daughter of Louis X. The States-General, summoned by Philip in 1317, declared that women could not succeed to the throne. (See SALIC LAW.) In the same year Philip settled the long dispute with Flanders and acquired some territory from its Count. In 1320 a large number of peasants, known as Pastoureaux, led by some renegade clerks, demanded to be taken on a crusade. They committed horrible outrages, but were finally suppressed. Philip's reign is noteworthy for its many administrative reforms. He centralized the treasury receipts at Paris, suppressed the garrisons in castles not on the frontiers, confiscated for the Crown many feudal rights of taxation enjoyed by the nobles, and organized the army more efficiently. In other attempted reforms he was thwarted by opposition from the States-General. Consult Lechugeur, *Histoire de Philippe V. le Long* (Paris, 1897).

PHILIP VI. (1293-1350). King of France from 1328 to 1350, the first King of the House of Valois. He was the son of Charles of Valois, younger brother of Philip IV. At first Regent of France on the death of Charles IV., the proclamation of a king being deferred on account of the pregnancy of Charles IV.'s widow, he was crowned at Rheims on May 29, 1328, after the Queen had given birth to a girl. His right to the throne was denied by Edward III. of England, the grandson of Philip IV., who declared that females, though excluded by the Salic law, could transmit their rights to their children, and, therefore, insisted upon the superiority of his own claims. Philip's reign commenced gloriously, for, marching into Flanders to support the Count against his rebellious subjects, he wiped out the disgrace of Courtrai by vanquishing the Flemings at Cassel, August 23, 1328. The relations with England were very strained, and in 1337 the Hundred Years' War (q.v.) began, mainly through Philip's own fault. It was carried on languidly for several years, the only prominent incident being the destruction of the French fleet off Sluis, June 24, 1340. Philip was very extravagant and delighted in maintaining a brilliant court. The constant round of fêtes and tournaments was never interrupted, even when the war had well nigh exhausted the wealth of the country, for the money to carry them on was immediately provided by some new tax, by an arbitrary change in the coinage, or by some fresh confiscation. In 1338 the States-General declared that their consent was necessary for the imposition of new taxes, but Philip evaded all restraints which were imposed. In 1346 Edward III. landed in Normandy, ravaged the country to the environs of Paris, and totally defeated Philip at Crécy (q.v.). A truce was

then concluded by Papal mediation in 1347, but the kingdom had no sooner been released from war than destruction in another and more terrible form, that of the 'black death' (q.v.), appeared. Nevertheless the extravagance at the Court was as great as ever. During Philip's reign the royal domain was increased by the addition of Valois, Chartres, Anjou, Maine, Champagne, Brie, and Dauphiné, but diminished by the exchange of Navarre for Champagne and Brie. Consult Lavissee and Rambaud, *Histoire générale*, vol. iii. (Paris, 1894), for a good general sketch and bibliography. See FRANCE.

PHILIP II. (1527-98). King of Spain from 1556 to 1598. He was born at Valladolid on May 21, 1527, the only son of the Emperor Charles V. (q.v.). His education was chiefly in the hands of the clergy and he grew up a cold and bigoted man. In 1543 he was married to Maria of Portugal, and upon her death he espoused in 1554 Mary I. of England (q.v.). In 1555 Charles V. surrendered the government of the Netherlands to Philip, and in the following year resigned also the crown of Spain to his son, who had been previously invested with the sovereignty of Naples, Sicily, and Milano. The possession of Spain in the New World included the West Indies, Mexico, and a great part of South America. The early part of the reign of Philip proved very successful. He defeated a coalition formed against him by the Pope and France, his armies winning several battles, notably that of Saint-Quentin (1557), and France was compelled to sign on April 2-3, 1559, the Treaty of Cateau-Cambrésis (q.v.), which marked the abandonment of her rôle as an aggressive power on the side of Italy. Philip determined to stamp out opposition to Roman Catholicism in all his dominions, and this caused the revolt of the Netherlands (q.v.). This successful rebellion, and the enormous expenses it entailed upon Spain, ruined the prosperity of Philip's dominions. The naval supremacy of Spain, moreover, was shattered by the defeat of the Armada (q.v.), which Philip had sent against England in 1588. Besides the war against England, Philip was led by the affairs in the Netherlands to interfere also in the concerns of France. He has been sometimes accused of having instigated the Massacre of Saint Bartholomew, and he supported the Guises against Henry of Navarre (later Henry IV.), but all in vain. On May 2, 1598, the Treaty of Vervins (q.v.) was concluded with France. Against the Turks Philip was more successful. They were decisively defeated in 1571 by his half-brother, John of Austria, commanding the fleet of the Holy League (Spain, Venice, the Papal States), at Lepanto (q.v.). Portugal was conquered by Philip's general, the Duke of Alva (q.v.), after the direct male line of that country had become extinct in 1580. But these successes were unable to outweigh the ruin of Spanish commerce and industry. Philip died after a lingering illness on September 13, 1598. After the death of Mary of England in 1558, Philip married in 1559 Elizabeth, the daughter of Henry II. of France, and when she died in 1568, he married Anna, a daughter of the Emperor Maximilian II. By his first wife Philip had a son, the celebrated Don Carlos (q.v.), and by his fourth wife, his successor, Philip III. (q.v.). Philip II.'s character has been the subject of considerable historical controversy. There can

be little doubt that he was bigoted and morose, but, on the other hand, the popular view, which represents him as a cruel monster, is a false one. He seems to have been an idealist and a visionary, who believed firmly that he was benefiting humanity by his drastic measures. He was often open to appeals for mercy and leniency, but the Inquisition was permitted a free sway in Spain, and all liberty was crushed.

Consult: Prescott, *History of the Reign of Philip II., King of Spain* (Boston, 1855-56), which is valuable, but incomplete; Forneron, *Histoire de Philippe II.* (Paris, 1881-82); Philippson, *Westeuropa im Zeitalter von Philipp II., Elisabeth und Heinrich IV.* (Berlin, 1882); Mignet, *Antonio Perez et Philippe II.* (Paris, 1874); Lobkowitz, *Philippus Prudens* (Antwerp, 1639); Gachard, *Correspondance de Philippe II. sur les affaires des Pays-Bas* (5 vols., Brussels, 1848-79); id., *Lettres de Philippe II. à ses filles les Infantes Isabelle et Catherine* (Paris, 1884); id., *Correspondencia de Felipe II. con sus embajadores en la corte de Inglaterra, 1558-84* (4 vols., Madrid, 1888). See SPAIN.

PHILIP III. (1578-1621). King of Spain from 1598 to 1621. He was the son of Philip II. and is to be remembered chiefly for accelerating the ruin of Spain, which had begun under his father, by driving out in 1609 the Moriscos (q.v.), the most industrious and thrifty inhabitants of Spain.

PHILIP IV. (1605-65). King of Spain from 1621 to 1665. He took little part in the affairs of government, which from 1623 to 1643 were in the hands of his favorite Olivarez (q.v.). In spite of the latter's efforts for the encouragement of trade and industry, the decline of Spain was hastened by exhausting wars in Germany and with France. In 1640 Portugal conquered its independence, and by the Treaty of Westphalia Spain acknowledged the independence of the Netherlands. The Peace of the Pyrenees in 1659 was highly favorable to France. Philip's reign was disturbed also by insurrections in Catalonia and Andalusia.

PHILIP V. (1683-1746). King of Spain from 1700 to 1746, first of the Spanish Bourbon dynasty. He was directly descended on both sides from Philip II., and was born at Versailles, December 19, 1683, the son of the Dauphin Louis and Maria Anna of Bavaria, and grandson of Louis XIV. and Maria Theresa, eldest sister of Charles II. of Spain. The Archduke Charles of Austria, second son of the Emperor Leopold I., stood equally near the Spanish succession; but Charles II., dying without issue, left the kingdom by his last will to Philip, then Duke of Anjou (1700). Philip was at once proclaimed at Fontainebleau and at Madrid as Philip V. To defend this succession, which threatened to disturb the religious political balance in Europe, France and Spain became involved in war with the Grand Alliance, formed by England, Holland, and Austria, and joined by Prussia, Denmark, Hanover, Portugal, and finally Savoy. (See SUCCESSION WARS.) The Peace of Utrecht (April 11, 1713) secured the throne of Spain to Philip, but shorn of the Italian possessions and the Netherlands. Philip V. was distinguished 'for few faults and few virtues,' was weak-minded, and became almost imbecile before his death. His first wife, Marie Louise of Savoy, died in

1714, and with her death ended the influence the Countess Orsini had acquired over him, for Philip married Elizabeth Farnese of Parma, an energetic and ambitious woman. Her schemes for advancing the interests of her sons kept Spain embroiled throughout the reign. The minister Cardinal Alberoni (q.v.) directed his policy toward regaining the lost Spanish possessions in Italy and had to be removed because of the hostility aroused among the powers. In 1724 Philip abdicated in favor of his eldest son, Louis, but upon the death of the latter in the same year he resumed the crown, notwithstanding his increasing incapacity. In 1734-35 Don Carlos, son of Philip, wrested the Two Sicilies from Austria. In 1741 Spain entered into an alliance with France against Maria Theresa in the War of the Austrian Succession. (See SUCCESSION WARS.) Philip died at Madrid on July 9, 1746. He was succeeded by his second son, Ferdinand VI. (q.v.). Consult: Coxe, *Memoirs of the Kings of Spain of the House of Bourbon from the Accession of Philip V. to the Death of Charles III.* (5 vols., London, 1815), a work that is still of value, although new sources have come to light since it was written; Boudeillart, *Philippe V. et la cour de France, 1700-15* (Paris, 1890). See SPAIN.

PHILIP OF SWABIA (c.1177-1208). An emperor of the Holy Roman Empire. He was the youngest son of Frederiek Barbarossa and Beatrice of Burgundy. He was educated for the Church and in 1191 became Bishop of Würzburg. In 1192 he resigned his see. His brother, the Emperor Henry VI., gave him Tuscany in 1195 and in 1196 he succeeded to the Duchy of Swabia. In 1197 he married the Byzantine Princess Irene. On the death of Henry VI., in 1197, Philip endeavored to secure the Imperial crown for his brother's infant son, Frederiek (II.), but the German princes were unwilling to place the child on the throne, and Philip himself was chosen Emperor in 1198. But the Guelphs, under the leadership of Adolf, Archbishop of Cologne, put forward as a candidate Otho of Brunswick, who was crowned two months before Philip (1198), and in 1201 gained the support of Pope Innocent III. Philip fought bravely against great odds, and by bribes won over the Archbishop of Cologne and Hermann of Thuringia, with other powerful princes. In 1205 he was crowned by the Archbishop of Cologne, and captured the city, but let his rival slip through his fingers (1206). He made terms with Otho and with Innocent III. The former broke his promises, and Philip, making ready to attack him, was assassinated by Otho of Wittelsbach. Consult Winkelmann, *Philipp von Schwaben und Otto IV. von Braunschweig* (Leipzig, 1873-78).

PHILIP THE BOLD (1342-1404). Duke of Burgundy from 1363 to 1404. He was the fourth son of John the Good, King of France. He was present in 1356 at the battle of Poitiers (q.v.), and displayed such courage, venturing his own life to save that of his father, that he became known as *Le Hardi*, i.e. 'the Bold.' He shared his father's captivity in England, and on returning to France in 1360 received in reward of his bravery the Duchy of Touraine, and subsequently (1363) also that of Burgundy, being created at the same time the first peer of France. In 1369 he married Margaret, the daughter and

heiress of Count Louis de Male of Flanders. On the death of King Charles V., in 1380, he became Regent, together with his brothers, for his nephew, Charles VI. In 1382, at the head of a French army, he marched against Philip van Artevelde, the leader of the Flemish burghers in their revolt against their Count, and overwhelmed him in the battle of Roosebeke. Flanders, Artois, and Franche-Comté fell to him by the death of Louis in 1384. Energy and wisdom characterized his government; arts, manufactures, and commerce were encouraged, and his land was one of the best governed in Europe. When Charles VI. became insane (1392) the supreme control of affairs in France fell into the hands of Philip, and he used his power to strengthen his own line. He died at the château of Hall in Hainault, April 27, 1404. Consult Lavisse and Rambaud, *Histoire générale*, vol. iii. (Paris, 1894), and bibliography. See also FRANCE.

PHILIP THE GOOD (1396-1467). Duke of Burgundy from 1419 to 1467. He was the son of John the Fearless and Margaret of Bavaria. He was born at Dijon, June 13, 1396, and on the assassination of his father on the bridge of Montereau, succeeded to the Duchy of Burgundy. Bent on avenging the murder of his father, he entered into an offensive and defensive alliance with Henry V. of England at Arras in 1419, recognizing him as the rightful Regent of France, and heir to the throne after Charles VI.'s death. This agreement was sanctioned by the imbecile King himself as well as by the mother of the Dauphin, Queen Isabella, in the Treaty of Troyes (1420). The Dauphin (later Charles VII.), however, declined to resign his rights, and took to arms, but was defeated and driven beyond the Loire. Some disputes with the English concerning possessions in Brabant and elsewhere prompted Philip to threaten in 1429 to conclude a treaty with Charles VII. However, the English, by ceding to Philip the Province of Champagne, and paying him a large sum of money, restored him to their side. In 1429-30 Namur, Brabant, and Limburg were annexed to Burgundy, and in 1433 Countess Jacqueline ceded Hainault, Holland, and Zealand to Philip. Though much more powerful than his nominal superior, the King of France, Philip did not take the royal title. After the death of his wife, sister of the English Regent in France, the Duke of Bedford, he gradually drew nearer to Charles VII., and in 1435 tried to negotiate a peace at Arras between all parties in the Hundred Years' War. The English demands proving excessive, he made peace alone with the French King. The latter part of his reign was filled with trouble caused by the quarrels between Charles VII. and his son, the Dauphin Louis, afterwards Louis XI. (q.v.), who had fled from his father's Court, and sought shelter with Philip. Philip died at Bruges, July 15, 1467, deeply lamented by his subjects. Under him, Burgundy was the most wealthy, prosperous, and tranquil State in Europe; its ruler was the most feared and admired sovereign of his time, and his Court far surpassed in brilliancy those of his contemporaries. Knights and nobles from all parts of Europe flocked to his jousts and tournaments. In 1430, in honor of his marriage with Isabella of Portugal, his third wife, he established the famous order of the Golden Fleece (q.v.). De Baranté, *Histoire des ducs de Bourgogne*, vols.

iii.-vi. (2 ed., Brussels, 1834-40). See CHARLES VII.

PHILIP THE MAGNANIMOUS (1504-67). Landgrave of Hesse from 1509 to 1567. He was born on November 13, 1504, and succeeded to the throne on the death of his father, William II. In 1518 he began to govern in person. At first he showed no sympathy for the Lutheran doctrines, of which he was to become the champion, and in 1523 he married the daughter of the Catholic Duke George of Saxony. In 1525, however, he was definitely won over to the cause of the Reformation. At the same time he aided in suppressing the Peasants' War. Philip became one of the chief leaders of the Reformation in Germany, and together with the Elector John of Saxony formed in 1526 the Protestant League of Gotha and Torgau. In 1529 he arranged the celebrated disputation between Luther and Zwingli at Marburg. It lasted for three days (October 1st-3d), but the two parties were unable to agree on the doctrine of the Eucharist. Philip himself, however, began to lean strongly toward the Swiss side. In 1531 he formed together with the Elector of Saxony and other Protestant princes the League of Schmalkald (q.v.). On March 4, 1540, Philip married a second time, though his first wife was still living. Luther and Melancthon had consented to this bigamy, and the revelation of this fact caused a great scandal. In the Schmalkald War, which broke out in 1546, Philip did his best for the Protestant cause, but the treachery of Maurice of Saxony, his son-in-law, who joined Charles V., made matters hopeless. At the battle of Mühlberg on April 24, 1547, Philip was made prisoner and placed in close confinement. He was liberated in 1552 by the action of Maurice, who deserted Charles and rejoined the Protestant cause. Philip died on March 31, 1567, leaving four sons, among whom Hesse was divided. Consult: Rommel, *Philipp der Grossmütige, Landgraf von Hessen* (Giessen, 1830); Ranke, *History of the Reformation in Germany* (Eng. trans., London, 1845-47); Janssen, *History of the German People at the Close of the Middle Ages* (Eng. trans., ib., 1896—).

PHILIP THE MAGNANIMOUS, ORDER OF. A Hessian order of merit with five classes, founded by Grand Duke Ludwig II. in 1840. The decoration is an eight-pointed cross of white enamel, with the motto *Si Deus nobiscum, quis contra nos*.

PHILIP, KING (?-1676). A famous Indian chief, son of Massasoit; called by the English King Philip, though his Indian name was Metacomet. He became sachem of the Wampanoags, who were settled in the Rhode Island Country in 1662, and in the same year went to Plymouth and promised to maintain friendly relations with the English colonists and not to cede any territory without their knowledge. About 1670 his friendly intentions began to be suspected on account of frequent meetings of the tribes and many murders of white settlers. In view of these suspicions, Philip and the principal tribesmen were summoned to meet the whites and explain their movements. This they did, and also agreed to surrender their arms; but it was only a truce, and preparations for war were still secretly carried on by the Indians. An Indian convert named Sausamon revealed to the colonists the prepara-

tions made by Philip, and was murdered by the Indians. In revenge for the execution of his murderers by the whites, the Indians killed eight or nine colonists, and open hostilities were begun in June, 1675. The Indians did not venture to meet the colonists in battle, but burned or attacked a number of their settlements, including Swansea, Brookfield, Deerfield, and Hadley, and laid ambushes for the settlers. In December, 1675, Governor Josiah Winslow led a force of 1000 men against the Narragansets, with whom Philip had formed an alliance, took by storm a fort said to have contained 4000 Indians, near the present location of Kingston, R. I., destroyed their village of 500 wigwams, and put to death 500 of their warriors and twice as many Indian women and children. The war went on for the first six months of 1676, and was marked by burnings and massacres at Weymouth, Groton, Medfield, and Lancaster, Mass., and at Warwick and Providence, R. I. But the increased efforts of the colonists soon struck demoralization into the ranks of the Indians. A substantial reward was offered by the Government for every Indian killed in battle, and many Indian women and children were captured and sold into slavery. A force under the command of the great Indian fighter Capt. Benjamin Church (q.v.) hunted Philip from place to place, at last locating him through the aid of a friendly Indian in a swamp near Mount Hope, where he was killed by another Indian while trying to escape. His body was quartered, on a Thanksgiving Day especially appointed, and his head was sent to Plymouth, where it was long kept on a gibbet. During this war some 600 colonists were killed, 600 buildings burned, and 13 towns destroyed, but of the two once powerful Indian tribes it is said that less than 200 individuals were left. The cost of the war was estimated at \$1,000,000. Consult: Fiske, *The Beginnings of New England* (Boston, 1889); Palfrey, *History of New England* (ib., 1864); and Doyle, *The English Colonies in America*, vol. iii. (New York, 1889).

PHILIP, GOSPEL OF. See APOCRYPHA, section on *New Testament*.

PHILIP, THE ADVENTURES OF. A novel by Thackeray (1862). This sequel to *The Shabby Genteel Story* appeared in the *Cornhill Magazine* (1861-62). Philip Firmin, the attractive, high-spirited hero, was almost ruined by his unspeakable father, the doctor, ignored by his relatives, helped by the Pendennises, and happily married to Charlotte Bayne.

PHILIP, JOHN WOODWARD (1840-1900). An American naval officer, born in New York City. He was appointed to the United States Naval Academy at the age of sixteen, became midshipman in 1861, and during the Civil War served in the Gulf blockading squadron, the James River fleet, and the South Atlantic blockading squadron, acting as executive of the *Chippewa*, *Purnee*, and *Montauk* at the siege of Charleston. In July, 1862, he was promoted to be lieutenant, and in July, 1866, to be lieutenant-commander. After the war he was executive successively of the *Hartford* and the *Richmond*, was placed in command of the *Monocacy* in June, 1873, and in December, 1874, was commissioned commander. From 1874 to 1876, on leave of absence, he commanded one of the steamers of the Pacific Mail Steamship Company, running between San Fran-

cisco and Hong Kong, and in 1877, again on a leave of absence, he commanded the 'Woodruff Scientific Expedition Around the World.' He was promoted to be captain in 1889, commanded the Boston Navy Yard from 1894 to 1897, and in the latter year was placed in command of the battleship *Texas*, which, still under his command, took a prominent part in the naval battle of Santiago during the Spanish-American War. In August, 1898, he was promoted to be commodore and was placed in command of the second squadron of the North Atlantic fleet, and in March, 1899, he was promoted to be rear-admiral and made commandant of the Brooklyn Navy Yard.

PHILIP NERI, SAINT (1515-95). The founder of the Congregation of the Oratory (q.v.). He was born at Florence of a distinguished family, July 21, 1515. On the death of his parents in 1533, he was adopted as his heir by a wealthy relative, with whom he lived for a time at San Germano, near Monte Cassino. But he relinquished these prospects to devote himself to the service of God, and on the advice of the Benedictine monks of Monte Cassino, came to Rome to make his theological and philosophical studies (1534-37). He devoted himself to works of mercy, once sold his books to feed the poor, and in 1548, in conjunction with his confessor, Persiano Rosa, founded the Confraternity of the Holy Trinity to care for the needs of the vast numbers of pilgrims who came to Rome. This brotherhood is said to have provided hospitality for not less than 600,000 pilgrims in the jubilee year of 1625, and for a quarter of a million in 1825. (See Morichini, *Instituti di pubblica carità* Rome, 1870). Having long refused holy orders from motives of humility, he finally received them in 1551, and began as a priest a still more remarkable career of devotion and influence. Inspired by the tidings of the heroic labors and death of Saint Francis Xavier, he determined to go to the Indies, and assembled 20 companions; but he was finally convinced that Rome was meant to be the field of his work. The objects of the informal association out of which the Congregation of the Oratory later developed were the instruction and training of the young and uneducated. As a means of withdrawing them from dangerous amusements, sacred musical entertainments (hence called by the name of *oratorio*) were held in the oratory, at first consisting merely of hymns set to popular tunes, but afterwards partaking more of the nature of sacred dramas. The music was composed by the first musicians of Rome. Palestrina was a spiritual child of Philip's, and died in his arms. It was in the lectures originally prepared for use in the oratory that, at Saint Philip's instance, the gigantic Church History of Baronius had its beginning. The personal character of Philip, the unselfish devotion of his life, his unaffected piety, genuine love of the poor, kindly and cheerful disposition, and perhaps as much as anything else a certain quaint humor which pervaded many of his sayings and doings, contributed to popularize his work. The development of the Oratory was almost unconscious. In 1564 Philip was requested by his fellow-countrymen the Florentines in Rome to take charge of their Church of San Giovanni near the Ponte Sant' Angelo; he declined, until Pope Pius IV. gave him permission to hold it while still retaining his residence in his humble

cell at San Girolamo. In 1574 the Florentines erected a new oratory near the church, and the exercises were held there for a time; the following year he saw himself compelled to provide for the permanence of his work on a larger scale, and, taking the small Church of Santa Maria in Vallicella, he pulled it down and built a large new one. Here he was authorized by Gregory XIII. to found a definitely organized congregation in the same year. He still remained at San Girolamo, and refused to appear as the head and founder of the new society, until in 1583 he was expressly commanded by the Pope to take up his residence in the new house. Then his associates elected him superior for life, despite all his protests. Ten years later, however, he prevailed upon them to let him lay the burden aside, and Baronius was chosen in his stead. He died May 26, 1595. Paul V. beatified him in 1615 and Gregory XV. canonized him in 1622. Called the Apostle of Rome, he remains to this day emphatically the popular saint of the Roman people, who observe his feast-day with great devotion. From 1726 until the Italian occupation, the popes were accustomed to go in solemn state on this day to visit his tomb and to say mass there. Consult the contemporary lives of Gallonio, Barnabei, and Bacci (the two first contained in the *Acta Sanctorum*); English translation of the last by F. W. Faber (London, 1847); a modern biography by Cardinal Capecepatro (Naples, 1879; Eng. trans., London, 1894); *Maxims and Counsels of Saint Philip Neri* (Dublin, 1890); Cardinal Wiseman, *Panegyric of Saint Philip Neri* (London, 1856).

PHILIPP, ISIDOR (1863—). A French pianist of Austrian birth. He was born at Pesth, but early removed to France. In 1879 he entered the Conservatory as a pupil of Mathias, and later studied under other famous teachers of that institution. He was intimately connected with the musical life of Paris, and did much to spread a love for classical chamber music. He was one of the most popular artists appearing at the Lamoureux concerts, and was equally well received throughout the large cities of France. In London and Brussels he was also highly esteemed. His published compositions have been successful, particularly his editions of classic studies. Together with Loeb and Berthelier, he organized a series of concerts given in the Salle Erard, which concerts were largely devoted to the presentation of new French compositions. He was also co-founder and subsequent president of the Société d'Art.

PHILIPPA OF HAINAULT, há'nó' (c.1314-69). An English queen, wife of Edward III. and daughter of William the Good, of Holland and Hainault. She was married in 1328 to her cousin, Edward of England, by Papal dispensation, and brought him a large dowry and valuable Continental allies during the war with France. It is said that she summoned the forces which defeated the Scottish troops at Neville's Cross (q.v.) in 1346. Philippa was mother of the Black Prince, Edward. She was a patron of Froissart and was very popular among the English common people. Queen Philippa is notable because she aided in maintaining and strengthening that close connection of England and Flanders, so important for English commerce.

PHILIPPE DE THAUN. See THAUN.

PHILIPPEVILLE, fê'lêp'vel'. A fortified seaport and the capital of an *arrondissement* in the Department of Constantine, Algeria, 38 miles north-northeast of the city of Constantine, on the Gulf of Stora, between Cape Boujaroun and Cape de Fer (Map: Africa, E 1). Laid out in 1838 by Marshal Valée, on the ruins of the ancient Russica, it is one of the prettiest towns in Algeria, and thoroughly French in its character. Philippeville is the chief railway station for the Department of Constantine, and is connected by steamer with Marseilles and Algiers. It has several public offices, a large hospital and dispensary, Catholic and Protestant churches, public library and museum, theatre, etc. It has a distillery, tanneries, and cork manufactures. In the vicinity at Filfila are quarries of marble and iron mines. The town is an important entrepôt of the commerce of the east of Algeria and the Sahara, and the country in the vicinity is picturesque and fertile, producing grain, tobacco, cotton, and fruits. Its fine outer and inner harbors of 125 acres are protected by two breakwaters. The total annual value of its imports and exports is \$17,500,000. Population, in 1901, 21,251.

PHILIPP GALEN, gâ'len. See LANGE, ERNST P. K.

PHILIPPI (Lat., from Gk. Φιλίπποι). A city of Macedonia. It was named after Philip II. of Macedon, who conquered it from Thrace, up to which time it had been called Crenides, or 'the place of fountains,' and enlarged it because of the gold mines in its neighborhood. It was situated on a high hill on the southern edge of a great plain, and about nine miles from the coast, where was the harbor Neapolis. With the rest of Macedonia it fell under the Roman power in B.C. 168, and was joined to the District of Amphipolis. In B.C. 42 it was the scene of the battles between Brutus and Cassius on the one side and Mark Antony and Octavian on the other, which resulted in the destruction of the former. In consequence of this victory, Augustus subsequently made it a Roman colony and conferred on its inhabitants the *jus Italicum*, which exempted them also from the land tax. Here about A.D. 50 the Apostle Paul founded a Christian church, to which is addressed the Epistle to the Philippians. An epistle to the same church is also preserved among the writings of Polycarp. The ruins are still called in Turkish Felib-edjik.

PHILIPPI, FELIX (1851—). A German dramatist, born in Berlin. He early entered journalism, and in 1875 removed to Munich, where he contributed to various French and German papers. After about 1884, however, he devoted himself almost wholly to the writing of plays, and ultimately became one of the most popular contemporary dramatists in Germany, his plays being produced also in other countries and being given with considerable success in the German theatres in New York City. As a playwright he is classed with the modern realistic school. His plays include: *Der Advokat* (1884); *Irrlicht* (1885); *Daqmar* (1886); *Meeresleuchten* (1888); *Das alte Lied* (1889); *Die kleine Frau* (1891); *Der verlorene Sohn* (1892); *Wohlthäter der Menschheit* (1895); *Der Dornenweeg* (1895); and *Wer Wars?* (1896).

PHILIPPIANS, EPISTLE TO THE. One of the New Testament letters, whose authorship is

generally assigned to Paul. It was written to the church at Philippi to correct tendencies toward faction and self-seeking among its members (ii. 1-4, 14; iv. 2-5), to warn them against evil influences in their midst (iii.), to encourage and strengthen them in their Christian life and work (i. 12-30; ii. 12-16; iv. 1, 4, 6, 8), and to thank them for their practical ministry to the Apostle's needs in his imprisonment (iv. 10-19). It differs from the principal Pauline Epistles in the marked absence from its contents of controversial topics, while, on the other hand, it is unlike most of the subordinate writings of the Apostle in containing passages which have formed the gathering points of considerable theological debate. These are chiefly the notable Christological passage of the second chapter (vs. 5-11) and, though to a much less degree, the well-known soteriological passage of the third chapter (vs. 3-16).

In spite of the denial of the Epistle's Pauline origin by the Tübingen school (1845) and by as recent and able a scholar as Holsten (1898), the letter is to-day almost universally accepted as from the Apostle—its rejection by the modern Dutch school of criticism (1882) merely forming a part of their peculiar negative position with regard to all the New Testament books. A phase of this Dutch critical attack, however, is the denial of the Epistle's integrity, in which position certain outside the school have joined (Spitta, 1893; Clemen, 1894). But, though there are recognized difficulties in its sequence of thought, especially in the connection of the third chapter with its preceding and following context, the letter's unity is generally maintained by critics to-day. Scholars have almost without exception settled upon Rome, during Paul's first imprisonment, Thiersch (1879) and Macpherson (1892) being practically alone among later writers in the assertion of an origin at Casarea before Paul's voyage to Rome.

That which may be said to be of chief interest in the criticism of the Book is the question of its relative order to the other Epistles of Paul's first Roman imprisonment. The opinion more generally in favor to-day is that it is the last of this captivity group. It is argued that (a) the large size of the Church of Rome (i. 12-14); (b) the evidence of success from Paul's evangelistic work (i. 12-18), which would follow the statements made in Colossians and Ephesians of desire for such success (Col. iv. 3-4; Eph. vi. 19-20); (c) the several journeys between Philippi and Rome involved in the Philippians' ministry to the Apostle (ii. 25-27; iv. 18); (d) the desertion of the Apostle by his friends (ii. 19-21), which shows itself to be the climax of Col. iv. 11 and at the same time stands in contrast to Col. iv. 10-14 and Philemon 23-24; (e) the expectation of the near approach of his trial and the decision for life or death (i. 20-22; ii. 17, 24-26; iii. 10)—that these all show more naturally a later rather than an earlier date of writing. On the other hand, it is held that the similarity of much of the contents of the Epistle to the characteristic thought of Romans, and of much of the contents of Colossians and Ephesians with that which marks the thought of the pastors, show in both cases a state of mind on the Apostle's part which would most naturally fit in with a nearness in composition of the respectively related Epistles. Whatever may be said,

however, as to the reasonableness of either line of argument, it is quite clear that the passage regarding the variant preachers in Rome (i. 14-18), with its bearing upon the state of the Roman Church when the Apostle wrote his letter to it, must be fully understood before the question of the date of this Philippian letter can be finally settled. To this study is being directed to-day.

BIBLIOGRAPHY. Besides the standard New Testament introductions, consult the following commentaries and discussions: Klöpffer (Gotha, 1893); Lightfoot (London, 1894); Haupt, in *Meyer-Kommentar* (Göttingen, 1897); Lipsius, in *Holtzmann Hand-Kommentar* (Freiburg, 1892); Moule, in *Cambridge Bible for Schools* (Cambridge, 1893); id., *Philippian Studies* (London, 1897); Vincent, in *International Critical Commentary* (New York, 1897); Baur, *Paulus* (Eng. trans., Edinburgh, 1873-75); Spitta, *Zur Geschichte des Urchristentums* (Göttingen, 1893); Clemen, *Die Einheitlichkeit der paulinischen Briefe* (Göttingen, 1894); Gifford, *The Incarnation* (New York, 1897); Holsten, *Paulinische Theologie* (Berlin, 1898).

PHILIPPICS. See CICERO; DEMOSTHENES.

PHILIPPINE ISLANDS. An archipelago forming the most northern group of islands in the Malay or Eastern Archipelago. It lies wholly within the tropics. The land surface extends between latitudes 21° 10' and 4° 40' N., 1150 statute miles; the east and west limits are longitude 116° 40' and 126° 34' E., making about 650 miles. The most northern land in the Philippines is Y'Ami Island, of the Batanes group; the most southern is Balut Island, of the Sarangani Islands, south of Mindanao; the most western is Balabac Island, north of Borneo; and the most eastern is Sancó Point, on the east coast of Mindanao. The archipelago is bounded on the north and west by the China Sea, on the east by the Pacific Ocean, and on the south by the Sea of Celebes and the coastal waters of Borneo. It is 93 miles distant from foreign territory on the north (Formosa); 31 miles from Balambangan, an island near Borneo, on the south; 510 miles from the Pelew group (German) on the east, and 515 miles from Cochín-China (French) on the west.

The archipelago numbers about 1600 islands, most of them very small, and having altogether about 11,500 miles of coast line. Two of them, Mindanao and Luzon, are, however, classed among the larger islands of the world, and eleven islands, Luzon, Mindanao, Samar, Panay, Negros, Palawan (Paragua), Mindoro, Leyte, Cebú, Masbate, and Bohol, are of primary geographical importance. The others are mainly dependent islands or islets along the coast of the large islands or subordinate archipelagoes like the Sulu Islands. The area of the total land surface is computed at 127,853 square miles, or a little larger than the New England States, New York, and New Jersey together. Mindanao (45,559 square miles) and Luzon (43,075 square miles) comprise about seven-tenths of the total land surface, the area of the other leading islands being: Samar, 5198 square miles; Negros, 4839; Panay, 4752; Palawan, 4368; Mindoro, 4050; Leyte, 3872; Cebú, 1668; Bohol, 1400; and Masbate, 1230. The total water surface within the limits occupied by the archipelago is 705,115 square miles.

TOPOGRAPHY. This immense labyrinth of islands forms that part of a vast submarine plateau which has emerged above the ocean. The surrounding waters are shallow, for the most part not over 200 feet in depth, showing that the wide plateau on which the islands stand nearly approaches the surface. But strewn here and there over the sea floor are troughs and hollows and wide depressions, particularly to the west of Luzon and Mindanao, where greater depths are found. There is nothing approaching oceanic depths till the eastern edge of the submarine plateau descends to the Pacific deeps from 100 to 300 miles east of the archipelago. In the south three lines of islands stretch like isthmuses between the main archipelago and the southern lands. In the northwest is the most regular and best developed of these isthmuses, stretching from Mindoro to North Borneo, the long, narrow island of Palawan forming more than half its extent. In the centre the Sulu Archipelago connects the western terminus of Mindanao with the northeastern point of Borneo; and in the southwest the great peninsula of Celebes with the Sanguir Archipelago and other islands forms another isthmus, sweeping around to the south of Mindanao. These ridges are extended throughout the archipelago in the form of mountain ranges, from south to north, and form a large part of its relief. From the southern coast of Mindanao to the north of Luzon the mountains are disposed in a line with or parallel to the southern isthmuses. The whole interior is essentially mountainous, the Cordilleras extending north and south, their highest peaks ranging from 3720 to 10,312 feet (Apo in Mindanao), with outlyers and ramifications partly filling the gaps between the ranges. Narrow plains occur between the mountains and wider ones where the river valleys broaden near the coast, and are enriched with alluvial deposits. Mountains are the backbone of all the islands, though in Leyte there are no mountains of special prominence. Three ranges in Luzon and four in Mindanao are the dominating features in the topography of those largest islands. The wider plains are in the basins of the larger rivers of Mindanao and Luzon. Owing to the predominance of mountains, the area of tillable lands is not believed to be one-third of the total area.

HYDROGRAPHY. In the smaller and narrower islands the mountain chain which is the backbone of each island is the great central water-parting, streams flowing to the sea on either side of it in short, straight courses. Mindoro, for example, has about 60 independent little rivers. The drainage of the larger islands is more complicated, the parallel arrangement of the mountain chains giving space for the development of considerable streams. Among them is the Rio Grande de Cagayan (q.v.), with a drainage basin of 16,000 square miles, or much more than one-third of Luzon. All the interior waters of North-eastern Luzon are tributary to the Cagayan, reaching the China Sea on the north coast of the island. All the interior waters of Central Luzon, south of the Cagayan basin, are included in the system of the Rio Grande de la Pampanga, which empties through a wide delta into Manila Bay. The mountains are so near the sea in East Luzon that the rivers of that coast are of small importance excepting the Bicol in the southeast, which floats small vessels; but in the northwest the

Agno has 11 feet of water on its bar at high tide, which gives some importance to the port of Dagupan at its mouth. The Pasig is only 12 miles long, but as it connects Bay Lagoon (q.v.), or Laguna de Bay, with Manila Bay through the chief port of the island, it is a commercial highway of importance. The river systems of Mindanao, confined within the parallel ranges, have chiefly a north and south direction and are more important for navigation than those of Luzon. The Rio Grande de Mindanao, one of the largest rivers in the Philippines, drains the central basin of the island, carries the waters of many tributaries to the Celebes Sea on the west coast, and is navigable for gumbats as far as Lake Lagusan. The Rio Agusan (q.v.) rises about 25 miles from the south coast, and reaches the sea on the north coast, nearly dividing the island. It is navigable for a few miles from its mouth. The most important lakes in Luzon are: Laguna de Bay, 25 miles long and 21 miles wide, which receives numerous small streams from the mountains around it, and Bombon, 14 by 11 miles in extent, Taal volcano rising amid its waters. The largest lakes of Mindanao are Maguindanao, in the centre, and Malanao, near the north coast. Smaller lakes are scattered over the islands.

CLIMATE. As the archipelago is wholly within the tropics, the climate is naturally very warm. From November to February inclusive, the most temperate months, the temperature ranges from 75° to 80° F. The hottest months are April, May, and June, when the monthly mean ranges between 81° and 83°. The intermediate temperatures are in March, July, August, September, and October, when the mean is from 79° to 81°. The temperature at Manila rarely rises above 100° in the shade, and does not fall below 60°. The prevailing atmospheric humidity intensifies the discomforts of heat, from which there is little relief in the three hottest months; but in December, January, and February the nights are fairly cool. As the mean temperature for the year varies merely by a few degrees, only two seasons are recognized. In the wet season, from June to October, five months, the rains are very heavy in the interior and on the west coast, because the moist southwest monsoon there prevails. The east coasts do not share in the excessive precipitation, because they are shielded by the mountains. In the dry season, from November to May, the comparatively dry northeast monsoon prevails, there are many fair days, and the precipitation is greatest on the east coast. The rivers often overflow their banks during the wet season and wide areas in the larger islands are submerged; but the floods are not feared so much as the cyclonic storms of wind and rain known as typhoons, which seldom occur south of 9° N. latitude, but north of that line sometimes destroy the lives of thousands of persons and wreck many vessels and villages. Cyclones are most frequent in July, August, September, and October, when these whirling winds from the Pacific occasionally sweep the whole archipelago north of Mindanao. The most terrific of these storms recorded in the Philippines struck Manila in 1882, traveling at a velocity of 140 miles an hour.

The danger from epidemic diseases is not great except for the occasional visitations of cholera, which is difficult to control, as has been proved since the United States acquired the islands.

Smallpox is always prevalent, but very seldom attains wide-spread development. The bubonic plague has never gained a strong foothold, though in 1901-02 the most strenuous efforts were required to suppress it. Malaria is prevalent in some islands, especially Mindoro, Balabac, and parts of Palawan, Luzon, and Mindanao, but large districts are entirely free from it. Malarial fevers and digestive troubles are the chief diseases. On the whole the health of the natives is fairly good, but the climatic conditions, except in some districts, are not favorable to long residence by Americans or Europeans. It is fortunate that some places among the mountains afford health resorts to which white persons may go for recuperation. Such an asylum is the elevated plateau of the small province of Benguet, 150 miles north of Manila, where, during the hottest month of the year, the temperature is not over 70° F. at midday.

FLORA. The vegetable life is rich and varied, with very few distinctive species, but some plants that are transitional between the flora of Formosa on the north and Borneo on the south. Sixty species of large trees afford the most valuable hard woods for the use of the ship-builders and cabinet-makers. Many other trees are so hard that they cannot be cut by the ordinary circular saw. The bamboo grows in numerous varieties, and, as in other parts of the Malayan Archipelago, is indispensable to the natives. The cocoa palm flourishes everywhere and many of the ripe nuts are collected in rafts and floated to market. The oil is used in cooking and as an illuminant. Other palms are very numerous. The banyan is common and grows to enormous dimensions, and the cinnamon, clove, and pepper are found wild in the southern islands. About 1200 genera and 5000 species of plants have thus far been recognized by botanists. Economically the most valuable of the wild plants is Manila hemp, the fibre of a wild plantain (*Musa textilis*). The plant closely resembles the edible banana in appearance and grows best on shaded hillsides at moderate elevations. The export crop is raised on plantations, which yield, when carefully managed, an annual return of 30 per cent. on the capital invested. This fibre is not successfully raised elsewhere except on a few plantations in North Borneo. Practically all the cultivated plants of the South Asian island world are successfully raised, including rice, sugar, tobacco, coffee, cocoa, maize, and sweet potatoes.

FAUNA. The islands are poor in indigenous mammals. The most important animal is the carabao or water buffalo, which is caught young, tamed, and universally employed as a draught animal, while his tough flesh is valued by the natives as meat. He is usually docile, but is slow and lazy and during the heat of the day will not work more than two hours at a time without his mud bath. The female gives abundant milk, from which *ghee*, a kind of butter is made. The hide makes valuable leather. The timarau, a small buffalo living in the jungles of Mindoro, has never been tamed; it often attacks and kills the larger carabao. A small humped variety of cattle are raised in large numbers for beef on some of the islands. Goats are common and are utilized both for milk and flesh. There are several species of deer, and both wild and domesticated hogs are very abundant. The larger horse as known in America and Europe, does not thrive, but the Philippine

PHILIPPINE ISLANDS.

Capital: Manila
 Treaty Boundaries:
 Railroads:
 Telegraph Cables:

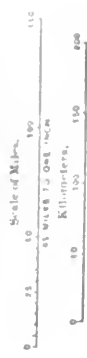

Longitude East from Greenwich

121 Part of Japan
 21 Sea
 20 PART OF CAGAYAN PROVINCE
 19 Luzon I.
 18 Batangas I.
 17 Channel
 16 Cebu I.
 15 Mindanao I.
 14 Palawan I.
 13 Basilan I.
 12 Sulu I.
 11 Zamboanga I.
 10 Zamboanga I.
 9 Zamboanga I.
 8 Zamboanga I.
 7 Zamboanga I.
 6 Zamboanga I.
 5 Zamboanga I.
 4 Zamboanga I.
 3 Zamboanga I.
 2 Zamboanga I.
 1 Zamboanga I.

P A C I F I C
 O C E A N
 C H I N A
 S E A
 V I S Y A N S E A

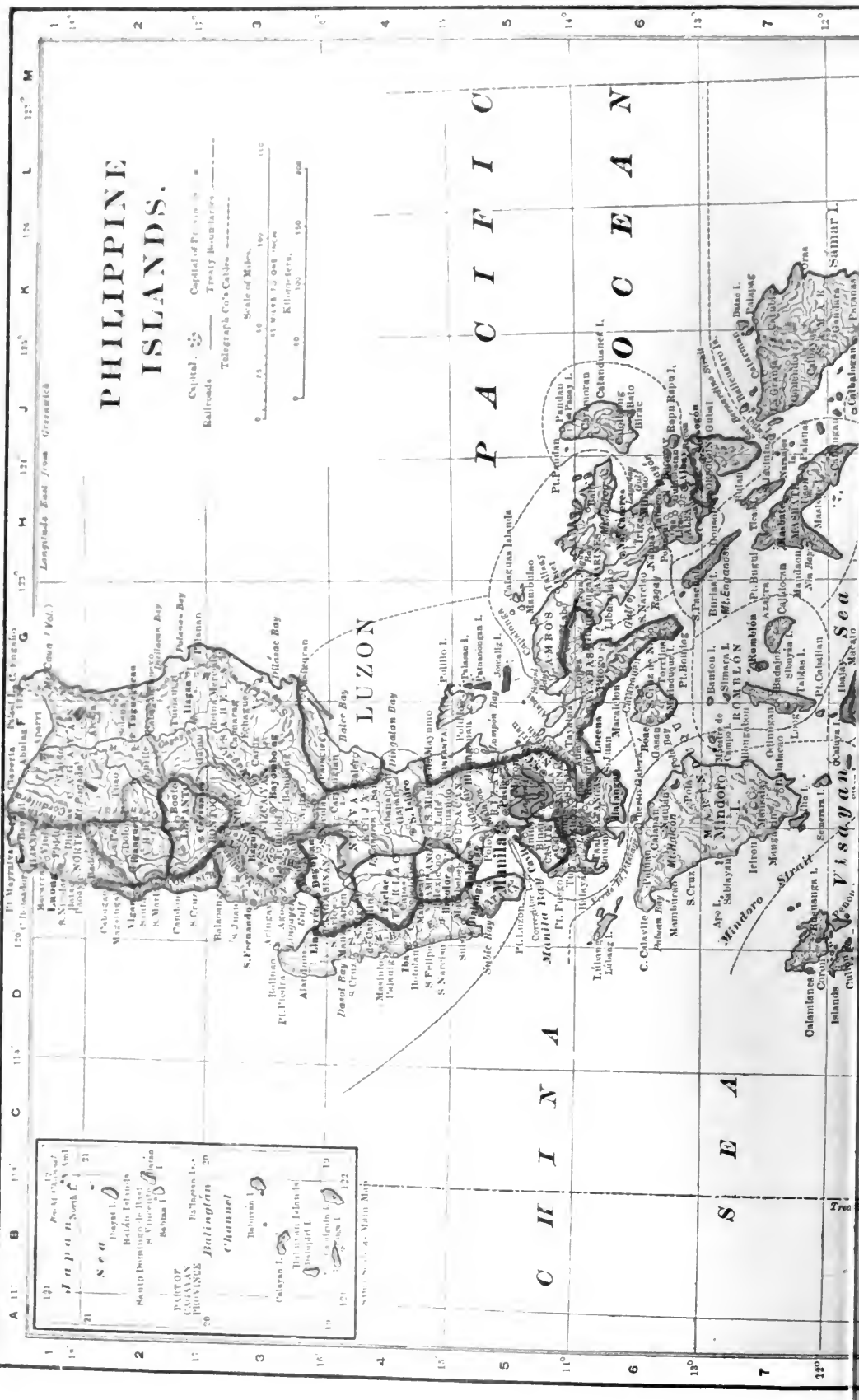

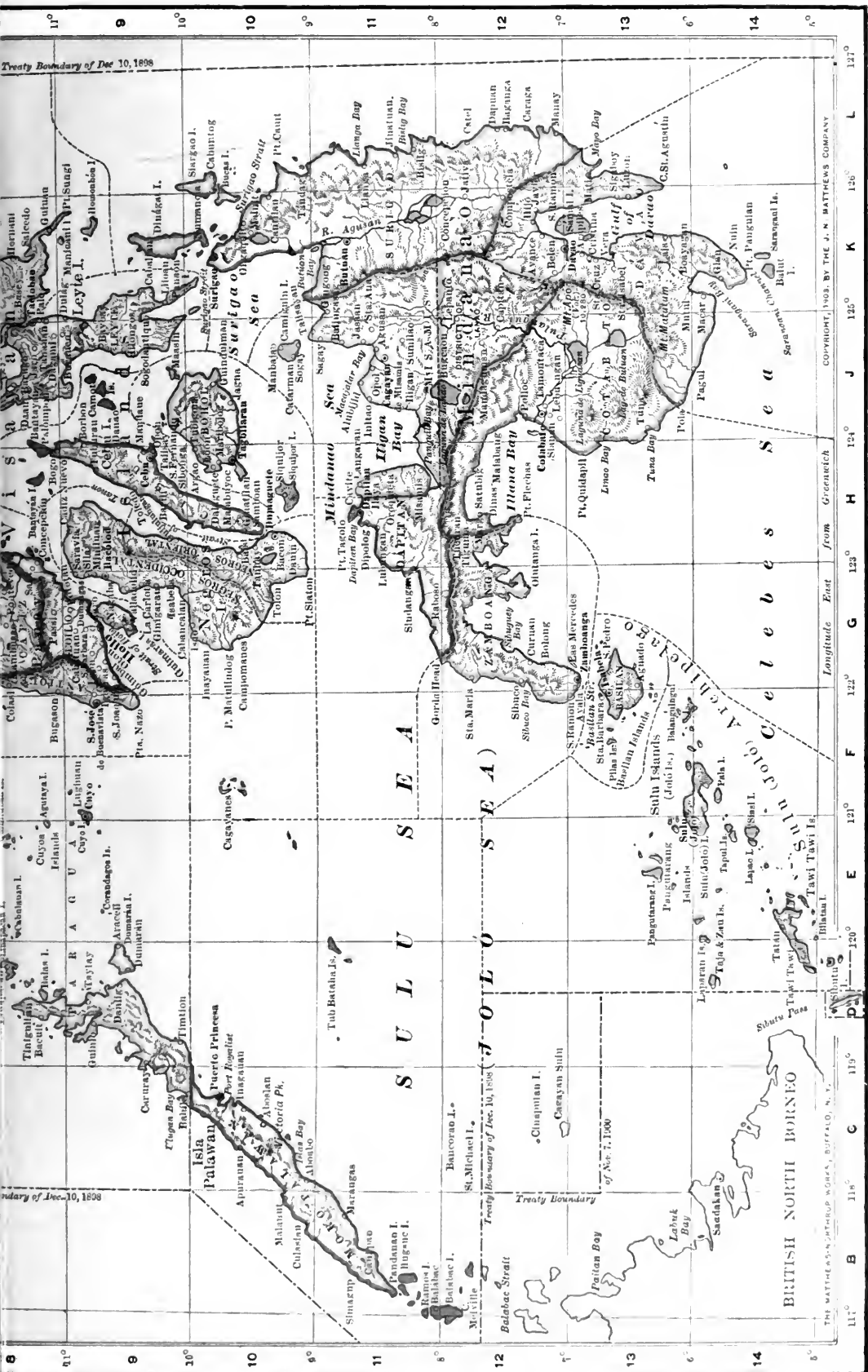

Treaty Boundary of Dec. 10, 1898

Treaty Boundary of Dec. 10, 1898

COPYRIGHT, 1903, BY THE J. N. MATTHEWS COMPANY

THE MATTHEWS-STEPHENSON CO., BUFFALO, N. Y.

BRITISH NORTH BORNEO

Sulu (GOLU) ARCHIPELAGO

S U L U S E A

Sulu Islands

Sulu (GOLU) ARCHIPELAGO

Sulu (GOLU) ARCHIPELAGO

Sulu (GOLU) ARCHIPELAGO

Sulu (GOLU) ARCHIPELAGO

Sulu (GOLU) ARCHIPELAGO

Sulu (GOLU) ARCHIPELAGO

Sulu (GOLU) ARCHIPELAGO

Sulu (GOLU) ARCHIPELAGO

Sulu (GOLU) ARCHIPELAGO

Sulu (GOLU) ARCHIPELAGO

Sulu (GOLU) ARCHIPELAGO

Sulu (GOLU) ARCHIPELAGO

Sulu (GOLU) ARCHIPELAGO

Sulu (GOLU) ARCHIPELAGO

Sulu (GOLU) ARCHIPELAGO

Sulu (GOLU) ARCHIPELAGO

Sulu (GOLU) ARCHIPELAGO

Sulu (GOLU) ARCHIPELAGO

Sulu (GOLU) ARCHIPELAGO

Sulu (GOLU) ARCHIPELAGO

Sulu (GOLU) ARCHIPELAGO

Sulu (GOLU) ARCHIPELAGO

Sulu (GOLU) ARCHIPELAGO

Sulu (GOLU) ARCHIPELAGO

Sulu (GOLU) ARCHIPELAGO

Sulu (GOLU) ARCHIPELAGO

Sulu (GOLU) ARCHIPELAGO

Sulu (GOLU) ARCHIPELAGO

Sulu (GOLU) ARCHIPELAGO

Sulu (GOLU) ARCHIPELAGO

Sulu (GOLU) ARCHIPELAGO

Sulu (GOLU) ARCHIPELAGO

Sulu (GOLU) ARCHIPELAGO

Sulu (GOLU) ARCHIPELAGO

Sulu (GOLU) ARCHIPELAGO

Sulu (GOLU) ARCHIPELAGO

Sulu (GOLU) ARCHIPELAGO

Sulu (GOLU) ARCHIPELAGO

Sulu (GOLU) ARCHIPELAGO

Sulu (GOLU) ARCHIPELAGO

Sulu (GOLU) ARCHIPELAGO

pony, originally from Spain, is an excellent saddle horse, and useful in teams as a carriage horse, but not strong enough for heavy work. The carnivora have no large representatives, and only a small wild cat, two species of civet cats, and the binturong are conspicuous. The islands have nearly 600 species of birds, among which are the jungle fowl, hornbill, fruit pigeon, the snipe, curlew, and other waders; also the species of swift whose nests (edible birds' nests) are highly esteemed in China as an article of food. Marine fish are far more important than fresh-water fish and form the largest part of animal food, the natives also eating many varieties of 'shell fish.' The pearl oyster, yielding a considerable quantity of shell and jewels, is fished in the Sulu Archipelago. Crocodiles and snakes are abundant. Swarms of locusts sometimes devastate the fields, and rice and tobacco have other insect enemies.

GEOLOGY AND MINERAL RESOURCES. The geology of the archipelago has not yet been systematically studied. In broad outline the islands appear to consist of ancient eruptive rocks that have been covered by volcanic outpourings of the Tertiary, Quaternary, and present epochs, and in the lower levels by alluvium. Fossils are not found in the higher altitudes, and deposits of marine fossils are of small extent in recent geological times. There are twenty-three well-known volcanoes, of which eleven are more or less active. The most famous among them, and perhaps the most beautiful volcanic cone in the world, is Mayón, or the volcano of Albay, near the Bay of Legaspi, in Southeastern Luzon. Mayón is 8274 feet in height, and some of its eruptions in the past three centuries have been very serious. The surrounding country has been well-nigh buried under its streams of lava, and its clouds of volcanic dust have been carried through the air as far as the coast of China. Another remarkable volcano is Taal, which is an island in the middle of Lake Bombon, Luzon, with an area of 220 square miles, built up from the bottom of the lake by the outpourings from several craters. The archipelago is a centre of seismic as well as volcanic energy, and the volcanic centres are often the sources of the severest earthquakes. Most of the very violent shocks from which Manila has suffered, for example, have radiated from the Taal centre. For the eighteen years 1880-97 there was an average of 53.4 earthquake days in the year, or 4.5 per month.

The mineral resources are supposed to be very large, but their extent is not yet known. Better transportation facilities and more capital and labor will be required to develop these sources of wealth. True coal has not been found, but the highly carbonized lignite of Tertiary age which takes its place is supposed to be the chief mineral product. It is a fairly satisfactory fuel for steamers, and is widely distributed over the archipelago, especially in Luzon, Mindoro, Masbate, Panay, Samar, Cebú, Negros, and Mindanao. At present it is mined chiefly in Cebú, where as soon as the transportation shall have been perfected the output is expected to be 5000 tons a month. Gold is found in many localities, and has long been mined by natives, employing very rude and wasteful methods. Explorations have proved that the alluvial deposits in many parts of Luzon, Mindanao, and other islands are extensive, and gold-bearing quartz is found among the mountains of Northern Luzon, in Mindanao, and else-

where, some of it being crushed by the natives between heavy stones and the metal extracted by washing. The prospects of gold-mining in Luzon are very favorable. Copper ore is reported from many islands, but the deposits have not yet been worked to any extent. Iron ore is abundant in Luzon, Cebú, Panay, and other islands. Some of the ore of Luzon yields 85 per cent. of pure metal, but thus far the ores are almost unworked except to a small extent in Luzon. Silver occurs in association with lead; sulphur may be obtained in large quantities around some of the volcanoes; and salt, gypsum, and a few other minerals of commerce are found.

AGRICULTURE. Though agriculture is the most important source of wealth, it is in a very backward condition. Farming implements are of the most primitive sort. The cultivator, farm roller, and many other implements were never seen in the Philippines till the United States authorities opened the Government experimental farm. The natives do not understand the use of fertilizers, and know so little about forage crops that all the fodder for the horses and mules in the Government service has been imported. The indolence of the natives has also been unfavorable to large agricultural development. Nearly all the tilled lands are between sea level and 700 feet above the sea. The staple products in order of importance are Manila hemp (abaca), tobacco, sugar, coffee, and rice. Hemp is produced chiefly in the provinces of Luzon south of Manila, in the islands of Samar and Leyte, and on a smaller scale in the other islands north of Mindanao, and on the north coast of Mindanao. The bast, or fibrous outer leaf, yields the coarse, strong fibre which is the best material for sail-cloth and cordage. From the fibre yielded by the inner stalks are woven fabrics that are superior in softness and lightness. These fabrics are seldom exported, but the bast, of which, under the best conditions, 3000 pounds of the acre are produced, is the greatest export commodity, the average yearly shipments amounting to nearly 100,000 long tons. Cotton and ramie fibre are also produced to some extent, but cotton has declined, owing to the increased use of foreign textiles. Tobacco is of excellent quality, though it does not equal the favorite grades of the Cuban crop. The best leaf is grown on the wide plain of the Rio Cagayan (Isabela and Cagayan provinces), North Luzon. This favored tobacco region supplies most of the leaf sent to foreign lands or manufactured in Manila. The inferior, though good, tobacco grown in the more southern islands is chiefly consumed at home, but the leaf of North Luzon is famous throughout Southeastern Asia and many Western countries. Sugar-cane, grown in all the islands, is of great importance, and though it is cultivated with little intelligence, and raw sugar is produced by the crudest methods, its value for export is second only to that of hemp. The coffee of Luzon and Mindanao is of excellent quality, comparing favorably with Java, but the crop has declined on account of insect enemies. Rice is grown everywhere, and is the great food staple of the common people. It was formerly exported to China, but for years the supply has been short of the home demand, and large quantities are imported from Cochin-China. Maize thrives throughout the archipelago and is grown especially on land that is not fitted for rice. While its use as food is

increasing, many natives do not eat it. Among other products are cocoanuts, cocoa, wheat, indigo, sesame, peanuts, many varieties of vegetables, and spices in the south. Large quantities of copra, the dried meat of the coconut, are prepared for export. The pastoral industries are extensive. Some of the islands, as Masbate, have comparatively little tilled ground and depend more largely upon live stock. It is estimated that Masbate has 10,000 carabaos, 55,000 cattle, and 5000 horses. Cattle of a small humped variety are raised for beef on several islands. Swine and fowls are found in every native settlement. The Government experimental farm near Manila is for the purpose of encouraging the production of crops. Experiments with alfalfa and other forage plants have been very successful, and most of the vegetables grown in the United States, excepting melons and white potatoes, yield well. The Government distributes seeds and is giving special attention to coffee-growing. Very little land is owned by the peasantry, who rent their small holdings, paying half the crop to the owners. About 500,000 acres of the best tillable lands are owned by three of the Roman Catholic societies which do not encourage thrifty farming; it is likely that their lands will be purchased by the Government and sold to the tenants. The settlement of the land question is of the highest importance, as it is impossible in most cases to give a safe title to lands.

MANUFACTURES. The most important manufactures are the products of the tobacco works. The largest tobacco factory in Manila has over 10,000 employees. Most of the natives smoke home-made cigars, and over 150,000,000 cigars are annually exported. The leaf is cured and manufactured by means of modern machinery, many of the cigarette machines are worked by steam, and Manila is the chief centre of all tobacco products. Fabrics of Manila hemp, wool, cotton, silk, and piña fibre are woven on hand looms; and bamboo, rattan, palm leaves, and other material are used with intelligence and skill in making mats, hats, bags, cigar cases, and a large variety of other articles. Rope, soap, leather, sugar, and some other commodities are made by antiquated and imperfect processes, but much skill has been developed in erecting the better class of buildings, and in making furniture and wood carvings.

COMMERCE. Trade relations with foreign countries have grown rapidly since law and order were restored throughout most of the islands about the beginning of 1900, as the following table, giving the value of exports and imports, shows:

	1900	1901	1902
Exports.....	\$19,751,068	\$23,214,948	\$29,000,000
Imports.....	20,601,436	30,279,406	33,342,166

The large increase in the trade between the Philippines and the United States is shown by the following table:

	1898	1899
Exports to the United States.....	\$3,829,003	\$4,409,774
Imports from the United States....	127,804	404,171

	1900	1901	1902
Exports to the United States.....	\$5,971,208	\$4,420,912	\$6,612,700
Imports from the United States.....	2,635,624	4,014,180	5,251,867

The trade in 1901 with the other countries that are most important in Philippine commerce is indicated in this table:

	United Kingdom	Hong Kong	British East Indies
Imports from.....	\$6,956,145	\$3,529,322	\$2,820,797
Exports to.....	10,704,741	5,067,547	1,314,084

	Spain	France	French East Indies
Imports from.....	\$2,166,866	\$1,684,233	\$1,914,238
Exports to.....	1,656,400	1,934,256	1,483

The exports consist very largely of agricultural products. Manila hemp and sugar, the leading staples of the islands, are the principal factors in the trade, their combined value usually amounting to more than 75 per cent. of the total export valuation. In 1900 the value of the principal exports was: Manila hemp, \$13,290,400; sugar, \$2,397,144 (smaller than usual); copra and cocoanuts, \$3,184,853 (unusually large); cigars and cigarettes, \$1,164,369; leaf tobacco, \$1,033,900; hides and skins, \$311,183. The exports were classified as: Products of agriculture, 87 per cent.; manufactures, 7 per cent.; miscellaneous, 6 per cent.

The imports are chiefly manufactured articles, cotton goods usually forming one-third to nearly one-half of the total, and foodstuffs. Rice is the most important of the agricultural imports. The value of the chief imports in 1900 was: Cotton manufactures, \$8,727,777; rice, \$4,365,056; iron and steel articles, \$1,425,233; wheat flour, \$475,236; malt liquors and cider, \$1,113,684; mineral oils, \$374,717; silk manufactures, \$385,984; glass and glassware, \$395,620.

Manila hemp is almost the only article imported into the United States, the value of the fibre brought to this country in 1902 amounting to \$6,318,470.

Great Britain leads in the foreign trade with the Philippines, chiefly on account of its large purchases of Manila hemp and its surpassing sales of cotton cloth. The United States supplies more foodstuffs, excepting rice, which comes from Cochin-China, than any other country; and its sales of iron manufactures to the islands in 1902 amounted to \$957,342. In the same year the imported foodstuffs amounted to over \$14,000,000, or about two-fifths of the total imports.

TRANSPORTATION AND COMMUNICATION. The three leading ports of the islands are Manila, Cebu, and Iloilo. The situation of Manila (q.v.) gives it superior advantages in the domestic and foreign trade of the islands. Vessels, however, having a draught of more than sixteen feet are compelled to anchor two miles from the shore, and are dependent upon lighterage for loading and unloading cargoes. The Government intends to dredge an inshore harbor and protect it by breakwaters, so that the largest vessels may tie up at the docks. Cebu and Iloilo are the chief ports of the islands of Cebu and Panay, respectively, in the Visayan or great central group of islands between Luzon and Mindanao. There are also three ports of secondary importance: Aparri, on the north coast of Luzon, a large centre of tobacco shipments; Zamboanga, the leading port of Mindanao; and Jolo, the chief port of the Sulu Archipelago, in the south. Custom houses are maintained at these six ports, and

FISHES OF THE PHILIPPINES

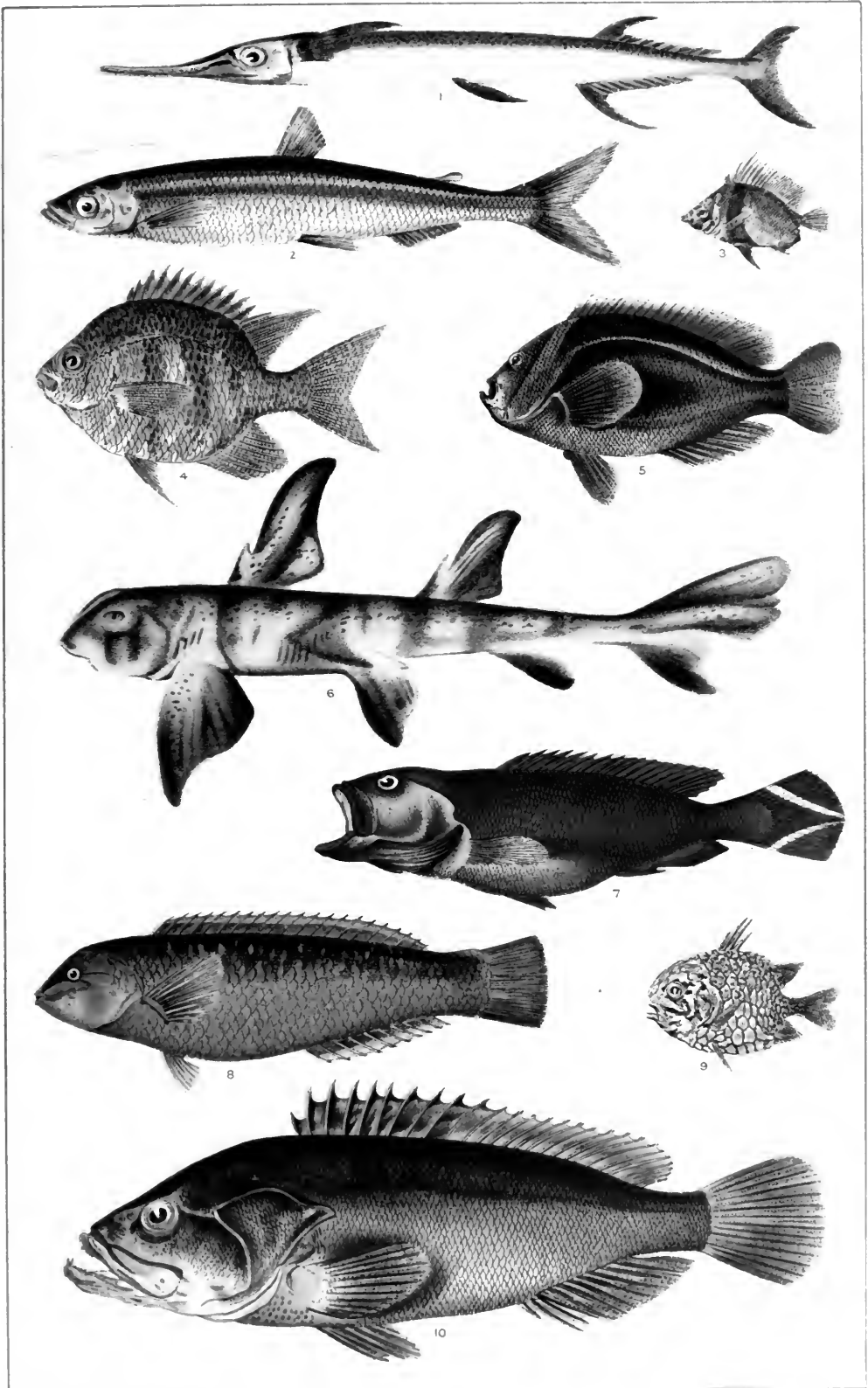

COPYRIGHT, 1902, BY DODD, MEAD & COMPANY

THE SCIENCE PHOTOGRAPHIC CO. LITH. N.Y.

1 GREAT GAR - (BELONE GIGANTEA)

2 SMELT - (OSMERUS JAPONICUS)

3 FLAG-FISH - (HENIOCHUS MACROLEPIDOTUS)

4 A DEMOISELLE - (GLYPHIDODON SMARAGDINUS)

5 AMPHIPNION FRENATUS

6 PORT JACKSON SHARK - (CESTRACION PHILIPPI)

7 A GROUPEE - (SERRANUS URODELUS)

8 FOUR-COLORED WRASSE - (JULIS QUADRICOLOR)

9 CONE-FISH - (MONOCENTRIS JAPONICUS)

10 A SEA-BASS - (SERRANUS MARGINALIS)



they are open to foreign trade. In addition to these ports there are a large number of local ports whose business is confined to the coastwise trade. Many of them are connected directly by small steam and sailing vessels with the ports engaged in the foreign trade. As the islands lack railroads and have very few roads of any description, they are dependent upon this large coasting trade for the distribution of their domestic commerce or for the dispatch to or receipt from foreign countries of articles in the foreign trade. Thus the leading ports are the forwarding and distributing points for the entire over-sea commerce. There are, for example, about thirty local ports at which the Manila hemp crop is collected for shipment to Manila, Iloilo, and Cebu, where it is transferred to vessels in the foreign trade. The freight rates on these coasting lines are high.

All the ports are reached from the interior by small rivers, or by bad cart roads or footpaths. These paths and trails extend from the ports in all directions, but are very inadequate, and commerce is hampered by the poor inland communica-

BANKING. There are three general banking corporations in the islands. The Banco Español-Filipino, at Manila, with a branch at Iloilo, monopolizes the bank-note circulation of the Philippines, amounting to 2,407,560 pesos (a peso = 50 cents). Its capital is 1,500,000 pesos. The Hong Kong and Shanghai Banking Corporation has branches at Manila and Iloilo, and the Chartered Bank of India, Australia, and China at Manila and Cebu. The aggregate liabilities of all these establishments on December 31, 1901, was 53,415,809 pesos, including deposits of 35,012,127 pesos. The Savings Bank and Pawn Shop of Manila, capitalized at 221,460 pesos, had in January, 1902, deposits amounting to 755,829 pesos and total resources of 1,096,597 pesos.

FINANCE. The central government is supported chiefly by import and export duties. The provincial and municipal governments derive their support from internal taxes. The revenues and expenditures in the archipelago from the date of the American occupation, August 20, 1898, to the end of the fiscal year, June 30, 1901, were as follows:

REVENUES	1899	1900	1901	Total
Customs.....	\$3,097,864	\$5,535,952	\$9,032,600	\$17,666,417
Postal.....	42,954	104,282	121,559	268,796
Internal.....	240,378	522,509	932,484	1,695,372
Miscellaneous.....	130,131	361,195	591,017	1,082,344
Total.....	\$3,511,327	\$6,523,938	\$10,677,660	\$20,712,929
EXPENDITURES				
Customs.....	\$29,177	\$134,685	\$280,815	\$444,678
Postal.....	30,410	89,149	147,031	266,591
Other expenditures.....	2,337,810	4,994,545	6,335,975	13,668,331
Total.....	\$2,397,397	\$5,218,379	\$6,763,821	\$14,379,600

tions. The only railroad extends from Manila north to Dagupan, on Lingayen Bay, 120 miles. It is estimated that the islands require at least 1000 miles of railroad as a factor in their development.

The islands are fairly well supplied, through the three leading ports, with transportation to foreign lands. They have direct steam communications with all the leading ports of South Asia, Australia, San Francisco, and Barcelona, Spain. A large amount of the freight, however, is transhipped at Hong Kong and other Asian points, where it meets the steamships of the regular lines in the European and American trade. In 1901, 789 British, German, Chinese, and other foreign vessels entered the ports of Manila, Iloilo, and Cebu. Very little of the trade even with the United States is carried in vessels flying the American flag. In 1902 about 94 per cent. of American sales to the Philippines and 99 per cent. of American purchases were carried in foreign bottoms. Since August, 1898, the Signal Corps of the United States Army has laid 1327 miles of cables between the islands and 5000 miles of permanent telegraph lines, so that most parts of the archipelago have now the means of rapid communication with one another. In 1903 direct electrical communication with the United States was opened by means of a Pacific cable between the east coast of Luzon and San Francisco by way of Guam, Midway Island, and Honolulu. Manila is also connected by cable with Hong Kong and the European system.

One-half of the internal revenue receipts in each province is turned over to the provincial treasury, and the remaining one-half to the municipalities of the province. A poll tax of \$1 Mexican is levied upon each male person between eighteen and fifty-five years of age, one-half being paid into the treasury of the town where he lives and the remainder into the provincial treasury. The municipal council may license saloons and other business requiring police supervision. An ad valorem land tax is collected for the benefit of the provincial and municipal governments, the provincial board levying one-eighth of 1 per cent. on the assessable land for roads and bridges, and may levy two-eighths more for general purposes. The municipal council is required to levy one-fourth of 1 per cent. for schools, and may levy one-fourth per cent. more for general purposes.

WEIGHTS, MEASURES, AND MONEY. The coinage in use comprises the Mexican silver dollar, and silver peso and fractional currency coined at the Manila mint, which was established in 1902. A large amount of pesos coined at the Philadelphia mint are sent to the Philippines in 1903. The Philippines silver coins are legal tender to the amount of \$10. Two pesos are exchanged for \$1 of United States money, and a ratio of 2 to 1 is maintained between Mexican dollars and United States gold. The metrical system of weights and measures is officially in use, but the Spanish denominations are also employed.

POPULATION. A census of the Philippines was

in progress when the insurrection began in 1896, and the American authorities found returns for over two-fifths of the population stored in Manila. The returns were made the basis for the estimate of the population in the twelfth census of the United States, where it is given as 6,961,339. A later Government estimate is 6,975,073, with 1137 towns, the population being divided among the island groups as follows:

GROUPS	Area sq. miles	Popula- tion	Towns
Luzon.....	44,235	3,727,488	570
Marinduque.....	681	48,000	6
Mindanao.....	46,721	495,659	130
Mindoro.....	4,108	106,200	19
Pulawan.....	5,037	52,350	14
Sulu Archipelago.....	1,029	22,630	14
Visayan Islands.....	25,302	2,497,908	381
Unassigned.....	740	24,838	3
Total.....	127,853	6,975,073	1,137

With the exception of Manila, the capital, which has a population of 350,000, there are no cities in the archipelago with more than 40,000 inhabitants, though there are about 30 towns with populations between 20,000 and 40,000. The most important of these are Albay, Batangas, Bauan, Laoag, Lipa, and Taal in Luzon, Cebu in the Visayas, and Zamboanga in Mindanao.

EDUCATION. There is considerable controversy as to the exact status and results of the system of education in operation before the American occupation. It is contended, on one hand, that the provisions for primary and secondary education were largely neglected, the tendency being to centre efforts upon the few who were sent to the college or university. It is accordingly asserted that comparatively few persons stood out prominently as educated Filipinos, while the great mass were either wholly illiterate or could barely read and write. Other authorities maintain that the Spanish system, considering the conditions which existed, achieved fair results. The report of the United States Commissioner of Education states that "the public elementary school system required by the Spanish law, whatever its defects, was widely diffused over the archipelago when the Americans arrived." In some places the average of those who could read and write was high, in others low—a diversity due to local conditions. Higher education was well provided for, and presented many admirable features. Since September 1, 1900, the civil administration has put in force an educational bill designed to provide wider instruction for the masses as well as the more prosperous class. The archipelago has been divided into seventeen educational divisions, with an American superintendent over each division. Up to 1903 about 1000 American teachers had been distributed for primary work in the towns; 200 American teachers for secondary work were also assigned to duty; 200 soldier-teachers were detailed from their regiments; and 3400 Filipino teachers were also appointed. Instruction in the English language was provided in 1500 schools, in which more than 200,000 children were enrolled. Night schools were opened in various parts of the archipelago, with an enrollment of about 25,000 pupils. Grammar and high schools are a part of the system. Permanent normal schools and vacation normal courses for the training of Filipino teach-

ers were organized. In 1903 plans were under discussion for increasing the number of trade schools and establishing schools of painting, sculpture, drawing, and music, and also a university at Manila. The aim of the common schools is in part to fit the Filipinos for practical work and to make a feature of agricultural and industrial training.

RELIGION. Under the treaty of peace of December 10, 1898, religious freedom is guaranteed to all. The people of the islands are largely Roman Catholic, though there are moon-worshippers, Mohammedans, Buddhists, etc. The Moros, living in the south, and the pagan wild tribes of the mountains, are the leading non-Christian classes. As shown by the Church registry in 1898, 6,559,998 Roman Catholics were distributed among 746 regular parishes, 105 mission parishes, and 116 missions. Most of the parishes are administered by Spanish friars of the Dominican, Franciscan, and Augustinian Orders, assisted by many native priests in the small parishes and missions, though since the American occupation several priests from the United States have been appointed to bishoprics. Controversy exists here also in regard to the attitude of the native population toward the friars. Some assert that they are obnoxious to a large part of the people, owing to the onerous contributions they are said to have levied for the support of the Church, and the large areas of tillable land they acquired, much of it, it is asserted, by dispossessing the owners on the pretext of exacting the Church's dues. The apologists of the friars, on the other hand, vigorously assert that their unpopularity is only with a faction of the natives, and springs largely from political motives. They call attention to the fact that a counter-movement of popular origin and considerable proportions has taken place in favor of the friars. When Spanish sovereignty ceased, many members of the Orders retired to Spain, and the policy of acquiring their lands and delegating their lands to other officials of the Church has been advocated in reports of the Philippine Commission.

GOVERNMENT. For a time after the transfer of the Philippines to American control, the islands were held under military government subject to the orders of the President of the United States. In January, 1899, a commission was appointed by the President to investigate conditions in the Philippines. (See below under HISTORY.) In February, 1900, the provisional government of the islands was intrusted to a new board of civil commissioners, five in number, at the head of which was Judge William H. Taft of Ohio. The other members were D. C. Worcester, Luke E. Wright, Henry C. Ide, and Bernard Moses. The commission reorganized the local civil governments and in January, 1901, established a municipal code for the government of cities other than Manila and tribal settlements. An electoral system making the qualifications for suffrage the ownership of property, payment of certain taxes, or a knowledge of English or Spanish was also created. A constitution for the government of the provinces enacted by the commission provided that their officials should be a governor elected by the municipalities subject to the approval of the commission, and a secretary, a treasurer, a commissioner of public works, and a public prosecutor, all appointed by

PHILIPPINE ISLANDS



STREET SCENES IN THE PHILIPPINE ISLANDS
1. MALASIQUI 2. SAN CARLOS

the commission. From time to time the commission instituted civil governments in the localities as circumstances required, until in 1903 more than 700 localities had local governments suited to their conditions. In June, 1901, the civil and military administration of the islands were separated by the appointment of Judge Taft as civil governor, thereby relieving the military governor of his civil duties in the pacified provinces. Shortly thereafter the commission was increased from 5 to 8 by the addition of three natives and was reorganized so as to place each member at the head of an administrative department. By an act of the commission dated June 11, 1901, the judicial system was reorganized. A Supreme Court was created to consist of seven justices, four American and three native; and sixteen Courts of First Instance, over which natives presided, were established. A considerable portion of the minor criminal jurisdiction was transferred to justices of the peace. A new code of civil procedure, authorizing the use of either English or Spanish in judicial proceedings, went into effect September 1, 1901. The city of Manila, the capital, is governed by a board of three commissioners somewhat after the manner in which the city of Washington is governed. In addition to the above measures the present constitution of government for the Philippines consists of the order of April 7, 1900, creating the Philippine Commission and defining its powers; that of June 21, 1901, creating the offices of Governor and Vice-Governor; an act of the Philippine Commission of September 6, 1901, organizing the departments of the interior, of commerce and police, of finance and justice, and of public instruction; and the important act of July 1, 1902, for the temporary government of the Philippines, which continued the government established under the above-mentioned orders and acts.

The act of July 1, 1902, defined the citizenship of the Philippines as including all the inhabitants of the islands who were citizens of Spain at the date of the ratification of the treaty with Spain, February 6, 1899, and declared that as such they should be entitled to the protection of the United States. The substance of the bill of rights of the Federal Constitution, except the right of maintaining a militia and the right of trial by jury, was extended to the Philippines. The act directed the President of the United States to have a census of the islands taken, and within two years thereafter, if peace prevailed in the islands, a legislative assembly should be called into existence. This body is to consist of two chambers, the Philippine Commission constituting the upper one, while the Lower House is to consist of from fifty to one hundred popularly elected delegates apportioned among the provinces on the basis of population, except that each province shall be entitled to at least one member. Persons qualified to vote for delegates include those who have held office under the Spanish régime or who own property of the value of \$250 or pay taxes amounting to \$15 or over, or who speak, read, and write Spanish or English. Two resident commissioners to the United States are to be chosen by the Legislature, and both commissioners and delegates are to be chosen biennially. The Legislature is to hold annual sessions; but if at any session the Legislature refuses to vote the necessary supplies for the support of the Government, the executive

may appropriate sums equal to the amount last appropriated.

The Supreme Court, the Courts of First Instance, and the Municipal Courts as established by order of the Philippine Commission June 11, 1901, are continued. The United States Supreme Court is given appellate jurisdiction over all judgments of the Philippine Supreme Court in cases involving more than \$25,000, or whenever the Constitution, the laws, or any right or title claimed under the authority of the United States is drawn in question. The Governor, Vice-Governor, members of the Philippine Commission, heads of executive departments, and the justices of the Insular Supreme Court are to be appointed by the President of the United States, with the advice and consent of the Senate. Congress reserves the power to annul all laws passed by the Philippine Legislature, and the Philippine Commission is directed to make annual reports of all receipts and expenditures to the Secretary of War. The Division of Insular Affairs instituted by the War Department is continued as the Bureau of Insular Affairs, and to this bureau are committed all matters pertaining to civil government in the insular possessions of the United States subject to the jurisdiction of the War Department. By a proclamation of July 4, 1902, the President of the United States declared the Philippine insurrection at an end everywhere except in the Moro territory and abolished the office of military governor, his authority in civil matters being superseded by that of the Philippine Commission.

ETHNOLOGY AND CUSTOMS. The inhabitants are unequally divided between blacks, browns, yellows, and whites, and there is also a slight representation of reds. The blacks comprise native tribes, with descendants of African negroes and Papuans introduced by Spaniards. The native blacks are of Negrito type, commonly called Aeta, from a principal tribe: they are dwarfish in stature, and dwell in remote parts of the archipelago. They are usually regarded as the aborigines, and as remnants of a pigmy race; some students consider them degraded Papuans. There are only twenty thousand of them. The brown race, either pure or mixed, constitutes nine-tenths of the population. A fraction are related to the Polynesians; yet the distinctness of this type is problematical, and the ethnologist finds his surest identities in the vast numbers of Malay peoples in the islands. The first immigrants were uncultured savages, whose descendants are now represented in the interior and the outskirts of the islands by living tribes. These were followed by incursions in historic times of Malay peoples having alphabets and a primitive culture. About B.C. 200 came the ancestors of many head-hunting tribes. The immigration of the Tagal, Visaya, Nicol, Ilocano, and other industrial tribes is assigned to A.D. 100-500. Third and last came the Islamic or Moro invasion, occurring in the fourteenth and fifteenth centuries of our era, and brought to an end by Spanish conquest in the sixteenth century. At present the brown Malay is mixing with white and yellow peoples. The yellow or Mongoloid type exists in the Philippines partly as pure-blooded Chinese, Japanese, Siamese, and Cambodians, but principally in mixtures of various sorts. The Chinese held sway in Luzon for centuries, and after their rule was thrown off trade continued between them and the natives.

It is improbable that these immigrations and blendings were numerous prior to the founding of Manila (1571) and the coming of Mexican and Peruvian silver in trade. So vigorous was the Chinese invasion afterwards that it threatened to overthrow the Spanish rule, while it resulted in the creation of a large mestizo population. The red or American race found its way into the islands on the Spanish ships sailing annually between Acapulco and Manila in the sixteenth, seventeenth, and eighteenth centuries. It was not so much a migration of peoples as of arts. There are evidences of small settlements of Mexican Indians in and about Luzon, and the civilized portions of the archipelago were enriched by maize, pineapples, tobacco, cacti, agaves, and the varied industries associated with them. The white race, in all its important elements, Hamitic, Semitic, and Aryan, was permanently mingled with the brown during the 250 years of Spanish domination. In Northern Luzon and in the mountainous and central portions of other islands the native blood has not been changed, but elsewhere the term 'pure-blood' has little meaning. This blending has been most rapid in the Tagal, Vicol, and Visaya tribes, which constitute the largest fraction of the population.

The Negritos are small in stature, with closely curled hair, yellow sclerotic coat, and white teeth, which they file. They are among the shortest of mankind, the average stature being 1.47 meters (58 inches). Their cranial capacity is 1100 to 1200 cubic centimeters, and their cranial index 85. The Malay or brown Filipinos are of dark chocolate color and average 1.50 meters (59 inches) in stature. Some are meagre in body, but most of them are sturdy.

Culture among the Filipinos extends from the low savagery of the Negrito tribes to a form of civilization fairly comparable with that of the countries on the continent adjacent. The industrial life of the Filipinos is partly agricultural and mechanical, partly maritime. The outrigger canoe is in evidence about all the islands. Clothing is little needed as a defense against cold, but the need of protection from the sun's rays and the rain has quickened inventive faculty in devising a style of headgear which combines the functions of hat and umbrella, varying from island to island, with a rain cloak, also varying in form and material. The dwellings are made of bamboo, rattan, and palm leaves. The original fire-making device was the fire-saw, consisting of a section of bamboo stem, notched and laid on the ground and rubbed crosswise by another piece in shape like a knife; the bamboo fire syringe is also common.

Industrially the Filipinos are in the Iron Age. They have little machinery. All their tools are of the rudest sort, and are either Malay or Spanish. Many of them, especially the Moro tribes, work cleverly in metals, but do little at mining or reduction of ores. Their most elaborate work is done on the blades of edged weapons. Pottery is made by the brown peoples for domestic purposes; working in hard woods is a fine art, and in textiles the Filipinos excel. They split the bamboo and rattan into delicate filaments for hats and screens; make thread, twine, and rope of the native hemp; ornament their clothing and furniture with delicate vines and grasses; and weave the finest of cloth from the fibre of the pineapple. These fabrics are plaited by hand or

wrought on looms, but it is difficult to tell which processes are Malayan and which came through Hispano-Mexican influences. The more advanced tribes rear a variety of small horse that is tough and serviceable; but the chief domestic animal is the carabao or water buffalo, which is largely used for turning water wheels for irrigation and as a draught-animal for plowing or hauling. Native transportation was originally by means of the buffalo, and rude water craft. Even before the coming of the Spaniards, the Chinese and the Japanese carried on a brisk trade with Manila and introduced their vehicles and money. During the 250 years of Spanish domination the 'groaning cart' and old-style water craft partly took the place of native devices.

The Negrito weapons of war and the chase are the bow with string of bamboo, and arrows with heads of wood or of iron procured in trade. The brown peoples have inherited from their ancestors edged weapons set on a hilt or a shaft. They carry also wooden shields, decorated with patterns cut in and rubbed with lime wash or mud. Firearms of many patterns are to be found. Fortification of the village is effected by path splinters and spiked pitfalls.

Fine art among the Filipinos had no separate existence, but the possession of a strong artistic sense is revealed by the taste displayed in their industries. Even the Negritos are not devoid of it. The dress of men and women; the metal working of the men, especially on their weapons; the exquisite textile work of the women—all show artistic instinct. Under the influence of Spanish teaching and the inspiration of European and Christian motifs, some of the native Filipinos have attained distinction in painting and literature.

The principal tribes and languages are: Abaca, Abra-Igorrote, Abulone, Adang, Aeta, Agutaino, Altaban, Apayao, Aripa, Atá, Bagobo, Baluga, Bangot, Barangan, Batak, Batane, Bicol, or Vicol, Bilane or Vilane, Bisaya or Visaya, Bouayanano, Buhano, Bulalacano, Bukidno, Bukil, Buquitnon, Cagayan, Calangan, Calamian, Calaua, Calinga, Caraga, Carolano, Catalangan, Catubangan, Cimarron, Coyuvo, Culáman, Dadayag, Dulangan, Dumagate, Durugmun, Eta, Gaddane, Gamungan, Guianga, Guimbahano, Guinaane, Halaya, Hiliguayna, Hilloona, Ibalone, Ibanag, Ibilao, Ifugao, Igorrote, Ilamut, Ilanos, Ilocanos, Ilongote, Iraya, Isinay, Ita, Itaa, Italone, Itanega, Itetapane, Kiangane, Lutanga, Lutayo, Maguindanao, Malauec, Malanao, Mamánua, Mandaya, Manguanga, Manguiane, Manobo, Mayoyao, Moro, Mundo, Nabayugan, Negrito, Palauan, Pampango, Pangasinan, Quiangan, Sámale, Sameaca, Sangley, Sanguile, Silipan, Subano, Tagabaloye, Tagabawa, Tagabelie, Tagacaolo, Tagala, Tagbanaua, Tandelano, Tinguan, Tinitian, Tino, Tiruray, Vico (Bicol), Vilane, Visaya (Bisaya), Zambale. Some of these names are also applied to localities, in which case the people may be called after the place, which is rare, or they may have given designation to the place, which is common. The tribes and languages are defined in their several places.

HISTORY.

In accordance with the terms of the Demarcation Bull of Pope Alexander VI. of May 4, 1493, the Spaniards were to make discoveries and to establish colonies beyond a meridian line in the Atlantic 100 leagues west of the Azores (later by

the Treaty of Tordesillas, June 7, 1494, 370 leagues west of the Cape Verde Islands), while the Portuguese were to confine their efforts to the field of discovery east of that line. In the race for the control of the spice trade of the East Indies the Portuguese came off victorious, for they reached the Moluccas or Spice Islands the year before Balboa discovered the Pacific Ocean, revealing that the Spaniards had found, not the Indies, but a great barrier continent that blocked the way thither.

The Moluccas lay so far to the east of India as to make it probable that if the demarcation line were extended round the earth they would be found to be in the Spanish half of the globe. It was to demonstrate this hypothesis and carry to completion the great design of Columbus to find a western route to the Spice Islands that Magellan undertook his voyage around America and across the Pacific. In March, 1521, he discovered a group of islands which he named after Saint Lazarus, whose festival was celebrated early in his stay among them. A few weeks later the heroic navigator lost his life in a skirmish with the natives. That he had achieved his project and proved that the Spice Islands lay within the Spanish half of the world was accepted by King Charles of Spain, but the impossibility of accurately determining longitude in those days, the difficulties of the voyage through the Straits of Magellan and across the Pacific, and financial necessities led him to relinquish all claims to sail or trade west of a new demarcation line, in the Antipodes, 297 leagues east of the Moluccas. (Treaty of Saragossa, 1529.) This really surrendered all rights to the newly discovered Islands of Saint Lazarus, which were slightly to the west of the Moluccas. The conquest of Mexico and the establishment there of the prosperous Viceroyalty of New Spain removed the difficulties presented by the navigation of the Straits of Magellan, and, in contravention of the provisions of the treaty, an expedition was dispatched to the islands in 1542 under the command of Villalobos. This expedition had no permanent result beyond giving to the group the name of 'Islas Felipinas,' in honor of the Prince, later King Philip II. The permanent conquest of the islands was achieved under Legaspi at the head of an expedition fitted out in Mexico. Legaspi arrived at Cebú in April, 1565. It was three years before his first reinforcements came, and five years before the conquest of Luzon was undertaken. In June, 1571, the city of Manila was founded, and this became the seat of the Spanish power. Within the next year great progress was made and at the time of Legaspi's death in August, 1572, the Spanish authority was securely planted in the islands and the conversion of the natives considerably advanced. Legaspi's force was small and the conquest was accompanied by relatively little bloodshed. The lack of social and political cohesion among the natives, the weakness of their religious beliefs, and the rivalries and hostility of the local chieftains opened the way for a patient and tactful prosecution of the policy of divide and rule; one chief after another was won over to the Spaniards, the picturesque ceremonials of the Church appealed to the artistic sense of the people, and the simple clan-like social organization was skillfully utilized by the Spaniards as the basis of their rule. Lying on the extreme verge of the vast empire of Spain, the islands

were commonly known as the Western Islands (Islas del Poniente), and until December 31, 1844, they were reckoned, so far as the calendar was concerned, in the Western Hemisphere, Manila time being about sixteen hours slower than Madrid time. The Portuguese protested against this invasion of their East Indian realm, but the conquest of Portugal by Spain in 1580 settled the question before there had been any serious collision. More formidable than the hostility of Portugal or the resistance of the natives were the incursions of Chinese pirates and later the attacks by the Dutch, who during their great contest with Spain made their way to the Indian seas and took possession of the Spice Islands.

The dominating impulse in this remote extension of Spanish power had been religious rather than commercial. The new conquest was to be an outpost of Christianity facing the great Asiatic heathen world. From it as a base the missionaries could prosecute their labors effectively in China and Japan. Religious purposes and interests continued to dominate the life of the islands for over three centuries. They never were in the true sense of the term a Spanish colony, but a great mission like the more familiar Jesuit missions in Paraguay and California. It is as a mission that the history of Spanish rule should be studied and its results estimated. To convert the natives, to collect them in villages where they would live under the oversight of the pastor with the faithful obedience of the flock to the shepherd and prepare themselves for salvation, was the simple ideal of the mission. That it was in a large measure achieved is the very general testimony of fairly dispassionate observers. The Christian population steadily increased, and the requirements of religion, while rigorously enforced, were not more burdensome than in Europe. There was little real oppression and hardly any exploitation of the people. Plantation slavery, the dark page in West Indian colonization, never existed. Schools were provided in the pueblos and in the larger towns hospitals and colleges; the native languages were given literary form, grammars and dictionaries were compiled and translations made of the simpler literature of the devotional life. The Christian population of the islands formed a unique community, the only large body of Asiatics permanently converted to Christianity in modern times. In its general framework the administration of the islands as a Spanish dependency was modeled on the system introduced into America, which in turn was an adaptation of that existing in the provinces of Spain. At the head was the Governor with viceregal powers, having by his side the Audiencia or Supreme Court. This body served not only as the highest court of appeal, but also as a check upon the arbitrary authority of the Governor. Another important restraint upon that official was the *residencia*, or obligation to stand ready to answer all charges of misbehavior which should be preferred during a period of six months, after the termination of his tenure of office. The heads of the provincial administration were the *Alcaldes Mayores*, whose functions were both executive and judicial. In his judicial duties the Alcalde Mayor was assisted by an assessor and a notary. The administrative division below the province was the pueblo or village, which was ruled by the Petty Governor, who was origi-

nally elected by the general suffrage of the married inhabitants of the pueblo, but in later years was chosen by a small body of thirteen electors. Within the pueblos the population was subdivided into little clan-like groups of forty or fifty families called *barangays*, a survival of the earlier native organization, each under a *barangay* headman (*cabeza de barangay*). Each family was assessed a tribute of 10 reals, about \$1.25, and the headmen were responsible for its collection. The petty governors and headmen of *barangays* were Filipinos; the higher administrative officers were Spaniards. The inhabitants of these pueblos were all natives. No Spaniards were allowed to live in these mission villages except the friars, who exercised there the firm but ordinarily gentle sway of the parent or schoolmaster. In the few Spanish towns there existed the ordinary municipal organizations that prevailed in Spanish America. There was the town corporation 'el Cabildo' (chapter), consisting of two *alcaldes* (justices), eight *regidores* (aldermen), a registrar, and a constable. The members of the Cabildo held office permanently. Membership could be bought and sold or inherited.

At the head of the ecclesiastical administration stood the Archbishop of Manila, the Bishops of Cebú, Segovia, and Cáceres, and the Provincials of the four great Orders of friars (the Dominicans, Augustinians, Franciscans, and barefooted Franciscans), and of the Jesuits. The members of these Orders (the regular clergy) greatly preponderated in numbers and influence over the secular clergy, who were mostly natives.

The economic development of the islands was rendered impossible by the manufacturers in Spain, who demanded protection against Asiatic competition in the markets of Mexico and Peru, and secured the restriction of the imports from the Philippines to the cargo of an annual ship. Under this handicap the islands never were a self-supporting, much less an income-yielding, dependency. They were always a burden upon the treasury of New Spain. Their principal trade was with China and was in the hands of the Chinese. The vast majority of the pueblos were simple self-supporting communities of farmers and small artisans.

Secluded from the outside world, the domestic history of the Philippines is distinctively parochial in its character. There is little progressive political or economic evolution from generation to generation. Progress is manifested by the extension of the missions and the amelioration of the life of the natives. Much of the internal history is made up of the various conflicts between the clergy and the political administration or between the Archbishop and the friars. The chief incidents in external history are the volcanic eruptions, the incursions of the Chinese or Moro pirates, the attacks of the Dutch, etc. The events of the great Seven Years' War rudely interrupted this placid life. Spain, drawn into the maelstrom of this conflict in the vain hope of recovering Gibraltar, lost the Floridas and saw Havana and Manila fall before English fleets. The preliminaries of peace, however, had been agreed upon before the news reached England of the capture of Manila, and the conquest was therefore relinquished to Spain. The reforming Government of Charles III. exerted its activities even to the remote Philippines. The Royal Philippine Company was chartered to carry on direct

trade between Spain and the islands (1785). Three years earlier the enterprising Governor-General Basco y Vargas, to make the colony self-supporting, introduced the Government tobacco monopoly (1782), by which lands suitable for growing tobacco were arbitrarily pressed into that service and the cultivators compelled by forced labor to produce stipulated amounts to be sold to the Government at fixed prices. This system of compulsory labor was practically the first attempt really to exploit the resources of the islands, and during the following century was fruitful in abuses and of the seeds of revolt. It was abolished in 1882. In this connection should be mentioned the *polos y servicios*, forty days' required labor on the roads, bridges, public buildings, etc., which was exacted of the natives in addition to their tribute. These requirements for public service could be canceled for from one to three dollars. The official class men were exempt from this burden.

The Mexican Revolution severed the ancient connection of New Spain with the 'Western Islands,' and the Spanish Constitution of 1812, which embodied the principles of the French Revolution, and which put all parts of the Spanish Empire on an equality and admitted the Philippines to representation in the Cortes, led the natives to believe that now they would be exempt from tribute and *polos y servicios*. Consequently, when the news came that Ferdinand VII. in 1814 had abolished the Constitution of 1812, the Ilocanos rose in rebellion. Henceforward the agitations of home politics and the example of the Spanish-American States steadily undermined the old-time stability of conditions in the Philippines. The mission system could not be maintained in its integrity. The number of Spaniards in the islands increased, the spirit of colonial exploitation grew, the monastic Orders which combined the functions of landlords and spiritual guides were more and more pervaded with the mercantile spirit. Nor did their predominant influence in the government of the islands at all diminish in an age progressively hostile to clerical control. The opening of the Suez Canal brought the Philippines relatively near to Europe and more than ever exposed them to the contending forces of modern thought. Promising young Filipinos completed their education in Europe. By a few weeks' voyage they found themselves in many respects transported from the sixteenth century to the nineteenth. That they should contentedly return to the earlier age was impossible. The Spaniards did not weather the transition. The final collapse began with the insurrection of 1896, which was primarily an agrarian revolt aimed at the expulsion of the Orders from their estates and the islands.

It seems to be agreed that the establishment of Masonic lodges in the islands and the admission to them later of prominent Filipinos and Mestizos of anti-clerical or liberal sentiments offered a nucleus for agitation, facilitated united action, and led immediately to the formation of the patriotic Asociación Hispano-Filipina, the Liga Filipina, and the revolutionary society, "el Katipunan." The first Masonic lodges were founded about 1860, but it was over a quarter of a century before they became active centres of anti-clerical agitation. The Asociación Hispano-Filipina was devoted to promoting Filipino national aspirations through literary channels, and established an organ, *La Solidaridad*, in Barcelona.

The Liga Filipina was founded by Dr. José Rizal (q.v.) to work for the expulsion of the friars and to secure the same political concessions for the islands that had been granted to Cuba, a larger recognition of the natives in the appointments to civil offices, and freedom of the press and of association. More radical than these was the Katipunan, which was established in 1892 to secure independence by open revolt, and began by wholesale assassinations of Spanish officials and friars. The existence of an elaborate plot was revealed by a native, August 19, 1896, and on the 25th the mask was entirely thrown off. The garrison of Manila consisted of only 300 Spanish regulars and about 1200 native soldiers. The total number of Spanish soldiers in the islands was under 2000. The authorities could act only on the defensive until October, when reinforcements began to arrive from Spain. On the other hand, the insurrectionists were hampered by a great lack of arms and ammunition. The insurrection centred in the province of Cavité, which was under the control of the rebels until their power was broken in the spring of 1897 by the vigorous campaign of General Lachambre. Its leaders were Andrés Bonifacio, the head of the Katipunan, and Emilio Aguinaldo (q.v.).

After organized resistance had been shattered, it seemed wise to the Governor-General, Primo de Rivera, to attempt to secure peace by obtaining the withdrawal of the native leaders from the islands. In accordance with the Treaty of Biacnabató, Aguinaldo and some of the other generals withdrew to Hong Kong. No properly authenticated text of this treaty has ever been published. That made public by Aguinaldo is substantially identical with the demands which he made, and which it would appear were not acceded to by Primo de Rivera. Aguinaldo demanded \$3,000,000, the expulsion of the friars, the representation of the Philippines in the Cortes, equality of Filipino and Spaniard in the administration of justice, the participation of Filipinos in the higher administrative offices, a readjustment of the property of the parishes and of the taxes in favor of the natives, the proclamation of the individual rights of the natives, and liberty of association and of the press. Aguinaldo has asserted that the suppression of the religious Orders and the establishment of administrative autonomy were agreed upon, although not put down in writing, Governor-General Primo de Rivera giving his word of honor that the agreement would be fulfilled. Primo de Rivera, on the other hand, maintained that nothing but money and personal security were promised to the leaders. The treaty was signed December 17, 1897. Only the first installment (\$400,000) of the sum of \$800,000 finally fixed was ever paid, and, on the other hand, the insurrection was quieted only temporarily. In March, 1898, a new rising in the provinces north of Manila took place and early in April there was an outbreak in the island of Cebu. On March 24th the Seventy-fourth Regiment of native soldiers deserted to the insurgents, who now vastly outnumbered the Spanish forces, but were greatly hampered by the lack of arms.

The day that war began between Spain and the United States, Aguinaldo appeared in Singapore, and on April 24, 1898, United States Consul-General Pratt had a conference with him in reference to cooperating with Commodore Dewey. Of the exact nature of the understanding the same

uncertainty exists as in the case of the Treaty of Biacnabató. What is certain is that Commodore Dewey arranged for Aguinaldo to follow him to Manila and that Aguinaldo expected the United States to pursue in the Philippines the policy proposed for Cuba, the policy of common action with the insurgents against Spain for their liberation from her rule. What is probable is that Consul Pratt at Singapore, and Consul Wildman at Hong Kong, and Commodore Dewey as well, had similar expectations. Later they all equally disclaimed having bound the United States in any way. On May 1st the Spanish fleet in the Bay of Manila was annihilated by the Asiatic Squadron under Commodore Dewey. Aguinaldo arrived at Cavité on May 19th, in the American dispatch boat *McCulloch*. He had an interview with Dewey, who supplied him with arms for the insurgents, who flocked to his standard. In the weeks that elapsed until the arrival of General Merritt late in July, Aguinaldo secured control of the Province of Cavité and thoroughly invested Manila by land. His capture of Spanish garrisons was not only sanctioned, but assisted by Dewey, and had it not been for the native forces the capture of Manila would have been a far more arduous undertaking for the Americans and the Spanish forces might have eluded them by retiring into the interior. As it was, the condition of the Spaniards was hopeless, and on August 11th the arrangement was effected, through the Belgian Consul André, by which the American ships should refrain from firing on the walled city of Manila and the Manila forts from firing on the ships, while on shore there should be only a brief show of resistance to enable the Spanish general to save honor at least. The American soldiers were in ignorance of this arrangement, and through an accident there was more bloodshed than was intended at the taking of the city (August 13th). To the onlooking foreigners in the harbor the transaction seemed like a travesty of war. The fall of Manila marked the complete collapse of the Spanish power in the islands. The Americans held the capital and controlled the harbor; and Aguinaldo and the insurgents rapidly extended their control over the various provinces.

In the meantime (almost exactly coincident with the capture of Manila) came the signing at Washington of the peace protocol (August 12th), providing that the United States should occupy and hold the city, bay, and harbor of Manila, pending the conclusion of a treaty of peace, which should determine the control, disposition, and government of the Philippines. On October 31st, after the Peace Commission had been at work in Paris for a month, the Spanish plenipotentiaries were painfully surprised by a demand for the cession of the whole group. It was nearly a month before Spain yielded to the inevitable. In the treaty as signed December 10, 1898, Spain ceded the whole group and the United States agreed to pay Spain \$20,000,000, give Spanish ships and merchandise admission to the islands on the same terms accorded to American ships and goods for a period of ten years, and to transport to Spain the Spanish soldiers captured at the surrender of Manila. The treaty was submitted to the Senate of the United States January 4, 1899, and it was ratified February 6th, by only three votes more than the necessary two-thirds majority (57 to 27).

In the meantime, before the protocol of peace, Aguinaldo had organized a government (June 12, 1898), and in the provisional constitution promulgated June 23d he announced the independence of the islands as the chief object of the Revolutionary Government. On August 6th Aguinaldo appealed to the powers of the world for recognition of his forces as belligerents and of the independence of the Philippines, asserting that the Revolutionary Government was predominant in fifteen provinces. These provinces comprised the central part of Luzon and the majority of the inhabitants. During the following months the Americans held Manila and the native forces the rest of the island. The hopes of independence under American protection, which had been based upon the declared attitude of the United States toward Cuba and the friendly cooperation of Admiral Dewey and General Anderson, were rudely shaken by the proposed annexation of the islands to the United States, and relations became greatly strained in consequence of President McKinley's proclamation of December 21st that the islands were ceded to the United States and that military rule was to be extended over them as rapidly as possible. The tension proved too great to last, and on the night of February 4, 1899, hostilities broke out at Manila. The news of this battle, reported as an attack by the Filipinos on the Americans, no doubt contributed to the ratification of the peace treaty two days later.

The first intimations that the islands might be annexed called forth opposition in the United States, which was increased by the open declaration of that policy by the Government and greatly intensified by the outbreak of war between the American army and the Filipino republic. This opposition characterized the acquisition of the islands as the beginning of imperialism, as at variance with the traditional policy of the United States toward peoples struggling for independence, as being identical in its purposes with the projects of Napoleon III. in Mexico, as irreconcilable with the principles of the Declaration of Independence and the spirit of the Constitution, and as inevitably involving unknown expense and bloodshed. It was urged that our policy should have been one of conciliation and substantially identical with that pursued in Cuba, that the Filipinos were as capable of self-government as the South Americans, in whose behalf the Monroe Doctrine was first promulgated, or as the adherents of Juarez in Mexico, who were supported by the United States against Maximilian, and that a protectorate by the United States would have been acceptable to the Filipinos. On the other side, the acquisition of the islands by the United States was declared the only possible solution that would save them from anarchy or from falling into the hands of some European power, and that it was the duty of the United States to accept the burden. Others felt strongly the appeal of the great natural resources of the archipelago, almost undeveloped by Spain, and the immense strategic importance of holding them in view of the future Eastern Asiatic questions.

The discussion of the points of view and the policy of the Government were hampered by great lack of knowledge of the situation. To meet in part this difficulty, President McKinley appointed, in January, 1899, a commission, consisting of President Schurman of Cornell Uni-

versity, Admiral Dewey, Gen. E. S. Otis, the Hon. Charles Denby, and Prof. D. C. Worcester, to investigate conditions in the islands and to labor for the acceptance of American rule by the natives. In March, 1899, the Commission began its work. On April 5th it issued a proclamation to the people of the islands, explaining the purpose of their mission and the intentions of the American Government. The efforts of the Commission were devoted particularly to conciliating prominent Filipinos, and to building up a party favorable to American rule. To do this concurrently with the vigorous prosecution of the war was uphill work. In May they had a conference with some representatives of Aguinaldo, but it came to nothing.

The operations of the American army disorganized the republic and the national movement became embodied in the leadership of Aguinaldo. During the first nine months of the war disappointingly little headway was made by the Americans. The great majority of the engagements were within a radius of fifty miles of Manila. The military authorities exercised a rigid censorship over the press dispatches, so that it was practically impossible for the general public to know the real conditions. In the fall and winter of 1899 there was greater progress. Most of the country, from Manila to Dagupan, came under American control, and the native army was driven to the mountains. The principal events in 1900 and 1901 were in connection with the process of establishing civil government in the islands for which see above under *Government*.

On March 23, 1901, Aguinaldo was captured, and on July 4th military government was superseded by civil government in the pacified districts. By act of Congress, approved July 1, 1902, civil government was established throughout the islands. Up to the establishment of civil rule in July, 1902, the total number of troops sent to the islands amounted to 4135 officers and 123,903 men. The cost of the war to the United States was over \$170,000,000.

BIBLIOGRAPHY. The numerous works on the Philippines fall naturally into two groups, those describing the condition of the islands under Spanish rule, and those dealing with the new order of things brought about by American supremacy. To the first group belong the following: Mallat, *Les Philippines* (Paris, 1846), perhaps the best single work; Jagor, *Reisen in den Philippinen* (Berlin, 1873); Sansienco, *El progreso de Filipinas. Estudios económicos, administrativos y políticos. Parte económica* (Madrid, 1881); Jordana y Morera, *Bosquejo geográfico e histórico-natural del archipiélago filipino* (ib., 1885); Montero y Vidal, *El archipiélago filipino y las islas Marianas, Carolinas y Palaos* (ib., 1886); id., *Historia general de Filipinas* (Madrid, 1887-1895), perhaps the best general history; Meyer and Schadenberg, *Die Philippinen* (Dresden, 1890-1892); Zuñiga, *Estadismo de las islas Filipinas*, ed. by Retana (Madrid, 1893), which has a bibliography; Sastrón, *Colonización de Filipinas* (Malabón, 1897). The second group includes: Foreman, *The Philippine Islands* (2d ed., London, 1899), which gives an immense amount of information, and is the basis of several other works; Young-husband, *The Philippines and Round About* (New York, 1899), a general résumé of the history and political conditions; Lala, *The Philippine Islands*

(New York, 1899), which gives the point of view of a progressive Filipino; Sawyer, *The Inhabitants of the Philippines* (London, 1900), a historical study of the elements that make up the population of the islands; Buel, Wright, etc., *Our Late Wars: Spain and Our New Possessions* (Washington, 1900); Robinson, *The Philippines: The War and the People* (New York, 1901); Schurman, *Philippine Affairs: A Retrospect and an Outlook* (New York, 1902), an account of the proceedings of the first American Commission; U. S. *Philippine Commission, Report to the President* (4 vols., Washington, 1900-1901); Blair and Robertson, *Philippine Islands, 1493-1803*, an exhaustive work on the early history, compiled from original documents, to be in 55 vols. (Cleveland, Ohio, 1903 et seq.). On special periods of the history, consult for conquest and first half century, A. de Morga, *The Philippine Islands*, trans., Hakluyt Society (London, 1868); for the eighteenth century, Le Gentil, *Voyage dans les mers de l'Inde* (Paris, 1781). For the first half of the nineteenth century, Comyn, *Memoria sobre el estado de Filipinas* (Madrid, 1820; Manila, 1877; trans. by Walton, London, 1821); Sinibaldo de Mas, *Informe sobre el Estado de las Islas Filipinas en 1812* (Madrid, 1842); Buzeta and Bravo, *Diccionario geográfico, estadístico, histórico de las Islas Filipinas* (Madrid, 1850); Bowring, *A Visit to the Philippine Islands* (London, 1859). The novels of José Rizal, the Filipino patriot, illustrate the social conditions prior to 1896. *Noli me Tangere* (Berlin, 1856) appears in English somewhat condensed in two editions—*An Eagle Flight* (New York, 1901), and *Friars and Filipinos*, trans. by Gannett (New York, 1902). It was translated into French as *Au pays des Moines* (Paris, 1899). Other works on miscellaneous subjects are: Semper, *Reisen im Archipel der Philippinen* (Leipzig, 1868-1901); Blumentritt, "Versuch einer Ethnographie der Philippinen," in *Petermann's Mitteilungen, Ergänzungsheft* 67 (Gotha, 1882); Worcester, *The Philippine Islands and Their People* (New York, 1898); Stevens, *Yesterdays in the Philippines* (London 1890); Tornow, "The Economic Condition of the Philippines," in *National Geographic Magazine*, vol. x. (Washington, 1899); Morris, *Our Island Empire* (Philadelphia, 1899); Millet, *The Expedition to the Philippines* (New York, 1899); Sonnichsen, *Ten Months a Captive Among Filipinos* (New York, 1901); and for bibliography, Josephson, "Bibliographies of the Philippine Islands," *Bulletin of Bibliography*, vol. ii. (Boston, 1899). For the ethnology, consult: Blumentritt, "List of the Native Tribes of the Philippines, etc.," in *Smithsonian Report* (Washington, 1901); Meyer, "Die Philippinen," in *Ethnographisches Museum*, vol. viii. (Dresden, 1890); Brinton, "The Peoples of the Philippines," *American Anthropologist*, vol. xi. (New York, 1898), which has a bibliography; Meyer and Schadenburg, *Album von Philippinen-Typen* (Dresden, 1891); id., "Die Philippinen," and id., "Negritos," *Königlich-Ethnographisches Museum zu Dresden* (Dresden, 1893).

PHILIPPINE LANGUAGES. The number of languages spoken in the Philippine Islands is variously estimated as from about 25 to over 50. These languages may be considered under two heads: (1) the languages of the Negritos, probably the remnants of the aboriginal population, who live in scattered tribes in the interior of

most of the large islands; (2) the languages of the various tribes of Malay race which constitute the bulk of the population (Christian, Mohammedan, and pagan).

About the idioms of the Negritos very little is known, but they are apparently similar to the Malay dialects. This similarity, however, is perhaps to be explained as due to the influence of the languages of the surrounding Malay tribes, especially as, according to Spanish authorities, the Negrito languages are of monosyllabic structure, and entirely different from the languages of the Malays.

The idioms of the Malay tribes form a closely connected group of tongues which constitute a branch of the Malayo-Polynesian family of speech. The principal languages of the Christian tribes are: Batan (Batan and Babuyan islands, north of Luzon), Ibanag (North Luzon), Ilocan (North-west Luzon), Pampango (Central Luzon), Pangasinan (West Luzon), Tino (language of the Zambals, West Luzon), Tagalog (Manila, Middle Luzon, coast of Mindoro), Bikol (South Luzon), Bisayan (spoken in various dialects in the Bisayan Islands, and North and East Mindanao). The principal languages of the Mohammedan tribes are the Sulu of the Sulu subarchipelago and the coasts of Palawan, and the Magindanao of Southwest Mindanao. The idioms of the pagan tribes which inhabit the mountain districts of Northern Luzon, a large part of Mindanao, and the interior of Mindoro, Palawan, and the western Bisayan Islands, are very numerous, but little known. Among the best known are the Gaddan and Isinay of Luzon, and the Tiruray and Bagobo of Mindanao. A number of the Philippine languages, such as Tagalog and Bisayan, have reached a high state of development, and are well suited for literary use.

The vocabularies of the Philippine languages contain several foreign elements. In common with other languages of the Malay branch of the Malayo-Polynesian family, many of the Philippine dialects have borrowed a number of Sanskrit words. The languages of the Christian tribes also contain a number of Spanish words, those of the Mohammedan tribes a number of Arabic words.

The alphabets in which the native languages were or are written are also due to these foreign influences. The native alphabets, which are no longer used except by the Mangians of Mindoro and the Tagbanuas of Palawan, were probably derived from India. The Mohammedan tribes of the south now use the Arabic alphabet with some additional signs, while the languages of the Christian tribes are written in the Roman alphabet conformed to the peculiarities of Spanish orthography.

The sounds of the Philippine languages are in the main similar to those of English. All the languages, however, possess a peculiar guttural-nasal sound (written *ng*) distinct from the ordinary guttural-nasal *ng* as in Eng. *sing*. In some of the languages, as in Tagalog and Bisayan, there is a peculiar *r*-sound, due to a phonetic modification of *d*.

The roots of these languages are for the most part dissyllabic. They may be used uncoupled as nouns or adverbs, but only rarely as verbs. Derivation is accomplished by means of a great variety of particles, which are usually employed as prefixes, though there are a few suffixes and infixes. So prominent a characteristic is this use

of particles, that these dialects are sometimes spoken of as 'Particular' languages. Reduplication is very common in the formative processes of both noun and verb. There is no distinction of gender, nor is there, generally speaking, any inflection to denote person, number, or case in verbs or nouns. Only in certain pronouns is there found a species of inflection to indicate case. Verbs are practically always derivative, the particles employed being of two kinds: (1) special verbal particles, which give the root a simple verbal meaning or the signification of causative, intensive, etc., each particle generally having two slightly different forms, one used with active and the other with passive verbs; (2) the common or essential passive particles, which are an essential part of practically all passive forms. The combination of root and verbal particle is often modified to indicate differences in mood and tense.

The most salient syntactical characteristics of these languages are: (1) the use of certain particles, so-called ligatures, to connect two or more words which stand to each other in the relation of modifier and modified; such as adjective and noun, noun or pronoun and appositive, adjective or verb and adverb; (2) the prevailing use of a passive construction, the verb standing in the active only when the object of the action is something indefinite or when the agent is specially emphasized; (3) a paucity of simple prepositions, one or two being used to express the greatest variety of relations.

The following is a brief grammatical sketch of Tagalog, the most important of the Philippine languages:

The articles are simply definite, personal, and inclusive (used with names of persons), as *ang táwo*, 'the man,' *si Pedro*, 'Peter,' *siná Pedro*, 'Peter and his companions.' They have three case forms, nominative, genitive, and oblique. The plural of nouns is expressed by preceding *manḡá*, e.g. *manḡá táwo*, 'men'; case, by the case forms of the article or pronominal adjectives.

Adjectives are usually made by prefixing *ma* to a root, as *ma-búti*, 'good'; plural *mabubúti* or *manḡá mabúti*.

The pronouns have usually three case forms. Among them are to be noted *tayó*, 'we (including you),' *kami*, 'we (not you),' *kitá*, 'we two.'

The ideas of 'being' and 'having' are expressed by independent particles.

Verbs are divided into seventeen classes according to the special verbal particles. Four stems are distinguished, imperative-infinitive, future, preterite, and present. One class has no special particle in the passive, the active particle being *um*; in the others the special particle has generally initial *p* in the passive, which becomes *m* in the imperative-infinitive and future active, and *n* in the preterite and present active, as *pag*, *mag*, *nag*, etc. The present and future are characterized by reduplication. The common passive particles are *in*, *i*, *an*.

Practically the only simple prepositions are *sa* and, with names of persons, *kay* and *kaná*, 'to,' 'for,' 'from,' 'in,' etc. Adverbs and conjunctions are numerous and important.

The ligatures are, *-ng* after a vowel or *n*, *na* after other consonants, as *ang malakás na táwo*, 'the strong man,' *lubhá-ng mabúti*, 'very good.'

The construction of verbs is very similar to that of nouns. When the subject precedes, it is

connected with its verb by the particle *ay*, 'to be.' The direct object of the active and the agent of the passive stand in the genitive, other nominal adjuncts in the oblique case. Any verbal form may take the article *ang*. The character of the subject determines the verbal form to be used in a sentence. In general, if the subject is the agent of an action, the verb stands in the active, otherwise in the passive. The *in*-passive is used in general when the subject is the object of an action, the *i*-passive when it is the object of an action away from the agent, or the cause of an action, the *an*-passive when it is the place of an action.

The Philippine languages possess little literature. The old native manuscripts inscribed on leaves or strips of cane have been lost. At the present day the scanty native literature may be grouped under three heads: (1) religious writings; (2) native poetry; (3) native newspapers and newspaper articles.

Consult: Totanes, *Arte de la lengua Tagala* (2d ed., Binondo, 1865); Campomanes, *Lecciones de gramática Hispano-Tagala* (5th ed., Manila, 1894); Noceda, *Vocabulario de la lengua Tagala* (2d ed., ib., 1860); Zueco, *Metodo del Dr. Ollendorff . . . adaptado al Bisaya* (ib., 1871); Bermejo, *Arte compendiado de la lengua Cebuana* (Bisayan) (2d ed., Tambobong, 1894); Lozano, *Cursos de lengua Panayana* (Bisayan) (Manila, 1876); Mentrída-Aparicio, *Arte de la lengua Bisaya-Iiligayna* (Tambobong, 1894); Figueroa, *Arte del idioma Visaya de Samar y Leite* (2d ed., Binondo, 1872); Encarnacion, *Diccionario Bisaya-Español* (3d ed., Manila, 1885); Naves, *Gramática Hispano-Ilocana* (2d ed., Tambobong, 1892); Agustín, *Vocabulario Iloco-Español* (2d ed., Manila, 1888); De Cuevas, *Arte nueva de la lengua Ybanág* (2d ed., ib., 1854); Bugarín, *Diccionario Ibanag-Español* (ib., 1854); Bergaño, *Arte de la lengua Pampanga* (2d ed., Sampaloc, 1736); id., *Vocabulario de la lengua Pampanga* (2d ed., Manila, 1860); Pellicer, *Arte de la lengua Pangasinana* (2d ed., ib., 1862); Cosgaya, *Diccionario Pangasinán-Español* (ib., 1865); San Agustín-Crespo, *Arte de la lengua Bicol* (ib., 1879); Cowie, *English-Sulu-Malay Vocabulary* (London, 1893); Juanmartí, *Gramática de la lengua de Maguindanao* (Manila, 1892); id., *Diccionario Moro-Maguindanao-Español* (ib., 1892).

PHILIPPONS. A Russian sect, a branch of the Raskolniki (q.v.), who emigrated to Lithuania and East Prussia at the beginning of the eighteenth century. They take their name from their leader, Philip Pustosviät. They are described as peaceable and orderly, skilled in agriculture, thrifty, and industrious. They refuse to take oaths or perform military service, and set a high value upon suffering and death for conscience' sake. Priestly duties, such as leading in worship, baptism, and absolution, are performed by the oldest of the community. They do not observe the Lord's Supper, and have no confirmation or religious marriage ceremony. Their religious services consist in singing psalms, and reading the Gospels.

PHILIPPOPOLIS (Bulg. *Plovdiv*, Turk. *Filibch*). The largest city of Bulgaria next to Sofia, and formerly the capital of Eastern Rumelia. It is situated in a wide, fertile plain at the head of navigation on the Maritza

River, on the railroad between Constantinople and Sofia, and 80 miles southeast of the latter city (Map: Balkan Peninsula, E 3). Most of the houses are of wood, but the city has in recent years been much enlarged and beautified by the laying out of new streets and public parks, such as the beautiful Exhibition Park, laid out in 1892, and the growing up of fine residential suburbs containing the villas of wealthy Greeks and Bulgarians. The city is the seat of a Greek archbishop, and has a new Greek cathedral, besides a number of other Christian churches and many mosques. There are also a college and a national library. Philippopolis is the chief commercial centre of Southern Bulgaria, and has an active trade in the products of its manufactures, such as silk and cotton fabrics and attar of roses, as well as in rice, grain, tobacco, and hides. Population, in 1888, 33,032; in 1900, 42,849, of whom nearly half are Bulgarians, the remainder being mostly Turks and Greeks. Philippopolis was an important Thracian city in ancient times. It was almost wholly destroyed by an earthquake in 1818, and again by fire in 1846; but it recovered rapidly, owing to its excellent trade facilities.

PHILIPPOTEAU, fé'lô'pôtô', FÉLIX (1815-84). A French battle painter. He was born in Paris, and was a pupil of Léon Cogniet. His thorough knowledge of military details enabled him to depict the turmoil of battle with great historical truth, as may be judged by the following more important productions from his brush: "Louis XV. Inspecting the Battlefield of Fontenoy" (1840, Luxembourg Museum); "Battle of Balaklava" (1859); and some in the Museum at Versailles, such as the "Battle of Rivoli" (1844); "Bayard on the Bridge of Tarigliano" (1503); "Battle on the Alma" (1875). His "Last Banquet of the Girondists" (1850, Marseilles Museum) is also worthy of notice. He is well known as a painter of panoramas, in which he made great improvements. (See PANORAMA.) He received a medal of the first class in 1840 and the cross of the Legion of Honor in 1846.

PHILIPPSBURG, fil'ips-böörk. A town in the Grand Duchy of Baden, situated near the Rhine, about 17 miles north of Karlsruhe. It was once a noted fortress originally founded by the bishops of Speyer at the beginning of the seventeenth century. It played a conspicuous part in the wars of the seventeenth century, and the fortifications were destroyed in 1800. Population, in 1900, 2546.

PHILIPPSON, fil'ip-zôn, MARTIN (1846-). A German historian, born at Magdeburg. He studied at Bonn and Berlin, became docent at Bonn in 1871, and in 1878 professor in the University of Brussels. From this post he resigned in 1890 after a sharp quarrel with the anti-German student body, and removed to Berlin. Philippson wrote: *Geschichte Heinrichs des Löwen* (1868); *Heinrich IV. und Philipp III.* (1871-76); *Geschichte des preussischen Staatswesens vom Tode Friedrichs des Grossen bis zu den Freiheitskriegen* (1880-82); *Kurfürst Friedrich Wilhelm von Brandenburg* (1879-1901); *Kulturgeschichte Europas seit dem Ausgange des Mittelalters* (1898); and *Das Leben Kaiser Friedrichs III.* (1900).

PHILIPS, AMBROSE (1675?-1749). An English poet, born in Shropshire, probably in 1675.

He graduated from Saint John's College, Cambridge, B.A. in 1696, M.A. in 1700, and was elected fellow of his college, but he resigned his fellowship (1708) and traveled on the Continent. From Copenhagen he addressed (March 9, 1709) an *Epistle to the Earl of Dorset*, which was published in the *Tatler* (No. 12) with warm praise by Steele. The same year appeared his pastorals in Tonson's *Miscellany*, along with Pope's *Pastorals*. Then ensued a controversy as to which poet had better succeeded. Both series are artificial. Philips was angered by a moek commendation of his pastorals which Pope contributed to the *Guardian* (No. 40), and he is said to have hung up a rod at Button's coffee-house for chastising his adversary. No encounter ever took place. Philips was, however, remembered in the *Dunciad*. In ridicule of Philips, Gay wrote the *Shepherd's Week* (1714), descriptive of rustic life with the gilt off. In 1712 Philips was lauded for his adaptation of Racine's *Andromaque*. In 1718-19 he edited an imitation of the *Spectator* called the *Freethinker*. His support of the Government led to his appointment as secretary to Bishop Boulter in Ireland (1724). He also represented Armagh in the Irish Parliament; was made secretary to the Lord Chancellor (1726), and judge of the Prerogative Court (1733). He died in London, June 18, 1749. Philips also translated the odes of Sappho (1713), once thought to be a brilliant achievement. Perhaps his best work is represented by his odes to children (1725-26). Consult: Pope's *Works*, ed. by Elwin and Courthope (10 vols., London, 1871-89); and Johnson's *Lives of the Poets*, ed. by Henley (London, 1896).

PHILIPS, EDWARD (1630-c.1696). An English compiler, the biographer of his uncle, John Milton. The poet's elder and only sister, Ann, on her second marriage left her two sons by her first to the care of her brother, who took them into his own house in Aldersgate. Edward was at that time ten years old, John a year younger, and besides his nephews, Milton took in other pupils. Edward ceased studying with him in 1646, and two years afterwards went to Oxford, where he departed from his Puritan training and joined himself to the Cavalier Party. Edward voiced his royalist sentiments in *The Mysteries of Love and Eloquence*, etc. (1658), containing verses some of which are not original, and to record the Restoration he wrote a *Continuation* (1665) to Barker's *Chronicle of the Kings of England*, which had stopped at 1641. He edited the poems of Drummond of Hawthornden (1656), compiled a dictionary (1658), and was tutor in more than one noble household, but was often obliged to support himself and his family by compilations and translations. John Philips never became reconciled to his uncle, but Edward did. He was the first to praise *Paradise Lost* in the press, spoke in the highest terms of its author in his *Theatrum Poetarum* (1675), and wrote the scant but appreciative *Life of Milton* prefixed to the *Letters of State* (1694).

PHILIPS, FRANCIS CHARLES (1849-). An English novelist and playwright. He was born at Brighton and educated for the army, but he left army life and in 1884 became a barrister. At that time he began, without ceasing to be a barrister, to write both plays and novels. Of the latter the most noted is *As In a Looking Glass* (1885), which was dramatized and played both

by Mrs. Bernard Beere and by Sarah Bernhardt. Among his other books are: *A Lucky Young Woman* (1886); *The Dean and His Daughter* (1887), on which was founded the play of *The Dean's Daughter*, by himself and Sydney Grundy; *Young Mrs. Annesley's Courtship* (1890); *Mrs. Bourverie* (1894); *The Luckiest of Three* (1896); *Men, Women, and Things* (1898), etc. With various collaborators, he is the joint author of the plays *Husband and Wife*, *A Woman's Reason*, *Papa's Wife*, and others.

PHILIPS, or PHILLIPS, JOHN (1676-1709). An English poet, born at Bampton, Oxfordshire, December 30, 1676, and educated at Winchester School and at Christ Church, Oxford. He died at Hereford, February 15, 1709. Philips is still known for two poems: the *Splendid Shilling*, a burlesque (1701), and *Cyder* (1708), on the plan of Vergil's *Georgics*. The first was translated into Latin, and the second into Italian. As a Tory reply to Addison's *Campaign*, Philips wrote *Blenheim* (1705). Philips was among the few poets between Milton and Thomson to cultivate blank verse. Consult Johnson's *Poets*, ed. by Henley (London, 1896).

PHILIPS, KATHERINE (1631-64). An English poet, better known by her literary nickname, 'the Matchless Orinda.' She was born in London, the daughter of John Fowler, a well-to-do merchant. In 1647 she married a Welshman, Hector Philips, son of her mother's second husband; four years afterwards she addressed Henry Vaughan in what seems her first poem; and she soon formed that literary and friendly circle which included Jeremy Taylor and Sir Charles Cotterel, and in which she took the name Orinda. She spent the year 1662 in Dublin and there made many friends among the Royalist Party, with which she had sentimentally allied herself, and translated Corneille's *Pompeé* with great success. *Horace* she did not live to complete, for she died of smallpox in her thirty-third year. Her poems, printed without authorization in 1663, were highly praised by her contemporaries. Her *Letters to Poliarchus* (Sir Charles Cotterel) were published in 1705. Consult Gosse, *Seventeenth Century Studies* (London, 1883).

PHILISTINES (Lat. *Philistini*, from Heb. *P̄lišti*, Philistine). The designation in the Bible of a people who lived on the coast of the Mediterranean, to the southwest of Judea, from Ekron toward the Egyptian frontier, with their eastern limit at Beth-Shemesh. Aside from a few notices in Assyrian and Egyptian inscriptions, we have no knowledge of the early history of the Philistines, except what may be gathered from the Old Testament, in which their relations to the Hebrews are set forth in the course of the historical narratives. The people called Philistines were immigrants who came into Canaan from Caphtor (probably Crete). They are probably identical with the *Plst* of the Egyptian inscriptions, who invaded Egypt from the north in the time of Rameses III. and, being repelled, settled on the Syrian coast. Their settlement in Western Palestine presents, therefore, a parallel to the Hebrew conquest of Canaan. In both cases the new comers dispossessed an older population, and adopted the language and to a large extent the customs of the conquered race. But, while the Hebrews and Canaanites belonged to the same Semitic stock, the

Philistines are aliens in a racial sense. At the time of the Hebrew conquests, they were already in Palestine, and their five central cities, Ashdod, Gaza, Ashkelon, Gath, and Ekron, around which their history, as far as we know it, centres, were presumably already in existence. Hebrew tradition contains a reminiscence of an unsuccessful attempt to drive the Philistines out of their settlements (Jud. i. 18-19).

We reach more certain historical ground in the account of Shamgar's stand against the Philistines (Jud. iii. 31), but evidently the latter retained the supremacy, for we find them subsequently in possession of a sacred palladium of the Hebrews—the chest which was the symbol of Yahweh (I. Sam. iii. 10 sqq.). The story of Samson is of value as showing what were the relations between the Hebrews and Philistines. A victory is signalized for the Hebrews at Mizpah (I. Sam. vii. 10), but if the account is historical, the result was not decisive, for we find that Saul was constantly engaged in warding off their new encroachments, and at Gilboa he and his sons fell in a disastrous battle against them. David, however, though in the early part of his reign obliged to pay tribute to the Philistines, succeeded in routing them in several expeditions. Under Solomon they gave no further trouble, though it is doubtful whether they were ever actually tributary to the Hebrew kingdom. The internal troubles of Judea emboldened the Philistines once more to open resistance. Under Joram they invaded Judea and did considerable damage. Uzziah, however, recovered the lost ground; he overthrew them and dismantled some of their most powerful fortresses—Gath, Jabne, and Ashdod—and erected forts in different parts of their country. Under Ahaz, they rose again, and attacked the border cities of the 'plain' on the south of Judah; and a few years later renewed their attacks, in league with the Syrians and the Assyrians. Hezekiah, in the first years of his reign, subjugated their whole country again, by the aid of the Egyptians, whom we find in possession of five cities. The Assyrians were frequently engaged in conflicts with the Philistines, who at times joined the other Palestinian principalities in opposing the advance of Assyrian arms. In the struggles for supremacy which raged between the Neo-Babylonian monarchy and the Egyptians, Philistia was the constant battleground of both—her fortresses being taken and retaken by each of them in turn; so that the country soon sank into ruin and insignificance. In the time of the Maccabees the Philistines were subjects of the Seleucid rulers and had to suffer occasionally from the Jews, although intermarriages between the two nations were of no rare occurrence. Alexander Balas transferred part of the country to Judea; another part was taken by Alexander Jannæus; Pompey incorporated some of the cities with Roman Syria; Augustus transferred another portion to Herod; and, finally, Salome received a small fragment of it as a principality, consisting of Jamnia, Ashdod, and Ashkelon. But by this time the name of the country had long been lost in that of Palestine, which designated all the territory between Lebanon and Egypt.

Of the state of culture, institutions, etc., of the Philistines we know very little. They appear as a civilized, agricultural, commercial, and warlike nation. They traded largely, and their wares

seem to have been much sought after. Their worship was much akin to that of the Phœnicians and Canaanites. Dagon, Ashtaroth, Beelzebub, and Derceto were the chief deities.

BIBLIOGRAPHY. Stark, *Gaza and die philistäische Küste* (Jena, 1852); Schwally, "Die Rasse der Philister," in *Zeitschrift für wissenschaftliche Theologie*, vol. xxxiv. (Leipzig, 1891); W. M. Müller, *Asien und Europa* (Leipzig, 1893); id., *Die Philister* (Berlin, 1899); G. A. Smith, *Historical Geography of the Holy Land* (London, 1897); McCurdy, *History, Prophecy, and the Monuments*, vol. i. (New York, 1894).

PHILISTINISM. A term made popular in England and America by Matthew Arnold. The allusion is to the ancient Philistines, the enemies of the children of light; hence Philistinism, in its modern application, means stolid opposition to the higher intelligence of the age, inaccessibility to ideas; plain, humdrum, respectable conventionalism. The German students first applied the term *Philister* to a townsman or to one who had not been trained in a university; it soon found a foothold in German literature, and reached England through Carlyle. The term has now grown hackneyed and its indiscriminate use has almost emptied it of meaning. Perhaps Leslie Stephen's definition of Philistinism, as "a term of contempt applied by prig to the rest of their species," is the only one that is sufficiently comprehensive. Consult Arnold, "Heine," in *Essays in Criticism*, first series (Oxford, 1865).

PHILISTUS (Lat., from Gk. Φίλιστος, (c.435-356 B.C.). A Greek historian of Syracuse. He assisted the elder Dionysius in securing and maintaining supreme power in Syracuse (c.405 B.C.), but in 386 was banished for marrying a niece of the tyrant without the latter's consent. Recalled soon after the accession of Dionysius the younger, he brought about the banishment of Dion and Plato, and according to the latter, employed his talents in defense of the despotic policy of Dionysius. In B.C. 356, however, he was defeated in a naval battle by Dion and the revolted Syracusans, and either committed suicide or was killed by the populace. He left *Sicelica* (Σικελικά), a history of Sicily from the earliest times to B.C. 362, in thirteen books, begun in exile. According to the testimony of the ancients, by whom he is frequently mentioned, he sought in this work to palliate the despotic deeds of Dionysius, in order to secure his own return from exile. In style he was a close, though unsuccessful, imitator of Thucydides. The few extant fragments of Philistus are edited in C. Muller's *Fragmenta Historicorum Græcorum* (Paris, 1841).

PHILLEO, PRUDENCE (CRANDALL). See CRANDALL (PHILLEO), PRUDENCE.

PHILLIMORE, SIR ROBERT JOSEPH (1810-85). A distinguished English jurist, born in London. He was educated at Westminster and Christ Church, Oxford, where he graduated in 1831, and then became a clerk of the Board of Control. Soon afterwards he was called to the bar, where he acquired a large practice, and was made a Queen's counsel. In 1844 he was made Chancellor of the Duchy of Chichester, and later was a member of Parliament. He was made judge of the Cinque Ports in 1855, advocate-general in admiralty, 1862, when he was knighted, and in 1867 judge of the High Court of Admiralty and of the Arches Court of Canterbury. He was

Judge Advocate-General, 1871-73, and made Master of the Faculties in the latter year. In 1875 he resigned his other offices, and was appointed judge of the Admiralty and Probate Division of the High Court of Justice, retiring in 1880. The most valuable of his numerous legal works is his *Commentaries upon International Law*, 4 vols. (3d ed., London, 1879-89). Among his other writings are *Memoirs and Correspondence of George, Lord Lyttleton, 1731-73* (ib., 1845); *The Ecclesiastical Law of the Church of England*, largely taken from the work of Burns upon that subject (2d ed., ib., 1895).

PHILLIMORE, SIR WALTER GEORGE FRANK (1845-). An English jurist, born in London. He was educated at Oxford, where he had a particularly distinguished career, became a barrister of the Middle Temple in 1868, and received the Patent of Precedence there in 1883. He stood high in the Admiralty Court, and in ecclesiastical circles as vice-president of the English Church Union, and chancellor of the Diocese of Lincoln. He wrote a *Book of Church Law*, and edited Robert Phillimore's *Ecclesiastical Law of the Church of England*, and a third edition of vol. iv. of that author's *International Law*.

PHILLIP, JOHN (1817-67). A Scotch genre and portrait painter. He was born at Aberdeen, April 19, 1817. His boyhood was spent in poverty, but his remarkable talent attracted the attention of Lord Panmure, who enabled him to study at the Royal Academy. He at first painted Scotch genre subjects in the manner of David Wilkie, but a voyage to Spain in the summer of 1851-52, made for the benefit of his delicate health, completely changed his style. Influenced by Valazquez and by the bright colors of nature about him, he adopted the rich coloring by which his best works are distinguished. His work having attracted the attention of Sir Edmund Landseer, who introduced him to the Queen, he received a number of royal commissions, among which was a large ceremonial picture, "The Marriage of the Princess Royal with the Crown Prince of Germany" (1860). He visited Spain in 1856-57 and again in 1860, his last visit being a time of great artistic activity. After a journey to Rome and Florence in 1866, for the purpose of studying Titian, he was stricken with paralysis and died at Kensington (London), February 27, 1867.

Among the best paintings of his early period are: "Wallace and His Schoolfellows at Dundee" (1846); "Presbyterian Catechising" (1847); "Baptism in Scotland" (1850); "Scotch Washing" (1851). After his visit to Spain he executed "The Spanish Gypsy Mother" (1853), the "Letter-Writer of Seville," and the "Dying Contrabandista" (1858), all in the Royal Collection. Other important works are: "A Huff" (1859); the "Prison Window" (1857); "La Bomba" (1862-63); and his masterpiece, "La Gloria" (1864), in the National Gallery of Scotland. In the Metropolitan Museum, New York, is his "Gossips at the Well." He also produced a number of forcible portraits, including those of Sir J. E. Millais (1843), the Prince Consort (1858), and the Princess Beatrice (1860).

PHILLIPS. The name of a family identified with the founding of Phillips Academy (q.v.). SAMUEL, JR. (1751-1802), politician and philanthropist, was born at Andover, Mass. He grad-

nated at Harvard in 1771 and was elected in 1775 to the Provincial Congress, of which he continued to be a member until 1780, when he was elected a member of the Massachusetts State Senate, of which for seventeen years (1785-1802) he was presiding officer. From 1781 until 1798 he was also judge of the Court of Common Pleas for Essex County, and in 1891 he was elected Lieutenant-Governor by the Federalists. He is best known, however, as the founder of Phillips Academy at Andover in 1778. In this project he interested his father, SAMUEL (1715-90), who graduated at Harvard in 1734, and afterwards represented Andover in the General Court; his uncles, JOHN (1719-95), who graduated at Harvard in 1735, settled at Exeter and was for many years a member of the Council of New Hampshire, and WILLIAM (1722-1804), who held important political offices in Massachusetts; and the latter's son, WILLIAM, JR. (1750-1827), who was in twelve successive elections chosen Lieutenant-Governor of Massachusetts. Their liberality enabled the academy to take a high position from the day of its opening. A few years later John Phillips, who was childless, founded at Exeter a similar academy, to which at his death he bequeathed two-thirds of his estate, the remaining third going to Phillips Andover. During his lifetime he also endowed a professorship at Dartmouth College, and made liberal gifts to Princeton.

PHILLIPS, ADELAIDE (1833-82). An American opera singer. She was born at Stratford-on-Avon, England, but when she was seven years old her family emigrated to America and settled in Boston. She first appeared at the Boston Museum, in 1843, as "Little Pickle," and played *soubrette* parts in that theatre and at the Walnut Street Theatre, in Philadelphia, until 1852, when, having revealed the possession of a contralto voice of remarkable sweetness and compass, she was sent to Italy for study, an advantage obtained largely through the efforts of Jenny Lind, who organized a subscription for the purpose. She remained abroad two years, and made a successful *début* in Breseia, in 1853, in *Semiramide*. The following year she returned to the United States, and appeared in concert in the Music Hall, Boston, making her American *début* in opera at the Academy of Music, New York, March 17, 1856, in the part of "Azucena" in Verdi's *Il Trovatore*. In 1861 she sang in the Italian Opera House in Paris. She was the leading contralto singer of America for many years. She died at Karlsbad.

PHILLIPS, HENRY (1838-95). An American archaeologist, born in Philadelphia. He was admitted to the bar in that city in 1859, but, because of ill health, devoted himself to the study of numismatics, philology, and archaeology. His publications include *History of American Colonial Paper Currency* (1865); *History of American Continental Paper Money* (1866); *Pleasures of Numismatic Science* (1867); a volume of Spanish and German poetry (1878); Chamisso's *Faust* (1881); and four volumes from the Hungarian, German, and Spanish (1884-87).

PHILLIPS, JOHN (1800-74). An English geologist, born in Wiltshire. After receiving an elementary education he joined his uncle, William Smith, in geological investigations in various parts of England. In 1825 he was made curator of the Yorkshire Philosophical Society, and in 1834 was appointed professor of geology at King's

College, London. Resigning this office in 1840, he served successively as geologist on the survey of Great Britain, professor of geology at Trinity College, Dublin, and at Oxford, and Keeper of the Ashmolean Museum. He was president of the Geological Society in 1859-60. He contributed numerous papers to scientific journals, and also wrote the following separate works: *Illustrative of the Geology of Yorkshire* (1822-36); *Guide to Geology* (1834); *Treatise on Geology* (1837); *Geological Map of the British Isles* (1842); *Memoirs of William Smith* (1844); *Vesuvius* (1869); and *The Geology of Oxford and the Valley of the Thames* (1871).

PHILLIPS, JOHN ARTHUR (1822-87). An English geologist, born at Polgooth, near St. Austell, Cornwall, and educated at the Paris School of Mines. He was appointed chemist to the Admiralty commission engaged in finding the most suitable coal for burning at sea, and afterwards made valuable researches in mineralogy. He inspected gold mines in California and elsewhere, and between 1875 and 1878 he wrote a series of important monographs on the rocks of his native country. He published *The Mining and Metallurgy of Gold and Silver* (1867), and *The Elements of Metallurgy* (1874), but his chief work was *A Treatise on Ore Deposits* (1884).

PHILLIPS, PHILIP (1834-95). A Methodist evangelist and singer. He was born in Chautauqua County, N. Y. After the age of nineteen he devoted all his time to the study and use of music. During the Civil War he sang much for the benefit of the Christian Commission; he became musical editor for the Methodist Book Concern in 1866; and made a musical tour around the world in 1872, holding evenings of song in all lands. On his return he gave 200 nights for the Sunday School Union in England; subsequently he traveled with D. L. Moody. He produced a number of hymn books, such as *Early Blossoms* (1860); *The Singing Pilgrim* (1866); *American Sacred Songster*, prepared for the British Sunday School Union (1868); *Hallowed Songs* (1871); *Our New Hymnal* (1894); and, with his son, *Bright Gems* (1895). Several of these had a very large sale.

PHILLIPS, STEPHEN (1868—). An English poet, born at Summertown, near Oxford, July 28, 1868, son of the Rev. Stephen Phillips, afterwards precentor of Peterborough Cathedral. Having attended the grammar school at Stratford-on-Avon and at Peterborough, he studied for the civil service and entered Queen's College, Cambridge, in 1886, but at the end of the first term he joined F. R. Benson's company of Shakespearean players, with whom he stayed six years. He traveled through the country and played at the Globe Theatre in London. Among his parts were Iago, the ghost in *Hamlet*, Prospero, Brutus, and Sir Andrew Aguecheek. Leaving the stage, he became a lecturer on English history in Wolfram and Needham's classes for army candidates, but soon he adopted literature as a profession. In June, 1890, with three other authors he published in London a booklet of verse entitled *Primavera*. In 1894 followed *Eremus*, which won the praise of Symonds, Jowett, and Stopford Brooke. *Christ in Hades and Other Poems* (1896; fourth edition with additions, 1897), and *Poems* (1897), containing "Marpessa," secured for the author a high rank among

recent poets. The *Poems* won from the London Academy the award of one hundred guineas for the best verse of the year. Commissioned by George Alexander to write a verse tragedy for Saint James's Theatre, Phillips composed *Paolo and Francesca* (1899), a poetic tragedy in four acts. The blank verse of this lyric tragedy recalls the Elizabethans, but its simple structure is more nearly akin to the French classic drama. For Beerbohm Tree Phillips wrote his second play, *Herod* (1900), a tragedy in three acts on an Elizabethan theme. *Ulysses*, a dramatic poem, appeared in 1902, and in the same year a play called *David and Bathsheba*.

PHILLIPS, THOMAS (1770-1845). An English portrait painter, born in Dudley, Warwickshire. He was a pupil of Francis Eginton, a glass painter of Birmingham, and afterwards worked under Benjamin West on the windows of Saint George's Chapel, Windsor. He began to exhibit at the Royal Academy in 1791 and was elected to that institution in 1808. There he succeeded Fuseli as professor of painting and his *Lectures on the History and Principles of Painting* were published in 1833. His portraits include those of the Prince of Wales, William Blake (in the National Portrait Gallery), Napoleon (at Petworth), Lord Byron (two pictures), Crabbe, Lord Brougham, David Wilkie (in the National Gallery), Walter Scott, Hallam, Faraday, and Davy.

PHILLIPS, WENDELL (1811-84). An eminent American orator and reformer, born in Boston. He was educated at Harvard, graduating in 1831—the year of the first appearance of the *Liberator*. After a three-years' course at the Cambridge Law School, he was admitted to the Suffolk County bar; but he was little interested in professional eminence. On October 21, 1835, from his office window he indignantly saw Garrison dragged at a rope's end by a respectable mob; in 1836 he joined the Abolitionists, and thereafter was occasionally heard at meetings of the American Anti-Slavery Society. He came at once into prominence by his Faneuil Hall speech of December 8, 1837. At the instance of Dr. W. E. Channing, a public assembly had convened to protest in a suitable manner against the murder of the Rev. E. P. Lovejoy (q.v.) at Alton, Ill. This purpose seemed likely to be defeated by J. T. Austin, Attorney-General of Massachusetts, who commended the Alton rioters, and affirmed that Lovejoy "died as the fool dieth." To this Phillips made a brilliant and crushing reply, whose eloquence he never surpassed, and which has been ranked by Curtis with Henry's oration at Williamsburg, and Lincoln's Gettysburg address. From that time he was an Anti-Slavery leader, preëminently the orator of the movement. In 1839 he withdrew from the practice of law through scruples against compliance with the attorney's oath to the Constitution, and later he refused to stand for a Congress which he could not enter without swearing allegiance to that same Constitution. He called for the immediate and complete abolition of slavery, declared the Church *particeps criminis* for its attempt to justify slavery by the Scriptures, opposed colonization for the negro, discontinued voting, and regarded disunion as the best means for accomplishing emancipation. He was not, however, like Garrison, a non-resistant. In the Abolitionist

divisions of 1839-40, he with Garrison opposed the organization of the Abolitionists in a political party, and the attempt to bar any from the anti-slavery platform on the ground of religious beliefs. In 1840 he was the representative of the Massachusetts Abolitionists at the London World's Anti-Slavery Convention. Differences arose between himself and Garrison in 1864, in regard to Lincoln's reelection, which he did not favor; and in 1865 these differences were renewed when he advocated and Garrison opposed the continuance of the Anti-Slavery Society. His contention was that the work of the society was not finished until the negro obtained the suffrage. As a result he was elected in Garrison's stead (1865) to the presidency of the society, which was dissolved in April, 1870, upon the passing of the Fifteenth Amendment. Phillips was prominently active in the various controversies of the Reconstruction. Yet his task did not end there. "Let it not be said," he once wrote, "that the old Abolitionist stopped with the negro, and was never able to see that the same principles claimed his utmost effort to protect all labor, white and black, and to further the discussion of every claim of humanity." Accordingly, he spoke in behalf of Ireland, Crete, the Indian, prison reform, the abolition of capital punishment, prohibitory legislation regulating the sale of liquor, the 'greenback theory,' and in connection with the labor question urged that vast combinations of capital with unlimited monopolies and powers tend to make the rich richer and the poor poorer. In 1870 he received about 20,000 ballots as labor reform and temperance candidate for the Governorship of Massachusetts.

Phillips must be compared among American orators to Everett, Clay, and Webster; and his achievement is, perhaps, to be reckoned greater than that of any of these, when it is considered that whereas they represented a strong political organization or powerful conservative opinion, he attacked existing prejudices and institutions, for years spoke to hostile audiences, was denounced by the two great parties, and belonged to none. His manner was that of "simple colloquy," so that Greeley said Phillips made one think it easy to be an orator. His voice was in the baritone register, used largely in what elocutionists call the upper chest notes, and remarkable not so much for its compass, volume, or intensity as for its *timbre*. In gesture or general action he was sparing. He seldom employed the dramatic mode of expression. But in invective or epigram he was unsurpassed, he possessed wit, which most other notable American orators have lacked, and he told an anecdote with much skill. Phillips was not a scholar in the restricted sense, for this the demands made upon his time as a public speaker did not permit. But his reading was considerable, and he could always find illustrative material in the one subject he was accustomed to say he knew thoroughly—the great English Revolution. In addition to his anti-slavery and other reform speeches, he appeared in various lyceum addresses, the most noteworthy of which are *The Lost Arts*, *Toussaint l'Ouverture*, and *Daniel O'Connell*, and in 1881 he made a distinguished oration on *The Scholar in a Republic* at the centennial anniversary of the Phi Beta Kappa of Harvard. During anti-slavery days he always offered to speak without remuneration and pay

his expenses if he might substitute an anti-slavery for a literary subject. He wrote for the *Liberator* and the *Anti-Slavery Standard*, and published a number of pamphlets, including *The Constitution a Proslavery Compact* (1844); *Can Abolitionists Vote or Take Office Under the United States Constitution?* (1845); *Review of Spooner's Unconstitutionality of Slavery* (1847); *Review of Webster's Seventh-of-March Speech* (1850); *Review of Kossuth's Course* (1851); *Defense of the Anti-Slavery Movement* (1853). Collections of *Speeches, Lectures and Letters* have appeared at Boston, the first series, edited by James Redpath, in 1864, the second by T. C. Pease in 1892. These are edited from the best stenographic reports. There are two inadequate biographies, one by Austin (Boston, 1888), the other by Martyn (New York, 1890; American Reformers Series). Consult also works dealing with the anti-slavery struggle.

PHILLIPS ACADEMY. An important boys' school at Andover, Mass., commonly known as Phillips Andover. It was founded and opened in 1778 through the gifts of members of the Phillips family. The school was incorporated in 1780, and in 1807 the trustees were empowered to receive and hold funds for a separate theological institution, and the Andover Theological Seminary was accordingly established in the following year. In 1830 the Teachers' Seminary was established in anticipation of the normal schools, but in 1842 was merged in the parent academy, and is its present scientific department. In 1901 an archaeological department, with valuable collections and an endowment for instruction, research, and publication, was established by two anonymous donors. The Academy, with its sister institution at Exeter, has always been regarded as a typically democratic American school. During the early years of its history it had as students many of the famous men of the country. The equipment has in recent years been largely increased by new buildings, among them several dormitories and a gymnasium. The standards of Yale and Harvard, to which most of the graduates go, form the basis on which the work of the school is arranged. The academy had in 1902 an attendance of 400 and 24 instructors. The endowment was \$400,000, the gross income \$70,000, and the college property was estimated at \$500,000, exclusive of invested funds. The library contained 60,000 volumes.

PHILLIPS ACADEMY. One of the oldest and most renowned of American schools, at Exeter, New Hampshire, commonly known as Phillips Exeter. It was founded in 1781 and opened in 1783. The school was the first educational institution incorporated by the Legislature of New Hampshire, and has its name from John Phillips, its founder, who was a generous benefactor of Dartmouth College and of Phillips Academy, Andover, Mass. It early gained a national reputation, and drew students from all sections of the country. The alumni in 1903 numbered about 7000, among its earlier students being Daniel Webster, George Bancroft, Edward Everett, John A. Dix, and Jared Sparks. In 1902-03 over 300 students were enrolled and the faculty numbered 16. The school buildings, many of which have been built since 1886, include well-equipped laboratories, fine dormitories, an administration building, gymnasium, and a

building designed as a common dining-room and for the entertainment of visiting alumni. The buildings with their equipment are valued at about \$300,000. The endowment in 1902 was about \$400,000, and the annual income \$100,000. Characteristic of the school have been its democratic spirit and its successful application of a system of self-government.

PHILLIPSBURG. A town in Warren County, N. J., on the Delaware River, opposite Easton, Pa., and on the Pennsylvania, the Lehigh Valley, the Lackawanna, and the Central of New Jersey railroads (Map: New Jersey, B 2). It possesses valuable advantages for an industrial centre, the river affording good water-power and the railroads making accessible a supply of coal and iron ore. Its manufacturing interests are extensive, and include shops of three of the railroads that enter the town, also iron furnaces, sheet iron mills, foundries and machine shops, stove works, boiler works, horseshoe mills, drill works, and large silk mills. Settled in 1749, Phillipsburg was incorporated in 1861. It is governed under a revised charter of 1875, by a mayor, annually elected, and a council which controls appointments of most of the subordinate officers. Population, in 1890, 8644; in 1900, 10,052.

PHILLPOTTS, EDEN (1862—). An English novelist, son of Captain Henry Phillpotts. He was born at Mount Aboo, in India, November 4, 1862, and was reared at Plymouth, England. At the age of eighteen he became clerk in the Sun fire insurance office—a position which he held for ten years. A number of earlier novels were followed by two great successes, *Lying Prophets* (1897) and *Children of the Mist* (1898). In these novels Phillpotts depicted Devonshire life with remarkable power and beauty. In their coloring they recall Blackmore, and in their tragedy they are akin to Hardy. There have since followed *Loup Garou* (1899); *The Human Boy* (1899), which is a volume of stories illustrating schoolboy humor; *Sons of the Morning* (1900); *The Striking Hours* (1901), a collection of short Devonshire stories; *The Good Red Earth* (1901); and *The River* (1902).

PHILOBIBLON. A prose treatise by Richard Aungerville, known as Richard de Bury, Bishop of Durham (1345). The author, an enthusiastic collector of books, and founder of a library at Oxford in connection with Durham College, writes in praise of learning, of the value and proper care of books, with advice to students. It was printed first at Cologne in 1473, at Paris in 1500, and at Oxford in 1599. The latest English translation is that of E. C. Thomas (London, 1885).

PHILO BYBLOS. See SANCHONIATHON.

PHILOCORUS (Lat., from Gk. Φιλόχορος). A Greek historian who is said to have lived at Athens between B.C. 306 and 260. According to Suidas, he was one of the bitterest opponents of Demetrius Poliorcetes and of his son, Antigonos Gonatas, and was put to death by the latter after the conquest of Athens (about B.C. 260). He is known chiefly by his *Atthis*, a history of Athens from the earliest times to B.C. 262, in seventeen books. By later writers it is frequently referred to as one of the most thorough and reliable of the special histories of Attica. Important fragments are preserved in Müller's *Fragmenta*

Historicorum Græcorum (Paris, 1841). Consult: Streuge, *Quæstiones Philochoræ* (Göttingen, 1868), and Siebelis's edition (Leipzig, 1811).

PHILOCTETES (Lat., from Gk. Φιλοκτήτης, *Philoktētēs*). A Greek chieftain who inherited the bow and arrows of Heracles. He started with seven ships for the Trojan War, but was bitten on the way by a serpent at Lemnos. On account of the stench of the wound, the other Greeks left him behind and went on to Troy. As an oracle, however, declared that Troy could only be taken by the arrows of Heracles, Odysseus and Diomedes went to Lemnos to fetch Philoctetes. He accompanied them to Troy, slew Paris, and returned safely home. The drama *Philoctetes* by Sophocles is still extant, the legend having been also dramatized by Æschylus and Euripides.

PHILODEMUS (Lat., from Gk. Φιλόδημος). An Epicurean philosopher of the first century B.C. He was born at Gadara in Syria, and studied under Zeno. Besides thirty-four epigrams, mostly erotic, in the Greek anthology, Philodemus wrote works on philosophy, of which copies much mutilated were discovered at Herculaneum. They are: *De Rhetorica*, edited by Gros (1840) and by Sudhaus (1892-95); *De Musica*, edited by Kempke (1884); *De Vitis*, by Götting (1830) and Ussing (1868); *De Ira* and *De Pietate*, by Gomperz (1864-66); and *De Morte*, by Mekler (1886). Martha makes him the editor of Lucretius and many attempts have been made to prove that Cicero got his knowledge of Epicureanism from Philodemus and so from Zeno.

PHILO JUDÆUS (Lat., from Gk. Φίλων Ἰουδαῖος, *Philōn Ioudaios*, Philo the Jew). A Jewish-Hellenistic philosopher, born at Alexandria about B.C. 25. He belonged to one of the most wealthy and aristocratic families—his brother Alexander was the Alabarch or president of the Jewish colony at Alexandria—and he received the most careful Jewish education, consisting largely of a study of the Old Testament in the Septuagint version. He also became acquainted with the writings of the Greek philosophers. He went to Rome, A.D. 39 or 40, as the advocate of his Alexandrian brethren, who had refused to worship Caligula in obedience to the Imperial edict. He has left an account of this embassy, the result of which was not satisfactory. Of his life we know little except what is recorded above.

While strict in all that pertained to ceremonial and ritual, in doctrinal matters Philo was a bold allegorizer. A literal interpretation of the Scriptures he regarded as superstitious and mean. Especially did he explain away all theophanies recorded in the Old Testament, as told in accommodation to the sensuous character of human minds, which needed anthropomorphic representations of supersensible truth.

His writings develop his ideas and his system in the two directions indicated. In that division of his writings principally which treats of the creation (*Kosmopoia*), he allows allegory to take the reins out of his hands; in that on the laws (*Nomoi*), on the other hand, he remains remarkably sober and clear, extolling the Mosaic legislation throughout, at the expense of every other known to him. In a very few instances only he is induced to find fault, or to alter

slightly, by way of allegory, the existing ordinances.

His idea of God is a preëminently theosophic not a philosophic one. God alone is the real good, the perfect, only to be imagined as the primeval light, which cannot be seen by itself, but may be known from its rays, that fill the whole world. He has no attributes, and therefore no name, and reveals himself only in designations expressive of this 'inexpressibility.' He is better than virtue and knowledge, better than the beautiful and the good (*Kalokagathia*), simpler than the one, more blissful than bliss. He is the existing unity or existence itself, self-sufficient, free from pain and fear and participation in evils, and full of happiness. Dynamically God is omnipresent, but not really. Indeed, so far is God really from filling the world with his presence that the world, on the contrary, finds its place in God. And yet the God who comprehends within himself the material universe is so exalted above the world and so remote from it that a point of contact cannot be found between them; hence the need of an intermediate class of beings to stand between them. These were found in the spiritual world of ideas, which are not only 'ideals,' or types, in the Platonic sense, but real, active powers, surrounding God like a number of attendant beings. They are his messengers, who work his will, and by the Greeks are called good demons; by Moses, angels. There are very many different degrees of perfection among them. Some are immediate 'serving angels;' others are the souls of the pious, of the prophets, and the people of Israel, who rise higher up to the deity; others again are the heads and chief representatives of the different nations, such as Israel does not need. The *Logos* comprises all these intermediate spiritual powers in his own essence. (See article *LOGOS* for Philo's views on this part of his system.) Man is a microcosm, a little world in himself, a creation of the *Logos*, through whom he participates in the deity. The ethical principles of Stoicism Philo identified with the Mosaic ethics, in which the ideal is most exalted moral perfectibility or sanctity, and man's duties consist in veneration of God, and love and righteousness toward fellow-men. Philo holds firmly the belief in immortality. Man is immortal by his heavenly nature; but as there are degrees in his divine nature, so there are degrees in his immortality, which only then deserves this name when it has been acquired by an eminence of virtue. There is a vast difference between the mere living after death, which is common to all mankind, and the future existence of the perfect ones. Virtue and sin both have all their rewards within themselves; but the soul, which is 'pre-existing,' having finished its course in the sublunary world, carries this consciousness with it in a more intense and exalted manner. Paradise is oneness with God; there is no hell with bodily punishments for souls without a body, and no devil in the Philonic system. (For the relation between Philo, as the representative of the Judeo-Alexandrian philosophy, and other contemporary philosophic tendencies, see *NEO-PYTHAGOREANISM*). Of the many works left under his name, several have been declared spurious, but in some cases without much show of reason. His writings have been published by Richter (Leipzig, 1828-30) and by Tauchnitz

(ib., 1851-54). See Gfrörer, *Philon und die alexandrinische Theosophie* (Stuttgart, 1831); Dähne, *Geschichtliche Darstellung der jüdisch-alexandrinischen Religionsphilosophie* (Halle, 1834); Wolff, *Die philonische Philosophie* (Leipzig, 1849); Delaunay, *Philo d'Alexandrie* (Paris, 1867); Drummond, *Principles of the Jewish-Alexandrian Philosophy* (London, 1877); id., *Philo Judæus* (ib., 1888); Freudenthal, *Die Erkenntnislehre Philos von Alexandria* (Berlin, 1892).

PHILOLA'US (Lat., from Gk. Φιλόλαος) (c.450 B.C.). A Pythagorean philosopher, born at Tarentum or Croton. Little is known of his life. Some fragmentary writings are attributed to him, in which he sets forth the teachings of Pythagoras. The authenticity of these writings has been the subject of serious study and of dispute among critics. To him is ascribed a knowledge of harmonic ratio, and of the fact that the number of vertices of a cube is an harmonic mean between the number of faces and the number of edges. He seems also to have known with reasonable exactness the periods of revolution of the planets. Consult: Boeckh, *Philolaus des Pythagoräers Lehren, nebst Bruchstücken seines Werkes* (Berlin, 1819); Schaarschmidt, *Die angebliche Schriftstellerei des Philolaus* (Bonn, 1864).

PHILOLOGICAL ASSOCIATION, AMERICAN. A learned society, organized at Poughkeepsie, N. Y., in July 1869, from the Classical Section of the Oriental Society (q.v.), with Prof. William D. Whitney, of Yale, as the first president. Its object is the advancement and diffusion of philological knowledge. It has a membership of about 600, and its annual meetings are held in such cities as the society may, from year to year, select. The publications of the association are annual volumes of *Transactions*, in which are printed in full such papers as the executive committee may select, and *Proceedings*, giving an account of the annual meeting and brief abstracts of all papers presented to the society.

PHILOLOGICAL SOCIETY, BRITISH. A learned society founded in London in 1842, to investigate and promote the study and knowledge of the structure, the affinities, and the history of languages. It added to these objects the publication of the 'New English Dictionary,' work upon which was begun in 1857, under the editorial charge of Dr. James A. H. Murray, assisted by many scholars and men of science in Great Britain and the United States. The first part was published in 1884, and the bound volumes issued to 1903 bring the Dictionary down to the letter M, though some parts in O and Q have also been sent out in pamphlet form. The society has its headquarters at University College, London, and holds its annual meeting in May and monthly meetings from November to June, at which papers are read, the more important ones being afterwards published in volumes of *Transactions*, distributed to members without charge, while summaries or synopses of the other papers are printed in the monthly *Abstract*, also published by the society.

PHILOLOGY (Lat. *philologia*, from Gk. φιλολογία, love of literature and learning, love of language and history, from φίλος, *philos*, dear + λόγος, *logos*, word). In modern English usage,

the science of comparative linguistics. As speech may be studied either in its expression or in its origin, philology may occupy itself with linguistic expression, with literature, or with the genesis and laws of language. French and German scholars usually employ the word in the former sense, and many English scholars prefer to understand by philology the study of literary expression, even including all that is revealed through literature. Nevertheless, although this is perhaps the more legitimate use of the word, yet the tendency of the day, even among French scholars, and still more among English-speaking people, is to confine philology to the study of language, and to divide this study into (a) linguistics proper, including phonetics, and (b) comparative philology, the study of language by a comparison of different languages in the same family. Languages may be divided roughly, and merely for convenience without scientific accuracy, into several types. Of these the most important are the isolating or monosyllabic, the agglutinative, with its subdivision the incorporating or synthetic, the inflectional, and the analytic. The isolating group, formerly supposed to be represented by Chinese, is characterized by invariable monosyllabic roots. The opinion which once considered this group to be the most primitive is now rejected by many who hold that the type represents, on the contrary, the culmination of a long linguistic evolution. The agglutinative type, which includes the majority of languages, such as the Dravidian, Malayo-Polynesian, Uro-Altaic, and African, is marked by the addition of prefixes, suffixes, and infixes to the so-called root (q. v.) or base. These additions have, at least at first, distinct meanings of their own, but in course of time the meanings become obscured, the particles themselves become fused in signification with the base, and lose their individuality. The result is the type of language called inflectional. (See INFLECTION.) In the incorporating or polysynthetic languages, represented by the American Indian groups, the verb absorbs the name, pronouns, adjectives, and adverbs, thus marking a higher degree of agglutination than the agglutinative languages themselves. The analytic languages are a development of the inflectional. In time the inflections tend to become weakened in force, and to require the help of pronouns, prepositions, and auxiliary verbs. When the inflections have in the main disappeared, and their places have been taken by individual words, the language is termed analytic. To this group belong such languages as English, French, Italian, Persian, and Hindustani, as distinguished from the inflectional groups represented by the Semitic and Indo-European families, which include Hebrew, Arabic, Sanskrit, Greek, Latin, and German. It is, however, customary to confine comparative philology to the study of the group of Indo-European languages, though there is no reason why the term should not be applied to any other group as well. The different aspects of philology thus outlined are treated under different heads, to which the reader is referred for special discussion. See the articles on LANGUAGE, for the psychology of language; ALBANIAN, ARMENIAN, INDO-IRANIAN, etc., for special branches; and for classical philology, see the articles on GREEK LANGUAGE and ITALIC LANGUAGES.

HISTORY OF COMPARATIVE PHILOLOGY. Until the discovery of Sanskrit no comparative philology was possible. Sir William Jones in 1786 and Schlegel in 1808 connected Sanskrit with Greek and Latin; but Franz Bopp (q.v.) first correlated the facts observed by others and founded the science. Approaching the subject from the philosophical side, Bopp devoted himself to glottogonic problems, his chief aim being to discover phonetic laws and the genesis of forms. He was at first influenced by Friedrich Schlegel, and opposed the doctrine of mechanical affixes (called agglutination), holding rather to an inner inflection as the index of different relations, though he admitted into the root (in the aorist, etc.) the abstract verb *as*, 'be.' But this view (1816) was soon changed, and Bopp in 1819 himself opposed this philosophy of language and taught that verbal endings, *-ti* for example, are really pronominal in origin. In his *Conjugations-system* and *Vergleichende Grammatik* (1833) he went still further, assuming a pronominal origin for case-endings as well as verbal endings (*-s* of the nominative being *sa*, 'he,' etc.). It is unnecessary to give in detail the mixture of fact and fancy which from a later point of view, alternately adorns and disfigures this first exhaustive attempt to create a science of grammar. His monumental work was followed by the equally important *Geschichte der deutschen Sprache* (1848) of Jakob Grimm (q.v.), who with Rask (q.v.) extended the comparison of forms and discovered phonetic laws of change (see below). After Grimm, the *Etymologische Forschungen* (1836) of Pott (q.v.) established a rationalized system of etymology for the whole group of Indo-European languages. Bopp, Grimm, and Pott may justly be called the creators of the comparative study of language. Agglutination, monosyllabic roots, *a*, *i*, *u*, as the three essential vowels, and a mother-language, these characterize the belief of the first period of the study represented by them. This period extends to the appearance of Schleicher's (q.v.) *Compendium* (1862), which systematized the views of his predecessors, while adding to them his own more stringent but false conception of language as a living organism, which in his opinion should be studied by the methods of natural science. An increasing respect for 'phonetic law' (q.v.) marks the close of this period, in which the names of Schleicher and Georg Curtius (q.v.), the latter being one of the first to insist on phonetic regularity, are most prominent. Different languages now began to be studied more carefully, each for itself, and the laws of each more strictly established. New problems arose, such as that of the parent language and primitive vocalism, but Schleicher stood on the platform of his predecessors as regards the old problems. The parent speech Schleicher represented as the root of a tree, with trunk, branches, and twigs representing descendant languages and dialects (the so-called *Stamm-baum-Theorie*). Like Curtius, he held that the simpler vocalism of Sanskrit was more antique than the variation shown in Europe, and believed that Sanskrit *a* was older than Greek *α*, *ε*, *ο*.

Ten years later, in 1872, Johannes Schmidt (q.v.) published his *Verwandtschaftsverhältnisse der indogermanischen Sprachen*, which put the interrelation of the different Indo-European languages in a new light. Instead of a family-tree with its organic growth and dialect-twigs,

Schmidt set forth the *Wellentheorie*, according to which the different languages had rolled away like waves from a common centre. This view replaced Schleicher's and in a somewhat modified form has been adopted by Leskien, Schrader, and other scholars of the present day. According to it, certain words and forms are explained as being common to one section till that splits up and so leaves the contiguous peoples in possession of a common linguistic property, while those dwelling farther apart possess linguistic property which, although originally practically identical, has become so differentiated as frequently to be mutually unintelligible. The obvious objection is that some wave-segments may have lost material formerly possessed and others made for themselves what is also found in other segments. This change of view is paralleled by that in regard to vocalism. Instead of assuming that the primitive language had only *a*, *i*, *u*, and that Sanskrit *a* was an older phase as compared with Greek *α*, *ε*, *ο*, the scholars of the second period, which began about 1862, Brugmann, Osthoff, Collitz, and others, showed that the varied phase was older. During this period, as for a dozen years previously, much of the best effort of philologists was directed toward individual languages, the publication of texts, lexicons and grammars, which gave much new material in many directions, notably in the Indo-Iranian field. Benfey, Roth, Böhtlingk, Westphal, Curtius, and Max Müller thus furthered the cause of general comparative philology. Moreover, new languages were added to the group, such as Albanian, Armenian, and Phrygian. At this time also began to be discussed afresh the problem of new formations. The answer to this was given in Whitney's enunciation of the theory of analogy (q.v.). By imitation of the old, the new is produced. But especially were the scholars now calling themselves young grammarians insistent upon one principle which became a shibboleth. This was the invariability of phonetic law (q.v.). In the seventies and eighties the various philologists of note in Germany were more or less split up into cliques headed by Georg Curtius, Fick, Schmidt, Brugmann, and others, but this was due less to a radical difference than to personal feeling and may be passed over. In America, Whitney centred his attention upon the fundamental question of the origin and growth of language, and in so doing came into conflict with Max Müller. Müller claimed that language gives conceptions which could not exist without speech. Thought and word were, in his view, convertible terms. Whitney held, on the other hand, that words are only signs associated with conceptions, and that every language known to us is a body of conventional signs for ideas. Müller denied that any man can change a language; Whitney maintained that individuals initiate changes subsequently accepted by the community, which makes the changes parts of its language by the simple employment of them. To Müller, language-study was a physical science, even in his final revision of the views first expressed in 1862. In all this, Müller showed that he was of the school of Schleicher, whom, indeed, he cited as his chief authority in teaching that the study of language is a physical science. Language is, however, a human institution, not a physical science, and the failure to recognize this fact undermines the foundation of Müller's

view. Müller further held that no new roots have ever been made since the original root-making period, and he treated these primitive roots as if they were necessarily non-derivative forms. In point of fact, many of the 'roots' of the primitive tongue may be reductions from compound words comparable to 'preach' and 'cost' in English. (See ROOR.) Such primitive roots in Müller's opinion, however, are ultimate facts, the nuclei in a chaos of interjectional or imitative sounds. Whitney upheld the view that language was composed of a body of conventional signs originally of depictive character of any sort, onomatopoeic or not. In one respect only was there an advance in Müller's system on Schleicher. He accepted the 'physical science' view of language, but he rejected the notion of a primitive Indo-European language from which Sanskrit, Greek, Latin, Germanic, Slavonic, and Celtic were derived, though even here he spoke of the mother-language of the whole family. At the same time he argued that where in two dialectic forms of one word there are two different consonantal sounds they must go back to an indistinct pre-ethnic consonant capable of developing into either, which is, in the premises, an impossible assumption. It is remarkable that German scholarship added little to the discussion of these fundamental questions. An exception, however, must be made in favor of Paul, whose *Prinzipien* (1880) discussed at length and acutely the causes leading to phonetic and morphologic changes. On the other hand, all the great discoveries of comparative philology have been made by Continental scholars.

THE FIELD OF INVESTIGATION. Turning now from this historical outline of the growth of the science of philology to the subject-matter of the science, it will be necessary first to explain the field of investigation. Comparative philology as applied to the Indo-European languages (q.v.) first demarcates those languages from others. The Indo-European family constitutes a single group, separated both by vocabulary and by structure from other groups of languages. Whether the Indo-European group had at any time a common origin with other groups passes human knowledge. Many scholars (Ascoli, Abel, and others) have made abortive attempts to connect Indo-European forms with Semitic, Mongolian, and Egyptian forms, but nothing cogent has been produced to show that there is any radical affinity between them, though there has often been connection. The name Indo-European is only one of many, but at present the usual one, to designate the group called in German quite as often Indo-Germanic, and in English frequently Aryan. The last name is one often used by German scholars to designate the narrower group of Indo-Iranian. The members of the Indo-European group are the sub-groups known as Indie, Iranic, Anatolic, Hellenic, Celtic, Teutonic, Balto-Slavic. Some scholars add Albanian as a separate sub-group and some particularize Armenian as a subdivision on a par with Hellenic (see below). These sub-groups include a great number of languages and dialects, various in themselves and in some cases intricately combined. The chief elements making each group are:

INDIC. Sanskrit and the pre-Sanskrit Vedic language. The former name is often made to cover both divisions, but, like English in relation to Anglo-Saxon, though conveniently used, it is

not accurate. There was no Sanskrit language till after the Vedic period. Whether Sanskrit is derived from the Vedic may be doubted. It is closely connected with that earlier language, but it is quite possible that the two are dialectic variations from the start. Evidence given by the Linguistic Survey of India seems to show that there were two main Aryan invasions of India, entering by two different routes and at different times; that those speaking the Vedic language were the first comers, afterwards pressed to the wall by the ancestors of those who in course of time spoke what we call Sanskrit. Opposed to Sanskrit is Prakrit (q.v.), a general term for various dialects recognized at an early date as being not Sanskrit and yet not foreign. The language of Hinayana Buddhism, Pali (q.v.), was one of these patois. It is closely related to the Vedic language, and may be as old. Corresponding to the patois Prakrit dialects of antiquity are the modern provincial dialects, Bengali, Panjabi, etc., reflecting, however, more or less the effect of Sanskrit. A European offshoot of this division is the Gypsy language of Europe, many of whose words (verbal roots) are still identical with those of Sanskrit. (See GYPSIES.) The oldest literary remains of this group are from B.C. 1000 to 1200, though some scholars assign a much greater antiquity to the Vedas, the earliest Indic literature.

IRANIC. This group, the name of which is derived from Iran (Eran), the great plateau including Persia, Afghanistan, and Baluchistan, can be traced from quarters contiguous with the Indic group, and is closely connected with the latter. In fact, Indie and Iranic (Aryan in the narrower sense) are both dialects of the same language rather than separate languages. Especially is this true of the Old Bactrian (Avestan or Zend) division of Iranic (see AVESTA), the sacred literature of which extends back to about the seventh century B.C. Opposed to this division is the Old Persian (q.v.), sometimes called the Western dialect in antithesis to Avestan as the Eastern. Old Persian is the language of the euneiform inscriptions of the Persian kings, and this alone survived as a spoken language, being gradually modified into Pahlavi (q.v.) and New Persian. See PERSIAN LANGUAGE.

ANATOLIC. This group comprises Armenian (which was formerly regarded as Iranic and is now sometimes accorded a separate division), Phrygian (q.v.), and Scythian, and until lately was supposed to be represented by Lycian and Carian also. Later investigations, however, have shown that the two latter do not belong to the Indo-European group, and Scythian applies only to such remnants of Indo-European origin as are represented by some of the names of nomads in Southern Russia and on the border of Asia Minor. As such the division is maintained by Fick, but it rests on very doubtful evidence. The oldest literature is of the fourth century, unless the recently (1902) interpreted 'Arzawa' language assigned to Cappadocia be regarded as Indo-European (c.1400 B.C.).

HELLENIC. This comprises all the old Greek dialects, Ionic, Doric, etc.; Albanian, a mixture of Greek and foreign elements; also the modern dialects of Greece. (See GREEK LANGUAGE.) The literature goes back to about B.C. 1000.

ITALIC. This division includes Latin, Umbrian, Oscan, and other minor dialects; modern dialects,

in part primitive, in part due to foreign elements, Italian, Provençal, French, Spanish, Portuguese, Ruman, etc., called in general Romance. The literature goes back to the third century B.C. (inscriptions still older). See LATIN LANGUAGE; ITALIC DIALECTS; ROMANCE LANGUAGES.

CELTIC. This group comprises (1) Cymric (Welsh, Breton, Cornish); (2) Gadhelic (Erse, Manx, Gaelic). The literature can be traced to the eighth century A.D. See CELTIC LANGUAGES.

TEUTONIC. Originally Gothic (see GOTHIC LANGUAGE) and non-Gothic were the only divisions. These subsequently, on the basis of one euphonic change, were differentiated into Low and High German. The old divisions, still recognized by many scholars, are: (1) High German (Old, Middle, New); (2) Low German (Gothic, Saxon, Dutch, Frisian); (3) Scandinavian (Norse, Icelandic, Swedish, Danish). Gothic literature (translations of the New Testament) is of the fourth century A.D., but linguistic forms cited by Roman writers are earlier. See TEUTONIC LANGUAGES.

BALTO-SLAVIC (SLAVONIC). It is customary to unite these languages, which, however, stand as far apart as do Indo-Iranic. The Baltic (or Lettic) division, embracing the Old Prussian (q.v.), Lithuanian (q.v.), and Lettic (q.v.), the last-named spoken in Courland and Livonia, forms a unit over against the Slavic division (see SLAVIC LANGUAGES), which is divided into a large number of dialects incapable of being subdivided into different groups, though one division into Eastern, (South) Eastern, and Western, and another into two subdivisions are sometimes made. But phonetics and morphology together prevent such classifications except as a matter of convenience, all the dialects being more or less related, but not in such a way as to show that any of them formed sub-groups. A common and convenient geographical distribution is into the Western group, Polabian (formerly spoken in North Germany), Polish, Sorbian (represented by the Wendish spoken in Lusatia), Czechish (spoken in Bohemia, Moravia, etc.), and the (South) Eastern group, Servian, Croatian, Slovenian, Bulgarian, on the one hand, and Russian, on the other. Literary fragments go back to the eighth century. In the (narrower) Baltic division, however, a catechism of the sixteenth century represents the oldest known form of the dialect.

INNER RELATION. Having thus sketched the geography of these parts of the Indo-European languages, we must next inquire whether any of these parts hold to each other especially close relations. Much that here seems obvious shows itself to be misleading. Thus Latin is often regarded as standing in a peculiarly close relationship to Greek. In point of fact, however, while the Greek and Latin literatures are closely connected, there is no special kinship of the two languages. To detail all the groupings by subdivisions that have been urged by different scholars would take too much space, but the most practical historical differentiation is based on the varying treatment of the gutturals and vowels. In Hellenic, Italic, Celtic, and Teutonic, *k* and *q* represent the *ś* and *k* of the Eastern languages. The Sanskrit tenuis is preserved in the Western group, but the media and aspirate are modified to *j* and *h* (confused with the palatal evolution). The Western group had a pure *k* instead of the *ś*-

series, and *q*-sounds (tending to become labials) instead of the *k*-series. Examples of the *k*-series are Hellenic *ἐ-κατόν*, Italic *centum*, but Indic *śatam*; *δχος*, wagon, but Avestan *vazaiti*; of the *q*-series, Italic *quod*, Indic *kad*. In vocalism the Eastern group has a simpler series than the Western. Now between these extremes lies the Balto-Slavic (and in part the Anatolic) system, which agrees with the Eastern group in having the *ś* and *k* series (as against the *k* and *q* series), but with the Western group in its more varied vocalism. There are no divisions of the languages which are of so marked a character as these of the '*śatam*' and '*centum*' divisions. Latin stands near to Celtic in some forms (future and passive), but near to Sanskrit in others (e.g. the ablative). So in other aspects of morphology, Balto-Slavic, Sanskrit, and Greek are akin, while in others they stand apart, and such resemblances and divergencies are found among the other languages as well. What the inner relation may have been cannot be more nearly established by a comparison of forms, still less of vocabulary, and it seems safest to establish as sub-groups only Eastern (Middle) and Western divisions. That Indic and Iranian lie so closely together may be due rather to their closer synchronism than to an originally greater similitude.

Before proceeding with the discussion of the inner relationship of these groups as shown by sounds, forms, and syntax, it is necessary to revert to the question of the primitive language, which, as was shown above, occupied so large a share of the attention of Schleicher. Since his day the problem has assumed a new form which may be studied under two aspects, geographical and dialectal. It was the opinion of the older Sanskritists that the earliest home of the Indo-Europeans was on the Pamir tablelands. Other sites have been assumed, the plains of Europe, Scandinavia, and many other centres. But on the basis of a comparison of the common vocabulary of all the languages and the state of culture represented by it, present opinion, induced largely by the results of Schrader's studies, inclines to the belief that the original home of the Indo-Europeans was on the plains north of the Carpathian Mountains. A very important contribution to the question was made by Schmidt, who tried to show that the duodecimal system of the Indo-Europeans was derived from Semitic sources. The discovery in 1902 of the Arzawa Letters (see above) would strengthen the belief in an early intercommunication between Indo-Europeans and Semites. These data, if accepted, would show that the Indo-Europeans at a very early period were near neighbors of the Semites, and perhaps in close communication with them. Further, it is known that trade communication between the north of Europe and the southeast, possibly Semitic, took place at an early date, and, finally, it is scarcely to be doubted that Indo-European language and Indo-European race are not terms implying an identity of race and language. In short, language proves nothing with regard to race. This truth leads to a clearer insight in regard to the 'parent speech.' Instead of imagining that there was a racial unity once marked by linguistic unity, we must inquire whether, in giving up racial unity as shown by language, we must not also renounce all attempts to establish a former linguistic unity. The answer will un-

doubtedly be an affirmative, and it is rendered more probable by all that we know of modern languages. The German dialects, for example, show no trace of ever having been identical in form. Still more striking is the illustration given by Slavic as compared with Baltic. In a word, there was no parent speech of the Indo-Europeans; but there were always related dialects. (See DIALECTS.) Thus the smallest dialect, geographically speaking, of Greece or Rome, may preserve forms as ancient as any other. The idea of a language-unity splitting up into dialects and these again into sub-dialects is a false conception. Co-dialectic forms is the only right expression. All efforts made to trace out a parent speech are based largely on doubtful data of the use of words regarded as original, although we do not know whether the words may not have been borrowed. All reconstructions of the parent speech, whether in the form of literature (such as Schleierher indulged in) or in the form of reconstructed hypothetical words, which are supposed to represent the sound of the *Ur-sprache* and are constantly employed in our comparative grammars, are pure fictions of the imagination, and are not to be regarded as representing an actual prehistoric condition of the language. We know the Indo-European languages only in dialectic form, as spoken by various races over a wide area. The dialects are divarications from each other, not, so far as we know, from any unitary parent speech. A universal parent speech is an historical possibility, but an Indo-European parent speech is merely a convenient hypothesis, which, however, leaves more to be explained than it explains, and may best be discarded, however pleasing it be to the mind which prefers unity.

PHONOLOGY. The regular interchange of certain sounds in the different languages of the Indo-European group was generally postulated at an early period without the later insistence on the necessity of regularity. At first it seemed as if there were exceptions which could not be explained by any law. The sounds first compared were consonantal, as these seemed most regular. Their correspondence in certain of the Indo-European languages was formulated by what is known as Grimm's law (q.v.).

The vowel-system took longer to explain and the consonantal system required modification. In the case of the vowels, apart from the determination of the long disputed point whether the *a*, *ε*, *ο* of the Greek, or their equivalents in one *a*-sound, as in Sanskrit, represented the older state, the vowel-system was seen to be more regular as soon as the primitive existence of sonant nasals and liquids was recognized. The chief modifications of Grimm's law and further contributory laws were established during the last quarter of the nineteenth century. At the same time was raised the question in regard to the original vowel-form of roots and that of its changes in *Ablaut* or modified vowels and diphthongs.

The priority of the Western *a*, *e*, *o*, as compared with the Asiatic monotone *a*, was proved by Amelung and Brugmann at about the same time. Next was shown the existence of an Indo-European *e*, that is of a real palatal vowel, in Sanskrit itself. This was proved by Collitz, and independently by Verner, through demonstrating that when a Sanskrit *a* (= *e*) follows a guttural it palatalizes it and hence must itself be palatal.

Thus Sanskrit *ca* = *τε*, *que*. Osthoff and Brugmann, again, pointed out the existence in Greek of the Sanskrit *l* and *r* vowels, as shown e.g. in *παρρῶσι* (= Sk. *pitṛṣu*), *ἔδρακον*, etc. Then, as opposed to the view of the Hindu grammarians and early European scholars, it was shown that in the series *i*, *e*, *ai*, the simple vowel is no more radical than is the *guna* form, *e*, *ai*, or, in other words, we cannot speak of the stem in *φένγω*, to take an analogons case, as being less original than that in *ἔφνγω*.

The chief modification of Grimm's law was made in 1875 by the complementary law of accent, which goes by the name of Verner's law (q.v.).

In discussing consonantism, the designations of other than the guttural series are self-explanatory, but in the guttural series there is great confusion of nomenclature. Thus the Indo-European languages had palatal sounds, *c*, *j*; dentals, *t*, *d*; labials, *p*, *b*, both aspirated and non-aspirated. So they had aspirated and non-aspirated, surd and sonant, gutturals, *k*, *g* (*kh*, *gh*). But these latter, being, as explained above, of twofold form, have different designations. There are two series, the palatal and non-palatal guttural series. These are sometimes distinguished as palatal and velar, but the former is also called the *ś*-series, and even the *k*-series; while the latter is called the *g*-series and also the *k*-series. The velar *k*-series was from the beginning distinguished from the palatal guttural by being a sort of back guttural, with a tendency to develop a half-vowel sound (*q^u* or *k^u*), which was lost in special languages. The two sounds either united or the guttural became more labialized, Sanskrit *ka*, Latin *quo*, Gothic *hva*, a tendency that reached an extreme in Greek, where this guttural is often represented by a labial, as in *πo* (also before nasals and liquids), though sometimes dentalized, as in *τε* (before *ι*, *ε*), while sometimes coinciding with *k* (*κῶς*). Besides gutturals and palatals, the Indo-European group possessed the consonantism just described, but it was defective in friatives and spirants (e.g. *f*, English *th*, *z*). Peculiar to the older language are the aspirated sonants retained in the Indo-Iranic group beside aspirated surds, as well as the modified nasals and sibilants, *n*, *s*, including *ñ*, the final half-nasal, and final half-sibilant. As already explained, Indo-European had as half-vowels *y*, *v*, *l*, *r*. Lingual sounds (found in Sanskrit) appear to be borrowed from the Dravidians.

Before passing on to the subject of morphology it will be necessary to speak of one of the most important topics discussed, though not definitively settled, in the last few years. Verner showed that accent or stress influenced the character of consonants according to the accentuation of the syllable. The effect of stress, however, as already explained, is also patent as regards the vowel, which, as in *οἶδο*, *ἴδμεν* (originally *ἴδμες*), shifts with the accent. But of late it has been shown that another very important law of accentuation has been at work in determining the form of stems. Fick and Möller have emphasized the importance of pitch, that is, musical accent, as contrasted with stress accent. They show that there is a certain relation between the palatal vowel and a high pitch, and a guttural vowel and a low pitch, a relation explicable on physiological grounds; the action of the vocal or-

gans naturally associating the high pitch with the palatal *e* and the low pitch with the guttural *o*. Thus there is a natural connection between the accent or non-accent and the form of the two vowels in λέγω, the *e*-vowel having the high pitch, the *o*-vowel having the low pitch. This matter has not yet been thoroughly investigated, and there are many phenomena not yet explained by it. For example, in λόγος the low pitch has the stress. But at all events, accent is evidently a factor which will, when properly understood, explain much in stem-formation.

MORPHOLOGY. This studies change of form and the cause of change. The chief factors tending to change the form of words are 'phonetic degeneration,' as it used to be called, or phonetic variation and growth, due partly to individual peculiarities, but more to the attrition of speech, force of expression, the law of least resistance, and the interaction of the individual and his environment. Change of stress and change of pitch and the substitution of stressed accent for pitch affect the form as well as the accent of words. Analogy (q.v.), especially false analogy, causes changes, in the endings particularly, and the growth or change of function in one class of words is liable seriously to affect the form and even the existence of words of another class. Imitation due to association may be conscious or unconscious. Complete changes in the pronunciation of a vowel may occur over a wide area in a short time and then remain, or as suddenly disappear. Most of these changes of form are the result of a long series of gradual minute alterations, intervening in time, both in phonetics and in morphology. Difference of meaning may be mentioned last as having had effect on form, a factor more or less connected with accent. Apart from these questions of the philosophy of change, morphology has to do with the forms as presented in language, which may most conveniently be discussed under the head of roots (see Roots), stems, the forms of nouns, and the forms of verbs.

In regard to the stem-complex of root and ending, apart from a vague theory of Westphal that 'near' and 'distant' sounds have something to do with stem-formation, only one theory has been opposed to Bopp's agglutination theory. This is a profound study by Ludwig, marred only by the assumption of absolute lawlessness in phonetics. The points made are that the endings serve different purposes, a first person serves as third, a locative as a genitive, etc., and the further back we go the looser is the language. Ludwig substitutes for agglutination, therefore, the theory of adaptation. Verbal endings are not from pronouns; no personal endings existed; before the verb was the indefinite infinitive used for any person, any tense, and both imperative or indicative in meaning; suffixes acquired definite implication by a gradual adaptation of special meanings, having originally only a demonstrative sense. While containing much truth, this adaptation theory is too exaggerated to be acceptable as a working hypothesis. Another theory, that of Scherer, regards endings of stems of verbs and nouns as indicating a locative sense, while Benfey traced all endings from *anti* (believing that nouns are from verbs); but the two latter views are too fantastic to be discussed.

FORMS OF NOUNS. The same word is noun and verb in its most primitive form, as Sanskrit

dāti, 'a giving' or 'he gives.' Nouns had seven cases, perhaps more, in Indo-European. The same case had different endings, but, on the other hand, it is most likely, despite the fact that this seems to point to other cases, that, had such cases existed, some traces would have been preserved. Different endings may gradually have become restricted in application, and, as in the case of the Greek dative, different functions may have been absorbed by one ending, tending to a loss of another ending. The seven cases have endings more or less uniform, but apart from modifications caused by the form of the stem, some cases are compounds of two case-endings and some cases show different forms according as a word is declined as noun or pronoun. The seven cases are nominative, accusative, instrumental, dative, genitive, ablative, locative. They are found in the singular, dual, and plural, but except for the nominative and accusative dual in *āu* (*dr-āu*, *duo*) the dual endings are not identical in the different languages and are omitted here. The vocative is not a case, but the bare stem in weak form. An apparent ending in the *o*-stems is only a vowel-weakening. The chief endings are:

Nom. sg., *s, m*; pl., *os (es)*, (*o*)*i*, [*ā*].

Acc. sg., *m, d*; pl., *ms, ā*.

Instr. sg., *e, a, bhī (mī)*, *na*; pl., *bhis, o-i-s*.

Dat. sg., (*ai*), *e, bhya (m)*; pl., *bhyas*.

Gen. sg., (*o*)*s, sia*; pl., *om (ām)*, *sām*.

Abl. sg., [*os*], (*a*)*t*; pl., *bhyas*.

Loc. sg., *i*; pl., *su (si)*.

The ablative is lacking in the singular, except in a few nouns and pronouns, and in the plural, borrowing the forms of the genitive singular and dative plural. The plural *os (as)* is the noun-ending in Sanskrit; *ai (oi)* the pronoun ending in Sanskrit and Oscan and the noun ending in Slavic, Greek, Latin, Celtic, and Gothic. As plural signs serve both *i* and *s*, the latter being added to the nominative, accusative, instrumental, and dative. Some endings were independent words, e.g. *i, u, a, āt*, and Sanskrit still has cases made by adding *ā* to *ē*. Adjectives have noun endings (with some restrictions). The comparative *tara* means 'farther' (also *ias, ios*). The superlative, *tata, tama*, and *ishta*, is not clear. Numerals have essentially the same form in Indo-European. *ai-ka (oīnas)*, *duā, tu, śatam-centum*, up to *Χίλιαι* = (*sa*)*hasra*, though the latter identification is doubtful, and in any case may mean 'heap,' or large number, rather than a definite thousand. The duodecimal system is clearly marked in Sanskrit higher numbers alongside of the decimal system (see above). Particles are part of the noun-system and the stems end in *ta, na, m (ā)na* in Sanskrit, Avestan, Greek, and Latin. Prepositions (adverbs) may have case-endings, e.g. *παρα-ί, παρά, πρόσσω*.

FORMS OF VERBS. The Indo-European languages had four tenses, present (imperfect), aorist, perfect, future, and four modes, indicative, subjunctive, optative, and imperative. Only the first three tenses are pure, the future being modal (will), and consequently the future is found only in the indicative, with rare (Vedic) and late (Greek) exceptions. There are two voices, active and middle, the latter serving originally as a passive as well. Secondary conjugations of the pro-ethnic period are numerous. The most clearly defined are causative, denominative, intensive, desiderative, and inchoative. Sanskrit further invented a passive class, and Latin

and Celtic had a special passive voice, while Greek and Sanskrit converted certain aorist forms into passives. There are three numbers, but the dual is weak and even in the oldest Vedic and Greek interchanges with the plural, being lost in Celtic and Latin (save for the ending *-tis*), though preserved in Gothic and Balto-Slavic. Verbal endings are primary and secondary (present and preterite); special endings occur in the perfect. Omitting the dual, these endings in Sanskrit, which has preserved them most fully, are in the active singular, 1, *mī, a;* 2, *si, tha;* 3, *ti, a;* plural, 1, *mas ma;* 2, *tha, a;* 3, *a(n)ti, us;* while the middle changes *i* to *ē* and *mas, tha,* to *mahē, dhvē,* and the preterite tenses drop the final vowel and have *mahi, dhram,* for *mahē, dhvē.* The preterites and the perfect have also certain *r*-forms, *ram, rē,* etc., like the Latin passive. The present stem is divided into many classes, of which ten are recognized by native Sanskrit grammarians. Including secondary conjugations, the Indo-European languages had in all thirty-two ways of varying the stem by infixes, suffixes, and changing the vowel of the root. Many of these verbal stems coincide with nominal stems. They appear originally to have indicated modified forms of action. The aorist stem is formed either by reduplication, like the perfect, or by inserting an *s*-element, like the future, or it may be differentiated from the present class merely by the vowel or by an ending (*βῆ, βάσκω*). The future has primary endings, but in Sanskrit may be augmented with preterite endings, making a conditional. The subjunctive and optative have different formative elements and their endings are originally the primary and secondary, respectively (see below), while the imperative has preterite endings modified, or special forms. It has no modal sign. In some classes of verbs the subjunctive form coincides with the indicative. Hence *ā,* the subjunctive modal sign, Greek *η,* is not locative, as Scherer taught, but probably due to analogy. The optative sign is *ia* when accented, *i* when unaccented, as shown by J. Schmidt; whence *i* is probably a reduction from *ia* (compare *yā,* 'go,' though this derivation is not favored by Schmidt).

As to the personal endings, with the exception of the third plural (and the dual), Delbrück thinks that they are connected with the personal pronouns, but if so they must go back to a period when they were more deictic than pronominal. The singular affixes *mī, si, ti* have been explained (not very convincingly) both as taken from the pronouns and as having originated the pronouns; but the plural *anti* is probably connected with the participle, the *i* being explained by Ascoli and Brugmann as due to analogy with *tī* (a locative in Scherer's opinion). This finite verbal form would then be analogous to *amāmini* (also a participle). The middle endings have been explained as strengthened forms. In Sanskrit the only original strongest form is *āi* (*sāi* and *tāi* being later), a still stronger form of *ē,* which lends color to this (still doubtful) suggestion. Verbal stems were originally not connected with prepositions (most of which are adverbs); hence Latin compound verbs are later than Greek and Sanskrit, and 'tmesis' in the latter is really the older form. New forms have been developed in the separate language, e.g. aorist passives, the future optative and future

infinitive in Greek; a third singular preterite aorist passive and a complete *ya*-passive in Sanskrit; *r*-passive and *bo*-future in Latin and Celtic. Greek, like Sanskrit, is older than Latin in having fuller endings, a middle voice, and an augment. The other Indo-European languages have later verbal forms. The augment may have had a short and a long form, *ε, η,* and survived in Sanskrit, Persian, and Greek, with traces in Avestan.

SYNTAX. Only the chief points can be noticed here. First, as to the syntax of nouns: The old distinction between grammatical and non-grammatical cases cannot be maintained. The nominative designates the active, the accusative the passive relation. The latter is both an object of a verb and an object of thought, *this day, me miserum,* non-verbal objectifications. With space and time the accusative is still a veiled object-case. The instrumental shows accompaniment, means, limit; the dative, 'to' or 'for'; the genitive, any adjectival relation, 'of,' 'belonging to;' the ablative, source and means, 'from,' 'by;' the locative, place or time, 'in,' 'at,' 'within.' The syntactical method of Delbrück assigns to each case a certain narrow function; as either 'in' or 'within' (but not both) to the original locative; 'to' or 'for' (but not both) to the dative, etc. But each (pure) case originally contained in itself all that is ascribed to it; the dative from the beginning was a 'to' and a 'for' case; the locative expressed both 'at,' 'in,' and 'within.' The instrumental survives in adverbial form in Greek, but the Greek dative singular is a locative. The genitive in *sia* is an adjective stem like that of the pronouns, *asmāka(m), nostrum, nostri,* which explains in part the syntax of the case. So the Latin *i*-genitive may be adjectival (preserved in other Italic dialects instead of changing to *oi* or *ei,* which would be the locative form). Other genitive syntax is explained as being due to a sort of adjective-compound effect, in that the sign *as* (*os*) is probably only a nominative affected by sentence accent. So *s* is the sign of the nominative as well as of the genitive. The ablative was probably confined at first to the singular pronoun, where it seems to be from an adverbial affix. Such syntactical growths are common, prepositions (adverbs) being affixed also to completed endings to emphasize the meaning, as *in* is added to the Italic locative, *ā* to the Avestan locative, or *i* to the Latin feminine nominative, *qua-i* (*quæ*). In the last case the meaning is probably only emphatic, just as in English *yes-sir-ee, indeed-y.* The nominative *s* has been associated with the demonstrative pronoun. The *m* of the accusative is identical with the *m* of *aham, idam, ἐγών, idem,* though what shade of meaning it may have had is as impossible to explain, as is the pseudo-ending of the German *mi-ch.* The neuter nominative in *m* has been explained as borrowed from the nominative, on the ground that neuters were originally not subjects of verbs; but this is improbable.

In verbs present tense-stem connotes durative time; the aorist, unrestricted time, either inchoative or resultant; the perfect, repeated present (inchoative or intensive); the future, modally affected future (will). The subjunctive gives the idea of the unrestricted indicative with the addition of a shall or will element (time and mode); the optative expresses

should or might; the imperative, a command. The aorist may be present or preterite in time and differs from the present-stem meaning only in its quality, since it does not express continued or durative time. Thus Sanskrit *gacchati*, present, is 'he continues a-going,' but *gāti*, aorist, is 'he goes.' The present may thus do duty for a future, as in Gothic. The verbal stem being coincident with the noun-stem, the sense of *bharati* is really 'a bearing, that' or 'he is a-bearing,' rather than 'is a bearer.' The reduplication of the perfect connects it with the reduplicated present, desiderative, and intensive forms, and in its first application it connotes present time, afterwards extended to past time, perhaps helped thereto by the pluperfect (with augment), which in Sanskrit is not so much a pluperfect as a reduplicated aorist. The tense of narrative was originally the imperfect, not the aorist. The syntax of the Greek aorist is complicated by the confusion of aorist and imperfect forms. In Sanskrit, future (will and pure future) and optative complement each other and eventually suppress the subjunctive altogether.

The subjunctive, as already stated, has originally primary, the optative secondary endings; but in Sanskrit the former has taken some secondary endings, and in Greek the latter some primary endings. These endings are significant. The optative goes with the imperative and injunctive, modes of wish and command; the subjunctive with the future, shall and may. Delbrück believes that the subjunctive originally expressed will, the optative wish. But his categorical system of syntax is unable to explain the potential sense of the optative and the future sense of the subjunctive. The subjunctive originally connoted a vague shall-will, at the pleasure of the speaker. The primitive subjunctives, *ἔδομαι*, *ero*, are, in fact, simple futures. So the optative expressed both should and might. In Latin the subjunctive is partly optative. The Homeric subjunctive is later limited to half of its functions. Sanskrit has a distinct precative optative to express wish. Here, as elsewhere in grammar, linguistic machinery of a rough sort was slowly adapted to growing needs, and many shades of meaning were expressed under one form. Vulgar English shows continually how people without discrimination get along very comfortably with the same tense and mode and ending for many situations. In regard to the imperative, which has secondary endings, it was originally used only in the present and for commands, not for prohibitions. Hence *μή* is used with the subjunctive aorist, and later with the present imperfect only as an extension. So a subordinate negative clause takes *μή*, as *ὅς μή* *ἔλθῃ*. ('shall not come'). Thence the use was extended (*εἰμή* with indicative). Some scholars claim that the optative was originally potential, for the pure optative is used with *οὐ*, not with *μή* (for wish). It is worth noticing, in connection with the Greek secondary endings, that when used without augment they may always indicate a command, as in the Sanskrit injunctive, which is an unaugmented preterite.

The determination of the meaning of cases, of tenses, and of moods does not exhaust the store of syntactical problems upon which light has been thrown by comparative philology; but these are the most important aspects and they show sufficiently what has been accomplished. The dis-

covery of new cases (instrumental and locative) in Sanskrit, not recognized in the classical languages, laid the basis for a thorough treatment of case-relations; as the discovery of the injunctive and the Vedic values of subjunctive, optative, aorist, and perfect first clarified the problems connected with the verb.

MODERN TENDENCIES. A typical example of the relation between the stages of growth in the study of philology is given by etymology (q.v.). Before Pott there was an utter want of scientific method. Pott opposed this looseness. Curtius again opposed Pott for thirty years on the ground that Pott was not strict enough. The "young grammarians" in their turn attacked Curtius because he refused to admit that phonetic law is irrefragable.

More recent studies have made etymology much stricter still. To cite a famous example, of all the parallels in the names of Greek and Hindu gods utilized by Müller in his mythological studies, only one case, Dyaus-Zeus, is now regarded as certain. On the other hand, in the question of irrefragable phonetic law, the modern tendency has been to claim that the new school went too far. Bechtel, in 1892, and since then other scholars have questioned the validity of the shibboleth of 'changeless law.' Other doubts have arisen in the last decade on other fields. Stress accent has been replaced in part by musical accent in importance. Schmidt's wave theory has been modified. Semitic influence, as shown in numbers, has been replaced by a putative Dravidian influence, but this matter is unsettled. In geography, Lycian and Carian have been definitively removed from the field of the Indo-European languages. The importance and antiquity of Pali (q.v.) has been brought to the fore. The possibility of reconstructing a 'parent language' has been rendered quite doubtful. Syntax has virtually been built up by one great German scholar, Delbrück. It was the latest task of philology. Naturally the principles thus swiftly built into a system by one man are open to revision. Signs are apparent that the categorical method hitherto employed has ceased to be useful in helping to discover the genesis of syntactical change. Delbrück himself has admitted that his results are founded chiefly on subjective impression. Other scholars question, not the value of the facts amassed by Delbrück, but their interpretation, in criticism that began with Whitney and has tacitly been accepted by Brugmann, Speyer, and other interpreters of syntactical data. In like manner the motive of phonetic change as explained by Delbrück has recently been attacked by Wundt, Meyer, and Oertel, who have respectively sought to show that phonetic change depends largely on ease (or speed), strength of expiration, and geographical environment.

But besides laying stress on new points of view of minor importance, such as haplography, philology has recently brought to the fore one principle and elevated it into the dignity of a new branch of the study under the name of semasiology (q.v.). In 1897 Bréal published his *Essai de sémasiologie*, which organized into a systematic whole, under different categories, transfers of meaning in the evolution of words. Contiguity, resemblance, and contrast were shown to cause changes of meaning. Our word 'pike' for 'road,' for example, arose from 'turn-pike road,' with a gradual reduction of the

phrase to its most characteristic element (the pike or pole which turned the stile at a toll-gate) to represent the whole.

BIBLIOGRAPHY. Brugmann and Osthoff, *Morphologische Untersuchungen* (Leipzig, 1890); Brugmann and Delbrück, *Grundriss der vergleichenden Sprachwissenschaft* (Strassburg, 1886-1900); Curtius, *Grundzüge der griechischen Etymologie* (Leipzig, 1879); id., *Kritik der neueren Sprachwissenschaft* (ib., 1885); Fick, *Vergleichendes Wörterbuch der indogermanischen Sprachen* (4th ed., vols. i. and ii., Göttingen, 1891-94); Leskien, *Die Declination im Slavischen, Litauischen und Germanischen* (Leipzig, 1876); Ludwig, *Agglutination oder Adaption* (Prague, 1879); Paul, *Prinzipien der Sprachgeschichte* (3d ed., Halle, 1898); Delbrück, *Syntaktische Forschungen* (ib., 1871-88); J. Schmidt, *Pluralbildungen der indogermanischen Neutra* (Weimar, 1889); Schrader, *Sprachvergleichung und Urgeschichte* (Jena, 1890); id., *Reallexikon der indogermanischen Alterthumskunde* (Strassburg, 1901); Max Müller, *Lectures on the Science of Language* (revised ed., New York, 1891); Whitney, *Life and Growth of Language* (ib., 1875). For the history of the study, consult: Benfey, *Geschichte der Sprachwissenschaft* (Munich, 1869); Steinthal, *Geschichte der Sprachwissenschaft bei den Griechen und Römern* (2d ed., Berlin, 1889); Delbrück, *Einführung in das Sprachstudium* (3d ed., Leipzig, 1893); Wheeler, *Introduction to the Study of the History of Language* (New York, 1890). Excellent manuals are: Henry, *Précis de grammaire comparée* (Paris, 1888); Brugmann, *Griechische Grammatik*; Stolz, *Latcinische Grammatik*; Schmalz, *Latcinische Syntax* (the last three in Müller, *Handbuch der klassischen Alterthums-Wissenschaft* (3d ed., Munich, 1900). Consult also: Wackernagel, *Altindische Grammatik* (Göttingen, 1896, incomplete); Speyer, *Sanskrit Syntax* (Leyden, 1896); Franke, *Pali und Sanskrit* (Strassburg, 1902); Gray, *Indo-Iranian Phonology* (New York, 1902); Pischel, *Grammatik der Prakrit-Sprachen* (Strassburg, 1900); Bréal, *Essai de sémantique* (Paris, 1897; translated with an introduction by Postgate, London, 1900); Van Wijk, *Der nominale Genitiv-Singular* (Leipzig, 1902); Knudtson, *Die zwei Arzawa-Briefe* (ib., 1902); Wechsler, *Giebt es Lautgesetze?* (Halle, 1900); Wundt, *Völkerpsychologie* (Leipzig, 1900); Morris, *On Principles and Method in Syntax* (New York, 1901); Oertel, *Lectures on the Study of Language* (ib., 1901); Delbrück, *Grundfragen der Sprachforschung* (Strassburg, 1901); Wundt, *Sprachgeschichte und Sprachpsychologie* (Leipzig, 1901); a reply to the last, Delbrück, *Das Wesen der Lautgesetze* (ib., 1902); and Meillet, *Introduction à l'étude des langues indo-européennes* (Paris, 1903).

PHIL'OMEL (Lat., *philomela*, from Gk. φιλολήλα, nightingale, from φιλῆν, *philein*, to love + μέλος, *melos*, melody). A nightingale, especially the Persian one. See NIGHTINGALE.

PHIL'OME'LA (Lat., from Gk. Φιλομήλη). In Greek mythology, a daughter of Pandion, King of Athens, and sister of Proene. In reward for assistance rendered, Pandion gave Proene as wife to Tereus, King of Thrace, who became by her father of Itys. He then dishonored Philomela, pretending that Proene was dead, and to prevent her from telling her wrong cut out her

tongue. Philomela, however, by weaving words in a robe, revealed the truth to Proene, who, to punish her husband, killed her son and served him up to Tereus. The sisters then fled, but, being pursued by Tereus, were changed into birds; Proene and Philomela to swallows or nightingales, while Tereus became a hoopoe or hawk.

PHILOMELA, THE LADY FITZWATERS' NIGHTINGALE. A romance by Robert Greene (1592). It is founded on an Italian story of jealousy, perhaps *Tito and Gisippo* in the *Decameron*. Philip charges a friend, Lutesio, to test his wife by tempting her. Though innocent, Philomela is divorced and flees to Palermo, where her repentant husband discovers her, but his joy is so great that he chokes and dies.

PHIL'OPÆ'MEN (Lat., from Gk. Φιλοποίμην, *Philopoimén*) (B.C. 252-183). The most illustrious statesman and general of Greece in the period of her decline, the great object of whose life was to establish the independence of his country on a firm and lasting basis. He was born at Megalopolis, in Arcadia, of a noble family. At an early age he lost his father, and was brought up by a wealthy citizen of Mantinea named Cleander, who secured for him a careful education. He received instruction from the academic philosophers Eodemus and Demophanes. His first experience in warfare was gained in the border raids which took place between the Arcadians and Laconians, and in B.C. 222 he with a few others defended Megalopolis against the attack of the Spartan King, Cleomenes. In the following year, when the Macedonian King Antigonos came to the assistance of the Achæans, Philopæmen joined him at the head of a band of horse, and distinguished himself in the battle of Sellasia (B.C. 221), in which the power of Sparta was completely broken. Philopæmen now went to Crete, where he lived for several years; on his return in 210 he was appointed commander of the Achæan horse, and in the expedition of 209 against Elis distinguished himself for his bravery, slaying with his own hand the Elean leader, Demophantus. In 208 he was chosen strategus or commander-in-chief of the Achæan League, a position which he held eight times in all. He at once proceeded to introduce reforms into the discipline and armor of the soldiers, and soon, by these means and by his personal influence, made the army a most effective instrument of war. In 207 he utterly defeated the Spartans under Machanidas, and at the Nemean festival which followed he was proclaimed liberator of Greece. In 201 he defeated Nabis, who had succeeded Machanidas as tyrant of Sparta, and soon afterwards made another voyage to Crete. Returning to the Peloponnesus in 194, he was appointed strategus in 192, and again defeated Nabis. Shortly after he compelled Sparta to enter the Achæan League, and when she revolted in 188 he took the town, razed the walls, and compelled her to adopt the Achæan laws. He was in his seventieth year and sick in bed when news was brought him that the Messenians had revolted from the League; he immediately left his bed and took command of the army. In the battle that ensued he was taken prisoner, and Democertes, the Messenian commander, sent him a cup of poisoned wine, which he drank. Consult: Plutarch's *Life of Philo-*

pæmen; Freeman, *History of Federal Government in Greece and Italy* (2d ed., London and New York, 1893); Mahaffy, *Alexander's Empire* (New York, 1888).

PHILOSOPHER OF FERNEY. A title given to Voltaire, from his Swiss residence.

PHILOSOPHER OF MALMESBURY. A title conferred on Thomas Hobbes, from the name of his birthplace.

PHILOSOPHER OF SANS-SOUCI, sän soo'sé'. A title applied to Frederick the Great.

PHILOSOPHER OF WIMBLEDON. A name used of John Horne Tooke, from his residence in Surrey.

PHILOSOPHER'S STONE, THE. A mysterious compound to which was attributed the power of transmuting metals into gold or silver, and the attempted making of which was the chief occupation of alchemists, at least during the Middle Ages. In reality it bore no resemblance to a stone, being more properly described as an amalgam. It was a universal panacea that was so eagerly sought, for with the function of a universal solvent it combined that of the elixir of life, a renewing influence on the body. The conception of the transmutation of metals was Oriental. The Arabs regarded metals as compounded of mercury and sulphur in varying proportions. To this was added a more philosophic conception of a common basis of all forms of matter, individual forms being due to a force separable from this. If the 'materia prima' could be dissolved from the combining forces and united with the special 'form' of gold and the combination could be controlled, then any bodies could be produced at will. Three forms of the philosopher's stone are mentioned—the great elixir, a red tincture transmuting metals into gold; the elixir vitæ, restoring youth and prolonging life; and the lesser elixir, a white tincture, changing metals into silver. The powers of the philosopher's stone appear to have been first described by Zosimus in the fifth century. Geber (q.v.) was the reputed author of the *Key of Wisdom*, a secret book on the philosopher's stone. The matter was generally shrouded in mystery and not clearly defined until the twelfth century. Salt, sulphur, and mercury, regarded as the elements of matter, were combined to produce the solvent. By the sixteenth century the formula of preparation become more definite. The 'mercury of philosophy,' combined with gold, was placed in a furnace where the gold was dissolved. After a long interval a black powder, called Saturn, was produced. A further heating produced the white tincture, or little philosopher's stone, and a hotter fire produced a red powder, the true stone. Van Helmont asserted that he had seen and handled the stone, which was sulphur-color, heavy, and brilliant as glass. Paracelsus described it as a solid of deep ruby color, transparent, flexible, and brittle as glass; Raymond Lully, as a carbuncle. After the thirteenth century a mystic and esoteric interpretation of the philosopher's stone seems to have been applied to morals, the stone bringing to the wearer wisdom and virtue, and purifying the soul.

PHILOSOPHICAL SOCIETY, AMERICAN. The oldest of American learned societies. Its official name is the American Philosophical Society,

Held at Philadelphia for Promoting Useful Knowledge. Its hall is No. 104 South Fifth Street, Philadelphia, in which are meeting and banquet rooms, an extensive and valuable library, many interesting portraits and busts, one of the latter being Houdon's Franklin, and a collection of relics, including the chair used by Jefferson while writing the Declaration of Independence. In 1893 the society celebrated the sesqui-centenary of its beginning, for on May 14, 1743, Benjamin Franklin published in Philadelphia "A Proposal for Promoting Useful Knowledge among the British Plantations in America," and though his suggestions were not acted upon immediately, he wrote on April 5, 1744, that the society had been formed and had held several meetings, with Thomas Hopkinson as president and himself as secretary. Within a few years regular meetings were discontinued, though before 1758 another society was started in Philadelphia, called the Junto, or Society for the Promotion of Useful Knowledge, which also languished until April 25, 1766, when it was revived, with thirty members, as the American Society for Promoting and Propagating Useful Knowledge. The earlier society renewed its activity in November, 1767, and the union of the two was suggested, but a year was spent in negotiation before the two became one on January 2, 1769, adopting the present name and electing Benjamin Franklin president. He held this office until his death in 1790. The second president was David Rittenhouse, the astronomer and the first director of the United States Mint, and he was succeeded by Thomas Jefferson. In 1785 John Hyacinthe de Magellan, of London, presented two hundred guineas to the society for a perpetual fund, the interest each year to be put into a gold medal, to be given to the author of the best discovery or improvement in navigation, natural history, or astronomy. The Magellanic fund has always been kept as a separate investment, and its medal is considered one of the great honors in the scientific world. Membership in the society is limited to those who are invited to join on account of their contributions to science and knowledge; consequently the honor of an election is highly prized by American scientists. In recent years the society has established a series of annual meetings, to which distinguished men of science of Europe are invited, and these assemblages have become events of international interest. The published *Transactions* of the society begin with 1771, in which year a copy was given to each member of the General Assembly of Pennsylvania, with the statement that "the volume is wholly American in composition, printing, and paper." The society also publishes *Proceedings*, beginning in 1833, issuing them in about two hundred parts, making over forty volumes.

PHILOSOPHY (Lat. *philosophia*, from Gk. φιλοσοφία, love of knowledge, from φιλεῖν, *philein*, to love + σοφία, *sophia*, wisdom, from σοφός, *sophos*, wise). A term originally used, e.g. by Socrates, to mean devotion to the pursuit of truth. In Plato it came to mean knowledge of eternal reality. Aristotle employed the term sometimes as equivalent to critical systematized knowledge, sometimes as meaning the science of ultimate reality. The Stoics considered philosophy to be the endeavor to obtain excellence

(ἀρετή, *aretē*) in knowledge and in morality; the Epicureans regarded the philosopher as the man who pursued happiness in the manner suggested by reason. In the Middle Ages philosophy came to be ancillary to theology, and in large measure the reasoned defense of divinely revealed truth. In modern times various definitions have been given, such as "rational knowledge derived from concepts as such" (Kant), "the revision of concepts" (Herbart), "the science of principles" (Ueberweg), "the totality (*Inbegriff*) of all scientific knowledge" (Paulsen), and "the reduction of the general knowledge obtained by the special sciences to a complete system" (Wundt); while some thinkers have despaired of the possibility of finding any definition that shall cover the whole field historically occupied by philosophical speculation. The conception of the task of philosophy necessarily changes with the course of time. At the beginning, before any special sciences had arisen, it was natural that the unity of knowledge should be insisted on, and that the student should ambitiously take all knowledge for his province. But the scope of philosophy has gradually grown narrower as its original domain has been encroached upon by new sciences. The failure of philosophers of the present to agree on the definition of their work is due to the fact that so much territory has been already occupied by these sciences as to leave the proper domain of philosophy in doubt. These sciences have one and all been experiential in their method. To those who believe in the existence of *a priori* knowledge, a point of departure for delimiting philosophy from science is obtained in this distinction of the inductive from the deductive. But the belief in *a priori* knowledge is less current than it was a hundred years ago, and some other differentiation of philosophy from science must be undertaken by the inductivist. Perhaps no better plan can be adopted than that based upon the specialistic character of present-day science. Each science pursues its own investigations in its own limited field, and will allow itself to be prejudiced as little as possible by what is done in other fields. But after all it is the same universe that furnishes object-matter to all the separate sciences, and one would naturally expect that all the separate knowledges gained by specialists would articulate themselves into a coherent system of knowledge. The hope to accomplish this articulation in detail would be idle; but every science has its concepts, which it uses to organize the facts in its own little field. Do all the concepts tally? Are they compatible with each other? Questions of this sort are reasonable, and an attempt to answer them forms the so-called philosophy of nature, which may be defined as the correlation and criticism of scientific concepts. Among such concepts are those of matter, energy and its conservation, atom, life, evolution, differential, point, line, etc. The philosophy of nature is without doubt the most difficult branch of philosophy, as it demands for its prosecution considerable familiarity with the leading sciences. But while it is not to be hoped that any very general treatment of the subject can be satisfactory, still more detailed work in the way of correlation and criticism of the conceptions employed in a few sciences can be reasonably expected. Such work has been done in English by Stallo in

his *Concepts and Theories of Modern Physics* (London, 1882), and by James Ward in his *Naturalism and Agnosticism* (London, 1899).

Again, all the sciences take for granted that man can know something about the universe. What is this knowledge? Is it really valid, as it claims to be? Is there any way of ascertaining its validity? A scientific treatment of these questions is called epistemology, or the theory of knowledge (q.v.), and forms a second philosophical discipline. Still again, can any light be thrown on the ultimate nature of the reality either of the external world or of the mind? This is the problem of metaphysics (q.v.). Formerly logic, psychology, and ethics were considered as branches of philosophy, but the modern tendency is to establish them as separate sciences. This is accomplished, however, only in a restricted sense. At bottom the question whether this or that discipline is a science or a branch of philosophy is of no great importance, when it is recognized that there is no fundamental difference in method between science and philosophy, the only difference being one of degree, not of kind. The more abstract any systematic knowledge is, the narrower the field it appropriates to itself; the more it neglects other subjects lying outside of that field, so much the more properly is it called a special science. On the contrary, the more comprehensive such knowledge is, the more philosophical it is; for philosophy is an attempt as far as possible to know the world as a whole.

HISTORY. The history of European philosophy is commonly divided into three main epochs, each characterized by a unique development, although at the same time the earlier periods furnish preface and starting-point for those which succeed them, so that the whole development is continuous. The first of these periods is that of ancient or Greek philosophy (q.v.). It extends from the earliest formulations of philosophic conceptions among the Ionian philosophers and continues into the Christian Era, throughout the dominance of paganism. While shared by other nations of antiquity besides the Greeks, as notably by certain Romans, Jews, and Græco-Egyptians, it received its form and lasting bent from the Greek mind, and its later influence proceeds almost exclusively from Athenian culture. The second period is that of mediæval philosophy, or scholasticism (q.v.). It had its rise in the theological speculations of the early Church Fathers, usually educated in Greek thought, and was continued and developed throughout mediæval times as the characteristic philosophy of Catholic Christianity. It had its culmination in the great synthesis of Thomas Aquinas, but has never ceased to be the traditional philosophy of the Church, and in modern times, as neo-scholasticism, is the subject of an energetic revival. During the scholastic period in Christian Europe the tradition of Greek philosophy was kept alive by the Arabs in Spain (see ARABIC LANGUAGE AND LITERATURE), among whom were many important philosophical thinkers. The third period is known as the period of modern philosophy, and is commonly dated from the Renaissance (q.v.), and more particularly from the advocacy of empirical methods of investigation by Bacon and of appeal to immediate reason or intuition by Descartes.

With the revival of learning there was also a

revival of all the important philosophical systems of antiquity. Platonism flourished in the Academy of Florence and found its most important advocate in Ficino. Neo-Platonism blended with Neo-Pythagoreanism, which was represented by Pico della Mirandola. Aristotelianism renewed its vigor in the two rival schools of Averroism and Alexandrism, and among the Protestants in Melancthon. Skepticism was defended by Montaigne, Sanchez, and Charron; eclecticism, virulent in its opposition to scholasticism, was propagated by Valla, Vives, de la Ramée, and Zwingli, while scholasticism found its champion in Suarez. Natural philosophy, a rehabilitation of one phase of Aristotle's system, but blended with Neo-Platonic mysticism, was developed by Cardano, Campanella, and especially by Bruno. Paracelsus and Böhme elaborated the mystical side of this line of thought, while Galileo and Kepler remained more true to an empirical study of nature, and formed the starting point of a mechanistic and materialistic conception of the universe. In Kepler, however, with his insistence on the harmony of the world order, we have a distinctively Pythagorean touch. Political philosophy took an entirely new start with Machiavelli, who threw aside the work of Aristotle and the authority of the Church, and worked out an anti-moral theory in which the State and civic freedom were all-important. But though the philosophers of the Renaissance thus bridged over the chasm that separated the ancient from the modern world of thought, it was reserved for Bacon and Descartes to lay the foundations of modern philosophy in empiricism on the one hand and in rationalism on the other; and the real problem of modern philosophy has been to rear a superstructure which should rest on both these foundations. As was to be expected, the foundations had first to be laid independently, and as a result we have two great modern schools, each equally one-sided, but each equally standing for a fundamental truth—the one, the truth that all secure knowledge rests on experience; the other, the truth that in all satisfactory knowledge the demands of reason are met.

Modern empiricism came to articulate expression first in Francis Bacon, who insisted upon the abandonment of the deductive, *a priori* speculation of the schoolmen, and on the necessity of studying nature without bias. Hobbes followed Bacon in urging the necessity of a philosophy of experience; but being especially interested in human nature, and yet lacking the data for an inductive study of society, he allowed himself to construct society out of imaginary isolated human beings and to palm off this fiction for fact.

Modern rationalism began with Descartes, who is often called the father of modern philosophy. He likewise emphasized the necessity of beginning anew, but, unlike Bacon, he looked to the inner nature of self-consciousness for the principles that can build up the structure and furnish the certainty of knowledge. The Cartesian system is rationalistic; the method for advancing our knowledge was thought to consist in letting the light of reason shine forth. This was accomplished by the application of mathematical method to metaphysics, with the result of bringing out the innate truths and principles of reason. In this way we become assured, so Descartes

argued, of our own existence, of the existence of God, and of that of the material universe. Descartes sharply separated mind and matter; mind is thinking, unextended substance; matter is unconscious, extended substance. Two great problems are therefore handed down to his immediate followers. What is the relation between mind and matter in general, and the soul and body in particular? And what is the relation between the soul and God? Geulinx, the founder of Occasionalism (q.v.), answers the former question by saying that God acts in the individual, intervening on each occasion, to maintain the parallel between mind and body. God is the real subject of human acts, the individual being but a nominal subject. The second problem is taken up by Malebranche, who maintains that God thinks in the individual. The individual is nothing but the mode of God's being. The mind is in God, and in Him views everything in its eternal significance. Spinoza carries out Cartesianism to its logical conclusion. Substance is that which exists independently. Hence the infinite alone, God, is true substance. Mind and matter are two attributes of the one divine substance. They are known to us as the parallel manifestations of the hidden substantial identity in God. Spinoza develops his system by pure deductive reasoning, following the procedure of geometrical demonstrations. He thus exhibits the ideal method of rationalism, which regards reason, working solely on its own inner principles, as capable of discovering the true nature of reality. The moral and physical parts of the universe follow from these principles with the same rigid necessity as the *demonstranda* of geometry follow from its axioms. Joyful resignation to this rationalistic determinism is the essence of morality. Spinozism reduces the dualism of mind and matter to a common principle and results in pantheistic monism (q.v.). Leibnitz endeavors to solve the paradox of Spinozism that unextended and extended substances are ultimately identical. As a rationalist he sides with Spinoza; as an individualist he sides with Locke. Leibnitz's substance is not that which *exists* through itself, but rather that which *acts* through itself. Reality consists of an infinite number of monads (q.v.), which are unextended, ideal activities, centres of original forces, or *formal* atoms. Each atom is self-contained and cannot be modified from without. Spinoza surrenders the reality of individuals to the principle of unity. This unity Leibnitz breaks up into a plurality of independent, self-active monads. But the multiplicity is synthesized by the Leibnitzian principle of continuity and the law of preëstablished harmony (q.v.). All the monads belong to an organized system, and each mirrors or represents the universe. The individuals are not isolated, but belong to an organic whole. God, the supreme monad, is pure activity, while finite monads are in a state of imperfect realization. They are not completely active. It is the passivity of finite monads that gives rise to confused perceptions, which cause the appearance of an extended, material world. These fundamental principles of Leibnitz's system are sacrificed by his follower, Wolff, who adopted merely the rationalistic method of his master and reduced philosophy once more to scholastic form. This was the culmination of dogmatic rationalism on the Continent.

In the meantime the empiricism begun by Bacon and the rationalism begun by Descartes became curiously intermixed in Locke's theory of knowledge. Locke supported the Baconian appeal to experience. The sole sources of our knowledge are empirical facts, since the mind has no innate ideas. All the materials of knowledge are externally impressed upon the mind, the sole activity of which consists in linking together the given ideas. Upon this sensationalistic basis, however, Locke built up a rationalistic ideal of knowledge. We attain certainty in our intuitive knowledge of the existence of the self, and in the demonstrative knowledge of the existence of God, and of mathematical and moral truths as well. Our knowledge of the external world, being dependent upon sense-perception, reaches only the level of probability. In this, Locke violated his own fundamental principle that our knowledge extends no further than our sensationally given ideas, and that truth consists in the agreement of ideas among themselves, not in their correspondence with things or external reality. Berkeley took Locke's definition of knowledge in a strict sense, and insisted that we never get beyond the circle of our own ideas. We know nothing about the agreement of our subjective ideas with external things. All knowledge, he contended, is purely individual, and all ideas are merely particular. The mistaken belief in the existence of self is due to the confusion of taking an abstract or general name as representative of a real thing. The reality of sense-objects consists in their being perceived. The assumption of an object apart from the idea is as useless as its existence would be. Ideas signify nothing but modifications of the conscious subject. Hume carried empiricism to its inevitable logical consequence. There is nothing knowable, he argued, but conscious experiences—'impressions' and their copies, 'ideas.' These we cannot transcend. They are externally connected by 'gentle forces,' called relations or associations. We cannot prove the existence of God, of the self, or of matter. All these are fictions of the imagination, and have no basis in actual experience. Thus, step by step, empiricism ends in skepticism.

Kant, the founder of the critical philosophy, consciously and critically attempted what Locke had naïvely achieved, the arbitration of the controversy between empiricism and rationalism. His decision was that rationalism is right in its determination of scientific method; empiricism, in limiting scientific knowledge to the sphere of possible experience or phenomena. Knowledge, he maintained, is a joint product of two factors, one furnished by the conscious subject, the other given in the raw material of sensation. The former is *a priori*; it antedates experience and is the condition which makes experience possible. The latter is *a posteriori*, given from without. The *a priori* would be devoid of content without the sensible material; the *a posteriori* would be nothing at all were it not shaped and transfigured in the mold of consciousness. Theoretical reason may not transcend the bounded domain of experience, but practical reason asserts the necessity of the belief in a world of transcendent reality, in which the moral order is the natural law. God, freedom, and immortality, though undemonstrable, are the necessary postulates of our moral being. Thus reason gives way to

faith. Fichte, starting from a Kantian basis, objected to Kant's failure to show how the *a priori* principles of consciousness are necessarily involved in the nature of consciousness, as well as to the Kantian separation of the phenomenal world and the real world of things-in-themselves. By exhibiting the process in which consciousness unfolds itself, we see that the phenomenal world is meaningless unless organically connected with its intelligible essence. Knowledge is neither in whole (Hume) nor in part (Kant) the product of sensation. It is the creation of the ego. Voluntary selves freely choose to assert themselves and thus construct their whole organized world. The moral law is the prior condition of all we theoretically know, and the outer world exists simply for the sake of our moral self-realization. The speculative method, the exhibition of the progressive nature of consciousness, is the only possible method, since knowing does not begin with facts passively received by the ego, but with a spontaneous act of the ego's creative energy. Jacobi also objected to the Kantian separation between the thing-in-itself and the phenomenal world. Without the thing-in-itself, he said, no one can enter the Kantian system, and with it no one can remain in that system. The only solution of this antinomy was to exalt faith, to which even Kant had recourse, to the supreme place in philosophy. Not knowledge, but feeling, is the organon whereby we can attain certainty of reality. Thus results a philosophy of supranatural sensualism. Schelling reached much the same result, but by a different method. He regarded the world as the embodiment of intelligence, an objective fact, indeed, but one that exhibits in its progressive forms the same principle that is found in man. But the character of that absolute principle which thus manifests itself in external nature and in man cannot be apprehended by reason. Intuition alone brings us into contact with ultimate reality. In Hegel German rationalism vigorously reasserted itself: the real is the rational and the rational is the real. All reality is but a manifestation of reason. The world is a development of thought. But thought and reason are not abstractions. The word thought is used with a width of meaning that includes in it the concrete content of the world of sense organized into an all-inclusive universe. The life and stir of the universe is the life of thought. The development of this concrete thought is a dialectical development, hence philosophy must employ the dialectical method to exhibit the nature of reality. The motive force of this development is opposition and negation. Everything is what it is by virtue of what it is not; that is, by virtue of its relation to other things. These various things taken apart are self-contradictory; only when seen in their interconnection are they seen to be real. The contradictions are not annulled in their mutual relations; they are conserved, but thus conserved no longer are they contradictory. The tracing of this process of negation is the Hegelian dialectic. With the death of Hegel, Hegelianism broke up into warring schools and became utterly discounted in Germany, only to be resuscitated later in England and America in the so-called Neo-Hegelian School.

Schleiermacher took up the philosophical problem where Fichte, Schelling, and Jacobi had left

it. He agreed with Jacobi that thought cannot grasp the essence of reality; hence philosophy is not a complete science; but while it is not complete, it is ever growing and reaching out toward the goal of the identity of thought and being. This goal, however, can be reached only in religion, the communion of the finite with the infinite upon which it feels itself dependent. In Herbart and Schopenhauer there is a twofold opposition to Hegelianism; the former opposed his doctrine of real qualities to Hegel's idealism; the latter directed his pessimism (q.v.) against the idealistic estimate of the value of existence, and maintained that the real is an irrational principle of blind impulse. Beneke attempted to synthesize the results of previous philosophical activity by developing a psychological philosophy, based on inner experience. Self-consciousness reveals directly to us the psychic constitution of man; sensation is only mediate knowledge of the outer world, which must be interpreted after the analogy of psychic life. Lotze combined the Hegelian and Herbartian positions, while Hartmann aimed at a synthesis of Schopenhauer and Hegel. Among recent German thinkers the cry of "Back to Kant" is especially prominent; this Neo-Kantianism is represented by such men as Lange, Cohen, Volkelt, Riehl, and Paulsen. Another vigorous German school at present is that of the so-called immanent philosophy of Schuppe, Rehmke, and Schubert-Soldern, who deny the antithesis of idea and object, and assert an identical unitary consciousness in all beings. The immanent content of this consciousness is the world of space and time. Allied to this immanent philosophy is the empiriocriticism of Avenarius, who, like Schuppe, begins, not with the opposition of subject and object, but with the pure experience of the unsophisticated man free of all preconceived theory. In this experience the so-called object of consciousness is an integral part; and of this experience philosophy is an exact description. Materialism had a temporary revival in the middle of the nineteenth century in Germany; its champions were Vogt, R. Wagner, Moleschott, Büchner, Czolbe, and Dühring. Sometimes identified with materialism is the monism of Haeckel, who, however, is not a materialist, but an animist, holding all matter to be instinct with life; but inasmuch as the material, not the conscious, side of being is emphasized, the doctrine is closely allied to materialism. Fechner had some years before Haeckel advocated an animism, which, however, had emphasized the conscious side of being. Wundt's philosophy is related to Fechner's, inasmuch as he holds that the mechanical universe is "the outer wrapper behind which is hidden a spiritual creative activity, a striving, feeling, sensing, like that which we experience in ourselves." Holding that conation is the most fundamental essence of this activity, his view is voluntaristic.

Returning now to French philosophy, we may say that after the time of Descartes there have been no epoch-making thinkers in France except Rousseau and Comte. Deserving of mention are Bayle, the skeptic; Voltaire, more positive in his attitude and with a leaning toward mechanism; Rousseau, the political philosopher, believing with Hobbes in a state of nature preceding society, but emphasizing the social nature of man, which Hobbes had ignored; La Mettrie and

Condillac, sensualists; Rochefoucault and Helvétius, egoists; Bonnet, a rationalistic sensualist; Diderot and d'Alembert, pantheists. The last three, along with minor thinkers, are known as the Encyclopædists, because of their coöperation in the issue of the great *Encyclopédie*. During the French Revolution the predominant philosophy was sensationalism, going under the name of ideology, given it by Destutt de Tracy. Cabanis emphasized the physiological basis of sensationalism; a little later Maine de Biran, starting with the psychological fact of self-consciousness, reached a view similar to Beneke's, in which the spiritual nature of self-activity received recognition. He was thus the forerunner of spiritualism (q.v.), which was championed by Jouffroy and Royer-Collard, and had in Cousin its most prominent exponent. Spiritualism lived through the nineteenth century, being later represented by Ravaisson, Secrétan, and Vacherot. Opposed to ideology were the traditionalists, who, while reaching spiritualistic results, were hostile to the method of the spiritualists. Accepting the Catholic doctrines as unimpeachable, they emphasized the supremacy of faith above reason. Reason inaugurated the Reformation and issued in the Revolution; it is the source of nothing but evil. Faith resting on inspired authority is alone able to reach the truth. So wrote De Maistre, Frayssinons, and Bonald. But reason would not down, and turned its attention to the social nature and relations of human beings. Saint-Simon, the founder of the French Socialistic School, was not himself so much a philosopher as a reformer; he practiced rather than theorized; but he interested many speculative minds in social problems. The greatest of his disciples was Auguste Comte. Comte contended that the only true and final philosophy is positive; true philosophy is an accurate description of facts and their experienced relations. He brushed aside all pretence of knowledge of anything more ultimate than the phenomena of experience. Positivism, however, according to Comte, is only the third stage of philosophical reflection. Man's first attitude toward nature was theological; he attempted to explain phenomena by referring them to supernatural powers. Then man became metaphysical, using abstract conceptions, like force, as principles of explanation. Finally as the third stage came positivism, the insight into the futility of previous explanations, and the recognition of facts and their relations as philosophical ultimates. About the middle of the nineteenth century, in protest against Comte, a revival of Platonism occurred in certain Catholic circles; Cartuyvels, Hugouin, and Graty maintained that ideas are modes of God's essence. Positivism passed over into agnosticism in Littré, Taine, and Renan. With the development of experimental psychology a psychological philosophy has been cultivated by Ribot, Delbeuf, and Bernard. After Darwin's *Origin of Species* appeared, evolutionism was eagerly taken up by French thinkers, chief among whom have been Fouillée and Guyau. But Kantian principles maintained their ground in the philosophy of Renouvier and his followers. Laehelir attempted a combination of Kantianism and spiritualism. Against the determinism (q.v.) of positivism, psychologism, and evolutionism, Boutroux advocates a philosophy of contingency and freedom.

Since Bruno's time Italy has made little original contribution to philosophy, although she can boast of many brilliant expositors of already existing systems. Vico and Beccaria can lay the best claim to originality, both working in the realm of the philosophy of law. Genovesi, the empiricist; Galluppi, the sensationalist; Rosmini and Gioberti, objective idealists; Mamiani, a modified Platonist; Vera and Spaventa, Hegelians; Testa and Cantoni, Kantians; Villari and Dominici, positivists; and Bonavino, Thomist, deserve passing mention.

For the last two centuries Great Britain has shared with Germany the honor of having distinctive national philosophies. English thought has been predominantly empiricist and associationistic until the last half century. Hartley gave associationism (q.v.) its modern form, and James Mill applied it to all the life of mind. J. S. Mill, best known popularly by his utilitarianism (q.v.), did his greatest philosophic work in logic. True to empiricism, he introduced induction into the place it now occupies in logical theory, and yet he builded better than he knew. His empiricism did not furnish an adequate basis for his logic, and subsequent logicians, as Sigwart in Germany and Bosanquet in England, have succeeded in effecting a reconciliation between empiricism and rationalism in logic; but this they could not have done without Mill's pioneer work. Darwin's great discovery has been extremely fruitful in philosophy. Spencer has worked out an evolutionary philosophy in elaborate detail, but with a strong individualistic bias. It is, however, marred by a lack of historic perspective. Lowes represented positivism; Martineau has been the most prominent advocate of intuitionism (q.v.), applying intuitionistic principles especially to ethics and theology. Green, Bradley, and Bosanquet, under the influence of German idealism, have sought to stem the tide of empiricism. Ward, from a psychological starting-point, has likewise reached an idealistic result. Under the leadership of these men and of the two Cairds, of Scotland, English philosophy has almost left its empiricist moorings.

The typical philosophy of Scotland since the time of Hume has been intuitionism. Hutcheson may be regarded as its founder. Reid and Stewart gave it classical expression. This Scotch thought was a protest against the Lockean doctrine that knowledge is only a correspondence between ideas, and stoutly maintained that we have immediate knowledge of objective reality. Hamilton, in his natural realism, sought to reconcile intuitionism with Kantianism. The two Cairds and Stirling broke away from the intuitionistic tradition and gave Hegelianism a vogue which makes it rival intuitionism in Scotland and empiricism in England.

In America the greatest original philosopher was Jonathan Edwards, who, starting from Lockean premises, elaborated under Calvinistic influences a most uncompromising determinism (q.v.). Franklin, while not technically a philosopher, gave an impetus toward empiricism. Witherspoon and McCosh brought strong support to Scotch intuitionism, also taught by Upham and Wayland. Among the educators who early aroused interest in philosophy were Noah Porter, Mark Hopkins, and Daniel Coit Gilman. Hiecock was mildly Kantian; Bowen was

eclectic; Bowne and Ladd are Lotzeans. The Concord School of Philosophy, headed by Emerson, popularized German idealism, which has been strongly defended technically by Harris; while Royce and Dewey have given it a more independent and original statement. James is a brilliant advocate of empiricism and seeks to rescue philosophy from agnosticism by asserting the right of a will to believe in face of doubt; and George Stuart Fullerton is a keen critic, whose studies in epistemology are of special importance.

In the last century the significance of the history of philosophy has been brought out by a long line of historians, beginning with Hegel. The result is that the continuity of philosophic development, and the genuine advance made by philosophic thought, in spite of an apparently merely back-and-forth movement, have been appreciated.

BIBLIOGRAPHY. Külpe, *Einleitung in die Philosophie* (2d ed., Leipzig, 1898; Eng. trans., London, 1897); Rogers, *Brief Introduction to Philosophy* (New York, 1899); Ladd, *Introduction to Philosophy* (ib., 1890); Paulsen, *Einleitung in die Philosophie* (4th ed., Berlin, 1896; Eng. trans., New York, 1898); Hibben, *The Problems of Philosophy* (ib., 1898); Wundt, *System der Philosophie* (2d ed., Leipzig, 1897). W. S. Sonnenschein has published *A Bibliography of Philosophy* (London, 1897). For the history of philosophy especially, consult: Schwegler, *Handbook of the History of Philosophy* (Eng. trans., Edinburgh, 1871); id., *A History of Philosophy in Epitome* (Eng. trans., New York, 1888); Erdmann, *History of Philosophy* (Eng. trans., London, 1890); Ueberweg, *History of Philosophy* (Eng. trans., new ed., New York, 1891; the original German work has been frequently revised by Heinze, 8th ed., Berlin, 1896-97); Windelband, *History of Philosophy* (Eng. trans., New York, 1901); Weber, *Histoire de la philosophie européenne* (5th ed., Paris, 1892; Eng. trans., New York, 1897). For the Greek period, especially Zeller, *Die Philosophie der Griechen*, in several volumes, covering separate periods, and separately translated; Burnet, *Early Greek Philosophy* (London, 1892); Ritter and Preller, *Historia Philosophiæ Græcæ* (8th ed., Gotha, 1898). For scholastic philosophy, see the article **SCHOLASTICISM**. For the more modern developments, Windelband, *Geschichte der neueren Philosophie* (Göttingen, 1898); Fischer, *Geschichte der neueren Philosophie* (4th ed., Heidelberg, 1898-1902); Höfding, *History of Modern Philosophy* (Eng. trans., London, 1900); Royce, *The Spirit of Modern Philosophy* (Boston, 1892); Seth, *From Kant to Hegel* (London, 1892); Falckenberg, *History of Modern Philosophy* (Eng. trans., New York, 1893); also, Blackwood's *Philosophical Classics*, Griggs's *Philosophical Classics*, and Frommann's *Klassiker der Philosophie*. Excellent bibliographies are to be found in Weber's and Ueberweg's histories referred to above.

PHILOSOPHY, MORAL. See **ETHICS**.

PHILOS'TRATUS (Lat., from Gk. Φιλόστρατος). The name of four sophists of the Roman Imperial period. According to Suidas the first three were all natives of the island of Lemnos. (1) The first PHILOSTRATUS lived in Nero's reign (A.D. 54-68). The only extant work of his is the dia-

logue *Nero*, a conversation between the Lemnian Menecrates and the banished philosopher Musonius Rufus on the Emperor's proposed canal across the Isthmus of Corinth and on his great cruelty.

(2) **FLAVIUS PHILOSTRATUS** flourished under Septimius Severus (A.D. 193-211) and his successors. At the request of the Empress Julia Domna, he wrote a remarkable *Life of Apollonius of Tyana*, in which he laid especial stress on the miracles ascribed to this pagan saint. The work was used later to oppose the teachings of the Christians. The same Philostratus is the author of the extant *Lives of the Sophists*, written soon after A.D. 229. (3) The third **PHILOSTRATUS**, son of Nervianus and son-in-law of Flavius Philostratus, was a young man in the reign of Caracalla (A.D. 211-217). He composed a work entitled *Imagines* (*Eikónes*), which is still extant and describes 64 paintings in Naples. (4) The last **PHILOSTRATUS** was a grandson on his mother's side of the third Philostratus. He also wrote an *Imagines*, after the manner of his grandfather's book. This work is inferior to its model, and in its present form breaks off in the description of the seventeenth painting. The *Imagines* of the third Philostratus at least have now been proved to be descriptions of actual works of art, and so are of great value to the archaeologist. The dialogue *Heroicus* probably belongs to the third sophist, while the second apparently was the author of the interesting collection of *Letters*. The standard edition of all these works is by Kayser in the Teubner Collection (2 vols., Leipzig, 1849). The *Imagines* of the third Philostratus have been separately edited by the members of the Vienna Classical Seminary (Leipzig, 1893).

PHILO'TAS (Lat., from Gk. Φιλώτας). A Macedonian general. See **PARMENION**.

PHILOXENIAN VERSION. See **BIBLE**, section on *Text of the New Testament*.

PHILOXENUS (Lat., from Gk. Φιλόξενος) (B.C. 435-380). A famous dithyrambic poet, born in Cythera. When the Spartans recaptured the island from the Athenians, probably after the Sicilian Expedition, he became a slave. Eventually he passed into the hands of the poet Melanippides, who, attracted by his talent, educated and freed him. He lived some time at the court of the elder Dionysius in Syracuse. There he forfeited the tyrant's friendship either on account of his frank criticism of his patron's verses or because of his love for a beautiful flute-player, Galatea, the mistress of Dionysius, and was imprisoned in the quarries. Philoxenus subsequently took vengeance on Dionysius by composing the most famous of his dithyrambs, *The Cyclops*, in which he represented himself as Odysseus winning from the Cyclops the affections of his sweetheart, the nymph Galatea. This was the model for Theocritus's eleventh idyl. After leaving Syracuse, Philoxenus lived at Tarentum, and later in Greece, and died at Ephesus. He wrote 24 dithyrambs in all, which were greatly admired in antiquity. Of these only insignificant fragments remain. The poem entitled *The Banquet* (*Δείπνον*), of which much is extant, is generally ascribed to this Philoxenus; but it is probably the work of a Philoxenus of Leucas. The fragments are published by Bergk, *Poetæ Lyrici Græci*, vol. iii. (Leipzig, 1882).

PHILTER, or **PHILTRE** (Lat. *philtrum*, from Gk. φίλτρον, *philtron*, φίλητρον, *philetron*, love

charm, from φίλειν, *philein*, to love). An artificial means of inspiring and securing love. A belief in such charms seems to have been generally prevalent from an early age. Among the Greeks and Romans (among the latter in the later days of the Republic, and under the emperors), love charms, and especially love potions, were in continual use. Probably certain poisonous or deleterious herbs and drugs were among their chief ingredients, to which other substances, animal as well as vegetable, are said to have been added, coupled with the employment of magic rites. Thessaly was famous for producing the most potent herbs, and her people were regarded as the most skillful practitioners of magic arts, whence the well-known *Thessala philtra* of Juvenal (vi. 610). These potions were violent and dangerous, producing madness and death, instead of merely serving the purpose for which they were intended. The use of philters seems to have been not unknown during the Middle Ages; and in the East, belief in the power of love potions has never died out.

PHINEAS (fin'é-as) **FINN**, THE IRISH MEMBER. A novel by Anthony Trollopé (1869). It is the first of a series of political tales, *Phineas Redux*, *The Prime Minister*, and *The Duke's Children*, in which Finn and most of the characters of the story reappear. The hero, a handsome young Irishman, goes to London and enters Parliament. Much of his success is due to the Standish family, particularly Lady Laura. At the close he throws up his political career, retires to Ireland, and marries his former sweetheart, Mary Flood-Jones.

PHINEUS, fin'é-üs or fin'ūs (Lat., from Gk. Φινεύς). A blind soothsayer, the son of Agenor, and King of Salmydessus in Thrace. Because of his cruelty to his children by his first wife, when his second wife accused them falsely, he was punished with blindness and was tormented by the Harpies, who seized or defiled all the food placed before him. He was delivered from the monsters by Zetes and Calais, and in return directed the Argonauts in their expedition. Other traditions represent him as being slain by Heracles or by Boreas.

PHIN'TIAS (Lat., from Gk. Φιντίας). A friend of Damon. See **DAMON** AND **PHINTIAS**.

PHIPS, or **PHIPPS**, Sir WILLIAM (1651-95). The first royal Governor of Massachusetts. He was born at a border settlement, since called Woolwich, on the Kennebec River, in Maine, and was one of a family of twenty-six children, all of the same mother. Till eighteen years of age he was employed in keeping sheep, but dissatisfied with this occupation, he became a ship-carpenter, and removed to Boston. There he learned to read and write, and also married a widow with some property. Some years later he conceived the idea of fishing up treasure stored in a Spanish galleon that had been wrecked fifty years before in the West Indies. The English Admiralty fell in with this plan and gave him command of a frigate, but after a long search he returned unsuccessful. A little later he was sent out again in a vessel provided by the Duke of Albemarle and others, and this time he found a wreck and took from it treasure to the value of about £300,000. As a reward for his success, he received as his share £16,000, the honor of knighthood, and the appointment as sheriff of New England. In

1690 he was sent by Massachusetts with a fleet of eight vessels against the French settlement of Port Royal in Acadia, and succeeded in capturing it. Later in the same year he commanded a larger expedition, consisting of 34 vessels and more than 2000 men, against Quebec. So active, however, were the French under Count Frontenac that the attempt failed, and on the way back to Boston nine of the vessels were wrecked. In 1692, through the influence of Increase Mather, the agent of the colony in England, Phips was appointed Governor of Massachusetts, under the new charter. One of his first official acts was to commission a special court for the trial of those accused of witchcraft, but some months later he suspended its sittings. As Governor he displayed many of the bluff and choleric traits of a sea captain; among other things, he cudged Brinton, the collector of the port of Boston, and caned Captain Short of the Royal Navy. In 1694 he was summoned to England to answer complaints made against him, and while there died suddenly of a malignant fever. Phips was a man of great energy and determination, but possessed no remarkable intellectual capacity; and he appears to have been strictly honest in his private dealings, though he deemed it no sin to steal from Frenchmen. There is a curious life of him in Cotton Mather's *Magnalia* (London, 1702), but more trustworthily is that by Francis Bowen in vol. vii. of the first series of Sparks's *American Biography* (New York, 1834-37). Consult, also, Hutchinson, *History of Massachusetts*; Parkman, *Count Frontenac and New France Under Louis XIV.* (Boston, 1877); and Myrand, *Sir William Phipps devant Québec* (Quebec, 1893).

PHIZ. The pseudonym of the English caricaturist and illustrator Hablot Knight Browne (q.v.).

PHLEBITIS (Neo-Lat., from Gk. φλέψ, *phleps*, vein), or **INFLAMMATION OF THE VEINS.** Although seldom an original or *idiopathic* disease, it is a frequent sequel of wounds, in which case it is termed *traumatic* phlebitis, and is not uncommon after childbirth. (See PHLEGMASIA ALBA DOLENS.) It commonly arises by the extension of an inflammation from contiguous structures, as in phlegmonous erysipelas or cellulitis, or by the plugging up of a vein by an embolus or thrombus. If severe, the disease begins with a chill or chilly sensations, and a rise in temperature. There is great tenderness and pain along the course of the affected vessel, which feels like a hard knotted cord, and rolls under the fingers. If the vessel is small the consequences of its obstruction may be of little importance, but when a large vein is affected the consequences are always dangerous, and may be fatal.

Phlebitis may terminate in one of several ways. The most favorable is by simple resolution—the clot is absorbed, the vein becomes permeable, and circulation is reestablished. In other cases organization of the clot takes place, little blood vessels growing into it, from the walls of the vein, and the latter finally becomes a fibrous cord. The circulating blood is diverted to other channels which gradually dilate to accommodate the increased flow. Again, the clot may become infected, if it is not so from the beginning, undergo purulent softening, and the pus either discharged by the formation of abscesses, or emptied into the blood current to be carried by

the general circulation to all parts of the body. These purulent particles find lodgment in the large viscera, such as the liver, spleen, kidneys, and give rise to multiple abscesses. In the liver this frequently happens from inflammation of the portal veins. This general distribution of septic material is known as *pyemia* (q.v.). An organized clot may in rare instances become calcified by the deposition in it of lime salts, and form a *phlebolite*.

The treatment of phlebitis comprises rest in bed, elevation of the part, and the local application of antiphlogistics—lead water and opium at first, hot fomentations later. If abscesses form, they must be opened and drained. In certain cases it is possible to ligate the vein above and below the clot, open the vessel, and wash out the purulent material. The internal treatment varies with the symptoms, but in general must be stimulating.

PHLEBOLITE (from Gk. φλέψ, *phleps*, vein + λίθος, *lithos*, stone). A calcareous concretion formed by the degeneration of coagulations in veins. It is not infrequently to be felt as a nodule varying in size from a pinhead to a small bean along the course of chronically inflamed veins of the lower extremity, and phlebolites have been known to attain considerable size.

PHLEBOTOMY. See BLEEDING.

PHLEGETHON, φλεγέθων (Lat., from Gk. φλεγέθων, from φλέγειν, *phlegein*, to burn). In Greek mythology, a river of the lower world, along with Acheron, Coeytus, and Styx (qq.v.). In Homer it unites with Acheron, as does Coeytus, a branch of the Styx. Later writers described its fiery torrent and scorched and desolate shores.

PHLEGMASIA ALBA DOLENS (Neo-Lat., painful white inflammation), or **MILK-LEG.** A painful general swelling of a limb, due to the obstruction of the veins; a plastic phlebitis. It is due to pressure, general disease, sepsis, or thrombosis. Milk-leg occurs principally as an affection of women in childbed, occasionally during typhoid fever. The first symptom is a rise of temperature, which may be overlooked. Pain first attracts attention, felt on the inside of the thigh, in the groin, and in the calf, of a very severe character. There may be numbness, tingling, cramps, or creeping sensations. The limb swells early from a soft œdema, the skin being white and shining, often waxy. Blue veins may stand out prominently on the posterior part of the limb. Fibrinous coagula may be detached and carried along in the circulation to some other part, as the lung, forming embolism. Paralysis of motion, disorders of sensation, and wasting of the limb may occur. The treatment consists of supporting the limb on a higher level than the trunk; punctiliously avoiding any jarring of it; maintenance of the recumbent position for at least a month; fomentations to the limb, which must be wrapped, in the intervals, in cotton; support of the heart with appropriate drugs; control of pain with analgesics and of insomnia with hypnotics. The great danger is from pulmonary embolism, which is almost invariably fatal.

PHLEGRÆAN PLAIN (Lat. *Phlegræi Campi*). A region west of Naples, embracing the volcanic plain on the Campanian coast from

Cumæ to Capua. There legend placed the scene of the combats between the gods and the giants. The Romans filled it with palatial villas, and their poets celebrated its charm and productiveness. The volcanic disturbances to which the region has been subject have left of the magnificent buildings of the Romans only confused ruins, in part submerged under the sea.

PHLEGYAS, φλεγῆϊ-ās (Lat., from Gk. φλεγῆϊας). The son of Ares, and father of Ixion and Coronis. His daughter became by Apollo the mother of Æsculapius. Phlegyas was so incensed that he set fire to the temple of the god, and for this was condemned to everlasting fear in Tartarus, where an overhanging rock constantly threatened to fall on him.

PHLOEM, phlō'ēm (from Gk. φλοιός, *phloios*, bark), or **BAST**. That portion of a vascular bundle in plants including the sieve tissue, parenchyma, and bast fibres, and in ordinary trees forming the inner bark. See **STEM**.

PHLOGISTON. See **CHEMISTRY**.

PHLOGOPITE (from Gk. φλογώψ, *phlogōps*, flaming-red, from φλόξ, *phlox*, flame + ὤψ, *ōps*, face). A magnesium mica, similar to biotite, but differing from it in composition by usually containing fluorine and less iron. It crystallizes in the monoclinic system, has a pearly lustre, and is usually of a light yellow to brown and red color. The phlogopite occurs in serpentine rocks and frequently in association with limestone or dolomite. Phlogopite often exhibits asterism, especially when seen by transmitted light, as when a candle flame is viewed through a thin sheet. This property has been shown to be due to minute needle-like inclusions arranged chiefly in the direction of the rays of the pressure figure, producing a distinct six-rayed star. Phlogopite is found in Finland, Sweden, Switzerland, and in the United States at various localities in New York, New Jersey, and also in Canada.

PHLOX (Lat., from Gk. φλόξ, sort of flower, flame, from φλέγειν, *phlegcin*, to burn; connected with Lat. *flagrare*, to burn, Skt. *bhraj*, to shine brightly). A genus of mostly tall, erect, spreading perennial herbs belonging to the order Polemoniaceæ, natives of North America. The



CULTIVATED FORM OF MOSS PINK (*Phlox subulata*).

species, nearly all of which have a wide natural distribution within the United States, have entire leaves, and generally very showy flowers either solitary or in terminal clusters. Owing to their hardiness, easy cultivation, and the size and beauty of their flowers, many hybrid varieties with single and double flowers, in many colors, forms, markings, and long period of bloom, and a few of the pure species, are grown in gardens,

being well adapted for planting on rockeries and in borders and groups. The best known annual species of this genus is *Phlox Drummondii*, a native of Texas, from which all annual phloxes now in cultivation have been derived. *Phlox pilosa* is a somewhat variable species which flowers from May to August. *Phlox reptans* is native to the Allegheny Mountains. *Phlox Stellaria* is much prized as an ornamental plant on account of its numerous white flowers. The ground or moss pink commonly grown in gardens is *Phlox subulata*. The wild sweet William (*Phlox divaricata*) has pale lilac or bluish flowers appearing in spring and early summer. All the species of phlox grow readily in ordinary rich soil; the annuals from seeds and the perennials from seeds, division of the stools, or cuttings of the stems and roots. The seeds are sown early in the spring, given gentle heat, and after the seedlings are large enough they are transplanted, hardened under glass, and later set out in the open. The stem cuttings are made in summer and placed in fine sandy soil under cold frames or in greenhouses. The root cuttings when slightly covered with soil and placed in gentle heat sprout readily. After the cuttings have rooted they may be treated like the seedlings.

PHOCÆA (Lat., from Gk. Φώκαια). The northernmost of the Ionian cities of Asia Minor, about twenty miles northwest of Smyrna. It was said to have been originally settled by Phocians. It was included in the Ionian confederacy, and was one of the most flourishing and powerful of the Asiatic Greek cities. Its sailors were famous for the daring with which they pushed their fifty-oared war-vessels (not the heavy merchant craft) into the western seas. The westernmost colony of the Phocians was in Mænaca, in Spain, and they were on close terms of friendship with Arganthonius, King of Tartessus. Their most famous colony, however, was Massilia (Marseilles). Unable to defend themselves against Harpagus, the general of Cyrus, they abandoned their city and sailed to Chios (c.540 B.C.). Part of them subsequently decided to return and accept the Persian rule, but the majority sailed to Corsica and settled in Alalia. Attacked by the Carthaginians and Etruscans, who resented Greek entrance upon these lands, they were victorious in a great naval battle, but thought it wiser to abandon their settlement and move to Southern Italy, where they founded Hyele, or Elea (Velia). Phocæa seems to have continued to exist, though it is scarcely mentioned till it was captured and plundered by the Romans in the war with Antiochus. New Phocæa was founded by some Genoese about 1420, and this spot is now occupied by a little village, Phokia, while the site of the old city is still called Palæo-Phokia.

PHOCAÏS, fōk'ā-īs. An epic poem ascribed to Homer, and said to have been composed by him in Phocæa.

PHOCAS (Lat., from Gk. Φωκᾶς, *Phōkas*) (?-610). Byzantine Emperor from 602 to 610. He was an obscure centurion in the army, which was fighting the Avars on the Danube, when in 602 the soldiers rose in rebellion against the Emperor Maurice (q.v.), and Phocas was chosen their leader. He invested Constantinople, and after the forced abdication of Maurice was chosen and crowned Emperor. His first act was to cause the

public execution of Maurice and his five sons, and throughout his reign he was notorious for his cruelty. In Europe an ignominious peace was maintained, while in Asia unsuccessful war was waged against the Persian King Khosru II. (q.v.). He gave his only child in marriage to the patrician Crispus, and the images of the couple were indiscreetly placed by some of their friends in the circus, which was a privilege of royalty only. After this Crispus no longer felt secure, and he conspired with the rebellious exarch of Africa, Heraclius, to dethrone Phocas. This was accomplished in 610, and the tyrant was tortured and beheaded.

PHOCAS, COLUMN OF. A famous column in the Roman Forum, erected in 608 by the exarch Smaragdus in honor of the Eastern Emperor Phocas, and once surmounted by a gilded statue of Phocas. The column is 54 feet in height, and is of a better style than that which prevailed at the time of its dedication. It is therefore supposed that it may have been taken from some earlier edifice, or that an already existing monument was rededicated by Smaragdus. It was covered by the accumulated rubbish of centuries till 1813, when it was unearched by the Duchess of Devonshire.

PHOCION, fō'shī-ōn (Lat., from Gk. Φωκίων, *Phokiōn*) (c.402-317 B.C.). *An Athenian general. He was of humble origin, but received a good education and studied under Plato and Xenocrates. His first public service was performed under Chabrias at Naxos in B.C. 376. About 349 he was sent into Eubœa to quell a disturbance that had been fostered in Eretria by the partisans of Philip of Macedon, and won a victory at Tamynæ. Some years later he led a body of Athenian hoplites to Megara, crushed Philip's faction there, and reestablished the long walls to Nisæa; and also again conducted a force to Eubœa, where he liberated Oreus and Eretria from Macedonian influence. In 340 he was sent to the Propontis to act against Philip, who, besides suffering a number of minor reverses, found himself forced to abandon the siege of Byzantium and Perinthus. In politics, however, Phocion was a supporter of Philip and an adversary of Demosthenes, though not from mercenary or traitorous motives. When, after the destruction of Thebes in 335, Alexander sent to Athens demanding the surrender of Demosthenes and the other leaders of the anti-Macedonian party, Phocion advised compliance with the King's wishes. The proposal was rejected by the people, and an embassy was sent to Alexander to deprecate his resentment, but not until a second embassy had been sent, at the head of which was Phocion, was the King induced to remit his terms. After the death of Antipater Phocion became implicated in the intrigues of Cassander, the rival of Polysperchon, and was forced to flee to Phocis, but was surrendered to the Athenians and by them condemned to drink the hemlock. His body was carried out of Attica into the Megarid and there burnt. Shortly after his death there was a revulsion of feeling in his favor among the Athenians. They then celebrated his funeral obsequies at the public expense, and erected a statue in his honor. Consult Plutarch's *Life of Phocion*.

PHOCIS (Lat., from Gk. Φωκίς, *Phōkís*). In ancient geography, a division of Greece, in Hellas, bordered on the west by Ozolian Locris and Doris,

on the north by Epienemidian and Opuntian Locris, on the east by Bœotia, and on the south by the Gulf of Corinth. The greater part of the country is mountainous, with Parnassus filling the central and western portion, and only a section in the northeast, through which the Bœotian Cephissus flows, is fertile. The chief town was Elateæ, which commanded the entrance into Bœotia from the north. Other towns of some importance were Daulis, Abæ, the seat of an ancient oracle, and Hyampolis, but the most conspicuous place, to which the fame of the land was chiefly due, was Delphi, whose inhabitants, however, always claimed that the control of the oracle did not belong to the Phocians. The State was a league of 22 cities, most of which were of small size. The Phocians seem to have been akin to the Dorians, though there were elements derived from earlier settlers in those regions, and there is some evidence for colonization in the southern portion from Crete and the Peloponnesus. They do not play a prominent part in the earlier history of Greece, though we hear of a desperate defense against the advance of the Thessalians, and in general they appear as enemies of the Thessalians and Bœotians and friends of the Athenians, who supported their claim to control Delphi. In B.C. 357 the Amphictyonic Council, apparently through Theban influence, imposed a heavy fine on the Phocians for cultivating some land belonging to the Delphic oracle. The Phocians resisted the sentence and were favored, but not actively assisted, by Athens and Sparta, who were at that time on bad terms with the Council and hostile to Thebes. The Phocians seized Delphi and 'borrowed' the temple treasures with which to maintain their army. For ten years the war was waged with no decisive results, though in general to the advantage of the Phocians. Even the growing power of Philip of Macedon did not check them, for while he was victorious in Thessaly, he could not pass Thermopylæ, which was held by a Phocian army and an Athenian fleet. The Peace of Philocrates (B.C. 346) between Athens and Philip left the Phocians helpless, and the sentence of the Amphictyons, which expelled them from the Council, condemned them to an enormous fine and dispersed them into small villages, thus practically removing them from future history.

PHOCYLIDES, fō-sil'ī-dēz (Lat., from Gk. Φωκυλίδης, *Phokylidēs*) (c.560 B.C.?). A Greek poet of Miletus, contemporary with Theognis. He wrote chiefly didactic poems in two or three verses of hexameters or elegiac metre, the eighteen extant fragments of which have been included in almost all of the collections of the lyric and gnomic poets. Ποιήμα νοσητικόν, the admonitory poem, in about two hundred and thirty hexameters, which has been preserved under his name, is now supposed to have been the work of an Alexandrine Jew of the first century B.C. Consult: Bergk, *Poeta Lyrici Græci* (5th ed., Leipzig, 1900 et seq.); and Bernay, *Ueber das phokylideische Gedicht* (Berlin, 1856).

PHEBE. (1) A name applied to the goddess Artemis or Diana (q.v.). (2) In Shakespeare's *As You Like It*, a fickle shepherdess who falls in love with the disguised Rosalind, but at last marries the shepherd Silvius, her former lover. (3) A New England girl of strong common sense in Hawthorne's *Marble Faun*.

PHENIX PARK. A public park of 2000 acres in Dublin, containing a granite monument in honor of Wellington. The park became famous through the assassination within its borders, on May 6, 1882, of Lord Frederick Cavendish, Chief Secretary for Ireland, and Thomas Burke, the Under Secretary.

PHENIXVILLE. A borough in Chester County, Pa., 28 miles northwest of Philadelphia; at the junction of French Creek with the Schuylkill River, and on the Pennsylvania and the Philadelphia and Reading railroads (Map: Pennsylvania, F 3). It has a public library and a hospital; and is an important manufacturing centre, well known for its great iron mills, boiler works, silk mills, underwear and hosiery mills. There is also a match factory. The government is vested in a burgess, chosen triennially, and a council which elects all municipal officials excepting the school directors, who are independently chosen by popular vote. The borough owns and operates the water-works. Phoenixville was settled in 1792 and was incorporated as a borough in 1849. Population, in 1890, 8514; in 1900, 9196.

PHOLAS (Neo-Lat., from Gk. *φωλάς*, a lurking mollusk which makes holes in stones). A genus of bivalve mollusks having much roughened, file-like shells with which they excavate cavities in soft rocks, in other shells, etc., for their own occupancy. See DATE-SHELL.

PHOLUS. A centaur, son of Silenus, by whom Hercules was entertained on his journey in quest of the Erymanthian Boar. When the other centaurs were attracted to the cave of Pholus by the odor of the wine with which he regaled the hero, Hercules scattered and pursued them, but on his return found Pholus accidentally killed by one of the arrows which he had withdrawn from the body of a slain centaur, and which had dropped from his hand and stuck in his foot.

PHONAUTOGRAPH. See PHONOGRAPH.

PHONETIC LAW (Gk. *φωνητικός, ρηδνῆτικός*, relating to sound, from *φωνή, ρηδνῆ*, sound, voice; connected with *φήναι, φηναί*, Lat. *fari*, to speak, OHG. *ban*, Ger. *Bann*, AS. *bann*, Eng. *ban*). In comparative linguistics, a formula which sums up a certain phonetic correspondence or a certain number of such correspondences. The term law in this sense is, therefore, essentially different from its application in mathematics or chemistry, and approaches rather the usage of the word as it is employed in psychology. A given phonetic law, moreover, is required to be operative only under given conditions in a given dialect or dialect-group during a given period. As an example of such a law we may take the representation of the Indo-Germanic *ā* which becomes in Germanic *ō*, which remains unchanged in Gothic, Icelandic, Old Saxon, and Anglo-Saxon; as Sanskrit *bhrātar*, Greek *φράτηρ*, Latin *frāter*, 'brother,' but Gothic *brōþar*, Icelandic *brōþer*, Old Saxon *brōthar*, Anglo-Saxon *brōþor*. Further, it is a phonetic law in Old High German that such an *ō* becomes *uo*, which is changed in New High German to *ū*, so that we find corresponding to Gothic *brōþar*, Old High German *bruoder*, New High German *Bruder*. On the other hand, Indo-Germanic *ā* becomes *a* in Old Church Slavic and *ō* (written *o*) in Lithuanian, as Sanskrit *bhrātar*, 'brother,' Old Church Slavic *bratrū*, Lithuanian *brōlis*. As the science of comparative linguistics

developed, it was found that sound-changes followed certain rules. The very earliest investigators, however, seem to have paid little attention to the problem whose enunciation and discussion was destined to mark an epoch in the history of the science, the question as to the invariability of phonetic law. Yet even then it was realized that etymology (q.v.) without strict adherence to phonetic law was capricious and unscientific. The existence of such law was emphasized by the famous discovery known as Grimm's law (q.v.), which was in its turn supplemented and accentuated anew by the enunciation of Grassmann's law (q.v.), Verner's law (q.v.), and the palatal law, which postulated the existence of *e* in Pre-Indo-Germanic. In 1876 the logical result of phonetic investigations up to that time was given by Leskien, when he stated the theorem that phonetic laws know no exceptions. This was the keynote of the neo-grammarians movement. (See PHILOLOGY.) Osthoff and Brugmann two years later stated the principle in its definite form as follows: "All sound-change, in so far as it operates mechanically, is carried out according to invariable laws." By this modification of Leskien's statement the necessary scope was given for analogy (q.v.) in controverting the action of the laws. Exceptions were, therefore, only apparent, not real, and they were to be explained either by the operation of analogy or as the results of laws yet undiscovered. This latter point had already been emphasized by Leskien, as Whitney had laid stress on the importance of analogy in explanation of many difficult linguistic phenomena. The point at issue was unfortunately shifted, and the gulf between the old and new schools of grammarians widened almost hopelessly. The contention became not the nature of phonetic law, wherein all might, it would seem, be in harmony, but whether the laws were invariable or not, a problem which is yet unsolved. Without going into the details of the long discussions which followed after 1878, where Georg Curtius and Brugmann were the protagonists for the old and new schools respectively, it may be said that the net result has been a distinct gain for the neo-grammarians movement. Phonological and etymological investigation at present tacitly accepts the invariability of phonetic law. At the same time, it is not as rigidly bound by dogmatic adherence to this principle as was the case when the enthusiasm of its novelty was potent. The influence of the doctrine has, then, been most beneficial in enforcing accuracy in the application of the laws, and compelling exact and full explanation of any deviation, however slight, from their normal action. On the other hand, sufficient attention has not yet been devoted to the explanation of the laws themselves. Why, for instance, to revert to the example already given, does Indo-Germanic *ā* become *ō* in certain languages, *a* in others, and in others still remain unchanged? Phonetic changes, instead of being absolutely invariable, are only relatively uniform and obey only general tendencies. These tendencies are governed to a large extent by physiological requirements, and further by psychological processes, especially the associative faculties of analogy, imitation, and the like. Initially the changes are individualistic. If the phonetic change in question is physiologically possible and pleasing to a speech-community, however small, it may be adopted imitatively, and may then be extended analogi-

cally, and being accepted by a widening range of speakers, it may develop into a general tendency, become relatively uniform, and thus be made a phonetic law. These conclusions are confirmed by the study of living, spoken dialects, where the artificial uniformity of script does not mislead the investigator, as is too often the case with languages which have been preserved only in literary forms.

Consult: Curtius, *Zur Kritik der neuesten Sprachforschung* (Leipzig, 1885); Brugmann, *Zum heutigen Stand der Sprachwissenschaft* (ib., 1885); Schmechardt, *Ueber die Lautgesetze* (Berlin, 1885); Delbrück, *Einführung in das Sprachstudium* (3d ed., Leipzig, 1893); Paul, *Prinzipien der Sprachgeschichte* (3d ed., Halle, 1898); Oertel, *Lectures on the Study of Language* (New York, 1901). See GRASSMANN'S LAW; GRIMM'S LAW; PHILOLOGY; PHONETICS; VERNER'S LAW.

PHONETICS. In its broadest sense, a study of the whole range of sounds, articulate, musical, and otherwise. It is, however, usually confined to the articulate sounds of human speech. Even in this restricted sense, it is still broad enough to include the subject of the purely acoustic or mechanical side and the anthropological or philological side. It may discuss simply the vibrations that cause any particular sensation on the human ear, or it may include an investigation of the manner and causes of the change of one articulate sound in one language at one time, into another sound in another language or at another epoch. In the first case it should consider the mechanism and methods by which the sounds are produced, and also the way in which they are made effective in the ear, and impress the brain.

The question of the variations of articulate sounds and of the symbols which from time to time may be used to represent them belongs to the sphere of comparative philology (q.v.), and is not, therefore, discussed in this article.

Confining the attention to the physics of phonetics, the subject naturally falls under three heads, or questions: What is tone quality, or the mechanical difference between two sounds? How are sounds produced in the human voice? and How are they perceived in the ear? The divisions may best be treated in the order given.

One sound differs from another in three factors, pitch, intensity, and quality. (See SOUND.) The pitch and intensity, or loudness, are of but little importance in this connection. The controlling factor is the quality. In articulation the sounds are divided into two broad classes: the vowel sounds, or those which are maintained in more or less uniform quality for an appreciable length of time; and the consonants, or those sounds which are more essentially a peculiar stopping or starting of a vowel sound, and which are apt to form the transition from one vowel to another, by some one of an infinite variety of ways.

Taking up the discussion of the vowel sounds first as being the simpler case, it is evident that these sounds, which last with a uniform character for an appreciable fraction of a second, or at least may be so prolonged, must depend for their distinguishing peculiarities upon the same factors as any other sound. As the pitch of a sound depends upon the length of the wave, and the intensity upon the height of the wave, so

does the quality of the sound depend upon the shape of the wave. It has been demonstrated that any wave motion, no matter how complex, may be considered as made up of a series of simple waves of differing lengths and heights. Therefore, any quality of sound, no matter how complex, is made up of simple components, differing in pitch and intensity. By a simple sound is meant one in which the vibrating particles move in a simple harmonic motion, similar, for example, to that executed by a clock pendulum. When a violinist plays a particular note, it differs from the same note on the organ or the piano or the wind instruments only in the relative number, intensity, and pitch of the 'partials' or 'overtones' which accompany the fundamental, or 'pitch-tone.' In a manner entirely analogous the maintained sounds of the human voice differ one from another, when the same fundamental tone is being produced, only in the relative number, pitch, and intensity of the accompanying partials. It is believed by some that the 'phase-relation' of the components also affects the quality of the sound, but this is still an open question and certainly does not affect the case of articulation.

The question, then, is to determine just what are the particular combinations of elements which form the various vowel sounds. In the first place, it has been shown conclusively that the same relative components will not produce the same vowel sounds on different pitches. For example, a certain combination, bearing a definite relation to a fundamental of 256 vibrations per second, will produce a certain vowel quality, but if the rates of all these components are raised by the same interval of a fifth, the vowel quality will be quite different. In other words, that combination which is recognized as giving a perfectly satisfactory *a*, as in *father*, on a pitch of middle *c*, is entirely different from that which is similarly recognized on a pitch an octave higher.

There are two conceptions at present as to what constitutes the essential characteristic of a particular vowel sound. Some hold that each vowel sound always contains in its complex a certain characteristic tone component of definite pitch, and that the presence of this element makes that vowel. For example, *a*, as in *father*, has its essential vowel tone, and *ee*, as in *meet*, would have a different tone. This theory holds that the pitch of the characteristic elements is constant, irrespective of the pitch of the fundamental, or main tone. Others believe that there is no difference in the question of tone quality in vowels from the same question as applied to any tone. Under this conception there would be no essential component, but all would be essential and the total would be characteristic. This would mean that the difference between *o* and *a* pronounced on treble *c* is of exactly the same character as that between the two sounds when that note is played upon a flute and upon a violin. In other words, vowel quality is no different from tone quality.

The actual solution of this question is enormously complicated by the fact that habit allows the greatest possible variation in what may still be called a particular vowel. For example, the *a* in different individuals may differ more radically than the *a* and *o* in the same individual.

Helmholtz seems to hold to both theories, and gives the following as the pitches of the characteristic tones of the vowels: $U = 175$; $O =$

466; A = 932; Å = 1568; Em = 1976; I = 2349. In like manner he gives the composition of those vowel sounds as made up of a characteristic combination of overtones, as follows:

VOWEL	1	2	3	4	5	6	7	8
U.....	f	pp	pp
O.....	mf	p	p	f	p
Ä (as o in not).....	p	p	p	p	ff	ff	ff	ff
A.....	p	pp	p	f
E.....	p	pp	f	p	p	p	p	p

The letters *p*, *pp*, *f*, *ff*, and *mf* have the usual musical significance.

Nevertheless the greatest difference of opinion exists as to the exact pitch of the characteristic tone, and also as to the particular combination of partials which form the particular vowel sounds. In general it seems well established that in the sound of *a*, as in *father*, the complex consists of the fundamental and the first eight or ten overtones with intensities decreasing as they rise in pitch. *E*, as in *meet*, has not the higher overtones, and is characterized by a relative strengthening of the third and fourth in the series. *O*, as in *moat*, has number four rather strong; and finally *U*, as *oo* in *boot*, is little if anything besides the fundamental and a little of the first overtone. It is to be understood that these overtones are in the series present in a string, or an open pipe, i.e. the rates of vibration of the fundamental and overtones are in the ratio of 1 to 2, 3, 4, 5, etc.

The question of the exact composition of any vowel on any pitch cannot be definitely and finally determined, for the simple reason that the character of the sound differs with every individual, and no one can be said to be right and all the others incorrect. General conclusions can be stated or specific analyses in particular cases.

As to the quality of the sounds in the pronunciation of the consonants little can be said at present, as the case is much more complex than that of the vowels. On the one hand, the quality is rapidly changing from instant to instant, thus offering new and especial difficulties to the analyst; and on the other hand, the simple more or less musical tones are often accompanied by a number of irregular noises like the hiss, the aspirate, etc. There are also the peculiar methods of stopping and starting the sounds, as in *p*, *b*, *d*, *g*, etc., in initials or finals. A class exists where a neutral sound is produced in the larynx, and formed into *m*, or *n*, or *th*, etc., according to the way in which the air is permitted to escape, by the nose or mouth.

Thus far no rigid analysis of the consonants has been possible, although the individual variations may be less than in the vowels.

The second branch of the subject is the apparatus and method of production of human articulate sounds. This function is performed by the joint action of the lungs, larynx, mouth, and nose. The lungs are simply the wind box, and serve to supply the air to actuate the vocal cords and produce the various sounds; they supply the raw material, and are the source of energy.

In the larynx (q.v.) is to be found the original source of all the sustained sounds that bear any resemblance to musical tones. Whisperings, hisses, aspirates, etc., are formed independent of the larynx. In the larynx is to be found a pair

of cords or membranes, which may be so drawn together over the top of the windpipe that they practically close it. If air from the lungs is forced against the cords under the above condi-

tions, they are set into vibration and produce a sound. The pitch of this sound is regulated by the length, weight, and tension of these cords, there being present in the larynx sets of muscles for the involuntary control of these three factors which determine the pitch of a vibrating cord. Confining the attention again to the vowel sounds, it may be said that the function of the larynx is to produce a sound which can be molded into any one of the vowels, and that its action is not determinative as to which vowel shall be produced. Articulation is not performed by the larynx, but by the agencies between it and the outer air. The particular variation of tone that is produced by an individual depends upon the cavities of the mouth and nose, the position of the various movable parts, as the tongue and palate, and the size and shape of the opening at the teeth or lips. In the flute and clarinet it is the number and location of the openings which determine the pitch to a large extent, but in the human voice it is the larynx which determines the pitch of the fundamental, and the size, shape, and openings of the cavities of the mouth and nose determine the quality of the sound, i.e. the vowel sound produced. Resonance as applied to this subject means that property of a mass of air by virtue of which it can pick up and intensify the vibrations which fall upon it when those vibrations are of a frequency bearing the proper relation to the size, shape, and opening of the air mass. The vocal cords produce a complex sound composed of a fundamental and a more or less complicated series of over tones; this sound passing out through the cavities of the mouth and nose has certain tones reinforced by virtue of the resonance of the cavities, while other components are practically smothered out from finding no means of reinforcement.

Cases are on record where the whole larynx has been removed and a silver one substituted, so arranged that a simple reed could be inserted, and the patient could articulate just as well as before, with the sole difference that he spoke always on the same fundamental pitch. The system of phonetic writing devised by Alexander Melville Bell, by means of which an expert can represent perfectly any sound, articulate or inarticulate, by simply using a set of symbols that tells the speaker how to place the parts of the mouth, and how to use the breath and voice, is a practical proof that articulation proper is done above the larynx. Evidence in this case is also furnished by the methods of teaching deaf mutes to speak and to some extent by their ability to tell the meaning from the motions of the lips. Individual or race peculiarities of pronunciation may, of course, be due to peculiarities in the dimensions and character of the vocal cords and larynx, as well as to the cavities of the mouth and nose,

etc., but these elements are persistent and affect the voice accordingly.

The third and last element that must be considered under the physics of phonetics is the sound receiving apparatus of the human being. The ear (q.v.) consists of three essentially different parts: the interior ear, where are situated the nerves which perform the actual hearing; the intermediate ear, consisting of a series of little bones which transmit the vibrations of the ear drum to the nerves within; and finally the drum and external ear. The drum takes up the vibrations which fall upon it, and transmits them to the nerves. All of these parts have little or no effect upon the quality of the sound perceived, provided the ear is well and normal. The external ear, however, acting as a collector of the air vibrations and concentrating them upon the drum, does to some extent act as a resonator and distort the quality of the sound produced. This is practically constant for an individual and is not noticed, but it may vary considerably in different individuals, and hence the same sound complex may seem really different to two individuals by the time it reaches the real hearing mechanism.

BIBLIOGRAPHY. The standard work is Sievers, *Grundzüge der Phonetik* (5th ed., Leipzig, 1901), which has a full bibliography. Consult also: Bell, *Visible Speech* (London, 1867); Ellis, *Early English Pronunciation* (ib., 1869-89); Sweet, *Hand-book of Phonetics* (Oxford, 1878); Teichner, *Phonetik* (Leipzig, 1880); Meyer, *Organs of Speech and Their Application in Formation of Sounds* (London, 1883); Trautmann, *Die Sprachlaute in allgemeinen und die Laute des Englischen, Französischen und Deutschen in besondern* (Leipzig, 1884-86); Sweet, *A History of English Sounds from the Earliest Period* (2d ed., Oxford, 1888); Bell, *World English* (London, 1888); Rousselot, *La méthode graphique appliquée à la recherche des transformations inconscientes du langage* (Paris, 1891); Passy, *Etudes sur les changements phonétiques et leurs caractères généraux* (ib., 1891); Weeks, "A Method of Recording the Soft Palate Movements in Speech," in *Harvard Studies and Notes in Philology and Literature*, vol. ii. (Boston, 1891); Bremer, *Deutsche Phonetik* (Leipzig, 1893); Bell, *Sounds and Their Relations* (2d ed., Washington, 1894); Lloyd, "Speech Sounds: Their Nature and Causation," in *Phonetische Studien*, vol. iii. (Munich, 1898); Victor, *Elemente der Phonetik des Deutschen, Englischen und Französischen* (4th ed., Leipzig, 1898); Soames, *An Introduction to Phonetics* (London, 1899); Scripture, *The Elements of Experimental Phonetics* (New York, 1902).

PHONETIC SPELLING. Spelling according to sound. See **ORTHOGRAPHY**; **SHORTHAND**; **SPELLING REFORM**.

PHONETIC WRITING. Writing according to sound. In the case of languages which have not previously been reduced to writing and thus acquired a stereotyped orthography, phonetic writing is necessarily regularly employed. In

this way many Polynesian, African, and American Indian dialects have received a written form. In languages which already possess an established orthography, phonetic writing is employed either in shorthand or in so-called spelling reform. In the former case the phonographic shorthand signs are afterwards transliterated into the conventional orthography. In the latter instance the sound as heard by the writer is preserved at the expense of the etymology and very frequently of consistency, the same word often being variously written in phonetic spelling by different writers, and with a more or less cumbrous system of arbitrary diacritical letters. In indicating the exact pronunciation of words whose orthography does not represent the sound, some exact system of phonetic writing is usually employed. See **ORTHOGRAPHY**; **SHORTHAND**; **SPELLING REFORM**.

PHONOGRAPH (from Gk. *φωνή*, *phōnē*, sound, voice + *γράφειν*, *graphōin*, to write). The first mechanical device for the registering and reproduction of speech or other sound was the invention of Leon Scott, known as the phonautograph and constructed in 1855. It consisted simply of an ellipsoidal barrel. In this apparatus the sound receiver was open at one end and closed at the other. From the closed end projected a

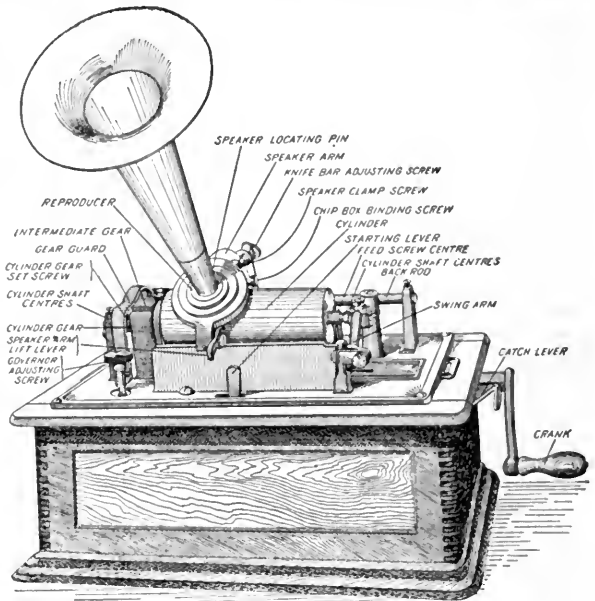

EDISON PHONOGRAPH.

small tube, across which was stretched a flexible membrane, to the centre of which by means of sealing wax was affixed a bristle, which acted as a stylus, and vibrated with the membrane. In front of the membrane was placed a horizontal cylinder, which was wrapped with a sheet of paper, covered with a thin layer of lampblack, against which the bristle rested lightly. Any sound vibrations entering the ellipsoid were transmitted by the membrane to the stylus, which, when the cylinder was made to revolve, and to advance slowly, described on the lampblack surface a zig-zag line which was thus practically a phonographic record of whatever vibrations had been produced.

The invention of Leon Scott embodies the essential principles on which recording and reproducing instruments of the present day are based. If now we substitute a receiving funnel for the clipsoid, a more rigid or metal stylus for the bristle, and a tin-foil covered cylinder for the lampblack one, we have the phonograph of Thomas A. Edison, as it was originally constructed in 1877; with this essential difference, however, that the sound vibrations were now indented instead of being traced. By reversing the machine—that is, causing a blunt stylus to travel over the indentations made, the original sound was reproduced. Great expectations were entertained of this invention at the time; but it

the wax, the cutting stylus advancing horizontally as the cylinder revolves. In reproducing, another diaphragm, which differs from the first in that it has a different tool and is made of sheets of mica, is employed. The cutting or recording stylus consists of a sapphire with a cup-shaped front which is ground to a fine edge. The reproducing stylus, on the other hand, has a ball-shaped point. This stylus follows the track cut out by the recording stylus. Its motion causes the diaphragm to vibrate, and thus to reproduce the original sound. The machine gets its power from a small electric motor or spring. The sound thus reproduced is not at all equal in volume to the original, but may be strengthened by means of a funnel attached to a reproducer, and by adjusting the speed of the machine sounds may be given out with sufficient loudness to be heard by all in a room. In using a cylinder that already contains a phonographic record, a sharp knife precedes the cutting stylus, thus removing the previous record. A record once made can be reproduced several thousand times without perceptible impairment of its quality, and a record made on one machine can be reproduced on another, thus admitting of the cylinder's being used for mailing, as in ordinary correspondence. There is no limit to the speed with which sounds can be recorded, nor to the number and variety of sounds. The difficulty of concentrating the sounds upon the diaphragm is surmounted in factories where musical and other records are constructed by grouping together the persons or instruments whose sound is recorded. By increasing the speed of the cylinder the pitch is raised, and by lessening it the pitch is lowered. See GRAMOPHONE.

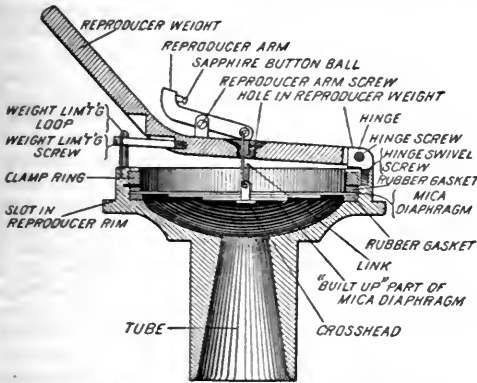

SECTION OF REPRODUCING APPARATUS OF EDISON PHONOGRAPH.

was found that after a few repetitions the record became effaced from the tin foil and the invention proved to be scarcely more than an interesting toy.

During the year 1888 Mr. Edison placed upon the market a phonograph which was a far more elaborate machine as well as more practical than any of its predecessors. The tin-foil gave place to a wax cylinder, which, as shown in the illustration, is slipped over and held on a mandrel. The recording and reproducing devices differ slightly and are shown in the accompanying figures. In operating, the wax cylinder is made to revolve. In talking into the funnel, the malle-

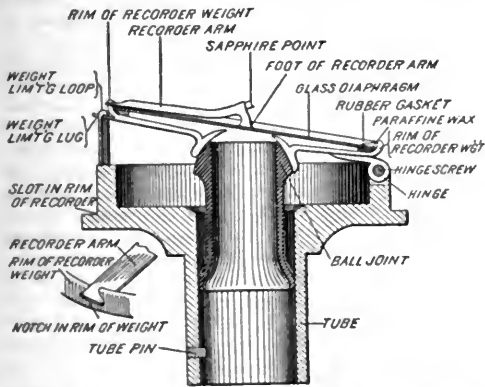

SECTION OF RECORDING APPARATUS OF EDISON PHONOGRAPH.

able glass diaphragm, with a cutting stylus on its under surface, is made to vibrate, and a register of the sound is thus cut vertically into

PHONOGRAPHY. See SHORTHAND.

PHONOLITE (from Gk. φωνή, *phōnē*, sound, voice + λίθος, *lithos*, stone). An igneous rock of porphyritic texture which has a chemical composition essentially equivalent to nephelene syenite (q.v.), and generally contains porphyritic crystals of feldspar (sanadine) and nephelene. Most phonolites have been poured out at the surface of the earth as lavas; as, for example, in the Auvergne of Central France, and in the Cape Verde Islands. Many phonolites possess a platy parting or separation by cracks into a series of parallel plates, so that they give out a peculiar sound when struck with a hammer. On this account they were formerly known as clinkstones. More subject to alteration from atmospheric agencies than most other rocks, they soon lose their fresh appearance, and frequently show the development of crystals of the zeolite minerals.

PHORADEN'DRON. An American plant. See MISTLETOE.

PHOR'BAS (Lat., from Gk. Φόρβας). (1) A son of Lapithes and Orsinome, who freed Rhodes from snakes and was honored by the inhabitants as a hero. He was called *ophiuchus* (the snake-holder) and given a place among the stars. In another legend, Alector, King of Elis, secured his assistance against Pelops, and gave him his daughter, sharing the kingdom with him. (2) A companion of Aeneas. The god of sleep assumed his form in order to deceive Palinurus.

PHOR'CUS, PHORCYS, or PHORCYN. In Greek mythology, an aged divinity of the sea. Hesiod and others make him the son of Pontus and Gaea, and brother of Nereus and Ceto. By

the latter he became the father of the Graces and Gorgons, who are hence called Phoricides or Phorceydes. He was also the father of the nymph Thoosa, who became the mother of Polyphemus, the Hesperides, and the Sirens.

PHORMIO. A lively and interesting comedy by Terence, produced in B.C. 161. It takes its name from the parasite in the play, which was modeled on the *Ἐπιδικαζόμενος* of Apollodorus. From this comedy Molière drew the plot of his *Fourberies de Scapin*.

PHORONIS (Neo-Lat., from Gk. *Φορωνίς*, relating to Phoroneus, from *Φορωνεύς*, *Phorōneus*, Phoroneus, an ancient Greek King of Argos). A marine worm-like animal recently decided to be in a class by itself (Phoronidea). It lives socially, each worm inclosed in a membranaceous or leathery tube. The body is long, slender, not segmented, and around the mouth is a crown of long delicate ciliated tentacles borne on a horseshoe-shaped lophophore. It is hermaphroditic, developing from eggs, and never asexually from buds. The larva is very remarkable; it is a modified trochosphere, and is called an 'actinotrocha.' It may be recognized by the large hood-like lobe overhanging the mouth, while there is a post-oral circle of large ciliated finger-like tentacles; it rapidly metamorphoses into the polyzoön-like adult. It occurs on the coasts of Northern New England and in Europe, while another species inhabits the Australian seas. Consult Harmer, *Cambridge Natural History*, vol. ii. (London, 1899).

PHORORHACHOS, *fō'rō-rā'kōs* (Neo-Lat., from Gk. *φορά*, *phora*, motion, from *φέρειν*, *pherein*, to bear + *ῥαχός*, *rhacos*, brier). A gigantic extinct running bird of prey, skeletons of which are found in the Miocene deposits of Patagonia. It was about 8 feet in height and its skull was larger than that of a horse and armed with a strong hooked beak like that of an eagle. The wings were small and useless, and the legs long and strong and provided with powerful talons. It appears to have been a swiftly running bird, like the ostrich, though actually related to the herons. Consult Lucas, *Animals of the Past* (New York, 1901).

PHOSGENE GAS (from Gk. *φῶς*, *phōs*, light + *γενής*, *-genēs*, producing, from *γίγνεσθαι*, *gignesthai*, to become), CARBONYL CHLORIDE, or OXYCHLORIDE OF CARBON, COCl_2 . A colorless suffocating gas which is formed by exposing equal volumes of carbonic oxide and chlorine to the action of sunlight. If brought into contact with water, phosgene gas rapidly decomposes into carbonic and hydrochloric acids. It may be readily condensed to a liquid, boiling at 8° C. It is largely used in chemical laboratories, as it readily reacts with various substances, so that many organic syntheses can be carried out with the aid of it. It is also employed in the manufacture of certain coal-tar dyestuffs. Phosgene was first prepared by J. Davy in 1811, its name indicating that it was formed under the influence of light.

PHOSPHATES (from *phosphorus*) (in physiology). The following phosphates play an active part in the chemistry of the animal body.

Phosphate of soda occurs in three forms, NaPO_3 , Na_2HPO_4 , and in NaH_2PO_4 , called respectively the basic, neutral, and acid salts. These are all

soluble in water. By exposing the second of these salts to a red heat *pyrophosphate* of soda, $\text{Na}_2\text{P}_2\text{O}_7$, is formed, and by similarly treating the third, *metaphosphate*, NaPO_3 , results. Phosphate of soda in one or the other of the above forms is a constituent of all the fluids and soft tissues of the body, and is especially abundant in the urine and bile. Pyrophosphate and metaphosphate of soda are found in the ashes of animal tissues after incineration, but they result merely from the action of heat on the neutral and acid salts. The salts of sodium are always associated with the corresponding salts of potassium, and what is said of the derivation, elimination, and physiological importance of the one is equally applicable to the other. The alkaline phosphates obviously are derived from the food, being either ingested as such or converted within the organism from other alkaline salts. Elimination is effected chiefly through the kidneys and intestinal canal. In the carnivorous animals, whose blood is much richer in phosphates than that of herbivora (the ash of the blood of the dog, for example, contains from 12 to 14 per cent. of phosphoric acid, while that of the ox or sheep does not contain more than from 4 to 6), these salts are carried off by the urine; but in consequence of the formation of free acids as products of the disintegration of the tissues, a portion of the base is abstracted from the originally alkaline phosphates, and a corresponding portion of phosphoric acid is liberated. The originally alkaline salt is thus rendered neutral or even acid; and the occurrence of the acid phosphate of soda, NaH_2PO_4 , in the urine is thus explained. In the herbivorous animals, on the other hand, the urine contains no phosphates, the whole of the phosphoric acid taken in their food being eliminated by the intestinal canal in the form of the insoluble phosphates of lime and magnesia. Although the general distribution of the phosphates of the alkalies in the nutrient fluids (there is 40 per cent. of them in the ash of the blood-cells; 28.4 per cent. of phosphoric acid and 23.5 of potash in the ash of cow's milk; and about 70 per cent. of phosphoric acid in the ash of the yolk of egg) is in itself an indication of their importance, the exact nature of their functions is not completely understood. Liebig has specially drawn attention to the peculiar grouping of the acid and alkaline fluids of the animal body. The permanence of this grouping is chiefly maintained, especially in herbivorous animals, by the conversion within the body of alkaline and neutral phosphates into acid phosphates by the means already described. Moreover, all tissue-forming substances (the protein bodies) are so closely connected with phosphates that they remain associated during the solution and subsequent re-precipitation of these substances; and the ash of developed tissues (such as muscle, lung, liver, etc.) always affords evidence that acid phosphates existed in the recent tissue; and, further, no exudation from the blood-vessels can undergo transformation into cells and fibres, or, in other words, become organized, unless phosphates are present. Another proof of the share taken by the phosphates in the formation and functions of tissue is the fact that, although herbivorous animals take up a very small quantity of phosphates in their food, and although their blood is very poor in these salts, their tissues contain as large a proportion of phosphates as the corresponding parts of car-

nivora. Lastly, the fact that one equivalent of the alkaline phosphate of soda, Na_2HPO_4 , possesses the property of absorbing as much carbonic acid as two equivalents of carbonate of soda, leads to the belief that the power of attracting carbonic acid, which the serum of the blood possesses, is due as much to the phosphate as to the carbonate of soda, and that, consequently, phosphate of soda plays an important part in the respiratory process.

Phosphate of lime occurs in the organism in three forms, viz.: as the normal calcium phosphate, $\text{Ca}_3(\text{PO}_4)_2$, the monocalcic calcium phosphate, $\text{Ca}(\text{H}_2\text{PO}_4)_2$, also called acid phosphate, and the dicalcic phosphate, $\text{Ca}_2(\text{HPO}_4)_2$. The normal phosphate occurs in all the solids and fluids of the body, but is most abundant in the bones, in which it amounts to about 57 per cent.; and in the enamel of the teeth, in which it ranges from 80 to 90 per cent. It may at first sight appear inexplicable how a salt so perfectly insoluble in water as normal phosphate of lime can be held in solution in the animal fluids. In some fluids, as the blood, it is probably, in part, at least, combined with albumen, with which it forms a soluble compound; while in other fluids, as the urine, it is held in solution by a free acid or by certain salts (as, for example, chloride of sodium), whose watery solutions are more or less able to dissolve it. When too small a quantity of this salt is taken with the food, the bones lose more or less of their hardness and firmness, and fractures do not readily unite. Phosphate of lime, like the phosphates of the alkalis, is indispensable to cell-formation; and in the mantle of the mollusks (where new cells for the formation of shell abound) this salt is far more abundant than in any other part of the body. Although by far the greater quantity of the phosphate of lime found in the body has doubtless preëxisted in the food, yet it is unquestionable that a part of it is formed within the organism by the action of carbonate of lime on the phosphoric acid that is formed during the disintegration of the phosphorus-containing tissues, such as the brain. In man and carnivorous animals, a certain portion of the phosphate of lime is eliminated by the kidneys, and the rest is carried off in the excrements; while in herbivorous animals the whole is carried off in the excrements. The acid phosphate of lime is occasionally found in the urine of man and carnivorous animals, but is of no practical importance. For the amount of earthy phosphates daily eliminated by the kidneys, see URINE.

Normal phosphate of magnesia, $\text{Mg}_3(\text{PO}_4)_2$, is analogous, both in its chemical and physiological relations, to the corresponding salt of lime, with which it is always associated. The abundance of this salt in cereals and vegetables explains its presence in the system. A far less amount of this salt than of the corresponding lime-salt seems to be required by the organism, as is shown by the relative quantities in which they occur in bone (57 of the former to 1.3 of the latter), and as is further indicated by the fact that, relatively, far more of this than of the lime-salt escapes intestinal absorption, and appears in the excrements.

The only phosphates remaining to be noticed are the *phosphate of ammonia and magnesia*, or, triple phosphate, $\text{MgNH}_4\text{PO}_4 + 6\text{H}_2\text{O}$, which occurs in beautiful prismatic crystals in alkaline

urine and urine that is beginning to putrefy, and the *phosphate of soda and ammonia*, which is occasionally found as a crystalline sediment in putrid urine.

PHOSPHATIC DIATHESIS, or PHOSPHATURIA. The excretion in excessive amounts of the earthy salts of phosphoric acid in the urine. Phosphoric acid is excreted in combination with the alkaline bases, sodium and potassium, and the earthy bases, calcium and magnesium. The alkaline phosphates form about two-thirds of the whole, and are always held in solution; the earthy phosphates form about one-third and are spontaneously precipitated under certain circumstances as phosphatic deposits and calculi. One of the causes of such deposition is an alkaline condition of the urine. The urine in health may be temporarily alkaline from eating much fruit or vegetables containing citrates, tartrates, or malates of potassium and sodium. These are converted into carbonates in the intestines and absorbed as such into the blood, and diminish the acidity of the urine or render it alkaline. The urine is sometimes turbid from a white deposit of the amorphous calcium phosphate ($\text{Ca}_3\text{P}_2\text{O}_8$). This may be mixed with a crystalline phosphate ($\text{CaHPO}_4 + 2\text{H}_2\text{O}$), the so-called stellar phosphate, or a phosphate of magnesia ($\text{Mg}_3\text{P}_2\text{O}_8$). A more common condition, however, is that observed when a feebly acid or neutral urine is heated and a thick white deposit or turbidity occurs. In urine which has undergone ammoniacal fermentation there occurs a precipitate of the ammonio-magnesium or triple phosphate ($\text{MgNH}_4\text{PO}_4 + 6\text{H}_2\text{O}$), in the form of minute triangular prisms.

It has been thought that there is a relation between the activity of the nervous system and the excretion of phosphoric acid. An increased amount is seen in the urine after excessive mental work or worry. This phenomenon is also observed in many diseases characterized by wasting and debility, such as phthisis, leucocythæmia, acute yellow atrophy of the liver, and severe anæmias. The old term 'phosphatic diathesis,' signifying a constitutional tendency or habit of body that produced or promoted a deposition of the phosphates from the urine, is no longer recognized.

PHOSPHATIC FERTILIZERS. See MANURES AND MANURING.

PHOSPHINE. See PHOSPHORUS.

PHOSPHOR-BRONZE. An alloy consisting of copper, zinc, and tin in various proportions, with a small quantity of phosphorus which has been introduced in the form of phosphor-tin. The addition of phosphorus has the effect of eliminating the oxides, and, by causing the tin to assume a crystalline structure, increases the homogeneity of the alloy, and thereby its elasticity and absolute resistance. In consequence, phosphor-bronze has met with considerable demand where special strength or power of resisting wear is required, as in the case of bearings for quick-running machinery.

PHOSPHORESCENCE. It has been observed that many bodies continue to emit light in a darkened room after having been exposed to sunlight or some other strong source of light. This phenomenon is called phosphorescence. Although the name is evidently derived from 'phosphorus,'

it should be noted that the cause of the luminosity of phosphorus is a slow oxidation, and is not due to its having been previously exposed to light. Phosphorescence itself is a special case of fluorescence (q.v.), and cases where there are permanent chemical changes are excluded. Those substances which phosphoresce most brilliantly are the sulphides of barium, calcium, and other alkaline earths, diamonds, sugar, etc. It has been found that the phosphorescent light is often brilliantly colored, and also that the color of the light to which the body is exposed in order to excite phosphorescence has a very important influence upon the intensity of the phosphorescent light itself. It is observed that the same law connecting the exciting light and the phosphorescent light holds true as was noted in the case of fluorescence, namely, that the phosphorescent light is of a longer wave-length than the exciting light. A distinction has been drawn between phosphorescence and fluorescence from the fact that only fluids exhibit fluorescence, while only solid bodies exhibit phosphorescence. Nearly all bodies which show fluorescence will show phosphorescence when in the solid state, as, for instance, if when liquid they are dissolved in gelatin and then dried. One of the earliest and most important investigations of phosphorescence was made by E. Becquerel, who made a special study of the interval of time phosphorescence would continue after the phosphorescing body was removed from the light. He invented an instrument known as the phosphoscope, which enabled him to measure with the greatest exactness the small intervals of time involved in the phenomena. He observed that many bodies in which by ordinary means of observation there was no trace of phosphorescence can be shown to phosphoresce for minute fractions of a second. For instance, after exposure to sunlight, calcite shines with orange-colored light; aragonite gives a greenish light, as does lead glass also; uranium glass shines with a greenish light which lasts for about one-thirtieth of a second, although it has its maximum intensity at about one three-hundredth of a second after the sunlight has been withdrawn. Sapphires and rubies give a brilliant pure red light, as do almost all the minerals which contain aluminum.

One most interesting feature of phosphorescence is that if a body is phosphorescing, as for instance a piece of paper covered with Balmain's paint, the application of heat at any one point will destroy the phosphorescence there. This evidently furnishes a method for the study of those portions of the spectra which lie in the infra-red region; i.e. those wave-lengths which are too long to affect our sense of sight. For if a strip of paper covered with Balmain's paint is exposed to sunlight for a short time and then taken into a darkened room and so placed that the infra-red spectrum coming from any source falls upon the paper, those places where there is radiation will be made manifest by the disappearance of phosphorescence owing to the heating effect of the rays of the spectrum. This procedure has been improved by Draper and Lommel, and now forms one of the best methods used in spectrum analysis. See LIGHT; FLUORESCENCE.

PHOSPHORESCENCE OF THE SEA. See LUMINOSITY OF ANIMALS.

PHOSPHORIC ACID, H_3PO_4 . An acid compound of phosphorus, hydrogen, and oxygen, first

obtained by Scheele in 1777. It may be prepared by cautiously heating yellow phosphorus with dilute nitric acid for several hours and driving off the excess of nitric acid by heat. Pure phosphoric acid is a colorless crystalline substance melting at about $41^\circ C$. It is a tri-basic acid, the three hydrogen atoms in its molecule being replaced gradually and the result being three series of salts, like NaH_2PO_4 , Na_2HPO_4 , and Na_3PO_4 . The 'neutral' salts of the alkali metals have a strongly alkaline reaction. When heated above $300^\circ C$. phosphoric acid is converted into pyrophosphoric acid, $H_4P_2O_7$, which was first prepared by Gay-Lussac in 1829. Several of the salts of phosphoric acid are used in medicine. The most important phosphates are described under the names of the metals. See also PHOSPHORUS.

PHOSPHORITE. The massive, concretionary, and mammillary form of apatite, especially the variety found in Estremadura, Spain. The name was first used by Kirwan in describing the phosphates found in Spain, which occur in veins and in pockets in the Silurian schists.

PHOSPHOROSCOPE (from Lat. *phosphorus*, Lucifer, phosphorus + Gk. *σκοπεῖν*, *skopein*, to behold). An apparatus invented by Becquerel for measuring the duration of phosphorescence in different bodies. See PHOSPHORESCENCE.

PHOSPHOROUS ACID, H_3PO_3 . A di-basic acid formed by the action of water on trichloride of phosphorus. It is a crystalline substance melting at $70^\circ C$. Its salts are termed phosphites.

PHOSPHORUS. One of the non-metallic chemical elements. It was discovered by Brand, a Hamburg alchemist, in 1669, while experimenting with urine with a view to preparing a liquid for the transformation of silver into gold. Kunekel, on learning of the discovery, without, however, knowing the method, invented a process of his own for the extraction of phosphorus from urine, and in 1678 published a work entitled *De Phosphoro Mirabili*. The existence of phosphorus in bones was discovered either by Gahn (about 1769) or by Scheele (1771), and subsequently phosphorus became a well-known and cheap substance, variously called Brand's phosphorus, Kunekel's phosphorus, Kraft's phosphorus, Boyle's phosphorus, and English phosphorus, while the name phosphorus, unqualified, was applied to phosphorescent substances in general until the antiphlogistic nomenclature introduced the present usage. The elementary nature of phosphorus was first recognized by Lavoisier. See CHEMISTRY.

Phosphorus does not occur free in nature, but is found abundantly in the form of phosphates. The minerals of the apatite group (combinations of calcium phosphate with calcium chloro-fluoride), struvite, vivianite, wavelite, and many other minerals contain considerable amounts of chemically combined phosphorus. But the principal source of phosphorus is still the substance of bones, which consists chiefly of the neutral phosphate of calcium. Calcium phosphate is also the chief constituent of coprolites and guanos, and calcium and magnesium phosphates are found in the ashes of plants. Ammonium-magnesium phosphate is the chief constituent of urinary sediments, while in combination with carbon, hydrogen, oxygen, and nitrogen, phosphorus is found in

the yolk of eggs, in the blood and other animal fluids, and in the substance of the brain and nerves.

To obtain phosphorus, bones are burned to destroy their organic matter and are treated with sulphuric acid, which converts the neutral phosphate $\text{Ca}_3(\text{PO}_4)_2$ into the soluble acid phosphate, $\text{CaH}_2(\text{PO}_4)_2$. The solution of the latter is evaporated to dryness, charcoal is added to the residue, and the mixture is strongly heated, when two processes take place in immediate succession, the first consisting in the transformation of the acid calcium phosphate into calcium metaphosphate, $\text{Ca}(\text{PO}_3)_2$, the second in the partial decomposition of the metaphosphate by the charcoal, resulting in the formation of free phosphorus, some neutral calcium phosphate, and carbonic oxide gas. The phosphorus vapors are condensed under water in suitable vessels of clay. The crude product thus obtained may be somewhat purified by melting under water and pressing through porous plates. Arsenic, an impurity usually introduced with the sulphuric acid employed in the manufacture of phosphorus, may be removed by means of nitric acid. When pure, the phosphorus is melted and cast in the form of sticks by sucking it into glass tubes and allowing to solidify.

The chemical symbol of phosphorus is P; its atomic weight is 31. The properties of free phosphorus are not always the same, the element being capable of existing in several different allotropic forms. (See ALLOTROPY.) The vapor of phosphorus has invariably the same density, leading to the molecular formula P_4 . (See MOLECULES—MOLECULAR WEIGHTS.) Experiment leads to the view that when dissolved in benzene phosphorus has a similar constitution. But the remarkable differences between the liquid and the several solid modifications of the element are by no means understood. Common or yellow phosphorus, which is ordinarily obtained by the manufacturer, is a transparent waxy substance that may be prepared in the form of crystals of the regular system by sublimation or by crystallization from solutions in carbon disulphide, in which the other varieties of phosphorus are insoluble. Its melting-point is 44.5°C . and its specific gravity at 0°C . is 1.837. It phosphoresces in the dark, and although it has been shown to exhibit this phenomenon when kept in gases incapable of reacting with it, it is quite certain that in all such cases the phosphorescence is caused by the presence of traces of oxygen, which oxidizes yellow phosphorus very readily. As a matter of fact, when kept in a vacuum or in gases which have been thoroughly freed from oxygen, phosphorus gives off no light. In the air, at ordinary temperatures, yellow phosphorus undergoes slow oxidation (see OZONE), and may readily take fire even if carelessly rubbed. It may be caused to burn under water by gently warming the latter and passing a current of oxygen into it. Besides, yellow phosphorus is extremely poisonous. It must therefore be handled with great care. The use of phosphorus for matches is well known. (See MATCHES.) *Red phosphorus* was discovered by Schrötter, of Vienna, in 1845. It is gradually formed by the action of light, especially violet rays, on common phosphorus, but may be conveniently prepared by simply heating the latter to about 250°C . (450°F .), in an atmosphere of carbonic acid, nitrogen, or some other inert gas. If heated to about 300°

C ., red phosphorus is reconverted into the common yellow modification. The specific gravity of red phosphorus is about 2.14, and it does not melt. It does not phosphoresce in the dark, is not poisonous, and is in every way perfectly harmless. (See MATCHES.) *Crystalline* ('metallic') phosphorus is formed during the solidification of molten amorphous phosphorus. It may be obtained in the form of long red tabular crystals having a distinct metallic lustre. Its specific gravity is 2.34. *Black phosphorus* is formed when melted yellow phosphorus is rapidly cooled. Two other allotropic varieties of phosphorus have been described, but deserve no mention here.

COMPOUNDS OF PHOSPHORUS. Phosphorus forms at least three different compounds with hydrogen: viz. a solid hydrogen phosphate, P_4H_2 ; a liquid phosphide, P_2H_4 ; and a gaseous phosphide, PH_3 , called phosphine. The last-named compound, analogous to ammonia (NH_3), is usually prepared by heating phosphorus with a strong solution of caustic potash. When thus prepared, however, it contains some vapor of the liquid phosphide, P_2H_4 , and as the latter takes fire spontaneously in the air, the impure phosphine, too, is inflammable. But under the influence of light, or by the action of strong hydrochloric or sulphuric acid, and certain other substances, the vapor of the liquid phosphide is decomposed; and if pure phosphine is prepared, say, by passing the impure gas through concentrated hydrochloric acid, it is found not to take fire in the air. The odor of phosphine resembles that of garlic and of rotten fish. The oxides of phosphorus include phosphorus trioxide, P_2O_3 , and phosphorus pentoxide, P_2O_5 . The latter, usually termed 'phosphoric' anhydride, is formed when common phosphorus burns in the air. It forms a white, exceedingly hygroscopic powder, taking up water with great energy to form phosphoric acid. With the halogens phosphorus forms a trichloride, PCl_3 ; a pentachloride, PCl_5 ; a tribromide, PBr_3 ; a pentabromide, PBr_5 ; and a triiodide, PI_3 . All these compounds are formed by the direct union of the elements. A tri-fluoride, PF_3 , and a pentafluoride, PF_5 , are also known.

Phosphorus is a constituent of many tissues, especially the nerve-centres, and its physiological action is that of a tonic. It is chiefly used in medicine in nerve exhaustion, myelitis, neuralgia, osteomalacia, and rickets. It has been used with success in lupus, acne, and psoriasis. It may be given in pill or in solution, the latter being preferable. It may be exhibited dissolved in oil or in chloroform. Phosphide of zinc has been used as a substitute for phosphorus. See ANTIDOTES.

PHOSPHORUS (Lat., from Gk. φωσφόρος, light-bringer). A name of the planet Venus as the morning star, also called Lucifer. As an evening star it is called Hesperus and Vesper.

PHOTIUS, fō'zhī-ūs (Lat., from Gk. Φώτιος) (c.820-c.891). Patriarch of Constantinople, one of the greatest theologians and scholars of the Greek Church. He was a member of a patrician family of Constantinople, and during the first period of his life filled various important public offices. In 857 Bardas, minister of the young Emperor, Michael III., undertook to remove the Patriarch Ignatius (see IGNATIUS, SAINT) from his position, and Photius, after being hurried through all the clerical offices in a few days, was put in his place. Pope Nicholas I. (q.v.) espoused the

cause of Ignatius and excommunicated Photius in 863. The latter maintained his position, supported by the Court, and in 867 assembled a council at Constantinople which excommunicated the Pope and his partisans, and withdrew from communion with the See of Rome. (See GREEK CHURCH.) The same year Basil I. succeeded Michael as Emperor, Photius was deposed and Ignatius reinstated. Ten years later, after the death of Ignatius, Photius was restored, and the Pope, John VIII., was induced to acquiesce; but in 881 he also excommunicated the Patriarch, whose relations with Rome continued unfriendly the rest of his life. In 886 the Emperor Leo banished Photius to an Armenian cloister, and he died there about five years later. Photius is revered by the Greek Church, while the Western Church accuses him of craft, violence, and perjury. His theological works include the *Amphilochia*, which not only discusses doctrinal and exegetical questions, but treats also of philosophy, science, medicine, grammar, and history; commentaries on the Gospels and Epistles; and a treatise in favor of the Greek doctrine of the procession of the Holy Spirit. The *Nomocanon* ascribed to Photius is of doubtful authorship. His chief literary and scholarly work is the *Myriobiblion* or *Bibliotheca*, a summary review of nearly 300 works which he had read, most of which are now lost. He also wrote a *Lexicon*, for use in reading the classic authors and the Scriptures. A number of Photius's letters are preserved, as well as sermons of much merit. His works are in Migne, *Patrologia Græca*, ci.-ev. Consult: Hergenröther, *Photius, Patriarch von Constantinopel* (3 vols., Regensburg, 1867-69); id., *Monumenta Græca ad Photium Spectantia* (ib., 1869).

PHOTO-CHEMISTRY. The branch of general chemistry that deals with chemical changes immediately producing or caused by light. In interpreting this definition it must be borne in mind that the combustion of illuminants cannot properly be classed as a form of photo-chemical changes, for the reason that combustion transforms the chemical energy of the illuminant, primarily not into light, but into heat, the latter then giving rise to the production of light. The chemical changes immediately producing light include those undoubtedly taking place at ordinary temperatures in the fireflies and other luminescent organisms, as well as in the eye. All such changes are as yet very imperfectly understood, and photo-chemical research has been confined almost exclusively to the opposite phenomenon, i.e. to chemical changes caused by light.

ACTINOMETRY. That light is capable of causing chemical transformations was not unknown in the eighteenth century. That silver chloride turns dark under the action of light was known to Schultze as far back as 1727. In the latter part of the century it was recognized that sunlight enables plants to decompose carbonic acid gas and set free its oxygen, and about 1840 Liebig grasped the full importance of this process in the economy of nature. But all photo-chemical knowledge remained qualitative until John W. Draper, of New York University, about 1842, introduced the quantitative measurement of the chemical action of light, by constructing the first 'actinometer.' Gay-Lussac and Thénard had

observed in 1809 that a mixture of equal volumes of chlorine and hydrogen, which may be preserved indefinitely in the dark, reacts with explosive rapidity if exposed to intense light, and slowly if the light is weak. The product of the reaction is hydrochloric acid gas, which is freely soluble in water, while hydrogen and chlorine are soluble only sparingly. To measure the effect of light in causing the reaction, Draper introduced a mixture of precisely equal volumes of hydrogen and chlorine into a glass bulb (a) half

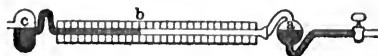

DRAPER'S ACTINOMETER.

filled with water and joined to a glass tube (b) likewise filled with the gaseous mixture, provided with a scale, and in its turn joined to a wide vessel (c) filled with water. He then exposed the upper part of a to light, whereupon part of the hydrogen and chlorine combined into hydrochloric acid, the latter was absorbed by the water, and the consequent diminution of the gaseous volume was shown by the length of the column of water entering from c into b. Draper's actinometer was improved in 1862 by Bunsen and Roscoe. But even the improved form of the apparatus did not permit of sufficiently rapid experimentation, and consequently the method was soon abandoned. Instead, Bunsen and Roscoe employed an actinometer which measured the chemical intensity of light by the time required to darken a photographic film to a certain standard degree.

In 1879 Eder devised a new method of actinometric measurement. If a mixture of mercuric chloride (corrosive sublimate) and ammonium oxalate in aqueous solution is exposed to the action of light (especially the ultra-violet rays), a chemical change takes place resulting in the precipitation of mercurous chloride (calomel), the quantity of which measures the chemical intensity of the light. Account must of course be taken of the fact that the amount of calomel precipitated not only depends on the intensity of the light, but is also influenced by the varying concentration of the solution during the experiment.

In 1897 Rigollot constructed an actinometer by immersing into a solution of common salt two copper plates whose surfaces were previously oxidized in the flame of a Bunsen burner, and exposing one of the plates to the light. If the two copper plates of this apparatus are connected by a wire, an electric current is found to flow from the dark plate toward the illuminated one, the intensity of the current being proportional to the intensity of the light, and hence being capable of serving as a measure of the latter. It may be observed that the principle of electrochemical actinometry was discovered as far back as 1839, by Becquerel, who found that a current passed between two silver plates covered with films of chloride of silver and immersed in dilute sulphuric acid if one of the plates was exposed to the light.

GENERAL PRINCIPLES. Passing now to the few known general principles of photo-chemistry, it must be observed first of all that while it was formerly believed that light of certain colors only ('actinic rays') was capable of chemical action, it is now generally admitted that chemical

changes can be produced by light of any wavelength whatever, including the infra-red and the ultra-violet rays. It is further generally admitted that if a substance is at all incapable of absorbing light, it is also incapable of undergoing photo-chemical changes of any kind. It is often possible, however, to increase the capacity of a substance for absorbing light, by mixing it with other substances which absorb light freely.

When light produces a chemical change, it naturally loses more or less of its original intensity, part of its energy being transformed into chemical energy. When, therefore, light passes through a medium in which it causes some chemical change, its intensity is diminished, first through purely optical absorption, and secondly through 'photochemical extinction.' Thus, for example, if light is passed through a given volume of chlorine gas, it is partly converted into heat and its intensity is found to have diminished by a corresponding amount. If now, in a second experiment, light of the same original intensity is passed through a mixture of chlorine and hydrogen, the intensity is found to have diminished by a greater amount than in the first experiment, owing to the photochemical combination of chlorine and hydrogen into hydrochloric acid. The absorption of light by the hydrogen gas present in the second experiment is small and may be left entirely out of account. In either experiment, the diminution of intensity may of course be measured by means of one of the actinometers described above.

In conclusion, it may be pointed out that if a given substance is capable of undergoing a chemical change both under the influence of light and without this agency, the change in the two cases need not necessarily be quite the same. Thus it has been proved that the decomposition of hydriodic acid takes place, under the influence of light, according to the equation.

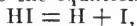

i.e. molecule after molecule of hydriodic acid is primarily decomposed into single atoms of hydrogen and iodine. On the other hand, if hydriodic acid is decomposed by heat, without the intervention of light, the decomposition takes place according to the equation

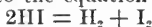

i.e. the molecules are decomposed in pairs, each pair yielding a molecule of hydrogen gas and a molecule of iodine.

Consult: Nernst, *Theoretische Chemie* (Stuttgart, 1900); Eder, *Handbuch der Photographie* (Halle, 1884); Niewenglowski, *La photographie et la photochimie* (Paris, 1896); Bunsen and Roscoe, *Photochemische Untersuchungen* (reprinted in Ostwald's *Klassiker der exakten Wissenschaften*, Leipzig, 1892); Draper, *Scientific Memoirs, Being Experimental Contributions to a Knowledge of Radiant Energy* (New York, 1878). See PHOTOGRAPHY; PHOTOSYNTHESIS; PHOSPHORESCENCE; ACTIVITY.

PHOTO-ENGRAVING. The art of preparing, by means of the chemical action of light upon certain bodies, an engraved plate or block for printing. There are two forms of this as there are of manual engraving; namely, engraving in intaglio, in which the ink for printing enters the incised lines and remains there while the rest of the plate is cleaned off; and relief engraving, in which the ink is deposited upon the projecting parts of an engraved block or plate.

In either case the paper takes the ink from the surface as in the printing of ordinary manual engravings. Photo-lithography, or the preparation by chemical effects of light of plane surfaces for printing, is treated under LITHOGRAPHY.

INTAGLIO PHOTO-ENGRAVING. This is known by the general name *photogravure*, a French term generally accepted in all languages. Heliogravure is a term which may be taken as the equivalent of photogravure, varying in meaning as does that more general term; but at different times the name heliogravure has been given to special patented or secret processes. Photogravure may have the appearance of pure line work, exactly as in manual line-engraving (q.v.), and it may have the appearance of tint or shade without line, nearly as in the case of mezzotint (q.v.). This form of the art has been carried to such perfection by some workmen, especially in France, that it is to be compared only to the finest and most artistical hand work, having in addition to that artistic charm an accuracy of reproduction which the manual work cannot pretend to. Thus in the large books on painting and monographs of special painters issued during the last twenty years, and especially the more recent ones, such as De Beruete's *Velasquez*, Yriarte's *Mantegna*, Lady Dilke's *French Painters of the Eighteenth Century*, Armstrong's *Gainsborough*, *Turner*, and other volumes, and the splendid catalogues of public and private collections, photogravures alternate with half-tone prints and other prints from photo-engraving plates, but the photogravures are distinguishable at once by the fineness of their texture (pure line in the one case and grain or texture in the other), in which no other process can approach them. In the case of line photogravure the facsimile of a drawing or of a print from an engraved plate may be so perfect as to be so indistinguishable from the original except by the most minute examination of an expert. Thus in the published work of Amand-Durand of Paris, the facsimiles of fine prints from the plates of Dürer, Rembrandt, Claude, Paul Potter, and other celebrated etchers and line engravers caused astonishment and doubt among collectors of prints when those facsimiles first appeared about 1870. Here was an unquestioned original Rembrandt, not a copy, as any student of Rembrandt would know, and yet it was printed upon modern paper. In all these processes, however, hand work has to be called in to complete the plate; and it is a general truth that the most artistic workmen produce the most perfect photogravures. In the case of Amand-Durand there was the peculiar advantage that the director himself was a skilled engraver before he undertook the photo-engraved process.

Gelatin treated with bichromate of potash is made insoluble under the action of light. Instead of gelatin some other form of albumen may be used, or asphaltum, which is found to answer equally well and to be cheaper. In making a photogravure in line a photographic transparency, or positive, of the drawing or print or picture or object which is to be reproduced is placed in contact with a copper plate coated with asphaltum or albumen mixed with a bichromate, and strong light is allowed to pass through the negative to the sensitized surface. Only those parts where the light passes through the negative with-

out interruption will be marked by complete insolubility of the gelatin; elsewhere the surface remains soft and capable of being dissolved away by washing. In this way the surface of the prepared plate affected by light is turned into a relief copy of the original. The plate is then etched by an acid, perchloride of iron, which eats it away exactly as in the case of ordinary etching (see ETCHING). When it is a line plate which is being prepared no other important steps are necessary; but when the plate is to be a tint plate or gradation plate without line and producing prints much like those taken from a mezzotint, it is usual to prepare the surface of the copper plate in the first place, by precipitating upon it a fine powder of resin or of resin and asphaltum in combination. This powdered surface prevents the complete access of the mordant to the metal exactly as in the case of aquatint (q.v.). The granular surface so obtained may be either coarse or indefinitely minute, this depending upon the character of the subject to be reproduced. In this way the reproductions of portraits by the greatest master of refined execution or landscapes of minute detail of most varied character may be reproduced with a perfectness of gradation equal to that of hand work in its highest perfection.

As it has become customary to illustrate costly books by means of large photogravure plates, so it has become usual to employ living artists of celebrity to make original monochrome pictures for such reproduction. These are sometimes produced in the more usual fashion by means of water-color work in bistre, sepia, India ink, or other one-colored pigment, but they are also made on a very large scale by oil painting upon canvas, exactly as in the case of paintings intended for exhibition or sale, except that they are worked in such gray or brownish-gray pigment as the painter and the photographer agree upon as convenient for the one and most easily adapted to the work of the other. Such monochrome paintings are often of considerable importance, and those collectors of works of art who have purchased them at the time of their production have considered them an important part of their possessions. It may be stated, also, that the improvements made in orthochromatic photography have made it possible to obtain very accurately the relative color values of the most difficult subjects, elaborate oil paintings, and the like.

The difficulty with the employment of photogravure in book work is the great cost, not alone in the production of the plates (for it is not uncommon to take two or three months in the perfection of a large plate), but of the printing, which has to be done on a hand press, and slowly, so that every separate impression, of which fifty may be bound up in a folio volume, will have cost a definite sum of money over and above the cost of the plates. It is on this account that modified processes are continually brought forward intended to produce plates from which the printing may be done more rapidly. There is, however, always the difficulty in printing from intaglio-engraving, that in order that the paper shall take the ink from the incised lines perfectly, leaving none behind, so that the design is reproduced in every minute particular by the raised pattern of ink on the paper, only a slow and painstaking process will serve.

A kind of photogravure has been introduced in which a screen is employed to make the grain exactly as in the case of the half-tone process described below. This, of course, if perfected, will tend toward much greater ease in rapid printing.

RELIEF PHOTO-ENGRAVING. This covers all those processes by means of which a surface is prepared like that of a wood engraving, the lines, points, and small surfaces which are to be reproduced upon the paper standing up in low relief from the background which is cut away. The level surfaces of these lines and points must be exactly true and uniform, all in one plane, except where it is deliberately lowered in one place or another in order that the block at that point shall press the paper less firmly and the ink impression show pale in contrast with other and blacker parts.

One of the most difficult of these processes is that called commonly the Gelatin Process, or, to distinguish it from others also depending upon gelatin, the 'swelled gelatin process.' It is an expensive process and one requiring the greatest care to employ it successfully, but its results are not very markedly inferior to that of photogravure which is not in distinct line. In fact, a good print made by this process may be often taken for a photogravure print of somewhat inferior excellence, without clear black and white, with a too uniform texture and a cloudy rendering of details. A sheet of glass is coated with a film of gelatin sensitized with bicromate of potash and exposed under a black and white negative. The film is then soaked in water and swells up where the opaque lines corresponding to the whites of the design protected the film, while the surface of the film corresponding to the black lines of the design do not swell. From the surface so produced a matrix is made, and from this another in a material such as wax, and, again, an electrotype of copper is made and mounted upon a block to give it the requisite stiffness and thickness.

The Woodbury type, the collotype, the artotype, the heliotype, the albertype, and many similar processes are all based upon the properties of certain resinous and glutinous substances, and their changes when submitted to light. Asphaltum, albumen, and gelatin are the three used.

The Half-Tone Process has resulted from the invention of the mechanical art of ruling lines of extreme fineness, of perfect uniformity in width, and at absolutely equal distances from one another. This, which was not practicable until within comparatively recent years, has now been developed so that plates of glass can be ruled in this way with minutely incised lines, two hundred or even three hundred to an inch. When two glass plates, each ruled with lines of this sort, for instance, diagonally across the plate, are brought together in such a way that the two sets of lines cross one another, the result is, as seen by transmitted light, a fine network of square or diamond-shaped mesh. The half-tone process depends upon this 'screen,' as it is called. The photographic negative is made by light passing through this screen, placed at a suitable distance in front of the sensitive plate, and the result is an image broken up into minute dots, easily seen with a magnifying glass. There is no absolutely continuous gradation of tint; but everywhere a

series of very small dots which constantly increase and decrease in darkness or intensity, conditioned upon the relative lights and darks of the subjects to be reproduced, and which are small enough to produce a general effect of uniform gradation. This negative reversed is placed in contact with a carefully prepared copper plate, the zinc is also used that has been coated with a preparation of fish-glue, bichromate of ammonia, albumen, and water. It is then exposed to the light and afterward washed in water, and those parts protected from the light by the dense portions of the negative will be washed out of the half-tones in due proportion. After burning in—that is, heating over a gas stove—the plate is all ready for etching, which is done in the case of a copper plate with perchloride of iron, or with zinc nitric acid.

The half-tone process requires less artistic sense and ability than, for instance, photogravure, but it requires the neatest handling, the most perfect delicacy of treatment, and it is often necessary for a good block that the acid should be applied in several consecutive 'rebitings' before the surface is perfect. In much of the finest work of to-day the highest lights and delicate tone gradations are very skillfully retouched by an experienced wood-engraver. Much of the re-engraving by hand, however, is clumsily done, and adds to the shortcomings of poor plates.

The special utility of the half-tone block is in this, that it can be printed with type. In order that this may be done, the metal plate is backed up by a block of wood of the right thickness, so that the surfaces of the prepared metal shall be exactly even with the front of the types. With reasonably careful work in the preparation of the stereotype plates and the like, a page may be printed of typography with pictures of full light and shade incrustated in it; the whole printed together, and that even on the power press.

The Line-Cut Process gives an exact facsimile of a drawing in solid or dotted black lines. Any drawing which an artist will make with a point, as of a pen, or a brush, and which does not include tints or half-tones, can be reproduced in exact facsimile. The process is similar to those described above. The light passing through the negative hardens the prepared surface, and the unsoftened stuff is washed away. In fact, this may be considered the original process from which the half-tone process has been produced by natural evolution, that is by the development along obvious lines. The line-cut block can be used in connection with type exactly as half-tones at a very much less cost and with greater facility and less care in the manipulation.

COLORED PRINTING FROM PHOTO-ENGRAVED SURFACES. The most important process of this kind is that known as the Three-color Process. This has become a very familiar and widely used process and promises well. The system is based upon the scientific fact that all the colors of the spectrum may be obtained from the three primaries, red, blue, and green. The rays of light are separated by means of what are called photographic filters, which are partly transparent substances which allow particular rays to pass while they stop or restrain others. Thus one of the three filters will allow only blue rays to pass. By this appliance used in connection with

the half-tone process there may be produced a perfect blue picture, and again with the use of other filters a green and a red, or approximately red picture. The printing of all these, one upon another, approximates very closely the complete chromatic result desired, that is to say, a picture in full color. The chief difficulties of the process are in the making of correct negatives, accurate registration in printing, and appropriately colored inks. The result so far may be said to approximate to the reproduction of fine manual painting. One obvious reason for this imperfection of the result is found in the inferior effect of colors superimposed to those which are laid side by side. Every student of painting knows how much more brilliant a gradation can be procured by putting touches of color close together, side by side, than by laying those colors over one another. It is true that much work, especially in oil painting, is done by superimposed color, but this is when the upper coat of pigment is more or less translucent, as when the yellow below shows through the thin glaze of blue to produce a certain quality of green. Commonly the juxtaposition of color is more brilliant than the superimposition of color; and this fact causes an indefinitely great amount of thought and experiment among those who are trying to improve the three-color process.

Another and more complex process of photographic color work has been introduced in the United States within the last four years, and some of the results are surprisingly accurate reproductions of the originals. The greatest successes in the color work have been obtained in the reproduction of colored textiles, notably in imitating the richness of color and texture of Oriental rugs. This is a secret process, and the methods employed are very carefully guarded. It is something more than the ordinary three-color work, and apparently as many as seven colors are employed in some cases. It is as yet costly.

PHOTOEPINASTY (from Gk. *φῶς*, *phōs*, light + *ἐπι*, *epi*, upon + *ναστός*, *nastos*, solid, from *νάσσειν*, *nassein*, to press close). The action of light in accelerating the growth of the upper sides of dorsiventral organs, such as leaves. See GROWTH.

PHOTOGRAPHIC SURVEYING (from Gk. *φῶς*, *phōs*, light + *γράφειν*, *graphēin*, to write). In recent times the art of photography has found its way into surveying, an application due chiefly to the French. Its advantage was at once recognized for military and topographical purposes, but its usefulness for accurate and extensive surveys is still quite limited, owing to the imperfections of the photographic lens. The chief instrument is a view camera provided with cross-wires and an apparatus for leveling. A survey is effected by selecting at least two stations, and measuring the base-lines between them. Then at each station a series of plates are exposed, the camera being turned at each successive exposure sufficiently to obtain for the series a continuous photograph of the area to be surveyed. The method of executing a map and of calculating heights and distances from photographs is best obtained from works on the subject, but a general idea may be gained from the following. Since the images of the cross-wires are photographed on the plate, every point of the field

appears in its proper position in relation to the four quadrants of the plate. Thus in Fig. 1 III'

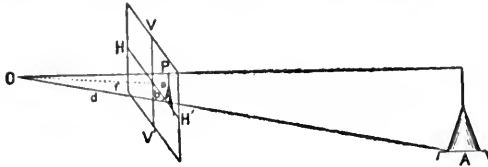

FIG. 1.

is the image of the horizontal wire, VV' the image of the vertical wire, and P the image of a church spire. The lines a and b can be measured in the photograph, and the focal distance f being known, line d can be computed, and when the distance OA has been determined from the map, the height of the spire above the level of the instrument is given by similar triangles. To plot a survey, the angular distance of any point from the base-line is determined by a photograph taken at each end of the base. In Fig. 2, P represents the plate of the camera at station A; B', C' being the images

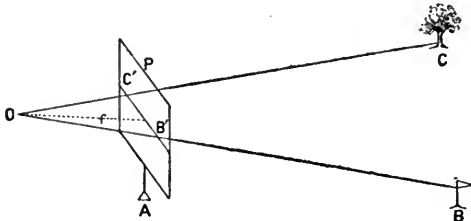

FIG. 2.

of station B and the point C; the angle $B'OC'$ can be determined from $B'C'$ and the focal length f . Then any point of the map may be plotted as follows: Lay off the base-line to a desired scale, and draw lines making angles with the base equal to those computed. These will intersect in a point on the map corresponding to the point in the field. Consult Deville, *Photographic Surveying* (Ottawa, 1895). See SURVEYING.

PHOTOGRAPHY. The art of producing the appearance of objects and fixing them by means of light on a previously sensitized surface, and the reproduction of the image thus obtained, by various processes, on glass, paper, and other materials. The first photographic camera was in reality a darkened room to which light was admitted through a single small hole in the window shutter. This was the camera obscura of Giambattista della Porta, an Italian philosopher, invented by him in the last half of the sixteenth century. When the sun shone brightly, a faint inverted image of a landscape could be seen on the whitened surface of the wall within. The camera obscura of the present time differs very little from Porta's invention except that it contains a lens in the apex of the roof, with a reflecting mirror above it, in order to throw the light from all the surrounding landscape down through the lens and thus form a panorama on the surface of a table placed in the middle of the room. J. H. Schultze, a German, who has been called 'The Columbus of Photography,' obtained the first actual photographic copies of writing as early as 1727, by placing the written characters upon a level surface previous-

ly prepared with a mixture of chalk and silver nitrate. The rays of light passing through the translucent paper blackened the silver compound underneath, except where it was protected by the opaque ink forming the letters themselves, and thus a white copy upon a black ground was obtained.

Scheele in 1777 demonstrated that silver chloride became black quickest by the action of the violet rays of the solar spectrum, thus showing that the rays of light were not equally active. A few years later Professor Charles projected the shadow of a head by means of strong sunlight on a sheet of white paper which had been made sensitive by chloride of silver and obtained a white profile on a darkened surface; but he was unable to fix the image upon the sensitive paper. Meanwhile the members of the Lunar Society, including Samuel Parr, James Watt, Josiah Wedgwood, and others, met regularly at the house of Matthew Boulton at Soho and discussed their experiments, some of which were on the action of light, and it has been shown that an artist named Eginton, in the employ of Boulton, made and sold numerous copies of well-known paintings at very low prices. Thomas Wedgwood, to whom is due the honor of being the first to produce pictures by the action of light on a sensitive surface, published his paper giving "an account of the method of copying paintings upon glass, and of making profiles by the agency of light upon nitrate of silver, with observations by H. Davy," in the *Journal of the Royal Institute* for June, 1802. To Davy credit is due for his discovery that silver chloride was more sensitive than the nitrate; but, notwithstanding his continued investigations, Davy was unable to find a means by which the fading out of the pictures could be prevented. Other investigators took up the subject later, among whom may be mentioned Joseph Niepce and Daguerre in France, and William H. F. Talbot in England. The first-named, in 1814, succeeded in producing permanent pictures by a process which he called *heliography*. It consisted in coating with bitumen a piece of plated silver or glass, which was then exposed in a camera obscura during 4 to 6 hours. Those portions of the bitumen which were acted on by the light became insoluble, and by removing the parts unacted upon by certain essential oils in which bitumen was soluble, the shadows of the image were removed, and the lights were represented by the insoluble bitumen that remained on the plate. This process was therefore the forerunner of our modern photo-mechanical methods. In 1824 Daguerre began his experiments, which led to the invention of his celebrated process. He formed a partnership with Niepce in 1829, and ten years later they announced the invention of the daguerreotype process, the principle of which had been discovered by Daguerre in 1832. The process consisted in exposing a metal plate covered with silver iodide for twenty minutes in a photographic camera, after which the plate was transferred to a dark room and exposed to the vapor of mercury, which developed the latent image, the latter being then made permanent by means of a solution of sodium chloride. Sir John Herschel, who devoted considerable attention to this subject, soon after announced the greater suitability of sodium hyposulphite for dissolving the haloid salts of silver and consequently the hyposulphite was adopted as a

fixing agent. Daguerre received a pension of 6000 francs from the French Government on August 10, 1839, in consideration of which the details of his process were given to the world. Information of this invention reached the United States in 1839 through Samuel F. B. Morse, who communicated it to his colleague in New York University, John W. Draper (q.v.), by whom the first sunlight picture of a human face (that of his sister Dorothy Draper) was made in 1840. Meanwhile Talbot, in England, had been pursuing investigations from a different view-point, and on January 31, 1839, he presented before the Royal Society a paper on "Pathogenic Drawings." These he produced by dipping writing paper in a solution of sodium chloride, drying, and then transforming the sodium chloride into silver chloride by passing the paper through a solution of silver nitrate. With this paper, which was extremely sensitive to light, he was able to produce a negative that became black by the action of sunlight except where it was covered by some opaque object, which he desired to reproduce, and in turn from this negative, by another exposure, a number of positive prints could be obtained, which were fixed by potassium bromide. Two years later Talbot patented his 'calotype' process, in which the negative was obtained by coating the surface of the paper with silver iodide, then washing it over with a mixture of silver nitrate with gallic and acetic acids, after which it was exposed in a camera to the object he wished to copy. The invisible picture thus obtained was developed by silver aceto-nitrate and gallic acid, and fixed with potassium bromide. Minor inventions and improvements followed the introduction of Talbot's process, among which the most important was the use of albumen, recommended by Niepee de St. Victor as a film containing haloid salts which he flowed upon the surface of the glass.

The development of the modern rapid processes of photography may be said to have begun with the introduction of the dry collodion process by Scott Archer in 1851. This process consists in coating glass plates with a film of collodion containing soluble iodides or bromides, which form a sensitive silver compound when dipped in a solution of silver nitrate. The soluble collodion is prepared by the action upon cotton of a mixture of nitric and sulphuric acids with a little water, or of a mixture of potassium nitrate with sulphuric acid, the resulting substance being dissolved in a mixture of alcohol and ether. On evaporation, the viscous solution leaves a film of collodion. The exact proportions of the ingredients used must be varied at different seasons of the year, and must be suited to the character of the objects to be photographed, one variety being suitable for landscape views, another for portraiture, etc. The collodion is flowed over the glass plate, which must be perfectly clean, and when partially dry sensitized by dipping into a bath containing silver nitrate in the proportion of from 35 to 50 grains of the salt to an ounce of water. A very small quantity of potassium iodide is added to the bath. The sensitized plate is then exposed in the camera to the object to be taken. The action of the light on the sensitive silver salts changes them in such a way as to produce a latent image on the film, which is then developed by pouring over the plate a solution of ferrous sulphate or pyrogallie acid, to either of which are added some

alcohol and acetic acid, after which the image on the plate is made permanent or fixed by immersion in a solution of sodium hyposulphite, potassium cyanide, or some other liquid capable of dissolving the portion of the silver salts that has not been acted upon by the light. For the protection of the collodion film it is common to coat the negative with a clear and hard varnish.

As the wet process required that the plates be prepared at the time of exposure, that process naturally found its most extensive employment for indoor work, and continual efforts were made to devise portable plates. Finally plates were introduced which were sensitized, washed, dipped in some organic preservative, such as a solution of tannin, and then dried.

In 1871 Maddox introduced the earliest form of the 'gelatin-emulsion process,' which has since been considerably improved, and is now used very largely. In this process the sensitive silver salt is held in suspension in either collodion or gelatin. The collodion emulsion may be made by dissolving in one portion of collodion a solution of zinc bromide, in another a solution of silver nitrate, and then thoroughly mixing the two portions. The gelatin emulsion may be prepared by bringing into solution the gelatin with potassium bromide, while a solution of silver nitrate to which some ammonia is added is gradually poured into the liquefied solution of gelatin. These emulsions are floated on plates and dried. Modern plates of this nature are found to be from ten to a hundred times more sensitive than the older wet plates, and have thus made possible the photography of moving objects and of those which are only dimly lighted. They also make possible the flash-light pictures by means of which instantaneous views are taken of a dark interior during the burning of a small quantity of magnesium. A large variety of developing agents are employed with the modern dry plate. Pyrogallie acid in connection with an alkali is perhaps the most common. Sodium hyposulphite is almost entirely used as the 'fixing' agent.

The camera consists of a box, either of wood or a framework of wood with a bellows-expanding body of leather, so that when closed the camera may occupy but little space and be conveniently carried. In the front of the camera is the lens, and at the back a piece of ground glass on which the image of the object to be photographed may be focused, together with an arrangement for lengthening or shortening the body of the camera. The camera should be placed so as to insure perfect rigidity when fixed, and for indoor work should be strong and steady, while for outdoor photography the camera stand should be made light so as to be easily portable, or the stand or tripod may be dispensed with altogether.

The lens is of very ancient origin. There is a lens in the British Museum which was found in the ruins of Nineveh, and during the Middle Ages the manufacture and properties of simple lenses were well understood in Europe. In general use now, four varieties of lenses are common: (1) A single lens consisting usually of a combination of two converging meniscus lenses separated by a diverging meniscus, arranged as a combination in the tube of the lens at the end nearest the camera, the convex side of the combination being toward the plate; (2) a rapid rectilinear lens consisting of a converging meniscus lens cemented to a diverging meniscus, the latter occupying the

outside position in the tube; (3) a wide-angle rectilinear lens of somewhat similar construction, having two combinations formed of meniscus lenses, but of much deeper curvature than those employed in other combinations, and placed closer together in the lens tube; and (4) the portrait lens, consisting of a back and front combination, arranged at some little distance apart, the front combination containing a double convex and a plano-convex lens cemented together, the double convex lens taking the position next the object, while the back combination consists of a double convex and a diverging meniscus lens, which are frequently mounted so as to leave a small space between the two.

In photographing an object the camera is set up, and, after the image is properly focused on the ground glass plate, the holder containing the sensitized plates, which are carried in double-backed dark frames arranged to carry two plates, each back to back, is inserted in the camera and the cover of the slide is withdrawn, exposing the sensitized plate so that it receives the picture. The shutter is then closed and the cover of the dark slide placed over the plate, which is later taken to the dark room for development.

For the bringing out or 'developing,' as it is called, of the latent image that has been produced on the sensitive plate, it is treated with various solutions; thus, in the daguerreotype the vapor of mercury is the agent used, and in the wet collodion process, as has already been mentioned, the development is effected by ferrous sulphate or pyrogallie acid. In the case of the dry plates, a developer, prepared by adding one part of a saturated solution of ferrous sulphate to four parts of a saturated solution of potassium oxalate, to which has been added a very small quantity of a solution of potassium bromide, is sometimes employed. A ferrous citro-oxalate is frequently used instead. As the plates are exceedingly sensitive, they must be developed in a dull ruby light, and the operation is accomplished by laying the plate in the developing tray, face upward, after which the liquid is run gently from one end of the plate to the other. Excellent results have also been obtained by the use of hydroquinone, eikonogen, metol, etc. These substances, when mixed with potassium bromide and sodium sulphide to act as reducing agents, produce very clear negatives. But pyrogallie acid is still most largely used as a developing agent.

For the reproduction of printed copies from the negative, a paper sensitized by dipping in a solution of silver nitrate is employed, and is then exposed to the sunlight, under the negative. The paper, which should be of some light and moderately strong quality, is first coated on the surface with a smooth layer of albumen to which either ammonium or sodium chloride has been added, and then floated in a solution of silver nitrate of varying strength, according to the condition of the negative, and of which 50 grains of the salt for every ounce of water is an average proportion. The exposure to light also varies according to the brightness of the light and the character of the negative. The print thus obtained is toned by immersion in a neutral solution of gold containing certain metallic salts, and finally the image is fixed by immersing the print in a solution of sodium hyposulphite which removes the unaffected silver salt. The final opera-

tion consists in thoroughly washing the print, after which it is ready for mounting.

The gradual disappearance or fading out of prints made with silver salts led to numerous attempts to find satisfactory substitutes, and various metallic salts have been employed for the purpose of producing permanent prints, some of which are described in the following paragraphs:

CYANOTYPE OR BLUE PRINTS. The earliest of these is perhaps the one first described by Sir John Herschel, and consisting in the reduction of ferric salts by light. Solutions of 1 part each of ammonium ferric citrate and potassium ferrieyanide in 8 parts of water are made separately and then mixed in a dark room. The paper or cloth is floated on this solution and exposed under a negative to the action of sunlight, and then thoroughly washed. This process is employed largely for copying plans by builders and architects, and the lines of the drawing appear white on a blue ground. It is much used on account of its cheapness and simplicity. A somewhat similar process, in which the ammonium ferric citrate is substituted by a solution of 1 part of uranium sulphate in 4 parts of water, yields a beautiful rich brown print.

FERROTYPE, OR TINTYPE. In this process a piece of sheet iron is japanned with black varnish and baked, after which it is sensitized with a collodion solution and exposed in a camera to the object, then developed and finally covered with some protective coating. See **FERROTYPE**.

PLATINOTYPE. The substitution of platinum for silver, originally introduced by W. Willis, has found considerable favor, owing to the fact that the prints are both richer and more permanent than those made with silver salts. The original process consisted in sensitizing the paper with a mixture of ferric oxalate and a platinum salt. Exposure to light resulted in the reduction of the ferric salt to the ferrous state, and when the ferrous salt was in solution the platinum salt was reduced by it. By floating the exposed paper on a solution of neutral potassium oxalate, which is a solvent for ferrous oxalate, the platinum salt in contact was immediately reduced to the metallic state and the image built up. Such prints were fixed by immersion in dilute hydrochloric acid, which dissolved any ferric oxalate or calcium oxalate that might be present. A second process has been introduced in which the paper is simply coated with ferric oxalate containing a small quantity of mercuric chloride, which after exposure is developed by a solution of potassium oxalate with the platinum salt. A still more recent method is one in which the paper is sensitized with a mixture of the platinum salt with sodium-ferric oxalate and sodium oxalate, and under the influence of light and the moisture of the air the reduction of the platinum salt takes place in the printing frame. Excellent results have been obtained by toning silver prints with platinum, which yields rich brown and black tones.

PHOTO-MECHANICAL PROCESSES. Methods by which photographic impressions could be reproduced by mechanical means, and so used directly on the printing press, have naturally been sought for, and have been invented. Such processes depend for the most part upon the action of light on a gelatin film impregnated with a bichromate, generally of potassium or ammonium. The processes in question may be divided into two groups.

In processes of the first group, the picture is molded in gelatin and colored by a pigment. The group includes the Woodburytype or Photoglyph and the Stannotype. In the Woodburytype a sheet of bichromatized gelatin, a highly sensitized mixture of gelatin and potassium bichromate, is prepared and a thin film exposed under a negative to a strong light and then washed to remove the unchanged gelatin that was protected from the light by the negative, and finally dried. This film is placed upon a sheet of soft metal, usually lead, and forced into it by hydraulic pressure, producing a mold of the picture, in which the dark parts are in intaglio and the light ones in relief. This mold is then inked with a solution of warm gelatin colored with pigment, and a sheet of paper laid upon it, a strong pressure exerted in a horizontal press, the excess of ink being forced out by pressure. The print is then immersed in a solution of alum, which renders the picture insoluble. The Stannotype, which is a modification of the foregoing process, consists in substituting for the lead plate a thin sheet of tin-foil properly strengthened in the back by electrotyping material. In the photo-mechanical processes of the second group, the picture is printed with ordinary printing ink from a gelatin surface, from stone, from metallic relief surface, or from an intaglio copper plate. The 'collotype' or 'phototype' processes of this group, in which the picture is printed from a gelatin surface, are represented by the *Albertype*, invented by Joseph Albert, of Munich, in 1869. This process consists of coating a sheet of plate glass with a thin film of chromatized albumen and gelatin, which is then laid face down on black cloth and exposed to light. The insoluble gelatin next to the plate adheres firmly to the glass and serves as a foundation for a second film, which consists of chromatized gelatin. The dry film is placed under the negative in a printing frame and exposed to the light until the shades of the image are visible through the glass. Next the plate is washed in water to remove the soluble bichromate, and the film hardened with chrome alum and dried. The plate is fastened to the bed of a printing press by means of plaster of paris. The *Artotype*, which is similar to the foregoing, was invented in 1878. A mixture of albumen and soluble glass is used for the foundation on which the sensitive film is afterwards placed. As such a film does not require to be hardened by light, opaque metallic plates may be used instead of a glass plate, as in the previous process. *Indotints* or *autoglyphs* are produced by processes similar to the foregoing, except that the support for the gelatin film is usually of copper slightly roughened in order to cause the sensitive film to adhere firmly. The addition of alcohol to the chromatized gelatin is said to increase the toughness and tenacity of the film. After exposure under the negative the unchanged bichromate is washed out and the plate is dried. Prints from such plates can then be taken on a power press. The heliotype process differs from the foregoing by the hardening of the gelatin film with chrome alum and the detaching of it from the support upon which it was first prepared; thus yielding, when completed, a thin sheet or skin of gelatin that is both tough and flexible, and which may be placed on a plate of zinc or attached to a cylinder when used for printing.

Excellent results in color have been obtained

in the foregoing processes by preparing several gelatin plates, each of which corresponds to a different color in the original, and these are then used for printing with colored inks. Prints have been produced in which as many as seven successive distinct colors have been used. In those processes in which the picture is printed from stone, a sensitive mixture of albumen and ammonium bichromate in water is passed over a lithographic stone which has been thoroughly polished and cleaned. The excess is carefully rubbed off and the surface of the stone dried so as to remove all traces of moisture. It is then exposed under a negative, and wherever the light penetrates to the chromatized albumen it becomes insoluble. After sufficient exposure the surface of the stone is covered with lithographic ink and washed with water so as to remove the soluble parts of the film, and then treated with the acid and gummed and printed as in ordinary lithography. The difficulty in handling the heavy stones soon led to the invention of an improved process, in which a sheet of paper, sensitized with a solution of albumen, gelatin, and potassium bichromate, was placed face down on a sheet of smooth copper, and then exposed under a negative, after which it was coated uniformly with the usual lithographic transfer ink. The paper was then floated on boiling water in order to coagulate the albumen on the film, and the unaltered gelatin which was protected by the opaque portions of the negative absorbs moisture and swells, leaving the unaltered gelatin depressed. This print, again washed and then dried, is transferred to stone by simply placing it upon that material face downward and passing it through the press.

Processes in which the picture is printed from a metallic relief surface include the ordinary photo-engravings or photo-electrotypes. In the former a plaster mold is taken of the gelatin film and a cast reproduced in type metal, when it is called a *photo-engraving*, or in copper, when it is known as a *photo-electrotype*. Among these should be included those processes of photo-etching in which the pictures are printed from zinc plates to which the design has been transferred in adhesive transfer ink from paper, similar to the transfer process referred to under PHOTOLITHOGRAPHY. The zinc plate thus obtained is then treated with acid in order to lower the white portions, producing a low relief.

Processes in which the picture is printed from an intaglio copper plate had their origin in France, and were known variously as *photo-gravures*, *photo-aquatints*, etc. These consist of gelatin relief films similar to those of the Woodburytype (see above), with certain modifications which caused the production of a grain in the relief film; thus in the case of the photogravures of Goupil, the material producing this effect is said to be pulverized glass. A mold is then made from the gelatin relief, from which a copper plate is obtained by electrotyping, from which the prints are then carefully made.

The invention of a transparent and flexible film pellicle for supporting the sensitized photographic surface was made by Hannibal Goodwin, and his application for patent was filed May 2, 1887, but the patent was not issued until September 13, 1898. The substance itself was entirely new, and the manufactured article consisted of a film support of a dried and hardened cellulosidal solution of nitrocellulose. The film must be

non-greasy, insoluble in developing fluids, insensible to heat and moisture, hard, smooth, brilliant of surface, exceedingly thin and light, and absolutely transparent. It was no easy matter to obtain all these properties in the new support, and it is only after many years that the film has succeeded in supplanting, to any great extent, glass as a supporting substance. It was a very important invention and has made possible the widespread modern employment of photography by amateurs. The roll holder, by means of which a long strip of film can be carried in a comparatively small space, was first suggested by W. J. Stillman, and has led to the modern hand camera for films, and later to the so-called system of 'daylight photography,' which still further increased and simplified the use of photography by amateurs.

APPLICATIONS OF PHOTOGRAPHY. In addition to the production of pictures of persons and scenery, photography finds extensive application in reproducing paintings and thus popularizing famous works of art. Photography is further employed in many branches of science. The micro-photographs of minute forms of life have added much to our knowledge of such organisms, and the photographs of the heavens are furnishing innumerable data that will doubtless lead to astronomical generalizations of the greatest importance. (See **ASTRO-PHOTOGRAPHY.**) The application of photography in legal matters for the purpose of showing forged signatures and establishing facts that were disputed has been of the utmost value. Photographs taken from balloons during the Boer War furnished information that proved of great value. The biographic pictures in which the effect of motion is reproduced in consequence of the successive exposure, occupying but a 250th part of a second, has brought about a revision of the opinion in regard to many forms of motion, the details of which can now be studied. And the employment of photography is constantly growing.

PHOTOGRAPHY IN LAW. The courts have generally recognized that an accurate likeness of an object or place can be reproduced by means of the art of photography, and photographs are now often an efficient means of demonstrating a fact in the trial of a cause. They are admitted in both civil and criminal cases as an aid to the jurors in their efforts to understand descriptions of places and objects which might not otherwise be presented in an intelligible manner.

By the general weight of authority a photographer has no right to print copies from a negative likeness of a person, for his own use or distribution in any way, without the person's consent. The person whose likeness is thus taken may restrain the sale of his photographs, and recover such damages as he may have sustained by reason of the sale of the copies. This is generally placed on the ground of implied contract, and sometimes of breach of confidence. The photographer owns the negative, but the person whose likeness is on it has the right to say whether it shall be used or not.

BIBLIOGRAPHY. The literature of photography is so extensive that mention can be made of but few of the many works dealing with the subject in its different aspects. In fact, many of the authorities have prepared a number of works each of which discusses a single process or phase of the subject, and these should be consulted by

the reader in search of information. The works of Abney, Robinson, Vogel, Eder, and Burton are all authoritative and valuable. The following works will doubtless be of service to the reader, although it must be understood that such a list is by no means comprehensive:

Harrison, *History of Photography* (New York, 1887); Abney, *Instruction in Photography* (London, 10th ed., 1900); id., *Photography with Emulsions* (New York, 1886); id. (with H. P. Robinson), *The Art and Practice of Silver Printing* (London, 1888); Vogel, *Chemistry of Light and Photography* (London, 1882); Dallmeyer, *Telephotography* (London, 1899); Burton, *Photographic Optics* (New York, 1891); id., *Modern Photography* (London, 1892); Lummer, *Contributions to Photographic Optics*, translated and augmented by S. P. Thompson (London, 1900); Duchochois, *Photographic Reproduction Processes* (New York, 1891); Wilkinson, *Photo-Engraving in Line and Half-Tone* (London, 1886); id., *Photogravure* (London, 1890); Bolgas, Talant, and Senior, *A Handbook of Photography in Colors* (New York, 1900); Woodbury, *The Encyclopædia of Photography* (London, 1892); Wilson, *Cyclopaedic Photography* (New York, 1894).

Among the more prominent English and American annuals may be mentioned: *The American Annual of Photography* and the *Photographic Times-Bulletin Almanac* (New York), and *The British Journal of Photography Almanac* (London). The principal current periodicals are the *Photographic Times-Bulletin* (New York), *Wilson's Photographic Magazine* (New York), *The Photo-Miniature* (New York), *Camera Work* (New York), *Camera Notes* (New York), *The Photo-Beacon* (Chicago), *Camera Craft* (San Francisco), *The Professional and Amateur Photographer* (Buffalo), *The Photo-Era* (Boston), *The British Journal of Photography* (London), *The Amateur Photographer* (London), *Photography* (London), *The Photographic Art Journal* (London).

PHOTO-LITHOGRAPHY. See **LITHOGRAPHY.**

PHOTOMETRY (from Gk. φῶς, *phōs*, light, + -μετρία, *-metria*, measurement, from μέτρον, *metron*, measure). The science of comparing the intensities of sources of light. It is impossible at the present time to measure the intensity of a source of light in terms of any absolute standard, i.e. in terms of watts; and therefore it is customary to compare the intensity with that of a standard source of light, and for this purpose various standards of white light have been proposed and used, but none have been completely satisfactory. These will be found discussed below. The 'intensity' of any source of light is defined to be the amount of light emitted through a cone whose solid angle is unity. The 'flux of light' is the amount of light emitted through any sized solid angle. The 'illumination' of any illuminated surface is the flux of light falling upon it divided by its area. The 'brightness' of a source of light, if it is a surface, is the intensity divided by the area of the surface. See an article by Crew, *Astrophysical Journal*, vol. vii., p. 298, 1898.

If a surface is illuminated by a small source of light, its illumination varies directly as the intensity of the source and inversely as the square of its distance from the surface. (See **LIGHT.**)

The intensities of two sources may be compared, therefore, by allowing two portions of the same surface to be illuminated by them. If the illumination over these two portions is the same apparently to the eye, the intensities of the two sources are in the same ratio as the squares of their distances from the surface. There have been several devices invented to secure the illumination of two portions of the same surface by the two sources. These instruments are known as photometers and are described below. The problem of comparing two colored sources of light, or of comparing the intensities of the colors produced by two sources of white light when dispersed by a prism, is practically the same as that just discussed, but requires a photometer adapted for this purpose. See SPECTROPHOTOMETRY.

PHOTOMETERS. Most photometers are based upon the law of the inverse squares and enable us to compare the relative intensities of two lights by finding at what distance they furnish equal illumination. There are also other photometers, but those depending on the equality

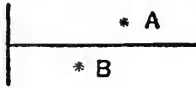

FIG. 1.

of illumination are by far the most extensively employed. The earliest photometer was devised by Bouguer and consisted of a vertical screen at right angles to a partition. On either side of the partition was placed a light so that it would illuminate one side of the screen. These lights were then adjusted until the two halves of the screen appeared of equal brightness. The distances of the lamps or lights from the screen were measured, and a proportion formed according to the law of the inverse squares. The screen, which was at first opaque, in later instruments was supplanted by one of ground glass, oiled paper, or other translucent material. An instrument based on the same principle which is in some respects modified is shown in the accompanying diagram (Fig. 2). Here A and B are the two illuminants,

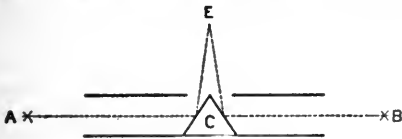

FIG. 2.

as before, and the rays of light fall on the surfaces of the prism C. The two lights are moved so that the surfaces of the prism appear equally illuminated to the eye of the observer at E. A simple and effective photometer was devised by Lambert in 1760, but as it was used extensively by Rumford some years later, it is known by his name. It consists of a vertical screen with a white surface, in front of which stands a cylindrical stick. The lights to be compared are placed in front of this stick, so that each will cast a shadow on the screen. These shadows represent the amount of light furnished by but one of the sources, consequently by varying the distances of the lights from the screen a position can be obtained where they furnish shadows of equal intensity. Measuring the distance of the lights from the screen, squaring these numbers, and forming a proportion, we can again compare

the intensity of the two illuminants. A second screen with an aperture cut in it may be placed parallel to the first with the lights in front of it

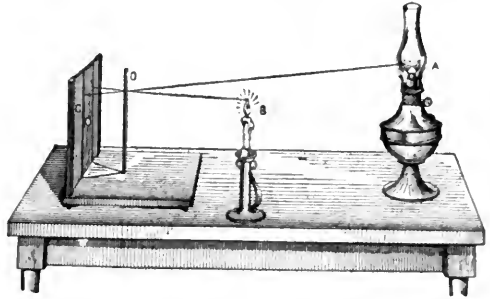

FIG. 3. RUMFORD PHOTOMETER.

and some little distance apart, so that each illuminates the screen by means of rays sent through the aperture. The two separate spots of light on the screen can be made equal by adjusting the lights and their comparative intensity computed as before. The photometer in most general use is that of Bunsen, where the two lights to be compared, A and B, are placed at the

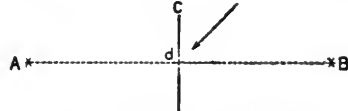

FIG. 4. BUNSEN PHOTOMETER.

opposite ends of the apparatus and a screen, C, whose face is perpendicular to the incident rays can be moved to and fro between them. This screen is made of a sheet of white paper with a central spot, d, produced by oil or grease, which appears bright on a dark ground by transmitted light, and dark on a light ground by reflected light. When the transmitted and reflected lights are equal in intensity the spot should disappear and the surface of the paper appear uniform, but in actual practice this condition is not realized. The sheet of paper is usually mounted in a box or carriage with mirrors or prisms enabling the observer to see simultaneously both sides of the paper, and is moved along a scale between the two lights, which is either graduated in units of length or indicates candle power direct. The reading is taken when the spot disappears as nearly as possible, and the candle power or relative intensity is determined as in the other cases. The arrangement of the lights, of course, varies in different forms of the instrument, as does also the construction of the box carrying the screen, but in general the results do not possess a greater accuracy than 4 or 5 per cent. The Rumford photometer cannot be depended upon closer than 8 or 10 per cent., but in all classes of photometric work much depends upon the observer.

The most modern and accurate photometer is that of Lummer and Brodhun, in which the central spot disappears entirely when the lights are of equal intensity. This is accomplished by the use of two right-angled prisms, one, E, with its hypotenusal face plane, the other, F, with this face ground spherical except in the centre, where a circular spot is perfectly plane. The two prisms are then placed with their hypotenusal sides adjacent, but separated except at the centre,

where the plane ground surface of the second prism is in contact with that of the other. The lights are placed at opposite ends of the apparatus, as in the case of the Bunsen photometer,

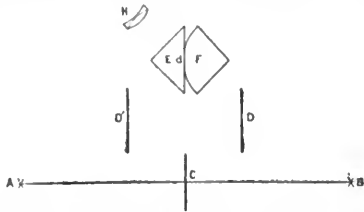

FIG. 5. PLAN OF LUMMER-BRODHUN PHOTOMETER.

and the rays fall on a central opaque screen, C, from which they are reflected to mirrors, D and D', and then to the faces of the prism. The rays from B entering the prism F, which has a spherical surface, undergo total reflection, except at

other. If the illuminant to the left of the observer, for example, is of greater intensity, then we have a bright spot on a dark ground, and reversing the conditions the dark spot surrounded by light. When the lights are of equal intensity the spot entirely disappears and the field is uniform. The Lummer-Brodhun screen is usually mounted on a carriage which can be moved along a scale and which is easily reversed as a check on the observations. It also has a telescope, H, to observe the surface of the prism, which is a distinct advantage, as it permits the use of one eye and enables the observer to decide more accurately when the spot disappears.

The main difficulty in photometry is the comparison of lights of different colors, as then the determination of equally illuminated surfaces is an extremely difficult matter. For this purpose Rood, employing a principle first made use of by Whitman, has devised a 'flicker photometer' in which the light from two different sources is pre-

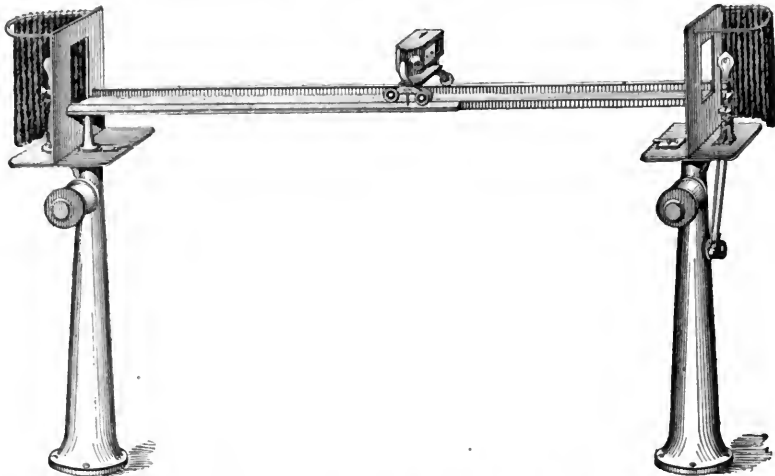

FIG. 7. LUMMER-BRODHUN PHOTOMETER ARRANGED FOR TESTING INCANDESCENT ELECTRIC LAMPS.

the central portion (d), where the glasses are in contact. Therefore, only the rays passing through this central portion enter the second prism, E, and produce a spot of light of elliptical shape on its opposite surface. The rays from the other source of light, A, are reflected into

sent alternately to the eye in rapid succession. When the flicker disappears, it is shown that the light coming from one source is equal in intensity to that from the other.

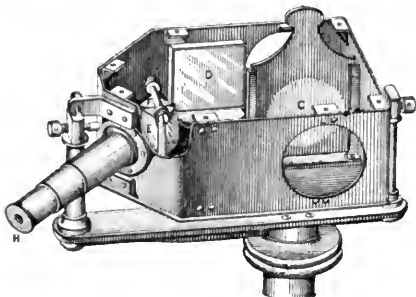

FIG. 6. LUMMER-BRODHUN PHOTOMETER.

the prism E, and by total reflection at the hypotenuse are brought to the third face of the prism, except those falling on the surface of contact, which enter the prism F. Consequently we have the surface of the prism E nearest the observer illuminated in part by the rays from one source of light and in part by rays from the

STANDARDS OF LIGHT. The question of standards of light possesses an intimate and important connection with photometry, and is a subject which is still attracting much attention from physicists. Until the International Congress on Electrical Units in 1883 adopted as the absolute standard the amount of light emitted by a square centimeter of melted platinum at the point of solidification, there was no really scientific unit in general use. Numerous forms of candles and lamps were employed, but little reliability could be placed on the results obtained in such tests; and they did not form a satisfactory basis for subsequent or independent determinations. In France the standard used in photometric tests was the Carcel lamp, which burned purified rapeseed oil. The lamp was constructed according to certain fixed specifications, but it did not appeal to scientific men universally as an accurate standard. Candles have been used for a number of years as standards in spite of their many shortcomings; and we are now accustomed to have our electric and other lights rated in candle power. The candle in use in the United States

and England for photometric tests is the standard spermacetti candle, which burns 120 grains of material per hour and six of which weigh one pound. When this is prepared according to certain specifications as to size and form of wick, and burns with a flame 45 millimeters in height, the light emitted is considered unity. The stearin star candle was used in France and a somewhat similar candle in Germany, while a paraffin candle known as the *Vereinskerze* on account of its being adopted by the Union of German Gas Men was used in Germany and Austro-Hungary. The standard now commonly used in Germany is the acetate of amyl lamp of Hefner, which can be so adjusted as to be equivalent to the English candle. In practical photometry secondary standards consisting of incandescent lamps which have been standardized by comparison with some fundamental standard are used, and ordinary lamps are tested by reference to them.

Consult: Palaz, *Industrial Photometry*, translated by Patterson (New York, 1894); Stine, *Photometrical Measurements* (ib., 1900); *Record of the International Congress of Physicists*, 1900 (Paris, 1901).

PHOTOPHONE (from Gk. $\phi\acute{o}\varsigma$, *phos*, light + $\phi\acute{o}\nu\eta$, *phoné*, voice), **RADIPHONE**, or **SPECTROPHONE**. Instruments in which radiant energy in the form of light acts to produce sound were devised by Prof. Alexander Graham Bell (q.v.) in conjunction with Sumner Tainter. The invention of the photophone arose from the employment of Willoughby Smith of selenium (q.v.) as a resistance medium in testing submarine cables. It was found that the electrical resistance of selenium varied considerably, and the discovery was made that this was due to the action of light, which lessened the resistance. Werner Siemens (in 1875) produced some extremely sensitive varieties of selenium, and in some of his experiments the resistance on exposure to light was found to be only one-fifteenth of what it was in the dark. Professor Bell substituted the telephone for the galvanometer and used intermittent flashes of light to produce a succession of changes in the conductivity of the selenium, corresponding in frequency to the musical vibrations within the limits of hearing, as it appeared to him that all the audible effects obtained from electricity could also be produced by variations in the light acting on selenium. He perceived the effect could be produced at the extreme distance at which selenium would respond to the action of a luminous body, and that this distance could be indefinitely increased by the use of a parallel beam of light, so that it would be possible to telephone from one place to another without a conducting wire, were apparatus devised by which variations could be produced in a parallel beam of light, corresponding to the variations in the air produced by the voice. After a number of experiments in which the resistance of the selenium cells was greatly reduced and other difficulties overcome, a form of photophone was devised in which light reflected from a plain mirror of flexible material, such as silvered mica or a microscope cover glass, against the back of which the speaker's voice is directed, was caused to vibrate with a frequency corresponding to that of the diaphragm itself. For reproducing sound at a distance sunlight or any other powerful light may be used, and a large beam is concentrated by means of a lens upon the diaphragm

mirror, which after reflection is again rendered parallel by means of another lens. The beam is received at a distant station upon a parabolic reflector, in the focus of which is placed a sensitive selenium cell, connected in a local circuit with a battery and a telephone. The loudest effects were produced by rapidly interrupting the beam of light by a perforated rotating disk, revolving over the face of another perforated disk, with holes corresponding. These experiments led to others with substances other than selenium, and without the use of telephone or battery. A thin sheet of hard rubber was held close to the ear while a beam of intermittent light was thrown upon it by a lens, the result being the production of a musical note, and this effect was intensified by arranging the hard rubber as a diaphragm and listening through a hearing-tube. The conclusion was reached that sounds could be produced by the action of a variable light from substances of all kinds when in form of thin diaphragms. Subsequently Professor Bell concluded that sonority under the influence of intermittent light was a property of all matter. Various experiments with different fibrous and porous materials, such as cotton-wool, worsted, silks, sponge, lampblack, etc., indicated that lampblack may be substituted for selenium in an electrical receiver. In France, M. Mercardier passed an intermittent beam from an electric lamp through a prism and found a difference in the audible effects in different parts of the spectrum. These experiments were repeated by Professor Bell, who ascertained that sounds were obtained in every part of the visible spectrum excepting the extreme half of the violet, as well as in the ultra-red. A continuous increase in the loudness of the sound was observed upon moving the receiver gradually from the violet into the ultra-red, corresponding exactly with the proportion of heat in different parts of the spectrum, and showing that these effects are produced by the heat which accompanies light. Beyond this point the sound began to decrease, and then stopped so suddenly that a very slight motion of the receiver made all the difference between almost maximum sound and complete silence. Experiments with various substances led to the conclusion that the nature of the rays that produce sonorous effects in different substances depends upon the nature of the substances that are exposed to the beam, and that the sounds are in every case due to those rays of the spectrum that are absorbed by the body. These considerations led Professor Bell to construct a new instrument for use in spectrum analysis, which he termed a 'spectrophone.' The eyepiece of a spectroscope was removed and sensitive substances were placed in the focal point of the instrument behind an opaque diaphragm containing a slit. These substances are put in communication with the ear by means of a hearing-tube, and if we smoke the interior of our spectrophonic receiver and fill the cavity with peroxide of nitrogen gas, we have then a combination that gives us good sounds in all parts of the spectrum, visible and invisible, except the ultra-violet. Now pass a rapidly interrupted beam of light through some substance whose absorption spectrum is to be investigated, and bands of sound and silence are observed upon exploring the spectrum, the silent positions corresponding to the absorption bands. The ear cannot compete with the eye in the examination

of the visible part of the spectrum; but in the invisible part beyond the red the method is applicable. In working in this region of the spectrum, lampblack alone may be used in the spectrographic receiver. Professor Bell stated that the spectrophone was only an adjunct to the spectroscope, but he considered that it would have a wide and independent field of usefulness in the investigation of absorption spectra in the ultra-red.

PHOTO-SCULPTURE. An ingenious use of photography to assist a sculptor in modeling portrait statues, or fac-similes and reduced reproductions of other statues, invented by M. Willème in 1867. The subject stands in the centre of a circular chamber, and is simultaneously photographed by no less than 24 cameras, arranged at equal distances round the chamber. The 24 photographs are subsequently made available in the sculptor's studio, where the clay model is arranged on a frame capable of being turned round. A magic lantern throws the outline of photograph No. 1 on a screen in front of the artist, who by means of a pantograph brings this outline to bear on the clay in its first position. The model is then turned round one twenty-fourth of a revolution, and the outline of photograph No. 2 is taken advantage of. Thus the modeler works his way in 24 changes round the model, and the likeness or fac-simile or reduced figure of the original is or should be complete. The method has been also applied to the taking of medallions and the like.

PHOTOSYNTAX (from Gk. $\phi\omega\varsigma$, $ph\acute{o}s$, light + $\sigma\acute{\upsilon}\nu\tau\alpha\acute{\xi}\varsigma$, $syntaxis$, arrangement. The first special term proposed (1893) to designate the process of the manufacture of carbohydrate food by green leaves under the influence of light. See PHOTOSYNTHESIS.

PHOTOSYNTHESIS (Neo-Lat., from Gk. $\phi\omega\varsigma$, $ph\acute{o}s$, light + $\sigma\acute{\upsilon}\nu\theta\epsilon\sigma\iota\varsigma$, $synthesis$, combination). The process by which the green parts of plants construct carbohydrates under the influence of light. Carbohydrates are substances like sugars, starch, etc., which serve as the most important foods, both for plants and animals. The materials out of which the plant builds these foods are carbon dioxide and water. The idea current in the middle of the last century, and persisting even yet, that plants obtain their carbon compounds chiefly from the soil is erroneous. Few of the materials absorbed from the soil are fairly to be considered as foods. Carbon dioxide is present in normal air in minute quantities, usually less than three parts in 10,000. Yet it is absorbed by the aerial parts of plants, particularly the leaves, in sufficient quantities, because it finds its way by diffusion at high speed through the minute openings in the epidermis (stomata, q.v.) into the intercellular spaces which are bounded by moist cell walls. (See AERATION.) In the water of these it readily dissolves and diffuses to the interior of the cells, where under proper illumination it is being used as rapidly as it can be absorbed. (See ABSORPTION.) It is not possible for the carbon dioxide to be dissolved in any considerable quantity by the superficial cells themselves, since the walls of these are more or less completely waterproofed to prevent evaporation. This effectually prevents solution and consequent diffusion of the carbon dioxide. The water necessary for food-making is obtained by absorption (q.v.) through the roots. The

amount requisite for this purpose, however, is very small in comparison with the great quantities needed to replace that lost by evaporation. (See TRANSPIRATION.) Carbon dioxide does not merely dissolve in the water, but enters into loose chemical union with it, producing carbonic acid, which is highly unstable, as compared with the very stable carbon dioxide. Therefore it may be readily decomposed and its components rearranged to form a new substance. This is done by the living protoplasm.

The necessary energy is only obtainable when the plant is supplied with light of sufficient intensity. To obtain the requisite energy plants have developed in the cells lying near the surface minute protoplasmic bodies called chloroplasts, holding various green and yellowish pigments called collectively chlorophyll (q.v.). These pigments absorb only certain wave lengths of light, as shown in the accompanying absorp-

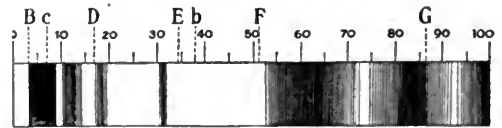

FIG. 1. THE ABSORPTION SPECTRUM OF CHLOROPHYLL. The most important absorption bands are the three regions near the B, C, and D lines. The absorption to the right of the F line is faint and not easy to resolve into three bands. It seems to be due mainly to carotin.

tion spectrum (Fig. 1). They derive their sole significance from their association with the living protoplasm, or enzymes (q.v.) produced by it. Like chemical action may be produced by protoplasm when energy is supplied to it in other ways, or when radiant energy of different wave lengths than that absorbed by chlorophyll is obtained. Thus certain bacteria containing purple pigments absorb some of the invisible ultra-red rays, and these organisms are said to produce carbohydrates.

It is possible to determine in some measure the influence of light waves of different lengths. It appears that the most efficient wave lengths are those which appear as red, orange, and yellow to our eyes. It has been clearly shown that absorbed light supplies the energy and that the chloroplasts do not act merely as a screen to cut off injurious or useless radiations, a theory which was once maintained with some vigor. The intensity of light adequate for photosynthesis approaches that of the brightest diffuse daylight. No plants are able in nature to secure sufficient carbon dioxide to utilize all the energy obtained from direct sunlight, though many of them are adapted to such conditions. Photosynthesis is nearly proportional to the intensity of the light, and though it is observable by proper methods in twilight, it has not yet been observed in so weak illumination as full moonlight. Artificial lights of various kinds are efficient in proportion to their intensity. Horticultural experiments in the United States and England have shown that electric light may be used for forcing certain plants in winter to a more vigorous development of foliage and vegetative organs. See ELECTRO-CULTURE OF PLANTS.

Scarcely any two cells of the plant receive the same amount of light. Those, therefore, which lie on the upper side and are first reached by the light are in the most favorable position for photosynthesis. As many as possible are developed by

leaves in this position. Indeed, the palisade region (see LEAF) depends for its mode of development on the action of light. The internal cells, receiving only that which has passed one or more external layers, work at a slower rate, although they are usually better situated for receiving an adequate supply of carbon dioxide. Window plants, receiving the light only from a very limited portion of the sky, at most 30 to 50 per cent., are usually more or less starved, because the energy received is inadequate in amount for the necessary food-making. A comparison of the total energy received by the leaf and the amount stored in the carbohydrates formed shows that a relatively small amount of the kinetic energy has become potential in these compounds. Inability to determine the exact quantity of carbohydrate formed and to separate the energy absorbed by the chloroplasts from that absorbed by the other portions of the plant make such computations uncertain. From them, however, it appears that 1 per cent. or less of the total energy received by the leaf reappears in the starch of starch-producing leaves. The products of photosynthesis are probably unlike in different plants. Starch is often spoken of as the chief product of this process. It is probably not only a secondary product of photosynthesis, but it is certain that many plants do not form it at all. Most of the larger seaweeds, for example, make other carbohydrates and much of the carbohydrate food in the ordinary land plants is in the form of sugars, cellulose, gums, etc.

Practically nothing is certainly known of the details of the process of photosynthesis or of its first product. Several theories have been proposed; the most plausible is that of Bayer, which has recently been receiving substantial support, although it is by no means yet clearly established. According to this theory the rearrangement of the elements of carbonic acid (H_2CO_3) results in the formation of formaldehyde (CH_2O) with the elimination of oxygen (O_2). After the production of formaldehyde it is condensed (or 'polymerized') into one of the simpler sugars, such as glucose ($C_6H_{12}O_6$), which could be formed by the proper union of six molecules of formaldehyde. This again could be polymerized to form cane sugar, and cane sugar has been shown to be one of the early products of photosynthesis in a number of ordinary leaves. Starch, which is a very complex carbohydrate, must result from further compounding, and therefore can be looked upon only as a still more remote product. Some of the supports for Bayer's hypothesis are as follows: First, green leaves and even uninjured seedlings have been supplied directly with glucose, with the result that they nourish themselves therewith and store up reserve starch; second, it has been possible to supply one of the products intermediate between formaldehyde and glucose, namely glycerose ($C_3H_6O_3$), to starved plants in the absence of CO_2 , with the result that they nourish themselves and store up starch; third, formaldehyde, though under ordinary conditions a violent poison, has been supplied at the moment of its formation to an alga and the plant nourished thereby; fourth, formaldehyde has recently been detected in the green leaves of active plants; fifth, formaldehyde is produced from CO_2 in light in liquid containing leaf-enzymes and chlorophyll, though no living protoplasm is present. Such experiments, while not conclusive,

strongly support the idea that formaldehyde is the first product of photosynthesis.

The by-product of photosynthesis, oxygen, is nearly equal in volume to that of the carbon dioxide absorbed. On the average it is a little less, but in many experiments is at least 8 per cent. greater. In such cases the extra oxygen may be derived from the decomposition of other substances in the plant, since it is impossible to distinguish all sources of the evolved oxygen, which is always given off in the neutral (O_2).

It is not possible to ascertain exactly the amount of carbohydrates made under given conditions, since an indeterminate amount is used at once in the making of other more complex proteid foods, and still other indeterminate quantities are lost from any given region by migration. The net product has been determined in the sunflower as 1.6 to 1.8 grams of starch per hour per square meter; in the gourd, 1.5 to 1.7 grams; in the bramble, by a different method, 1.54 grams. The accumulation of the products of photosynthesis never reaches such a point in the normal plant that it interferes with the process. By artificial means, however, this result may be brought about. Since the supply of energy to a well-illuminated plant is more than sufficient to enable it to utilize all the carbon dioxide which can enter the cells under the usual small partial pressure of carbon dioxide, increasing the pressure of this in the atmosphere, and therefore supplying a greater quantity to the living cells, increases the amount of carbohydrates produced. This increase is almost proportional to the relative increase of CO_2 , up to a point at which this gas retards other functions. An increase of CO_2 in the atmosphere from 3 parts in 10,000 to 600 or 800 parts proves beneficial for photosynthesis. Variations in other conditions, however, may so greatly affect this that inconsistent results may be obtained from experiments.

The rate of photosynthesis is affected by the temperature, increasing with a rising temperature to an optimum, which is not far from the optimum for growth. Yet it must be remembered that many plants flourish, and therefore may make food, at very low temperatures, e.g. the alga in Arctic waters, or at very high temperatures, e.g. alga in hot springs. In conifers, photosynthesis has been reported as occurring at temperatures even below $0^\circ C$. Though the leaves and surface tissues of plants are especially liable to lose water, and therefore to become flaccid, no interference with photosynthesis results.

PHOTOTAXIS (Neo-Lat., from Gk. $\phi\acute{o}s$, *phōs*, light + $\tau\acute{\alpha}\xi\iota\varsigma$, *taxis*, arrangement, from $\tau\acute{\alpha}\sigma\sigma\epsilon\upsilon$, *tassein*, to arrange). (1) In animals, control of the direction of locomotion by light. Like the unicellular plants, the Protozoa as well as higher animals may migrate in a direction determined by that of the rays of light. According as the migration is toward or from the source of light, we can distinguish positive and negative phototaxis. The flagellate Infusoria (*Chilomonas* and *Euglena*) will move toward the light, crowding together on the illuminated side of the vessel. *Amoeba* has been observed by Davenport to be strongly phototactic, showing that such responsiveness is a general property of protoplasm, the result of chemical changes produced by light. Ciliate infusorians are not markedly phototactic. Cells containing such different kinds of pigment

as the chlorophyll of plants and the retinal pigment of the eyes of arthropods respond to the action of light in a similar way, this response being an adaptive one. A striking example of phototaxis in pigmented cells (chromatophores) is described by Keller. He has discovered that the dark color of the (illuminated) skin is due to the rich branching at the base of the epidermis of black pigment cells lying deep in the cutis. In the dark, the pigment granules stream out of the branches into the cell-body, but the branches themselves are undisturbed. So long as the black pigment has this central position, the skin appears whitish. The light, on the contrary, causes the pigment, which is probably carried passively in the plasma, to move centrifugally. (See PIGMENT.) Hydra was observed by Trembley to wander toward the light, and this is of advantage to the animal because many of the Entomostraca on which it feeds are also phototactic. So also is the starfish. The phenomenon is especially marked in bilateral animals, such as planarians, annelids, crustaceans, flies and many other insects, mollusks, and vertebrates. As Davenport states, animals which live in shady places or in the dark are negatively phototactic, i.e. shun the light, while those living in the light are positively phototactic. The house-fly is well known to be phototactic, but its maggot shuns the light. Butterflies, says Davenport, are attuned to a high intensity of light, moths to a low intensity, so that bright sunlight, which calls forth the one, causes the other to retreat. On the other hand, a light like that of a candle, so weak as not to stimulate a butterfly, produces a marked response in the moth. The males and females of ants have been observed while mating in the air to be strongly phototactic, but after that period they show themselves neutral (Loeb). The larvae (nauplii) of barnacles as well as other pelagic animals rise to the surface of the sea during the night, but descend before the strong sunlight. Temperature also affects phototaxis; a low temperature causes several of the normal responses, while under a high temperature it is accelerated; also Loeb has found that a concentrated medium, as when the water is rendered more salt, acts as the lower temperature. It is thought that, while in the retina of the eye the protoplasm is specialized for perceiving light, there is some evidence that in the eyeless animals the whole surface of the body contains such light-perceiving substances. This is well known to be the case with the earthworms, and perhaps with the oyster, Pholas, Unio, etc. The pelecypod Psammobia, the blind Protens of caves, and Triton cristatus when blinded, are irritated by rays of light, especially the blue rays, falling on the skin. Consult Davenport, *Experimental Morphology*, part i. (New York, 1897), which contains a full bibliography. Compare TROPISM.

(2) In plants, the sensitiveness to illumination. This may be fundamentally the same as heliotropism (q.v.). The effect of light upon the organism may be to accelerate or retard the movements of the motor organs on the illuminated side, this causing the body to be rotated until both sides are equally illuminated (see CHEMOTAXIS and CHEMOTROPISM), when any progress will then necessarily be toward or away from the source of light. Organisms which approach the source of light are said to be posi-

tively phototactic, those which recede from it negatively so. The same organism may show successively both forms of response in light of different intensity. For instance, *Euglena viridis* is positively phototactic in weak light, but negatively so in strong.

PHOTOTHERAPY (from Gk. φῶς, *phōs*, light + *θεραπεία*, *therapeia*, cure, from *θεραπεύειν*, *therapeuein*, to cure, from *θεράπων*, *therapōn*, attendant). Treatment of disease by means of light. The method of applying light for therapeutic purposes, devised by Dr. Niels R. Finsen, of Copenhagen, about 1896, is founded on the following data: (1) The bactericidal property of the chemical rays of light; (2) the power of the chemical rays of light to produce an inflammation of the skin (sunburn, *erythema solare*); (3) the power of the chemical rays of light to penetrate the skin. The violet and ultra-violet rays of light obtained from the sun or from an electric arc-lamp will, in a few hours, kill plate cultures of *Bacillus prodigiosus* at a great distance. The so-called sunburn is not a burn. If sunlight or electric light be passed through a layer of distilled water so arranged as to cut out the ultraviolet rays (the dark rays of heat), the resulting skin-inflammation is as great as if the light were uncontrolled. If sunlight be thrown upon the skin through a glass screen which cuts out the violet and ultra-violet rays, there is no resulting inflammation. Again, if small sealed bottles containing muriate of silver be placed under the skin of some animals kept in the dark, and of some animals exposed to the sun, if the tubes be removed an hour later, it will be found that the muriate of silver is blackened in the cases of the animals which were exposed to the sunlight, but not in the cases of those kept in the dark. It is shown by experiment that the chemical rays of light penetrate more easily in bloodless tissues than in those filled with blood. In a piece of sensitized paper put against the back of a man's ear upon the front of which the blue and violet rays are allowed to fall for 5 minutes, no reaction takes place. If the paper be replaced and the ear be compressed tightly between two glass plates and exposed again to the same light, the paper will be blackened after 20 seconds' exposure. In the treatment of patients, sunlight is used in the summer, when the sky is bright, but otherwise the light of electric arc-lamps of 50 to 80 amperes is employed. Concentration of the light is necessary to render it powerful as a bactericide. To avoid burning the skin, the light must be colored. To make the sunlight strong and cool Finsen devised a special apparatus, consisting of a lens about 20 to 40 centimeters in diameter. The lens, composed of a plain glass and a curved one, is framed in a brass ring, with a bright blue, weak ammoniacal solution of sulphate of copper between them. The water absorbs the ultra-red rays and, being blue, it excludes much of the red and yellow rays. The excluded heat rays have little bactericidal power; whereas the blue, violet, and ultra-violet rays are but slightly impaired in chemical or bactericidal power. The lens is so hung that it can be raised and lowered as well as turned on a vertical and horizontal axis, by which means it can be placed perpendicularly to the sun's rays, and at such a distance as to make the light strike the diseased area. For concentrating the electric arc-light Finsen devised an

apparatus consisting of lenses of quartz framed in two brass tubes, telescoping the one within the other. Quartz allows the ultra-violet rays (even those of very short wave-length) to pass through it much more easily than through glass, and these rays from the electric light are of less length than those from sunlight. Facing the lamp are placed two lenses having together a focal distance of 12 centimeters. At this distance from the lamp, those lenses will concentrate and render parallel the divergent rays from the lamp, and direct them through the brass tubes, at whose distal end they strike two quartz lenses. These lenses concentrate the parallel rays and converge them till they are united about 10 centimeters beyond the outer lens. The space between these latter lenses is filled with distilled water which absorbs the ultra-red rays, but does not impair the blue, violet, and ultra-violet rays. Surrounding this end of the apparatus is a mantle, through which cold water flows to prevent boiling of the distilled water between the lenses. In spite of all this precaution, the light is still too warm, and the skin must be cooled to avoid burning. This is effected by an apparatus consisting of a plate of quartz and a plain convex lens of quartz, both fitted into a conical brass ring, which carries two small tubes and four arms. To each arm is fastened an elastic band by means of which the apparatus is pressed against the skin. Cold water is run into one tube and out of the other, and thus the skin is cooled so that it can tolerate the strongest light. The pressure of the plano-convex lens on the skin renders it anæmic, thus fitting it for the easy penetration of the chemical rays. A small area of the skin is treated for an hour each day. The skin swells and becomes red, and a bulla may appear; but sloughing has not resulted. During the application the nurses are obliged to wear dark glasses to protect their eyes from the brilliant light. Dilatation of cutaneous vessels by the violet rays may continue for six months. Many diseases of supposed bacterial origin have been treated by this method, but cures have resulted only in cases of *lupus vulgaris*, *lupus erythematosus*, *alopecia areata*, and *carcinoma*. The greatest success has been reached in cases where there was an absence of scarring, of pigmentation, of great vascularity, of great depth below the surface, of involvement of eyelid or mucous membranes, or of great extent of lesion.

The number of patients at Finsen's Institute has increased from seven in 1897 to an unnumbered clientèle, with over a hundred on a waiting list. A Brooklyn, N. Y., physician has opened an institute for Finsen's treatment. The Roentgen rays (q.v.) penetrate to deep layers not reached by sunlight or electric light. Consult Morris & Dore. "Finsen's Light Treatment of Lupus and Rodent Ulcer," in *British Medical Journal*, February 9, 1901.

PHOTOTROPISM (from Gk. φῶς, *phōs*, light + τροπή, *tropē*, a turning, from τρέπω, *trepein*, to turn). A sensitiveness of plant organs to light, by virtue of which they bend to assume definite positions with reference to the direction of light incident upon them. See HELIOTROPISM.

PHRANZA, frän'zä, or **PHRANZES**, frän'zäs (Gk. Φραντζή, *Phrantzē*), GEORGE (1401-78). A Byzantine historian, born at Constantinople. He was secretary to the Emperor, Manuel II.,

and held other high offices, but at the fall of Constantinople was obliged to flee, and ended his days in an Italian monastery, where he wrote his valuable *Chronicle*, embracing the period of Byzantine history from 1259 to 1477. It was printed in Vienna in 1796, and translated into Latin in 1838.

PHRASE (Lat. *phrasis*, from Gk. φράσις, manner of speech, from φράζειν, *phrazein*, to declare). The name given, in music, to the simple motives containing in themselves no satisfactory musical idea, which enter into the composition of every melody containing a perfect musical idea, e.g.



The phrase most usually consists of two measures; in compound time it may be comprised in one measure, and an extended phrase is one which contains three measures. In the more simple and regular forms of musical composition, two phrases unite to form a section, ending in a cadence, and a perfect musical idea is formed of two such sections terminating, the first with the dominant, the second with the tonic harmony. See FORM.

PHRASING. The proper rendering of musical phrases. (See PHRASE.) A musical composition is analogous to a literary one, the sentences being replaced by phrases: upon their correct interpretation depends the intelligible presentation of the whole piece. One of the most important elements of phrasing is accent (q.v.), the general principles of which will be found under RHYTHM; but in no case must an accent be so insisted upon as to break the unity of the musical phrase. On the contrary, the ordinary accent is often postponed or anticipated in order to emphasize the general effect of the phrase. For the same reason, especially in rapid passages, accents are often added; while in quick movements accents are sometimes omitted so as to give an impression of unity to a number of separate bars. Two common faults in phrasing are breaking up a group of notes which together form a musical sentence, and running together two distinct sentences. In instrumental work, especially, there is a tendency to make a break at the end of a bar; but in reality a sentence always ends on the accented division of a bar, the bar-stroke having absolutely no relation to phrasing. In vocal music the musical accents correspond with those of the text, and the phrases are, as a rule, dependent upon the lines or word sentences. Vocal phrasing, therefore, is obviously much simpler than instrumental. The signs most commonly used to indicate phrasing are the dash; the curved line, denoting *legato*; and the slur; but the interpretation of any composition is to a great extent a matter of personal appreciation and discrimination. For some helpful suggestions on the subject, consult: Ehrenfechter. *Delivery in the Art of Pianoforte Playing* (London, 1897); Goodrich, *Theory of Interpretation* (Philadelphia, 1899); Lussy, *Traité de l'expression musicale* (6th ed., Paris, 1892).

PHRENOLOGY (from Gk. φρήν, *phrēn*, heart, mind + -λογία, *logia*, account, from λέγειν, *legēin*, to say). The theory that the mind consists of a number of independent faculties, each of which has a definite localization in a region

of the brain whose size is indicative of the degree of the faculty resident in it. Franz Joseph Gall (q.v.), an eccentric Viennese physician, announced about 1796 the discovery of a system of phrenology. He asserted that he had arrived at his results empirically, having for several years examined the heads of individuals who exhibited unusual mental or moral endowments. By these examinations he made out a system of correlations between the topography of the skull and the traits. He further concluded that the size and configuration of the brain was indicated by the size and configuration of the skull. His lectures, begun in 1796, ceased at the order of the Austrian Government in 1802, his doctrines being judged to be materialistic and inimical to the truths of morality and religion. In 1804 he associated with him his favorite pupil, Johann Gaspar Spurzheim (q.v.), and the two traveled through Germany, Prussia, and Switzerland to France. In Paris, the French Institute appointed a commission to investigate their assertions. This commission reported favorably upon certain methods of dissection, etc., but regarded their main conclusions as hypothetical. In 1809 the two began publishing a large work, *The Anatomy and Physiology of the Nervous System in General, and of the Brain in Particular, with Observations upon the Possibility of Ascertaining Several Intellectual and Moral Dispositions of Man and Animals by the Configuration of Their Heads*. Gall died in Paris in 1828, and was interred with the greatest marks of respect and honor. Spurzheim came to America in 1832, but died suddenly shortly after his arrival at Boston.

The fundamental tenets of phrenology are that the brain is the material substratum of mind, that it is a multiplex structure, composed of a definite number (originally 34, now 42) of constituent organs, each of which is the seat of a particular power of the mind—a 'sentiment,' a 'propensity,' or an 'intellectual faculty.' Furthermore, phrenology teaches that these 42 organs, or pairs of organs, constitute a series of cones with their apices at the oblongata and their bases at the surface. Each prominence in the skull indicates the size of the organ just beneath it, and in that way the development of the correlated mental faculty; for this development varies directly with the volume of its brain substrate, and, conversely, the exercise of any faculty promotes the growth of its brain seat. The 'propensities' or 'passions,' situated at the lower and posterior part of the brain, are amativeness, philoprogenitiveness, continuity, adhesiveness or friendship, combativeness, destructiveness, constructiveness, acquisitiveness, secretiveness, inabitiveness, alimmentiveness, vitativeness, and conjugal love. The 'sentiments,' situated at the superior portion of the cranium, are self-esteem, love of approbation, cautiousness, firmness, benevolence, veneration, hope, ideality, conscientiousness, spirituality, and sublimity. The 'intellectual faculties,' in the anterior region, are individuality, form, space or size, weight or resistance, color, locality, order, duration, number, tune, language, comparison, causality, wit, imitation, supernaturality or wonder, human nature, and suavity. In actual diagnosis, the size of the prominence determined the degree of the faculty only when taken in conjunction with other tendencies, for one faculty might aid or inhibit the function of another.

It is scarcely necessary to say that, as a pretension to a science, phrenology is related to modern neurology as astrology to astronomy, or alchemy to chemistry. It did, indeed, serve a useful purpose in stimulating the investigation of cortical function, in instilling the principle of the dependence of consciousness upon the cerebrum, and in offsetting the extreme views of men like Magendie and Flourens, who believed that the brain functioned homogeneously like the lungs or the liver. But in the light of modern knowledge phrenology is bad psychology and bad neurology. Modern psychology does not regard the mind as a bundle of faculties. Its components are determined rather by the contributions of the various sense-organs to its structure than by the types of activity by which the psychological self seems to acquire knowledge or express its attitude. Neurologically, too, there are many disproofs of phrenology. Different skulls have a different thickness; the same skull varies in thickness in different regions; prominences on the surface do not necessarily indicate a greater size in the part of the brain beneath; there is no correlation between brain weight and intelligence; three-fifths of the gray matter of the cortex is concealed in the sulci; loss of portions of the brain by accident or disease destroys or impairs the sensory or motor functions connected with some sense department, or some association system, not some 'faculty.' Finally, the whole structure of phrenology falls with the modern investigations of cortical localization by the methods of degeneration, electrical stimulation, medullation, and extirpation. See **PHYSIOLOGY**.

BIBLIOGRAPHY. Sewall, *An Examination of Phrenology* (Washington, 1837); *Phrenological Journal*, xxxi. 4 (New York, 1885); Barker, *The Nervous System* (New York, 1899); Donaldson, *The Growth of the Brain* (New York, 1898); Holländer, *Historisches über die Localisation der psychischen Thätigkeiten im Gehirn mit besonderer Berücksichtigung der Lehren Galls* (Berlin, 1899).

PHRIXUS (Lat., from Gk. Φρίξος). The son of Athamas and Nephele. With his sister Helle he was rescued by his mother when about to be sacrificed to Zeus, and carried to Colchis upon a ram with golden fleece. On the journey Helle fell into the waters called after her, the Hellespont. The fleece of the ram, given to King Autes and hung upon the grove of Ares, was the object of the Argonautic Expedition.

PHRYGIA, frij'î-â (Lat., from Gk. Φρυγία). A country in Asia Minor, the extent and boundaries of which varied very much at different periods of ancient history. Originally, the boundaries toward the east were the river Halys and the territory about Iconium, which was the last Phrygian city; toward the south, it touched the Taurus and the Pisidian Mountains; on the north, it reached the Hellespont and Propontis; on the west, it seems to have included the Troas and Mysia, and may have held suzerainty over Lydia and Caria. Later invaders from Thrace, who occupied Bithynia and Mysia, cut this region into two parts: Little Phrygia, a somewhat indefinite region south of the Hellespont, and Greater Phrygia, which alone preserved the national character. This was bounded on the north by Bithynia and Paphlagonia, on the east by Pisidia Lyeaonia, on the south by Cappadocia, and on

the west by the maritime countries of Mysia, Lydia, and Caria. The boundaries were further modified by the Gallic invasion of the third century B.C. (See GALATIA.) Pergamene conquests added part of Southern Bithynia, including the important city of Dorylæum, under the name of Phrygia Epictetus. The Roman provincial administration divided Phrygia, attaching the northeastern part to the Province of Galatia and the western portion to the Province of Asia. Phrygia was in general a high and somewhat barren plateau, though its pastures supported immense flocks of sheep, noted for the fineness of their wool, as indeed they still are. The most fertile part was the valley of the Sangarius, but the most beautiful and populous district was the southwestern, at the base of the Taurus, where the Mæander and other streams had their rise, and here were the chief cities, Synnada, Celæna, Apamæa, Colossæ, Laodicea, while farther to the east was Antioch. The mountains and streams yielded gold; Phrygian marble was anciently celebrated, and the cultivation of the vine appears to have been extensively carried on.

The Phrygians were certainly an Indo-European race, and seem to have entered Asia Minor from Thrace, pushing into the interior from the Troad along the valley of the Sangarius, and making themselves masters of the whole tableland, and probably extending their sway over the Asiatic tribes on the coast. We hear of a race of powerful kings alternately bearing the name of Gordius and Midas, and in the mountains near the headwaters of the Sangarius are the great rock-cut tombs or façades which were associated with these rulers. The invasions of the Cimmerians (c.675 B.C.) seem to have broken their power, and henceforth they played no part in history, but fell first under the rule of the growing Lydian kingdom, then under Persia, Macedonia, Pergamum, and Rome. They seem to have been a peaceful rustic people, devoted to agriculture and cattle-raising. Their religion was an ecstatic nature worship in which the Great Mother of the Gods, Rhea or Cybele, and a male deity, Sabazius, played a great part. The orgiastic rites and wild music seem to have exercised considerable influence upon the Greeks and Romans, and we find their deities transplanted to the Western world. Consult: Ramsay, *Historical Geography of Asia Minor* (London, 1890), and especially his incomplete work, *Cities and Bishoprics of Phrygia* (Oxford, 1895-97).

PHRYGIAN CAP. See LIBERTY CAP.

PHRYGIAN LANGUAGE. The native language of the Phrygians is known partly through glosses preserved by Hesychius and other lexicographers and authors, partly through inscriptions found in the territory once occupied by this people. Tombs with inscriptions were discovered in the valley of Doghanla by Colonel Leake in 1820. Four of these inscriptions, including that on the sepulchre of King Midas, were first published by Hamilton in 1842. A number of additional inscriptions were published by Ramsay in 1883 and others copied by himself and Sterrett appeared subsequently. Many of these are in Greek, but have Phrygian additions at the end. That the additions contain formulas of execration was first surmised by Schmidt in 1869. The researches of Ramsay and Fick have corroborated

this conjecture. As Herodotus (vii., 73) and Strabo (xlvii., cexcv.) declare that the Phrygians were related to the Armenians and the Thracians, it was natural that the language should be supposed to be Armenian. That was done by Mordtmann and Gosche. A collection of 63 glosses was made by Lagarde. He concluded that the Phrygians were derived from the Thracians and that their Iranian character was proved by such words as *ἀδάμνα* and *κύρβαυτ*. There seems to be good reason for assuming that the Phrygian language belonged to the Iranian family. While most of the monuments found belong to the Roman period, there are some that have plausibly been assigned by Ramsay to the end of the eighth century B.C. If one doubtful letter is a χ rather than a ψ , as seems probable, the Phrygians apparently received their alphabet, not from the Ionians, but from the old Æolians. After the Phrygian language had been supplanted by the Greek, it still maintained itself in imprecations, believed to be more efficacious in the speech of the fathers. The same alphabet has been found at Abu-Simbel in Egypt in inscriptions that must date from B.C. 650-590 and in an inscription found in Lemnos in 1886 in an unknown language and of uncertain age. Consult: Leake, *Journal of a Tour in Asia Minor* (London, 1824); Hamilton, *Researches in Asia Minor, Pontus, and Armenia* (ib., 1842); Stewart, *Ancient Monuments of Lydia and Phrygia* (ib., 1842); Lagarde, *Gesammelte Abhandlungen* (Leipzig, 1866); *Corpus Inscriptionum Græcarum*, iii. 3810, et seq.; Schmidt, *Neue lykische Studien* (Jena, 1869); Fick, "Zum Phrygischen," in *Bezenberger's Beiträge*, xiv., 50; Ramsay, in *Journal of the Royal Asiatic Society*, xv. (London, 1883); id., in *Journal of Hellenic Studies* (London, 1882, 1884); id., in *Zeitschrift für vergleichende Sprachforschung*, xxviii. (Gütersloh, 1887).

PHRYNE (Lat., from Gk. *Φρύνη*). One of the most celebrated courtesans of antiquity. She was a daughter of Epicles, and was born at Thespie, in Beotia. She was of very humble origin, and is said originally to have gained her livelihood by gathering capers, but her beauty afterwards brought her such wealth that, when Alexander destroyed the walls of Thebes, she is said to have offered to rebuild them, if she might be allowed to inscribe on them the words: "Alexander destroyed them, but Phryne, the courtesan, rebuilt them." Being on one occasion accused by Euthias of profanation of the Eleusinian mysteries, she was summoned before the court of the Heliasts and was there defended by the orator Hyperides; but Hyperides, seeing that the verdict of the court was likely to be an unfavorable one, threw aside her veil and exposed her bosom and shoulders; the judges thereupon acquitted her, and she was carried in triumph to the Temple of Aphrodite. She served as the model for Praxiteles's Cnidian Venus, and for the Anadyomene (q.v.) of Apelles, she having, on the occasion of a festival at Eleusis, entered the sea, unclad, in the presence of the assembled throng. Her neighbors dedicated to her at Delphi a gilded statue resting on a base of Pentelic marble, the whole the work of Praxiteles. There is preserved in Athenæus an epigram in her praise written by Praxiteles and inscribed on a statue of Cupid, which he presented to her and which she dedicated at Thespie.

PHRYNICHUS, frín'i-kūs (Lat., from Gk. Φρύνιχος). A Greek tragic poet of Athens, an older contemporary of Æschylus. He won his first victory in b.c. 511 and his last in 476, when Themistocles was his *choragos*. Like Æschylus, he is said to have died in Sicily. In all the accounts of the rise and development of the tragedy, Phrynichus is ranked immediately after Thespis, and according to some critics he should be regarded as the real inventor of tragedy. He was the first to bring female characters on the stage; for the light satyr plays of his predecessors, he substituted plays on serious subjects taken both from the heroic age and from the history of his own time; and he was the first to introduce an actor distinct from the leader of the chorus, and thus to open the way for the development of the dialogue. In his works, however, the lyrical choruses still retained the principal place, and these are said to have been so celebrated that they were sung even in the time of Aristophanes. Of his plays, the most important were *Φοῖβισσαι*, which dealt with the defeat of the Persian invaders (b.c. 480), and is said to have been copied by Æschylus in *The Persians*, and *Μιλήτου ἄλωσις*, on the capture of Miletus by the Persians. According to Herodotus, the Athenians were so moved by the latter tragedy that they fined the poet one thousand drachmas for recalling to them the disasters of their kinsmen, and passed a law forbidding further performances of the piece. Only a few fragments and the titles of nine of his plays are extant. Consult: Nauck, *Tragicorum Græcorum Fragmenta* (Leipzig, 1856).

PHTHIOTIS, thi-ō'tis (Lat., from Gk. Φθιώτις). In ancient geography, the southern part of Thessaly, north of Ænis and Malis, and west of the Pagasæan Gulf. The district was famous in the epic as the home of Achilles, and from this region the Æolian colonization of Asia Minor seems to have gone forth. The population, though maintaining a Thessalian element, was considered to be Achæan. The chief cities were Phthiotian Thebes, Larisa, Lamia, Melitæa, and Thaumaci.

PHTHISIS, thi'sis. See TUBERCULOSIS.

PHYCOCYANIN (from Gk. φύκος, *phykos*, seaweed + κυανός, *kyanos*, blue). The peculiar pigment, usually bluish-green, of the blue-green algæ. See CYANOPHYCEÆ.

PHYCOERYTHRIN, fi'kō-ēr'i-thrīn (from Gk. φύκος, *phykos*, seaweed + ἐρυθρός, *erythros*, red). The red pigment of the red algæ contained in the chromoplasts, and giving the general tint of the plant body. See RHODOPHYCEÆ.

PHYCOMYCETES, fi'kō-mi-sē'tēz (Neo-Lat. nom. pl., from Gk. φύκος, *phykos*, seaweed + μύκης, *mykēs*, fungus). A group of plants which comprises, as the name indicates, those fungi most resembling the algæ. (See FUNGI.) The Phycomycetes include the black molds (Mucorales), certain insect parasites (Entomophthorales), the water molds (Saprolegniales), and a group of very important plant parasites included in the order Peronosporales. The simplest of the Phycomycetes are unicellular aquatic forms (Chytridiales) that generally live parasitically in the cells of algæ. These representatives are usually observed in a quiescent condition, in the form of thick-walled spores or resting

spore-cases, but there are motile periods in the life history when the organisms swim freely in the water. The Entomophthorales are mostly

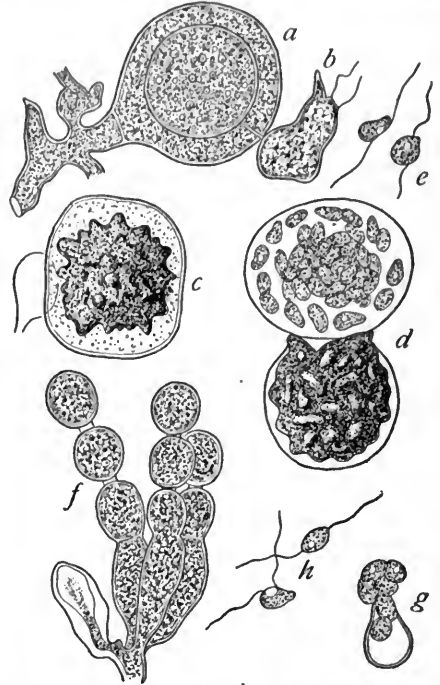

WHITE MILDEW (*Albugo Candida*).

a, Oögonium; b, antheridium; c, oöspore; d, swarm-spores escaping from oöspore; e, swarm-spores; f, conidia; g, swarm-spores escaping from conidium; h, the same, more distinct.

parasitic on insects, preferring the Diptera and Orthoptera, a common representative (*Empusa*) being found on the house fly. Late in the summer and in the autumn dead house flies may

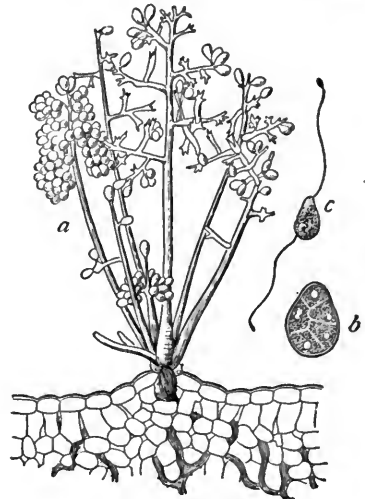

GRAPE MILDEW (*Plasmopara*).

a, The branching sporophores arising from the surface of the host; b, a germinating spore; c, a swarm-spore.

frequently be observed attached by their proboscæ to window panes, walls, and other sur-

faces, with a halo of yellowish powder on the surface around them. This powder is made up of spores that have been thrown off from the ends of fungal filaments, which after filling the body of the insect have grown through the segments to the exterior. The large common molds (Mucorales) are frequently called black molds because of the color of the spore-cases (sporangia), and to distinguish them from the green and yellow mildews. They are saprophytes, growing upon organic matter in damp places, the bread mold (*Mucor*) being a familiar example. The vegetative portion of the molds (mycelium) consists of conspicuous threads (hyphæ) plainly visible to the eye, which grow over the sub-

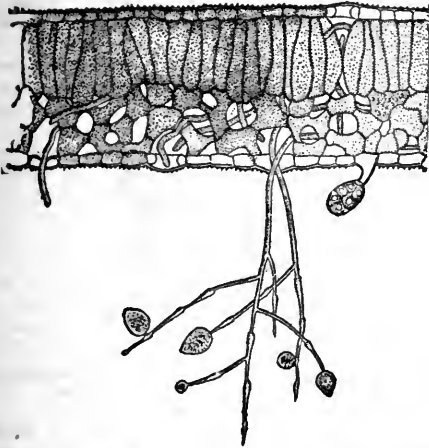

DOWNY MILDEW OF POTATOES (*Phytophthora infestans*).
Cross-section of leaf showing growth of mildew.

stratum and when possible penetrate it in all directions. The commonest fructification is a black swollen head (sporangium) containing thousands of spores, and borne at the end of an erect branch (sporangiphore). The Peronosporales are an assemblage of forms, mostly parasitic, and contain some fungi responsible for such serious diseases as the rot of potato and the downy mildews of grapes. (See paragraph *Diseases* under GRAPE and POTATO.) Another troublesome form, sometimes placed among the Peronosporales and sometimes among the Saprolegniales, is *Pythium*, the fungus responsible for the 'damping off' (q.v.) of seedlings. The water molds (Saprolegniales) have habits widely different from other Phycomycetes, being aquatic and living on dead insects, fish, and frogs, and sometimes on the living animals. They surround the body with a beautiful halo of delicate radiating filaments. These fungi sometimes cause epidemics in fish hatcheries, where they attack the mouths and gills of young trout and salmon. Consult Engler and Prantl, *Die natürlichen Pflanzenfamilien* (Leipzig, 1887—).

PHYCOPHÆIN (from Gk. *φύκος*, *phykos*, seaweed + *φαίος*, *phaios*, dusky). The brown pigment characteristically present in the cells of the brown alga. See ΠΛΕΟΡΗΥΣΕΛ.

PHYLACTERY (Lat. *phylacterium*, from Gk. *φυλακτήριον*, *phylaktērion*, safeguard, amulet, from *φυλακτήρ*, *phylaktēr*, sentinel, guard, from *φυλάσσειν*, *phylassein*, to guard). An amulet or charm worn as a protection against evil influences.

In the New Testament the name is given to a strip of fine parchment inscribed with certain passages from the Scripture (Exod. xiii., 1-10; xiii., 11-16; Deut. vi. 4-9; xi., 18-21), and inclosed in a small leathern case. This was, in accordance with a literal interpretation of Exod. xiii. 9-16; Deut. vi. 8, 9, 18, fastened by leathern straps to the forehead, just above and between the eyes, or to the left arm, at the point where the arm, hanging down, falls nearest the heart, or sometimes to the door-post.

PHYLÆ (Lat. nom. pl., from Gk. *φυλή*, *phylē*, tribe). In Greek political institutions, the tribes or clans, originally perhaps embracing all the inhabitants of a district, though in many cases there seems to have been a theory of common descent rather than residence. Among the Dorians we regularly find the three tribes, Hylleis, Dymanes, and Pamphyli; at Miletus in Ionia and at Athens we find Geleontes, Argadeis, Ægicoreis, and Hopletes, and these names recur in other Ionian communities. The most important development of the tribe was in the reorganization of the Athenian democracy by Clisthenes after the expulsion of the tyrant Hippias (B.C. 510). The four old tribes were swept away, and the whole people divided into ten tribes on the basis of the demes, in which the people were registered. The demes in each tribe were so selected that the three divisions, Mountain, Coast, and Plain, were all represented. The tribes, which were named from heroes, were Erechtheis, Ægeis, Pandionis, Leontis, Acamantis, Oeneis, Cecropis, Hippothontis, Æantis, Antiochis. The tribes were organized as corporations, and held regularly meetings, apparently at Athens, but not in their own halls. The executive officers were the Epimeletæ, and a treasurer who had charge of the property of the tribes, for as each eponymous hero had priest and sanctuary, and received a certain part of all booty in war, the tribe had to manage certain lands and investments. The tribe chose its representatives on State commissions where work was divided among the tribes, such as the repair of walls, etc. They also elected the rich men whose duty it was to provide the choruses for intertribal competition at the festivals, or other similar public duties laid upon the rich. The military organization was based on the tribal division, for each tribe furnished a regiment of infantry under a taxiarch and a squadron of cavalry under a phylarch. Though the Senate was composed of fifty from each tribe, the senators were not chosen by the tribe but by the demes, among whom they were apportioned on the basis of population.

PHYLARCHUS, fi-lär'kūs (Lat., from Gk. *Φυλαρχος*) (c.210 B.C.-?). A Greek historian. He was born probably at Naucratis, in Egypt, but spent most of his life at Athens. His great work was a history of Greece, embracing the fifty-two years between the invasion of the Peloponnesus by Pyrrhus (B.C. 272) and the death of Cleomenes III., King of Sparta (B.C. 221). His style was graphic and animated, but according to Polybius (ii., 56) he frequently falsified history on account of his passionate admiration for Cleomenes. The work was used by Troguus Pompeius and by Plutarch in his lives of Cleomenes and Aratus. The few extant fragments have been edited in Müller's *Fragmenta Historicorum Græcorum* (Paris, 1868).

PHYL'LIS (Lat., from Gk. Φυλλίς). (1) A Thracian princess, betrothed to Demophoön, the son of Theseus, who left her to go to Athens, promising to return at a certain date. When the appointed time had passed without his arrival, Phyllis killed herself and was changed into an almond tree, which put forth leaves only when Demophoön shortly afterwards returned and embraced it. (2) In pastoral poetry, a name conventionally used of a maiden or lady-love.

PHYLLOCAR'IDA (Neo-Lat., from Gk. φύλλον, *phyllon*, leaf + *καρίς*, *karis*, shrimp). A highly composite or generalized order of Crustacea, separated by Packard from the Phyllopoða. The group is represented at the present time by *Nebalia* and its allies (*Nebaliidæ*) of the North Atlantic, forming the *Leptostraca* of Claus; also by fossil forms from the Cambrian period to the end of the Carboniferous, some of which were over a foot in length, while *Nebalia* itself is about half an inch long. In *Nebalia* the

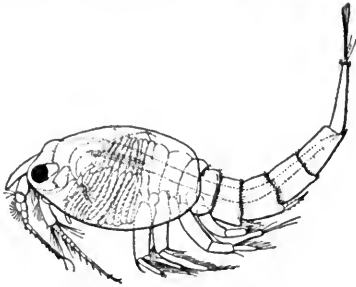

A PHYLLOCARID (*Nebalia bipes*).

body is compressed and protected in front by a bivalved carapace, closed by a weak adductor muscle, but without a hinge; the rostrum is free, movable; the eyes stalked; the eight pairs of thoracic legs resemble those of phyllopod crustacea, and the hind-body is modeled on that of a copepod crustacean such as *Cyclops*. It undergoes no metamorphosis, and is an example of the persistence of type from very early geological times.

PHYL'LOCLAD (from Gk. φύλλον, *phyllon*, leaf + κλάδος, *klodos*, branch), or CLADOPHYLL. A branch that functions, as a leaf, which it resembles in form and color. Well-known illustrations are the 'leaves' of smilax and asparagus.

PHYL'LODES (from Gk. φυλλώδης, *phyllōdēs*, leaf-like). Leaf petioles which have developed as blade-like organs that replace regular blades. They occur only among dicotyledons. Phylloides may be distinguished from true leaves by the parallel veining, and also by presenting their edges up and down (profile position). The greatest display of phylloides is found among the acacias of Australia, where nine-tenths of the numerous species have phylloides instead of true leaves. The normal blade of these acacias is pinnately compound, as is shown by their seedlings, and occasionally when older growths are subjected to unusual conditions. In the case of pitcher plants (see CARNIVOROUS PLANTS) the urns, tubes, etc., are usually regarded as hollow phylloides, the true blade being represented by the more less conspicuous lids.

PHYL'LOGRAP'TUS (Neo-Lat., from Gk. φύλλον, *phyllon*, leaf + γραπτός, *grapτος*, written,

from γράφειν, *graphein*, to write). A genus of fossil graptolites, index fossils of the Lower Ordovician rocks of North America and Northern Europe. The theca, or cells in which the animals lived, are arranged in four rows with their dorsal sides united along a common axis to form a four-bladed colony, the blades of which are at right angles to each other. See GRAPTOLITE.

PHYLLOP'ODA (Neo-Lat. nom. pl., from Gk. φύλλον, *phyllon*, leaf + πούς, *rous*, foot). An order of fresh-water Crustacea, in which the legs are broad and leaf-like, subdivided into lobes, and adapted for respiration as well as locomotion. The trunk is not differentiated into a thorax and abdomen. The eyes are usually simple or compound, and either sessile (*Apus*) or stalked (*Branchipus*), while there is a median

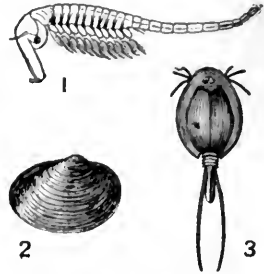

PHYLLOPOD CRUSTACEANS.

1. *Branchineella Coloradensis*; 2. Shell of *Estheria Belfrugi*; 3. *Lepidurus Coeui*; front and side views.

simple eye retained from the Nauplius stage. The number of body-segments varies greatly, and the body is usually protected by an ample shell consisting of two valves closed by an adductor muscle. In the group represented by *Branchipus* and the brine shrimp (*Artemia*) there is no shell. These crustaceans are very primitive, and apparently are the ancestral forms of the class Crus-

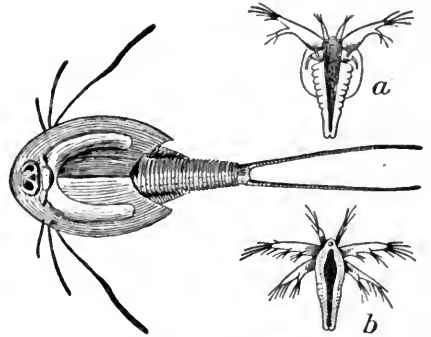

PHYLLOPODA AND LARVÆ.

Adult of *Apus acqualis*; and (a) Larva of *Apus caneriformis*; (b) Nauplius of *Artemia salina*.

tacea (q.v.), their limbs being much like the parapodia of annelid worms. A Cambrian form (*Protocaris*) is supposed to be allied to *Apus*. All the members of this order hatch in the Nauplius stage, and after a series of molts attain the adult form. The phyllopods live in pools liable to dry up in summer. Their eggs are of two kinds, summer and winter, the latter being protected by a dense shell, so that they can dry

up and live for months or years, the young hatching when the eggs are moistened by the refilling of the pools or ditches. In some species the males have not yet been found. Consult Packard, *A Monograph of North American Phyllopod Crustacea* (Washington, 1883).

PHYLLOTAXY (from Gk. φύλλον, *phyllon*, leaf + τάξις, *taxis*, arrangement). Leaf arrangement; that is, the methods in which leaves are disposed upon their axes. See LEAF.

PHYLLOXERA (Neo-Lat. nom. pl., from Gk. φύλλον, *phyllon*, leaf + ξηρός, *xēros*, dry). An insect of American origin (*Phylloxera castantriæ*), belonging to the aphid family, and which accidentally introduced into France about 1859 upon native American vines, spread through the principal vine districts of Southern Europe, causing enormous damage. It has further spread into Algeria and through Southern Russia into the adjoining countries of Asia. It has also been carried into New Zealand and South Africa, as well as portions of Australia. In the United States it was at first known only in the region of the Rocky Mountains, but was afterwards found in California, where it is confined to those vineyards in which the European vine is grown from its own roots.

The Phylloxera is indigenous to North America, where it has always existed on the wild vines. It occurs in four forms, the leaf-gall form (*gallicola*), the root form (*radicicola*), the winged or colonizing form, and the sexual form. The sexual insect lays the winter egg on the old wood. The young one hatching in the spring proceeds to a young leaf and locates itself upon the upper surfaces, gradually forming a gall about itself which projects from the lower side of the leaf. It reaches full growth in fifteen days, and fills its gall with small yellow eggs, from 500 to 600 in number. These eggs hatch in eight days, and the young migrate to all parts of the vine to form new galls. Six or seven generations of these wingless females follow one another through the summer, frequently covering the leaves with galls. At the approach of cold weather the young proceed to the roots, remaining dormant until spring. In the spring the root is attacked by a series of generations of wingless females which produce swellings upon the rootlets. During the late summer and fall some of the root-lice give birth to winged females, which escape through the soil and fly to neighboring vines, laying their eggs on the bark. From these eggs the sexual generation issues, and the life cycle is begun again. The root form, however, may proceed in successive broods for a number of years, as is the case with the European vines on which the leaf form rarely occurs. The insect is spread by the flight of the winged females, by the migration of the root-lice through cracks in the soil, and by the carrying of the leaf-gall lice by winds, by birds, and by other insects, and further by the shipping of infested rooted plants or cuttings bearing the winter eggs. The leaf form is especially noticeable upon American vines, and is common upon the wild vines. The root form is rarely seen, but is the cause of the only severe injury to the plant. When occurring plentifully, the death of the vine in a few years is certain. The root-lice first produce enlargements on the rootlets, extending their work to the larger roots. These become swollen

and broken and finally die and rot. The vine stops growing, the leaves become sickly and yellowish, and since the Phylloxera disappears from the dead roots, the cause of the death of the plant is frequently obscure. The European vine (*Vitis vinifera*) is particularly subject to the attacks of the root form, while most American vines, although frequently carrying the leaf-galls, are more or less immune to root attacks.

The remedies used for this pest are the subterranean injection of bisulphide of carbon, and the submersion of the roots by inundating vineyards at certain seasons of the year by water. The standard preventive now employed all over the world is the use of American vines as stocks upon which to graft the susceptible European varieties. The immunity of the American vines seems to be due to the thicker bark covering of the roots, and to a greater natural vigor. The chief resistant varieties of American vines are the *Æstivalis*, the *Riparia*, and the *Labrusca*. Some American vines, however, as the Delaware, are almost as susceptible as the European vines. The varieties of the *Æstivalis* most used are the *Herbemont* and *Cunningham*; of the *Riparia*, the *Clinton*, *Taylor*, and *Solonis*. Consult Marlatt, *Principal Insect Enemies of the Grape* (Washington, 1898).

PHYLOGENY (from Gk. φύλον, *phylon*, tribe + -γένεα, *-gencia*, production, from γίγνεσθαι, *gignesthai*, to become). While ontogeny (q.v.) is a term expressing the development (embryology) of the individual, phylogeny means the development or genetic history of the members of the group or class as a whole. The conception of such a process did not arise until a multitude of facts had been accumulated during the study of the embryology of different animal types, the results being further checked and complemented by the facts of paleontology. The doctrine or theory of phylogeny, then, rests (1) upon a series of life-histories of animals, including their embryonic and post-embryonic stages of development; (2) upon what we know of the geological succession of animal forms; and (3) upon the theory of descent. Phylogeny is the equivalent of genealogy, and involves the idea of blood-relationship. A genealogical tree of a single human family, when carried out through many generations, is almost indefinitely branched and subdivided, the members or descendants from the earliest human pair affording an instance of divergent evolution. The ancestral tree or pedigree of any class of animals is a matter of theory, but the facts of affinity and homology are so numerous and natural that the theory is fairly well grounded. The phylogeny of any group is an expression of one's view of classification, and since in respect to many groups there is a divergence of opinion as to the systematic position of this or that member, so the views as to the pedigree of certain classes or general groups differ with different systematists. The success of the endeavor to work out a phylogeny of any group depends very largely on knowledge of the earlier fossil forms; yet each attempt leads to the more careful study of this or that characteristic, to tracing its growth, development, and final disappearance, or replacement by a later acquired feature, while the mental discipline resulting tends to render the work of the systematist more philosophical. See PALEONTOLOGY; EVOLUTION.

PHYLUM (Neo-Lat., from Gk. *φῶλον*, tribe). A term given by Haeckel to the primary divisions of the animal and vegetable kingdoms, which has now generally superseded the old terms 'sub-kingdom,' 'branch,' and 'type.' A phylum is a primary group either of animals or plants, all the members of which are supposed to be blood relations descended from one and the same stem, or ancestral, primitive form. The members inherit a mode of development, larval or nepionic stages of post-embryonic development, and adult structures which taken together make them to differ from those of other phyla. See CLASSIFICATION OF ANIMALS; PHYLOGENY.

PHYSA (Neo-Lat., from Gk. *φύσα*, pair of bellows, breath, bubble). A small pond-snail abounding in quiet fresh waters throughout the warmer parts of the world. It is closely allied to the *Limnaea*, but the whorls of the amber-



PHYSA.

colored shell revolve from right to left, instead of from left to right as is the rule among spiral shells. A very wide-spread species in the United States is *Physa heterostropha*.

PHYSA'LIA. See PORTUGUESE MAN-OF-WAR.

PHYS'ALIS (Neo-Lat., from Gk. *φυσάλλης*, *physallis*, plant with husks like bladders, bladder, from *φυσᾶν*, *physan*, to blow, from *φύσα*, *physa*, bellows, breath, bubble). A genus of annual and perennial herbs and shrubs of the natural order Solanaceae, remarkable for the calyx, which becomes large and inflated after flowering is over, and incloses the ripened berry. The species are natives of temperate and warm climates, and widely scattered over the world. The common winter cherry (*Physalis Alkekengi*) is a peren-



WINTER CHERRY (*Physalis Alkekengi*).

nial, native of Southern Europe and a great part of Asia, growing in vineyards and bushy places. The berries, which have a sweetish subacid taste, are often eaten. Among the American species, perhaps the following are best known: The downy winter or ground cherry or *Physalis pubescens*, *Physalis Peruviana*, *Physalis Philadelphiaica*, *Physalis angulata*. Some of these are cultivated in gardens to a small extent. Their fruits make good preserves.

PHYSICAL FORCE PARTY. In British politics, the term frequently applied to the party of Young Ireland which advocated physical force to procure the repeal of the union with Great Britain, after O'Connell in 1843 had countermanded the Clontarf meeting which had already been proclaimed by the military authorities, and on his arrest a week later had issued a manifesto advising the people not "to be tempted to break the peace, but to act peaceably, quietly, and legally."

PHYSICAL GEOGRAPHY. See GEOGRAPHY; PHYSIOGRAPHY.

PHYSICAL OPTICS. See LIGHT.

PHYSICAL SOCIETY, AMERICAN. A learned society organized for the advancement and diffusion of the knowledge of physics. It is one of the affiliated societies meeting with the American Association for the Advancement of Science. It also holds four meetings a year for the reading and discussion of papers upon the subject of physics.

PHYSICAL SOCIETY OF EDINBURGH, ROYAL. A learned organization of Scotland instituted in 1771 and incorporated by royal charter in 1788. Its object is the advancement of physical and natural science, including anthropology, paleontology, and meteorology. Discussions take place at monthly meetings held in the Philosophical Institution, Edinburgh, where the society possesses a large and valuable reference library. The membership is divided into three classes, ordinary fellows, corresponding fellows or non-resident members, and honorary fellows, the number of the last named being limited to fifteen. For over a century the society did not print its transactions, but now publishes an annual volume of *Proceedings*, 16 volumes being issued before 1903.

PHYSICAL SOCIETY OF LONDON, THE. A learned society founded in 1874, with its office and reference library in the Physical Laboratory of the South Kensington Museum, which has since transferred its official headquarters to Burlington House, London. Its object is to promote the advancement and diffusion of a knowledge of physics, and for that purpose to have papers read, new apparatus shown, and experiments tried at its meetings, which it holds fortnightly. The society publishes *Proceedings*, which are issued quarterly, and contain the more important papers read at the meetings, as well as the official records of the society.

PHYSICAL TRAINING (ML. *physicalis*, from Lat. *physicus*, from Gk. *φυσικός*, *physikos*, relating to nature, from *φύσις*, *physis*, nature, from *φύω*, *phycin*, to produce; connected with Lat. *fin*. I was, Skt. *bhā*, to become, OHG., Ger. *bin*, AS. *bēo*, I am, Eng. *be*). A term in its largest sense including (1) the training of muscles of the body for the acquiring as well as the preservation of health; (2) the employment of the mind as a relaxation from work; (3) the physical exercise of the body as a whole as a means to health and happiness. This does not include training aimed at the enlargement of the muscles alone, which often results in ill health, since most great athletes use up their vitality early in life and die in middle age; nor does it include, except indirectly, the cultivation of certain inherited weak parts of the body, since here again

direct medical advice is the only safe plan to follow.

First of all, certain laws may be laid down.

(1) The best exercise is always attained by playing a physical game, as contrasted with gymnasium apparatus, since the game not only stimulates all the functions of the body which otherwise are checked by the sedentary life of most human beings, but it also occupies the mind and thoughts, which, being thus turned away from the cares of life, are restored and refreshed. (2) Such games and exercise should be practiced in the open air, as contrasted with the same practiced within doors, since the air of outdoors is fresher, more stimulating, freer from dust and all substances which, taken into the lungs, do harm. (3) Such exercise should take place in the daytime, as contrasted with the night, since again sunlight has direct physical benefits that are lost when the sun has set. (4) Such exercise should be taken regularly at the same time every day, since a little regular work once a day is better than a large amount once a week, or irregularly.

A game played regularly out of doors in the daytime is therefore the ideal form of physical culture. Yet for a thousand reasons this best form may be impossible. Next best is a game outdoors at night, and after this a game indoors in the daytime. Again, if games are impossible, there are many forms of exercise which can be carried on in the daytime out of doors, and those should be chosen which require the greatest mental attention, in order to still rest the mind as much as possible. Next in order would come physical exercise, exclusive of games indoors, and in the daytime, and finally, least important of all, but still infinitely better than nothing, certain physical exercises indoors during the night time. It is manifest at the start that the great body of humanity is confined to this last, but properly carried out it is itself sufficient to preserve health and often to bring back health to those who have lost it.

OUTDOOR EXERCISE.

GAMES. The best exercise in the world is unquestionably obtained in the game of polo. The entire body is at work all the time; every muscle, every nerve, is used constantly; no part of the body is neglected. In addition to this no man can play the game and keep his mind on business; for not only must all the brain he has be devoted constantly to the play, but he has under him another personality—the pony—which requires constant watching and direction. When the game is over the physical body is thoroughly exercised, the mind has been employed to its unbounded relief, and the whole man, physically tired, is renovated as nothing else can renovate him. Polo, however, is very expensive and therefore confined to the few. Next in order of importance would come the game of football, which covers all that has been said of polo, except that there is no other intelligence than that of the individual himself to guide. As in polo, football exercises all parts of the body, occupies the mind, with its absorbing interest in organization, combination—team play as it is called—and with the constant attention required to develop the best results for the individual himself. Again, this game is limited to young men, both because of the time required to practice, and because middle

age too often makes the human machine incapable of enduring the physical strain.

Lacrosse comes next in importance. It has many of the good qualities of the two first-mentioned games, and it certainly occupies the mind. But a moment's reflection will show that in lacrosse the legs and leg muscles are developed at the expense of the chest, back, and some abdominal muscles. Lacrosse, however, is also confined to young men as a rule. Lawn tennis is more available for the average man; it has the advantage of being open to women and requires less training, less preparation, fewer players, and a shorter time each day. The expense is much less and its availability is therefore much greater. Again, however, one side of the body is exercised and therefore developed at the expense of the other, which is a serious objection, and also an element is wanting that plays an important part in the games already mentioned. In polo, football, lacrosse, and such games the element of personal contact is a most beneficial factor, even though it adds materially to the danger of the games. When injuries occur they are to be deplored, but they do not destroy the good there is in the games, and the moment the personal contact feature disappears, just so soon does the individual lose all the training in self-reliance, self-control, dignity, forbearance, and courage, which are as important in physical culture as are digestion, good circulation, and normal muscles. The loss of these in such games as lawn tennis is a serious drawback, and yet, following the principles already laid down, lawn tennis is infinitely better than nothing. The game can be played almost three-quarters of the year in the northern half of the United States and all the year round in the southern half. Baseball, considered from the point of view of physical culture, is not equal to any of the games already mentioned. It is first irregular in its muscular development; then, the very nature of the game requires sudden unnatural spurts of exercise with many periods of nerve-straining delays interspersed. Golf is now thoroughly established in this country, and becomes much more available as a means of physical training than any of the games so far mentioned because it is possible and feasible for many men and women. It has not the physical culture that other games have, because it involves no personal contact and because it is slight in its development of muscular tissue. And yet for the present purpose it is very valuable, since men and women of all ages from childhood to old age can play it, and it is available nearly the entire year over the whole of this country. Furthermore, if played regularly, it furnishes a training to the man who could not stand the more vigorous demands of other games.

Ice sports may be compared in merit with lacrosse. They offer the invaluable quality of being available at a time when most outdoor games are impossible on account of weather conditions, and as such they are the winter equivalent of other sports. The open air, the stimulant to circulation, the optimism engendered by the bracing qualities of the wintry out-of-doors are all valuable, but the limited time of their use confines them to the class of substitutes for other forms of physical culture.

In a general way, track sports and rowing cover the other forms of games for out-of-doors.

and both of these should come last in any physical culture category, since they have certain distinctly meretricious elements. Rowing in eight-oared shells, in four-oars, in pairs, in singles involves racing—competition—which, good in other sports, works for evil here. There can be no question that the strain of a boat race of any kind is injurious to the heart and the lungs. In contradistinction to other games, rowing is one continuous strain and effort from start to finish. There is no respite, no temporary delay where for an instant the organs of the body can snatch a little rest. And the same is in a measure true of running of all kinds, while the added disadvantages present in all track sports is manifest in the absence of any personal contact.

Walking, much abused as it is, will do much for health if properly conducted. But walking, as here considered, is different from the employment of 'shank's mare' to conduct a body from one point to another. In the first place, the walk should be taken at the same time each day. The individual should dress for it in light, loose clothing to give the freest possible play to all the muscles. The head should be held up, shoulders well back, chest thrust far forward, and the arms bent a little, while the hands grasp two banana-shaped pieces of cork like the handles of a bicycle. The stride must be long and swinging, starting from the shoulders and including the hips, so that the whole body swings forward on one side and then on the other as each step is taken, and the side and abdominal muscles are kept constantly at work. The pace should be fast and there should always be a definite point to be reached at a definite time. One would say that any human being, no matter how busy he might be, could find time for a half hour's walk during the day or night, and if he would prepare for it in suitable clothing and follow it out as an exercise, and not as a dilatory way of getting an opportunity to think over some problem of business, he would receive material benefit thereby. Its great disadvantage, however, is that even carrying out the stride, the position of the body and the regularity of the exercise, he still secures no rest for his mind, since the mere physical act of walking does not necessarily require constant mental attention. It only requires a problem of life that is sufficiently absorbing to divert the thoughts from surrounding objects or from attention to the operation of walking to the problem itself. In fact, walking often helps the mind to work. Riding has this advantage over walking, that it does give the mind relaxation, since the management of the horse requires a certain amount of attention. But, again, riding has not the amount of physical exercise in it that walking has when the latter is properly carried out, and riding is not as easily undertaken in view of the expense of keeping a horse. In the order of importance as regular outdoor forms of special development exercise come swimming, bicycling, running, shot-putting, hammer-throwing, and so on. They are all good—that is, better than nothing, better than the same things indoors—when properly and regularly carried out; but they all have distinct disadvantages. For example, bicycling develops the legs without doing much for arms or shoulders, and the bicyclist too often leans heavily upon the handle-bars, bending far forward, compressing his lungs, training his shoulders to become 'round,' and forgetting entirely the ab-

dominal muscles that need the regular gentle development of constant movement. Swimming, which is very general in its all-round use of the body, has its distinct advantages. But it can only be undertaken at limited times in the year, and then only by him who lives near the sea or some large body of water. It is questionable for the individual, since there are many people whose circulation is far from being benefited by bathing in the constant manner which is necessary if any physical good is to come of swimming as a regular exercise.

INDOOR EXERCISE.

Sparring is perhaps the best of indoor games. It is a most admirable exercise. It uses all the muscles of all parts of the body. The swaying of the trunk, the quick movements required in all the leg muscles, the extraordinary variety of movements about the arms, neck, back, and head, all keep the muscles in good condition and stimulate circulation, respiration, and good digestion. But in addition to this it can be seen that no one who is boxing can give much thought or attention to his business, or to anything but the game in hand. It needs only a straight blow on the nose to wake up the delinquent and make him give his undivided attention to the matter in hand. Here is a game that in many ways surpasses bicycling as a means to physical culture, while bicycling, on the other hand, has the one advantage of taking the individual out of doors. Wrestling has many of the good points of sparring and as such is a good form of physical culture. Yet here the teacher is more necessary than in most games. The danger of straining muscles and weakening tendons is very great, since a contest is of course necessary, and the desire for victory prevents one or the other of the combatants from giving up when a strain becomes the penalty for not doing so. Yet both these games develop all parts of the body equally and thoroughly.

Rackets, court tennis, and handball are all capital indoor games. They employ the mind and can be undertaken for half an hour a day regularly at a certain time. The disadvantage in them over such exercises as sparring is that they develop one side of the body to the detriment of the other. A right-handed player, for example, is constantly using his right arm with the racket, and thus develops his whole right side without bringing the left side into play to any great extent. Naturally the circulation, the respiration, and the general relaxation of both mind and body go on, but the muscular development needs some specific exercise for the left side after the game is over, if the normal of physical culture is to be attained.

Fencing also has the same one-sided development, yet it adds the ease and grace of movement which make it one of the most valuable means of physical culture for women that can be used under cover of a roof. Like single stick and the many forms of offense and defense with a weapon, it really has qualities that few games can boast. The agility, quickness, grace, and *finesse* that are required have to do with physical culture in its highest sense.

SPECIAL DEVELOPMENT EXERCISES.

To go thoroughly into this large branch of physical culture would be impossible here. It is possible, however, to suggest lines of work. The pulley-weights and dumb-bells are so monoto-

nous that they do not occupy the mind, and they therefore lose a part of their force as means toward physical culture. The punching bag, on the other hand, is really a game which is played with an inanimate but very vigorous adversary. Again, however, it is necessary to add, in order to preserve a proper sense of proportion, that this is not equal to a game out of doors in the daytime and never will be; but then, on the other hand, it is so much better than nothing that it often means in so many words the difference between health and sickness. In like manner might be catalogued the apparatus of the gymnasium in the order of their desirability, such as rowing machines, parallel bars, pulley-weights, and so on. They all have their uses; they can all be set up in any private house, and they are all of service in maintaining health when nothing better can be had. Their use is precisely and only this: Exercise must be taken regularly every day in some form to stimulate circulation and respiration; exercise must be given the mind along other lines than those followed in daily life. Either the home or the club gymnasium will be better than nothing, as a little regular exercise day by day of whatever kind is better than none at all. One other method offers itself for general consideration and that, too, is better than nothing. Yet it requires what is found only here and there in mankind—the capacity for absolute regularity day by day, every day of every year. There seems to be something in the human make-up that militates against regularity, and in the least beneficial and yet easiest of forms of physical culture regularity is the whole story. Forms of exercise without the use of apparatus are best suggested by the United States Army *setting-up exercises*. They include the *Swedish system*, the *Delsarte system*, and all the other innumerable forms of setting-up exercises which have been invented. In considering these, two very different points of view must be considered. (1) If a portion of the body is weaker than all other portions—for example, if a broken leg, now healed, needs special attention to bring the long unused muscles up to standard—these forms of exercise ought to be taken under the advice of a physical culture instructor, since a thorough knowledge of anatomy is needed to point out just what exercises are most efficacious. (2) If the maintenance of general health is desired, then no teacher or instructor is at all necessary. It only needs to consider the muscles of the body. For example, before bathing, lie on the floor on your back and (1) rise to a sitting position twenty times; (2) raise the legs to a perpendicular position twenty times; (3) turn over, and, touching only the toes and hands to the floor, thrust the body upward by straightening the arms twenty times; (4) stand up, and, keeping the legs straight, bend forward and touch the finger-tips to the floor twenty times; (5) rise on the toes twenty times; (6) keeping the body straight and upright, bend the knees and sink down toward the floor twenty times, rising again by straightening the legs; (7) take hold with one hand of the end of a door and grasp with the other the door frame when the door itself has been opened about one-quarter of a quadrant; standing thus, allow the body to fall forward so that the chest passes through the opening and the shoulders are thrust far back until the shoulder-blades touch; do this

twenty times; (8) place the hands on the hips, stand straight, and then bend forward as far as possible twenty times, backward twenty times, to the right side twenty times, to the left twenty times; (9) standing straight, go through—twenty times each—the motions of raising the arms at full length above the head, backward, forward, and down. When a child or youth or a young girl is in question the advice of an expert is, of course, almost necessary.

GENERAL CONSIDERATIONS.

In conclusion it is necessary to suggest a few general rules which apply to all forms of exercise for physical training. Food is the principle question. Eat three times a day and always at the same hours. Eat simple meats and vegetables, a light breakfast, a moderately light lunch or mid-day meal, and a moderately heavy evening meal. Never eat at any other time. By simple foods is meant meat and vegetables cooked simply without sauces and extra substances which only confuse the digestive organs when they begin their wonderful work of turning food into blood and tissue. Drink plenty of water between meals, but little or none at meals. Drink alcoholic drinks or not as you like, or as your belief dictates; but remember that temperance is neither too much nor too little, and the actual amount per day which is really temperate must in each case be decided by the individual. There have been men who drank temperately all their lives and lived to be ninety and the quantity per day which they consumed would have killed another man in a year. Temperance is the only rule, and as what is temperate for one is intemperate for another, each must decide for himself. Clothing has much to do with physical culture. In parts of the United States the climatic changes are great, but it should be remembered that our houses are of about the same temperature all the year round. Therefore the underclothing should be of the same thickness all the year round and the outer clothing should fit the outer climate of the day. But more important perhaps than this is the rule that underclothes should be changed once every day. After the regular occupation of the day, just before dinner or supper, say at six or seven o'clock, every man and woman should put on a clean set of underclothing. The physical benefit is immense, but it does not compare with the mental rest and recreation that will result from this simple aid of physical culture. Bathing is another necessity. Each man and woman immediately after rising and taking fifteen minutes of exercise, should take a shower bath of first warm and then cold water, or if a shower is impossible, an ordinary bath in a tub. Never neglect the final cold water. It closes the pores of the skin and avoids the danger of taking cold. The feet are perhaps as important as anything. Napoleon said that an army with good shoes could do anything he asked of it. So might a man say that his body will do anything he asks of it if his feet are well cared for. Buy good shoes, and take care that they are not too large, and are well made. Keep them carefully and change them at least once a day in the early evening. Have several pairs so that the shoes can have a rest every other day. Finally *regularity* in sleeping, eating, dressing, and exercising is the important detail. Such are the extraordinary powers of the human body that it responds to regularity, to habit, as to nothing else. It be-

comes accustomed to certain things at certain times and it will serve you better than you serve it, if you will but treat it temperately, regularly, and generously. If you sleep regularly, eat regularly, dress regularly, exercise regularly, you can put your physical and mental body to such strain in the way of work as would kill the irregular man in a few months—and that is after all the substance of all physical culture.

BIBLIOGRAPHY. Frobisher, *The Blood and Breath: a System of Exercise for the Lungs and Limbs* (New York, 1876); Brendiecke, *Grundriss zur Geschichte der Leibesübungen* (Cöthen, 1882); Hoole, *Science and Art of Training* (London, 1888); La Grange, *The Physiology of Bodily Exercise* (ib., 1889); Schreber, *Aerztliche Gymnastik* (23d ed., Leipzig, 1889); Jenkin, *Gymnastics* (New York, 1890); Lewis, *Home Gymnastics* (ib., 1892); Bissell, *Physical Development and Exercises for Women* (ib., 1891); Stebbins, *Dynamic Breathing and Harmonic Gymnastics* (ib., 1893); Treves, *Physical Education* (London, 1893); Sandow, *Physical Training in American Colleges and Universities* (Washington, 1896); Gissen, *Rational Home Gymnastics for the 'Well' and the 'Sick'* (Boston, 1898); Wide, *Handbook of Medical Gymnastics* (London, 1899); Hough, *A Review of Swedish Gymnastics* (Boston, 1899); Blaikie, *How to Get Strong and How to Stay So* (new ed., New York, 1898); Demeny, *Les bases scientifiques de l'éducation physique* (Paris, 1902); Leonard, "A Select Bibliography of the History of Physical Training," in *American Physical Education Review*, vol. vii. (Brooklyn, 1902).

PHYSICIAN (OF. *physicien*, *fisicien*, from Lat. *physicus*, from Gk. *φυσικός*, *physikos*, natural philosopher, physician, from *φύσις*, *physis*, nature, from *φύειν*, *phyein*, to produce). In law, one who has complied with all State regulations in regard to the study of medicine, and who may lawfully practice medicine. Most States require a medical student to pass a State examination satisfactorily, and thereupon grant a license to practice to successful candidates. Such provisions are constitutional. A person who holds himself out as a physician is considered to represent that he has the ordinary skill of one of his profession. Lack of skill or negligence on the part of a physician, resulting in injury to a patient, are called malpractice (q.v.). It is generally held to be optional with a physician as to whether or not he will attend a person calling him.

The relation of a physician and patient is a confidential one, and the former is bound not to divulge any of the secrets confided to him by the patient, even on the witness stand. The statutes of each State in regard to the practice of medicine should be consulted. See MALPRACTICE; EVIDENCE.

PHYSICK, fiz'ik. PHILIP SYNG (1768-1837). An American physician, born in Philadelphia, educated at the Friends' Academy. In 1788 he went to Europe, studied with John Hunter, and was admitted to Saint George's Hospital in 1790. In the same year he received a diploma from the Royal College of Surgeons, and assisted Dr. Hunter for one year. Returning to Philadelphia in 1793, he was appointed physician to the yellow-fever hospital at Bush Hill; in

1794 surgeon to the Pennsylvania Hospital; and the following year, on the recurrence of the yellow-fever epidemic, he was placed once more in charge of the Bush Hill Hospital. In 1801-16 he was surgeon to the Philadelphia Almshouse Infirmary; in 1805 professor of surgery in the University of Pennsylvania; in 1819 called to the chair of anatomy, which he filled until 1831; in 1821 consulting surgeon to the institution for the blind; in 1824 president of the Philadelphia Medical Society. In 1825 he became a member of the Royal Academy of Medicine in France, and in 1836 honorable fellow of the Royal Medical and Chirurgurgical Society of London. He was the author of *Deapoplexia* (1792).

PHYSIC-NUT (*Jatropha*). A genus of about 70 species of tropical shrubs and trees of the natural order Euphorbiaceæ, characterized by alternate, stalked, angled, or lobed leaves, corymbs of flowers on long stalks, and the acrid oil of their seeds. The common physic-nut (*Jatropha Curcas*) of the East Indies, introduced into the West Indies, southern Florida, and other warm parts of the world, is a small, much branched, rapidly growing tree or bush with a milky juice. It is used for fences in many tropical countries. The expressed oil, commonly called jatropa oil, is used for illuminating purposes, and has been used in medicine. The French or Spanish physic-nut (*Jatropha multifida*), an American shrub with many-lobed leaves, yields an acrid oil, called oil of pinhoen. To this



PHYSIC-NUT.

genus belongs the pinocillo (*Jatropha lobata*) of Peru, the roasted seed of which is an agreeably flavored food. Incisions in the stem of this tree allow the escape of a clear bright powerfully caustic liquid which after some time becomes black and horny, but retains this property for years. Physic-nettle (*Jatropha urens*), a native of the Southern United States, has similar qualities.

PHYSICS (from Gk. *φυσικά*, *physika*, nom. pl. neu. of *φυσικός*, *physikos*, relating to nature). Physics is one of the successors of the study formerly called natural philosophy, or the science of the phenomena of nature as revealed to us by our senses and as interpreted and systematized

by our intellects. The name itself is the plural of the word 'physic,' which was used as early as the fourteenth century to mean natural philosophy, but which afterwards became restricted to mean the science of medicine, and finally to mean a medicine or drug itself. While physics in its modern sense comes closely in contact with chemistry, astronomy, and many other sciences, it is impossible to state in words its exact scope. It may be said,—however, in general that the study of physics includes the phenomena of acoustics, of heat, of light, of electricity and magnetism, and of mechanics to a certain extent. Within recent years many subdivisions have been made both in physics as a general study and also in its various parts. The subjects pertaining to the nature of solutions are now included in physical chemistry; the spectroscopic examination of the sun, stars, etc., together with the related theories, forms the science of astrophysics; the observations and theories of earthquakes, heat conduction on a large scale, volcanoes, etc., are now studied under the name of geological physics. Practical applications have been made of many observations in physics, and there are schools of engineering devoted to the study of these matters. Among the branches of engineering are mechanical, hydraulic, steam, and electrical.

The fundamental idea of physics is that we learn by means of our senses certain facts in regard to natural phenomena, which are independent of time and space. These last two concepts, namely those of time and space, are considered as intuitive. The name matter is given provisionally to whatever is the cause of our sensations; but it is *defined*, naturally, in terms of its properties. There is not necessarily involved any assumption as to the reality of matter; rather, there are found certain mathematical expressions, certain differential equations, which express our knowledge of nature, but which we interpret in such language and with such ideas as correspond to our mental pictures. Associated with this idea there are two great divisions of physical methods; one may be called the laboratory method, the other the method of mathematical physics. (See LABORATORY.) The laboratory method consists, first, in making a series of observations and amassing information in regard to phenomena, but further in seeking to obtain a generalization with which the observed phenomena may be in accord. The object and scope of mathematical physics is well expressed by Professor Poincaré in his introduction to the *Reports of the International Congress of Physics* (Paris, 1900). The fundamental method is to devise certain postulates and to state such axioms as will lead by rigid mathematical processes to formulæ which may be compared with observed phenomena. Thus by means of the methods of logic conclusions may be drawn connecting many phenomena which on their face are unrelated.

HISTORY OF PHYSICS. It is remarkable to note how few facts other than obvious ones were known to the ancients in regard to nature, and also to find how few instruments were available for what may be called scientific observation. Beyond a doubt simple forms of instruments were known for the measurement of time, such as water-clocks, sun-dials, etc., and the Chinese at least had a knowledge of some of the simple

properties of a magnet. The law of the reflection of light was generally known and lenses were in use for various purposes. The law of the lever was known to Archimedes, as were also certain of the laws of hydrostatics. There was a knowledge of harmony in music more or less incomplete. A few observations are also noted in regard to electric attraction and the facts of meteorology.

Up to the Middle Ages there are few if any facts to be recorded in regard to the growth of natural philosophy, because the Romans were content with the knowledge left them by the Greeks, and the intellectual activity of the Arabs seemed to be concentrated, as far as physics is concerned, in the person of Al-Hazen, who was interested largely in optics. There was a revival of interest in nature during the thirteenth century, as shown by the work of Roger Bacon and Peregrinus. In the sixteenth century Copernicus lived, and he was followed by Galileo, Kepler, Stevin, Gilbert, and others.

The effect of the life and work of Galileo in Italy and of Gilbert in England cannot be overestimated. There was a universal revival of intellectual activity and a universal interest in the study of natural phenomena. Each of these two men emphasized the need of experimental study and the utility of logic apart from observation. Galileo's greatest contribution to physics was the statement of the principles of mechanics. He was succeeded by pupils whose interest and influence was so great that they led to the establishment of academies and learned societies throughout Europe. With the appearance, however, of Huygens's *Horologium Oscillatorium* (1673) and Newton's *Principia* (1687) physics came to the front as the most important of the sciences. The methods used by these two men, both in their observations and in their statement of laws of nature, have served as the models for succeeding generations. They were followed by two schools, one interested in the mathematical development of mechanics, the other interested in the purely experimental side of the subject, whose legitimate predecessors were Torricelli, Pascal, Boyle, and Guericke.

MODERN TIMES. The development of our present knowledge of physics is more fully described under the separate headings of its various subjects; namely, acoustics, heat, light, electricity, and magnetism. It should be sufficient in this place to refer to a few names in connection with each of the subjects. Our accepted ideas in regard to the nature of heat and heat effects are due to the researches and theories of Black, Rumford, Davy, Carnot, Clausius, and Joule. In light we owe most to Young, Fresnel, Fraunhofer, Kirchhoff, and Stokes. In the subjects of electricity and magnetism a long list of names should be mentioned, but among these those of Volta, Cavendish, Ampère, Oersted, Faraday, Henry, Gauss, Weber, Maxwell, and Hertz are easily the most notable. To Helmholtz alone, it is only fair to say, all of our accepted ideas of the theory of sound are due. The names of no living men have been included in the above summary, but any such list would be incomplete without the addition of the names of Kelvin, Rayleigh, Lorenz, J. J. Thomson, and Röntgen, who have contributed so much to the most recent ideas in regard to the fundamental concepts of nature.

Previous to the nineteenth century there were

three great principles of physics which were firmly established and which deserve to be called laws of nature. These were the law of gravitation, the principle of the conservation of matter, and that of the conservation of momentum. Some doubts have recently arisen as to whether the weight of a definite quantity of matter remains unchanged as its state is altered, but there seems to be no reason for doubting the principle of the conservation of matter itself. The most notable fact in the history of physics during the nineteenth century was the development of the principle of the conservation of energy and its application to all fields of science. This great development was due largely to the efforts of J. R. Mayer, Helmholtz, and Joule. Other great principles, such as the second law of thermodynamics, were expressed in words, and will be found discussed in other places. The kinetic theory of matter was also elaborated and established on a firm basis.

Beginning with the discovery of the X rays by Röntgen in 1895 and of the radiation from uranium by H. Becquerel in 1896, there has been a progress in physics and in our knowledge of the properties of matter which has been one of the most striking facts in the whole history of science. The point of departure in our new knowledge comes from the epoch-making discovery by J. J. Thomson that in their passage through air both the X rays and those from uranium make the air a conductor for electric currents. This discovery led at once to investigations by observers the world over in regard to the nature of the ionization of air and of the radiations which produce it. It was soon found that many substances other than uranium had this same power of emitting radiations which would ionize a gas; such were thorium, and the newly discovered elements, radium and polonium. These substances are said to be 'radio-active;' and it was observed that nearly every body in nature was 'active' to a greater or less degree. The properties of the radiations themselves were carefully studied and analyzed, and their properties other than that of ionization were investigated. There are always present in the radiations from such bodies both positively and negatively charged particles of matter whose velocities vary within wide limits. When the velocities of the negatively charged particles as produced in various ways were studied, a most remarkable fact was observed. Attention had been called many years ago by J. J. Thomson to the fact that if a charged sphere were moving rapidly it would have an effective inertia greater than that which would be observed in case it were uncharged. In other words, an electrical charge in motion has an apparent mass quite apart from that of the matter carrying it; and formulas have been deduced by Thomson, Heaviside, and Abraham connecting this mass of the charge with the quantity of charge, its velocity, and its acceleration. It was observed in the case of the negatively charged radiations above referred to that their apparent mass was exactly that which would be calculated from the formulæ on the assumption that the mass was due entirely to the moving charge. This discovery renewed at once the theories of matter which had been advanced before, in accordance with which the inertia of matter is a property due to the motion of an electric charge. The name 'electron' has

been given these charges when considered apart from matter, and a most interesting discussion of their properties and of the theories of matter based upon these is given in a series of papers by Sir Oliver Lodge in the *Electrician* (London) during the winter of 1902-03.

One of the great contributions of the nineteenth century to physics was the development of the idea of the luminiferous ether. The necessity of a medium for the transmission of the waves which produce the sensation of light had been recognized for many years and was clearly stated by Fresnel and others. Faraday had also come to the conclusion that a medium was necessary for the transmission, or rather existence, of electric and magnetic forces, and had suggested that possibly this medium might be identical with the one that carried 'light waves.' Maxwell showed by theoretical considerations that the velocity with which an electromagnetic disturbance would be propagated in the medium referred to by Faraday must be numerically equal to the so-called 'ratio of the electrical units,' and further showed from experimental evidence that this was equal to the number expressing the velocity of light. He also proved by a mathematical investigation that the electromagnetic waves were identical in all respects with those with which we are familiar in the phenomena of light, and thus established the fact that only one medium is necessary for the explanation of the phenomena of light, electricity, and magnetism. The connection between this ether and ordinary matter has been investigated by many observers, as described in the article on ABERRATION. The accepted theory at the present time is that the ether does not move as material bodies are carried through it; and this, in connection with the ideas of electrons, has been elaborated by Lorentz into a theory which is able to explain in the most satisfactory manner the phenomena of dispersion, metallic reflection, and stellar aberration. There are many difficulties, however, which still remain to be investigated in regard to the properties of the ether, in spite of the great progress marking the beginning of the twentieth century. If the inertia of matter is to be regarded as capable of explanation, as indicated above, from the standpoint of electricity, there still remain two great problems for solution. What is the nature of an electric charge? and what is the cause of gravitation? The development of physics at the present time is tending toward investigations of these two questions.

BIBLIOGRAPHY. *General Works:* Winkelmann, *Handbuch der Physik* (Breslau, 1891-96); Daniell, *Principles of Physics* (London and New York, 1894); Chwolson, *Lehrbuch der Physik* (Brunswick, 1902 et seq.); Müller-Pouillet, *Lehrbuch der Physik und Meteorologie* (9th ed., Brunswick, 1902 et seq.); Ames, *Theory of Physics* (New York, 1897); Jamin, *Cours de physique* (Paris, 1896); Poynting and Thomson, *Text-Book of Physics* (London, 1899); Watson, *Text-Book of Physics* (ib., 1896).

Periodicals: *Annalen der Physik* (Leipzig, 1877 et seq.); London, Edinburgh, and Dublin *Philosophical Magazine* (London, 1832 et seq.); *Journal de physique* (Paris, 1872 et seq.); *Physikalische Zeitschrift* (Leipzig, 1899 et seq.); *Zeitschrift für Instrumentenkunde* (Berlin, 1881 et seq.); *Astrophysical Journal* (Chicago, 1895 et seq.); *Physical Review* (New

York, 1893 et seq.) ; *Zeitschrift für physikalische Chemie* (Leipzig, 1887 et seq.) ; *American Journal of Science* (New Haven, 1818 et seq.).

History: Cajori, *A History of Physics* (New York, 1899) ; Whewell, *History of the Inductive Sciences* (3d ed., London, 1857).

PHYSIOCRATS (from Gk. φύσις, *physis*, nature + κρατείν, *kratein*, to rule). A French school of political and economic philosophers, known to their own generation as *Les Economistes*, who wrote against the antiquated methods of the State in encouraging industry (see COLBERT), and in favor of agriculture, industrial freedom and natural liberty. The school flourished from 1756 to 1776. The founder and leader of the school was François Quesnay (q.v.), a noted surgeon, metaphysician, and, after 1749, physician to Madame de Pompadour. With Quesnay is often associated in the founding of the sect the name of Jacques Claude Marie Vincent de Gournay (q.v.), who did not, however, endorse the extreme views of the school respecting the paramount economic importance of agriculture. The most earnest disciples and indefatigable propagators of the Physiocratic doctrine were the elder Mirabeau, Mercier de la Rivière (1720-94), and Dupont de Nemours (q.v.), editor of the works of Quesnay and Turgot and of the Physiocratic journals. Among the statesmen, rulers, and princes of the time who accepted the main doctrines of the Physiocrats were first and most important, Turgot (q.v.), Minister of Finance under Louis XVI.; Charles Frederick, Margrave of Baden; Gustavus III. of Sweden; Leopold II., Grand Duke of Tuscany, and afterwards German Emperor; Stanislas of Poland; the Emperor Joseph II.; and Charles III. of Spain. With some of them the acceptance was little more than half-hearted, and the only monarch who made an earnest attempt to carry out their programme of reform was Charles Frederick of Baden. He tried to apply their principles in three villages, but finally abandoned the attempt.

The general doctrine of the Physiocrats was an extension to the economic sphere of the theory of natural liberty which Locke, Hutcheson, Shaftesbury, and others had applied to the sphere of politics and religion; but, unlike the British philosophers, the Physiocrats denied that the natural rights of the individual could be abridged by any social contract. Every man, they held, has a right to the free exercise of his faculties, so long as he does not infringe the like liberty of others, and this involves the further right to the undisturbed enjoyment of the property which results from the exercise of his faculties in productive labor. It follows from these rights that the sole function of government is to protect life and property and to administer justice, and no interference by the government with commerce and industry is permissible—in the classic phrase of the school, *laissez faire, laissez passer* (q.v.)—but within the restricted sphere noted above the Physiocrats advocated a strong monarchical government, a “legal despotism, tempered only by an enlightened public opinion.”

The peculiar economic views of the Physiocrats seem to rest upon a confusion of wealth with material objects, leading to the conclusions that agriculture alone yields a surplus product—*produit net*—above the expenses of production; while manufactures and commerce, which merely

change the form or position of raw materials, are barren. As agriculture is the only form of production yielding a value in excess of the cost of production, they advocated that taxes should be levied upon rent—which expresses or measures the ‘net product’—so as to avoid the expense and friction attendant upon the shifting of the tax to this source when placed originally upon other objects. They thus gave to political economy the fruitful theories of surplus value and the single tax—*impôt unique*. (See POLITICAL ECONOMY.) The scientific virtues and defects of the Physiocrats may be traced to one and the same cause, the belief in a beneficent and absolute natural law governing the moral and social universe with the same rigidity and precision as the material universe is governed by physical law. This belief made them at once narrow but precise, systematic but unmindful of the difference between physical and psychical phenomena, careful in definition, distinction, and classification, but careless of the effects of customs, law, and the diversity of human motives. They have exercised a deep and lasting influence upon political economy, and it is now usually admitted that Quesnay, rather than Adam Smith, is to be regarded as the ‘father of political economy.’ Opinions differ regarding their influence upon the practical affairs of the day. They undoubtedly stimulated the study of agriculture, suggested several important agricultural improvements, called attention to the oppression of the peasantry and elevated their importance in the eyes of the nation, and secured a freer intercourse of trade—particularly in breadstuffs—within the French kingdom. In the early years of the French Revolution their doctrines exercised an appreciable effect upon the Constituent Assembly, but their most striking practical influence was exercised through Turgot (q.v.), who, while not a professed Physiocrat, made many earnest attempts, both as intendant of Limoges (1761-74) and as Comptroller-General of Finance (1774-76), to abolish the *corvées* and the guilds, to introduce free trade in corn, to reduce taxation, and to accomplish the general reforms which the Physiocrats demanded.

Among the most important publications of the Physiocrats are Quesnay’s articles on *Fermiers* and *Grains*, published in the *Encyclopédie* of Diderot and D’Alembert; *Le droit naturel*, published with other of his writings in the *Physiocratie* (which gave the school its name), edited by Dupont de Nemours, and his *Tableau économique*, 1758, “the Bible of the Physiocrats,” reprinted for the British Economic Association, London, 1894; Mirabeau’s *Théorie de l’impôt*, 1760, and *Philosophie rurale*, 1763; Dupont de Nemours’ *De l’origine et de progrès d’une science nouvelle*, 1767, published in his *Physiocratie*; Mercier de la Rivière’s *L’Order naturel et essentiel des sociétés politiques*, 1767; and Turgot’s *Réflexions sur la formation et la distribution des richesses*, 1770.

BIBLIOGRAPHY. Oncken, *Euvres de Quesnay* (Frankfort, 1888); Hasbach, *Die allgemeinen philosophischen Grundlagen der von François Quesnay und Adam Smith begründeten politischen Oekonomie* (Leipzig, 1890); Higgs, *The Physiocrats* (London, 1897).

PHYSIOGNOMY (OF. *physiognomic*, *phisionomic*, Fr. *physionomic*, from Gk. φυσιογνωμία,

physiognōmia, φνσιωγνωμία, *physiognōmonia*, art of judging by the features, from φνσιωγνώμων, *physiognōmōn*, one who judges by the features, from φύσις, *physis*, nature + γνώμων, *gnōmōn*, judge, from γινώσκω, *ginōskō*, to know; ultimately connected with Eng. *know*). In general, the form and expression of the visage or face, especially when regarded as indicative of character; specifically, an art or system of reading character from the face. This system was framed by Lavater, and is related to that of phrenology as formulated by Gall and Spurzheim; it was extended and expanded in America chiefly by S. R. Wells in connection with O. S. Fowler, L. N. Fowler, and others. In its application the system involved temperament as determined from complexion, etc.; the general aspect of head and face, sometimes in comparison with those of animals whose traits the individuals were considered to imitate; the form, size, and prominence of particular features, etc. The chief bases of the system were assumed (1) localizations of functions in the brain, and (2) corresponding localizations in the external features. Later researches in cerebral and general anatomy and physiology have failed to establish most of the assumed localizations and correspondences, while modern students commonly regard facial forms and features rather as hereditary ethnic characters than indices of individual disposition; so that the current art may be defined as character-reading from facial expression. A good many modern students, among whom Cesare Lombroso may be regarded as the leader, distinguish between normal and abnormal types of physiognomy, and view the latter as indices of either degeneracy or reversion to lower ancestral types; and some writers have sought to combine certain classes of abnormalities in a 'criminal type' for the guidance of students, jurists, and statesmen. The recognized abnormalities include certain malformations of face and head, asymmetry of features sometimes analogous to that accompanying epilepsy or paralysis, excess or deficiency of hair and beard, unusual pigmentation, and various stigmata, either congenital or of later development. The coördination of these abnormalities with conduct forms a considerable part of the foundation for criminology (q.v.) as defined by Lombroso. The general form and expression of the visage are among the ethnic traits recognized in defining races and peoples. The facial angle, i.e. the degree of prognathism, is among the most useful measures both in comparative anatomy and in ethnology; the shape of the jaw, the conformation of the cheek-bones, the position of the ocular orbits, the number and character of the teeth, and the nature of the dermal appendages (hair, beard, brows, etc.) are also of primary importance as ethnic characters; while the superior expressiveness of the features of more advanced peoples is among the characteristics noted by the ethnologist.

PHYSIOGRAPHY (from Gk. φύσις, *physis*, nature + -γραφία, *-graphia*, description, from γράφω, *graphō*, to write). There is much difference in the usage of the term physiography. It is employed as a synonym for the older term physical geography; as a term to include a general introduction to science; for the study of the physical environment of life; and for the study of land forms alone, that is as a synonym for the

recently proposed name geomorphology. In the United States the term physiography is rapidly coming to replace the older term physical geography, at the same time that a more scientific basis is being introduced into physical geography. In this sense, physiography is concerned with the study of air, ocean, and land, with the object of understanding their present condition and influence on life. To understand present conditions leads back into meteorology, oceanography, and geology; to appreciate their influence on life presupposes knowledge of history and biology at least. It is no uncommon belief that physiography is too complex, and drawing upon too many other subjects to have distinct boundaries, and hence to deserve the name science. It is true that there is no general agreement as to the exact boundaries; but this is by no means proof that physiography can have no boundary. Some one has said that geology is a study of the past. That is to say, a geologist, to appreciate his subject fully, must have knowledge as a physiographer; and a physiographer must know the past that he may use geology as a tool in his attempt to understand the present.

ASTRONOMICAL ASPECTS. The study of physiography deals essentially with the earth—its spherical form, its envelopes of air and water, its cold crust and heated interior, and their influence on life. Yet no thorough appreciation of these conditions and influences is possible without a general knowledge of the astronomical relations of the earth. The earth as a sphere, and as a member of the solar system in which it so moves as to give day and night and the seasons, are facts of fundamental importance to an understanding of changes in the earth; and the spherical form of the earth, and the presence of heat among the members of the solar system, furnish adequate reason for a consideration of the hypotheses for the origin of the earth. This does not mean that the subject encroaches on astronomy; it is dealing with the earth, but it inquires of astronomy the reasons for terrestrial phenomena of vital importance, and applies these to an interpretation of the phenomena in their relation to life.

THE AIR. The influence of the air on life is universal. Its oxygen and carbon dioxide; the influence of its pressure; the effects of its density, for example, on the flight of birds; its water vapor; its winds and their effects—these are among the many reasons why a study of the air properly forms a part of physiography. The science of meteorology furnishes the explanations, and with these the physiographer needs to be familiar. In order that he may understand the distribution of life he should know why there is vapor, why winds blow as they do, why there are rainy and desert regions, and why there are storms. The branch of physiography that deals especially with this phase of the subject is climatology. If the climatologist studies only the causes of climate he becomes a meteorologist; but if his especial concern is the understanding of the laws of climate with reference to their influence on life, he is a physiographer. The study of the air has a bearing on other phases of physiography. Waves and ocean currents depend on air conditions, and to understand them calls for a knowledge of air movements. Rain, river floods, the difference between the topography of arid and moist lands, and the existence of glaciers, are among the fea-

tures of the land that depend upon a knowledge of the air for their proper appreciation. Each of these reacts on life. Thus, along several lines, it is evident that there is a phase of air study, calling for an appreciation of the science of meteorology, it is true, but with its main object the investigation of the influence of the air on the environment of plant, animal, and human life.

THE OCEAN. The temperature and movements of the ocean, dependent upon sun's heat and air movements; the tides, dependent on the attraction of the sun and moon; the composition of the ocean water, its depth, and the characteristics of the ocean bottom are among the important physiographic features of the ocean. Each of these has an influence on life. The ocean supplies vapor to the air; its vast expanse and its currents influence the temperature of the air and aid in those movements of the air by which the temperature and rainfall of the lands are profoundly affected. Life in the ocean as influenced by its environment; the effect of ocean influence on the life of the lands; the ocean as a barrier to the spread of life; and its importance to man in commerce and many other ways are among the subjects with which a physiographic study of the ocean is concerned. The oceans and the lands are profoundly interrelated. The waste of the land is carried to the sea by rain and rivers; and the oceanic agents are attacking the land along its border, forming many varied coast features. Changes in level of the crust lower parts of the land beneath the sea, and raise sea bottoms to form dry land. No study of the lands can promise the best results without a knowledge and appreciation of the conditions of the coast line and sea bottom. From this it is evident that the physiographic study of the ocean is broadly interrelated with the study of the land and air. The science of the study of the ocean is called oceanography; and, as in the case of meteorology, while the physiographer must understand the principles, his concern is far less with the science of oceanography than with the application of its principles to an understanding of their influence on life.

THE LANDS. There is a conflict of forces at the present time operating to modify the forms of the lands which themselves so greatly influence life. On the one hand contraction of the interior of the earth is causing changes in the level of the crust as a result of which continents are raised and ocean bottoms depressed, while mountain chains, volcanoes, plateaus, and plains are being made. On the other hand opposing forces are at work on the land removing the rocks that lie above the sea level and dragging the fragments into the sea. The weather disintegrates the rocks, the rains, rivers, and winds remove the fragments. Glaciers occasionally aid in this erosion, and the seacoast is the seat of further important work of this kind. The result of the opposing forces of elevation and destruction has been to produce a very complex land surface, and it is one of the most important provinces of physiography to understand this land surface and to point out its effect on life. For this phase of physiography the name geomorphology has been proposed. It is intimately related to geology and makes use of geological principles. It is by some considered as a branch of geology; that is, the geology of the present.

Many of the principles relating to the physiography of the lands are stated under other topics.

(See RIVER; LAKE; MOUNTAIN, etc.) In this place only the scope of the subject will be indicated. The simplest land form is the plain (q.v.), the most extensive and perfect plains being on the sea bottom. They may be classified as constructional and destructional, the former being represented by elevated sea-bottom plains, lake-bottom plains, delta plains, flood-plains, etc.; the latter by plains of marine denudation, plains caused by lateral erosion of rivers, etc. In the beginning their surfaces are level, they permit the ready spread of animals and plants, and, if the climate favors, they are usually well suited to occupation by man. If newly formed, or young, the surface may be so level that water stands on it as lakes or swamps; but with increasing age the surface is drained, streams cut valleys, the flat-topped divides are narrowed, and the lakes and swamps are destroyed. In the development of these stream valleys, if the plain stands high enough above sea level, or base level, the rapid cutting along the channels permits the development of deep, steep-sided valleys. In these young valleys the vigorously working streams flow with rapid slope, and with occasional falls where hard layers are encountered. If the land is high above base level, that is, if it is a plateau, the young streams may so trench the land that travel across country is prohibited by the deep cañons. In such cases the interstream areas only are habitable and are chosen for roads and railways. With time the valleys broaden, the slopes become more gentle, and both the valley bottoms and sides invite settlement. Such a land surface is mature, and is well illustrated by the Mississippi Valley. There are few if any falls, the rivers are navigable, and they are bordered by flood plains—waste from the land along the course which the river is unable to bear to the sea over its gentle lower slope.

The Alps as a barrier to the spread of life, and as a refuge from invasion, stand as rugged mountains reaching above the snow line. Their ruggedness is due to their youth and to the fact that denudation, working high above base level, on rocks of very different degrees of hardness, has been able to work rapidly and sear and carve the mountains profoundly. With greater age mountain peaks and ridges are lowered, the valleys are broadened, and the rivers slowly shift position, eating their way backward at the headwaters, robbing weaker opponents of drainage area, and pushing their way across ridge after ridge, as in the Appalachians. The importance of the river gaps to transportation and the influence of mountains on occupation are observable throughout the world.

Rising land gives a straight coast, as along Western South America; sinking forms an irregular coast, with many islands, peninsulas, harbors, and straits, as in the Northeastern United States. A shelving coast of soft materials which has recently assumed its position is skirted by sandbars, like the coast south of New York, while a young coast of hard rock has bold headlands, with beaches in the bays. Here again are innumerable opportunities to study land forms in order to understand their cause and point out their influence on life.

The physiography of the lands investigates islands, peninsulas, capes, plains, plateaus, and valleys; it studies their differences in form; it distinguishes between the different kinds of hills,

cliffs, talus slopes, etc. In fact, it studies all land features, and in all cases it is concerned with the form, its cause, its relation to other land forms, and its effects on life. It shows how, in their conflict, the movements of the crust and the operation of the agents of denudation make land forms by constructional and by destructional processes. It shows that there is a constant building up of land forms by both the internal forces of elevation and the external forces of denudation; and that there is constant tearing down by the forces of denudation. It is the province of physiography to trace the operation of these processes, both to see how they modify the lands and to discover the influences of these modifications on life.

BIBLIOGRAPHY. Powell, Shaler, etc., *Physiography of the United States* (National Geographic Society Monograph, ib., 1896); Huxley, *Physiography* (London, 1880); Mackinder, *Britain and the British Seas* (New York, 1902); Tarr, *Physical Geography of New York State* (ib., 1901); id., *New Physical Geography* (ib., 1897); Davis, *Physical Geography* (Boston, 1900); Shaler, *Nature and Man in America* (New York, 1897); id., *Sea and Land* (ib., 1894). See GEOLOGY; GEOGRAPHY, etc.

PHYSIOLOGICAL SELECTION. A theoretical explanation proposed by Romanes of the evolution of species on the principle of the prevention of intercrossing. Hence Romanes also referred to the assumed law as that of the "Segregation of the fit." He was led to his generalization by consideration of the facts of sterility between species, and of fertility between varieties and races. Basing upon observation the postulate that the reproductive system was the most susceptible to change of any part of an animal's organization, he argued that in that system would often (perhaps more often than in any other) arise independent variations in individuals. If these were of such a character as to tend toward sterility between them and parent-forms, they would tend to separate the variety from the species and a new species would evolve. Romanes concluded that the principle of sterility between species was essential to the separate existence of species.

PHYSIOLOGY (Lat. *physiologia*, from Gk. *φυσιολογία*, natural philosophy, from *φυσιολόγος*, *physiologos*, discoursing on nature, natural philosopher, from *φύσις*, *physis*, nature + *λόγος*, *logos*, word, account, ratio, from *λέγειν*, *legein*, to say). Under the term physiology, when used in its widest sense, we include all that is known of the properties of living matter. Following the great line of demarcation of living things into animals and plants, we have an animal physiology and a plant physiology. The two subjects, while closely related, are sufficiently different to be considered as separate sciences and to require specialists of different training for their study. In animal physiology we have to deal especially with the properties of animal protoplasm, and although the fundamental properties of this material are believed to be much the same in all animals, yet for each animal or group of animals there are minor distinctions which are due in part to fundamental differences in structure, and in part to the variety in the physiological mechanisms developed in different animals. In what follows an attempt will be made to present briefly

an outline of the important facts and principles of human physiology, but it should be remembered that the body of facts included under this designation have been obtained in many, if not in most cases, by direct study and experiment upon lower forms of life, not only upon the mammals most closely related in structure to man, but also upon the simplest organisms which for one reason or another have offered especial opportunities for study.

It is convenient to consider the physiology of the human body under two general heads, namely, the properties of the tissues and the properties or functions of the organs and mechanisms. The human body, like that of other animals, starts as a single cell, the fertilized ovum. During the progress of development this cell multiplies to form an infinite number of cells which gradually become differentiated in structure and segregated into groups that are known as tissues. Each tissue is characterized by its appearance, as seen by the eye or with the aid of a microscope, and also by known differences in chemical composition and reaction. We distinguish in the human body the muscular tissue, the nervous tissue, the epithelial tissue, the gland or secreting tissue, the blood, the connective or supporting tissue, the lymphatic tissue, the tissue forming the red blood corpuscles, and so on. Each tissue is different not only in structure, but in its properties. Along with the differentiation in form there is a specialization in function. Without attempting to describe their microscopic characteristics, a word or two may be said of the more important physiological properties of some of these tissues.

THE MUSCULAR TISSUES. In man, as in the other vertebrates, we distinguish three kinds of muscular tissue: (1) the cross-striated or voluntary muscle which forms the musculature of the body by means of which our voluntary movements are made; (2) the heart-muscle, composing the walls of the heart; and (3) the plain or unstriated muscle which is found in the walls of the hollow viscera, such as the alimentary canal, the blood-vessels, the uterus, the bladder, etc. The common characteristic of these three tissues is the property of contracting. While this property may occur in other tissues, it reaches its greatest development in the muscles. In cross-striated muscles the contraction is always started by a stimulus received through the nerves and originated usually in the brain by an act of the will. The contraction is very rapid. A single stimulus gives a single or simple contraction that occupies less than one-tenth of a second. All of our ordinary voluntary contractions are, however, compound or tetanic, that is, they are composed of a rapid series of simple contractions fused together more or less completely. The rapid series of contractions is due to a series of stimuli or nerve impulses received from the brain through the nerve fibres connecting it with the muscle. In every voluntary movement, therefore, whether short or prolonged, we must imagine to ourselves a series of changes in the nerve cells of the brain, which are propagated along the connecting nerve fibres to the muscle or muscles and there set up a series of contractions so rapid that they become fused into a long-lasting contraction or movement.

Plain muscle is characterized by the slowness of its contractions. The tissue as found in different parts of the body varies somewhat in this respect, but in all cases its contractions are very

much slower than in the cross-stripped muscle. The plain muscle, moreover, is not under voluntary control; we are not conscious of the movements of the stomach, the blood-vessels, etc. The contractions of these organs are brought about by stimuli conveyed to the muscle through the so-called sympathetic nervous system. The slow and prolonged contractions of plain muscle explain the gentle, long-continued movements of the viscera such as occur in the action of the stomach and intestines in propelling food along their length. Heart-muscle is somewhat intermediate in structure between the plain and the cross-stripped varieties. Its contractions are also intermediate in duration, but approach closer to the quick movement of the striped muscle. The predominant characteristic of heart-muscle, however, is its property of making spontaneous rhythmic contractions which are due not to external stimuli received through the nervous system, but to processes arising within itself. To this property is due the rhythmic beat of the heart.

NERVOUS TISSUE. The nervous tissue is found in the brain, the spinal cord, the nerve ganglia of the sympathetic system, and the peripheral nerves or nerve trunks distributed throughout the body. The nerve tissue consists of nerve cells and their processes. The body of the cell lies in the nerve centres, that is, the brain, the spinal cord, and the ganglia, and the typical cell has two kinds of processes, one comparatively short and much branched, known as the dendrites or dendritic processes, the other but little branched and in some cases very long, as much as two or three feet. This latter branch is known as the axis-cylinder process; it may pass out of the nerve centres to be distributed to the other tissues forming the essential part of what we call nerve fibres. It is important, therefore, to bear in mind that nerve fibres are essentially long processes from nerve cells and form the mechanism by which the nerve centres are connected with and influence the activity of the peripheral tissues. Physiologically, the important function of a nerve fibre is to conduct a change or process known as the nerve impulse. This impulse travels along the fibre at a rate of about one hundred feet per second. The nerve fibres fall into two great groups, those that convey impulses from the peripheral tissues to the nerve centres, and those that convey impulses from the centres toward the periphery. The former group compose the afferent or sensory fibres, the latter name being used because in many cases the impulses finally reach the brain and give rise to conscious sensations of various kinds. In many cases, however, the impulses conveyed to the nerve centres by the afferent fibres cause no change in consciousness, but manifest themselves by what we call reflex effects, as, for instance, in the movements of the intestines, the blood-vessels, or the heart. The group of fibres that carry their impulses outward from the centre to the peripheral tissues compose the efferent or motor fibres. If these fibres end in muscles, the effect of their impulses is the production of a muscular contraction; if they end in a gland, they cause a secretion, the nature of the resulting action depending on the kind of tissue with which the nerve fibre is connected. It should be stated that there is no known difference in structure between afferent and efferent nerve fibres. Each, like a telegraph wire, can conduct an impulse in either direction.

But just as a telegraph wire with a sending apparatus at one end and a receiver at the other is arranged to conduct messages only in one direction, so the afferent and efferent nerve fibres, by the peculiarities of their end connections, are arranged so that normally they can convey effective impulses only in one direction. What we call a nerve or a nerve trunk consists of many hundreds or thousands of nerve fibres belonging usually to both the afferent and the efferent group. Though combined in one bundle, each fibre is physiologically independent and may act alone or in combination with others in the same trunk. In a muscle, on the contrary, the hundreds or thousands of muscular fibres of which it is composed act usually as a unit, all contracting together when the muscle is in action.

REFLEX ACTIONS. A large part of the beautiful adaptation and coördination of the different parts of our bodies is effected by the reflex activities of the nervous system entirely outside our conscious knowledge. The way in which these reflexes are produced is illustrated best by the simple reflex movements that can be obtained from a headless frog. If in such an animal, with its spinal cord intact, one of the toes is gently pinched, the leg will at once be drawn in toward the body. If the skin is stimulated by bits of paper moistened with dilute acetic acid, the leg of the corresponding side will be raised and the piece of paper will be wiped off by a neat movement involving the coördinate activity of a number of muscles. What happens in these cases is that the stimulus applied to the skin irritates the sensory nerve fibres and sends in a stream of nerve impulses to the spinal cord. These impulses are conveyed to the dendrites of certain motor nerve cells and arouse in them fresh impulses which are conducted outward through the efferent nerve fibres to the muscles. The original stimulus, or, more accurately, the nerve impulses to which it gives origin are thus, as it were, reflected in the nerve centres and sent to the peripheral tissues, whence the name of reflex action. Every such reflex involves the activity of at least two groups of nerve cells, one connected with the sensory fibres stimulated and one connected with the efferent fibres going to the muscles. Such reflexes may occur in all parts of the spinal cord and brain. A common reflex in ourselves, for instance, is the winking of the eye when its sensory surfaces are touched. As a rule we limit the term reflex action to those cases in which the element of consciousness is not involved. As a matter of fact, however, all of our conscious processes and mental activities are effected by a similar action of one nerve cell or unit on another, the mechanism in action being essentially similar to, although more complex than, the simple reflexes of the spinal cord. In a mammal as well as in a frog it can be shown that if a part of the spinal cord is severed from its connections with the brain, under such conditions that death does not result at once, the part of the cord below the injury will suffice to effect complex movements upon appropriate stimulation of the skin. To the uninformed such movements usually suggest consciousness, but the evidence of physiology proves conclusively that they are entirely unconscious reflexes.

It should be added that the outgoing impulse in reflex stimulation of the cord or brain may proceed through nerve fibres connected with other

tissues such as the heart-muscle, the plain muscle of the viscera or the glands, and the reflex effect, instead of exhibiting itself as a movement of the limbs, may take the form of a secretion, of a change in the heart beat, or of a constriction or dilatation of the blood-vessels. Owing to the complexity of the connections among the numerous nerve cells in the spinal cord and brain, it is evident that reflex effects may be widespread and very intricate. Certain definite paths or connections are inherited or become acquired during life from repeated use, so that the passage of a sensory nerve impulse that reaches the central nervous system is not hap-hazard, but for the most part along predetermined paths. The wonderful instincts of the lower animals may be regarded as complicated reflexes, and the unconscious regulation of the different parts of our body, especially the activity of the internal organs or viscera, is controlled in this way by the nervous system.

THE CIRCULATORY MECHANISM. The anatomical mechanism for the circulation of the blood and lymph consists of the heart, the blood-vessels, and the lymph-vessels. With regard to the blood we have the central fact that the powerful musculature of the heart serves as a force-pump driving the blood out from the ventricles through the circuit of the blood-vessels and back to the heart. The system of arteries branching from the heart resembles a tree with its central trunk and its vast number of branches of different sizes. As one goes outward from the heart toward the periphery, the arteries distributed to each organ become smaller and smaller until they end in minute capillaries. The combined area of these branches increases, however, toward the periphery, so that the sum of the areas of all the capillaries arising from the aorta is several hundred times as great as that of the aorta itself, just as the combined diameters of all of the twigs of a tree would much exceed that of the trunk. The quantity of blood being practically the same at all times, it becomes distributed as it goes out from the heart over a wider and wider area, or, to use a convenient figure, flows through a wider and wider bed. As a result of this fact the velocity of the blood-flow becomes smaller as we approach the capillaries. While in the aorta the blood may flow with a velocity of 300 millimeters per second, in the capillaries the velocity becomes reduced to $\frac{1}{2}$ millimeter. In the venous system the same general fact holds true. The capillaries unite into larger veins, and these into still larger ones, until finally all of the blood in the aortic system is collected into two large veins, the superior and the inferior vena cava, which open into the auricles. As a consequence the blood, as it flows back to the heart, passes through a path that becomes narrower and narrower, and its velocity increases proportionately. With regard to the velocity of the blood-flow, therefore, we can state that it is greatest in the large arteries and veins and least in the capillaries.

In the arteries, moreover, the blood is under a much greater pressure than in the capillaries and veins. From a cut artery the blood spurts to some distance, while from a cut vein the blood flows out quickly, but with little force. The cause of this difference is easily understood. In flowing through the vessels the blood encounters considerable resistance. Naturally this re-

sistance is greatest in the capillaries and in the small arteries and veins communicating with them. On account of the great resistance in the capillary region, known technically as the peripheral resistance, the blood is dammed up, retarded on the arterial side, stretching the elastic walls of the arteries and putting the blood under a considerable tension. In the capillaries the pressure of the blood is much less, and in the veins it becomes smaller and smaller as we approach the heart. Physiologically the most important part of the blood-circuit is in the capillaries. While flowing through these thin-walled and very minute vessels the blood fulfills its function of nourishing the tissues. At this point the blood, while still under some pressure, is flowing at its slowest rate, and the liquid part of it, the blood plasma, transudes through the thin walls and comes into direct contact with the tissues, thus forming the tissue-lymph. The oxygen carried by the red corpuscles of the blood is liberated in the capillaries and diffuses from the blood to the tissues, being transported to the latter while held in solution in the lymph. The lymph gives up its food materials and oxygen to the tissue cells and at the same time receives from them the waste products and carbon dioxide formed during their nutritive activity. The lymph is prevented from accumulating in the tissues by the fact that it is continually drained off by the system of lymphatic vessels. These vessels form a system parallel in course and structure to that of the veins. They begin in the tissues by small capillaries which unite to larger and larger vessels, forming eventually two main trunks that open into the veins of the neck. By this arrangement the excess of lymph is continually drained off and returned to the blood. The means by which the supply of lymph is regulated forms one of the most interesting and difficult subjects of study in modern physiology.

The heart and blood-vessels are not a fixed and rigid system. On the contrary, they are supplied with nerves through which the beat of the heart and the capacity and resistance of the blood-vessels may be reflexly adapted to the different conditions of the body as a whole, or the individual needs of its separate parts. The heart receives two sets of nerve fibres; one, the inhibitory fibres, are capable of slowing the heart-beat; the other, the accelerative fibres, quicken the rate. The small arteries, on the other hand, receive also two sets of nerve fibres; one, the vaso-constrictors, causes a diminution in size of the blood-vessels, while the other, the vasodilators, brings about an increase in size. The numerous conditions under which these regulating nerve fibres act are too complex to be described here. The mechanism is so adjusted as to control automatically the supply of blood to different organs under varying conditions of rest and activity.

THE RESPIRATORY MECHANISM. In mammals like ourselves the chief organ of external respiration is the lungs. When the inspiratory muscles are contracted the chest is enlarged and air flows into the lungs. When the expiratory muscles are contracted the chest is diminished in size and air is forced out of the lungs. In ordinary respiration the expiratory act is entirely passive; the chest, expanded by the action of the inspiratory muscles, sinks back into its normal position when these muscles cease to act. In forced breathing,

however, the expiratory muscles come into action. By means of these respiratory movements the air in the lungs is continually renewed, the supply of oxygen is maintained, and the carbon dioxide is removed. The oxygen contained in the air-sacs of the lungs diffuses through their thin walls, and, coming into contact with the blood, it unites chemically with the coloring matter of the red corpuscles, the hæmoglobin. In this combination it is carried to the heart, and thence distributed over the body through the various arteries. When the blood reaches the capillaries the compound of hæmoglobin and oxygen is broken or dissociated by the physical conditions there prevailing, while the liberated oxygen passes into solution in the blood plasma and lymph, and is thus conveyed to the tissues. On the other hand, the general nutritive change or metabolism of the tissues results in the formation among other things of carbon dioxide. This substance is a waste product, and if it accumulates in the tissues, brings on a suppression or perversion of the normal nutritive processes. Under normal conditions, however, it is rapidly removed by the lymph and blood. As the oxygen passes from the blood to the tissues by diffusion through the thin-walled capillaries, so the carbon dioxide as rapidly as it is formed streams in the opposite direction from tissues to blood. Each gas follows the physical law of diffusion from a point of greater to one of less tension. Within the blood the carbon dioxide is held mainly in chemical combination, partly with the proteids of the blood plasma, partly with the proteids of the blood corpuscles. When the blood reaches the lungs this loose chemical union breaks down, the carbon dioxide is liberated and diffuses into the air-sacs of the lungs, whence it is given off in the expired air. The process of respiration, therefore, may be divided into two parts, external and internal respiration. Under the former term we include all the processes involved in the movement of air into and out of the lungs, and the exchange of oxygen and carbon dioxide between the blood and the air in the lungs. By internal respiration we mean the exchange of oxygen and carbon dioxide between the tissues and the blood as well as the processes of nutrition by means of which the oxygen is used and the carbon dioxide produced. What we call arterial blood differs from venous blood in that it contains more oxygen and less carbon dioxide, and to this difference in the gaseous contents is due also the well-known variation in color, arterial blood having a scarlet tint, while the venous blood is purplish or crimson. The machinery for the movements of respiration, that is, the respiratory muscles, are under the control of the central nervous system. These muscles may be influenced within certain limits by direct voluntary effort; but a far more important factor is their unconscious or reflex regulation exerted through the respiratory nerve cells or nerve centre found in the medulla oblongata. By the activity of this centre the respiratory movements are kept continually in play and the extent of the respirations is adjusted to the needs of the body.

DIGESTION AND NUTRITION. The living matter of the animal body is characterized, as compared with plant protoplasm, by its limited powers of assimilation. While the latter can construct living matter from comparatively simple inorganic material, such as carbon dioxide, water,

and nitrogen containing salts, the former requires food in the more complex form of organic material. Since in the last analysis this organic food is derived from the plant kingdom, it may be said that the maintenance of animal life is only possible through the synthetic activity of plant protoplasm. All of our varied foods are found upon analysis to be composed of essentially the same materials united in different proportions. These constituent materials of our foods are known as food-stuffs and are usually classified as *proteids, fats, carbohydrates, water, and salts*. Of these substances the water, inorganic salts, and proteids are absolutely essential. The two former are necessary to the composition and reactions of the living tissues, but they do not directly furnish any energy to the body. The requisite amount of water is controlled by the sensation of thirst, and the proper proportions of the inorganic salts are provided in our foods without the necessity of any conscious selection on our part, except perhaps in the case of sodium chloride. Proteid foods have a different value. They are complex nitrogen-containing compounds which in the body are destroyed and reduced to much simpler substances, namely, carbon dioxide, water, and urea. This destruction of proteid is essentially an oxidation, and as much heat is given off in the process as would be liberated outside the body by burning proteid to the same end-products. Proteids are an absolutely necessary constituent of food, because they contain nitrogen in a form capable of being used in the construction of living matter. Fats and carbohydrates, since they contain no nitrogen, cannot be used alone in the synthesis of protoplasm. They are nevertheless valuable foods, since they are readily destroyed or burned in the body with the liberation of energy in the form of heat or muscular work. In a normal diet proteids, fats, and carbohydrates are usually combined in certain proportions, and experience as well as direct physiological experiments show that within limits the fats and the carbohydrates may be interchanged, and furthermore the greater the amount of these two substances used the less will be the amount of proteid required; as we say in physiology, fats and carbohydrates are 'proteid spacers.'

The nutritive history of these three energy-yielding foods may be summarized briefly as follows: The proteids in whatever form they may be taken are digested partly in the stomach by the action of the gastric juice and partly in the intestines by the action of the pancreatic juice. By the act of digestion the food proteids are converted into simpler and more soluble forms known as peptones and protoses, which are then absorbed into the blood and carried to the various tissues. Here they are utilized in part to form protoplasm, either to replace that broken down in metabolism or to supply material for growth. But much the larger part of the proteid is simply destroyed in the tissues with the transformation of some of its chemical energy into a corresponding amount of heat. The fats are prepared for digestion in the stomach, but undergo the important change that fits them for absorption after they are brought into contact with the pancreatic juice in the small intestine. After absorption they are found in the blood and lymph for a time, but soon pass into the tissues. Here they may be deposited as part of our normal store of

body-fat, but with the usual diet of adult life they are supposed to be completely burned. It is known from experiments that one gram of fat burned outside or inside the body yields as much heat as 2.2 grams of proteid. The carbohydrates include the starches and the sugars which from a nutritive standpoint have the same value. The starches form the bulk of our diet, and they are digested partly in the mouth by the action of the saliva, but mainly in the small intestine by the action of the pancreatic secretion. Under the influence of these secretions the starches are converted into a form of sugar, which is then absorbed into the blood. As the blood from the intestines passes through the liver this absorbed sugar is removed and again converted into a form of starch known as glycogen, which is deposited or stored in the liver cells. From time to time the glycogen is reconverted to sugar and given off to the blood. The regulating mechanism controlling this production and conversion of glycogen is so adjusted that under the normal conditions of life the blood always contains a nearly constant amount of sugar. Sugar, therefore, is the final form in which all of our carbohydrate food is brought to the tissues—and under the influence of the living matter it is eventually oxidized to carbon dioxide and water. In the long run, therefore, the final fate of our food is to be burned and furnish energy in the form of heat, muscular work, etc. The continual consumption of food is necessary to maintain the body temperature, and in the body we have very complex regulating mechanisms which control the loss of heat and to a certain extent its production, with the normal result that the temperature of the body remains nearly constant under all the varying conditions of life. It has been shown with scientific accuracy that all the detectible energy given off from the body is derived directly from the food consumed. The energy value of any food can, therefore, be determined by ascertaining the amount of heat produced by burning it, or more conveniently by ascertaining the heat value of proteids, fats, and carbohydrates, and then analyzing the food to determine how much of these three foodstuffs is contained in it.

THE CENTRAL NERVOUS SYSTEM. Some statements regarding the structure of the nervous system will be found in the beginning of this article. (Consult also the article on **NERVOUS SYSTEM AND BRAIN.**) At the base of the brain immediately adjoining the spinal cord we have the medulla oblongata. In this part of the brain are found certain important collections of nerve cells which control the movements of respiration, of the heart, and of the blood-vessels, their activity being entirely unconscious and under the influence of reflex stimulation. Collections of nerve cells connected with and regulating the action of physiological mechanisms are known as nerve centres, and in the medulla we recognize the existence of the three centres mentioned and designate them as the respiratory centre, the cardio-inhibitory centre, and the vaso-motor centre. They and other similar centres regulate the activity of the visceral organs, whose functions are discharged for the most part without our conscious knowledge or control. Injury to the medulla or severance of its connections with the spinal cord is fatal at once, owing to the destruction of the connections of the respiratory

centre with the respiratory muscles and the consequent inability to breathe. In the cerebellum we have an organ which seems to control the co-ordinated activity of the voluntary muscles. Extensive injury to the cerebellum, while not accompanied by actual paralysis, renders the animal incapable of executing orderly movements. If the animal survives the injury, the ability to make co-ordinated movements may be recovered more or less completely, but some awkwardness and muscular weakness persist as permanent results. In the nerve cells of the cerebral hemispheres we have the seat of the conscious sensations and of all the so-called psychic activities. Modern physiology has shown that different parts of the cerebral hemispheres have different functions. The optic nerve fibres end eventually in the occipital lobes, and here our conscious sensations of vision are mediated. A similar arrangement prevails for the other senses. In the cortex of gray matter covering the cerebral hemispheres there are in fact certain sense areas each of which mediates a different kind of consciousness. Other areas are connected with the various muscles of the body and form the centres through which our voluntary movements are executed, while in still other regions we have areas in which are stored the memories of past experiences and in which the factors of sensation are organized into the complex associations that characterize our mental life. Injuries to the brain may, therefore, be followed by quite different results according to the region involved. There may be a paralysis of this or that group of muscles, a loss of this or that primary sensation, or a disturbance or perversion of this or that group of memory associations. The so-called aphasias form noteworthy illustrations of these facts. Injury to certain limited areas of the brain may result in a partial or complete loss of the power of speech, or of the ability to understand either written or spoken language without any interference with vision or hearing. When defects of this character exist it is possible to locate the probable seat of the lesion, and not infrequently this knowledge has been made the basis of successful surgical operations.

HISTORY OF PHYSIOLOGY. The history of physiology is coextensive with that of medicine. Its relatively slow advancement through many centuries was closely associated with the growth of anatomical, chemical, and physical knowledge. In modern times, however, dating perhaps from the first part of the nineteenth century, physiology has become an independent science with a technique peculiarly its own, yet adopting more and more the exact methods that have arisen in the sciences of physics and chemistry. This development of physiology has been especially marked since investigators abandoned the idea of a special vital force controlling the phenomena of life and set themselves to the task of explaining the properties of living matter in terms of the forms of energy recognized as responsible for the phenomena of inanimate nature. The great facts in physiology, as in other subjects, have been discovered in a few cases only by the genius of individual workers. In most instances they have developed gradually as the result of the combined labors of many investigators, so that a history of the growth of the fundamental principles of modern physiology involves a discussion of the progress of the natural sciences in gen-

eral. Every important advance in physics and chemistry has influenced and will continue to influence the development of physiological knowledge. Some of the significant discoveries that belong especially to physiology and that can be traced more or less exactly to a definite period and individual observers are as follows: The circulation of the blood (Harvey, 1616-28); the existence of the lymphatic system of vessels (Aselli, 1622); the microscopic structure of the lungs, capillaries, glands, and other tissues (Malpighi, 1660-90); the discovery of the mammalian spermatozoon (Leeuwenhoek, 1678); the method of direct measurement of blood-pressure (Hales, 1732); the independent irritability of muscle (Haller, 1757); the discovery of oxygen and its functions in respiration (Lavoisier, 1775); the digestive action of gastric juice (Réaumur, 1752); the distinction between motor and sensory nerve fibres (Bell and Magendie, 1811-22); the discovery of the mammalian ovum (Von Baer, 1827); the true nature of the secretions of glands (Johannes Müller, 1830); the existence of enzymes, unorganized ferments, in the gland secretions and saliva—diastase (Leuchs, 1831); pepsin (Schwann, 1836); the nature of reflex actions (Marshall Hall, 1837); the electrical phenomena of muscle and nerve (Du Bois-Reymond, 1843); the existence of inhibition and inhibitory nerve fibres (Weber, 1845); the introduction of the graphic method in physiological experimentation (Ludwig, 1847); the existence of secretory nerve fibres (Ludwig, 1851); the existence of vaso-motor nerve fibres (Bernard, 1851); the existence and functions of glycogen (Bernard, 1857); the function of hæmoglobin in respiration (Hoppe-Seyler and Stokes, 1862-64); the localization of function in the cerebrum (Fritsch and Hitzig, 1870); the establishment of the fact of internal secretions (Brown-Séquard and others, 1891). For full information, consult: Foster, *Text-Book on Physiology* (Philadelphia, 1885); *The American Text-Book of Physiology* (2d ed., ib., 1900); Schäfer, *Text-Book of Physiology* (New York, 1900). For details of the histological features, consult Piersol, *A Text-Book of Normal Histology* (Philadelphia, 1901).

PHYSIOLOGY OF PLANTS. HISTORY. Up to the close of the seventeenth century nothing was known of the physiology of plants beyond the scattered impressions derived from the practical cultivation of plants in fields and gardens. Inasmuch as the physiology of animals was better known, the first study of the actions of plants was an endeavor to identify plant functions with those of animals. As the functions of animals were only superficially known, this attempted identification led oftentimes to most egregious errors. But as the nature of animal functions became better known, the essential identity of the processes in both sorts of living beings became more evident. At first the study of physiology was scarcely more than an enumeration of plant activities and their comparison with those of animals. Later, however, attempts were made to investigate the causes and conditions of the functions. For this a knowledge of anatomy was recognized as of prime importance. Deeper insight into physiology, however, demanded knowledge of physics and chemistry; and it was only when these two sciences underwent their pro-

found transformation and extension that explanations of plant phenomena began to be possible. Among the earliest investigations after the revival of learning were those made in Italy by Malpighi on the movement of sap, and those of Ray on the influence of light upon the colors of plants. About the same time in Germany Camerarius proved the necessity of pollen for the formation of fertile seeds.

Early in the eighteenth century Hales published his studies on the movement of sap and the evaporation of water from the leaves. Later in the eighteenth century came the investigations of Koelreuter, who added to the knowledge of sexuality in plants by his experiments on hybridization. It was in connection with these experiments that the relations of insects to pollination were first pointed out. Later (1793) these interesting relations were set forth at length by Christian Konrad Sprengel, whose famous "Das entdeckte Geheimnis der Natur" was scarcely appreciated until the contributions of Darwin had opened the eyes and understanding of naturalists to Sprengel's extraordinary work. About the same time Ingenhous showed that the green parts of plants when illuminated absorb carbon dioxide and eliminate oxygen, thus deriving the carbon which they need from the atmosphere. He also showed that the living parts of plants absorb oxygen, whether illuminated or not, and evolve carbon dioxide, thus establishing the fundamental facts of nutrition and respiration. This work was further confirmed by Senebier, who demonstrated that the decomposition of carbon dioxide takes place only in green organs. He also studied the influence of light upon the growth and green color of plants. By the beginning of the nineteenth century Nicolas Théodore de Saussure had shown that plants not only fix carbon from carbon dioxide, but also use the elements of water, which, with the mineral salts, are a necessary part of the food materials. Between 1822 and 1832 De Saussure and Goepfert established the connection between the respiration of plants and the development of heat in their bodies. Through the influence of Liebig, about the middle of the century, Ingenhous's clear exposition of the respiration of plants, which had been fairly established, was discarded, to be reinstated in confidence only after 1860 by the father of modern vegetable physiology, Julius von Sachs. Yet Liebig's valuable work in connection with the chemistry of foods and food materials of plants and Bous-singault's investigations in France, especially in relating the known facts to the empirical processes of agriculture, were of great service to both cultivators and physiologists. The year 1860 marks the rise of modern physiology, as indeed it does the rise of modern biology, many cooperating causes, the most notable of which was the publication of Darwin's *Origin of Species*, furnishing the impulse to renewed investigation.

SCOPE. As a science, plant physiology concerns itself with every inquiry relating to the functions and behavior of living plants. Certain aspects of physiology, namely the relation of living plants to the environment, physical (including soil, water supply, temperature, etc.) and biological (i.e. other plants and animals), have recently been separated from physiology proper and named ecology (q.v.). Physiology proper restricts itself to the activities of the individual

plant. Its study demands a previous knowledge of the anatomy (q.v.) and histology (q.v.) of plants, since familiarity with plant mechanism must precede the knowledge of plant function.

The functions of plants may be divided for convenience into certain groups. *First*, processes connected with the absorption of materials by the plant from the surrounding medium. Everything which enters the plant body must do so in solution. The plant depends, therefore, fundamentally upon water, which, with an infinite variety of solutes, both solid and gaseous, it absorbs. (See ABSORPTION.) *Second*, processes by which materials escape from the plant body. Gases, especially carbon dioxide and oxygen, are evolved (see AÉRATION; OSMOSIS); a great variety of materials are eliminated from the plant body by various processes of secretion (q.v.); and water is evaporated in great quantity by the surfaces of land plants. (See TRANSPIRATION.) *Third*, processes by which water and gases are moved about from the points of absorption or manufacture to the points of use, storage, or loss. But in spite of the fact that the movement of water was almost the first subject that attracted the attention of observers, no satisfactory explanation has yet been devised. (See CONDUCTION.) *Fourth*, processes of nutrition. Carbohydrate foods are made only by green plants under the influence of light, a power which is of the utmost importance, since the commercial supply of food and energy depends at present almost wholly upon green plants. The making of carbohydrates is fully described in the article PHOTOSYNTHESIS. (See CHLOROPHYLL; CHLOROPLASTS.) All plants, however, make proteid foods, when the necessary supply of carbohydrates, nitrates, and salts is furnished. Proteid synthesis is discussed in the article FOOD OF PLANTS. When proteid foods are at hand, either through manufacture or absorption, they undergo various changes before they become a part of the protoplasm. (For what little is known of these processes, see ASSIMILATION.) *Fifth*, processes concerned with the release of energy in the plant body or adjacent to it, in such a way that the kinetic energy can be applied to such work as the plant must do. For most plants, these processes constitute respiration. (See RESPIRATION IN PLANTS.) For a few plants fermentation (q.v.) seems to replace, in part at least, the normal respiration. *Sixth*, processes of repair and growth. One of the important activities of the plant is the formation of new material or the rearrangement of old into new parts. The diverse operations involved in this constitute growth (q.v.). *Seventh*, processes of perception and response. Every function of the plant is more or less influenced by the changes occurring in its vicinity, whether these be entirely outside of the body or only in adjacent parts. In order to adjust itself to these changes the plant must receive impressions of them, and these impressions must result in appropriate adjustment. The changes in the protoplasm corresponding to changes in the surrounding medium and the chain of effects thus initiated, are said to manifest irritability (q.v.). The visible alterations of the rate of growth (q.v.) or in movement (q.v.) are most striking evidences of irritability. See CHEMOTROPISM; GEOTROPISM; HELIOTROPISM; HYDROTROPISM; MOTOR ORGAN; RHEOTROPISM; STIMULUS; TENDRIL; TRAUMATROPISM.

BIBLIOGRAPHY. Sachs, *History of Botany* (Eng. trans. Oxford, 1890); id., *Lectures on the Physiology of Plants* (Eng. trans., ib., 1887); Vines, *Lectures on the Physiology of Plants* (Cambridge, 1886); Goodale, *Physiological Botany* (New York, 1885); Pfeiffer, *Plant Physiology* (2d ed., trans. by Ewart, Oxford, 1900); MacDougal *Practical Text-Book of Plant Physiology* (New York, 1901); Green, *Vegetable Physiology* (London, 1901); Peirce, *Plant Physiology* (New York, 1903). In experimental plant physiology consult the following: Detmer, *Practical Plant Physiology*, trans. by Moor (London, 1898); Darwin and Acton, *Practical Physiology of Plants* (Cambridge, 1894); Ganong, *An Elementary Course in Plant Physiology* (New York, 1901); MacDougal, *Experimental Plant Physiology* (ib., 1895). A brief and elementary summary of plant physiology will be found in Barnes, *Plant Life* (New York, 1898).

PHY'SODON (Neo-Lat., from Gk. φύσα, *physa*, bellows, breath, bubble + ὀδούς, *odous*, tooth). An extinct sperm whale known by its skull, found in the Miocene formations of Patagonia. It differed from the modern sperm whale in having enamel-capped teeth in its upper jaws. See CETACEA.

PHY'SOSTIG'MA. See CALABAR BEAN.

PHYTOGEOGRAPHY. See DISTRIBUTION OF PLANTS.

PHY'TOLAC'CA (Neo-Lat., from Gk. φυτόν, *phyton*, plant + Neo-Lat. *tacca*, lac; from Per. *lak*, *luk*; Hind. *lāk*, from Skt. *lākṣā*, lac-insect, from *lākṣā*, hundred thousand, referring to the numbers of insects in each nest; so called from the crimson juice of the berries). A genus of about 20 species of dicotyledonous herbs and half-shrubs of the natural order Phytolaccaceæ, natives of warm parts of Asia, Africa, and America. *Phytolacca decandra*, the poke or pocan, a native of North America, now naturalized in some parts of South Europe, is occasionally cultivated for its young shoots, which are eaten like asparagus. The juice of the berries, which are about the size and color of black currants, is employed in the adulteration of wine. The young shoots of *Phytolacca acinosa* are boiled and eaten in the Himalayas. Under the name *Phytolacca esculenta* it has been introduced into gardens.

PHY'TOLAC'CA (in medicine). Official under either of two forms, the fruit or the root of *Phytolacca decandra* or poke, also called 'pigeon-berry' and 'garget root.' The fruit is a small, deep purple compound berry, nearly round, with a sweet and slightly astringent taste. The root is "large, branched, fracture fibrous, inodorous, sweetish, and acrid" (Potter). A fluid extract and a tincture are the preparations used, besides the berry and root. Poke has been used in ulcers, certain tumors, eczema, syphilis, and other skin diseases, chronic rheumatism, mastitis, tonsillitis, and pharyngitis. It has been used to decrease adipose tissue and thus reduce obesity since 1858. When given in large doses, phytolacca causes nausea, depression, vomiting, and purging. It lowers the rate of respiration and weakens the heart's action, and has caused convulsions.

PI. See PRINTING.

PIACENZA, pē'a-chēn'tsā. The capital of the Province of Piacenza, Italy, situated on the right

bank of the Po, two miles below its confluence with the Trebbia, 43 miles southeast of Milan (Map: Italy, D 2). The city is gloomy and desolate in appearance, though its thoroughfares are broad and regular. The Stradone is one of the most beautiful streets in Italy. Piacenza occupies a position of great strategic importance, and is fortified with solid walls and a strong castle. The Italian Government has strengthened and extended these fortifications by the construction of external defensive works, and by a formidable intrenched camp. The city has numerous fine palaces and churches. The attractive cathedral, an edifice in the Lombard-Romanesque style, founded in the eleventh century, is interesting for the grotesque character of its interior decorations. It has frescoes by Guercino and L. Carracci. The Church of Sant' Antonino, the original Cathedral of Piacenza, has been several times rebuilt. Santa Maria di Campagna has excellent mural paintings by Pordenone. The noteworthy San Sisto, an ancient church rebuilt in the Renaissance, gave its name to Raphael's Sistine Madonna. Among the other principal buildings are the immense Palazzo Farnese, begun in 1558 and never completed, once famous, but now serving as barracks; the fine Palazzo Municipale, dating from the thirteenth century, with its arched arcades and pinnacles; and the Palazzo dei Tribunali with curious courts, now in ruins. The principal square is the Piazza de' Cavalli, so called from the colossal bronze equestrian statues of the Dukes Alessandro and Ranuccio Farnese. There are a public library with over 130,000 volumes, a splendid theatre built in 1803, two new theatres, several hospitals, and an arsenal. Piacenza has manufactures of silk, cotton and woolen goods, hats, pottery, and machinery, and a trade in wine, grain, cheese, and marble from its quarries. Population (commune), in 1881, 34,987; in 1901, 36,064.

Piacenza, the ancient Placentia, was founded by the Romans in B.C. 219. In B.C. 200 it was plundered and burned by the Gauls, but recovered its prosperity with the construction of the Æmilian military road, which had its western terminus here. In the twelfth century it became a member of the Lombard League. In 1545 Piacenza, along with Parma, was erected into a duchy for the Farnese family. (See PARMA.) An important battle occurred here in 1746 in which the allied French and Spaniards were defeated by the Austrians. Consult Giarelli, *Storia di Piacenza* (Piacenza, 1889).

PIA MATER. See NERVOUS SYSTEM AND BRAIN.

PIAN'KISHAW. An Algonquian tribe, originally a band of the Miami, formerly residing chiefly upon the lower Wabash and claiming jurisdiction over most of southern Indiana and southeastern Illinois. When first known to the French, about 1670, they were in central Illinois, with the Miami and Illinois, and probably reached the Wabash about 1700. In 1832 they and the Wea sold all their claims in the east and agreed to remove to Kansas as one tribe. In 1867, having in the meantime consolidated with the remnants of the Illinois, they removed to the Indian Territory. They probably never numbered many more than 1000. In 1870 they were reported at 950, in 1895 at 800. In 1825 there were only 234 remaining in their original country,

with a few others residing in Missouri. The whole body of mixed-blood Piankishaw, Wea, Kaskaskia, and Peoria together now number only 180.

PIANO (It., soft), abbreviated *p*. A sign used in music to denote that the strain where the indication occurs is to be played with less than the average intensity of force: *pp*, or *ppp*, for *pianissimo*, signifies very soft, or as soft as possible. *Piano* is used in contradistinction to *forte* (q.v.), and the transition from the former to the latter is indicated by the sign <; the change from *forte* to *piano* is marked by the opposite sign >.

PIANOFORTE (It. *pianoforte*, from *piano*, soft + *forte*, loud). A percussive instrument consisting of wire strings struck by felt-covered hammers, operated by keys arranged in a keyboard. It was directly evolved from the clavichord and harpsichord (qq.v.). The history of the pianoforte proper begins with the year 1709. Scipione Maffei in the *Giornale dei letterati d'Italia* (1711) gives a detailed account of four instruments built by Bartolommeo Cristofori (not Cristofali, as generally stated until quite recently), named by him *pianoforte* and exhibited in 1709. The earlier clavichord and harpsichord admitted no gradation of the loudness of tone. In order to render musical performances more expressive by a contrast of soft and loud tones, three different men about the same time turned their attention to this matter. These were the just-mentioned Cristofori in Italy, Marius in France, and Schröter in Germany. Marius exhibited some harpsichords with hammer-action in Paris in 1716, but it is not known that Schröter ever built an instrument or had one built for him. Schröter claimed to have invented the hammer-action between 1717 and 1721. But not until 1738, when Cristofori's instruments had become famous, did he come forward with his claim; and he waited even till 1763 before he published for the first time a drawing of his invention.

Cristofori's earlier instruments show a very simple form of escapement: the return of the hopper to a perpendicular position is secured by means of a spring. But there is no check to prevent the rebound of the hammer after striking

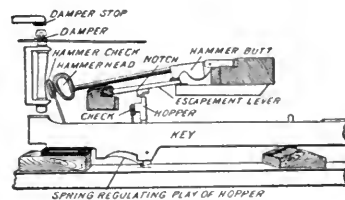

ACTION OF CRISTOFORI'S PIANO.

the string. Two later instruments, built in 1720 and 1726 respectively, have a device for checking. In order to withstand the force of the impact of the hammer it was necessary to use thicker wire than in the harpsichord. This thicker wire increased the force of the tension, and necessitated a strengthening of the supporting framework. The hammers were covered with leather, and every key had a damper. Thus the fundamental principles of our modern grand pianos are all found, though in a simpler form, in the instruments of Cristofori. The compass of these instruments was four to four and a half octaves. The action of

Cristofori was adopted in its essential features by the famous organ-builder Silbermann. His first instruments failed to win the approbation of J. S. Bach, who criticised them for their weak treble and heavy action. This led Silbermann to spend some years in experiments which finally resulted in success.

Up to 1760 all pianofortes were built in the shape of the modern grand. In that year Zumppe a German workman, settled in London and began to build instruments in the square form, which at once became very popular. About the same time other makers settled in London and practically made the English capital the centre of the world's pianoforte trade. About 1790 Broadwood, working upon acoustic principles, discovered the fact that when struck at a certain point the string would yield a fuller tone. Accordingly he adjusted the hammers so as to obtain this result. He also transferred the wrest-plank (the block in which the tuning pins are held) to the back of the case, and in 1783 invented the pedals: one by means of which all the dampers could be raised, the other to soften the tone by dropping a piece of cloth over the strings. In these improvements Broadwood had the advice and assistance of Backer and Stodard. The action as perfected by Broadwood has come to be known as the English action, and is generally in use today.

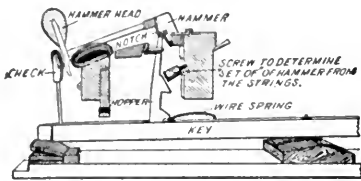

ENGLISH GRAND PIANOFORTE ACTION.

Meanwhile German manufacturers had not been idle. Stein, a pupil of Silbermann, invented a new action, which has become famous as the Viennese action. While in Cristofori's (English) action the axis of the hammer does not change, because the hammer is fixed upon a lever separate from the key. Stein attached the hammer directly to the rear end of the key itself, causing a change of axis of the hammer when the key is struck. This produced the extreme lightness characteristic of the Viennese action. Stein's

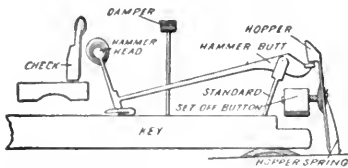

STREICHER'S GRAND PIANOFORTE ACTION.

son-in-law, Streicher, in 1794 further improved this action and established a great reputation for his instruments. France was supplied chiefly with English pianos until Erard (a German whose name originally was Erhardt) settled in Paris in 1777. The Revolution drove him to London, where he made himself thoroughly familiar with English methods. Even after his return to Paris Erard continued to use the English action, but meanwhile he was seeking some improvement. His experiments resulted in 1821 in the double

escapement action, which soon spread the fame of Erard all over the world. The next important manufacturer in France was again a native German, Pape, of Hanover. Pape invented, in 1827, a down-striking action where the action is above

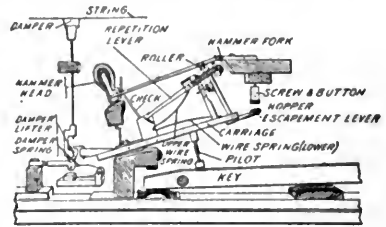

FRENCH GRAND PIANOFORTE ACTION.

the strings. He also substituted felt for leather in the covering of the hammers (1839). But this departure had already been made a few years previous by Babcock, of Boston.

In order to save space, some English makers toward the end of the eighteenth century conceived the idea of building pianos in an upright form. The first attempts consisted in nothing more than turning a grand or square instrument on one side. The first genuine upright was patented (1800) in England and the United States by John Isaac Hawkins, an Englishman living in the latter country. It is remarkable for containing most of the features which distinguish the modern upright. In the direct line of piano development, however, we owe a greater debt of gratitude to Southwell, who after fourteen years of experimenting exhibited the first upright piano that yielded practical results in 1807. This he called the 'Cabinet.' In 1811 he built another instrument which shows many decided improvements. Wornum still further improved this

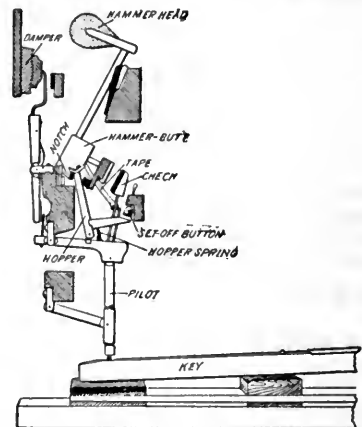

ENGLISH UPRIGHT PIANOFORTE ACTION.

model by the introduction of diagonal stringing. The increased length of the strings yielded a more powerful tone. He also invented a new action principle (the so-called lever-check action), which was taken up and further improved by Pleyel of Paris, in which form it became known as the French action.

It must not be imagined that the pianoforte immediately upon its appearance at the beginning

of the eighteenth century superseded the harpsichord or clavicembalo. These instruments continued to be made; especially the clavicembalo kept its position in the orchestra throughout the century. Composers still wrote for the harpsichord. The earliest known composition written especially for pianoforte appeared in 1771. The composer, a certain Müthel, entitles it "Duetto für zwey Claviere, zwey Fortepiano oder zwey Flügel." But the technique is not different from that of the harpsichord. The first compositions written especially for the pianoforte and showing a technique characteristic of the new instrument are three sonatas (op. 2) by Muzio Clementi, published in 1773. From that time on composers began to study the peculiarities of the pianoforte and to employ the proper technique. The colossal pianoforte works of Beethoven were destined to revolutionize the manufacture of pianofortes. Many of his pianoforte works were beyond the capabilities of the instrument at that time. Thus he gave a powerful stimulus to piano-builders to increase both the compass and power of the pianoforte. In order to obtain power of tone the *thickness* of the strings had to be increased; to extend the scale the *number* of strings had to be increased. Manufacturers had to devise some frame capable of withstanding this enormous increase of tension. This led to the use of metal. In 1820 Allen and Thom patented a frame consisting of hollow metal tubes with brass and iron plates supported by heavy wooden crossbars. This was soon adopted by the leading manufacturers. Babcock of Boston in 1825 tried a cast-iron frame, and in 1832 Allen produced a frame that combined the string-plate, tension bars, and wrest-plank in one casting. This was still further improved by Chickering in 1837. In 1859 Steinway & Sons of New York added to the metal frame in one casting an agraffe, which is a small metallic support for the string, inserted between the bridge and the string for the purpose of preventing vibration in that part of the string. The same firm introduced also a double overstrung scale, which is obtained by dividing the strings into two sets, so that one set lies diagonally across the other.

Besides the improvements mentioned innumerable others have been and are still being made. From the four-octave instrument of Cristofori with a moderate tension, supported by a wooden sounding board, the modern pianoforte has developed into an instrument of tremendous tone-power with a compass of over seven octaves and a tension amounting to several tons. A modern pianoforte consists of the following parts: (1) The *frame*, now almost universally made of iron cast in a single piece. At the rear end is attached the *string-plate*, into which the strings are fastened. In the front there is the *wrest-plank*, into which the *tuning-pins* are set. Around these is wound the other end of the strings, and by turning these pins the tension of the strings is regulated. (2) The *sounding-board*, a thin piece of wood placed under the strings for the purpose of reinforcing the tone by means of sympathetic vibration. (3) The *strings*, made of steel wire, increasing in length and thickness from the treble to the bass. The lower ones are made heavier by being *overspun*, i.e. wound around with a coil of thin copper wire. For the very lowest tones only one wire is used (A_2-F_2). Then two strings for each tone (G_2-C); above that three

strings. (4) The *action*, the entire mechanism required for propelling the hammers against the strings. This includes the keyboard, a row of keys manipulated by the fingers. The keys corresponding to the natural tones are made of ivory, those corresponding to the chromatically altered tones, of ebony. When a key is pressed down the rear end rises and lifts a rod, called *jack*, which, in turn, throws the *hammer* against the string or strings. At the same time a *damper* is raised. The hammer, having struck the string, falls back immediately and is caught by a *check*, preventing a rebound. But as long as the key is pressed down the damper remains raised and thus allows the string to vibrate freely. (5) The *pedals*, levers pressed down by the feet. (a) The *forte* or *loud* pedal raises all the dampers, so that all the strings struck continue to vibrate even after the keys are released. (b) The *soft* pedal, which either throws all the hammers nearer to the strings, so that the striking distance is diminished by one-half, or shifts the hammers a little to one side, so that only a single string instead of the two or three is struck. (c) Some pianos have a third or *sustaining* pedal which does not raise *all* the dampers, but keeps raised only such as are raised by the keys at the moment this pedal is applied. (d) Recently many upright pianos have been built in which the application of a pedal interposes a strip of felt between the hammers and strings, so that only a very faint sound is produced. This is a great convenience while practicing. (6) The *case*. According to the shape of the case, pianos are classified as grand, square, and upright. The square form is no longer built, although many instruments of that shape are still in use. For use in private homes they have been entirely superseded by the uprights, which latter take up far less room. The grand pianos are built in various sizes, from the full concert grand, 8 feet 10 inches long, to the parlor or baby grand, 6 feet long. The cases are often very elaborately carved or even inlaid. There have been special instruments made that cost \$50,000.

For the sake of completeness, it is necessary to speak briefly about some inventions made in connection with the pianoforte. There is a device for increasing the volume of tone. This is the *æolian attachment*, an arrangement by means of which a current of air is directed against the strings, reinforcing the vibrations and thus causing a considerable increase in the volume and duration of the tone. In 1891 Dr. Eisenmann, of Berlin, invented the *electric piano*. Besides the ordinary hammer-action this instrument has an electro-magnet attached to each string. By pressing down the keys an electric circuit is closed, and the action of the electro-magnets causes a steady vibration of the strings. When the electric action is employed alone, the tone of the piano closely resembles that of the stringed instruments. By means of a special pedal any tone or chord can be sustained at will even after the fingers have left the keys. The electric action or the hammer-action may be employed each separately, or both may be combined. Many ingenious devices have been invented by which the piano can be played automatically, the most successful of which is perhaps the *pianola*. The great advantage of this invention is the control which the player can exercise over expressive interpretation by means of fine dynamic shading

and modifications of tempo. But, like all mechanical contrivances, it has its shortcomings, as the inability to bring out a melody in the middle voices. The idea of dumb keyboards is quite old. The *digitorium* or *dumb piano* is a portable box having five keys supported on springs. The use of it has always been strongly condemned by good musicians. In 1883 Mr. Virgil of New York invented the *Virgil practice clavier*, which is now extensively used and has several points of excellence. It has a complete keyboard. Each key when pressed down gives an audible click. There is a mechanism by means of which the player is enabled to cause a second click upon the release of a key. This is of great advantage in the practice of a legato touch. The performer need only see to it that the two clicks, the one produced by the release of a key, the other by the depression of the next key, coincide exactly. By means of a mechanical adjustment the action can be regulated at will from the very lightest pianoforte touch (2 ounces) up to 20 ounces. If used with judgment this is an excellent device for acquiring strength of the fingers. For exercises of a purely technical nature, the clavier is a valuable help. Some standard works dealing with the history of the pianoforte are: Rimbault, *History of the Pianoforte* (London, 1860); Paul, *Geschichte des Klaviers* (Leipzig, 1868); Gontershausen, *Der Klavierbau* (Frankfort, 1870); Ponsicchi, *Il pianoforte, sua origine e sviluppo* (Florence, 1876); Blüthner and Gretschel, *Lehrbuch des Pianofortebaues* (Weimar, 1886); Spillane, *History of the American Pianoforte* (New York, 1890); Hipkins, *The Pianoforte* (London, 1896); Bie, *A History of the Pianoforte and Pianoforte Players*, trans. from the German (London, 1899). See HARPISCHORD; MONOCHORD; PANTALEON; SPINET; VIRGINAL.

PIARISTS (from Lat. *pious*, pious), or **FATHERS OF THE PIOUS SCHOOLS**. A religious congregation for the education of the poor, founded at Rome at the end of the sixteenth century by Saint Joseph of Calasanza. He was a Spanish priest who, while in Rome, was struck with the imperfect and insufficient character of the education even of the higher classes, and decided to devote himself wholly to the meeting of this want. In 1597 he opened a school, with the assistance of a few like-minded friends, which rapidly increased until, seven years after, it numbered 900 pupils, and in 1613 as many as 1200. In 1617 the associates were recognized as a congregation by Paul V., who warmly approved the work. It spread during the seventeenth century into various European countries, and now numbers some 350 members, principally in Italy, Spain, and America. The general, who is chosen for nine years, resides in Rome, where general chapters are held every six years. The system of education adopted in their schools is very thorough, and in many ways resembles that of the Jesuits, with whom the Piarists have always had some affinity; on the suppression of the Society of Jesus they received many of its members into their ranks.

PIAS'SABA, or **PIAÇABA** (Port. *piassava*, *piacub*, from the native Brazilian name). A remarkable and important vegetable fibre produced by one or more species of South American palms. The greater part is furnished by the coquilla-nut palm (*Attalea funifera*), but Wallace states that

much of it is produced from a species of *Leopoldinia*, which he has named *Leopoldinia piassaba*. This quality is known commercially as Para piassaba. When the leaves decay, the petioles split up into cylindrical, dark-brown hard fibres varying from the thickness of a horsehair to the size of a quill. This material has been widely used in making coarse brushes, particularly those required for street-sweeping machines, for which purpose the coarsest have almost superseded all other kinds. The smaller fibres are used for finer brushes. In Brazil, cables, baskets, hats, and many other articles are made from this fibre. Large quantities are exported.

PIATIGORSK, pyät'-görsk'. A town in Russia. See PYATIGORSK.

PIATRA, pyät'ra. A town of Moldavia, Rumania, situated on the Bistritza, about 55 miles southwest of Jassy (Map: Balkan Peninsula, F 1). It has a large number of churches and monasteries and is an important centre in the lumber trade. Population, in 1901, 17,391.

PIATT, pi'at, DONN (1819-91). An American lawyer and journalist. He was born in Ohio, was educated at Saint Xavier College, Cincinnati, studied law, and was in 1851 elected judge of the common pleas court. During President Pierce's administration he was secretary of the Paris Legation, and for some months was acting chargé d'affaires. He enlisted as a private at the outbreak of the Civil War, and rose to the rank of colonel of volunteers, having served for the greater part of the war as adjutant-general on General Schenck's staff. After the war he was a newspaper correspondent, and founded the *Washington Capital*. His publications include: *Memoirs of the Men Who Saved the Union* (1887); and the poem, *The Lone Grave of the Shenandoah* (1888). Consult Miller, *Life of Donn Piatt* (1893).

PIATT, JOHN JAMES (1835—). An American journalist and poet, born in Milton, Ind. After studies at Capital University and Kenyon College, he was connected with Louisville and Cincinnati journals, and in 1871 was chosen librarian of the House of Representatives. From 1882 to 1893 he served as United States Consul at Cork and Dublin, Ireland. His poems are collected under many titles, among which are: *Poems of Two Friends* (with W. D. Howells, 1860); *The Nests at Washington* (with Mrs. Piatt, 1864); *Poems in Sunshine and Firelight* (1866); *Western Windows* (1869); *Landmarks, and Other Poems* (1871); *Idylls and Lyrics of the Ohio Valley* (1884-88-92); *At the Holy Well* (1887); etc. His prose works are less striking than his description in verse of the sentiments that underlie life in the Middle West.—His wife, SARAH MORGAN (BRYAN), born in Lexington, Ky., August 11, 1836, is known for many volumes of verse. She issued her *Collected Poems* in 1894.

PIAUHY, pē'ou-e'. A State of Northeastern Brazil, bounded on the east by the States of Ceará and Pernambuco, on the south by Bahia, on the northwest by Maranhão (Map: Brazil, J 5). On the Atlantic Ocean, on the north, it has a coast line of less than 10 miles. Area, 116,218 square miles. The surface consists mainly of sparsely wooded tablelands or *campos*, with lowlands in the north and west and along the rivers. There are no forests and the climate is dry and

hot. The chief rivers are the Paranyha and its tributaries. Agriculture is hindered by droughts and the scarcity of population, and the attempts to establish colonies of foreign immigrants have not been successful. Sugar, manioc, tobacco, and grain are raised in quantities hardly sufficient for domestic consumption. Cattle-raising is more extensive. Piauhy contains iron, aluminum, and some silver, but the deposits are not worked to any extent. The population was estimated in 1894 at over 300,000, mostly of mixed race. The capital is Theresina (q.v.), and the chief port is Paranyha.

PIAZZA ARMERINA, pĕ-ăt'sá är'má-rĕ'ná. A town in the Province of Caltanissetta, Sicily, 18 miles southeast of Caltanissetta. It stands on the crest and slopes of an isolated hill on the left bank of the Terranova. It is the residence of many nobles and landowners. The town has a Renaissance cathedral (1517), an old castle now used as a prison, a gymnasium, a seminary, a technical school, a theatre, and a picture gallery. The trade is chiefly in corn, wine, oil, fruits, and nuts. Piazza Armerina was founded by the Greeks. It was destroyed in 1160, but was soon rebuilt. Population (commune), in 1881, 19,591; in 1901, 24,379.

PIAZZA DELLA SIGNORIA, dĕl'lá sé'nyô-rĕ-á. See FLORENCE.

PIAZZA DEL POPOLO, pĕ'pô-lô. See ROME.

PIAZZA DI SPAGNA, spá'nyá. A square in Rome named from the Palazzo di Spagna, the residence of the Spanish ambassador. It is the centre of the foreign colony. Its most noted feature is the famous Spanish steps, leading to the Church of the Trinità de' Monti, and the resort of picturesquely clad artists' models.

PIAZZA NAVONA, ná-vô'ná. The second largest public place of Rome, laid out on the site of the Stadium of Domitian, on the ruins of which the surrounding buildings rest. The piazza, officially called the Circo Agonale, corresponds in size and shape to the ancient stadium, and contains three fountains and an obelisk in honor of Domitian, originally in the circus of Maxentius.

PIAZZA VENEZIA, vá-ná'tsé-á. See ROME.

PIAZZI, pĕ-ăt'sé, GIUSEPPE (1746-1826). An Italian astronomer, born at Ponte. He is known principally for his work at Palermo, where he went in 1781 to take the chair of mathematics, and where he established an observatory, which was put in working order in 1789. The first results of his observations were the corrections of some errors in the estimation of the obliquity of the ecliptic, the aberration of light, the length of the tropical year, and the parallax of various heavenly bodies. These results were published in 1792. On the night of January 1, 1801, he discovered a new planet, the first known of the planetoids (q.v.). Piazzi was able to obtain only a very few observations of it before it passed too near the sun to be visible; from which Gauss (q.v.) was nevertheless able to compute its orbit so that it was again found later in the year. Piazzi named it Ceres, after the ancient goddess of Sicily. In 1803 he published a catalogue of the fixed stars, the result of ten years' observations and far superior to any before published. It was rewarded with a prize from the Institute of France. In 1814 appeared a new and more

complete catalogue, containing 7646 stars, for which he was again rewarded with a prize from the French Institute. This catalogue is now regarded as his work of most lasting value to astronomy; and a new computation of his observations, using modern methods, is now being made. He also made researches into the nature of comets. In 1817 he was called to Naples as chief director of the Government Observatory, where he remained till his death.

PI-BESETH, pĕ-bá'sĕth. See BUBASTIS.

PIBROCH, pĕ-brôk (Gael. *piobaireachd*, art of playing on the bagpipe, from *piobair*, piper, from *piob*, bagpipe + *feair*, OIr. *fer*, man, connected with Lat. *vir*, Lith. *vicjras*, Lett. *vicrs*, Skt. *vira*, Goth. *vair*, AS., OHG., *wer*. man). The highest form of music written for the bagpipe. It consists of a series of variations written on a fundamental theme called *urlar*. These variations (generally three or four in number) increase in difficulty and speed, the last one, *creanluidh*, being a furious *presto*. What renders the notation of pibrochs particularly difficult is the great number of ornaments introduced, so that no definite rhythm can be discovered. A still greater difficulty is encountered because they make use of the eleventh overtone (a tone between *f* and *f#*), and thus cannot be reduced to any scale. Only in comparatively recent times (nineteenth century) has the expression of pibrochs in our notation been attempted. Before that, all music for the bagpipe was taught by a special system, the different tones having such names as *hodroho*, *hananin*, *hiechin*, etc. Niel Macleod published in 1828 at Edinburgh a collection of pibrochs in this peculiar notation. See BAGPIPE.

PICA. See PRINTING.

PICAN'DER. The pseudonym of the German poet Christian Friedrich Henrici (q.v.).

PIC'ARD. A corruption of Beghard. See BEGUINES.

PICARD, pĕ'kär', JEAN (1620-82). A French astronomer. In 1655 he succeeded Cassendi as professor of astronomy in the Collège de France. In 1666 he became a member of the Academy of Sciences. In 1671 he went to Uranienborg, on the island of Hven in the Sound, to determine the latitude and longitude of Tycho Brahe's observatory. The Paris Observatory and the *Connaissance des Temps* were founded by his efforts. He is known especially for his geodetic work in connection with determining by measurement the exact length of a degree of latitude.

PICARD, LOUIS BENOIT (1769-1828). A French dramatist, born in Paris. He began early to write plays, the first of which was *Le badinage dangereux* (1789). In many that he subsequently produced, he was both author and actor, and he had several collaborators. His plays, excellent pictures of the time, are satirical and vivacious, and have animated dialogue. The best include: *Encore des ménechmes* (1791), which made his reputation; *Médiocre et rampant* (1797); *Les marionnettes* (1807); *Les capitulations de conscience* (1809); and *L'intrigant maladroît* (1820). Several of them are printed in his *Théâtre* (8 vols., 1821) and *Théâtre républicain* (1832).

PIC'ARDY (Fr. *Picardie*). Formerly a province of France, now constituting the Department of Somme and parts of the departments of

Pas-de-Calais, Aisne, and Oise. Its principal town was Amiens. In 1167 Philip of Alsace, Count of Flanders, became Count of Picardy. It was acquired by Burgundy in 1435 and was united to France in 1477.

PIC'CADIL'LY. An important London street extending for about a mile between the Haymarket and Hyde Park Corner. One portion of the street contains many handsome shops, while the other is given up to fashionable residences. The name is referred to a kind of lace, fashionable in Queen Elizabeth's time, or to the collars so called during the reign of James I.

PICCINI, or PICCINNI, pè'chè'nè, Niccolò (1728-1800). An Italian composer. He was born in Bari, and studied music with Durante and Leo at the Conservatory of Sant' Onofrio, Naples. After producing a number of operas at Naples he removed to Rome, where he brought out *Allessandro nell' Indie* (1758); *Cecchina zitella, ossia la buona figliuola* (1760), which had an unparalleled success; and *L'Olimpiade* (1761). In 1776 he went to Paris, where Gluck was then the popular composer. Marmontel and others championed Piccini, and for several years a bitter controversy was carried on between the 'Piccinists' and the 'Gluckists.' Marmontel made a modern version of Quinault's drama *Roland*, and Piccini composed an opera on it, which had great success. He also composed *Iphigénie en Tauride*, a subject on which Gluck had also written an opera, *Atys*, and many others. He was professor in the Ecole de Chant (1783-91), was removed, and returned to Naples, where he suffered much annoyance from the espionage of the Government on account of his supposed revolutionary sympathies. Returning to Paris in 1798, he succeeded in obtaining from Bonaparte the inspectorship of music at the National Conservatory, but he did not live to begin the duties of his office. He is of interest to the musical historian, not so much for the quality of his work, or his ability as an artist, as for the important part he played in the overthrow of Logroscino (q.v.), whose buffo operas were then the vogue in Naples; and his own defeat (together with the ideas for which he stood) by Gluck (q.v.). He died at Passy, near Paris.

PICCININO, pè'chè-nè'nò, NICOLA (1375-1444). An Italian soldier, born at Perugia. He entered the band of condottieri led by Braccio da Montone, and after the death of their chief was elected to succeed him. For a short time he served Florence, but in 1425 went over to Filippo Maria Visconti, of Milan. Fighting in his interest, he defeated Carmagnola and the Venetians at Soncino and at Cremona (1431), and at Imola in 1434 gained a victory over the Venetians and Florentines. He captured Bologna in 1438. The city revolted from Piccinino's rule in 1443, and, overcome by reverses and the loss of his son, he died in the next year.

PICCIOLA, pè'chò-là. A pathetic story by Saintine (1836) which attained wide popularity and brought the author a decoration and the Montyon prize. It is the story of a prisoner in the time of Napoleon I., who beguiles the monotony of his confinement by caring for a plant which springs up between the stones of his cell, and which he calls *Picciola* (poor little one). The prisoner's life is saved in sickness by an infu-

sion of the leaves of the plant, which withers and dies after his release.

PIC'COLO (It., small). A flute of small dimensions, having the same compass as the ordinary flute, while the notes all sound an octave higher than their notation. In joyous as well as violent passages this instrument is sometimes very effective in an orchestra. The piccolo is usually made in three keys, C, D \flat , and E \flat , the latter two being used almost exclusively in military music. Piccolo is also the name of an organ stop. See FLUTE.

PICCOLOMINI, pik'kò-lóm'i-nè. The name of an old Italian family, whose ancestors settled at Rome, afterwards removed to Siena, and finally obtained the Duchy of Amalfi. Its most eminent member was **ÆNEAS SYLVIVS PICCOLOMINI**, who became Pope in 1458. (See PIUS II.) The family also gave several cardinals to the Church, and another pope, Pius III. (q.v.).—**OTTAVIO PICCOLOMINI** (1599-1656), first Duke of Amalfi, and fifth in direct descent from Pope Pius II., was a distinguished general in the Thirty Years' War on the Catholic side. He first entered the Spanish military service, and then as captain in a Florentine cavalry regiment aided Emperor Ferdinand II. against the Bohemians. He won distinction as a cavalry leader, served under Wallenstein, and at Lützen (1632) commanded the regiment of cuirassiers that met the last charge of Gustavus Adolphus. Wallenstein confided to him his secret designs against the Emperor; Piccolomini, however, communicated these designs to the Emperor, and after Wallenstein's assassination (1634) received as a reward for his fidelity a part of his estates. He took part in the battle of Nördlingen (1634), and in the following year was sent with a large force to aid the Spaniards in the Netherlands, where the French and Dutch were carrying all before them. Piccolomini speedily drove out the French, but his success against the Dutch was not so marked. In 1640 he was summoned to stay the Swedes, under Baner, who were threatening the hereditary possessions of Austria. He succeeded in checking the invaders in Bohemia and the Palatinate, but was badly beaten, along with the Archduke Leopold, in 1642 at Leipzig by Torstenson. He was now sent to the Netherlands to take command of the Spanish troops, and though the prestige of the Spanish infantry was destroyed by the Duke d'Enghien (the future Condé) at Rocroi (May 19, 1643), Piccolomini was again successful against both the French and Dutch till 1648, when he was anew summoned to Germany to encounter the victorious Swedes. The Peace of Westphalia put an end to the Thirty Years' War soon after. Piccolomini had now attained the rank of field-marshal. In 1650 he was raised to the dignity of a prince of the Empire. The King of Spain conferred upon him the order of the Golden Fleece, and bestowed upon him the Duchy of Amalfi, which had previously belonged to his family. With a fictitious son, Max, Piccolomini figures prominently in Schiller's *Wallenstein*.

PICCOLOMINI, DIE. The second play in Schiller's Wallenstein trilogy, produced in 1799. It represents Wallenstein in the midst of his preparations to make himself master of the throne of Bohemia, and takes its name from the two Italians, Octavio and Max Piccolomini. **Max,**

the son, is the devoted adherent of Wallenstein, while Octavio, the professed friend on whom Wallenstein relies, is in reality employed by the Emperor to watch him. Octavio in *Die Piccolomini* gradually involves Wallenstein in the web which leads to his death in the third tragedy of the series, *Wallenstein's Tod* (q.v.).

PICHEGRU, pèsh'gru', CHARLES (1761-1804). A French revolutionary general. He was born February 16, 1761, at Arbois, in the Department of Jura, and was educated at the college of his native town. He subsequently attended the military academy at Brienne, where he taught mathematics and had Bonaparte as one of his pupils. He entered an artillery regiment in 1783 and was for a short time in America. He was lieutenant when the Revolution broke out. Pichegru became an ardent republican, joined the army of the Rhine, and by his soldierly qualities soon attracted general attention and earned rapid promotion. In 1793 he became general of division and commander of the Army of the Rhine, and, in conjunction with the Army of the Moselle under Hoche, repeatedly defeated the Austrians and established himself securely in the Palatinate. After the arrest of Hoche, his success at the head of the combined Rhine and Moselle armies was not less decided. The rapidity and boldness of his manœuvres when in command of the Army of the North, in 1794, again disconcerted the Allies, and they were compelled to retreat beyond the Meuse. Pichegru completed the conquest of Holland in 1795 and ended a glorious campaign by organizing the Batavian Republic. He next visited Paris, and while there suppressed an insurrection in the suburbs of the city (April 1, 1795); but soon afterwards went to take command of the Army of the Rhine, and for some time displayed his usual skill and energy, crossing the river in the face of the enemy and capturing the fortress of Mannheim. But the state of affairs at Paris, combined with the flattering promises and bribes held out to him by the Prince of Condé, converted Pichegru into a secret partisan of the Bourbons. His inactivity, though prearranged with the Austrian generals, was not suspected till he suffered himself to be defeated at Heidelberg, and retreated, leaving Jourdan (q.v.) without support, thus compelling the latter also to retire. The suspicions of the Directory were confirmed by the seizure of Pichegru's correspondence, and he was immediately superseded by Moreau (q.v.). He then retired to his native town, where he lived till 1797, when he was elected one of the Council of Five Hundred. He soon became its president; but still continuing his intrigues with the Bourbons, he was arrested, and subsequently transported to Cayenne, but escaped in June, 1798, to England. He entered heart and soul into the Bourbon conspiracy along with Cadoudal (q.v.), the two Polignacs, and others, the primary object of which was the assassination of the First Consul. The conspirators secretly reached Paris, and there in 1804 Pichegru attempted to persuade Moreau, who was on bad terms with Napoleon, to join them, but without success. But the plans of the conspirators were soon known to the police, and an intimate friend of Pichegru, with whom he resided, sold the secret of his retreat to the police. Pichegru was suddenly arrested and taken to the Temple prison, February 28, 1804. On April 6 he was found dead in his bed.

The Royalists endeavored to fasten a charge of secret assassination on Napoleon, but it was generally, and probably correctly, believed that Pichegru strangled himself. Consult the biographies by Gassier (Paris, 1814), Pierret (ib., 1826), Vouziers (Dôle, 1870); also Montgaillard, *Mémoire, concernant la trahison de Pichegru* (Paris, 1804); and Daudef, *La conjuration de Pichegru, etc.* (ib., 1901).

PICENUM. One of the ancient divisions of Middle Italy, extending along the Adriatic from the Aesis (now Esino) to below the Vomano (now Vomano) River and bounded on the west by Umbria, Sabinum, and Vestinum. It was anciently inhabited by the Umbrians, who were conquered by the Sabines, under whom the name Picenum was acquired. In 268 the district was reduced by the Romans to the condition of a dependency and many of its inhabitants colonized in the town of Picentia. In Asculum, the old capital of Picentium, in B.C. 91, occurred the outbreak of the war of the Italian Confederacy against Rome. Under Augustus Picenum formed the fifth political region of Italy.

PICHICIAGO. See ARMADILLO and Plate of ANT-EATERS.

PICHINCHA, pé-chèn'chá. A volcano of the western range of the Andes in Ecuador, situated a few miles northwest of Quito (Map: Ecuador, B 3). It is an irregular mass of peaks, the highest of which, Huahua-Pichincha, has an altitude of 15,918 feet. Its crater is over 2000 feet deep; it is dormant, there having been no great eruption since 1660. On its slopes, on May 24, 1822, was fought the battle which secured the independence of the Republic.

PICHLER, pik'lér, ADOLF VON (1819-1900). An Austrian poet and naturalist. He was born at Erl in Tyrol, studied at Innsbruck and Vienna, published his first volume of poems in 1846, and in 1848 fought as an Austrian volunteer in the Italian campaign with great bravery. In 1867 he was appointed professor of mineralogy and geology in the University of Innsbruck. He wrote on the geology of the Alps and of Tyrol, but is better known as the Tyrolean poet, author of *Frühlieder aus Tirol* (1846), *In Lieb' und Hass* (1869; 3d ed. 1900), *Vorwinter* (1885), and *Spätfrüchte* (1896). Valuable autobiographic material is contained in his *Aus den März- und Oktobertagen zu Wien, 1848* (1850), and *Aus dem wälsch-tirolischen Kriege* (1849). Consult Prem, *Adolf von Pichler, der Dichter und Mensch* (Innsbruck, 1901).

PICHLER, KAROLINE (1769-1843). An Austrian novelist, born in Vienna. Her first novels, *Gleichnisse* (1800), *Oliver* (1802), *Leonore* (1804), *Ruth* (1805), possessed slight merit; *Agathokles* (1808), her best work, was meant to disprove the heresies of Gibbon's *Decline of the Roman Empire*. Succeeding novels were chiefly historical in matter, patriotic in purpose, and diffuse in style; e.g. *Die Grafen von Hohenburg* (1811), *Die Belagerung Wiens* (1824), *Die Schweden in Prag* (1827), *Henriette von England* (1832). She also wrote society stories, *Frauenwürde* (1808), *Die Nebenbuhler* (1821), *Zeitbilder* (1840), which, like her autobiographical *Denkwürdigkeiten* (1844), are wearisome. Her works are in 60 vols. (1845).

PICHURIC ACID. See LAURIC ACID.

PICIDÆ, pís'i-dê (Neo-Lat. nom. pl., from Lat. *picus*, woodpecker). The family of woodpeckers (q.v.).

PICK, BERNHARD (1842—). A Lutheran clergyman, born at Kempen, in Prussia. He studied in Berlin and at the Union Theological Seminary, New York City. In 1868 he entered the Presbyterian ministry, and, after having held several pastorates in that Church, he joined the Lutheran denomination in 1844. Besides contributing to the *Cyclopædia of Biblical, Theological, and Ecclesiastical Literature*, the *Cyclopædia of Religious Knowledge*, and many periodicals, his publications include: *Luther as a Hymnist* (1875); *Life of Christ According to Extra-Canonical Sources* (1887); and *The Talmud, What It Is and What It Says About Jesus and the Christians* (1887).

PICKELHERING, pik'el-hä'ring. A stock fool in the drama. The name was probably first assumed in the early part of the seventeenth century by Robert Reynolds, who traveled through Germany with a company of strolling comedians, and created a type which maintained itself until the eighteenth century.

PICK'ENS, ANDREW (1739-1817). An American soldier, born at Paxton, Pa. He removed with his parents to the Waxhaw settlement, S. C., in 1752, and fought in the Cherokee war in 1761 as a volunteer. At the beginning of the Revolutionary War he became captain of a militia company, and by successive promotions soon attained the rank of brigadier-general of South Carolina troops, gaining great distinction as a partisan leader. In 1779 he defeated a superior force of loyalists under General Boyd at Kettle Creek, participated on June 10th in the battle of Stone Ferry, and defeated the Cherokees at Tommassee. He commanded the militia at the battle of Cowpens, January 17, 1781, twice rallying them after they had been driven back, and for his gallantry received a sword from Congress. At the battle of Entaw Springs, September 8, 1781, he was in command of the Carolina militia, and in 1782 forced the Cherokees to relinquish their claim to a large tract of land now included in the State of Georgia. After the war he was a member of the South Carolina Legislature from 1783 to 1794; sat in Congress in 1793-95; was a member of the State Constitutional Convention; became major-general of militia in 1795; and was again in the Legislature in 1801 and 1812. He was commissioner on many occasions to treat with the Indians. His son, ANDREW, a lawyer, was Governor of South Carolina in 1816-18, and died in Mississippi in 1838.

PICKENS, FORT. See FORT PICKENS.

PICKENS, FRANCIS WILKINSON (1805-69). An American statesman and diplomat, born at Togadoo, Saint Paul's Parish, S. C. He studied at South Carolina College, was admitted to the bar in 1829, and three years afterwards was elected to the State Legislature, where he soon became prominent as an advocate of nullification and the doctrine of extreme States' rights. From 1834 until 1844 he was a member of Congress, in 1850-51 a delegate to the Nashville Southern Convention, and in 1854 presiding officer of the South Carolina State Convention, and in 1856 a delegate to the General Democratic Convention in Cincinnati. The next year he was appointed

United States Minister to Russia, but returned to America in 1860, and soon afterwards was elected Governor of South Carolina. He zealously supported the secession movement, and immediately after the passage of the ordinance by the Charleston Convention began to organize an independent government. To this end he demanded the surrender of all Federal property within the borders of the State, and when Major Anderson refused to give up Fort Sumter, began to erect the batteries which afterwards, under the orders of the Confederate Government, caused its reduction.

PICKEREL (double diminutive of *pike*). One of the smaller members of the pike family, Lucidae. The Eastern or pond pickerel, jack, or green pike (*Lucius reticulatus*) is common everywhere east and south of the Allegheny Mountains. In Tennessee and Arkansas it reaches a length of 24 inches and is golden green marked with numerous dark lines and streaks, which are mostly horizontal, and by their junction with one another produce a reticulated appearance. The banded pickerel (*Lucius Americanus*), of the coast streams from Massachusetts to Florida, is 12 inches long and dark green, with about 20 blackish curved bars on the sides. The little pickerel (*Lucius vermiculatus*) occurs throughout the Mississippi Valley, is 12 inches long and very variable in color, with an irregular network of fine curving streaks on the sides. The common pike is also frequently called 'pickerel.' The habits and mode of catching are the same as in the case of the pike (q.v.). See Plate of NEEDLE-FISH, PIKES, ETC., and Colored Plate of AMERICAN GAME FISHES, accompanying article TROUT.

PICKEREL FROG. A small light brown frog (*Rana palustris*) with dark square or oblong brown blotches in two rows on its back, and the head marked by a dark line which runs from the nostril to the eye. This frog dwells in the Eastern United States, especially in mountainous parts, and occurs mainly about springs.

PICK'ERING, CHARLES (1805-78). An American naturalist, grandson of Col. Timothy Pickering, born at Starucca Creek, Pa. He graduated at Harvard in 1823, and at the Medical School three years later. After practicing for some years he was, in 1838, appointed naturalist of the United States Exploring Expedition under the command of Lieut. Charles Wilkes (q.v.). In 1843 he visited Egypt, Arabia, East Africa, and India. He published: *The Races of Man and Their Geographical Distribution* (1848); *The Geographical Distribution of Animals and Plants* (1854); and *The Chronological History of Plants; Man's Record of His Own Existence Illustrated Through Their Names, Uses, and Companionship* (1879).

PICKERING, EDWARD CHARLES (1846—). An American astronomer, born in Boston. He graduated at the Lawrence Scientific School, Harvard, in 1865, and for the next two years was instructor of mathematics there. From 1867 until 1877 he was Thayer professor of physics at the Massachusetts Institute of Technology, but in the latter year he returned to Harvard as professor of astronomy and director of the observatory. At the Institute of Technology in 1869 he established the first physical laboratory for general instruction in the United States, and later, in connection with his work at Harvard, established an

observatory at Arequipa, in Peru. He devoted particular attention to the study of light and the spectra of the stars and published the results of his observations in the *Annals of the Harvard Observatory*. He also wrote *Elements of Physical Manipulation* (1874).

PICKERING, JOHN (1777-1846). An American linguist and lexicographer, son of Timothy Pickering, born in Salem, Mass. He graduated at Harvard in 1796, studied law with Edward Tilgham in Philadelphia, was Secretary of Legation in Lisbon until 1799, and then became private secretary to Rufus King, Minister to England. He practiced law in Salem, Mass., from 1801 to 1827, was City Solicitor of Boston (1827-46), and during his service in the State Legislature took a prominent part in revising the Massachusetts general statutes. He was president of the American Academy of Sciences, first president of the American Oriental Society, an able linguist, and, like his father, particularly interested in the languages of the North American Indians. He wrote *A Uniform Orthography for the Indian Languages* (1820), *Remarks on the Indian Languages of North America* (1836), *Vocabulary of Words and Phrases Supposed to be Peculiar to the United States* (1816), and a *Greek and English Lexicon* (1826; 3d ed. 1846), as well as many monographs on ancient and international law. Consult the biography by his daughter, Mary Orne Pickering (Boston, 1887).

PICKERING, TIMOTHY (1745-1829). An American statesman. He was born at Salem, Mass., July 17, 1745, graduated at Harvard in 1763, and was admitted to the bar in 1768. In 1773 he drafted for the town of Salem a paper entitled *State of the Rights of the Colonists*, and in the following year the memorial of the citizens of Salem to General Gage in regard to the Boston Port Bill. In 1776 he joined the Revolutionary Army and led an Essex County regiment to Tarrytown, N. Y. In the following year he took part in the battles of Brandywine and Germantown, and was appointed a member of the Congressional Board of War. In 1780 he was appointed Quartermaster-General of the army and retained the office until its abolition in 1785. Upon his retirement from the army, he engaged in business in Philadelphia, but two years later removed to the Wyoming Valley and became involved in the disturbances of that region, where he was instrumental in maintaining order and quiet. He settled the territorial disputes between Pennsylvania and the inhabitants of the Wyoming Valley, and organized Luzerne County, which he represented in the Pennsylvania Constitutional Convention of 1789. In 1790 he was commissioned by President Washington to negotiate a treaty with the Six Nations, which he did successfully, and later performed a similar service with the Indians of the Northwest. In 1791 Colonel Pickering was appointed Postmaster-General of the United States, which office he held until 1795, when he was appointed Secretary of War. Pickering signalized his administration by establishing a military school at West Point and by supervising the construction of the frigates *Constitution*, *United States*, and *Constellation*. Upon the resignation of Edmund Randolph near the end of 1795, Colonel Pickering was appointed Secretary of State, which office he held during the remainder of Washington's term and through the great-

er part of Adams's administration. In 1800 he was abruptly removed on account of a serious disagreement with the President growing out of the difficulties with France over the X. Y. Z. correspondence (q.v.). He then retired to his uncleared lands in what is now Susquehanna County, Pa., but was in poor circumstances, and some of his Massachusetts friends prevailed upon him to return to his native State, where in 1802 he became Chief Justice of the Court of Common Pleas. In the following year he was elected to the United States Senate, where he served until 1811. As a member of the House of Representatives he served until 1817, when he refused a renomination and again retired to private life. He died at Salem, January 29, 1829. Pickering wrote numerous political papers, including a *Review of the Correspondence Between John Adams and William Cunningham*. A biography of Colonel Pickering in 4 vols. was published by Octavius Pickering and C. W. Upham (Boston, 1867-73).

PICKERING, WILLIAM (1796-1854). An English publisher. After serving for ten years in a Quaker publishing house in Cornhill, London, he opened a bookshop of his own in Lincoln's Inn Fields (1820). Adding publishing to the business, he subsequently moved to Chancery Lane (1824), and to Piccadilly (1842). For printing he employed the Chiswick Press. About 1830 he adopted the trade-mark of Aldus, the famous Italian printer—an anchor entwined with a dolphin, to which was added the motto, *Aldi Discip. Ang.* Among his notable undertakings were the *Diamond Classics* (a series of delicate volumes in 48mo and 32mo, issued between 1821-31); and reprints of different versions of the Book of Common Prayer, between 1549 and 1662 (6 vols., 1844), the typography of which has probably never been surpassed. Among his sumptuous publications may be cited Walton's *Compleat Angler*, illustrated by Stothard and Inskipp (2 vols., 1836). He also projected the Aldine edition of English poets. After his death the business was carried on by his son, BASIL MONTAGUE PICKERING (1836-78), who, among several reprints, issued a fac-simile of the first edition of *Paradise Lost*. In 1878 the firm came to an end.

PICKET (OF. *piquet*, *piequet*, Fr. *piquet*, peg, diminutive of OF. *picue*, *pieque*, Fr. *pique*, pike, probably from Lat. *spica*, point, ear of grain, tuft of a plant, pin). A military term having several meanings. Specifically it is used as describing a small body of men posted at some point beyond the general line of sentries for the purpose of observing the motions of an enemy, or giving timely notice in case of impending attack. (See OUTPOST.) Formerly, in the British Army the term was applied to a military punishment, in which the culprit was held by the raised arm in such a position that his whole weight fell on one foot, which was supported on a picket with a blunt point. The time the man thus stood was proportioned to the offense. It was a peculiarly inhuman form of punishment, and is now strictly forbidden. In camp, horses are said to be picketed when secured to a picketing rope. Pegs of wood or iron used to secure tent ropes are also called pickets. In all English garrisons and camps a small body of men under a corporal or sergeant, and known as the garrison picket, patrols the lines or city as a disciplinary check on

the troops, and a support to the military police (q.v.). See **ADVANCE GUARD**; **OUTPOST**; **PATROL**.

PICKETING. In labor wars, the practice pursued by trades-unions of stationing outposts near the place of employment where a strike is in progress, for the purpose of dissuading workmen not affiliated with the union from taking service with the employer against whom the contest is being waged. In theory a matter of persuasion, picketing, in strikes where feeling runs high, is apt to assume the form of intimidation against non-union workmen, and as such has come within the cognizance of the police, who, as a rule, have been able to prevent the effective execution of picketing duty by the exercise of the authority vested in them to prevent open disorder and loitering in the public highways. Legally the question is a mooted one, and the real point in most cases that appear before the courts is one of fact as to whether the union watchers have overstepped their right of exercising moral persuasion and have resorted to force. In recent judicial decisions a double trend is apparent. On the one hand, the judges, by a broad use of the power of injunction (q.v.) have declared against any action on the part of strikers partaking of the nature of intimidation. In reaction against this view, some courts have shown a tendency toward permitting the peaceable propaganda of their views on the part of strikers, and where picketing has been carried on by small groups of men, scarcely to be suspected of exercising force against non-union workers, to countenance such action as falling within the legitimate exercise of every man's right to express his views in a peaceable manner. See **STRIKE**.

PICKETT, GEORGE EDWARD (1825-75). An American soldier, born in Richmond, Va. He graduated at West Point in 1846, served in the Mexican War, and was brevetted first lieutenant for gallantry at Contreras and Churubusco, and captain for his conduct at Chapultepec. He became first lieutenant in 1849, and captain in 1855. In 1856, while serving in the Territory of Washington, he occupied San Juan Island and prevented the landing of British troops. He resigned from the Federal Army June 25, 1861, and became major of artillery in the Confederate Army. On July 23d he was made colonel in the provisional army and was assigned to command in the lower Rappahannock. He became brigadier-general on February 28, 1862, and at Seven Pines held his ground stubbornly, though outnumbered. He was seriously wounded at Gaines's Mill, and on his recovery was made major-general, in October, 1862. At Fredericksburg he held the centre of the Confederate line. At Gettysburg his division reached the field on the morning of the third day, July 3d, and formed the centre of the attacking line in the famous assault on Cemetery Ridge. (See **GETTYSBURG**.) In September, 1863, General Pickett was given charge of the Department of North Carolina, and made an unsuccessful demonstration against New Berne in January, 1864. When he returned to Virginia his division recaptured the Confederate lines at Drewry's Bluff in June. He was sent to Lynchburg to oppose Sheridan's cavalry in March, 1865, and was badly defeated at Dinwiddie Court House and Five Forks, but rallied his men and checked the pursuit. After the close of the war

he engaged in business at Richmond, where he died.

PICKING, HENRY FORRY (1840-99). An American naval officer, born in Somerset County, Pa. He graduated at the United States Naval Academy in 1861, and in the Civil War served successively in the North Atlantic Blockading Squadron, the East Gulf Blockading Squadron, and the South Atlantic Blockading Squadron, being promoted to be a lieutenant in July, 1862, and being placed in command of the *Nahant* in 1865. In July, 1866, he was promoted to be lieutenant-commander, and in January, 1875, to be commander. He commanded the *Kearsarge* in 1879-81, was Lighthouse Inspector in 1881-82, and commanded the United States naval force in the Northwestern Lakes in 1887-89. In August, 1889, he was promoted to be captain, in November, 1898, to be commodore, and in March, 1899, to be rear-admiral. He succeeded Rear-Admiral Howison as commandant of the Charlestown Navy Yard on March 25, 1899, and died there in the following September.

PICKLES (from Ger. *pökel*, *bökel*, pickle, brine). Although the term *pickled* is applied to animal substances, such as beef, pork, and fish, preserved in salt, yet pickles are generally understood to be the various kinds of fruits or vegetables preserved in vinegar. The process employed is first to wash the articles intended for pickles in clean cold water, and afterwards to soak them for a few days in a strong solution of salt in water. They are next taken out, and if fruits or roots, dried in a clean cloth; but if vegetables, such as cauliflower, etc., they must be well drained, and then placed in the vessels intended to hold them, a few peppercorns, or any other spice which is suitable, being sprinkled in from time to time. When the vessel is so far filled that it will hold no more, boiling vinegar is poured in until it is quite full, and tightly covered up. Many persons prefer to boil the spices, of whatever kind used, in the vinegar; and some add the vinegar cold to such vegetables or fruits as are of a naturally soft substance, because, except in the case of green walnuts, and one or two other fruits, extreme softness is objectionable in pickles. When the materials to be pickled are naturally green, as in the case of gherkins or small cucumbers, French beans, etc., it is considered very desirable to preserve their color as much as possible; and it is sometimes very successfully accomplished by steeping vine, cabbage, spinach, or parsley leaves in the vinegar, by which their color is imparted through the vinegar to the pickles. But this requires great care and patience, more, indeed, than is generally thought worth applying to it, and dealers consequently resort to very reprehensible methods of coloring their pickles, such as boiling the vinegar in copper vessels, and thereby forming an acetate of copper, which is green; or even directly adding that salt to the pickles. Many serious accidents have resulted from the presence of this poison. Many fruits are preserved by pickling, in which case no salt is used and sugar is added to the vinegar. Pears, plums, and blackberries are particularly palatable when prepared in this way. The principal vegetables commonly preserved by pickling are cauliflowers, cucumbers, gherkins, onions, mushrooms, and nasturtiums. *Piccalilly*, or Indian pickle, is a mixture

of various vegetables, as cucumbers, onions, cauliflower, and of spices, pickled together. *Chouchou* is a mixed pickle to which mustard is added. See FOOD, PRESERVATION OF.

PICKLE WORM, or **PICKLE MOTH**. A moth of the family Pyralidæ (*Diaphania nitidalis*), which occurs abundantly throughout the Southern and Western United States, and lives, in the larval state, in cucumbers, boring into them and destroying them when about half-grown, or at about the stage when they are preferably used for pickles, whence the popular name. It also feeds upon other cucurbitaceous plants, such as the squash, cantaloupe, and melon. The early generation of this insect feeds upon the leaves of the same plants, and there is little doubt that by carefully spraying with arsenicals before the fruit is grown the insect may be held in check.

PICK'NELL, **WILLIAM LAMB** (1852-97). An American landscape and marine painter, born at Hinesburg, Vt. He studied under George Innes at Rome from 1873 to 1875, under Gérôme at Paris in 1875, and under Robert Wylie in Brittany until 1879. He returned to America in 1882, passing his summers at Anquisham, Mass., his winters in England and Southern France. He became a member of the Society of American Artists in 1880, and of the Society of British Artists in 1884. He received medals at Boston (1881 and 1888), and a gold medal at the Paris Salon with his "Morning at the Loing" (1895). He died at Marblehead, Mass. His work is natural and unaffected, and shows a fine feeling for line, brilliant light effects, and rich color, though he also succeeded well with the shimmering mist in his gray marines. His chief works include: "Route de Concarneau" (1880), Coreoran Gallery, Washington; "Borders of the Marsh" (1880), Academy of Fine Arts, Philadelphia; "A Stormy Day" (1891); "Coast of Ipswich" (1882), in the Boston Museum; "Sunshine and Drifting Sand" (1895); "Bleak December" (1887), in the Metropolitan Museum, New York; "A Sultry Day" (1884); "Wintry March" (1885); "November Solitude" (1887); "Among the Olives" (1894); "Midwinter on the Littoral" (1895); "Route de Nice" (1896).

PICKWICK CLUB, **THE POSTHUMOUS PAPERS OF THE**. A novel by Charles Dickens (1837). It was undertaken to accompany a set of comic sketches by Seymour, appearing as a serial in 1836 and 1837, and established Dickens's literary success. A work of humor throughout, giving rather loosely connected accounts of comical characters in many walks of life, linked together by the adventures of the amiable Mr. Pickwick, chairman of the Club of Solemn Stupidity. Mr. Pickwick, with his associates, Tupman, Winkle, and Snodgrass, pursues his investigations in various parts of England, in the course of which he runs across the inimitable Sam Weller, Sam's father, the coachman, the 'shepherd,' Stiggins, the hospitable Mr. Wardle, of Dingley Farm, impecunious Alfred Jingle, and Job Trotter, the 'portable engine,' the buxom Mrs. Bardell, who brings the famous breach of promise suit, Mr. and Mrs. Leo Hunter, and other minor characters.

PICO, pē'kō. One of the Azores Islands (q.v.), belonging to the central group. It is 36 miles long and 4 to 10 miles wide, with an area of 176 square miles. It is traversed by a volcanic

ridge, which rises 7613 feet high in the peak (Pico), whence the name of the island. The chief product is wine. Population, in 1900, 16,626.

PICO DELLA MIRANDOLA, dē'l'la mè-rān'-dō-lā, GIOVANNI, Count (1463-94). An Italian philosopher and theologian. He was born February 24, 1463, the son of the sovereign prince of Mirandola and Concordia. From his fourteenth to his sixteenth year he studied at the University of Bologna, and afterwards visited the principal schools of Italy and France, everywhere distinguishing himself by his extraordinary facility of acquisition. He is said to have known more than twenty languages; he was familiar with the different phases of the scholastic philosophy, and was also versed in mathematics, logic, and physics. At the age of twenty-three he returned to Rome, when Innocent VIII. was pontiff, and immediately sought an opportunity of showing his learning in the most striking manner, by publicly posting up no fewer than 900 theses or propositions in logic, ethics, physics, mathematics, theology, science, and cabalistic magic, drawn from Latin, Greek, Jewish, and Arabic writers, offering to maintain an argument on each against all the scholars of Europe, and undertaking to pay the expenses of those who came from a distance. Pico presumptuously entitled his theses *De Omni Re Scibili* (On Everything that can be Known). Pope Innocent VIII. refused to allow Pico to carry on this discussion, inasmuch as some of his theses were deemed heretical. But Alexander VI. cleared him of the charge of heresy. He died November 17, 1494, at the early age of thirty-one. A complete edition of his works was published at Bologna in 1496; it has since been frequently reprinted. In philosophy Pico was a Neo-Platonist, though his thoughts are tinged with cabalism. Consult: Dreydorff, *Das System des Johannes Pico von Mirandola und Concordia* (Marburg, 1858); *Vita di Giovanni Pico della Mirandola, filosofo platonico* (Florence, 1882); Pater, *Studies in the History of the Renaissance* (London, 1873); also his *Life* by his nephew, translated by T. More (ib., 1890).

PICOT, pē'kō', FRANÇOIS EDOUARD (1786-1868). A French historical painter, born in Paris. He was the pupil of David and Vincent, and won the Prix de Rome in 1813. His works include: "Cupid and Psyche" (1819); "Orestes Sleeping in the Arms of Electra" (1822); an "Annunciation" (1827); and decorative paintings in the Louvre, and in Paris churches. He was awarded a first-class medal at the Salon of 1819, and the cross of the Legion of Honor in 1852. In 1836 he was elected to the Institute.

PICOT, GEORGES (1838-). A French jurist and historian. He was born in Paris, studied law, and in 1865 was appointed judge at the Seine tribunal. In 1877 he received a post in the Ministry of Justice, from which he retired when Grévy became President, to become editor of *Le Parlement*, the organ of the Left Centre. In 1878 he was elected to succeed Thiers in the Academy of Moral and Political Sciences, and in 1896 became its perpetual secretary. Among Picot's writings the chief are: *Recherches sur la mise en liberté sans caution* (1863); *Les élections aux Etats généraux dans les provinces, 1302-1614* (1874); *Histoire des Etats généraux* (1872);

2d ed. 1888), his best work, twice winner of the Gobert prize; *La réforme judiciaire* (1881); *Un devoir social et les logements d'ouvriers* (1855); *Pacification religieuse* (1892); and *Décentralisation et ses différents aspects* (1897).

PICPUS (pék'pus') **SOCIETY**. The name commonly used for a religious community in the Roman Catholic Church officially styled the Congregation of the Sacred Hearts of Jesus and Mary and of the Perpetual Adoration. It was founded in 1805 by Pierre Joseph Condrin and confirmed by Pius VII. in 1817. Its mother house is in the Rue Picpus in Paris, whence the colloquial name. The society devotes itself to missionary work, especially in Eastern Oceania and South America. Consult Keller, *Les congrégations religieuses en France* (Paris, 1880).

PICRIC ACID (from Gk. πικρός, *pikros*, bitter), or **CABAZOTIC ACID**, $C_6H_2(NO_2)_3OH$. One of the first organic dyes that have been prepared by artificial processes. It is derived from carbolic acid, or phenol, by the action of nitric acid, and is therefore called also trinitrocarbolic acid or trinitrophenol. It is best prepared by dissolving carbolic acid in strong sulphuric acid and gradually adding nitric acid; after the violent action has subsided, the mixture is kept for about two hours at a gentle heat, so as to complete the reaction. Picric acid separates out in crystalline form from the solution thus obtained, and may be purified by crystallization from hot water, in which it is moderately soluble. The acid is also formed by the action of nitric acid on many organic products, such as wool, leather, silk, indigo, resins, etc. While it is but sparingly soluble in cold water, it readily dissolves in organic liquids like ordinary alcohol, ether, benzene, etc. Its solutions have a strongly bitter taste and stain the skin as well as wool and silk a bright yellow. Formerly picric acid was much used as a dye. Since vegetable fibres are not colored by it, it may be used to detect cotton mixed in with wool. At present picric acid is used extensively for the manufacture of certain explosives. The acid itself burns quietly if ignited; but its alkali derivatives, the *picrates* of sodium, potassium, and ammonium, explode when heated, with great violence. It is mostly these derivatives of picric acid that are employed in the manufacture of explosives. The explosive known as *melinite*, however, consists mainly of the free acid. Formerly the acid was largely used in the manufacture of smokeless powder. Picric acid is said to have been employed also as a substitute for hops in the manufacture of beer. In France the acid is commonly used as a remedy for burns, as it is believed to prevent the formation of blisters. A small quantity of the acid is dissolved in a little alcohol, and the solution is diluted with a large amount of cold water; the solution is constantly applied to the burned part until the smarting pain has ceased. In organic chemistry picric acid is classed with the phenols, being a benzene derivative containing the hydroxyl group (OH). Unlike most other phenols, however, it is more strongly acid than carbonic acid, from the combinations of which (the carbonates) it is capable of taking away the alkali metals, to form picrates. These strongly acid properties of picric acid (trinitrophenol) are due to the presence of nitro-groups (NO_2) in its molecule.

PICROTOXIN (from Gk. πικρός, *pikros*, bitter + τοξικόν, *toxikon*, poison, originally that in which arrows were dipped, neu. sg. of τοξικός, *toxikos*, relating to a bow, from τόξον, *toxōn*, bow), $C_{30}H_{14}O_{12}$. The active poisonous principle contained in the seeds of *Anamirta paniculata*, which grows in the East Indies. It may be obtained from the seeds by extraction with hot alcohol and may be purified by crystallization. The substance is extremely poisonous, one-third of a grain being sufficient, when introduced into the stomach of a cat, to produce tetanic convulsions and death in a few minutes. It is sometimes used externally as a parasiticide, and internally to check night-sweating in phthisis.

PICTET, pék'tá', **RAOUL** (1842—). A Swiss physicist and chemist. He was born at Geneva and served as professor in the university of that city. He has devoted himself largely to problems involving the production of low temperatures and the liquefaction and solidification of gases. (See LIQUEFACTION OF GASES.) By using extreme cold and pressure he ascertained in 1877 that oxygen, nitrogen, and hydrogen could be liquefied, making this discovery about the same time as Cailletet (q.v.) in Paris, who employed an altogether different method. Pictet is the author of *Mémoire sur la liquéfaction de l'oxygène, la liquéfaction et la solidification de l'hydrogène et sur les théories des changements des corps* (1878); *Synthèse de la chaleur* (1879); *Nouvelles machines frigorifiques basées sur l'emploi de phénomènes physicochimiques* (1895); *Etude critique du matérialisme et du spiritualisme par la physique expérimentale* (1896); *L'acétylène* (1896); and *Le carbide* (1896).

PIC'TON, Sir **THOMAS** (1758-1815). A British general, born at Poyston, Pembrokeshire. In 1794 he went to the West Indies. He distinguished himself in the taking of Saint Lucia and Saint Vincent from the French, and Trinidad from the Spaniards, and was made military Governor of Trinidad in 1797. He restored order there, and made many improvements, and in 1801 was made brigadier-general and Civil Governor of the island. The severity of his rule caused complaint and he was superseded in 1803, but was made commandant at Tobago. He was recalled to England to answer charges against his Trinidad administration, but was honorably acquitted and as major-general (1808) went to serve at Flushing. He commanded the Third Division under Wellington, and was with him throughout the Peninsular campaigns, and fought in all the leading battles. He was promoted to the rank of lieutenant-general in 1813, joined Wellington again in the Netherlands, and was killed in the battle of Waterloo, while leading his brigade.

PICTONES, pik'tōn-ēz, or **PICTA'VI**. An ancient tribe in Gaul whose name survives in Poitiers, the capital of the Department of Vienne. They are mentioned by Cæsar with the Senones, Parisii, Carduci, Turones, Auleri, and Lemovici in the combination against the Romans organized by Vercingetorix. The chief interest in them is the belief that they were Iberians and probably blood kindred of the Picts in Scotland. On the strength of this connection and resemblance in physical characteristics, Rhys, an eminent authority, applies the title Ibero-

Pictish to the pre-Celtic longheads in Britain. In Cæsar's time the language of the Pictones was Gaulish, but originally they spoke Iberian. Consult Keane, *Man: Past and Present* (Cambridge, 1899).

PICTOU, pik-tōō'. The capital of Pictou County and a port of entry on the north coast of Nova Scotia, Canada, 84 miles north-northeast of Halifax (Map: Nova Scotia, G 4). It stands in a fertile and well-cultivated district, with extensive coal mines and quarries of building stone in the vicinity, and is the terminus of a branch of the Interecolonial Railway. It has a safe and well-equipped harbor and exports large quantities of coal, building stone, dried fish, and potatoes. An important lobster culture establishment is maintained here. The chief building is the Pictou Academy, founded in 1818. The town dates from 1763, and replaced an Indian village. The United States is represented by a consular agent. Population, in 1891, 2998; in 1901, 3235.

PICTS. An ancient people of the Stone Age (Long Barrow Period) inhabiting the whole of Great Britain. They were dolichocephalic and of rather low stature (5 feet 5 inches), dark in complexion, and are supposed to have been Iberians or, according to Sergi, longheaded Mediterraneans from Africa speaking Celtic. They were supplanted or incorporated by the succeeding Teutonic invasions in the primitive period of the English nation. The name originated from the custom of the Picts of staining or tattooing the skin. It is pretty generally agreed by scholars that the Southern Welsh, the *Firbolg* (q.v.) of Western Ireland, and perhaps the short and dark remnants in Scotland represent survivals of the Picts. The language is not only extinct, but has left no literature and only scant traces in place names. Concerning their history nothing definite is known until A.D. 297, when we find the name *Picti* used by the orator Eumenius. They called themselves *Cruithnigh* (q.v.) and occupied at that period the north and the centre of the Highlands. The Romans waged continuous war with the Picts and built large walls to keep them out of the conquered provinces. The Saxons at first did not come into contact with this race, but as they pushed farther northward they also encountered the Picts, and in 685 were defeated by their King Brude. After this a continuous border warfare was carried on with varying results. Gradually the Picts were converted to Christianity, and their King Angus MacFergus (731-761) ruled over the whole of Scotland. Soon thereafter this race disappeared as a separate entity, and in the middle of the ninth century Kenneth MacAlpine, as King of the Scots, ruled over all the different races. It must be stated that concerning nearly everything which pertains to the Picts long disputes have been carried on by scholars. Consult: Skene, *Celtic Scotland* (3 vols., Edinburgh, 1876-80); Innes, *A Critical Essay on the Ancient Inhabitants of the Northern Parts of Britain or Scotland* (Edinburgh, 1885); MacRitchie, "Modern Views of the Picts," in *The Monthly Review*, vol. ii. (London, 1901).

PICTS' HOUSES. The small stone houses built underground in Scotland probably as places of concealment during wars or other dangers, and the chambered tumuli found in the north of the British Isles, of which Mousa and Maeshow,

in the Orkneys, are types. In popular tradition they have been attributed to the Picts.

PICTURED ROCKS. A series of sandstone cliffs 300 feet in height, stretching for five miles along the shore of Lake Superior, about 45 miles east of Marquette. They present a remarkable variety of form and color, and are diversified by a number of waterfalls. The wigwam of Nokomis or Hiawatha stood on the site of Munising Harbor.

PICTURES, RESTORATION OF. See RESTORATION OF PAINTINGS.

PICTURE-WRITING. See HIEROGLYPHICS.

PICUDA, pi-kōō'dā. The largest and most voracious of the barracudas (q.v.), of which several species inhabit the American tropical seas. The great barracuda, 'picuda,' or 'becuna' (*Sphyræna picuda*) reaches a length of 6 feet, and is highly valued as food. It is silvery in color, with dark blotches along the sides, and some inky spots. Other species are known as 'piendilla,' 'guaguanche,' 'spet,' etc., and the larger ones are sometimes dangerous to bathers, attacking them as fiercely as a shark.

PICULET (diminutive of *picule*, from Lat. *picus*, woodpecker). Any one of a group of about thirty species of tropical birds, which form a subfamily (Picumminæ) of woodpeckers. They are small, plainly colored, usually marked with black, and with red or yellow on the head, and differ from typical woodpeckers in having short rounded tails without spinous shaft-tips, and the nostrils hidden by bristles. Most of them are Central and South American birds. See Plate of WOODPECKERS.

PI'CUS. A legendary king of Lavinium, father of Faunus and grandfather of Latinus. He was gifted with prophecy, a warrior and statesman. Because he aroused the jealousy of the sorceress Circe, she changed him to a woodpecker (Lat. *picus*). The whole story is late and may have arisen from a folk-tale about the bird sacred to the great god Mars.

PIDDIG, pè-dég'. A town of Northern Luzon, Philippines, in the Province of Ilocos Norte. It is situated on the Guisi River, 8 miles east of Laoag (Map: Philippine Islands, E 1). Population, 10,840.

PIDDOCK (of uncertain etymology). A bivalve mollusk of the genus *Pholas*, related to the ship-worms (q.v.). The shell is thin, white, and very hard, and beset with calcareous inequalities, connected by fine transverse parallel ridges, forming a kind of rasp, used by the animal for boring a hole, in rock, wood, or other substances in which it lives. The animal itself is club-shaped, with large, long siphons, united almost to the end, and a short foot. The shell is two or three inches in length, gaping at both ends and provided with two accessory valves. The siphons are two or three times as long as the shell and are extended to the opening of the hole in which the animal lives. Several species occur on the eastern coast of America, living buried in mud or clay. The commonest species is *Pholas truncata*, which lives in clay or peat banks between tides, and burrows into them to a depth of a foot or more. A larger and finer species is *Pholas costata*, found only in deep water. Two or three species are used in Great Britain for bait and

for food. In boring its hole, the piddock fixes itself firmly by its foot, and works itself from side to side, making use thus of the rasping power of its shell. See Colored Plate of CLAMS AND EDIBLE MUSSELS.

PIDGIN (Chinese corruption of Eng. *business*), or PIGEON ENGLISH. A mixed language much in use in the ports of China, as a medium of oral communication between foreigners who cannot speak Chinese (merchants, sea-captains, sailors, etc.) and such Chinese servants, shopkeepers, compradores, boatmen, etc., as they may have to converse with. It is also occasionally used by natives from different ports whose own dialects are so different as to be mutually unintelligible. It consists of a mixture of English words, mostly monosyllabic, with corrupted Chinese, Portuguese, Malay, and other terms and expressions, arranged according to Chinese idiom. These words are "uninflected" except to the extent that vowel-endings such as *o* or *ee* are frequently added after certain consonants which the Chinese in common with the Japanese are unable to pronounce without a following vowel; for example: *washee* for *wash*; *largee* for *large*; *s'posce* for *suppose*; *wifo* for *wife*. Owing to the inability of the Chinese to pronounce initial *r*, *l* takes its place, and 'rice' becomes *licc*; 'American' becomes *Melican*; 'friend' becomes *flew*, and 'try' becomes *tli*. Among the corrupted Chinese words are *bobbyery*, noise, disturbance, abuse, scold, either noun or verb, as "you makee too muchee bobbyery;" "howe fashion you bobbyery my?" *Chop* is a mark, brand, or device; *chop-chop* means quick! make haste! and the same *chop* occurs in *chop-sticks* or 'hasteners' used in eating. *Chow-chow* means food or eat; and *maskee* (probably of Malay or Portuguese origin), never mind! no matter! *Belong* takes the place of *be*; *my* is equivalent to I, me, my, mine ("no belong my" = I didn't do it, or it is not mine). *Sarey* means know; 'not' is replaced by *no*, and the opening sentence of Hamlet's famous soliloquy, "To be or not to be! That is the question," is simply rendered by "Can do no can do! Howe fashion?" *Joss-pidgin* means religious ceremony, and *Joss-pidgin man*, a priest, clergyman, or missionary. In the same way a tourist or sightseer becomes a 'look-see man,' and *get* is expressed by *catchee*. Consult Leutner, *Wörterbuch der englischen Volkssprache Australiens und der englischen Mischsprachen* (Halle, 1891).

PIDGIN, CHARLES FELTON (1844—). An American writer, statistician, and inventor, born in Roxbury, Mass. He received an academic education, was in the mercantile business in Boston from 1863 to 1873, and in June of the latter year became chief clerk of the Massachusetts Bureau of Statistics of Labor. Among many other machines and appliances for the mechanical tabulation of statistics, he invented an electrical adding and multiplying machine, an addition register, a self-counting tally sheet, and automatic multiple tabulating machine. He wrote the librettos for a number of musical comedies, and cantatas, and the words for more than sixty songs, and, in addition to many magazine articles, published: *Practical Statistics; or the Statistician at Work* (1888); and the novels, *Quincy Adams Sawyer and Mason's Corner Folks* (1900), and *Blennerhasset; or the Decrees of Fate* (1901).

PIEDMONT, pēd'mōnt (It. *Piemonte*, country at the foot of the mountains). A compartment of the Italian kingdom embracing the provinces of Turin, Cuneo, Alessandria, and Novara, and bounded by Switzerland, France, Liguria, and Lombardy. In 1247 a partition of the territories of Savoy (q.v.) led to the establishment of the two related lines of Savoy and Piedmont. The rulers of the second line were made princes of the Empire in the early part of the fourteenth century. In 1418 the dynasty became extinct and the land reverted to Savoy. From 1797 to 1814 it was a part of France. It constituted the principal part of the former Kingdom of Sardinia (q.v.), which was not infrequently spoken of as the Kingdom of Piedmont. See ITALY.

PIEDMONT PLAIN. A name used in the physiography of the United States to designate that part of the Atlantic coast plain which lies between the Appalachian highland and the low coastal plain proper. It is distinguished from the latter topographically by being more rugged and eroded with deeper river-valleys, and geologically by consisting of much older and harder rock strata. The change from the hard to the soft and recent formation is marked by a definite line of escarpments over which nearly all the Atlantic rivers fall in rapids or cataracts, and the line is known as the 'fall line.' The Piedmont Plain is less defined in New England than in the Southern States. It is narrowest and also approaches closest to the sea in New York, and broadens southward, being about 300 miles wide in North Carolina.

PIED PIPER OF HAMELIN, THE. A poem by Robert Browning (1842), written for a child of Maeready, the actor, on the old legend of the piper who agreed to rid the town of rats in 1284, and, because he was not paid, lured the children of Hamelin by his playing to a cave in the mountain, where they disappeared.

PIE'GAN. One of the most interesting of the Algonquian tribes in North America. They are associated with the Siksika and the Kino or Bloods in the so-called Siksika confederacy, and over two thousand of them are on the Blackfeet agency in northwestern Montana. They are well disposed and tractable, and crimes are almost unknown among them. The other members of the confederacy extend northward into Canada, where they join their co-linguists, the Creeks (q.v.), to form the westernmost tribes of the most widely diffused language family in the Western Hemisphere.

PIEHL, Pēl, KARL (1853—). A Swedish Egyptologist, born at Stockholm. He was docent in Egyptian languages at Upsala in 1881, became director of the Egyptian Museum in 1889, and in 1893 was appointed to a newly endowed chair of Egyptology. Three years afterwards Piehl became editor of the *Sphinx*, a periodical of Egyptian archaeology. His publications include: *Petites études égyptologiques* (1881); *Dictionnaire du papyrus Harris No. 1* (1882); and the great work, *Inscriptions hiéroglyphiques* (1884 sqq.).

PIENZA, pē-én'tsā. A town in the Province of Siena, Italy, 25 miles southeast of Siena. It is interesting because of the extant examples of early Renaissance architecture. The chief of

these are the cathedral, with an ecclesiastical museum attached, the *Palazzo Pubblico*, and the *Palazzo Piccolomini*. Population (commune), in 1901, 3864.

PIEPOWDER, COURTS OF (also *piepoudre*, *piepoudre*, from OF. *piepoudreux*, peddler, dusty foot, from *pie*, foot + *poudre*, powder, dust). Inferior courts in England, which formerly had special jurisdiction for the speedy trial controversies arising at fairs, markets, etc. The French name was probably applied to the court because most of the litigants were peddlers and tradesmen who traveled from one fair to another—persons with 'dusty feet.' Its jurisdiction was extended in some counties to include whole villages. This court has fallen into disuse, though it seems it has not been expressly abolished in some countries.

PIER. See BRIDGE; FOUNDATION; DOCK; WHARF; HARBOR.

PIERCE, pērs, FRANKLIN (1804-69). The fourteenth President of the United States. He was the son of Gen. Benjamin Pierce, a soldier of the Revolution and twice Governor of New Hampshire, and was born at Hillsborough, N. H., on November 23, 1804. He graduated at Bowdoin College in 1824, having among his college mates Nathaniel Hawthorne, John P. Hale, S. S. Prentiss, and Longfellow. After leaving college he studied law in the law office of United States Senator Levi Woodbury, and also in offices at Northampton, Mass., and at Amherst, N. H., and was admitted to the bar in 1827. Two years later he was elected to a seat in the State Legislature as a Democrat. He was thrice reelected and for two terms served as Speaker of the House of Representatives. In 1832 he was elected to a seat in the Lower House of Congress, and was reelected in 1834. In 1837 he was elected to the United States Senate, and when he took his seat enjoyed the distinction of being the youngest member of that body. As a member of Congress he supported by his speeches and votes the policy of President Jackson. He opposed appropriations for the Military Academy at West Point, the renewal of the United States Bank charter, and the policy of internal improvements, and was averse to the spoils system. Among his colleagues in the Senate were Benton, Clay, Calhoun, Webster, Woodbury, and Wright, in comparison with whom Pierce was not a distinguished figure, although his service was marked by industry and faithfulness to duty. In 1842, before the expiration of his term as Senator, he resigned and resumed his law practice, settling in Concord, N. H. He successively declined an appointment to fill a vacancy in the Senate, refused the nomination for Governor of New Hampshire, and would not accept the office of Attorney-General of the United States tendered by President Polk, and announced it as his fixed purpose never again to accept public office. He did not, however, cease to take interest in public affairs, and during his retirement took an active part in the councils of his party, openly advocated the annexation of Texas, and took the stump against his former college mate, John P. Hale (q.v.), the successful anti-slavery candidate for the United States Senate. Upon the outbreak of the Mexican War, Pierce promptly volunteered as a private soldier. He was soon appointed colonel, and in March, 1847, received a commission from

the President as brigadier-general of volunteers. He at once sailed for Vera Cruz and joined General Scott in time to participate in the battles of Contreras and Churubusco. In the former engagement he was thrown from his horse, but, although painfully injured, refused to leave the field. Upon the conclusion of peace he resumed his law practice, which was again interrupted in 1850 by his election as a delegate to the New Hampshire Constitutional Convention, over whose deliberations he was chosen to preside by an almost unanimous vote. At the Democratic National Convention, held at Baltimore in June, 1852, he was brought forward, after thirty-five ballottings, as a compromise candidate for the Presidency, and was nominated on the forty-ninth ballot, defeating Buchanan, Douglas, Cass, and Marey. On account of his personal popularity, and his conservative position with regard to the slavery question, General Pierce was able to draw to his support a large number of voters in the North, among them many Whigs, and consequently defeated General Scott, the Whig candidate, by a vote of 254 to 42. He carried every State except Massachusetts, Vermont, Kentucky, and Tennessee, and received a larger electoral vote than had ever before been cast for a Presidential candidate. He chose a Cabinet of able and distinguished men to aid him. This Cabinet was the only one in the history of the country that did not suffer a break during the Presidential term. The chief events of Pierce's administration were the Gadsden Purchase (q.v.), the Koszta affair (q.v.), the conclusion of commercial treaties with Great Britain and Japan, the bombardment of Greytown, Nicaragua, the reorganization of the diplomatic and consular service, and the creation of a United States court of claims. As regards the slavery question, the policy of President Pierce caused much discontent in the North. The chief events under this head were the promulgation of the Ostend Manifesto (q.v.) and the enactment of the Kansas-Nebraska Bill (q.v.), which brought on strife between the pro-slavery and free-State settlers in Kansas. From 1855 to the end of Pierce's term the sole problem of importance was that of governing Kansas and maintaining peace therein—a problem in the management of which the President did not add to his distinction. Upon the expiration of his term Pierce traveled for several years in Europe, taking no further part in politics. As an advocate at the bar, Pierce was excelled by few. Two 'campaign' biographies of Pierce were published in 1852, written by Nathaniel Hawthorne (Boston) and D. W. Bartlett (Auburn). Consult, also, Carroll, *Review of Pierce's Administration* (Boston, 1856); and Rhodes, *A History of the United States from the Compromise of 1850* (New York, 1901). See UNITED STATES.

PIERCE, GEORGE FOSTER (1811-84). A bishop of the Methodist Episcopal Church, South. He was born in Green County, Ga., the son of Lovick Pierce (q.v.). He studied law, but entered the Georgia Conference (1831). He was president of Georgia Female College, Macon, 1839-42; president of Emory College, Oxford, Ga., 1849-54; elected bishop, 1854. His sermons and addresses were edited and published by Bishop A. G. Haygood (1886). He was considered one of the ablest preachers of his Church. Consult his *Life* by George G. Smith (1888).

PIERCE, Lovick (1785-1879). A minister of the Methodist Episcopal Church, South. He was born in Halifax County, N. C.; entered the South Carolina Conference in 1805, though he began to preach the year before; he was chaplain in the army during the War of 1812; at the close of the war he retired from the ministry and studied and practiced medicine. In 1823 he reëntered the ministry and filled the chief appointments of the Church; he represented his conference in numerous general conferences. He was known as one of the most eloquent preachers of his time.

PIERIDÆ. A family of butterflies noted for mimicry. See MIMICRY.

PIERIDES, pi-ēr't-dēz (Lat., from Gk. *πριίδες*). (1) A name given the Muses from their birth-place, Pieria in Thessaly. (2) According to late mythology the nine daughters of Pierus, King of Enathlia, whom he named after the nine Muses. When they were defeated by the Muses in a musical contest, they were changed into magpies.

PIERNÉ, pyār'ná', GABRIEL (1863-). A French organist and composer, born at Metz. He was graduated at the Paris Conservatory, where he won many important prizes, including the Prix de Rome in 1882. He became organist at Sainte Clothilde in 1890, succeeding César Franck, and subsequently devoted himself largely to composition. He produced several operas (notably a four-act opera *Izél*, 1894), all of which are highly regarded.

PIERO DELLA FRANCESCA, pyār'ró dē'lá frán-chēs'ká. An Italian painter. See FRANCESCA, PIERO DELLA.

PIERO DI CASIMO, dē ká'sé-mò (1462-1521). An Italian painter of the Florentine school. He was born in Florence and was a pupil of Casimo Rosselli, from whom he derived his name and whom he assisted in painting the frescoes in the Sistine Chapel. Afterwards the influence of Leonardo da Vinci becomes apparent in his works, of which "Perseus Delivering Andromeda" (Uffizi, Florence), "Holy Family" (Dresden), "Venus with Cupid and Mars" (Berlin), "Coronation of the Virgin" (Louvre), and "Death of Procris" (National Gallery, London) are the most remarkable. A special feature of his pictures is the fine landscape backgrounds. He was the first master of Andrea del Sarto. For his biography, consult Knapp (Halle, 1899).

PIEROLA, pē'á-rō'lá, NICHOLAS DE (1839-). A Peruvian politician, born at Camaná. He was educated for the law and served as Minister of Finance during Balta's administration (1869-72). He was implicated in the revolts against Prado in 1874 and 1877, and when, in the war with Chile, Prado deserted his post, Pierola assumed the leadership of the Revolution, and was proclaimed supreme chief at Lima, in the closing days of 1879. In 1881 he was defeated and obliged to retire into the interior. Four years later he made an unsuccessful attempt to seize the Presidency, and was banished in consequence. In 1894 he headed another revolt, overthrew President Cáceres, was himself elected President in 1895, and held the office until the expiration of his term, September 10, 1899.

PIER/PONT, FRANCIS HARRISON (1814-99). An American political leader, born in Monon-

galia County, Va. (now West Virginia). He supported himself while studying and graduated at Alleghany College (Pennsylvania) in 1839. He began the practice of law at Fairmount, Va., about 1845. He was a pronounced abolitionist, and was an elector on the Whig ticket in 1848. After Virginia seceded, representatives from 40 western counties met in convention at Wheeling June 11, 1861, organized the 'Restored Government of Virginia,' and elected him Governor. He was recognized by President Lincoln and raised troops for the Federal Army. In the fall he was elected by the loyal people for the unexpired term of two years, and then for a full term of four years. When West Virginia was admitted to the Union as a separate State in June, 1863, he removed his capital to Alexandria, under the protection of the Federal Army. When Richmond was evacuated he removed there, and acted as Governor of the entire State until 1868. He then returned to Fairmount and sat in the West Virginia Legislature in 1870. President Garfield appointed him collector of internal revenue, in which capacity he served until the consolidation of his district.

PIERPONT, JOHN (1785-1866). An American poet. He was born in Litchfield, Conn., April 6, 1785, and graduated from Yale College in 1804, after which he taught school for a few years. He then studied law and practiced at Newburyport, Mass. After unsuccessful business ventures in Boston and Baltimore, he studied theology in the Harvard Divinity School, and in 1819 was ordained over the Hollis Street Congregational (Unitarian) Church in Boston. His advocacy of anti-slavery, temperance, and other reforms caused his withdrawal from that parish in 1845, after which he became pastor of the Unitarian Church at Troy, N. Y., and of the First Church (Unitarian) at Medford, Mass. During the Civil War he was appointed, though seventy-six years old, as chaplain of a Massachusetts regiment, but was soon transferred to the United States Treasury Department, where he remained till his death at Medford, Mass., August 26, 1866. He published, among other volumes: *Airs of Palestine* (1816; republished and enlarged as *Airs of Palestine, and Other Poems* in 1840) and *Anti-Slavery Poems* (1843). Some lines on his dead son are also notable for their pathos. He was a genuine poet, though his work is rather slight.

PIERRE, pēr. A city, the county-seat of Hughes County and the capital of South Dakota; situated near the centre of the State, on the Missouri River, and on the Chicago and Northwestern Railroad (Map: South Dakota, E 5). It has a Government industrial school for Indians, and is the commercial metropolis of an extensive stock-raising and farming district. It is the largest stock market in the State, the annual shipments of cattle averaging 1000 cars. Underlying the city are supplies of natural gas, which is used for lighting and heating and for industrial purposes. Pierre was settled in 1880, and incorporated three years later. It is governed under a charter of 1900, which provides for a mayor, elected biennially, and a council. The water-works, gas plant, and electric light plant are owned by the municipality. Population, in 1890, 3233; in 1900, 2306.

PIERREPONT, pēr'pōnt, EDWARDS (1817-92). An American lawyer and diplomat, born at

North Haven, Conn. He graduated at Yale in 1837, was admitted to the bar in 1840, and practiced at Columbus, Ohio, until 1845, when he removed to New York. He was elected judge of the Superior Court, New York, in 1857, but resigned in 1860, and resumed his practice. In 1867 he conducted the case for the Government against John H. Surratt, indicted as an accomplice in the murder of President Lincoln, and in 1869 he was appointed United States District Attorney by President Grant, but resigned a year later, when he took an active part as one of the Committee of Seventy in fighting the Tweed ring. He was appointed Attorney-General of the United States in 1875, and the next year Minister to the Court of Saint James's, which post he resigned in 1877. During his later years he took a keen interest in finance, and published several pamphlets dealing with financial questions.

PIERROT, pyá'ró'. A character of French comedy taken over from the Italian Pedrolino of the *commedia dell' arte*. Toward the beginning of the eighteenth century he appeared on the French stage in parodies at the Opéra Comique and other theatres. The Pierrot of the pantomime was introduced by Debureau at the Funambules, and reappeared with the revival of the pantomime at the end of the nineteenth century. Pierrot's costume consists of very wide trousers, a loose coat with great buttons, and a wide collar, all white.

PIERSON, pēr'son, ABRAHAM (c.1645-1707). An American educator. He was born probably at Southampton, Long Island, N. Y., graduated at Harvard in 1668, became colleague pastor with his father at Newark in 1672, and was in sole charge of the New Church from 1678 to 1692. He then preached for two years in Greenwich, Conn., became pastor at Killingworth, Conn., in 1694, and from 1701 until his death was the first president, or rector, of Yale College. See YALE UNIVERSITY.

PIERSON, ARTHUR TAPPAN (1837—). An American Presbyterian minister, born in New York City. He graduated at Hamilton College in 1857, was pastor of Congregational churches at West Winsted, Conn., in 1859-60, at Binghamton, N. Y., in 1860-63, and at Norwalk, Conn., in 1863. In the latter year he became a Presbyterian; thereafter had charge of churches of that denomination at Waterford, N. Y. (1863-69), Detroit, Mich. (1869-82), Indianapolis (1882-83), and Philadelphia (1883-91). He occupied the pulpit in the Metropolitan Tabernacle, London, in 1891-93. He was made editor of *The Missionary Review of the World* when it was founded in 1888. His publications include: *Many Infallible Proofs* (1886); *Crisis of Missions* (1886); *Divine Enterprise of Missions* (1891); *Miracles of Missions* (1891); and *New Acts of the Apostles* (1894).

PIERSON, HENRY HUGO (1815-73). An English musician and composer, born at Oxford. His correct name was Henry Hugh Pearson. He was educated at Harrow and Cambridge, and before his graduation (1830) had set to music half a dozen of Byron's songs. Forsaking the study of medicine for that of music, he went to Germany (1839), where he became a pupil of Reissiger, Tomaschek, and Rinck, the organist.

He returned to Great Britain (1844) to be Reid professor of music in Edinburgh University, but shortly went back to make his home in Germany, where the greater number of his works were produced, though the best of them, the oratorio *Jerusalem*, was first sung at the Norwich Festival of 1852. Two years afterwards he received the gold medal of art and science from the Belgian King for his musical setting to *Faust* (part ii.), while his five-act opera *Contarini* was performed at Hamburg the year before his death, which occurred in his Leipzig home. Besides his first operas, *Der Elfensieg* (Brünn, 1845) and *Leila* (Hamburg, 1848), he left an unfinished oratorio, called *Hezekiah*, and several fine overtures, songs, and choruses, sacred and secular, of which only *Ye Mariners of England* gained favor in his native land.

PIERS PLOWMAN. See LANGLAND, WILLIAM.

PIERS PLOWMAN'S CREDE. An alliterative poem, written about 1394 by an unknown poet whom Skeat identifies with the author of the *Plowman's Tale*. An ignorant man, wanting to learn his creed, applies to friars for help. They merely show their greed and jealousy of one another, and the creed is taught at last by a poor plowman.

PIETAS (Lat., piety). In Roman mythology, the goddess of loyalty, especially of filial devotion. She is symbolized by the stork.

PIETER DE KEMPENEER, pē'tēr de kēm'-pe-nār. The name of the Flemish-Spanish painter Pedro Campaña (q.v.).

PIETERMARITZBURG, pē'tēr-mā'rīts-bōrg. The capital of the British colony of Natal, South Africa, 40 miles by rail, northwest of Durban, the chief port of the colony (Map: Africa, H 7). It is a well-built town, situated 2200 feet above sea-level, and is noted for its healthful climate. It has considerable trade, and is the seat of an Anglican bishop. Its chief features are the Government buildings, town hall, a fine park, botanical gardens, and bathing establishments; it has electric lighting. The town was founded by the Boers in 1839, and named after the two Boer leaders Pieter Retief and Geert Maritz. Population, in 1901, 30,000.

PIETISM (from piety. OF. *piete*, Fr. *piété*, from Lat. *pietas*, piety, from *pius*, pious). A name given in the latter part of the seventeenth century to a religious movement in Germany, distinguished by certain peculiarities of religious opinion and the manner in which these were manifested. The name is also applied to similar tendencies of opinion, feeling, and conduct exhibited elsewhere. Pietism may be regarded as an exaltation of the importance of religious feeling and of the practical part of religion, with a corresponding depreciation of doctrinal differences, and a contempt for outward ecclesiastical arrangements.

German Pietism was the natural outcome of conditions existing in the seventeenth century. The Reformers had emphasized the efficacy of faith in Christ as the means of securing deliverance from sin. But the controversies which arose among them and increased among their successors gradually gave a too exclusively doctrinal and polemical character to the sermons and writings of both Lutheran and Calvinistic

divines. When the inevitable reaction came it took form in favor of a religion of feeling and good works, or of the heart and life. Johann Arndt (1555-1621), Johann Valentin Andreæ (1586-1654), both Lutherans, and Johannes Coecejus (1603-69), a Calvinist, may be regarded as forerunners of Pietism. But its full development is to be ascribed to Peter Jakob Spener (q.v.) and his friends and disciples, particularly the Leipzig Doceats, Paul Anton, J. K. Schade, and August Hermann Francke. Driven from Leipzig by the opposition of the older school of theologians, Francke and Anton found a refuge, through Spener's influence, in the newly founded University of Halle, and under their lead and that of their associates, Joachim Justus Breithaupt and Hermann Lange, Halle became the centre of the movement and a source of new religious life in Germany. Pietism also became dominant in the universities of Königsberg, Giessen, and Marburg, and from North Germany spread to the south, where its head was Johann Albrecht Bengel, and even to other lands. Ultimately it went to excess, fantastic doctrines and fanatical practices came to prevail, and the rationalism of the eighteenth century was the inevitable and healthful reaction. For further details, see the article GERMAN THEOLOGY, section *The Period of Pietism*; see also the biographical notices of Spener, Francke, Bengel, and the other leaders. Histories of Pietism have been written by Schmidt (Nördlingen, 1863); Tholuek (Berlin, 1865); Heppé, treating particularly of the movement in the Netherlands (Leipzig, 1870); and Ritschl (Bonn, 1880-86). Consult, also, Renner, *Lebensbilder aus der Pietistenzeit* (Bremen, 1886); Hubener, *Pietismus geschichtlich und dogmatisch geschildert* (Zwickau, 1901).

PIET PAALTJENS, pēt pält'yēns. The pseudonym of the Dutch poet Francis Haverschmidt (q.v.).

PIETRA-DURA, pyā'trā dōw'rā (It., hard stone). A name given to the finest kinds of Florentine mosaic-work, in which the inlaid materials are hard stones, such as jasper, carnelian, amethyst, agate, etc. The real pietra-dura work dates as far back as the sixteenth century, about 1570; and from that time to the present has been almost confined to Florence, where a Government atelier has existed ever since the beginning of the seventeenth century. In the inferior kinds, which are sold in Italy, and are also manufactured in Derbyshire and other parts of Britain, pieces of colored sea-shells are used instead of the harder and more valuable colored stones.

PIETRAPERZIA, pyā'trā-pēr'tsē-ā. A town in the Province of Caltanissetta, Sicily, seven miles southeast of Caltanissetta. It has an old Norman fortress, and carries on a trade in grain and almonds. There are sulphur and gypsum mines in the vicinity. Population (commune), in 1881, 11,284; in 1901, 12,826.

PIETRASANTA, pyā'trā-sān'tā. A town in the Province of Lucca, Italy, 15 miles northwest of Lucca by rail, and two miles from the Mediterranean. It is situated on a hill, on the top of which is a large fortress, and is surrounded by a wall. The fourteenth-century Church of San Martino has fine choir stalls and a baptistry with bronze decorations by Donatello. The surrounding country is fertile, and the grape and

olive are produced in abundance. There are marble quarries and quicksilver mines. Population (commune), in 1881, 14,382; in 1901, 17,444.

PIETSCHMANN, pēch'mān, RICHARD (1851—). A German Orientalist. He was born at Stettin, studied in Berlin and Leipzig, and in 1888 became university librarian at Göttingen, where two years afterwards he received an appointment to a chair of Egyptology and Oriental history. He wrote: *Hermes Trismegistos* (1875); *Geschichte der Phönizier* (1889); and translations of Maspero's Oriental history (1877), and of the part dealing with Egypt in Perrot and Chipiez, *Histoire de l'art dans l'antiquité* (1884).

PIEZOMETER (from Gk. πῆζειν, *piezein*, to press + μέτρον, *metron*, measure). An instrument for measuring the compressibility of fluids. The name was given by Oersted (q.v.) to a piece of apparatus which he devised in 1822, and with which he was able to determine the compressibility of water, mercury, alcohol, and other liquids. It consisted of a cylinder of thick glass closed at either end by a brass cap. A tube of glass or brass containing a piston or a screw plug was fitted to the upper cap, by means of which considerable pressure could be exerted on the liquid in the cylinder below. This cylinder was sufficiently large to contain a glass flask whose neck was drawn out into a fine tube, like that of a thermometer, graduated into equal divisions, each of which represented a certain fraction of the volume of the flask. The flask was filled with the liquid whose compressibility was to be determined, and a small thread of mercury introduced into the fine tube. It was then placed inverted in the cylinder, which was filled with water, being so supported that the end of the fine tube dipped into a small vessel of mercury at the bottom. In this was placed another tube closed at its upper end, which acted as a manometer, enabling the observer to measure the pressure sustained by the liquid by the height of the mercury column. When the piston was pushed or screwed down, the liquid in the cylinder was put under pressure. This pressure was communicated to the liquid in the flask, which was compressed by a small amount, as was shown by the use of the mercury in the fine tube. Knowing the volume of the flask and the value of the divisions of the tube, the amount of compressibility was readily ascertained by the pressure shown by the manometer, and in this way Oersted found that the compressibility of water for one atmosphere of pressure amounted to 46.65 millionths. Colladon and Sturm, who performed a series of similar experiments, made this value 49.65 millionths, while Grassi somewhat later fixed the compressibility of water at 0° centigrade at 50 millionths, and at 53° centigrade at 44 millionths. With the piezometer it was also demonstrated that liquids are perfectly elastic, since when the pressure is removed the mercury sinks to its former position, showing that the liquid returns to its original volume.

PIFFERARI, pif'fā-rā'rē (It., pipers). The name given to shepherds of the Abruzzi who formerly flocked to Rome in the Advent season and collected gifts at the shrines of the Virgin, where they sang and played old airs on pipes and bagpipes. The pifferari were among the picturesque features of Rome and usually went in

PIGEONS



1. HOMING PIGEON
2. TURBIT
3. POUTER
4. BLACK FANTAIL
5. JACOBIN
6. CARRIER
7. BLACK NUN

pairs, an old man with pointed hat, cloak, sandals, and bagpipe, accompanied by a boy clothed in a skin and carrying the pipe.

FIG. See HOG; SWINE.

PIGAFETTA, pè'gà-fèt'tà, (FRANCESCO) ANTONIO (1491-c.1534). An Italian traveler and historian, born at Vicenza. His first journey was to Spain, where he obtained leave to go on the Magellan expedition (1519-22), and Pigafetta's was the chief account of the voyage. It was printed in French and Italian at Milan (1800), and a later edition came out in Rome under the title *Relazione intorno al primo viaggio di circumnavigazione. Notizie del Mondo Nuovo con le figure de' paesi scoperti* (1894).

PIGALLE, pé'gál', JEAN BAPTISTE (1714-85). A French sculptor, born in Paris. He was a pupil of Robert Le Lorrain and Lemoyne, and then studied in Rome. In 1741 he was elected to the Academy, where he became professor in 1752 and rector in 1777. His "Mercury Fastening His Sandals" (1763), a "Child with Cage," the busts of Marshal Maurice of Saxony (1750) and of the surgeon Guérin, and the marble statue of the Duke of Richelieu are in the Louvre. Other works by him include a marble group of the "Queen of Heaven," in Saint Sulpice, Paris; the tomb of the Comte d'Harcourt—partly destroyed, but restored—in Notre Dame, Paris; a statue of Voltaire in the library of the Institute; and his masterpiece, the tomb of Marshal Maurice of Saxony, in the Church of Saint Thomas at Strassburg. Consult Tarbé, *La vie et les œuvres de J. B. Pigalle* (Rheims, 1859).

PIGEON (OF. *pigeon*, *pipion*, Fr. *pigeon*, It. *piccione*, *pippione*, pigeon, from Lat. *pipio*, squab, young bird, from *pipire*, to chirp, onomatopoeic in origin). A name applied, like dove (q.v.), to all members of the family Columbidae. Although members of the group differ greatly in size and color, with a few exceptions they are easily recognized. They are chiefly medium-sized or rather large birds. Most of those of temperate regions are plainly colored with gray, brown, or slate, and some black and white, but some of the tropical forms show brighter shades of blue and purple; while the fruit-pigeons of the far Orient are gorgeous in green, yellow, orange, red, violet, and blue. The wings are usually long and pointed; the tail more or less elongated. The crop is large and double; during the breeding season it becomes glandular and secretes a milky fluid upon which the young are in part fed, or at any rate it moistens the food given them by their parents. The plumage of pigeons is generally very dense, quite smooth, often reflecting metallic lustres; the feathers entirely lack the aftershaft. Pigeons are monogamous, and the birds seem much attached to each other, and share mutually the labors of nest-building, incubating, and caring for the young. The nests are always flimsy structures of a few twigs in a tree, and the eggs, almost always two in number, are pure white. The young are naked and helpless when hatched. Pigeons are vegetarians, and eat fruit, grain, seeds, and the like, and are therefore often destructive in cultivated fields. Their notes are soft, low, and rhythmic—well described as 'cooing.' The flesh of most species is good eating, and they are ranked game-birds and are much

hunted. The flesh is nutritious, and that of the young, or 'squabs,' from twenty to twenty-five days old, is particularly delicate, and in some parts of the United States great numbers of domesticated doves are reared for market. One establishment near Los Angeles, Cal., kept in 1901 more than 10,000 to supply the demand for this delicacy.

More than 300 species of pigeon are known, of which nearly or quite half are the so-called fruit-pigeons of the East. The geographical distribution of the pigeons, living and extinct, suggests some of the most interesting inquiries in zoölogy. One interesting fact is that pigeons are generally absent from regions where monkeys abound, as these nimble thieves rob their open, unprotected nests so persistently that the two races of animals cannot dwell in the same district. Twelve species have been taken within the boundaries of the United States, but eight of these are West Indian or Mexican species, found only occasionally along our southern boundary. The remaining four are the little ground-dove (q.v.); the common 'mourning' or Carolina dove (*Zenaidura macroura*), abundant throughout temperate North America; the band-tailed pigeon (*Columba fasciata*), a large stout species, with a noticeable black bar across the bluish-ash tail, common from the Rocky Mountains to the Pacific; and the formerly very numerous 'wild' or 'passenger' pigeon.

The North American wild pigeon (*Ectopistes migratorius*) is especially interesting from the marvelous numbers composing its flocks before the settlement of the interior of the country caused its almost total disappearance. It is a large, slender bird, with a small head, notched beak, turned at the base, short strong legs with naked feet, a long acuminate tail, and very long, pointed and powerful wings. It is a beautiful bird, of very graceful form and finely colored plumage, and formerly was found in almost all parts of North America. It is not, properly speaking, a bird of passage, as apparently its movements are consequent on the failure of a supply of food in one locality and the necessity of seeking it in another. Its power of flight is very great. The nest of the passenger pigeon consists of a few dry twigs placed in a fork of the branches of a forest tree, and contains two eggs. They breed two or three times in a season. Although both the bird and its nest are rarities now, only isolated colonies remaining in the less settled parts of the country. During the early part of the nineteenth century incredible numbers of pigeons were wont to roost at night and nestle in certain breeding-places in the forests of the Mississippi Valley, where sometimes 100 or more nests were often seen in a single tree. These great breeding-places extended over a tract of forest, sometimes not less than forty miles in length. Flocks of pigeons were often seen flying at a great height in dense columns, eight or ten miles long; and calculations made by careful observers agreed that in some of their great migrations the column, a mile broad, was more than 150 miles long. The roosting-places were correspondingly extensive. The noise of wings and of cooing voices drowned the report of guns. The multitudes which settled on trees broke down great branches by their weight, so that it was dangerous to pass beneath. They crowded together, alighting one upon another, till they formed solid masses like hogs-

heads, and great numbers were killed by the breaking of branches. The inhabitants of the neighboring country would assemble, shoot them, knock them down with poles, stifle them by means of pots of burning sulphur, cut down trees in order to bring them in great numbers to the ground, eat them fresh, salt them, and bring hogs to fatten on them. Wolves, foxes, lynxes, cougars, bears, raccoons, opossums, polecats, eagles, hawks, and vultures congregated to share the spoils.

Such are the facts given by Wilson, Audubon, and the early historians of the West, and abundantly verified. The disappearance of these birds, as soon as settlers began to invade and clear away the woods, was so rapid as properly to be called sudden; and it is not easily explained.

Of the pigeons of the Old World, the most interesting is doubtless the blue rock pigeon, or rock dove (*Columba livia*), the 'biset' of the French, a bird of extensive geographical range. It is found as far north as the Farøe Islands and over the greater part of Europe, and breeds in crevices of rocks and often within caverns which open on the sea. In a wild state this bird exhibits great uniformity both in size and plumage; the prevailing color is bluish-gray, with two distinct bars of black across the closed wings. It is commonly believed that domestic pigeons are all descended from this species, although possibly some were derived from the very similar *Columba intermedia*. The ordinary domestic pigeon differs from the wild chiefly in color, and a tendency to revert to the original coloring has been observed. There are 250 or more domestic breeds, and they have undergone many remarkable changes under the selective care taken by intelligent fanciers, who often pay very high prices for fine birds. Some of the varieties which exhibit very strange peculiarities are known as 'fancy' pigeons, and are carefully tended and preserved by pigeon-fanciers. Of these may be mentioned, as among the most interesting, the rough-footed pigeon, having the feet feathered; the Jacobin, which has a range of feathers inverted over the head, and extending down each side on the neck, as a hood; the fan-tail, in which the number of the tail feathers is greatly increased, and the bird has the power of erecting its tail like that of a turkey-cock; the tumbler, so called from turning somersaults in the air in its flight, and further characterized by a very short bill; the pouter or 'cropper,' which has the power of blowing up its crop to an extraordinary degree so that the head seems fastened on the top of an inflated bladder; and the black nun.

None of these have the popular interest and value, however, reached by the carrier, or 'homing' breed, which is trained to return to its home from great distances, and is utilized for carrying messages in places where, sometimes, no other means of communication is available. This represents the highest example of pigeon development. This breed is of large size, about 15 inches long, and has the cere very large and carunculated, the eyes surrounded with a broad circle of naked red skin, and the wings reaching nearly to the extremity of the tail. Carrier pigeons are trained by being conveyed, when young, to short distances of a few miles from home and then let loose, the distance being grad-

ually increased until at last as much as 100 miles may be added, and the pigeon made to return accurately and swiftly from 500 to 600 miles away. Pigeons intended for this use must be brought from the place to which they are to return within a short period (not exceeding a fortnight) of their being let loose, and at a time when they have young in their nest; the remarkable fecundity affording particular facilities for its employment in this way. The impulse of the bird is to return to its family with the utmost haste.

The use of carrier pigeons is very ancient in the Orient, and was brought to the attention of Europe at the time of the First Crusade, when the Saracens were found to have the birds in regular use for the conveyance of information; and the Christian commanders employed falcons to chase and intercept this pigeon-post on several occasions, and on others caught the tired birds, substituted misleading messages for those they were carrying, and sent them on to deceive the enemy. Arabic writers attribute to the perfection of a system of pigeon-posts elaborated by the great Turkish sovereign Nur-ed-din a large part of his success in welding together the scattered parts of his broad empire. Although their use, publicly and as an amusement, continued, it was not until the Franco-Prussian War of 1870 that pigeons were again of conspicuous public service. During the siege of Paris constant communication between the beleaguered city and the outside world was obtained by this means, microphotographs of military despatches, private letters, and even newspapers, being printed upon films of collodion and carried by the birds—as much as 30,000 words in some instances. These would then be enlarged by photography and made legible. Subsequently the German, French, and other European governments established regular pigeon-corps in the intelligence departments of their armies and navies, and thousands of birds were trained, and many continue to be kept for use as messengers. Experiments were tried extensively by the French in the employment of pigeons at sea. It was found that they bore voyages well, and would fly from a distance of over 300 miles to shore-stations with great accuracy; but that they could not be depended upon to go from ship to ship. In 1897 many trials were made in the United States Navy, especially by Admiral Sieard, and considerable success was attained. A similar news-service was also attempted by certain newspapers in coöperation with some of the Atlantic steamship companies, but was not long maintained.

The flight of one of these birds is steady, direct, and rapid, but the rate of speed has been exaggerated, and is now known to be on the average only about 30 miles an hour and rarely 45 miles. It begins with a spiral flight upward as soon as the bird is released from its confinement (usually in a portable dark basket), which is continued to a sufficient height to enable the bird, searching the horizon, to catch sight of some landmark with which it has previously been made familiar. Its memory in this respect is marvelous; and it may be assisted by that instinctive faculty for direction which seems innate in many birds and other wild animals. (See MIGRATION.) It then directs its course straight toward that point, when it will sight

PIGEONS

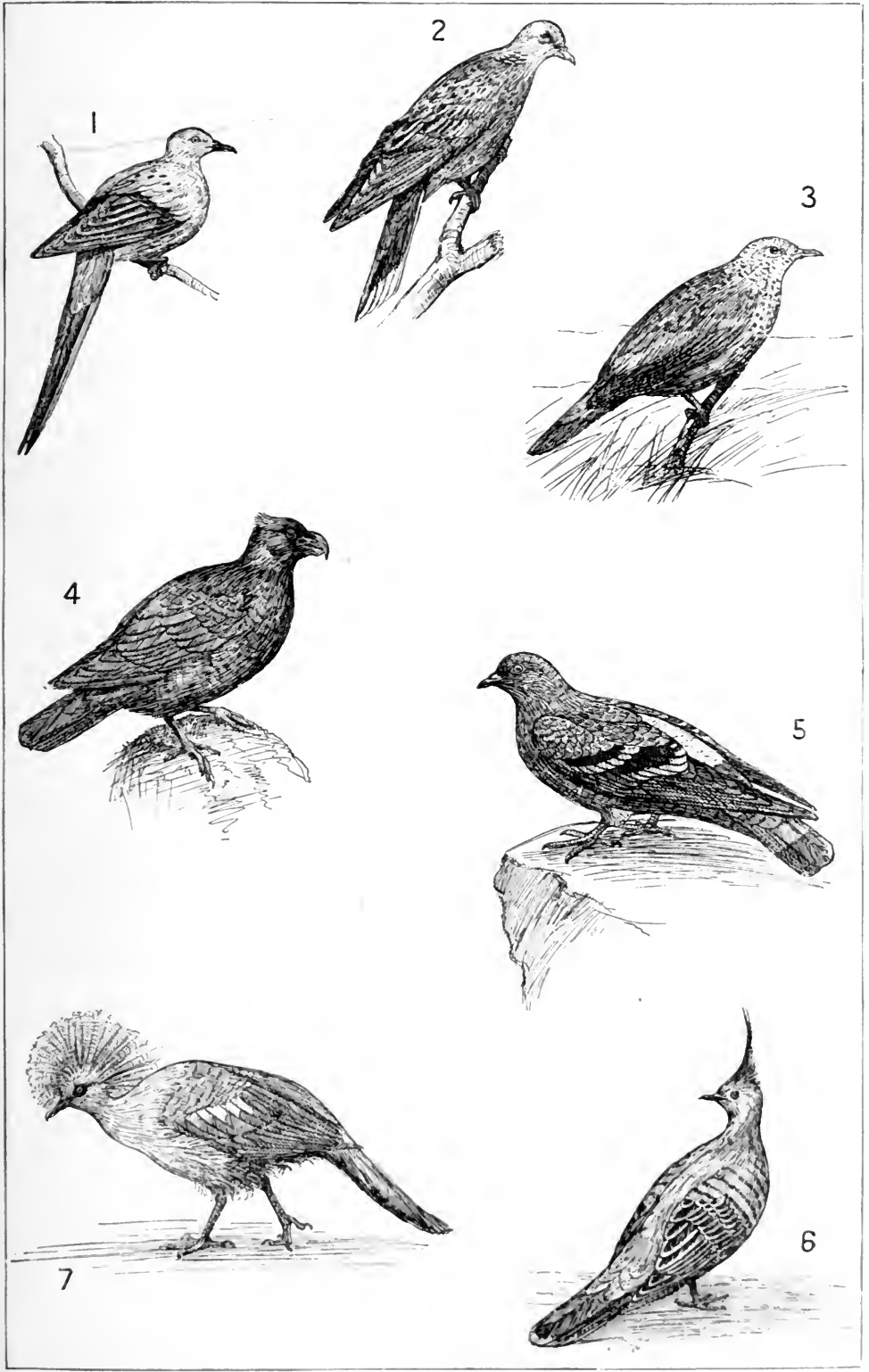

1. WILD or PASSENGER PIGEON (*Ectopistes migratorius*). 2. EUROPEAN TURTLE-DOVE (*Turtur communis*). 3. GROUND-DOVE (*Columbigallina passerina*). 4. TOOTH-BILLED PIGEON (*Didunculus strigirostris*). 5. BLUE ROCK PIGEON (*Columba livia*). 6. CRESTED BRONZEWING (*Ocyphaps lophotes*). 7. CROWNED PIGEON (*Goura coronata*).

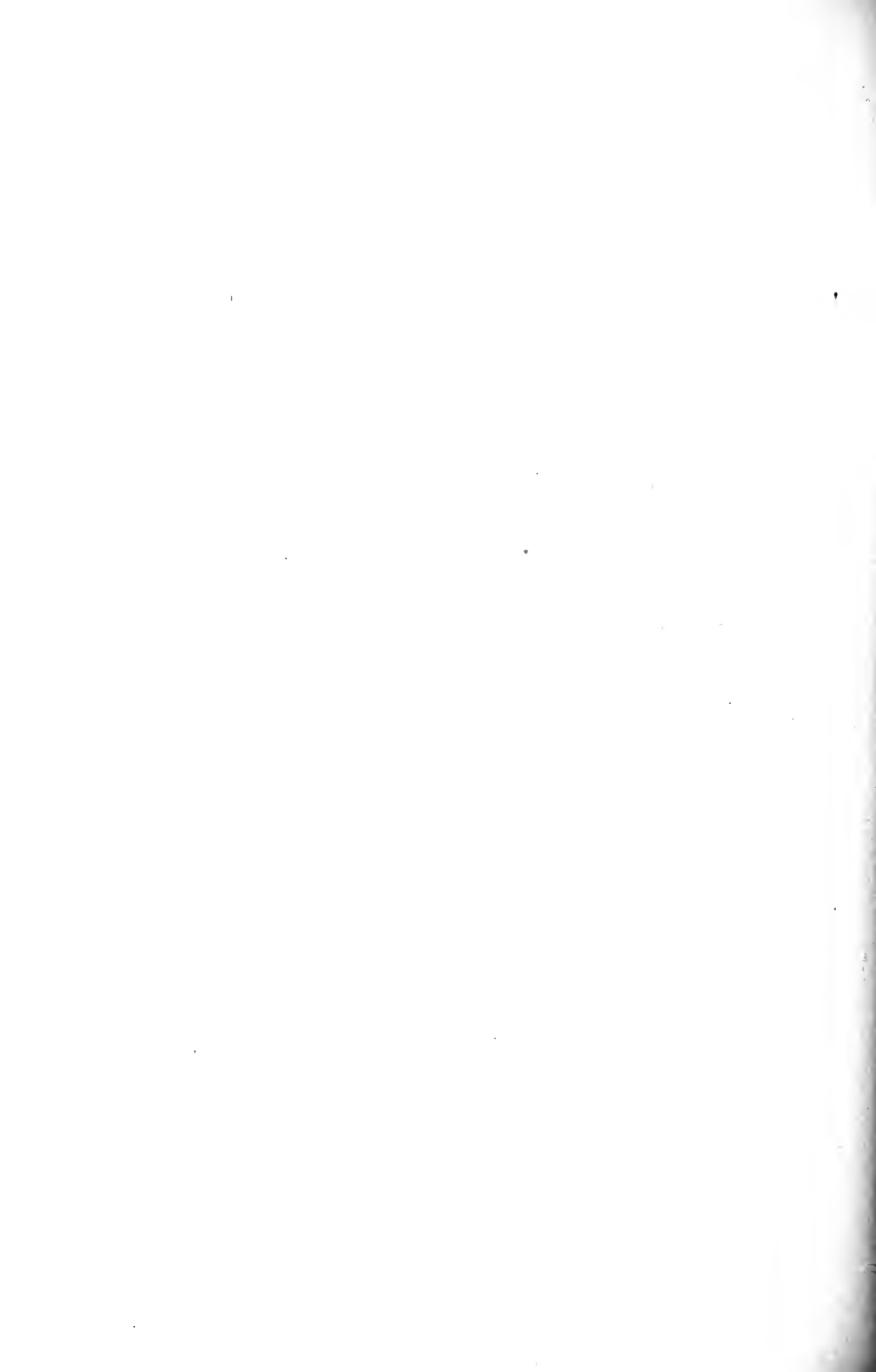

another landmark and so proceed from known place to place until it reaches home. Many societies in various parts of the world are breeding these pigeons and perfecting their abilities, and 500-mile races are frequently run.

The pigeons are a family, Columbidae, of the charadriiform suborder Columbæ, which also includes the families Dididae (see DODO) and Didunculidae (or tooth-billed pigeons). The Columbidae are divided by structural features into several subfamilies: (1) Gourinae, containing the gouras (q.v.). (2) Peristerinae, containing such tropical groups as the Nicobar pigeon, the wonga wonga of Australia, the bronze-wings, and several other robust, often terrestrial forms of the East and West Indies; also the ground-doves of American warm latitudes; the scaly doves of the Andean region; the American mourning-doves, and the many species of turtle-doves (q.v.) of the Old World. (3) Columbinae, the typical pigeons. (4) Treroninae, the fruit-pigeons, in the widest sense, about 120 species, most of which are Oriental and African.

BIBLIOGRAPHY. Excellent popular accounts of pigeons in general will be found in the *Standard and the Royal Natural Histories*; by Evans in *Birds* (New York, 1900); and by Newton, in *Dictionary of Birds* (New York, 1896), the latter with many bibliographical references. Monographs have been prepared by Temminck (1808-11), Prevost (1838-43), and Selby (1835), but the most recent is Salvadori's vol. xxi. (London, 1893) of the *Catalogue of Birds in the British Museum*. In respect to domestic pigeons, many works exist, of which the foremost is Tegetmeier, *Pigeons, Their Structure, etc.* (London, 1867); Darwin, *Origin of Species* (London, 6th ed., 1882); id., *Variation of Animals and Plants* (London, 2d ed., 1875); Helm, *Cultivated Plants and Domestic Animals* (English trans. by Stallibrass, London, 1891); Rice, *The National Standard Squab Book* (Boston, 1902); id., *Robinson's Method of Breeding Squabs* (ib., 1902).

PIGEON-BERRY. The fruit of a perennial herb. See POKE; PHYTOLACCA.

PIGEON-ENGLISH. See PIDGIN-ENGLISH.

PIGEON-FLYING. The art and practice of training and coursing carrier pigeons, according to the rules of societies which exist for the promotion of competitive races. See PIGEON.

PIGEON-HAWK. A falcon (*Falco*, or *Falco columbarius*), inhabiting the cold and temperate parts of America. It is from twelve to fourteen inches in length, with a spread of wing, in the female, of from two feet to twenty-six inches. The male, as is usual with falcons, is smaller. In the adult the back is of a bluish slate color, every feather having a longitudinal black line. The throat, breast and belly are pale pinkish or yellowish white, each feather with a longitudinal line of very dark brown. The quills are black, with ashy white tips; bill blue, legs reddish yellow, with dark lines. It is the most fierce of all hawks in proportion to its size, and lives mainly upon small birds, such as pigeons, but rarely if ever attacks poultry. It breeds in the northern part of the continent, but passes the winter in the tropics. A familiar hawk of India, known to falconers there as 'turumti' (*Falco typlus*), and an Ethiopian species (*Falco*

ruficollis) complete this lively and interesting genus. Consult American and European ornithologies, especially Fisher, *Hawks and Owls of the United States* (Washington, 1893).

PIGEON-PEA (*Cajanus*). A genus of plants of the natural order Leguminosæ, of which there is only one species (*Cajanus indicus*), a native of the East Indies, but much cultivated also in the West Indies and in Africa, where, as in other tropical countries, the plants annually drop their leaves and reproduce new ones with their flowers, when they are productive for several years. The seeds are among the most valuable tropical kinds of pulse. The plant is a shrub attaining a height of four to ten feet when grown in favorable regions, although in cultivation it is generally treated as an annual. It grows either in rich or poor soils. Tested at the Louisiana Experiment Station, the pigeon-pea was found very susceptible to frost and not well adapted to growing in this country.

PIGEON-PLUM. A Florida fruit. See SEASIDE GRAPE.

PIGLHEIN, pig'hin, BRUNO (1848-94). A German painter, born at Hamburg, where he originally studied sculpture under Lippelt. Subsequently a pupil of Schilling in Dresden, he was influenced by a visit to Italy to take up painting under Pauwels at Weimar (1870), then studied under Diez in Munich and after some decorative work became more widely known through his religious composition "Moritur in Deo" (1879, National Gallery, Berlin), representing Christ on the cross kissed by the Angel of Death. Soon afterwards he began to cultivate the pastel almost exclusively, and depicted fashionable ladies, roués, masked figures and dancers, but also executed many refined portraits of women and children, and scenes from child life, of which the "Idyl" (child and dog snugly seated by the water) became widely familiar through reproductions. After 1886 he gave preference again to religious subjects, well exemplified by an "Entombment" (1888), in the New Pinakothek at Munich, which also contains the impressive "Blind Maiden Going to the Well" (1890).

PIGMENT. See PAINTS.

PIGMENT (Lat. *pigmentum*, from *pingere*, to paint; connected with Skt. *piś*, to adorn). In animals, the coloring granular matter in certain cells of the inner layer ('derma' of vertebrates, 'hypoderma' of arthropods) of the skin. In mammals and man the pigment is brown or nearly black, that of the retina of the eye very black and abundant, and is always situated in cells of the Malpighian layer, which lies between the epidermis and derma; in amphibians the pigment is accumulated mostly in the derma, partly diffused, and partly inclosed within the cells. In birds, the skin being very thin and concealed by the feathers, the coloring matter is mainly confined to the feathers. The principal pigments are: Zoömelanin, the black animal coloring matter, distributed in amorphous little corpuscles, insoluble in water, alcohol, acid, or ether, but dissolved and destroyed when boiled in caustic potash and then treated with chlorine; it consists of about 53.5 per cent. of carbon, 4.6 of hydrogen, 8.2 of nitrogen, and 32.7 of oxygen. Zoöerythrin, red, hitherto found in the red feathers of cotinga, the flamingo, ibis, a cockatoo, the car-

dinal-bird, and others, and in the 'rose' around the eyes of the grouse. It is soluble in ether, alcohol, and chloroform, but not in acids or in potash. Zoöxanthin, yellow, can be extracted by boiling in absolute alcohol, and is a diffused pigment which tinges the shafts, rami, and radii of the feathers, and is possibly the same in the yellow feet and bills of birds of prey and ducks; like zoërythrin, it is a colored fatty oil. Turacin is a most peculiar pigment, detected in the red feathers of the Musophagide, and seems to be restricted to these birds. It consists of the same elements as zoömelanin with the addition of from 5 to 8 per cent. of copper. Such pigments appear in the coloring matter of birds' eggs. See Egg.

In insects the conditions are somewhat different, as the coloring matter is lodged not only in the scales, but in the skin or crust of the body. The pigment in most insects, as well as in the lobster, is secreted in the deeper layer of the skin, under the cuticle, and this layer is called the hypodermis. When the lobster casts its shell the soft hypodermal layer consists of cells which are filled with red and blue pigment masses. This cellular layer gives rise to the outer cuticle, which thus derives its hue, red and blue, from the deeper inner layer of color-secreting cells. In most insects the cuticle is nearly colorless, or horn-colored or honey-yellowish, in tint.

It has been found by experiments that pigments may be dissolved out by chemical reagents and subsequently restored by other agents. Both Coste and Urech have proved that red, yellow, brown, and black colors in the scales of certain butterflies are always due to pigments, and in a few cases greens, blues, violets, purples, and whites are due to the presence of pigments in the scales themselves. Dr. A. G. Mayer believes that the pigments of lepidopterous insects are derived from the blood of the chrysalis. The first color to appear in the pupa or chrysalis of the American silkworm, on which he made his observations, is dull-yellow ochre or drab; this is of the hue of the blood when removed from the chrysalis and exposed to the air. Mayer has also artificially produced several kinds of pigments from the blood, which are similar in color to various markings on the wings of the imago, or adult. He has also found that chemical reagents have the same effects on these manufactured products as on similar pigments in the wings of the living moth.

As regards pigmental colors, Baer classified them into two types: diffused and granular. Pigments of the first type are diffused through the chitin or substance of the scale, are usually present in very small amount, and include the dark pigments, most yellows, oranges, and reds, except in the Pieridæ, and the whites (uric acid) of the Pieridæ. Baer also, contrary to the results of Hopkins, found that some of the orange and yellow pigments of the Pieridæ are diffuse and not granular. Granular pigments occur exclusively in the Pieridæ and are yellow or red in color. They color the scales in which they occur very deeply. Such scales are few in number and almost without surface sculpturing. The superposition of dark-colored scales upon scales deeply tinted by yellow granular pigment may, as in *Anthochaus cardamines*, produce a greenish tint.

Equal activity has been shown by chemic-

biologists in the study of the coloring matter of flowers. It is now held that nearly all blue and red pigments originate from tannin; in other words, tannin constitutes the chromogen of the red and blue floral pigments. Keegan showed that the circumstances which created or influenced the particular tint of flowers was first chemical (the presence of quercetin in the form of rutin, etc., in the corolla), and second, physiological, i.e. the possession by the corolla of energetic respiratory and transpiratory functions, with the result that the substances contained in its cells underwent an oxidation more or less vigorous and complete.

PIGMY PARROT. One of the diminutive parrots of New Guinea, of the subfamily Nasiternine, which are smaller than a song sparrow. They have beaks like those of miniature cockatoos, short square tails, and the males have gorgeous plumage, but the females are more soberly dressed.

PIGNEROL, pé'nye-rôl'. The French name of the town of Pinerolo (q.v.), in Italy.

PIGNUS (Lat., pledge). At Roman law, a pledge, i.e. something given to secure performance of an obligation. Originally, *pignus* could be established only in corporal things, and only by giving possession; and it conferred no right upon the pledgee except that of retaining possession until the debt was paid. Power of sale in case of the debtor's default was first introduced by contract, but eventually the power of sale became part of the general law of pledge. Pledge of a claim against a third person (*pignus nominis*) was also recognized, a quasi-possession of the pledgee being established by notice to the pledgor's debtor. Before the close of the republican period the pledge of a thing had become independent of possession; it could be established by mere agreement; and such a contractual lien was enforceable against third persons. With this change *pignus* and hypotheca (see HYPOTHECATION) became virtually the same thing. In the Justinian law *pignus* designates a pledge or mortgage of movable property or of a debt, while hypotheca designates a mortgage of immovable property.

From the point of view of the relation of pledgor and pledgee, *pignus* was regarded as one of the real contracts. See CONTRACT.

Pignus could be established not only by contract, but by will. It could also be established by levy on property in execution of judgment, and it was established in some cases by direct operation of law, as in the case of the landlord's lien on the effects brought in by the tenant.

Modern civil law recognizes as a rule no pledge of movables without possession. See PROPERTY; also BAILMENT.

PIGNOT. See EARTHNUT.

PIGOTT, pig'ot, RICHARD (1828?-89). An Irish journalist and forger. He passed a checkered career on several Dublin newspapers. In 1879 he was proprietor of three newspapers, which he soon sold to the Irish Land League, of which Charles Stewart Parnell (q.v.) was president. Hitherto a violent Nationalist, Pigott now began to vilify his former associates and to sell information to their political opponents. His famous transaction was with the Irish Loyal and

Patriotic Association, founded in 1886, to resist home rule for Ireland. His papers, part true and part forged, furnished to this organization, were purchased by the London *Times*, in which they began to appear under the heading "Parnellism and Crime" (1887). Widespread sensation was created by a letter (published April 18, 1887), purported to be signed by Parnell. In this letter sympathy was expressed for the Phoenix Park murderers. In 1888 Parliament appointed a commission to inquire into the charges made by the *Times* against the Irish leader. Pigott was exposed by Sir Charles Russell, the counsel for Parnell, confessed his crime to Henry Labouchère, and fled to Madrid, where he shot himself as the English officers who had come to arrest him entered his room (March 1, 1889).

PIGRES, pi'gréz (Lat., from Gk. Πίγρης). A Greek poet of the fifth century B.C.; supposed to have been the brother or son of Queen Artemisia of Caria. According to Suidas and Plutarch he wrote a poem entitled *Μαργύρης*, and he is now generally regarded as the author of the mock-heroic poem *Βαρραχομωμᾶχια* (*The Battle of the Frogs and Mice*), which was once attributed to Homer. Pigres is said to have been the first poet to introduce the iambic trimeter.

PIG-TAILED BABOON. A small, black baboon-like monkey, of Celebes Island (*Cynopithecus niger*), which has a rudimentary tail.

PIG-TAILED MONKEY. Either of two species of East Indian macaques, remarkable for their short curling tails. The best known is the short-haired one (*Macacus nemestrinus*), described by Buffon as the 'maimon,' which inhabits the Malay Peninsula and southward through Sumatra and Borneo. It is as large as a mastiff, and has great strength; and it was long ago related of it that the Sumatrans trained it to climb trees and throw down coconuts, but it is now believed that if this were ever true it must have been so only of females or young, as the old males become very fierce and unruly.

The Burmese pig-tailed monkey (*Macacus leoninus*) is distinguished by its longer hair, smaller size, and darker color. It has a limited distribution, is rare, and little known. See Plate of MONKEYS OF THE OLD WORLD.

PIGWEEED. A name given to various species of *Amarantus* (q.v.) and often also to certain species of *Chenopodium* (q.v.).

PIKA. The popular name of the curious little duplicidentate rodents of the genus *Lagomys*, related to hares and rabbits, but representing a distinct degenerate family, the *Lagomyidae*. They are sometimes called 'calling hares,' 'little chief hares,' and 'comies.' They are about the size and shape of a guinea-pig, and are not superficially at all like the hares, except about the nose, though the rounded ears are large and the tail very short. Three species at least are known, one in Europe and Asia, a second in Asia, and the third in the mountainous parts of the Western United States. The latter (*Ochotona princeps*) is seven inches long, the tail less than an inch. It is dark grizzled blackish above and dirty whitish beneath. It inhabits the higher parts of the mountains, generally just above the timber line. The pikas are somewhat gregarious, and numbers usually inhabit masses of rocky debris at the base of cliffs, where their squealing

note makes their presence known. They are timid, unsuspecting, and perfectly harmless animals. They feed entirely upon vegetable matter, and store up hay and dried vegetables—which they cut and lay in the sun to cure—as bedding and fodder for the winter. The Indians hunt and trap them for their skins, which they sew together into undergarments. See Plate of HARES AND PIKA.

PIKE (so called from its sharp snout and slender shape). The name of any one of several species of soft-rayed fishes of the family *Lucidae* (or *Esocidae*). They have an elongated body, slightly compressed posteriorly, and covered with scales. The head is long with a prolonged and depressed snout. The mouth is large, the lower jaw somewhat the longer, and well supplied with strong, sharp teeth. The dorsal and anal fins are inserted far back. There is a single genus, *Lucius* (*Esox*), with six species all restricted to the northern part of North America except one species (*Lucius lucius*), which is also found in Northern Europe and Asia. This, the 'common' or English pike, grows to a length of about four feet. The "general color is bluish, or greenish gray, with many whitish or yellowish spots . . . arranged somewhat in rows; the dorsal, anal, and caudal fins with roundish or oblong black spots." It is called both 'pike' and 'pickerel' in the United States. The greatest of the American pikes is the maskinonge (q.v.), of the Great Lakes, which differs little from the European species. The remaining species are described under PICKEREL.

All the pikes are known for their voracity and are hated by fish culturists because of their inroads upon other more desirable species. A pike willingly attacks any fish of its own size and preys freely on the smaller ones, even of its own species. Frogs are frequent prey; water-rats and ducklings are sometimes devoured. They spawn in spring in grassy shallows of the rivers and weedy waters in which they live, laying many thousands of eggs, which remain entangled in the vegetation until they hatch. The young pikes grow with great rapidity, and in England are known as 'jacks,' or 'pickerels.' The Scotch name is gedd, a term similar to those in the Scandinavian languages.

The pike is caught by means of nets, by the rod, by set lines, and by trimmers or jiggers, which may be briefly described as floats with lines attached to them, the line being so fastened that the bait swims at a proper depth, and that some yards of line run out when the bait is taken. In angling for pike various baits are used, such as a minnow, a portion of a fish, etc., and sometimes an artificial fly is employed with success. These are English methods. In the United States a commoner method is by trolling with a spoon-bait. They are also much caught through the ice of the northern lakes. See Colored Plate of AMERICAN GAME FISHES, accompanying article TROUT; and Plate of NEEDLE-FISH, PIKES, etc.

Various other fishes are often called pikes, as the gars, and pike-perches (q.v.). The 'Sacramento pike' (q.v.) is a chub; the 'picuda' is a barracuda.

PIKE (AS. *pic*, OF. *pique*, *picque*, Fr. *pique*, pike). A weapon of warfare used extensively till the introduction of the bayonet. Among ancient armies the Macedonians were famous for

their spear or pike men, who carried weapons fully 24 feet long, while among comparatively modern armies pikes averaged a length of from 12 to 14 feet. They were of stout wood, and were tipped with a flat-shaped iron spear-head, which sometimes had cutting edges. As a defense against cavalry, the pike, from its length and rigidity, was of great value; but though it survived the introduction of gunpowder, that event was really fatal to it. In pike formations a depth of several men was essential, but the growing use of artillery rendered this impossible. For the transition from pike to bayonet, see BAYONET. See also INFANTRY.

PIKE, WALL-EYED. See PIKE-PERCH.

PIKE, ALBERT (1809-91). An American author, born in Boston. He studied at Harvard, and in 1831 journeyed to Santa Fé by way of Saint Louis. In 1832 he explored the head waters of the Brazos and Red rivers, and went 500 miles on foot, to Fort Smith, Arkansas, in which State he settled. After editing the Arkansas *Advocate*, he was admitted to the bar, and in 1836 he edited the Arkansas Revised Statutes. He served as captain of cavalry in the Mexican War, at the beginning of the Civil War was Indian commissioner of the Confederate Government, and later served as brigadier-general, commanding bodies of Indians whose enlistment he had secured. In 1866 he settled as a lawyer at Memphis, where in 1867 he edited the *Appeal*. In 1868 he resumed his practice at Washington, D. C. Besides preparing a number of volumes for the Freemasons, he published *Prose Sketches and Poems* (1834), and *Nugæ* (1854), printed privately, and containing the "Hymns to the Gods," which had appeared in *Blackwood's Magazine* in 1839. His poetry, especially his "Hymns to the Gods," proves him to have been a man of considerable talent. He died in Washington, D. C.

PIKE, ROBERT (1616-1706). An American colonist, born in England. He emigrated to this country with his father, John Pike, in 1625, and settled in Newbury, Mass. Four years later he removed to the farm at Salisbury which was his home for the remainder of his life. He early became a man of prominence in the colony, was major of the local militia, and from the time he was twenty-eight years old until his death—with the exception of three years when he was at odds with the General Court—he held political office, being for a long time a member of the General Court itself, and later of the Board of Assistants. He was chiefly remarkable, however, as the representative of the first advocates in America of the people's right to free speech, to petition and to criticise their legislative bodies, and to demand acquittal in a court of law when not confronted with conclusive evidence. Though strictly orthodox in his own beliefs, he defended the right of the Quakers to the free expression of their views and criticised the General Court for its action against sectarians. For this he was disfranchised by that body. Though he believed in the possibility of witchcraft, he protested against the admission of 'spectre testimony' at the trials of supposed witches. Several were condemned in the towns about Salisbury despite his labors in their behalf, but, probably because of his influence, none were executed; and so this little group of villages was saved from sharing in the notoriety of Salem.

PIKE, ZEBULON MONTGOMERY (1779-1813). An American soldier and explorer, born in Lambertton, N. J. He was taken by his father, an army officer, to Bucks County, Pa., and then to Easton. At the age of fifteen he was a cadet in his father's regiment, became ensign March 3, 1799, and was made first lieutenant November 1, 1800. On August 9, 1805, he started from Saint Louis on an exploring expedition into part of the territory acquired by the Louisiana Purchase. After suffering many hardships and reaching the Upper Red Cedar (Cass) Lake, he returned to Saint Louis in April, 1806. He started on another expedition on July 1st, ascended the Missouri River and the Osage, into the present State of Kansas, and thence proceeded south to the Arkansas River. He ascended this to the present site of Pueblo, Col., viewed 'Pike's Peak' (named in his honor), and then went to the site of the present Leadville. While searching for the Red River, he reached the Rio Grande on Spanish territory, and was sent under guard by the Spanish Governor of New Mexico to General Salcedo at Chihuahua. After some delay he was escorted to the boundary, and on July 1, 1807, reached Natchitoches. He had been made captain in 1806 and was promoted to be major in 1808, lieutenant-colonel in 1809, and colonel in 1812. On March 12, 1813, he was nominated brigadier-general (though he was not confirmed by the Senate before his death), and was assigned to the principal army as adjutant and inspector-general. In the expedition against York (Toronto), Canada, he landed on April 27th, and stormed one of the redoubts. The retreating garrison blew up the magazine, and a descending fragment of rock crushed his spine and caused his death within a few hours. Pike published the results of his expedition in *An Account of an Expedition to the Sources of the Mississippi, and Through the Western Parts of Louisiana, and a Tour Through the Interior Parts of New Spain* . . . (1810). This contains much valuable information, but is poorly arranged and full of repetition. It was rearranged and reprinted in England in 1811. From this was made a French translation in 1812 and a Dutch translation in 1812-13. Consult *The Expedition of Zebulon M. Pike to the Headwaters of the Mississippi, Through Louisiana Territory, and in New Spain* (3 vols., New York, 1895). This contains the rearranged text, full notes, and an elaborate memoir by Elliott Coues.

PIKE-PERCH. The name given in America to a genus of perches, *Stizostedion*, and in Europe to species of a very nearly related genus, *Lucioperca*, because of their rather elongate body and the resemblance of the snout to that of a pike. They are true perches and inhabit the lakes and streams of Europe, Western Asia, and Eastern North America. There are several species in each genus, and all are important food fishes. They are usually under two feet in length, but *Lucioperca sandra* of Europe may reach a length of four feet, and *Stizostedion vitreum* of America a length of three feet and a weight of twenty pounds. The latter is a fish of many names in the United States, 'wall-eyed pike' being perhaps the most widespread and familiar—a name, like 'white-eye' and 'glass-eye,' due to the large prominent eye; 'dory,' 'yellow' or 'blue' pike, and 'jack salmon' are other local

names. It is brassy olive in color, with the lower jaw, belly, and lower fins pinkish. It is scattered in favorable waters all over the North-western States and the Mississippi Valley, and is caught both in nets and by angling.

A second species (*Stizostedion Canadense*) is more northerly in its distribution, and is known as 'sauger' and 'sand' or 'gray' pike. It is particularly a fish of the Great Lake region, and has a more cylindrical form and more spotted fins than the wall-eyed pike, from which it may also be distinguished by absence of the jet-black spot over the hinder spines of the dorsal fin. See Plate of PERCHES.

PIKE'S PEAK. A peak of the Rocky Mountains, in El Paso County, Col., near Colorado Springs (Map: Colorado, E 2). It was discovered by General Pike, U. S. Army, in 1806. Its height is 14,108 feet above the level of the sea, and it commands a magnificent and widely extended view of the great plains, and of a rugged, mountainous country containing many lakes and rivers. Pine forests cover the slopes to a height of 11,700 feet, above which the mountain consists of bare granite rocks. The summit was occupied by a meteorological station of the United States Signal Service from 1873 to 1888, and reoccupied by the Weather Bureau in 1892. A rack and pinion railroad to the top was opened in 1891.

PILASTER (ML. *pilasterum*, little pillar, diminutive of Lat. *pila*, pillar). An ornamental member in architecture, corresponding to the column and pier, but forming a part of the wall from which it projects. When it is not prominent and is lacking in capital and base, it is called pilaster strip. In Greek architecture it was called *anta*; in Roman buildings, as in Greek, the pilaster usually responded to a column, but in some cases, as in the beautiful arch at Tripolis, it was independent and richly ornamented. The pilaster was used in every style, but until the Renaissance was not as favorite a form as the engaged column. The decorative pilasters of the early Italian Renaissance were the most charming works of their class, and, though copied in design from Roman art, were more profusely used than in any other style.

PILATE (Lat. *Pontius Pilatus*). The Roman Governor of the territory comprising Judæa, Samaria, and a large part of Idumæa, which, after the deposition of Herod Archelaus in A.D. 6, became an Imperial province. His official title was procurator, and he resided in the prætorium at Cæsarea, going up to Jerusalem at the season of national feasts. He possessed complete judicial authority except in cases of Roman citizens, who had the right of appeal to Rome, but many of these functions were discharged by local courts, particularly by the Sanhedrin in Jerusalem; death sentences were confirmed and executed by the procurator. Pilate's term of service in Palestine was long, from the appearance of John the Baptist, through the ministry of Jesus, and while the early Church was gaining its first converts (A.D. 26-36). The early years of his administration were marked by strained relations between himself and the Jews, whose intense religious convictions and national pride he failed to understand. He was thoroughly hated, and, in one instance at least, the people appealed successfully to the

Emperor against him. Pilate is known chiefly from his connection with the trial and death of Jesus of Nazareth. After the Sanhedrin had condemned Jesus to death, they came to Pilate evidently expecting that he would ratify their decision without investigation. This, however, he refused to do. The Jews therefore presented charges of corrupt teaching, interference with tribute, and false claims of kingship against Jesus (Luke xxiii. 2), which brought him within the sphere of civil law. Pilate examined him privately and Jesus answered his questions frankly. As a result of the examination, Pilate was convinced that Jesus was politically harmless and wished to save him, but he feared to do so by peremptory release. In the end popular clamor prevailed, and personal and political considerations of a selfish nature outweighed Pilate's loyalty to the functions of a just judge. Pilate's rule in Judæa ended by his being cited to appear in Rome to explain certain acts of cruelty. Thereafter he disappears from authentic history. There are many traditions concerning the end of his life. One of these is connected with Mount Pilatus, near Lucerne, Switzerland, in a lake on which his body is said to lie. Consult, besides the lives of Christ, and Schürer's *History of the Jewish People in the Time of Jesus Christ* (Eng. trans., Edinburgh, 1886-90), especially, G. A. Müller, *Pontius Pilatus der fünfte Prokurator von Judäa* (Stuttgart, 1888).

PILATE, ACTS OF. See APOCRYPHA, section on *New Testament*.

PILATE, ARCH OF. An arch spanning the Via Dolorosa at Jerusalem, said to mark the spot where Jesus with the crown of thorns was presented to the Jews by Pilate with the words "Ecce Homo." The structure is probably a Roman triumphal arch.

PILATUS, pi-lä'tus, MOUNT. A peak of the Bernese Alps in Switzerland, rising from the western shore of the Lake of Lucerne (q.v.) to a height of 6998 feet (Map: Switzerland, C 2). It is visited by numerous tourists on account of the fine view to be had from the summit, which is reached by a rack and pinion railroad. The name is probably a corruption of *pilatus*, 'capped;' but according to a legend it is derived from Pontius Pilate, whose body is supposed to have been thrown into a little lake at the foot of the mountain, and whose ghost, as the legend goes, still haunts the place.

PIL'CHARD (formerly also *pilcher*, from Ir. *pilseir*, pilchard). A European fish (*Clupea pilchardus*), closely allied to the herring and the same thing as the sardine, sardines being simply young pilchards. (See SARDINE.) The pilchard occurs in vast schools along the western coast of Europe and in the Mediterranean Sea, and is taken by means of seines in enormous quantities for the European markets and preserving factories. It reaches nearly the size of the herring, but is rather thicker, and the outlines of the back and belly are straighter; the upper part of the body is bluish green, the sides and abdomen silvery white, the cheeks and gill-covers yellowish, and the dorsal fin and tail dusky. In Great Britain it is caught only along the Channel coast. See Plate of HERRING AND SHAD.

PILCOMAYO, pi'kó-mä'yó. A river of South America, the longest tributary of the Paraguay

River (q.v.). It rises in the Cordillera Real in Western Bolivia, and flows with no large deviations southeastward until it joins the Paraguay just below Ascunción (Map: Paraguay, E 8). In the lower half of its course it forms the boundary between Argentina and Paraguay. After descending from the Bolivian plateau and breaking through several ridges, it flows for the remainder of its course through the great plain of the Gran Chaco, partly through dense forests, partly through wide, marshy tracts, where the banks are submerged, and where the river divides into several parallel channels. It is here a sluggish stream with an average width of thirty yards, and so shallow and obstructed as to be almost completely unnavigable. The Pilcomayo has not yet been thoroughly explored, and its length is undetermined, but is estimated at 1200 miles.

PILE (AS. *pil*, from Lat. *pilum*, javelin, pestle, from *pisere*, *pinsere*, to pound). In engineering and architecture, a long post generally of wood, but often of iron, driven into soft soils to support a load or to form an inclosure against the entrance of water. Piles are known by different names, according to their character or use, the more important being: *Bearing pile*, one used to sustain a vertical load and the one generally meant when the word pile is employed without qualification; *sheet piles*, thick boards or timbers driven in close contact, often tongued and grooved, to inclose a space, to prevent leakage, etc.; *serew pile*, an iron shaft to the bottom of which is attached a broad-bladed serew with one or two turns; *disk pile*, an iron shaft to the bottom of which is attached a circular disk to give additional bearing power. The most common form of pile is the bearing pile of, usually, a roughly trimmed, slender tree trunk, or, less usually, of a squared or other dressed timber shape. The woods used for piles are spruce and hemlock for soft soils, pines, elm, and beech for firmer soils, and oak for compact soil. Engineers usually require that piles shall not be less than

falling weight. These leaders are usually braced back to the pile-driver platform by diagonal timbers. The sides of the hammer are grooved to slide between the leaders, and it weighs from 500 to 4000 pounds, usually about 2000 pounds. It is hauled to the top of the frame by a rope or chain attached to its top and passing over a pulley at the top of the frame, and thence to a hand windlass or the drum of a hoisting engine. In one kind of pile-driver the rope is attached to the hammer by a sort of tongs which is automatically opened by a tripping device when the top of the frame is reached, thus allowing the hammer to fall. In another form the rope is permanently attached to the hammer, which is set free by loosening a friction clutch, thus allowing the drum to unwind the rope which is pulled down with the hammer. The latter form of driver is the one least commonly used, and is the most expensive in first cost, but is generally regarded as the most efficient.

Drop-hammer pile-drivers are mounted on scows or cars, or may be skidded about on the platform timbers. A steam-hammer pile-driver consists of a steam cylinder in which a piston works, carrying a heavy weight or hammer on the end of the piston rod. This steam cylinder is vertical with the piston rod, extending downward, and is held between the tops of two or four uprights which serve to guide the hammer. The bottoms of these uprights are held together by a cast block pierced with a conical hole which fits over the partly sharpened head of the pile. The hammer has a cylindrical projection which passes through the hole in the base block to strike the pile. The piston stroke is usually about three feet, and the weight of the striking parts is commonly about one and one-half tons. This whole apparatus is swung between the leaders of a pile-driver frame by a rope exactly as is the hammer of a drop-hammer pile-driver. In operation the apparatus is lowered on to the pile until the pile carries its entire weight. By means of flexible hose connections with a steam boiler steam is admitted under the piston, raising it with its attached piston-rod hammer until at the top of the stroke a trip cuts off the steam and the hammer falls by its own weight, striking the pile a heavy blow. At the end of the down stroke the valves are automatically reversed and the stroke repeated. In this way the machine can deliver from sixty to eighty blows per minute, as compared with from six to fourteen blows for a trip drop-hammer driver, and from twenty to thirty blows for a friction drum drop-hammer. While the steam-hammer driver strikes blows having much less energy than those of a drop-hammer driver, it strikes its lighter blows so much more rapidly that it compares favorably with the best friction drum drop-hammer drivers in efficiency.

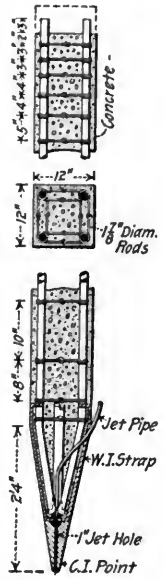

CONCRETE-STEEL PILE.

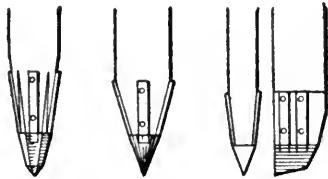

METAL SHOES FOR WOODEN PILES.

ten inches in diameter at the smaller end. Generally the pile is shaped for driving, and sometimes a pointed iron shoe is attached to the pointed end; the top is frequently bound with an iron band to prevent brooming.

Piles are sunk into the soil by several methods, the most common of which is driving by a hammer. The machines used to drive piles by a falling weight or hammer are known as pile-drivers. There are two general forms of such machines known as drop-hammer pile-drivers. In a drop-hammer pile-driver a heavy hammer of iron is pulled to the top of a lofty frame by hand or power and allowed to fall freely on to the head of the pile. The frame consists of two uprights called leaders about two feet apart and from ten feet to sixty feet long, which guide the

The two other forms of pile-drivers are the

gunpowder driver and the water-jet driver. The gunpowder driver is seldom used and is worthy of mention chiefly for its novelty. It consists essentially of a heavy hollow cylinder with its bottom resting on the pile and its top open, which is called the gun. Into the top of the gun fits a sort of piston carrying on its top a mass of iron weighing about 1500 pounds, which is called the ram. In operation the ram is raised, a cartridge of from two to three ounces of gunpowder is placed in the gun, and the ram is let fall. In falling the piston enters the gun, compressing the air and causing sufficient heat to explode the cartridge, when the expansive force of the powder forces the pile down and the ram up. A cartridge is thrown into the gun each time the ram ascends. With this machine thirty to forty blows per minute can be struck with a fall of from eight feet to ten feet. The water jet is not strictly a pile-driver, but it is such a well-known method of pile-driving that it merits mention here. The method is very simple; a jet of water is forced into the soil just below the point of the pile, thus loosening the soil and allowing the pile to sink either by its own weight or with very light blows. The water is conveyed to the point of the pile by a hose which is held to the pile by staples during sinking and pulled up to be used again after the pile is sunk.



SCREW PILE.

Timber piles sunk by the methods just described support their loads partly by the friction of the soil on the sides of the pile and partly as a column by the point resting on an impenetrable material. There are two methods of determining the supporting power of a pile: (1) to note its resistance to penetration under the last blow of the pile-driver hammer, and (2) to load the pile and observe the weight that it will safely stand. The former method is the one generally used, the latter being used simply as confirmatory evidence in doubtful cases. See FOUNDATIONS.

As previously stated, the two most common forms of iron piles are screw piles and disk piles. Sometimes the stem of such piles is of wood, while the screw and disk are of metal. Screw piles for engineering work usually have a shaft from three inches to eight inches in diameter, with screws from three feet to six feet in diameter. They are driven by rotating the shaft just as an ordinary wood screw is driven, capstan bars being usually employed to secure the screwing motion, although hydraulic screwing devices have been occasionally employed. Screw piles will penetrate all ordinary soils. They are seldom used in the United States, but are commonly employed abroad. Disk piles are sunk by the water-jet. At the ocean pier at Coney Island, New York, disk piles were used having wrought-iron shafts $8\frac{1}{2}$ inches in diameter and disks two feet in diameter and nine inches thick. Some of these piles stand seventeen feet in the sand, and carry loads of over six tons per square foot of disk. Consult Baker, *Treatise on Masonry Con-*

struction (New York, 1900). See FOUNDATIONS; LIGHTHOUSE; BRIDGE.

PILE (AS. *pil*, from Lat. *pilum*, javelin, pestle). In heraldry (q.v.), one of the charges known as ordinaries.

PILE-DRIVER. See PILE.

PILE DWELLING. See LAKE DWELLING.

PILES (from Lat. *pila*, ball), or HEMORRHOIDS. Small vascular tumors situated either within or on the verge of the anus. They consist of dilated veins containing either fluid blood or a solid clot, covered with inflamed, infiltrated or permanently thickened mucous membrane. They are termed *internal* when situated above or within the sphincter; *external* when below or outside it. Piles vary greatly in size and structure, and in the symptoms they produce. They may be merely little knots of varicose veins in the submucous tissue; these may in time increase in size, be forced in and out during defecation, become inflamed and strangulated, and even ulcerated and gangrenous. External hemorrhoids usually do not bleed; the internal variety, which extend above the sphincter for an inch or more, are soft, purple irregular masses, and bleed readily when irritated by hardened fecal masses. *Arterial piles* contain, besides a large vein, arteries of some size. These bleed easily and freely, but are comparatively rare. Children are occasionally afflicted with *capillary piles*, small, sessile tumors, which also bleed.

Hemorrhoids are caused by any circumstance which produces long-continued venous congestion in the rectum. Constipation, enlargement of the prostate gland, pregnancy, tumors of the uterus or its appendages, congestion or cirrhosis of the liver, certain diseases of the heart and lungs, sedentary occupations, and relaxing climate, are a few of the causes. Over use of harsh cathartics and horseback riding are also mentioned as factors.

The following are the general symptoms of this affection. The patient, after having experienced for a varying time a feeling of heat, fullness, and dull pain about the lower part of the bowel, becomes conscious of a foreign body in the anus; and, on examination, discovers a small tumor, which either remains outside or is retracted, according as it originated without or within the sphincter. This tumor gradually increases, and others form around it, until a mass at length results as large as a pigeon's egg, or larger. In its ordinary indolent state the tumor has little sensibility, and occasions comparatively little annoyance; but when inflamed it is exquisitely tender to the touch, and is the seat of burning and stinging sensations, rendering the evacuation of the bowels (and sometimes of the bladder also) difficult and painful. In women an inflamed pile may cause pain in the back, and other anomalous symptoms. In severe cases the patient can neither stand nor sit with comfort, and only finds relief in the horizontal position.

Piles may be prevented by active exercise, mild saline catharsis, a light laxative, non-stimulating diet. These measures may also avail to cure or hold in abeyance the affection in its earlier stages; and, with the exception of the first, are always indicated in conjunction with other means of treatment. Scrupulous cleanliness must al-

ways be observed. When inflamed, in addition to the above precautions, piles should be treated by absolute rest, warm fomentations, and the injection of cold water into the rectum several times a day. As the acute symptoms subside, astringent and sedative lotions, such as lead water and laudanum, and extract of hamamelis, may be applied. Internal piles that protrude must be pushed back; if they become strangulated, hot applications are to be used until reduction is possible. For the bleeding, which is sometimes severe, cold applications and injections usually suffice. Hemorrhoids occasionally become so troublesome as to make life a burden, and operation is the only measure that will bring relief. The tumors, if external, may be simply tied with ligatures at the base and cut off. Internal piles may be drawn down with forceps and treated in the same manner. In persistent cases the whole pile-bearing area of mucous membrane may be dissected off and removed, and healthy membrane brought down to take its place.

PILEUS, pi'lé-üs (Lat., cap). The cap-like top of a toadstool. See **BASIDIOMYCETES**.

PILEWORT. An herb. See **RANUNCULUS**.

PILGRIM (OF. *pellegrin*, *pelerin*, *peregrin*, Fr. *pélerin*, pilgrim, from Lat. *peregrinus*, foreigner, pilgrim, from *pereger*, being in foreign lands, from *per*, through + *ager*, field). One who visits some distant place for a religious purpose. The notion that particular localities possess special sanctity is widespread. The gods of primitive religions are local and can only be approached within their proper boundaries or at their peculiar sanctuaries. Hence, when their worshipers become scattered, a journey is necessary to offer devotion or ask for favors. A place where a theophany is supposed to have occurred is naturally considered as consecrated by the divine presence and particularly favorable for answer to prayer. Localities of importance in the history of a religion or in the lives of persons specially revered attract the interest and devotion of the faithful. In religions where self-mortification is considered meritorious or obligatory, the trouble and pains involved in a journey, particularly in times and places where travel is neither easy nor secure, have made of pilgrimage a meritorious act and pious duty. On the other hand, the journey affords opportunity to see the world, satisfies the love of adventure, and provides an outing, and this element is not to be overlooked in tracing the history of pilgrimage.

Pilgrimages are characteristic of many religions, as those of ancient Egypt, Persia in the Mithraic period, Syria, Mexico, and Peru, India, China, and Japan. The Greek and Roman custom of consulting the gods at local oracles, like Dodona and Delphi, is well known. In the early period of Hebrew history there were many local sanctuaries, and pilgrimages to some of them are clearly indicated, as Shiloh (I. Sam. i. 4), Ophrah (Judges viii. 27), Dan and Bethel (I. Kings xii. 30-33). The great Mohammedan pilgrimage to Mecca (see **HAJJ**; **MOHAMMEDANISM**) is a survival of pagan times. Besides this, which is obligatory on every Mussulman, there are numerous devotional pilgrimages, particularly to the tombs of saints. Kairwan (q.v.) in Tunis,

Wazan in Morocco, Kerbela in Mesopotamia (q.v.), and Masjid Ali in Irak are sacred cities, the last two in the estimation of the Shiites hardly second to Mecca.

The early Christians regarded certain places with special religious interest; above all, the Holy Land, and particularly the scenes of the passion of the Lord at Jerusalem. Other sacred places, too, were held to be fit objects of the same visits of religious veneration. The tombs of the Apostles Peter and Paul, and of the martyrs in the catacombs at Rome, are so described by Saint Jerome (*Commentary on Ezekiel*). The pilgrimage, however, preëminently so called, was that to the Holy Land; and even after Jerusalem had been occupied by the Mohammedans, the liberty of pilgrimage, on payment of a tax, was formally secured by treaty; and it was from the necessity of protecting pilgrims from outrage that the well-known military orders (see **ORDER**) had their origin. The Crusades (q.v.) may be regarded as a pilgrimage on a great scale, the direct object being to secure for the Latin Christians immunity of pilgrimage. On the other hand, the final abandonment of the Crusades led to a great extension of what may be called domestic pilgrimage, and drew into religious notice and veneration many shrines in Europe, which, after the lapse of time, became celebrated places of pious resort. The chief places of pilgrimage in the West were: in Italy—Rome, Loretto (q.v.), Genazzano, Assisi; in Spain—Compostela, Guadalupe, Montserrat; in France—Fourvières, Puy, Saint-Denis; in Germany—Oetting, Zell, Cologne, Treves; in Switzerland—Einsiedeln; in England—Walsingham, Canterbury, and many others of minor note. The pilgrim commonly bound himself only by a temporary vow of chastity and other ascetic observances, terminating with the actual visit to the place of pilgrimage, or at least with the return home. He wore a broad hat, a black or gray cloak, girt with a cincture, and carried a long staff. Those who had completed the pilgrimage to the Holy Land brought away a palm leaf and hence were called palmers. A string of scallop shells was the badge of a pilgrim from Compostela, a bottle or bell from Canterbury. Pilgrims had many privileges. They were considered holy men whose person was sacred, and were entitled to entertainment and assistance on their way. Hospices for their accommodation were established in many places, notably in Rome, and are a prominent feature of Jerusalem at the present day. In the course of time many unworthy persons joined the number and brought pilgrimages into disrepute. They have always been maintained in Italy, Spain, Southern Germany, and Switzerland; in France they fell into disfavor during and after the Revolution. In late years, however, pilgrimages on a very large scale, even from the United States, have visited the sanctuaries of Lourdes (q.v.), La Salette, and Paray-le-Monial (q.v.). Another popular European place of pilgrimage is Czenstochowa, in Russian Poland. A famous shrine of the New World is Saint Anne de Beaupré, near Quebec; and large numbers annually visit the place consecrated by the death of the Jesuit martyrs Father Jogues (q.v.) and his companions at Auriesville, N. Y. The Holy Land is visited still by many pilgrims from the Eastern churches, particularly Russian peasants, and a smaller number from Western Europe. For the history of Chris-

tian pilgrimages, consult Marx, *Das Wallfahren in der katholischen Kirche* (Treves, 1842); and for some of the most famous shrines, Northcote, *Celebrated Sanctuaries of the Madonna* (London, 1868).

PILGRIMAGE OF GRACE, THE. The name given to an uprising in the north of England in 1536. The destruction of the smaller monasteries by Henry VIII. angered the country gentlemen and the Commons, who had taken great pride in these institutions and had received educational and other benefits from them. They feared, too, that after this work was done, Cromwell, the King's evil genius, would plunder even the parish churches. This was the chief grievance which drove 60,000 men of Lincolnshire to rebellion. Though they soon dispersed, a more formidable uprising in Yorkshire took place under the lead of Robert Aske, a gentleman and barrister. Priests encouraged the movement. The rebels, calling their march the Pilgrimage of Grace, and carrying a banner embroidered with the five wounds of Christ, demanded a renewal of the connection with Rome, restoration of the monasteries, and punishment of Cromwell. As the King's forces could not cope with the insurrection, he promised to call a Parliament in the north to settle the grievances. The rebels thereupon returned to their homes; but, far from keeping his word, Henry not only put to death twenty leaders of the rebellion, but covered the whole north with gibbets.

PILGRIM FATHERS. A name given to those emigrants who came to America early in the seventeenth century on account of religious differences in England, and founded the colony of Plymouth. They were Separatists and members of John Robinson's congregation in Leyden, whither they had come from England. They are to be distinguished religiously from the Puritans of England. See CONGREGATIONALISM; MASSACHUSETTS; ROBINSON, JOHN.

PILGRIM'S PROGRESS, THE. A famous allegory by John Bunyan, the first part printed in 1678, the second in 1684. The first part describes the journey of Christian to the Celestial City; the latter, the journey thither of his wife, Christiana, and her children. This drama of the soul's progress through life was written in Bedford prison, probably in 1675-76, and not during Bunyan's earlier and longer imprisonment. The pilgrim idea of life was an old one, but was never worked out in so powerful a manner as by this humble Puritan, whose only helps were his Bible and Fox's *Book of Martyrs*.

PILGRIM'S TALE, THE. A poem erroneously attributed to Chaucer, as one of the *Canterbury Tales*. A confused story was told of it by the son of Thynne, who edited Chaucer's works in 1532, and is said to have printed it. But it is not found in either of Thynne's editions. It appeared in *The Courte of Venus*, a collection of verse published about 1536, in which it is credited to Chaucer. Only two fragments of this work exist in Oxford, one of which contains the *Tale*.

PILKINGTON, LETITIA (1712-50). An Irish adventuress, born in Dublin. She was the daughter of Dr. Van Lewen, and married Matthew Pilkington, an Irish clergyman, in 1729. Swift, then Dean of Saint Patrick's, in Dublin,

was attracted by her vivacity and ingenuous manners, and helped her improvident husband to get a position in London. Afterwards, the pair were divorced, and Mrs. Pilkington lived in Ireland and England, befriended by Colley Cibber, Samuel Richardson, and others. The *Memoirs of Mrs. Letitia Pilkington . . . written by herself, wherein are occasionally interspersed all her poems . . .* (3d ed., 1754), have been harshly criticised for their lack of truth, but they are written in an engaging style and include many anecdotes of Swift and bits of personal biography, not touched upon by others. Thackeray uses them freely in his *English Humorists*.

PILL (from Lat. *pilula*, abbreviated in mediæval prescriptions to *pil.*, plural *pill.*, pill, little ball, diminutive of *pila*, ball). The most convenient and popular form of medicine. Pills are globular masses of a size convenient for swallowing, and of a consistence sufficient to preserve their shape and yet not so hard as to be difficult of solution in the stomach or intestines. They are especially suitable for remedies which operate in small doses, as the metallic salts; substances whose action it is desired to retard until they have reached the intestines; bodies whose specific gravity is too inconsiderable to allow their suspension in aqueous vehicles; and substances which are disagreeable to the taste or smell. The pill form is, on the other hand, unsuitable for medicines which it is necessary to give in large doses; fluid or semi-fluid substances, such as oils, balsams, etc., which require a very large proportion of some dry powder to make them into a mass; and substances so insoluble that when exhibited in solid form they pass through the intestinal canal unaltered, as extract of logwood. Many substances, such as vegetable extracts, may be at once formed into pills without any addition; but most of them require an excipient for converting them into a pill mass. The excipients in common use are bread crumbs, soap, extract of licorice, mucilage, syrup, molasses, honey, castor oil, and confection of roses; the latter is probably the most generally useful, from its property of remaining soft for a considerable length of time. It is common to place pills in some fine powder to prevent them from adhering to each other and to conceal their taste. For this purpose licorice powder, wheat flour, starch, magnesia, and lycopodium are employed. Pills made in large numbers and by machinery are often coated with sugar, variously colored and flavored, gelatin, keratin, and other materials. Pills retain their moisture and activity much longer in bottles than in pasteboard boxes. The ordinary weight of a pill is five grains; if it much exceeds that weight it is too bulky to swallow conveniently, especially if it consists of vegetable matter. A pill much larger than this is called a bolus, while very small pills are known as granules. See CAPSULES.

PILLAR (OF. *pilier*, *pilier*, Fr. *pilier*, from ML. *pilare*, *pilarius*, *pilarium*, *pillare*, pillar, from Lat. *pila*, pillar, pier, mole). A term used by unscientific writers on architecture to designate a support of masonry, of any form—round, square, or polygonal—more properly called column or pier, according to its shape.

PILLAR SAINT, or STYLITE. One of a remarkable class of ascetics, chiefly of Syria, who,

with a view to separating themselves more completely from earth and fellow-men, took up their abode on the tops of pillars, and remained thus without descending to earth, exposed to all the variations of climate or sheltered only by a hut built on top of the pillar. The earliest of these and the most celebrated, was Saint Simeon or Simon Stylites, a Syrian monk, who was born near the close of the fourth century, and is said at first to have lived for ten years in extreme seclusion in his monastery in the neighborhood of Antioch, without ever moving from his narrow cell. Increasing in enthusiasm, about 423 he withdrew from the monastery, and built a pillar, on the top of which, only a yard in diameter, he took up his position. From this pillar he removed to several others in succession, each higher than its predecessor, till at last he attained to 40 cubits, or about 60 feet in height. In this life he spent 37 years. Many remarkable stories are told of his austerities, and he acquired the reputation of a miracle-worker. The fame of his sanctity brought crowds of pilgrims from the most distant countries to see him; and he is said to have converted many to the Church. A disciple of Simeon, named Daniel, succeeded to his reputation for sanctity, and to his mode of life, which he maintained for 33 years, in the still more trying climate of the shores of the Bosphorus, about four miles from Constantinople. In Syria there were many pillar saints as late as the twelfth century; after the sixteenth century they disappeared altogether. In the West there is only a solitary example. A monk named Wulfaicus, near Trèves, attempted the pillar life in the sixth century, but the neighboring bishops compelled him to desist, and destroyed his pillar.

PILLARS OF HERCULES. See HERCULES, PILLARS OF.

PILLAU, pil'lou. A seaport town, fortress, and bathing resort of Eastern Prussia, situated on the southern end of a tongue of land separating the Frisches Haff from the Baltic Sea, at the entrance to the former and about 25 miles west of Königsberg, with which it is connected by a navigable channel (Map: Prussia, J 1). It is the outer port of Königsberg.

PILL BEETLE. A beetle of the family Byrrhida, a term used by English collectors. The group is a small family of 200 to 300 species, of which about 40 occur in the United States. They are small insects, move very slowly, and when disturbed at once contract the limbs so completely that they look like inanimate objects.

PIL/LING, JAMES CONSTANTINE (1846—). An American ethnologist, born in Washington, D. C. He was educated at Gonzaga College in that city, and while with Major J. W. Powell on the Rocky Mountains Geological Survey (1872-79) had opportunity for studying aboriginal dialects. In 1881 he was appointed chief clerk of the Bureau of Ethnology, and ten years afterwards was made head of the same bureau in the Smithsonian Institution, Washington. He catalogued the *Linguistic MSS. in the Bureau of Ethnology* (1881) and made bibliographies of the following Indian languages, which were published by the Government: *Siouan* (1887), *Iroquoian* (1888), *Muskhogeian* (1889), *Algonquin* (1891), *Atha-*

pascan (1892), *Chinookan* (1893), *Salishan* (1893), and *Wakashan* (1894).

PILLNITZ, pil'nīts. A palace and ordinary summer residence of the royal family of Saxony, in a beautiful situation, six miles southeast of Dresden. Pillnitz acquired a historic interest from the meeting of Leopold II. and Frederick William II. held in the castle in August, 1791, when the declaration of Pillnitz was framed, in which Austria and Prussia affirmed that the affairs of King Louis XVI. (then a prisoner in the Tuileries, after his ineffectual attempt to escape from France) were a matter of common interest to the sovereigns of Europe, and expressed the hope that common cause would be made for his restoration. The Emperor and the King of Prussia were resolved to use force in order to effect this result; but any immediate interference on their part was rendered unnecessary by Louis's acceptance of the Constitution as modified by the National Assembly, after which he was again placed on the throne.

PILLORY (OF, Fr. *pilori*, from Prov. *espilori*, pillory, from Lat. *speculatorius*, relating to an observer, from *speculator*, observer, investigator, scout, spy, from *speculare*, to view, from *specula*, watch-tower, from *specere*, to see). An obsolete instrument for the public punishment of criminals. It consisted of two parallel boards, joined by sliding hinges and fixed like a sign-board on the top of a strong pole, supported on a wooden platform elevated above the ground. A large circular hole with its centre in the line of junction of the two planks received the neck, and two corresponding holes of smaller size, one on each side of it, the wrists. The pillory existed in England before the Conquest, in the form of the *halsfang* or catch-neck, an instrument by which the neck only was confined; according to the 'statute of the pilory' of Henry III. it was originally intended for "forestallers, users of deceitful weights, perjury, forgery, etc.," and all such dishonorable offenses. Its use was confined to this class of offenders till 1637, when restrictions were put upon the press, and all who printed books without a license were put in the pillory. From this time it became the favorite mode of punishing libelers, authors and publishers of seditious pamphlets, or of strictures on the Government, and many eminent men suffered on the pillory. The inadequacy of the pillory as a means of inflicting punishment, however, became apparent, for to those who were popular favorites it was no punishment, while those who were objects of popular dislike were ill-used to such an extent as occasionally to suffer death. In France the pillory was anciently called *pilori*, and later *carcan*, from the iron collar by which the criminal's neck was attached to the post; but punishment by this mode was abolished in that country in 1832. It was also in use in Germany, where it was known as the Pranger. The use of the pillory was abolished in England in 1837, and in the United States, where early statutes had provided for its use in the case of some offenses, in 1839.

PIL/LOW, FORT. See FORT PILLOW.

PILLOW, GIDEON JOHNSON (1806-78). An American lawyer and soldier, prominent as an officer in the Mexican War, and on the Confederate side in the Civil War. He was born in

Williamson County, Tenn.; graduated at the University of Nashville in 1827; and commenced the practice of law in Columbia, Tenn., in the following year. He was commissioned brigadier-general and placed in command of the Tennessee volunteers on the outbreak of the Mexican War in 1846. He served for a short time in the Northern campaign under General Taylor, then joined General Scott before Vera Cruz; commanded the right wing of the American army at Cerro Gordo, where he was severely wounded; was promoted to be major-general in April, 1847; and participated in the battles of Contreras, Churubusco, and Chapultepec. After the war he was charged with insubordination by General Scott, but was honorably acquitted by a court of inquiry. He then returned to the practice of the law in Tennessee, and took an active interest in politics. On the outbreak of the Civil War he entered the Confederate service and was appointed brigadier-general. He was in command against Grant at the battle of Belmont on November 7, 1861; was second in command at Fort Donelson under General Floyd, with whom he escaped on the night before the surrender to Grant by General Buckner (see FORT HENRY AND FORT DONELSON); was temporarily relieved from command; and subsequently served under Beauregard in the Southwest and acted as chief of conscripts in the Western Department.

PILLSBURY, HARRY N. (1872—). An American chess-player, born in Boston, Mass. A strong taste for mathematics early led him to the study of chess. At the International Chess Congress held at Hastings, Eng., in 1895, he won the world's championship over a group of famous experts, the first American since Paul Morphy to attain to that honor. He became the principal American representative at foreign tournaments and in international cable matches, and was always distinguished for his strong, careful, and original play. His more recent successes were at Vienna in 1898, where he tied with Tarrasch for first place, at London in 1899, where he divided second honors with Janowsky and Maroczy, and at the American tournament in Buffalo in 1901, where he won first prize.

PILLSBURY, JOHN SARGENT (1828-1901). An American merchant and politician, born at Sutton, N. H. He received a common-school education, and in 1855 settled at the Falls of Saint Anthony, Minn., where he opened a hardware store. In 1872 he became a partner in the firm of Charles A. Pillsbury & Co., flour-millers. From 1864 to 1876 he was a State Senator, and from 1876 to 1882 was Governor. During his administration he persuaded the people to pay off the State debt, which they had repudiated twenty years before. He gave generously to the University of Minnesota and other public institutions, built a town hall for Sutton, his birthplace, and founded a library for workmen in East Minneapolis.

PILLSBURY, PARKER (1809-98). An American abolitionist, born at Hamilton, Essex County, Mass. He removed to Henniker, N. H., in 1814; about 1829 began to drive an express wagon between Boston and Lynn; afterwards was a farmer; in 1835-38 studied at the Gilmanton (N. H.) Theological Seminary, and in 1838-39 at the Andover Theological Seminary.

In 1839 he was licensed to preach, and in 1839-40 was pastor of the Congregational Church at New London, Merrimack County, N. H. He then withdrew from the ministry, enlisted in the anti-slavery movement, was for a short time editor of the *Herald of Freedom*, at Concord, N. H., and then became a lecturer in New England and the West. In 1854 he visited England in the interest of the movement. He was fanatical in his views and violent in his methods. He joined Phillips in the meetings of the American Anti-Slavery Society and elsewhere in opposition to the reelection of Lincoln. His attacks upon the Church, owing to the attitude of the pulpit toward anti-slavery reformers, were particularly bitter. Upon the dissolution of the American Anti-Slavery Society, whose continuance for philanthropic work among freedmen he had urged, he became a preacher for free churches at Salem and Toledo, Ohio; Battle Creek, Mich.; and other towns of the West. He published some pamphlets, including the text of a lecture, "The Plague and Peril of Monopoly" (1887); *Acts of the Anti-Slavery Apostles* (1884); and *The Church as It Is* (1885). The *Acts* contains an autobiographical sketch.

PIL/MOOR, JOSEPH (1739-1825). One of the founders of Methodism in America. He was born at Tadmouth, in the North Riding of Yorkshire; educated at the Kingswood school; entered the ministry in 1765; came to America in 1769 and labored in New York and Philadelphia. He returned to England in 1774; because he was not included by Wesley in the 'legal hundred' he was offended and retired in 1785. Returning to America, he became a member of the Protestant Episcopal Church, and was ordained by Bishop Seabury the same year. He still ministered in New York and Philadelphia, the last twenty years of his life being spent as rector of Saint Paul's Church in the latter city, where he died. His journal in manuscript is the property of the Methodist Historical Society of Philadelphia; a portion of this has been published under the title *The Western Pioneers* by John P. Lockwood (London, 1881).

PILOCARPINE. See JABORANDI.

PILON, πῆλον', GERMAIN (c.1535-90). A French sculptor of the High Renaissance. He was born in the Faubourg Saint Jacques, Paris, about 1535, as is known by a document of 1573. His father was a stone-cutter from whose instruction he passed to that of Pierre Bontemps. At the age of twenty-three he was engaged with Pierre Bontemps in the execution of a fine monument of Francis I. in the Church of Saint Denis. In 1561 was undertaken the extremely important group in the Louvre of three Graces supporting a bronze vase, which formerly contained the heart of Henry II. After the year 1565 Pilon was much occupied with the decoration of the monument of Henry II. in Saint Denis. All the sculpture of this monument was formerly attributed to him, but it is now known that only the kneeling statue of the Queen and the reclining statue of the King are his. Other equally fine work on this monument is by Freymyn Roussel, Laurent Regnaudin, Dominique Florentin, and Girolamo della Robbia. One of the most charming of the works attributed to Pilon is the mantel now in the Louvre which formerly stood

in the Chateau of Villeroy. In 1571 he had lodgings in the Hotel de Nesle and assisted in arranging the triumphal entry of Charles IX. into Paris. In 1573 he was appointed comptroller-general of the coinage. It is supposed that he made the great bronze medals of the Valois, the most interesting of which are those of Catharine de' Medici and Henry III. In 1587 he made the monument of the Abbé Joseph Foulon for a chapel of Sainte Geneviève in Paris. Pilon died February 5, 1590. His reputation as a sculptor of the High Renaissance in France is second only to that of Goujon. Consult: Lami, *Dictionnaire des sculpteurs français* (Paris, 1898); Paulstre, *La Renaissance en France* (ib., 1885).

PILOT (OF. *pilote*, Fr. *pilot*, probably from OF. *piloter*, *pilotier*, to sound with plummet and line; probably connected with Dutch *peillood*, sounding-lead, from *peilen*, MDutch *peylen*, *pijlen*, from MDutch *peyelen*, to gauge, from *pegel*, capacity of a ship's gauge + *lood*, MDutch *loot*, Goth. *lōþ*, Ger. *Lot*, AS. *lead*, Eng. *lead*). A person who makes a business of conducting vessels in and out of port, through narrow channels, up rivers, or along coasts where the navigation is specially difficult or dangerous. He is possessed, or supposed to be possessed, of sufficient knowledge of all reefs, rocks, shoals, currents, and other dangers to navigation in the region for which he professes to be, or is licensed as, a competent pilot. Except in little frequented ports, pilots are usually members of a pilot association or company organized under authority of law; and they are required to pass examination as to fitness before being appointed or licensed. The pilotage fees are not retained by the pilot in each case, but are paid into a common fund which is divided among the members according to the rules of the association. In order to furnish a sufficient fund for the payment of an adequate supply of pilots, pilotage is compulsory in many ports, but in these places vessels usually need pay only half pilotage if they do not actually take a pilot. In ports which are not very easy of entrance marine insurance policies usually require that local pilots be employed under penalty of forfeiture of the policy. Masters of vessels frequenting particular ports very commonly take out pilot license to reduce the expense of entry and departure. Pilots may be found off all large ports. They are usually carried in small fast sailing schooners, but in recent years some pilot boats are steam vessels. Pilot boats carry numbers which are placed on the sail or conspicuously painted on the hull (if a steamer). A century ago a pilot was a necessity for a ship entering a locality unfamiliar to the captain or master, but the great improvement in charts, the increase in the number of light-houses, buoys, beacons, and other aids to navigation, and the change of motive power from sail to steam in more than half the large vessels of the world have contributed to lessen the pilot's importance.

PILOT FEE. The sum of money paid to a pilot for his services in guiding a vessel in or out of a harbor is called *pilotage*. Where a pilot is engaged by the proper officer of a vessel the pilotage is a lien on the vessel. Consult Benedict, *American Admiralty* (New York, 1870).

PILOT, THE. A sea-tale by James Fenimore Cooper (1823). It is the story of an attempt

made during the American Revolution to kidnap some prominent Englishmen for exchange. An American frigate off the English coast takes on a pilot, who is the famous Paul Jones. The plot fails, and the crew are rescued from peril, arising from Colonel Howard, an American loyalist refugee.

PILOT CHART. The Pilot Charts of the North Atlantic and of the North Pacific Oceans, issued monthly from the United States Hydrographic Office, Navy Department, Washington, give, in a form suitable for use by seamen, a general view of the climatological conditions prevailing over each of these oceans during the successive months of the year, with certain deductions therefrom, along with a large amount of additional information, meteorological and otherwise, which is likely to prove of value to navigation. The charts are drawn on the Mercator projection, that of the North Atlantic extending from the equator to 60° north, and from the meridian of 10° east to 102° west; that of the North Pacific from the equator to 70° north and from 75° west to 117° east. Each of the charts is published some days prior to the first day of the month to which it refers. They are lithographed in three colors, black, blue, and red, the color serving, within certain limits, as an index to the character of the information conveyed. The base of the chart, along with such information as is invariable throughout the year, is printed in black. Among other matter this embraces the lines of equal magnetic variation (see SHIP'S COMPASS; MAGNETISM; TERRESTRIAL) for the current year, than which no feature of the chart is more highly appreciated by navigators, owing to the almost universal employment of the Pilot Chart as a track chart, upon which the position of the vessel from day to day is plotted. See SAILING.

For the purpose of climatological study the surface of the ocean is supposed to be divided into rectangular areas by the even five-degree parallels of latitude and meridians of longitude, 5°, 10°, 15°, etc. The Pilot Chart for any month gives in blue for each of these areas the atmospheric pressure and temperature prevailing under normal conditions, the average force of the wind, the number of hours within the month during which the wind may be expected to blow from a given quarter, and the frequency of calms, derived from a discussion of the observations taken within the same month during previous years. All of this is shown symbolically upon the face of the chart. In addition to this there is also given in blue a brief text, containing a forecast or statement of the average conditions that may be expected during the month for the more frequented parts of the ocean, the probability of storms, the nature of these storms, the frequency of fog (upon the Pilot Chart of the North Atlantic Ocean this is also shown graphically upon the face of the chart), and the limits within which dangerous masses of floating ice may be expected. The proper sailing and steamship routes for the given month and the limits of the trade winds are also exhibited.

The information given in red is in the nature of a review. Upon the Pilot Chart of the North Atlantic Ocean it comprises a brief account of the main features of the weather over that ocean during the month preceding the date of publica-

tion of the chart. The path followed by the centre of each of the more important barometric depressions that have occurred within that period is shown, and the force of the winds which accompanied them, the latter on the Beaufort scale. The region through which fog has been frequent is also shown. Upon the Pilot Chart of the North Pacific Ocean there appears the average track followed by the centres of the barometric depressions for the month that occurred during the ten-year period 1878-1887; also the tracks followed by the centres of the various classes of typhoons, those terrific storms which render navigation in East Asiatic waters so fraught with danger. Upon both charts is given in red the last reported position of floating derelicts, wreckage, buoys, and other obstacles to navigation. Recently reported icebergs and field ice are also shown, all of these being plotted upon the chart precisely where last sighted, in order that the mariner may have the dangers which menace his vessel constantly in view, without dependence upon his memory and without reference to any publication save the chart before him.

Other features of the chart are the list of equator crossings for several future months, intended for the use of vessels bound on distant voyages; the list of new charts recently published and of additions and corrections to old; the storm warnings displayed by the United States and by other maritime nations, all of which are shown graphically. In addition to these the land space of the chart is always devoted to a discussion of some topic of interest to navigators, such as studies in the law of storms, the experience of various vessels in recent cyclones, recent improvements in the theory and practice of navigation, the relative advantages of different sailing routes, and other similar subjects. The reverse of the chart is also frequently utilized for this purpose, one of the interesting publications of the United States Hydrographic Office being the chart which appears annually upon the back of the Pilot Chart, showing the drift of sealed bottles which are cast overboard in various parts of the ocean and find their way to distant shores.

As in the days of Maury, so now the United States Government is still the pioneer in this class of publications for the benefit of seamen. The first edition of the Pilot Chart of the North Atlantic Ocean appeared in December, 1883, that of the North Pacific Ocean in January, 1894. The German Government and also the English have recently entered the field, each of these having in January, 1901, begun the publication of a chart of the North Atlantic embodying many of the features of the American Pilot Chart. The German chart bears the title *Nordatlantische Wetterauschau*, and is published monthly by the Deutsche Seewarte, Hamburg, Germany. The British Pilot Chart extends also over the Mediterranean Sea, and is published monthly by the Meteorological Office in London. See HYDROGRAPHIC OFFICE.

PILOT-FISH, or ROMERO. A fish (*Naucrates ductor*) of the family Crangidae, resembling the mackerel, except that there are no finlets succeeding the dorsal fin. It gets to be about two feet long; the general color is silvery grayish-blue, five dark transverse bands passing around the whole body. Its flesh is said to be very delicate, resembling mackerel in flavor, but it is not often

met with in the markets. It is the only species of the genus, and is widely distributed through the tropical seas. It is often seen in the company of a shark, and is therefore very commonly supposed to direct the shark to its prey. The facts probably are that the pilot-fish, in company with sharks and other fishes, follow in the wake of vessels for the purpose of picking up anything edible that may fall from the ship. It is not impossible that the pilot-fish finds it a decided protection against enemies to be associated with the shark, and in this way has developed the habit. A related fish, one of the amberfishes, is often called 'shark's pilot;' it is *Scriola zonata*, of the American coast from Cape Cod to Cape Hatteras; and a West Indian demoiselle (family Pomacentridæ, *Eupomacentrus leucostictus*) is called 'black pilot,' or 'cockeye pilot.' The name 'pilot-fish' is also given to the 'round' whitefish (*Corcogonus quadrilateralis*) of the Great Lakes.

Consult: Goode, *Fishery Industries* (Washington, 1884); Bennett, *Gatherings of a Naturalist in Australia* (London, 1860). See Plate of HORSE MACKERELS AND ALLIES.

PILOT KNOB. A conical hill in Iron County, Missouri, 75 miles southwest of Saint Louis (Map: Missouri, F 4). It is about a mile in diameter at its base, and consists of beds of iron ore, porphyry, and porphyry conglomerates. The ore is hard, specular, steel-gray in color, extremely brittle, and with a faint lustre. A few miles to the northwest is Iron Mountain (q.v.).

PILOT MOUNTAIN. A mountain in North Carolina. See ARARAT.

PILOT SNAKE. (1) A North American blacksnake which is black or brown above, with or without darker squarish spots; the belly is very darkly clouded, and the head not banded. It is common from New Jersey to Texas, especially in the Middle States, where it is often called 'mountain blacksnake,' but is known to the mountaineers of the Alleghenian ranges as 'pilot snake.' It is a denizen of forests to a great extent, hiding in hollow logs and in holes of old trees. It climbs trees easily, and in the spring feeds largely upon birds and their eggs, and fledglings; otherwise its prey is mainly mice, rabbits, and other small animals. It is not only entirely harmless,

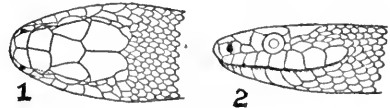

PILOT SNAKE (*Coluber obsoletus*).
1, Top of head; 2, profile.

but remarkable for gentleness, making little resistance to being handled, and soon becoming tame. Stejneger says this species deposits its eggs in hollow stumps and similar places, where they hatch in early summer. Consult Cope, *Crocodylians, Lizards, and Snakes* (Washington, 1900).

(2) A local name in the Eastern States for the copperhead (q.v.).

PILOTY, pã-lô'tê, KARL VON (1826-86). A German historical painter, famous for having revived the color element in the modern

German school of painting. He was born in Munich, October 1, 1826, the son of the lithographer Ferdinand Piloty (1786-1844), and was first instructed by his father. Entering the Academy at the age of twelve, he was even then an excellent draughtsman, assisting his father, whose lithographic business he managed after the father's death. Impressed by the coloring of the works of Gallait and Biéve, exhibited at Munich in 1843, he made a study trip in 1847 to Venice, where Paul Veronese especially claimed his attention. He also studied in Antwerp and Paris (1852), becoming thoroughly imbued with the spirit of the Belgian and French colorists, as is shown by his "Young Mother Dying" (1849), and "The Nurse" (1853). The latter, which was particularly commended for its brilliant technique and the realistic conception, foreboded a new era in the school of Munich, then under the influence of Cornelius's (q.v.) cartoon-painting. The success of this picture brought him the commission to paint for the Maximilianeum "The Founding of the Catholic League in 1609" (1854). The great triumph achieved with his "Seni Before the Body of Wallenstein" (1855, New Pinakothek, Munich) led to his appointment as professor at the Academy in 1856. His remarkable career as a teacher soon made the school of Munich the foremost in Germany. On a visit to Italy in 1858 he made the studies for his "Nero on the Ruins of Rome" (1861, National Museum, Budapest). His principal works during the next decade include "Galilei in Prison" (1861, Cologne Museum), "Godfrey of Bouillon and the Crusaders Approaching the Holy Sepulchre" (1862, Maximilianeum, Munich), and the "Death of Caesar" (1865, Hanover Museum), which is considered his most perfect work as regards composition. He was called to Berlin in 1869, but was induced by the personal appeal of King Louis II. to remain in Munich, and given the commission to paint "The Triumph of Germanicus" (1873, New Pinakothek), a replica of which is in the Metropolitan Museum, New York.

On the death of Kaulbach in 1874, Piloty was appointed director of the Academy, and soon after his appointment he began the huge allegorical painting of "Monachia" (completed 1879) for the new City Hall. Strangely conspicuous as his only biblical subject appears the parable of "The Wise and Foolish Virgins" (1881, Metropolitan Museum, New York). His last works were "Under the Arena" (1883), "The Council of Three in Venice" (1885), and "The Death of Alexander the Great" (1886, National Gallery, Berlin), which he left unfinished, succumbing to a painful disease at Ambach, on the Starnberger See, July 21, 1886.

His brother FERDINAND (1828-95), born in Munich, studied under Schorn at the Academy and worked subsequently under Karl's influence. His name is favorably known through historical frescoes in the National Museum, Munich, the town hall at Landsberg, and the castles of King Louis II. Among his oil paintings may be mentioned "Queen Elizabeth Reviewing Her Army in Sight of the Armada" (Maximilianeum), and "Sir Thomas More in Prison Visited by His Daughter" (Wiesbaden Gallery). He also deserves notice as an illustrator for the Schiller and Shakespeare Galleries. Consult: Regnet, *Münchener Künstlerbilder*, ii. (Leipzig, 1871); Pecht,

Deutsche Künstler des 19. Jahrhunderts, iii. (Nördlingen, 1881); Muther, in *Allgemeine deutsche Biographie*, xxvi. (Leipzig, 1888); and Rosenberg, *Geschichte der modernen Kunst*, iii. (ib., 1889).

PILPAI, pil'pi. See BIDPAI.

PILS, ISIDORE (1813-75). A French historical and military painter, born in Paris. He was the pupil of Lethière, and of Picot; studied at the Ecole des Beaux-Arts and won the Prix de Rome in 1838. His picture "Rouget de Lisle Singing the Marseillaise" (1845) attracted much attention. After the Crimean War he painted several rather formal, heavily colored military pictures, such as "The Battle on the Alma" (1861, Versailles Museum), and "Disembarkation of the Troops in the Crimea." He also decorated (1875) the ceiling of the staircase in the new opera-house in Paris with allegorical subjects. He was appointed professor at the Ecole in 1863, and was made a member of the Institute in 1868, and an officer of the Legion of Honor in 1867. He received a first-class medal, Paris Exposition, in 1867, and a medal of honor at the Salon of 1861. His art resembles Picot's, but is more realistic. Consult Becq de Fouquières, *Isidore Pils* (Paris, 1876).

PILSEN, pil'zen (Bohem. *Plezeň*). The second largest city of the Austrian Crownland of Bohemia, situated in a fertile valley at the confluence of the Mies and the Radbusa, 68 miles southwest of Prague (Map: Austria, C 2). It is well laid out and has many fine structures, among which are the Gothic Saint Bartholomew's Church (1292), with the highest spire in Bohemia, 337 feet; a town hall in Renaissance style, built in 1556, containing the banquet hall in which Wallenstein (q.v.) received the oath of fidelity from his generals; a number of museums; various schools and gymnasia; and a municipal brewery. The brewery occupies a complete district of the town, the cellar alone being four miles long. Pilsner beer is famous all over the world. Aside from its breweries, Pilsen has wire works, bell foundries, paper mills, refineries, glass-blowing establishments, copper works, potteries, etc. The city is governed by a burgomaster and a council of 36 members.

Pilsen's population is increasing rapidly. In 1900 it was 27,232, mostly Czechs. In its early days Pilsen was fortified and during the Hussite Wars it suffered severely. In 1634 twenty-four followers of Wallenstein were hung in the market place. The first printing press in Bohemia was set up in Pilsen (1468).

PILZ, pilts, VINCEZ (1816-96). An Austrian sculptor, born at Warnsdorf, Bohemia. He studied at the Vienna Academy, at first painting, then sculpture under Kähssmann and Bauer, and in Rome (1849-55) was the pupil of Tenerani and Cornelius. After his return to Vienna he was influenced by Führich and afterwards by Rahl, under whose direction he produced numerous reliefs, statues, and groups. These include "Science and Commerce," for Windsor Castle; the two "Winged Horses" in front of Memorial Hall at Philadelphia, and in Vienna the "Neptune Group" at the Exchange, six statues of antique celebrities for the Museum, ten of composers for the Conservatory, and several of generals for the Arsenal, besides many others for various public buildings.

PIM, BEDFORD CAPPERTON TREVELYAN (1826-86). An English admiral, born at Bideford, Devonshire. He was educated at the Royal Naval School, and later took part in the search for Sir John Franklin. He was in the Crimean War, was dangerously wounded in China in 1857, and the next year was promoted to be commander. While on the Central American station, in 1859, he surveyed the Nicaragua Canal route and later organized a company to construct a railroad over this route, which failed to secure subscriptions. He was retired from the service in 1861, though his name was left on the list and he was in 1885 promoted to be rear-admiral. In 1873 he was called to the English bar and he was returned to Parliament in 1874-80. His writings include *The Gate of the Pacific* (1863), *An Essay on Feudal Tenures* (1871), and *The War Chronicle* (1873).

PIMA, pē'má. One of the leading tribes of the Piman stock (q.v.). Before being collected upon Gila River and Salt River reservations, Arizona, where they now reside, they roamed, jointly with the Papago, who are practically the same people, over all the territory from the middle Gila southward to Sonora, Mexico. According to their own traditions, which seem to be confirmed by archeological evidence, they formerly lived farther to the northeast, in the Salado River valley, where they had permanent pueblo towns and irrigating canals. Being driven out by hostile tribes, they gradually moved down the Gila valley, halting on their way long enough to build and occupy the noted Casa Grande ruins. In their new homes on the Gila they ceased to build substantial structures and contented themselves with dome-shaped huts of poles covered with thatch and earth. They retained their agricultural habit, fertilizing their fields by means of extensive irrigation canals, and cultivating corn, beans, pumpkins, melons, and cotton, men and women working together. They also prepare a sort of bread from the mesquite bean, and a liquor from the great Zaguara cactus. The women make pottery and weave beautiful water-tight baskets. (See Colored Plate of INDIAN BASKETS, under BASKET.) They were brought under the influence of Spanish missionaries at an early period, but revolted under their chief, Don Luis, in 1751, destroying all the missions, with every other Spanish settlement in their country. They were subdued after about two years of fighting and have since remained at peace with the whites, although until recently obliged constantly to defend themselves against the raiding Apache. They bear a high reputation for courage, industry, and honesty. They number on the two reservations 4950. For about seventy years the weaker Maricopa (q.v.) have been associated with them. See PIMAN STOCK.

PIMAN STOCK. An important group of cognate tribes occupying nearly the whole of the west coast and Sierra Madre region of Mexico and Arizona from the Gila River southward into Jalisco, and including, besides other tribes and subtribes, the Huichol, Mayo Opata, Papago, Pima, Tarumari, Tepehuan, and Yaqui. According to Buschmann, Gatschet, Brinton, and others they, together with the Nahuatlán tribes, are in fact an extension of the great Shoshonean stock (q.v.) of the United States. As a rule they are sedentary and agricultural, nearly in the culture

states of the Pueblo tribes, but perhaps not quite so far advanced in house-building. Owing to the nature of their country, which makes inter-communication generally difficult, their systems of government are usually communal rather than tribal. Although as a body not aggressive, some of their tribes, notably the Yaqui and Tepehuan, have maintained a determined resistance to the Spanish and the Mexicans. The whole number may be about 120,000, of whom the Tarumari make perhaps one-half.

PIMENTO. See ALLSPICE.

PIMPERNEL (OF., Fr. *pimpernelle*, from ML. *pimpernella*, *pimpinella*, *pipenella*, *pipinella*, with the original initial *b* assimilated to the following, *bipinella*, *bimpinella*, *bibanella*, *pimpernel*, from Lat. *bipennis*, two-winged, from *bi*, two + *penna*, *pinna*, wing), *Anagallis*. A genus of annual and perennial plants of the natural order Primulaceae, natives chiefly of temperate climates, with beautiful but small flowers. Several species are cultivated in flower gardens; others are weeds. Among the best known are the scarlet pimpernel (*Anagallis arvensis*); the blue pimpernel (*Anagallis carulea*), a form of the preceding; and the bog pimpernel (*Anagallis tenella*). These are all European species. The water pimpernel (*Samolus Valerandi*), also called brookweed, is a European plant of the same order and of almost worldwide distribution, growing in watery gravelly places. It has racemes of small white flowers.

PIN (AS. *pinn*, from ML. *pinna*, pin, nail, peak, Lat. *pinna*, *penna*, feather, wing, fin, pen). Probably the pin in its most primitive form of a spike, thorn, or fish-bone was employed long before the earliest needle and thread, as a means of fastening a garment together. (See NEEDLE.) Among the remains of the lake dwellers of Central Europe have been found a great number of pins, some of bone, others of bronze. Many of these are quite elaborate, with ornamental heads, while others are rudely fashioned. Some have double stems and a few have been found in form exactly like the modern safety pin. Examples of artistically wrought pins are found among Egyptian as well as Greek remains. Ancient Roman bronze pins and bone hair-pins, with ornamental heads, have been found at Pompeii. The Romans also made very elaborate fibulae, the prototype of the modern brooch. That simple pins, consisting of heads and shank with a sharpened point, were much used and highly esteemed by the nations of antiquity is proved by the frequent allusions to them in proverbs and other literature. As a requisite of the toilet, pins of iron wire were made in England during the fifteenth century; brass wire pins were introduced from France in 1540 by Catharine Howard, Queen of Henry VIII. The invention of the process of drawing wire was the foundation of modern pin manufacture, and for years the industry was confined to the two countries, France and Germany, where this process was invented. Brass wire pins were first made in England in 1826. The industry was most successful and spread rapidly, so that within ten years it was well established at Gloucestershire, Bristol, Birmingham, and London, and the pin-makers of the last-named city had formed a corporation.

At first pins were made by filing a proper

length of wire to a point and then twisting a piece of fine wire around the other extremity. The complete process involved thirteen or fourteen operations, requiring the labor of as many different persons. Most of these processes were performed by hand tools as distinguished from automatic machinery, and in many cases a pin at a time. Toward the close of the eighteenth century various inventors were at work devising machines for shortening this complicated process. In 1797 a solid-headed pin was made by Timothy Harris, of England. The blanks were placed in a two-part mold in which prints at the proper place represented the pin-head. Into this mold an alloy of lead and antimony was poured, which solidified and formed a solid head to the pin. Successive improvements followed, the most important of which was the machine invented by Lemuel Wellman Wright, of the United States, in 1824. This did little more than make solid heads to the pins, by a process in principle like that used for nail-making—viz., by driving a portion of the pin itself into a counter-sunk hole. The action, however, was automatic, and consisted in an arrangement by which the wire was seized in two small grooved cheeks. When both cheeks are placed face to face, the wire is held tightly in the groove with a small portion projecting, a small ram or hammer connected with the machine strikes on the projecting portion described, and compresses it into a small cup-shaped depression, and thus the head is formed. In 1831 a machine for making perfect solid-headed pins, like those now in use, was invented by John Ireland Howe, a physician in Bellevue Hospital, New York City. The following year a company was organized to make pins after his patents, which, six years later, moved to Derby, Conn.

The modern pin-making machine, without the aid of hands, completes the pin in all respects except the coloring and polishing. First, a reel of wire as it comes from the wire-drawer is placed in the rear of the machine, and the end of the wire is taken hold of by a pair of nippers, which pull it over a *straightening-board*, and pass it on completely straightened, until it is seized by two cheeks, when a cutter descends and cuts it off, leaving the projecting part for the head; on the withdrawal of the cutter, the hammer flies forward, and makes the head as before described; the cheeks open and the pins drop on to a sloping metal plate, finely grooved, down which they slip with the heads upward, until the end which is to be pointed comes in contact with a cylindrical roller with a grinding surface, which soon grinds points upon them, by the operation of two or three ingenious arrangements; the first is, that the grooved surface of the plate by which the pins descend terminates a little above the grinding roller, then a slight depression is given to the sloping plate, and also to the roller, so that one end is an inch or two lower than the other; therefore as the pin descends the groove, and is thus brought down the inclined plate, until it lies on the smooth part, where it is highest, and its end in contact with the grinding roller which is revolving, the pin itself is compelled by the friction of the roller to turn round, and gradually descends from the upper to the lower part of the inclined plate, and then falls into a box placed to receive it. These operations are performed so rapidly that they

can scarcely be perceived by the eye, and the pins, beautifully pointed, fall into the box in a stream. They are then yellowed, tinned, and prepared for papering.

Samuel Slocum, of Connecticut, invented the first pin-sticking machine. It was introduced into Dr. Howe's factory in 1841. The modern sticking machine is worked by two children; one feeds the machine with pins, the other with papers. The first part of the machine is a box, about 12 inches long by 6 inches broad, and 4 inches deep; the bottom is made of small square steel bars, sufficiently wide apart to let the shank of the pin fall through but not the head, and they are just as thick as the space between the papered pins. The lower part of the bottom of the box is made to detach itself as soon as the row of pins is complete, and row after row at regular intervals is received and passed down a corresponding set of grooves, until they reach the paper, which, as before described, is pinched into regular folds and pierced to receive the pins, which, by the nicest imaginable adjustments, come exactly to their places, and are pressed into them.

The same general process is followed in the making of safety pins, only here the process is more complex, as not only must the wire be cut and pointed, but it must be bent to the desired shape, and in certain styles of pins a sheath or catch for the point must be attached. The machines are entirely automatic in their action, and require but little attention.

Enamel-headed pins are largely made at Aix-la-Chapelle, Germany. Great quantities of needles are also made in the same city and the enamel-headed pins were made, at first, to utilize the imperfect needles. Now, however, they are made in such quantities that wire shanks are specially prepared for this purpose. Enamel, or glass, is spun into a rod about three-sixteenths of an inch thick. The end of this glass is kept viscous by a gas jet. Into this soft substance the workman plunges the pin-shank, and by a complex whirling motion detaches a bulbous mass from the rod which adheres as a head to the pin. It is said that a workman can head from 25,000 to 30,000 pins daily.

Black or mourning pins are made of iron wire, heated in a muffle till the proper tint is obtained; or they are coated with a suitable varnish, which is afterwards hardened by storing the pins.

STATISTICS. The chief pin-manufacturing centres are located as follows: In France, at Aix-la-Chapelle, Germany; at Birmingham, England; and, in the United States, principally in Connecticut. The growth of the industry in the United States is shown by the following figures taken from the Twelfth Census, Washington, 1902: In 1850 there were four pin factories in the country, having a combined capital of \$164,800, and a combined annual product of \$297,550. In 1900, 50,167,817 gross of pins were produced, valued at \$898,054. Of these 47,338,429 gross were common or toilet pins; 1,189,104 gross were hair-pins; 1,640,284 gross were safety pins.

PIÑA (pá'nyá) CLOTH (Sp., pineapple). A very beautiful fabric made of the fibres of the leaves of the pineapple plant (*Ananas sativus*), and other allied species. (See BROMELIA.) It is of a delicate, soft, transparent texture and a yellowish tint. This cloth, which is made in Manila, re-

sembles horse-hair cloth, because the threads both of warp and weft are each single unspun fibres, consequently only small pieces can be made; the workers have, however, a plan of joining the fibres of the coarser kinds end to end, so as to make warp threads of considerable length. Piña cloth is very strong, and the better sorts far excel the finest lawns in texture. It is chiefly employed in the manufacture of ladies' pocket-handkerchiefs, which often have their costliness much increased by beautiful embroidery.

PINACATE BUG. Any of the tenebrionid beetles of the genus *Eleodes*, especially common in the Western United States. They are large, smooth, clumsy, wingless, black beetles, which congregate in large numbers under stones and pieces of wood. They defend themselves when disturbed by elevating the hinder portion of the body and discharging an oily fluid.

PINAFORE, H. M. S. A popular comic opera by Sir Arthur Sullivan, produced in London May 28, 1878. The libretto, by W. S. Gilbert, is a droll satire on current topics, the germ of which is "Captain Reece" in the *Bab Ballads*.

PINAKOTHEK (Ger., from Gk. *πινακοθήκη*, *pinakothékē*, picture-gallery, from *πίναξ*, *pinax*, picture, *θήκη*, *thékē*, receptacle). Among the Hellenes, a term used to designate a room or building near a temple, for the preservation of pictures brought as votive offerings to the gods. The Romans applied it to the entrance to the atrium of a house, which often contained statues, pictures, and other objects of art. Pinocoteca is the usual Italian term for a gallery of paintings; but the most celebrated collection bearing this name is the Pinakothek in Munich, erected in 1826-36, after designs by Klenze, the architect of the Glyptothek. The New Pinakothek was completed in 1853, and in it are placed the works of contemporary artists. The main gallery is one of the most important in its contents in Europe, especially for works of the early German and Italian schools. It was the earliest important public gallery formed in Germany, but during the last half century has not kept pace with that of Berlin. The largest hall in the building is devoted to ninety-five works by Rubens, and there are a number of Raphaels. There are altogether over 1300 paintings, including specimens of Cimabue, Giotto, Leonardo da Vinci, Correggio, Titian, Michelangelo, Dürer, Rembrandt, and Van Dyke. It comprises the best works of the royal collections, these being arranged with regard to their various schools, in nine halls and twenty-three compartments. The building is itself a monument of art, one of its corridors being divided into twenty-five loggie frescoed by Cornelius, with works illustrative of the history of the fine arts in the Middle Ages. The lower story of the building contains 9000 drawings by the old masters; the original drawings for Cornelius's loggie; and a cabinet of more than 300,000 engravings. There is also an important collection of Etruscan and other vases, and other works of antiquity.

PINAR DEL RÍO, *pê-nâr' dël rê'ô*. A province of Cuba, occupying the western end of the island, and bounded on the north by the Gulf of Mexico, on the east by the Province of La Habana, and on the south by the Caribbean Sea (Map:

Cuba, B 4). Its area is 5000 square miles. The Cordillera de los Organos, reaching a height of 2500 feet, runs lengthwise through the province, and the land slopes gradually to the coasts on either side, which, especially in the southwest, are low and marshy. The southern slope is the celebrated Vuelta Abajo, where the finest tobacco in the world is grown. Tobacco is the main product. Sugar and coffee, and in the lowlands sea island cotton, are also grown, and there is extensive lumbering and some copper-mining. The population in 1887 was 225,891, and in 1899 173,064. The capital is Pinar del Río.

PINAR DEL RÍO. The capital of the province of the same name in Cuba. It is situated on the south slope of the mountains, 90 miles southwest of Havana, with which it is connected by rail (Map: Cuba, B 4). It is the centre of the tobacco industry of the Vuelta Abajo, and a good road connects it with the port of Coloma. Population, in 1899, 8880.

PINARIA GENS. An ancient patrician tribe at Rome, who, with the Potitii, were believed to have entertained Hercules and to have been taught the conduct of his worship, becoming his hereditary priests. According to the legend, Appius Claudius bought the secrets of the rites from the Potitii, who were thereupon destroyed by Hercules, while the Pinarii continued in existence until late times, though without great importance.

PINAS'TER. A kind of pine (q.v.).

PIN-BORER, or SHOT-BORER. Any of several of the bark-boring beetles (family Scolytidæ), which in issuing from their food-plants leave holes through the outer bark, usually of very small size. See BARK BEETLE; AMBROSIA BEETLE.

PINCH (from OF., Fr. *pincer*, to pinch, of unknown origin). A term used in connection with mineral deposits to indicate a marked narrowing of the vein or bed. Pinches may be caused by movements in the rocks, or by irregularities of deposition.

PINCH, TOM. Mr. Pecksniff's clerk in Dickens's *Martin Chuzzlewit*, a modest, good-hearted, guileless fellow, very fond of playing the organ. His sister Ruth, a pretty girl devoted to Tom, marries John Westlock.

PINCHBACK, PINCKNEY BENTON STEWART (1837—). An American lawyer and politician of African descent, born in Macon, Ga. He was educated at the public schools in Cincinnati, Ohio, commanded colored troops in the Federal army during the Civil War, and was a Louisiana State Senator in 1868-71. He was acting Governor of Louisiana in 1872 and was elected to Congress the same year. In 1873 he was commissioner to the Vienna exhibition from Louisiana, and he was made a member of the Board of Education of that State in 1877, and served as a trustee of the Southern University in 1883 and 1885. He studied law at the Straight University and was admitted to the bar in 1886.

PINCHBECK (named from its inventor, Christopher *Pinchbeck*, a London clockmaker of the eighteenth century). An alloy of copper and zinc, usually in the proportion of five parts of

the former to one part of the latter. It has a color resembling red gold, and was formerly largely used in making watch-cases and similar articles in imitation of gold.

PINCH'ES, THEOPHILUS GOLDRIDGE (1856—). An English Assyriologist. He was born in London, learned his father's trade of die-sinking, and at nineteen began to study Assyrian. In 1900, after twenty-two years of service, he retired from the British Museum, where he had been employed in the department of Egyptian and Assyrian antiquities. He was closely connected with the publication of the *Cuneiform Inscriptions of Western Asia* and the *Cuneiform Texts from Babylonian Tablets*, both issued by the British Museum; and wrote many articles in *Hastings's Dictionary of the Bible*. He published besides *The Old Testament in the Light of the Historical Records and Legends of Assyria and Babylonia* (1902).

PINCHWIFE. A character in Wycherley's comedy *The Country Wife*, a jealous husband who tries to keep his young and ignorant wife from society, lest she prove unfaithful. The unsophisticated wife, Margery Pinchwife, is the counterpart of Agnes in Molière's *L'Ecole des Femmes*, from which the comedy is borrowed. The Pinchwives appear as Moody and Peggy in Garrick's adaptation *The Country Girl*.

PINCIAN (pīn'shī-an) **HILL**, or **MONTE PINCIO**, mōn'tā pin'chō. A hill at Rome, 164 feet in height, forming a spur of the Quirinal, from which it is separated by a small valley. It was not included among the seven hills of Rome or regarded as a part of the city. It was famous as the site of magnificent gardens, including those of Aclilius Glabrio, of the Anicii, where the Villa Medici now stands, and of Lucullus, and therefore bore the name of *Collis Hortorum*. It is now the fashionable promenade of Rome and commands fine views of the city and surrounding country.

PINCKNEY, pink'nī, CHARLES (1758-1824). An American statesman, born at Charleston, S. C. He studied law and was chosen to the Provincial Legislature when just of age. He was a member of the Continental Congress in 1785 and in 1787 of the National Constitutional Convention. He was Governor of South Carolina from 1789 to 1792, and in 1790 presided over the convention which framed the State Constitution. From 1796 to 1798 he was again Governor, and from 1798 to 1801 was a member of the United States Senate. From 1802 to 1805 he was Minister to Spain, and secured a renunciation on the part of that country of her claims to the Louisiana territory. He was again Governor in 1806-08, was a member of the Legislature in 1810-12, and was a strong advocate of the War of 1812. From 1819 to 1821, in the National House of Representatives, he opposed the Missouri Compromise. He was a man of liberal ideas and favored the abolition of primogeniture in South Carolina, the removal of Jewish disabilities, and a system of free schools. He wrote a series of letters signed *Republican* (1800), which strongly advocated the election of Jefferson to the Presidency.

PINCKNEY, CHARLES COTESWORTH (1746-1825). An American soldier and statesman,

born at Charleston, S. C., son of Charles Pinckney, Governor of South Carolina. He was educated in England, at Oxford and the Middle Temple. After studying for a time at the Royal Military Academy at Caen, France, he returned to America in 1769, and began the practice of the law at Charleston. He served in the first Provincial Congress of South Carolina in 1775, was elected captain of a provincial regiment in the same year, and became colonel in October, 1776. He was afterwards one of Washington's aides-de-camp, participated in the battles of Brandywine and Germantown, and, returning to the South in 1778, joined the expedition to Florida. In 1783, he was promoted to be brigadier-general, but, the war being over, he returned to his practice at Charleston. He was a prominent member of the United States Constitutional Convention in 1787; of the State Convention which ratified the Federal Constitution, and of the convention which in 1790 framed a constitution for South Carolina. Sent to France in 1796, as United States Minister, he was received with studied discourtesy by the Directory, which finally forced him to leave the country; nor on his return as a joint commissioner with Elbridge Gerry and John Marshall was his reception more favorable. (See X. Y. Z. CORRESPONDENCE.) Talleyrand assured the commissioners that a gift of money was a necessary preliminary to the negotiations, and that a refusal might bring on war. Pinckney is said to have answered: "War be it, then; millions for defense, sir, but not one cent for tribute!" On his return to the United States a war with France seemed imminent, and he was appointed a major-general. He was the Federalist candidate for Vice-President in 1800 and for President in 1804 and 1808, and was the third president-general of the Society of the Cincinnati.

PINCKNEY, THOMAS (1750-1828). An American diplomat and soldier, born at Charleston, S. C. In 1753 he was sent to England with his brother, Charles Cotesworth Pinckney, to be educated; was admitted to the English bar in 1770; and returned to Charleston in 1772. Entering the Continental army as a lieutenant in 1775, he served as aide to Lincoln, D'Estaing, and Gates successively, taking a conspicuous part in the battles of Stone Ferry (June 20, 1779) and of Camden (August 16, 1780), at the latter of which he was wounded and taken prisoner, remaining in confinement until the close of the war. He was Governor of South Carolina in 1789-1791, was Minister to England in 1792-1794, and in November, 1794, was sent on a special mission to Spain, where he negotiated an important treaty (signed October 17, 1795), guaranteeing to the United States the free navigation of the Mississippi, with privileges of deposit at New Orleans for at least three years. Returning in 1796, he was the Federalist candidate for Vice-President in this year, and was a member of Congress in 1799-1801). In the War of 1812 he served as major-general in command of the Sixth Military District, and at the battle of Horse Shoe Bend completely defeated the Creek Indians. Subsequently he retired from public life and spent his last years in Charleston.

PINCKNEYA (Neo-Lat., named in honor of C. C. Pinckney), GEORGIA BARK, or FEVERTREE. A small tree, *Pinckneya pubens*, occasionally

found in low or swampy land in Florida, Georgia, and South Carolina. It belongs to the natural order Rubiaceæ, has large oval leaves, and beautiful terminal clusters of purple-spotted flowers. It is used by the country people as a substitute for quinine.

PINC-PINC, or **TINC-TINC**. A small South African bird (*Cisticola textrix*), so called from its ringing metallic cry, often repeated as it hovers in the air. It is chiefly but wrongly known as the alleged builder of a wonderful nest, the real fabricator of which is the cotton-bird (q.v.).

PINDAR (Gk. Πίνδαρος, *Pindaros*). The most famous of Greek lyric poets. He was born near Thebes in Bœotia, c.522 B.C., and probably died soon after 445, the date of his latest known poem. A conservative in politics and religion, a singer of the athletic prowess of the old Æolian and Dorian nobility, he seems to belong to a more ancient order than that of the great Athenians of the fifth century B.C. Apart from the magnificence of his style, the chief points of interest in Pindar for us are that: (1) He was before the recovery of Bacchylides from an Egyptian papyrus the only Greek lyric poet who could be studied in a considerable body of work; (2) he is the representative of a provincial, colonial, and in some ways larger Greece than that in which we are wont to see only a foil to Periclean Athens; (3) he is the first extant Greek writer to proclaim the immortality of the soul and to portray a future judgment; (4) he shows us the Greek myths in transition from their treatment by Hesiod, the older epic, and the lost lyrics of Stesichorus to the forms which they assumed upon the Attic stage.

Only the outline of his life is known. His earliest extant ode, the tenth Pythian, dates from about his twentieth year, before which time he is said to have studied under the best musical and poetic masters of Athens and Thebes, and to have been the pupil or the rival of the Bœotian poetesses, Myrtis and Corinna. An early poem overlaid with mythic ornament, is said to have called forth from the latter the famous admonition: "One should sow with the hand and not with the whole sack." Pindar's family belonged to the noble clan of the Ægeids which had widespread connections in Thera, Sparta, and Cyrene. His deep religious feeling caused him to cultivate intimate relations with the priesthood of the great shrines, especially that of Delphi, where his name was publicly honored for centuries. He seems to have traveled widely to all parts of the Greek world from which his national reputation brought him commissions. At the court of Hiero in Syracuse he may have witnessed the famous eruption of Mount Etna, so magnificently described by him in the first Pythian and by Æschylus in the *Prometheus Bound*. He composed hymns or encomia for the priests of Ammon, for Alexander of Macedon, Arcesilaus of Cyrene, Theron of Agrigentum, Hiero of Syracuse, and for the noblest families of Thessaly, Rhodes, Corinth, Ægina, Athens, and Tenedos. No other Greek poet has so wide a geographical range. None presents so vivid a picture of the dazzling diversity of greater Hellas; none so adequately expresses the underlying spiritual unity preserved by the common language and religion, and

the tradition of the great Panhellenic temples and games. His Hellenic patriotism has been questioned because he says so little of Marathon and Salamis and in praise of Athens. As a citizen of a 'Medizing' State, he could hardly have said more. Tradition has it that he said too much to please the Thebans, who fined him for the line cited from a lost dithyramb: "O splendid, violet-crowned, glorious Athens, famed in song, pillar of Hellas, city divine." The legend adds that the reward bestowed by the Athenians more than paid the fine.

Pindar and his contemporary Simonides represent the culmination of the Greek choral lyric composed with music to be sung by trained choruses of youths and maidens, as distinguished from the personal lyric of a Sappho or Alceus recited or half chanted to a slight accompaniment on the strings. Only fragments remain of Pindar's hymns to the gods, peans, dithyrambs, processional odes, dancing songs, dirges, and encomiums. But we possess practically entire the four books of his Epinician or triumphal hymns composed in honor of the victors at the four great national games—the Olympian, Pythian, Isthmian, and Nemean. The victor in the Olympic games received such honors as Rome and the modern world would bestow only upon the triumphant soldier. The victory was celebrated on the spot by festivities generally impromptu, and later at the victor's home by triumphal processions, banquets, and serenades often repeated for many anniversaries. If the victor was rich or had wealthy patrons, a Pindar, Simonides, or Bacchylides would be commissioned to write a special hymn to be sung during the procession or at the banquet by a trained chorus of his comrades. A large part of such a poem was conventionally predetermined. The victor, his clan, and his city must be celebrated. The great commonplaces of athletics, the praise of youthful pluck and endurance and of the beauty of young manhood, must be touched upon. There must be a word of admonition to moderation, and perseverance in well-doing; a prayer for the continued blessing of heaven, a deprecation of the 'jealousy' whether of gods or men, which Greek feeling attached to all preëminence. The poet's task was to ennoble this commonplace by stately and melodious utterance, to transfigure the whole in the light of the splendor and magnificence of the Olympian or Pythian festival, to raise the petty and personal into relation with the larger life of Hellas, to exhibit the transient success of the hour as the natural flowering of the glorious tradition of family, clan, and city. To this end Pindar employs the myth, which fills the central portion of the ode and often seems to have little connection with the immediate theme, but which closer study shows to be chosen with an art that we can sometimes only divine, either to express the dominant mood of the occasion or to connect the hero with the mythic past. The English reader may compare the treatment of the legend of the golden fleece in the fourth Pythian with the leisurely epic handling of the same theme in Morris's *Life and Death of Jason*.

It is customary to describe Pindar's sublimity by comparing him to the eagle or the lonely Alpine peak. His style is untranslatable and indescribable. Horace compares it to a torrent that has burst its banks. Boileau, Cowley, Gray, and

the long line of eighteenth-century authors of Pindaric odes, thought to reproduce it by jerky, irregular rhythms, abrupt transitions, and bombastic diction. Matthew Arnold praises it as "the grand style in simplicity." Myers's beautiful translation into archaizing English prose reproduces the matter excellently, but hardly the manner. It is "the grand style in simplicity" doubtless. But Pindar's simplicity is compatible with an "intoxication of style," a polysyllabic sonority, a cyclopean phrase architecture, a kaleidoscopic flash of metaphor, and above all an organ roll of word music which no modern tongue can compass. The best translation is that of Myers. Carey is the most readable of the older translators in verse. The chief editions are those of Böckh (the foundation), Schneidewin-Dissen, Christ (Teubner text, and larger edition with Latin notes), Fennell, Gildersleeve (Olympian and Pythian Odes). The best comment and criticism will be found in Croiset's *Pindare* (2d ed., Paris, 1886); in Fraccaroli, *Le Odi di Pindaro* (Verona, 1894); in Jebb, *Lectures on Greek Poetry* (London, 1893), and his paper in the third volume of the *Journal of Hellenic Studies*, and in Gildersleeve's *Introduction*.

PINDEMONTÉ, pèn-dā-môn'tā. IPPOLITO (1753-1828). An Italian poet, born at Verona. He was educated at Modena, and in 1778 he went to Rome, where he was admitted into the Arcadia. Here he conceived the idea of translating the *Odyssey*. With this idea in view, he went to Naples and Sicily, visiting many places connected with the legend of Ulysses. At Florence he made the acquaintance of Alfieri, and he saw him again at Paris, whence he passed to London, Berlin, and Vienna, returning to Verona in 1791.

Pindemonté's chief works are the *Poesie and Prose campestri* (1788-94), the form of which is cast in the Greek and Latin mold, and the inspiration of which is largely English; the epistle, *I scpoleri*, written in response to Foscolo's poem of similar import; and an excellent blank verse version of the *Odyssey* (1818-22). His lesser works comprise many treatises, discourses, and letters; a tale, *Clementina*; a novel, *Abaritte*; a number of tragedies, of which the best is the *Arminio* (1804), dealing with the story of the conqueror of Varus; and other versified compositions, such as the *Francia*, which celebrates the opening of the States General at Paris in 1789, and his *Sermoni*. Consult the edition of his *Poesie originali* (Florence, 1858); the *Arminio*, in the 3d ed. of Verona, 1812; the *Odissea* (Florence, 1891); Montanari, *Storia della vita e delle opere di Ippolito Pindemonte* (Venice, 1856).

An elder brother of Ippolito was GIOVANNI PINDEMONTÉ (1751-1812), also a poet of some merit. He rose high in political circles at Venice, and became Podestà of Vicenza, but falling into disfavor, he had to seek refuge in France in 1796. In 1802 he played a part in the legislative body at Milan. He wrote tragedies and lyrics, the latter of elevated inspiration, but imperfect in form. Consult his *Opere drammatiche* (1804-05), and his *Poesie e lettere*, edited by Biadego (Bologna, 1883).

PINDHÁREES, pín-dā'rēz, or **PINDÁRIS** (Marathi, *Pindhāri*, *Pendhāri*, plundered, from *pendha*, bundle of grass + *hāri*, one who takes).

The name of marauding companies of mercenaries, who remained in arms after the fall of the Mogul Empire. Eventually, between 1804 and 1817, they became in effect a formidable warlike State, dangerous to English rule, and the terror of the native populations. In the year 1816 alone they destroyed 339 villages in British territory. The next year Lord Hastings, with forces amounting to 120,000 men, completely routed the united Mahratta and Pindhāree armies, consisting of 200,000 men and 500 guns. From this blow the Pindhārees did not recover.

PIN'DUS. A mountain range of Northern Greece, between Epirus and Thessaly. See GREECE.

PINE (AS. *pin*, from Lat. *pinus*, Skt. *pīn*, pine; connected with Gk. *πίτυς*, *pitya*, Oir. *ith*, grain, Skt. *pītu*, sap, *pīta*, pine, *pā*, to drink, AS. *plūme*, *plyme*, from Lat. *prunum*, plum, *prunus*, plum-tree, from Gk. *πρῶνον*, *prounon*, *πρῶνον*, *prounon*, plum, *πρῶμνη*, *proumnē*, plum-tree; for the phonological changes of *r* to *l*, and of *n* to *m*, cf. Eng. *pilgrim*, from Lat. *peregrinus*, stranger), *Pinus*. A genus of trees of the natural order Coniferae. Nearly two-thirds of the species are natives of the northern part of the Western Hemisphere, the others occurring in the temperate and subarctic portions of Europe and in Africa, extending as do some of the American species into the tropics upon the high mountains. The genus is readily distinguished by narrow, linear needle-like leaves, growing usually in clusters of two, three, or five, surrounded at their bases by a sheath of membranous scales; and in bearing its seeds in cones which usually mature the second year, some species the third or later years. Pines embrace some of the most ornamental and useful trees, their size varying from shrubby specimens, which usually grow at high elevations or latitudes, to trees of great size.

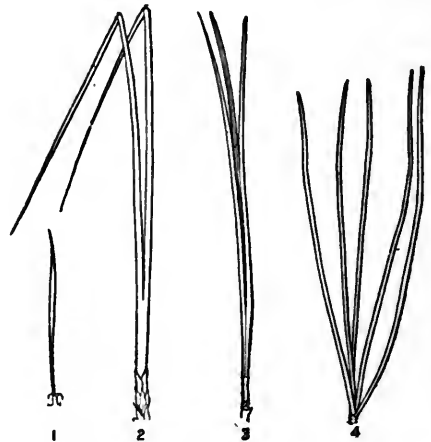

GROUPING OF PINE-NEEDLES IN SHEATHS.
1, *Pinus monophylla*; 2, *Pinus Pinaster*; 3, *Pinus Sabiniana*; 4, *Pinus Lambertiana*.

Pines grow in almost every kind of soil and situation, from the bleak mountain side to the plain of almost pure sand. They are more or less gregarious in habit and frequently cover extensive areas to the almost total exclusion of other

PINES



PITCH OR YELLOW PINE (*Pinus plusustris*).
Low Palm tree in background.

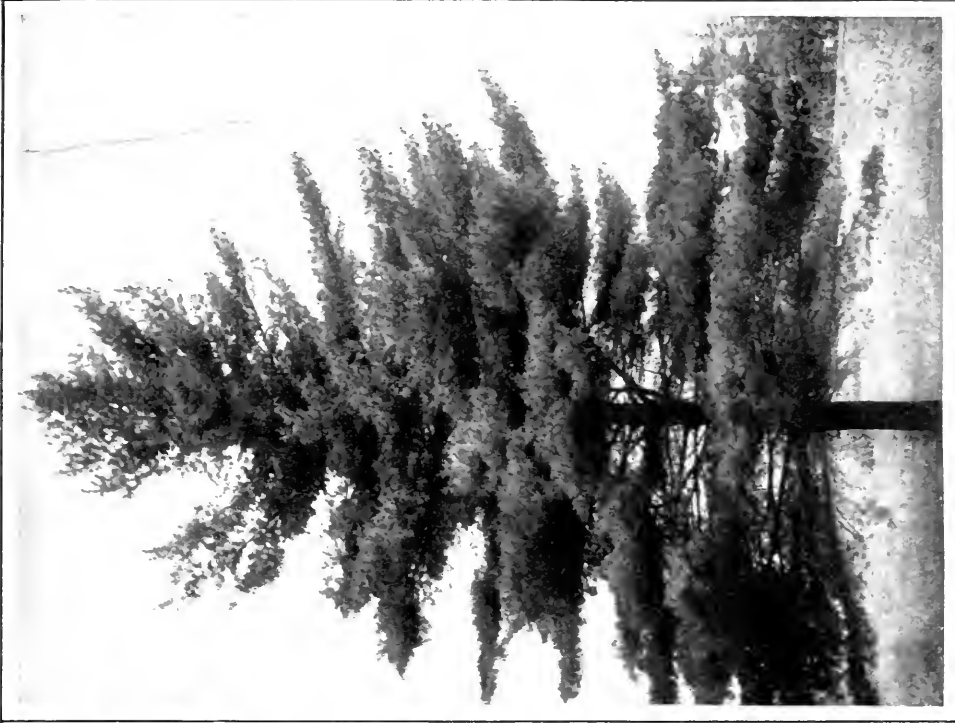

WHITE PINE (*Pinus Strobus*).

species, as in the pine barrens of North America. The thickened epidermis and reduced surface of the needles, which are in fact not true leaves, check transpiration and fit the trees admirably for the situations in which they often grow.

One of the most scientific systems of classification, that given by Engelmann in the Transactions of the Saint Louis Academy of Science for 1882, is based upon rather technical characters. By others artificial groupings are made, based upon the number of leaves in the cluster and the position and character of the cones. The following scheme, adapted from Veitch, shows the relationships of some of the more common species:

Strobi, leaves in bundles of five; cones pendulous; scales thin, blunt; seeds winged—*excelsa*, *lambertiana*, *monticola*, *strobus*.

Cembra, leaves in fives; cones erect or horizontal; seeds large, obscurely winged—*albicaulis*, *Balfouriana*, *Cembra*, *flexilis*.

Edules, leaves in bundles of one-fifth; cones subterminal; scales thickened; seeds large, very obscurely winged—*monophylla*, *parryana*, *edulis*, *cembroides*.

Tæda, leaves in threes; cones subterminal or lateral; scales much thickened, with sharp prickles; seeds winged—*coulteri*, *palustris*, *ponderosa*, *Tæda*.

Pinaster, leaves in twos; cones lateral, often clustered, mostly persistent; scales thickened, blunt or spiny—*contorta*, *echinata*, *municata*, *Pinaster*.

Sylvestres, leaves in twos; cones subterminal, small mostly falling off; scales slightly thickened; seeds with elongated wings—*Banksiana*, *halepensis*, *resinosa*, *sylvestris*.

The white pine (*Pinus strobus*) is one of the most important timber trees of North America. Its range extends from Newfoundland to Minnesota and southward to the mountains of Georgia. It attains a height of 75 to 150 feet, with a diameter of 4 feet. The wood is white or light yellow, soft, straight-grained, and not very resinous, although some resin is obtained from it. It is easily worked and is largely used in building, cabinet work, etc., being especially in demand for doors, frames, window sash, blinds, shingles, etc. This tree is becoming scarce in the Northern United States and the adjacent parts of Canada. It is one of the most rapid-growing coniferous trees, and as an ornamental has no superior in the northeastern part of the United States. It is propagated from seed, and the young seedlings require some shade. It is not considered as hardy as the Scotch pine, but is longer lived.

The yellow, long-leaved, or Georgia pine (*Pinus palustris*), a tree of the widest distribution and greatest economic importance of any in the South Atlantic and Gulf States, ranks second among American pines. It is found in the sandy and gravelly soil from near Norfolk, Virginia, in a belt about 125 miles wide to Louisiana, following the contour of the coast, and is readily distinguished by its long leaves, 9 to 15 inches long, and its cones, which are rather larger than those of other species which accompany it. The average height of the mature tree is about 100 feet, with a diameter of from 2 to 3 feet, tapering very gradually. The wood is

heavier and stronger than that of any other pine upon the market. The layer of sap-wood is rather thin and the heart-wood is prominently marked by the annual rings. The timber is used in all kinds of building, being especially adapted to ship-carpentry, bridge-building, flooring, etc. Large quantities are annually exported, while the building operations of the Southern States are almost wholly dependent upon it. The tree is very resinous, and wherever the sap-wood is laid bare there is an abundant flow of resin, which is largely used in the manufacture of naval stores, turpentine, resin, pitch, tar, etc. The industry ranks second only to the lumber interests. The leaves are utilized for the production by distillation of an oil closely resembling the oil of turpentine, and for the production of pine wool, made by boiling with alkalis, the resulting fibre being used in upholstering.

Two species associated with the Georgia pine in its lower limits are the Cuban pine (*Pinus heterophylla*), very similar to the Georgia pine in size and manner of growth, but considered

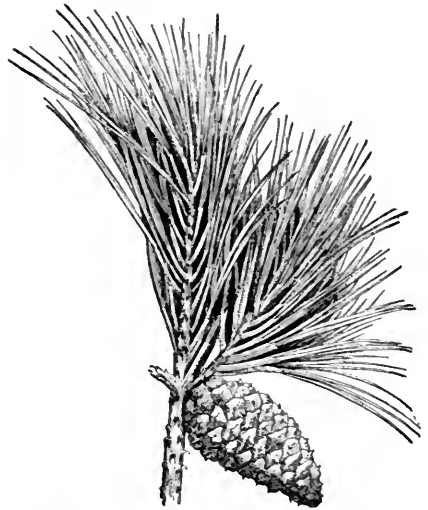

LOBLOLLY OR OLD FIELD PINE (*Pinus Tæda*).

somewhat less valuable, and the loblolly or old field pine (*Pinus Tæda*). The loblolly pine springs up in abandoned fields, soon affording a supply of timber and wood for fuel, the quality of which varies widely with the conditions under which it is grown, approaching the long-leaved pine in quality when grown in the forest, but considered inferior when grown in open fields. Another valuable species of the Southern and Eastern States is the short-leaved pine (*Pinus echinata*, or *Pinus mitis*, as it is frequently called), a tree which attains a height of 75 to 120 feet with a diameter of about 2 feet, and which ranges from New Jersey and Pennsylvania through southern Illinois to Arkansas and eastern Texas, in some places occurring in almost pure forests. The wood is heavy, hard, coarse-grained, but strong, and is largely used for the framework of buildings, weather-boarding, railway ties, car and other building. It is less resinous than the long-leaved pine, but in importance ranks next to that species in the South. The jack pine or scrub pine of the

Northern States is *Pinus divaricata* or *Pinus Banksiana*. It abounds from New Brunswick to the Mackenzie River and southward about the Great Lakes, furnishing the cover to the extensive pine barrens of that region, especially in Michigan. It is of little value except for fuel. Next to the white pine perhaps the most valuable species in the North is the red or Norway pine (*Pinus resinosa*), which is found from the Gulf of Saint Lawrence to Manitoba and south to Minnesota and Pennsylvania. It occurs as trees 60 to 100 feet tall and 2 feet in diameter, often forming extensive forests upon dry sandy soils. The wood is light, hard, elastic, resinous, and durable except when in contact with the ground. Its uses are similar to those of the short-leaved pine farther south. The Northern pitch pine (*Pinus rigida*), which occurs throughout the northeastern portion of the United States and adjacent Canada, is of little value except for fuel and charcoal, but, although rich in resin, it is little used, the Georgia pine having control of the market.

Among the important species of the Pacific region may be mentioned the sugar pine (*Pinus Lambertiana*) and the bull pine (*Pinus ponderosa*). The former is one of the largest of the genus, the trees attaining a height of 150 to 300 feet and more than 10 feet in diameter. It occurs through Oregon and California. The tree trunks are straight and without branches for a considerable portion of their height. The timber is of excellent quality, solid, straight-grained, does not warp, and is easily worked, so that it is in demand for finishing lumber and cabinet work. The tree exudes a resin which when burned has a sugar-like flavor, hence the name. The seeds of this and many other species of Western pines are eaten in considerable quantities as nuts. The bull pine, which has several well-marked varieties of diverse utility, is found from the Rocky Mountains to the Pacific Coast, where it attains a height of 100 to 150 feet and a diameter of 5 to 6 feet; occasional trees are found 250 feet high and 10 feet in diameter, but it is rather smaller in the Rocky Mountain region. In the Pacific Coast region the timber is heavy, hard, strong, and fine-grained; farther inland it is coarser-grained, harder, and more brittle. In the southwestern part of the United States are four species known as Piñon pines (*Pinus parryana*, *Pinus cembroides*, *Pinus monophylla*, and *Pinus edulis*). The various species found from Colorado and Utah to Texas and California are chiefly known for their large edible seeds called piñons. These are eaten as nuts (q.v.). The trees are for the most part small and of little value except for their seeds and for fuel. Among the Mexican species of pines the most valuable and interesting are *Pinus Ayacahuite* and *Pinus Montezumæ*, trees of considerable size, the former somewhat resembling the white pine of the United States.

In Europe the most valuable as well as the most widely distributed species are *Pinus sylvestris*, *Pinus Laricio*, and *Pinus halepensis*.

The Scotch pine or Scotch fir (*Pinus sylvestris*) occurs in immense forests sometimes mixed with spruce fir in some European countries, and is the only species indigenous to Great Britain. It attains a height of 80 to 100 feet and a diameter of from 2 to 4 feet, and is frequently

seen with very large branches resembling trunks. It is of quick growth and has been known to attain the age of 400 years. Its very resinous and durable timber, known as red deal and red pine, is highly valued, being used in house and ship carpentry. There is great difference, however, in the timber grown in different soils and situations, inferior white, soft, and comparatively worthless grades being produced in rich soils and sheltered situations. Several varieties yield very superior timber. The Scotch pine is valuable also on account of its turpentine, tar, pitch, and resin. Oil of turpentine is sometimes distilled from the cones, and the leaves, which last have also been used in Germany for the manufacture of a tow-like substance called *wald-volle* (forest wool), suitable for stuffing cushions, etc.

The black or Corsican pine or black fir (*Pinus Laricio*), a native of Austria, but found throughout Southern Europe, is another species closely allied to the Scotch pine. It is remarkable for its very long leaves and its content of resin, which is more abundant than in any other European tree. It often attains a height of 140 feet upon sandy soils, and has been employed to prevent sand drifting. Its timber is of little value, but a great part of the turpentine of the maritime districts of France is obtained from it. It yields also part of the Burgundy pitch in the market. The Aleppo pine (*Pinus halepensis*), a native of the south of Europe, Syria, etc., is a very graceful tree of moderate size, with slender leaves in pairs. It yields a liquid resin or turpentine, which is extracted from it in Provence and elsewhere, and sold as Venice turpentine. The wood is extensively used in the Levant for ship-building. The pinaster or cluster pine (*Pinus Pinaster*) is another important European species. It is found on the shores of the Mediterranean, and also in the Himalayas and in China. Like the black fir, it has been largely used in France for covering waste sandy tracts. The timber is of inferior quality, but it yields large quantities of resin and Bordeaux turpentine.

The stone pine (*Pinus Pinca*), a tree with a broad umbrella-shaped head, forms a characteristic feature of the scenery of the Mediterranean, and is very often introduced in paintings. It is the pinie of the Germans, the *pignon* of the French. The seeds, which do not ripen till the fourth year, are large, abound in a fixed oil, and when fresh have a sweet taste resembling that of almonds, like which they are used in Italy and other countries. Their use, however, is almost entirely confined to the countries in which they are produced, as they very soon become rancid. The wood is useful and beautiful. The Cembra pine or Swiss pine (*Pinus Cembra*), which grows in the central parts of Europe and the south of Siberia, is a stately tree, with more persistent lower branches than in most pines. It has rigid leaves in groups of three to five and produces edible seeds (cembra nuts), which, although extracted with difficulty, are much used in Siberia, this fruit being so much prized that trees are often cut down to obtain it. The cembra pine yields a pellucid, whitish oil, resembling oil of turpentine, and known as Carpathian balsam. The Himalaya mountains abound in pines, some of which rival in magnificence those of North-west America. The Bhotan pine (*Pinus excelsa*),

PINES

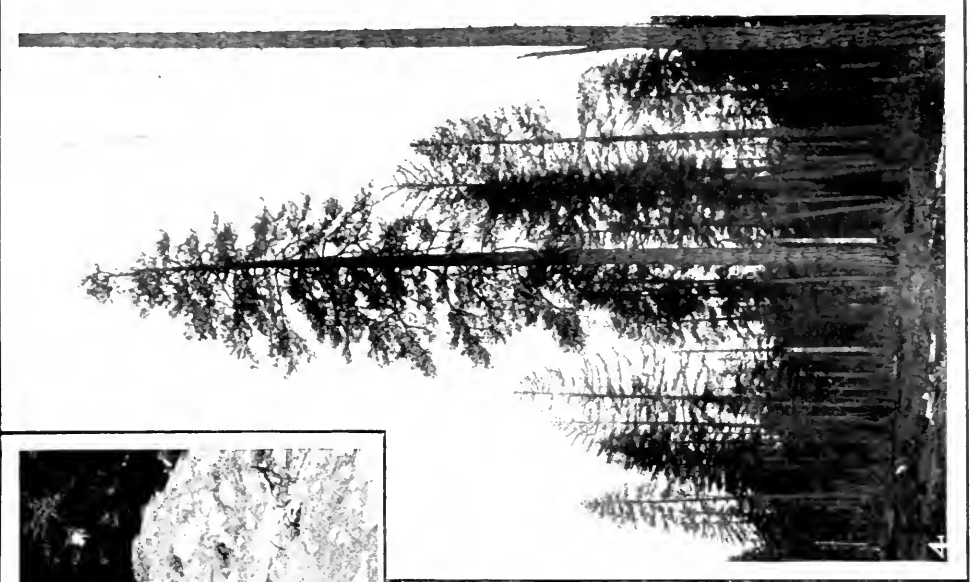
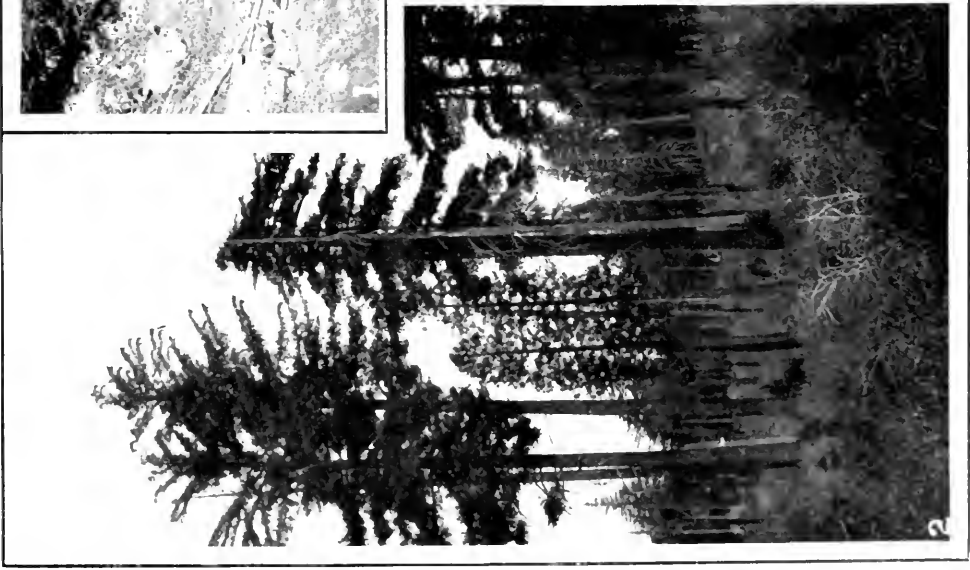

1. DWARF PINE. (*Pinus Pumilio*),
2. SUGAR PINE. (*Pinus Lambertiana*),

3. BARK OF BULL PINE (*Pinus ponderosa*),
4. BULL PINE (*Pinus ponderosa*).

much resembling the white pine in botanical characters, and attaining a height of 90 to 120 feet, abounds in Bhotan, but is not found in the neighboring countries of Sikkim and Nepal. The wood is durable, close-grained, and so resinous as to be used for flambeaux and candles. The cheer pine (*Pinus longifolia*) of India, where it is often cultivated as an ornamental tree, is of graceful appearance. It is abundant on the crests of hills in the lower Himalayas, growing at a lower elevation than other pines. It is much valued for its resin, and the wood is used in India as a substitute for European deal. Of the European species introduced into the United States, the Scotch pine has proved best adapted to the climate and soils. It is frequently planted as an ornamental. *Pinus Laricio* has been introduced into the United States, and its variety *austriaca*, known as the Austrian pine, appears especially adapted to the prairie regions. The dwarf pine (*Pinus Pumilio*) is an alpine species whose stems are usually prostrate.

PINE, JOHN (1690-1756). An English engraver, born in London. He was probably a pupil of Picart of Amsterdam, as his style resembles that master's. He was an intimate friend of Hogarth, who painted him in "The Gates of Calais." Pine's most important works were: "The Ceremonies of the Order of the Bath" (1730); a facsimile of the Magna Charta (1733); a famous edition of Horace with the text engraved throughout, and illustrations from the antique and from Italian scenery (1733-37); *The Tapestry Hangings of the House of Lords* (1739), a work of especial value, as the tapestries were afterwards burned; and a *Plan of London* (1746 and 1755).

PINE, ROBERT EDGE (1730 or 1742-90). An English portrait painter, born in London. He was the son of John Pine, the engraver, and probably his pupil. It is not known whether he had other instruction. After winning a prize with his "Surrender of Calais" and "Canute Reproving His Courtiers," he painted several portraits, such as those of George II., of the Duke of Northumberland, and of Garrick (in the National Portrait Gallery), and a series of scenes from Shakespeare, some of which afterwards appeared in Boydell's *Shakespeare*. About 1783 he came to America and settled in Philadelphia. His intention was to depict some events in the American Revolution, with portraits studied from life, but his time was completely taken up with portraiture. In this line his works include portraits of General Gates, Charles Carroll, Baron Steuben, Robert Morris, George Read, Thomas Stone, and Washington (1785). The latter was engraved for Irving's *Life of Washington*; but although valuable from an historic standpoint, it is not an impressive canvas, as the modeling is weak and he missed the personality of his sitter. After Pine's death many of his pictures were collected in the Columbian Museum in Boston, since burned. Consult Tuckerman, *Book of the Artists* (New York, 1867).

PINEAL BODY (from Lat. *pinæa*, pine-cone, from *pinus*, pine), or **PINEALIS**. The pineal body, improperly called pineal 'gland' and most properly known as the epiphysis, is an unpaired, upward and forward outgrowth of the 'twixt-brain

of vertebrates. It appears as a small, ovoid, conical body of a reddish color, projecting downward and backward between the anterior pair of corpora quadrigemina. Its function is not known, but it is regarded as a rudimentary sense-organ and probably an eye. In many fossil mammals and reptiles there occurs a depression or hollow in the parietal bone known as the parietal foramen, which is thought to have contained such an eye. This view is supported by the fact that in some lizards, and especially in the New Zealand sphenodon (see *TUATARA*), a parietal organ of this kind is well developed, although it lies beneath the skin and is doubtfully functional. Where the parietal eye is thus developed, it is connected with the brain by a special nerve, and both are formed from the epiphysis. In other cases, where there is no parietal eye, the epiphysis is frequently quite short and is sometimes hollow, the cavity being known as the pineal ventricle.

PINEAPPLE (AS. *pinæppel*, from *pîn*, pine + *æppel*, apple). The fruit of *Ananas sativus*, the pineapple plant, which grows from 2 to 4 feet high, producing a single axis to which are attached long, stiff, rough-edged, sword-shaped leaves. The individual plant produces only a single very fragrant and palatable fruit, which varies greatly in size, 4 to 5 inches being the usual diameters and 6 to 10 inches the prevailing lengths of ordinary market specimens. Very large specimens may weigh 15 to 20 pounds. The pineapple is a native of tropical America, and is widely grown in warm climates. Formerly it was an important European greenhouse crop, and the fruits thus produced were of superior quality, but with the improvement of transportation facilities less attention is given to its culture under glass than formerly. The West Indies, Bahama Islands, Florida, Azore Islands, and parts of Northern Africa are the principal regions of production for European and American markets.



PINEAPPLE (*Ananas sativus*).

Queensland supplies the Australian market. In 1899, 14,699,931 plants were growing in Florida, California, and Hawaii. Statistics for other countries are not at hand, but the production is increasing each year. The pineapple succeeds only in regions where frosts do not occur. A climate having an alternate wet and dry season, with a mean annual temperature of 75° to 80° F., appears most favorable. In Queensland the best pineapples are grown in localities having a mean less than 70°. The plant requires a porous, well-drained soil, otherwise it thrives on a great va-

riety of soils. In Florida the best pineapples are grown on a fine sandy soil, analyzing 94 to 99 per cent. silica, and on such soils heavy fertilizing is necessary. Pineapples rarely produce seed. They are propagated commercially by setting out the crown at the top of the fruit, slips from the base of the fruit, suckers from near the base of the stalk, and ratoons from the roots. Suckers are most commonly planted, since these usually produce a crop of fruit in from 14 to 18 months. Crowns or slips require a year longer to come into bearing. The plants are set in rows about 3 feet apart and 18 to 36 inches distant in the row. Once established a pineapple plantation will endure 8 to 10 years without resetting, suckers replacing the old plants. Little cultivation other than the scuffle hoe is required. Within recent years pineapples have been grown extensively in Florida under sheds. These sheds are built of lath spaced 2 or 3 inches apart and nailed to a light framework 6 to 7 feet high. They protect the plants from frost and excessive heat and greatly improve the quality of the fruit. The cost of putting them up prohibits their use except for the finest varieties. For an account of the greenhouse cultivation of pineapples, consult: Thompson, *Gardners' Assistant* (new ed., Watson, vol. v., London, 1902). For outdoor methods and growing under sheds, consult: Rolfs, *Pineapple Growing* (United States Department of Agriculture, Farmers' Bulletin 140, 1901); id., *Pineapple Fertilizers* (Florida Agricultural Export Station, Bulletin 50).

PINEAPPLE FAMILY. A natural order of plants. See BROMELIACEÆ.

PINE BLUFF. A city and the county-seat of Jefferson County, Ark., 42 miles south by east of Little Rock, on the Arkansas River, and at the junction of the Saint Louis Southwestern and the Saint Louis, Iron Mountain and Southern railroads (Map: Arkansas, D 3). It is the seat of the State Colored Normal College. Among other fine edifices are Merrill Institute with a gymnasium, free library, etc., the opera house, the court house, and fraternal society buildings. The State Fair Association holds annual fairs here. The centre of a fertile agricultural section largely interested in cotton-growing, Pine Bluff is an important commercial and manufacturing city. It carries on an extensive cotton and lumber trade, and has large wholesale interests. Its industrial plants include railroad shops of the Saint Louis Southwestern, cotton compresses, cottonseed oil and meal mills, boiler and sheet iron works, a foundry, large printing establishments, feed mills, large lumber and stave mills, a furniture factory, etc. Population, in 1890, 9952; in 1900, 11,496.

PINE FINCH, LINNET, or SISKIN. A small North American finch (*Spinus pinus*) closely related to the goldfinch. The upper parts are variegated black and buffy; the under parts white, tinged with buff and heavily streaked with black. It is found throughout North America, wintering as far south as the Gulf and breeding mostly north of the United States, but is erratic in its movements, being abundant some winters and then not seen again for several years. The nest is built in coniferous trees, of twigs and rootlets, and is lined with down and hairs. The eggs are usually four in number, bluish white,

thinly spotted with reddish brown. The pine finch feeds on seeds and buds, and resembles the goldfinch in habits, but is less sprightly and its notes are less musical. In England the pine grosbeak is often called pine finch. See GROS-BEAK.

PINE GROSBEAK. A large finch (*Pinicola enucleator*) of Northern North America, which visits the United States in winter. In general color the male is mottled rose-red above, and ashy on the under surfaces, with two white bands across the wing. The female is ashy-gray, with yellowish-brown on crown and rump. This bird lives in the evergreen forests, and feeds on the seeds of the pine and spruce. See Plate of BUNTINGS AND GROSBEAKS.

PINE GROUSE. One of the names of the blue or dusky grouse of Western America (*Dendragapus obscurus*). See GROUSE.

PINE INSECTS. The insect fauna of the pine is very extensive. In Europe nearly 300 species are found upon trees of the genus *Pinus*, and all but about 20 feed upon different portions of the tree. In the United States nearly 200 have been recorded, but the total number will probably prove to be nearly double that number. Of the pine insects known in the United States prior to 1890 the species which had occasioned locally the most direct and perceptible injury was the pine moth of Nantucket, but the most widely destructive kinds were the timber borers, and of those the larva of *Monohammus confusor*, known as 'the sawyer' in the Southern pine districts, did the most damage. Next to that insect, the white pine weevil (*Pissodes strobi*) does the most damage to timber, since it deforms the trees, causing the growth of gnarled, many-headed trees which except for these attacks would have grown straight and fitted for masts or for the best timber. Some pine-borers are noted for their longevity, and may live for years in articles of furniture or in the timbers of houses, if for some cause prevented from pairing and laying their eggs. Much damage has been done in different parts of the United States by bark-boring beetles of the family Scolytidæ, and especially by the species of the genus *Dendroctonus*, which also seriously affect spruce. The pine-destroying beetle of the Black Hills (*Dendroctonus ponderosa*) has done within recent years an enormous amount of damage to the rock pine in the Black Hills region, bringing about not only a great loss to the owners of the timber, but also to the mining interests of that region, from the lessening of the timber supply. The principal attack seems to be made in August, when the beetles migrate in swarms from the dying trees and settle on the living ones, which they attack and infest in large numbers from near the base to the upper part of the main trunk or stem. Remedial work is largely a part of forest management, and includes a careful consideration of the proper date for cutting.

The wood-engraver bark-beetle (*Xyleborus ætatus*) is the most common and most pernicious of the insects affecting the forests of white pine in the State of New York, and of the yellow pine in the more southern States. *Xyleborus pubescens* feeds mainly under the bark of *Pinus inalls-graphus* works in the pitch pine and to a lesser

extent in the white pine. There are perhaps 20 more species of scolytid bark-beetles which have similar habits in connection with pine trees. Of the flat-headed borers of the family Buprestidae about 20 have been found to attack the pine, while rather more than 20 longicorn beetles of the family Cerambycidae live in the larval state in the wood of the trees of this genus. The white pine weevil (*Pissodes strobi*) lays its eggs in the bark of the topmost shoot of young trees. The larvæ mine in the wood and pith, causing the shoot to wither and die, thereby occasioning a crook or fork in the body of the tree at this point. It is fatal to the growth of these trees, and no competent remedy has been discovered.

The pine moth of Nantucket (*Retinia frustрана*), referred to above, causes the death of pine trees in large numbers. The moth lays its eggs on the twigs and the young larva burrows into the wood, ultimately causing the death of the trees. Many insects affect the leaves of pine, including about a dozen sawflies. In the Northwest a butterfly (*Pieris menapia*) lays its eggs upon pine, and the larvæ destroy the leaves. Another butterfly (*Thecla Nippon*) does similar work on the pines in Florida and Georgia. Two of the hawk-moths, *Lipara Combycoides* and *Lipara pinetum*, feed in the larval state upon pine foliage; and the larva of the imperial moth (*Eacles imperialis*) has similar habits. Many other caterpillars are also to be found doing similar work. The larva of a curious little tineid moth (*Gelechia pinifoliella*) mines in the pine-needles, and the larva of one of the gall-midges (*Diplosis resinicola*) lives in the pitch which exudes from injuries to the pitch pine. Another gall-midge (*Diplosis pini-rigidae*) makes small galls at the bases of the needle clumps. Several plant-lice and scale insects also feed upon the pine, the most notable being the pine-leaf chermes (*Chermes pinifoliae*) and the pine-leaf scale insect (*Mytilaspis pinifoliae*), the latter frequently covering pine needles in various parts of the United States with its minute white scales.

Consult: Packard, *Report on Insects Injurious to Forests* (Department of Agriculture, Washington, 1890); Hopkins, *Insect Enemies of the Pine in the Black Hills Forest Reserve* (ib., 1902).

PINEL, pé'nél', PHILIPPE (1745-1826). A French physician; born at Saint André, in the Department of Tarn. After receiving a classical training at the College of Lavour, he studied medicine at Toulouse, taking his degree in 1773. He continued his medical studies at Montpellier, and in 1778 removed to Paris. He applied himself to the study of mental aberration, obtained a prize for his book on the subject, and was appointed physician of the Bicêtre (1792) and of the Salpêtrière (a similar asylum, for females) in 1795. In these institutions he won fame by recognizing insanity as a disease and replacing the old barbarous methods of treatment with kinder and more humane methods. In the Salpêtrière Pinel inaugurated the scientific study of insanity by commencing a class of clinical medicine, which he continued after his appointment to the chair of medical physics and hygiene, and subsequently to that of pathology, at the School of Medicine in Paris. He was admitted as a member of the Institute in 1803. His most valuable works are the *Traité medico-philoso-*

sophie sur l'alienation mentale (1801) and *La nosographie philosophique* (1798), with its commentary, *La médecine clinique* (1802).

PINE LINNET, or SISKIN. See PINE FINCH.

PINELO, pé-nā'lo, ANTONIO DE LEON. See LEON PINELO.

PINE MARTEN. The American marten (*Mustela martes*). See MARTEN, and Plate of FUR-BEARING ANIMALS.

PINE MOUSE. An American meadow-mouse (*Microtus pinctorum*), rusty brown in general color, and distinguished by its long, silky, mole-like fur. It is more subterranean in its habits than others of our mice, and frequently makes long tunnels under the surface, showing raised roofs like those of the moles. It is especially numerous in the pine-wood districts of the Southern States, but also ranges north into Southern New England and westward throughout the Lower Mississippi Valley. Consult Stone and Cram, *American Animals* (New York, 1902).

PIN'ERO, ARTHUR WING (1855—). An English dramatist. He was born in London, on May 24, 1855, of Jewish ancestry on his father's side. He began his studies with a view to the practice of law, which he abandoned, however, and made his appearance as an actor at Edinburgh in 1874. Subsequently he was a member of the Lyceum company, and obtained under Henry Irving a practical experience in stagecraft which was of great value to him. About 1876 he made, with *Tico Can Play at That Game*, his first attempt at play-writing, to which after 1881 he devoted himself. His comedietta *Tico Hundred a Year* was produced at the Globe Theatre in 1877. In the long list of his later plays, which have been for the most part very successful, are: *The Money Spinner* (1880); *The Squire* (1881); *Lords and Commons* (1883); *The Rocket* (1883); *The Magistrate* (1885; published, London, 1892); *The Schoolmistress* (1886; published 1894); *The Hobby Horse* (1886; published 1892); *Dandy Dick* (1887; published 1893); *Sweet Lavender* (1888; published 1893); *The Weaker Sex* (1888; published 1894); *The Profligate* (1889; published 1891); *The Cabinet Minister* (1890; published 1892); *Lady Bountiful* (1891; published 1892); *The Amazons* (1893; published 1895); *The Second Mrs. Tanqueray* (1893; published 1895); *The Notorious Mrs. Ebbsmith* (1895; published 1895); *The Benefit of the Doubt* (1895; published 1895); *The Princess and the Butterfly* (1897; published 1898); *Trelawney of the "Wells"* (1898; published 1899); *The Gay Lord Quex* (1899; published 1900); *Iris* (1901; published 1902). Of his earlier pieces the most popular was perhaps the domestic drama called *Sweet Lavender*. Pinero's greatest work, however, is considered to be *The Second Mrs. Tanqueray*, about which the battle of the critics has been waged over the fundamental questions of the problem play of modern society. Its cleverness and dramatic force make it an admirable example of its kind.

PINEROLO, pé'nā-rō'lo (Fr. *Pignerol*). A town in the Province of Turin, Italy, situated on a hill on the left bank of the Chisone, 22 miles southwest of Turin by rail (Map: Italy, B 3). It has an eleventh-century cathedral, a lyceum, a gymnasium, a technical institute, and a the-

atre. There are manufactures of woollens, cottons, silks, leather, and paper, and a trade in grain, wine, cattle, fruit, and lumber. Population (commune), in 1881, 17,039; in 1901, 18,250. Originally a possession of a local Benedictine abbey, Pinerolo passed to the House of Savoy in 1188 and later became a residence city. It was taken by the French in 1536 and in 1631, when it was strongly fortified, its castle was the prison for the Man with the Iron Mask, Fouquet and Lauzun. Pinerolo was returned to Savoy in 1696 and its fortifications were demolished in accordance with the Treaty of Utrecht.

PINES, ISLE OF. An island south of Cuba. See ISLE OF PINES.

PINES, ISLE OF. A small island in Melanesia, situated near the southern extremity of New Caledonia (q.v.), of which it is a dependency. It has an area of 58 square miles, is mostly barren, except along the coast, and has a population, exclusive of convicts, of about 600 New Caledonians and a few European settlers. Since 1872 it has been a French penal station.

PINE SNAKE, or BULL SNAKE. A large robust colubrine serpent (*Pityophis melanoleucus*) of the southerly half of the United States, often exceeding six feet in length, and glistening creamy white, blotched with dark brown. It derives its name from the pine lands in which it is found, emits a strong disagreeable odor, and feeds on eggs, birds, and small mammals. It is harmless, but makes a loud hissing and sometimes even bellowing noise, when disturbed, to which fact it owes its name 'bull snake'; but why it should also be called 'thunder-and-light-

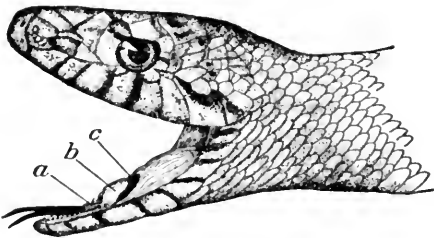

HEAD OF PINE SNAKE.

Showing formation of glottis: a, sheath of tongue; b, epiglottis; c, glottis.

ning snake' is not so easily explained. Three or four similar species and varieties inhabit dry, sandy regions, throughout the interior of the country, especially in the Southwest and in Mexico. These are brighter in color than is the Eastern species. Consult: Cope, *Crocodilians, Lizards, and Snakes* (Washington, 1900); Lockwood, "The Pine Snake," in *American Naturalist*, vol. ix. (Boston, 1874); Abbott, *A Naturalist's Rambles* (New York, 1884).

PINE SWIFT. The name in the Northern coast States of the 'fence-lizard' (*Sceloporus undulatus*). (See ALLIGATOR LIZARD; FENCE LIZARD.) It is very common in the pine woods from New Jersey southward. It is entirely harmless, and has many most pleasing ways.

PINE-TREE FLAG. A flag used in the Massachusetts Colony as early as 1700, at first red or blue with a pine-tree on the white field,

and later white bearing a pine-tree in the middle and the motto, "An Appeal to Heaven." This was the flag carried by the first war-vessels commissioned by Washington at the beginning of the Revolution.

PINE-TREE MONEY. Money coined in Massachusetts from 1652 to 1682, in the values of a shilling, sixpence, and threepence, so called from the rude figure of a pine-tree on one face, while the other bore "New England," with the date. The name 'Boston' or 'Bay' shilling was first used, being changed to 'Pine-tree' in 1680.

PINE-TREE STATE. Maine. See STATES, POPULAR NAMES OF.

PINEY DAMMAR. See DAMMAR.

PINEY-TREE. An East Indian tree. See CALOPHYLLUM.

PINEY VARNISH. See DAMMAR.

PING-PONG. A modified form of lawn tennis (q.v.) played on a table marked to scale, after the model of a full-sized lawn-tennis court. The bat is usually covered with a thin skin like a battledore, but resembles a lawn-tennis racket in shape, while the ball is generally made of light celluloid. The name ping-pong is a registered trade-mark, the game itself being by many attributed to an Englishman, James Gibb, who in 1891 called public attention to it, under the title 'gossima.' In 1900 the name was changed to ping-pong, and under that title enjoyed its greatest vogue. It spread to France and America, where for a short season it was very popular. Any kind of table may be utilized, but its size should not be less than 5 feet 6 inches by about 3 feet, nor larger than 10 × 5. The regulation table is 9 × 5, the height of the net, which is stretched across the middle of the table, being regulated at the ratio of three-fourths of an inch for every foot in the length of the table. The game is for two players standing one at each end of the table. The player who first delivers the ball is called the server and the other the striker out. At the end of each game the striker out becomes the server and vice versa. The service is strictly underhand, delivered from behind the end of the table. The ball served must drop on the table top anywhere beyond the net, and is then in play. If it drops into the net, or off the table, it counts to the striker out. There is no second service as in lawn tennis, but the system of scoring is the same as in that game. Consult Parker, *Ping Pong* (New York, 1902).

PIN'GREE, HAZEN SENTER (1842-1901). An American politician, born in Denmark, Maine, the son of a poor farmer. He worked in a cotton factory at Saco, and in 1860 entered a shoe factory at Hopkinton, Mass., whence he enlisted in 1862 in the First Massachusetts Heavy Artillery. He was captured by Mosby in 1864 and imprisoned at Andersonville for a few months. In 1865 he settled in Detroit and started the shoe firm of Pingree & Smith. In 1889 he was elected Mayor of the city on the Republican ticket, and served four terms. In 1896 he got control of the Republican State organization and was elected Governor, and held that office until 1900.

PING'-YANG' (Korean *P'yŏng*-, *Phyŏng*-, or *P'yŏng-Yang*). A walled city of Korea, capital of the Province of South Phyŏng-an, and the

most important city in the country after Hanyang Pu, the Seoul or capital (Map: Korea, G 4). It stands in an undulating plain on the right bank of the Ta-tong River, about 36 miles above its mouth. Its walls are 20 feet high, run parallel with the river for about 2½ miles, and are loop-holed and battlemented and pierced with several gates with imposing towers. The streets are laid out at right angles. P'ing-yang is the most ancient city of Korea, Ki-ja (see KI-TSE), the reputed founder of Korean civilization, having landed here some time after B.C. 1122. The superstitious notion is held by Koreans that the city is boat-shaped (representing the craft on which Ki-ja arrived from China) and that it is the height of good sense not to sink wells within the city lest the vessel be scuttled. The water supply of the inhabitants is, therefore, carried in from outside. Two large stone posts about 1½ miles above the town are supposed to be the mooring posts. The tomb of Ki-ja is one of the sights of the city. P'ing-yang is open to foreigners, and much successful missionary and educational work is carried on.

The city is regarded as the military key to Korea, and in consequence it has suffered much from war. A great battle was fought here in 1593 between the Chinese troops sent to succor Korea during Hideyoshi's invasion and the Japanese troops under Konishi; and the principal battle of the Japanese-Korea-Chinese War of 1894-95 was fought here September 16, 1894, resulting in the utter defeat of the Chinese, who lost 4000 men. A handsome stone monument in memory of the Chinese General Tso, who led the cavalry, has been erected on the spot where he died, and on a lofty knoll within the city is a monolith erected by the Japanese to their dead.

PINK (from *pink*, to puncture, to pierce; so called from the jagged edges of the petals). *Dianthus*. A genus of about 70 annual and perennial plants of the natural order Caryophyllaceae, chiefly natives of Europe and the temperate parts of Asia. Their beautiful and often fragrant solitary or clustered flowers are borne at the ends of the branches, and have attracted admiration in all ages, some of the species having been long cultivated in gardens. Their cultivation has given rise to many varieties, including single and double forms of many different colors. The species *Dianthus Caryophyllus*, including the well-known and widely cultivated carnation (q.v.), clove pink, picotee, or grenadine, is native to Southern Europe, where it is found growing wild on rocks and old walls. The common pink, also called feather pink (*Dianthus plumarius*), is the parent species of many cultivated forms. This has always been a favorite ornamental plant on account of its hardiness and the beauty and fragrance of its blossoms. It differs from the foregoing species in having rough-margined leaves and fringed petals. Nearly allied to the common pink is *Dianthus superbus*, found in moist places in some parts of Europe and often grown in flower-borders. The maiden pink (*Dianthus deltoides*) is a low growing perennial frequently cultivated for its dense masses of leaves and flowers. The China or Indian pink (*Dianthus chinensis*) has long been in cultivation and numerous dwarf and double and single flowered varieties of many varied colors have been developed. The sweet William, or bunch pink (*Di-*

anthus barbatus), is a popular species of easy cultivation and abounds in country gardens. Its flowers are crowded into dense flat clusters at the top of the stem. The varieties are exceedingly numerous and include many highly developed forms. The Deptford pink (*Dianthus Armeria*) is a small European species which has become



PINK (*Dianthus plumarius*).

naturalized in the Eastern United States. Pinks prefer a rather light sandy loam soil. They are propagated from seeds and from cuttings. If the plants are to flower the same season the seeds are sown in heat during February, transplanted when the plants are large enough, and hardened gradually to cool culture until May, when they are set out. Seeds sown in the open during summer produce plants which blossom the following year. The young plants of outdoor sowings are also transplanted as soon as they become crowded and finally transferred to their flowering position in fall. Many varieties of pinks are grown as greenhouse plants, and these are generally increased by layers or cuttings.

PINKERTON, ALLAN (1819-84). A Scottish-American detective, born in Glasgow, Scotland. In 1842 he emigrated to America to escape punishment for his part in the Chartist Movement, and soon afterwards settled in Chicago, where he opened a detective agency. Before the outbreak of the Civil War he had become widely known, and in 1861 he guarded President Lincoln during the latter's journey to Washington for the inauguration. Soon afterwards he was commissioned to organize the Federal Secret Service Department, of which he was made the head. During all this time he continued his private detective agency in Chicago, and established branch agencies in other important cities. When the changed industrial conditions that followed the war led to strikes and violence, he organized a force of armed men which he hired to employers and corporations for the protection of their property. This mercenary force, known as 'Pinkerton's Men,' played a conspicuous part in some of the most important labor disturbances of the last quarter century, notably in the suppression of the Molly Maguires (q.v.)

and in the Homestead strike. Among other well-known cases with which Pinkerton was connected were the capture of the robbers who took \$700,000 from the Adams Express Company's safe on a New York, New Haven and Hartford Railroad train, on January 6, 1866, and the dispersion of a gang of murderers who for a number of years terrorized all southern Indiana. He wrote several books on subjects connected with his work, among them: *The Molly Maguires and the Detectives* (1877); *Criminal Reminiscences* (1878); *The Spy of the Rebellion* (1883); *Thirty Years a Detective* (1884); and *History and Evidences of the Passage of Abraham Lincoln from Harrisburgh, Pa., to Washington, D. C., on the 22d and 23d of February, 1861* (1891).

PINKERTON, JOHN (1758-1826). A Scottish antiquary and author, born in Edinburgh, February 17, 1758. He was educated at the grammar school of Lanark; articled to a writer to the signet in Edinburgh; abandoned law for literature; settled in London (1781); and resided during his last years in Paris, where he died, March 10, 1826. Among his numerous publications are: *Rimes*, a volume of verse (1781); *Select Scottish Ballads*, professing to be ancient (1783); *Essay on Medals* (1784); *Letters of Literature* (1785); *Ancient Scottish Poems Never Before in Print, from the Manuscript Collection of Sir R. Maitland* (1786); and *The History of Scotland from the Accession of the House of Stuart to that of Mary, with Appendices of Original Documents* (2 vols., 1797). This last work, though valuable for its matter, is disfigured by an attempt to rival the style of Gibbon. Consult his *Literary Correspondence*, edited by Dawson Turner (London, 1830).

PINKEYE, or INFLUENZA. An infectious disease prevalent among horses. It is characterized by high fever, rapid prostration, swelling of the mucous membrane of the eyes, which become red and congested. On account of this condition the disease is called pinkeye. The cause is believed to be a specific bacillus similar to that producing influenza in man. The spread of the disease is also attributed to swarming of frits (q.v.), which get into the eyes of the horses. The treatment is symptomatic. Good food and water, fresh air and sanitary surroundings are of first importance. The heart should be watched carefully and if necessary cardiac stimulants used. The eyes should be bathed with an antiseptic wash.

PINKNEY, PINK'NI, EDWARD COATE (1802-28). An American poet, born in London, England, October 1, 1802. He was the son of William Pinkney, the well-known Maryland lawyer and orator, and was born while the latter was commissioner in England. He served in the navy (1816-24), was admitted to the Baltimore bar in the latter year, was made professor of rhetoric and belles-lettres in the University of Maryland, and edited the *Marylander* (1827); but he is best known for a tiny volume of *Poems* (1825), since highly praised by Poe and others and several times reprinted. Pinkney died in Baltimore, Md., April 11, 1828.

PINKNEY, WILLIAM (1764-1822). An American statesman, born at Annapolis, Md. He was educated at King William's Seminary (afterwards Saint John's College), studied law under Justice Samuel Chase, and was admitted

to the bar in 1786. In 1788 he was a member of the convention to ratify the Federal Constitution, and was elected to the House of Delegates the same year. In 1796 he was appointed a commissioner to England to determine the compensation due American merchants under the Jay Treaty (q.v.), and secured a claim of \$800,000 for Maryland on the Bank of England. He returned to practice law in Baltimore in 1804, and was elected Attorney-General of Maryland in 1805. In 1806 he was sent to England as Minister Extraordinary to treat in conjunction with Minister Monroe regarding the violation of rights of neutrals. On the return of Monroe in 1807 he remained as resident Minister until recalled at his own request in 1811. On his return he was elected to the Maryland State Senate, but was appointed Attorney-General of the United States by President Madison. He commanded a regiment of riflemen during the War of 1812, and was wounded at Bladensburg. He was a member of the national House of Representatives in 1815-16, and in the latter year was appointed Minister to Russia and Special Envoy to Naples. He resigned in 1818 to practice law, and was engaged in many important cases. In 1820 he was elected to the United States Senate, and opposed the admission of Missouri. Consult Wheaton, *Life, Writings, and Speeches of William Pinkney* (1826), which is condensed in vol. vi. of *Sparks's American Biography*. Consult also Pinkney, *Life of William Pinkney* (1853).

PINK ROOT. The root of a species of Spigelia (q.v.).

PIN-MONEY. In law, a sum of money paid periodically by a husband to his wife, to be expended for dress, ornament, and other personal expenses. The origin of the term has never been traced satisfactorily, but writers of some authority assert that it was derived from an ancient tax levied in England for the purpose of supplying the Queen with pins. The practice of providing such an annual sum for the wife's separate use, by means of a marriage settlement, was at one time quite common among the nobility in England. Out of this allowance the wife was supposed to maintain the dignity of her station in the matter of dress, ornament, private benefactions, etc. It was, therefore, intended to be spent and not accumulated. Accordingly, if a husband pays the wife's personal expenses directly, it is a bar to a claim for arrears of pin-money, and, in any event, while the wife continues to cohabit with the husband she cannot collect the arrears for more than one year. However, if she lives separately, all arrears may be collected. If the wife saves anything out of her pin-money while living apart from her husband it becomes her separate property; but if they are living together, such accumulation goes to the husband's representatives on his death, unless he had consented to his wife's saving for her own benefit.

The custom of providing pin-money is no longer common in England, and never gained favor in the United States, although there are some early decisions which apply the English law to such allowances. A weekly or monthly sum paid to the wife for household expenses, etc., does not correspond to pin-money. Sums given to the wife by the husband voluntarily from time to time, when he does not indicate that they are

to be used for a specific purpose, are usually considered as gifts, and become the separate property of the wife. See DOWRY; HUSBAND AND WIFE. Consult the authorities referred to under HUSBAND AND WIFE.

PINNA (Lat. *pinna*, *pina*, from Gk. *πύνα*, *πύνα*, sort of mussel). The popular and generic name of a group of marine mussels with very thin, wedge-shaped shells, tapering to a point at the hinge. The byssus is remarkably long and silky, and by it the species affix themselves to submarine rocks and other bodies, sometimes even to sandy or muddy bottoms. The best-known species is *Pinna nobilis*, of the Mediterranean, the byssus of which was occasionally used by the ancients for fabrics, chiefly as an article of curiosity.

PINNACE (Fr. *pinacc*, *pinasse*, from It. *pinassa*, *pinazza*, pinnace, pine, made of pine, from *pino*, from Lat. *pinus*, pine). Formerly a small two-masted vessel, fitted to be propelled by oars as well as sails, and generally employed as a tender to large ships. The French armed pinnace was usually of 60 to 80 tons, and carried one large 24-pounder and about 100 men. In the United States Navy the term pinnace is not used, but in the British Navy it is still applied to a large carvel-built boat similar to the American sailing launch.

PINNACLE (Lat. *pinnaculum*, diminutive of *pinna*, feather, wing, pin, pen). A termination of tapering form crowning some architectural member. Unknown to ancient art, it was occasionally used in the mediæval Mohammedan and Romanesque styles, but did not become common until the Gothic period, when it became a most important decorative element of architecture. It crowned façade buttresses and flying buttress piers, it filled in the four corners of square towers at the spring of the polygonal spire, it rose as a termination of piers or shafts at gable corners. Groups of pinnacles were sometimes profusely scattered over the roof, as at Milan Cathedral. Pinnacles were square, polygonal, or circular, with spires or gables crowned with finials; they had either an open story or solid masonry with engaged colonnettes and arcades. Sometimes they included a niche containing a statue. The main pinnacles on the buttress piers of Rheims Cathedral are 80 feet high. They are of all sizes, and of the greatest variety of form and decoration.

PINNATED GROUSE. The prairie-chicken. See section on *Prairie Chicken*, under GROUSE.

PIN-NIPE'DIA (Neo-Lat. nom. pl., from Lat. *pinna*, feather, fin + *pes*, foot). A section of Carnivora, comprising seals, otaries, and walruses, in which the fore and hind limbs are short and expanded into broad, webbed swimming paddles. The hind feet are placed very far back, nearly in a line with the axis of the body, and somewhat incorporated with the tail by the integuments. The body is elongated and covered with short fur or hairs, and terminated by a short conical tail. The five toes of each foot are united by the skin and form powerful swimming paddles. The tips of the toes are armed with claws, but they have little power for land locomotion, the typical seals being able only to drag themselves along when out of the water. The

ears are small, often only indicated by apertures, which the animal can close under water. The dentition varies, but teeth of three kinds are always present. The canines are always long and pointed, and the molars have sharp cutting edges.

The pinnipeds include three families, the earless seals (*Phocidæ*), the eared seals or otaries (*Otariidæ*), and the walruses (*Trichechidæ*). The seals differ from the walruses by having incisor teeth in both jaws, and moderate-sized canines, and from the otaries by the absence of ears and inability to use the hind limbs on land. The eared seals, sea-lions, or otaries differ from the typical seals by having small, conical ears, and in the greater use of the limbs, especially the hind limbs, so that they are enabled to execute a sort of walk. Consult: Beddard, *Mammalia* (London, 1902); Allen, *Monograph of North American Pinnipeds* (Washington, 1880). See SEAL; WALRUS.

PINNULE (from Lat. *pinnula*, diminutive of *pinna*, feather, wing, pin, pen). In a pinnately compound leaf, one of the subdivisions of the first divisions or pinnæ. The term has most frequent application among the ferns.

PINOCHLE, pē'nō-k'l' (Ger., of uncertain etymology). A game of cards. Where there are only two players, the game is opened by cutting for deal, which may be according to the highest card, all being high, or by one of the players dealing the cards alternately, one at a time and face upward, the player to whom falls the first ace turned up winning the first deal. Below the ace, the cards decrease in value as follows: Ten, king, queen, knave, nine, eight, and seven. Each player receives eight cards, commencing with the eldest hand, by two and three at a time, after which the seventeenth card is turned up for trump and exposed on the table. Should the card so turned up be a seven, the dealer scores 10 points immediately. The eldest hand begins the game by leading, after which the lead goes to the winner of the preceding trick. After the trick is played each player draws a card from the top of the talon, the winner of the preceding trick first. The drawing is continued after each trick until the talon is finished. The winner of the previous trick must make his announcement before drawing from the talon, only one announcement at a time being permissible. No more announcements can be made after the talon is exhausted, and suit must be followed, with the provision that if a player cannot follow suit, if possible he must play a trump. The face value of the cards is counted at the end of each game, and the points added to the value of the announcements and credited in the score; the winner of the last trick adds ten points additional. All announcements are based on the cards held in hand at the time of announcing. The five highest trumps count 150; four aces 100; four kings 80; four queens 60; four knaves 40; pinochle, or queen of spades and knave of diamonds, 40; king and queen of trumps 40; king and queen of any other suit 20. Seven of trumps counts 10, and, when duly announced for the turned-up card, is exchangeable. In this game 500 points constitute the game, and the player first making that score may throw down his hand and claim the game.

The game above described is the original single pinochle, but the modern and more generally adopted game is played with a specially prepared pinochle pack of cards, or with two packs of cards, of which only the ace, ten, king, queen, knave, ten, and nine of each pack are kept—a total of 48 cards in all. The dealer deals four cards at a time, until each player has twelve, the next or twenty-fifth card being turned up for trump and placed exposed by the side of the undealt cards. The scoring is the same as in the older game, except that 1000 points are game, and the value of announcements as follows: Eight aces 1000; eight kings 800; eight queens 600; eight knaves 400; double pinochle (i.e. two queens of spades and two knaves of diamonds) 300; ace, ten, king, queen, and knave of trumps 150; four aces of different suits 100; four kings of different suits 40; pinochle (i.e. queen of spades and knave of diamonds) 40; king and queen of trumps (styled a royal marriage) 40; king and queen of any suit not trumps (styled a marriage) 20. Generally speaking, the laws of bezique will be found to govern most matters of detail in pinochle.

In the three-handed game, all the cards are dealt by four at a time, the last card being turned up for trumps. Should a nine be turned up, the dealer scores 10 points; but where that does not happen, either of the other players holding a nine of trumps may exchange it for the trump card and claim the 10 points, the eldest hand having precedence. Each player melds or announces whatever he has in hand, but no melded points are added to the score until the player has taken a trick. Four-handed pinochle is played in the same manner as for three players, except that, to prevent the eldest hand getting information which would influence his play, no melds are permitted until he has led a card for the first trick, after which he may announce his melds. Each of the other players must first play to the first trick before declaring the melds.

PIÑON, pēn'yōn. A kind of pine (q.v.).

PINOS, pē'nōs. A town of the State of Zacatecas, Mexico, 65 miles southeast of the capital of the State (Map: Mexico, II 6). It is in the midst of an important mining region, with extensive gold and silver deposits, and manufactures large quantities of mescal. Its municipal population in 1895 was 8183.

PINSK. A district town in the Government of Minsk, Russia, situated in a marshy region on the Pina, about 105 miles east of Brest-Litovsk (Map: Russia, C 4). It has a Roman Catholic church of the fourteenth century, a realschule, and manufactures of matches, lumber, and leather. The commercial importance of the town has greatly decreased since the construction of the Poliessie railways. Population, in 1897, 28,028. Pinsk is mentioned as early as the eleventh century, and was formerly the capital of a separate principality.

PINSUTI, pēn-sōō'té. CIRO (1829-88). An Italian-English teacher of singing and composer, born in Siena. He studied under his father, and played in public at the age of ten. Subsequently he went to England under the auspices of the celebrated Henry Drummond, and studied the piano-forte and composition under Potter and the violin

under Blagrove. In 1845 he entered the Conservatorio di Bologna, where he became Rossini's favorite pupil. In 1848 he returned to England, and gave singing lessons in London and Newcastle. He was also appointed in 1856 professor of singing at the Royal Academy of Music, London. His compositions include several indifferently successful operas, pianoforte pieces, and over two hundred English and Italian songs, choruses, and part songs. His fame chiefly rests upon his songs. In England he was regarded as practically a native composer, largely through his appeal to the national spirit in such songs as "Where are the Boys of the Old Brigade?" He died in Florence.

PINT. See WEIGHTS AND MEASURES.

PINTA. The name of one of the three caravels in which Columbus made his first voyage to America.

PINTA'DO. See PETREL.

PINTAIL, or SPRINGTAIL DUCK. A common, widespread, and highly esteemed duck (*Dafila acuta*), characterized by the long tapering tail of the drake. It is about equal in size to the mallard, but more slender. The head is brown, with a white line on each side extending down the neck; the back and sides marked with wavy lines of black and grayish-white; the lower parts white; the elongated central tail feathers black. It is a native of all the northern parts of the world, migrates southward in winter, and is a regular visitant of many parts of the Atlantic coasts. It also frequents fresh-water lakes and ponds, and is common in winter in the valley of the Mississippi. It breeds from Iowa northward, but chiefly in the interior, and is not known as a summer resident anywhere on the Atlantic coast. Its winter range extends southward to the Mediterranean and the Gulf of Mexico, and even to Africa and the West Indian islands. Consult Baird et al., *Water Birds of North America* (Boston, 1884).

Some other birds having long sharp tails are called 'pintails' by sportsmen, as, especially, one of the European sand-grouse (*Pterocles setarius*).

See PLATE OF EGGS OF WATER AND GAME BIRDS.

PINTO, pēn'tō. See SERPA PINTO.

PINTO, FERNAO MENDES (1509 or 1510-83). A Portuguese traveler and the first white man to visit Japan. He was born at Montemor-o-Velho (Beira). Embarking for the East Indies, his ship was captured by the Turks and he was sold as a slave. According to his own account, his adventures were very wonderful. He spent twenty-one years in Asia and Africa, was thirteen times taken prisoner and seventeen times sold as a slave. While returning in a pirate junk from Cochinchina to China, his vessel was separated from her companions, and after twenty-three days on the open sea he sighted the island of Tane (Tanégashima), one of the Loo-choo islands (q.v.), where the strangers were welcomed and given a house. They surprised the people by their firearms, which the Japanese quickly imitated, making over 600 guns within five and a half months, and on one of his three later visits to Japan Pinto found firearms in a great many places. To this day, among Japanese country folk, a pistol is called Tanégashima. Hokusai (q.v.) pictured Pinto and his companions with their firearms in his albums. Re-

turning to Portugal in 1558, Pinto lived at Court several years and died near Lisbon, July 8, 1583. His posthumous work, *Peregrinação*, appeared at Lisbon in 1614 and was at first supposed to be a sort of Robinson Crusoe romance, but in the main, and apart from personal items, its statements have been confirmed by modern research. An English rendering by Cogan appeared in London in 1663, 1692, and 1891 (*Adventures and Voyages of Ferdinand Mendez Pinto*).

PINTSCH SYSTEM. A process for the production of compressed gas, used chiefly for lighting railway cars. When ordinary coal gas is burned at the pressure of street mains it gives an illumination of about 4 candles to each cubic foot, while oil gas at the same pressure yields about 16 candles to the cubic foot. Compression and storage of gas produce a diminution in illuminating power in consequence of the deposition of the rich oily hydrocarbons. This loss, however, is much less in oil gas than in coal gas. At 125 pounds pressure to the square inch, one foot of oil gas is equal in illuminating power to about five feet of coal gas. The use of oil gas for the purpose of illuminating railway cars is, therefore, much more economical, and the Pintsch system finds extensive use on many of the leading railway lines in the United States. The outfit consists of storage tanks, a pressure regulator, and a system of piping to the lamps, which are of special design, each having from four to six burners arranged beneath a porcelain reflector, the whole being incased in a glass bell-jar.

PINTURICCHIO, pên-tōō-ré'kê-ō (It., little painter) (1454-1513). The name commonly applied to Bernardino di Betto, an Italian painter of the Umbrian school (early Renaissance). He was born at Perugia, where he studied under Fiorenzo di Lorenzo, later reflecting many of the mannerisms of his contemporary Perugino. The latitude of his subjects and the distinctly illustrative and historical character of many of them have rendered him famous as the historical painter of the Umbrian school. Though using the Umbrian forms, which catered to mediæval tradition, Pinturicchio's works reflect the humanistic spirit of the times. They are mainly frescoes, highly decorative in style, and not without charm of color. As compared with Perugino, Pinturicchio lacks character and dramatic vigor; but he is less conscious and does not fatigue by monotony. In 1484 the artist was engaged as assistant to Perugino in fresco work in the Sistine Chapel. The "Adoration of the Shepherds" in Santa Maria del Popolo and decorations in the Palazzo Belvedere and Palazzo di San Apostolo, Rome, were executed before 1491. Between 1491 and 1501 he produced frescoes in the Cathedral of Orvieto; in the Vatican, Rome; the series illustrating the life of San Bernardino, in the Bufalini Chapel, Araceli, Rome; and the "Madonna" in the Perugia Academy. At Spello, near Foligno, he left numerous works by himself and his pupils. In 1502 Cardinal Francesco Piccolomini intrusted to him the decoration of the cathedral library at Siena. These frescoes, depicting the life of Æneas Sylvius Piccolomini (Pope Pius II.), called upon the artist for the display of his talent in ceremonial composition. The commission was completed in 1508, with the aid of many assistants, among whom was Raphael, who came to Siena in 1503.

The late works of Pinturicchio show a haste and carelessness that would tend to substantiate the accusation that his love of gain got the better of his love of art. He died in Siena, December 11, 1513.

Consult: Morelli, *Italian Masters in German Galleries*, translated (London, 1883); Vermiglioli, *Memorie di Bernardino Pinturicchio* (Perugia, 1837); Schmarzon, *Rafaël and Pinturicchio in Siena* (Stuttgart, 1880); id., *Bernardino Pinturicchio in Rome* (ib., 1882); Ehrle and Stevenson, *Gli affreschi del Pinturicchio nell'appartamento Borgia* (Rome, 1897); Steinmann, *Pinturicchio* (Leipzig, 1898); Ricci, *Pinturicchio: His Life, Work, and Time* (London, 1902).

PINUS. A genus of trees. See PINE; CONIFERÆ; GYMNOSPERM.

PINWORM. One of the nematode worms (*Oxyurus vermicularis*) parasitic in the large intestine and rectum of man, especially in children. It is a small white worm, half an inch long or less, and very slender. The females are larger than the males. Unlike many nematodes, the pinworms reproduce directly in their host, and have no alternation of hosts or of generations. The eggs are very minute and must be taken into the body with the food or at least through the mouth, but the exact manner of infection is not really known. The presence of these worms is often a matter of discomfort, but they are rarely so numerous that their presence is a source of danger to the person afflicted.

PINZON, pên-thôn', FRANCISCO MARTIN. A Spanish navigator, brother of Martin Alonso and Vicente Yañez Pinzon (qq.v.). He was pilot of the *Pinta*, on the first voyage of Columbus.

PINZON, MARTIN ALONSO (c.1440-93). A Spanish navigator, companion and patron of Columbus. He was born at Palos and attained distinction as a bold and skillful sailor, making distant and profitable voyages as far as the Guinea Coast. Through Fray Juan Perez de Marchena, prior of the Convent of La Rábida, he came to know Columbus, and his enthusiasm was aroused by the scheme of the great navigator. With his brothers, Vicente Yañez and Francisco Martin, he exerted his influence in the seafaring town of Palos to enlist men for the voyage across the Atlantic. The brothers also lent Columbus the money which he was to contribute as his share of the cost of the expedition. On the first voyage of discovery Martin Alonso commanded the *Pinta*. As the fleet was coasting along Cuba after the landfall on Guanahani Island, he separated from the other two ships in disregard of the Admiral's orders (November 21, 1492). He was the first to discover the island of Haiti, on the coast of which he rejoined Columbus January 6, 1493. He was met with severe reproaches by Columbus, who charged him with treasonable intentions; and indeed there is little doubt that Pinzon was envious of the glory which had fallen to the Genoese and was desirous of linking his own name with some great discovery. On the return voyage Martin Alonso, in the *Pinta*, parted company with the *Niña* during a storm, and reaching Bayona in Galicia, sought to obtain an interview with the Spanish monarchs, who, however, refused to receive in person any one but the Admiral. Pinzon thereupon set sail for Palos, which he reached on the same day as Columbus (March 15th). As the result prob-

ably of privations encountered during the voyage, he died soon after at the Convent of La Rábida. Consult Asensio, *Martin Alonso Pinzón, estudio historico* (Madrid, 1892).

PINZON, VICENTE YAÑEZ (c.1463-c.1519). A companion of Columbus. He was born in Palos, and was a younger brother of Martin Alonso Pinzon (q.v.). Pinzon commanded the *Niña* on the first voyage, and afterwards became the greatest of the seafaring men engaged in discoveries in the New World, down to the time of Magellan. He appears to have made several independent voyages before the close of the century, and it is probable that in 1497 (accompanied perhaps by Vespuceius) he reached the mainland of America (discovering Central America) almost simultaneously with Cabot's landing on the continent. He sailed again on November 18, 1499, returning the following September, after discovering the coast of Brazil and the mouth of the Amazon. In 1505 he was appointed to command an expedition to the Spice Islands, but Portuguese intrigues prevented him from sailing, and instead he was given charge over the fortifications to be erected in Porto Rico. He was also made Governor of the island with authority to colonize it. He was, however, a seaman rather than an administrator, and he spent the next year or two trying to get the command of a fleet, which the Portuguese prevented, as he was suspected of designs against their territories. In June, 1508, he finally got away, with Juan Diaz de Solis. They returned in November, 1509, but no record survives as to where they secured their cargo of gold and other New World products. Consult Harrisse, *Discovery of America* (London, 1892).

PIOMBINO, pé'óm-hé'nó. Formerly an independent principality of Northern Italy, now a part of the Province of Pisa. It belonged to Pisa before 1399, when it became independent under rulers of the House of Appiani. In 1700 it came into the possession of the Buoncompagni. It was incorporated with France in 1801, but from 1805 to 1814 was ruled as a principality by Elisa Bacciochi, the sister of Napoleon. In 1815 it was united with the Duchy of Tuscany.

PIOMBINO. A town in the Province of Pisa, Italy, situated on a promontory projecting into the Tyrrhenian Sea, 40 miles by rail southeast of Leghorn (Map: Italy, E 5). Its ancient walls and ruins of an old castle still remain. The town has a busy harbor, and manufactures ironware and oil. Population (commune), in 1901, 8309. To the north are Etruscan and Roman remains of the town of Populonia, whose site still preserves the ancient name.

PIOMBO, pé-óm'hó, SEBASTIANO DEL. See SEBASTIANO DEL PIOMBO.

PIONEER (Fr. *pionnier*, OF. *peonnier*, foot-soldier, sapper, from OF. *pcon*, *paon*, *pion*, foot-soldier, Fr. *pion*, pawn, from ML. *pedo*, foot-soldier, from Lat. *pes*, foot; ultimately connected with Eng. *foot*). A military mechanic, or laborer. Originally pioneers were ordinary laborers of the country in which the army was operating. Their name was undoubtedly derived from the fact that their principal duty was to prepare the way for the advance of the troops, cutting down trees, building bridges, removing obstacles, etc. They were the forerunners of the modern military

engineer (see ENGINEER CORPS), the engineers or technical troops of Germany being still known as pioneers. In the British Army there are two pioneers to every company of infantry, who collectively are under a pioneer sergeant, a regimental staff non-commissioned officer. Their equipment consists of either a pick, shovel, or axe, and a one-edged, pointed sword, the other edge of which is cut like a saw. Pioneers are the only soldiers allowed to wear beards. On the march, or on occasions of ceremony, they parade with the non-commissioned staff; and in column of route, precede the band. To be a pioneer, a soldier must be a skilled mechanic, and have passed the pioneer instruction course at Chatham. He receives working pay. See ENGINEERING, MILITARY.

PIONEERS, THE. A novel by James Fenimore Cooper (1823). Though the earliest published, it is the last but one in order of the *Leatherstocking Tales*, giving the old age of Natty Bumppo and the death of Chingachgook.

PIORRY, pé'ótré, PIERRE ADOLPHE (1794-1879). A French physician, born in Paris. He was educated there, became doctor of medicine in 1816, and in 1840 was appointed professor of pathology and in 1850 of clinical medicine. He devised a new nomenclature which met with no success and invented the pleximeter for mediate percussion, for which he received the Montyon prize in 1828. He wrote: *De l'hérédité dans les maladies* (1840); *Traité de médecine pratique* (1842-51); and *Traité de plessimétrie* (1866).

PIOTRKOW, pyótr'-kóv. A government of Russian Poland, bounded on the north by the Government of Warsaw. Area, 4735 square miles. The surface is mostly level and somewhat undulating toward the south. Coal and iron are found in some parts of the government and mined to some extent. The chief rivers are the Warta and the Pilica. Although the soil is not well adapted for agriculture, this is the chief industry. Stock-raising is also of some importance. Textiles represent the leading manufacturing industry, of which Lodz and Piotrkow are the two centres in Russian Poland. Population, in 1897, 1,406,951.

PIOTRKOW. The capital of the government of the same name in Russian Poland, situated on the Warsaw-Vienna Railway, about 16 miles southeast of Lodz (Map: Russia, A 4). It has a number of old churches and monasteries, an old castle, two gymnasia, and a fine town hall. The chief manufactures are farm implements and textiles. Population, in 1897, 30,400. Piotrkow is one of the oldest towns of Poland, being mentioned as early as the twelfth century. It was fortified by Casimir the Great and received Magdeburg rights in 1404. It was the scene of frequent diets and in 1577 became the seat of the highest tribunal of Great Poland.

PIOZZI, pé-ót'sé, Mrs. HESTER LYNCH, better known as Mrs. THRALE (1741-1821). A noted friend of Dr. Samuel Johnson. She was born at Bodvel, in Carnarvonshire, Wales. In her girlhood she learned Latin, French, and Italian, wrote for the *Saint James's Chronicle*, and was known among her friends for her cleverness and lively disposition. In 1763 she married Henry Thrale, a well-to-do Southwark brewer, her senior by thirteen years. It was no love match; but except for some flirtations of the husband, the

union was comfortable. Thrale had a house in Southwark and an estate at Streatham, near Croydon. Dr. Johnson became acquainted with Mrs. Thrale in 1764, and for sixteen years spent much time at Streatham Park. He was there usually from Saturday till Monday, and for months—during the summer. The memorable friendship was of great value to him. By society his eccentricities in dress and manners were toned down; and his disposition to gloom was neutralized by the presence of a vivacious and charming woman. In his whole career this is the only bright period. Thrale died in 1781, and three years later his widow married Gabriel Piozzi, an Italian musician. Piozzi was a man of talent and honor, but Johnson could brook no divided affection. He never again saw the friend who had so long ministered to his comfort. Immediately after the marriage, the Piozzis went to Italy, returning to England in 1787. They lived at Streatham till 1795, when they settled at Bachycraig, Flintshire, Wales, an estate Mrs. Piozzi inherited from her father. They afterwards built a villa, named Brynhella, on the Clwy. There Piozzi died in 1809. Mrs. Piozzi passed her last years mostly at Bath, Clifton, and Penzance. She died, May 2, 1821. Mrs. Piozzi's only valuable contributions to literature are *Anecdotes of the Late Samuel Johnson* (1786) and *Letters to and from the Late S. Johnson* (1788). Of her occasional verse, the best is *Three Warnings*, published in the *Miscellanies* of Mrs. Williams (1766), containing also Johnson's *Fountains*, a prose tale, of which the heroine is Mrs. Thrale. While at Florence in 1785 Mrs. Piozzi associated with the Della Crusceans and wrote for the *Florence Miscellany*, afterwards ridiculed by William Gifford (q.v.). Consult her *Autobiography*, *Letters*, and *Literary Remains*, ed. by Hayward (London and Boston, 1861); Mangin, *Piozziana* (London, 1833); Seeley, *Mrs. Thrale*, life and selections from writings (London and New York, 1891); *Glimpses of Italian Society in the Eighteenth Century, from the Journey of Mrs. Piozzi*, by the Countess Cesaresco (London, 1892); Boswell's *Life of Johnson* (ib., 1791); and the *Diary of Mme. d'Arbly* (ib., 1842-46).

PIP. The hero of Dickens's *Great Expectations*, who on the death of his unknown benefactor, the convict Magwitch, instead of gaining the wealth he had anticipated, is reduced to poverty.

PIP. A disease of poultry. See ROUP.

PIPA (Neo-Lat., from the native name of the Surinam toad). A South American frog (family Pipidae), the 'Surinam toad' (*Pipa Americana*), celebrated for its extraordinary method of carrying its eggs in the skin of the back. It is a peculiar, ugly-looking creature. The whole skin is covered with small tubercles, and is dark in color on the upper surfaces, but whitish on the under side of the body. Everywhere the skin bears papillæ, each with a little horny spike, and many with a poison gland at the base. The back of the female is furnished with numerous cells or pouches, in which the eggs are hatched and the young undergo all their transformations. It was not until the process was observed by Bartlett, who watched captive specimens in London (*Proceedings of the Zoölogical Society*, London, 1896, p. 595) that the method of placing the eggs in this curious nursery

was understood. Late in April, 1896, Bartlett noticed that the male pipa toads were becoming very lively, and were constantly heard uttering their metallic, ticking call-notes. On examining them, two of the males were observed clasped tightly around the lower parts of the bodies of females, the hind parts of the males extending beyond those of the females. On the following morning the keepers arrived in time to witness the mode in which the eggs were deposited. The oviduct of the female protruded from her body more than an inch in length, and the bladder-like protrusion, being retroverted, passed under the belly of the male on to her own back. The male appeared to press tightly upon this protruded bag, and to squeeze it from side to side, apparently pressing the eggs forward, one by one, on to the back of the female. By this movement the eggs were spread with nearly uniform smoothness over the whole surface of the back of the female, to which they became firmly adherent. When the operation was completed the males left their places on the females, and the enlarged and projected oviduct gradually disappeared. The eggs are produced in the early part of the rainy season, when these highly aquatic frogs have plenty of water about them, and at that time it is very difficult to capture them. In the dry season these frogs collect in swamps and ditches, and sometimes come close to or into houses. Consult Gadow, *Amphibia and Reptiles* (London, 1901).

PIP'CHIN, Mrs. A character in Dickens's *Dombey and Son*. She kept an establishment for young children at Brighton, where Paul was sent.

PIPE. An implement for smoking tobacco, opium, etc. See TOBACCO-PIPE.

PIPE (AS. *pipe*, from ML. *pipa*, pipe, from Lat. *pipire*, *pipiare*, to pipe, onomatopoeic in origin). An artificial closed channel, or conduit, for liquids, air, or gases, often under high pressures. Pipes are composed of a great variety of materials, according to the uses to which they are to be put and the cheapness of the various materials in a given locality.

LEAD PIPES are known to have been used at Babylon, Rome, and Pompeii, and, like all lead pipe until recent times, were made from sheets of lead bent to a pear-shaped section, with the horizontal joint welded or soldered. About the beginning of the sixteenth century the casting of lead pipes was begun in England, the process having been invented by Robert Brooke. In 1790 an English patent for drawing lead pipe was granted, and a machine was built for pressing lead pipe through dies. As the larger sizes of lead pipe have to be very thick to retain their shape and withstand high pressures, and on account of the high cost of lead pipe and for other reasons, such pipe is but little used now in diameters of over 2 inches or so, but it is made up to 4 inches, and, though rarely, to 6 or 8 inches. At the other extreme, it is made as small as $\frac{1}{8}$ inch, inside diameter. Modern lead pipe is pressed through dies in a continuous length. The molten lead is poured into a cylindrical hole in a hydraulic press. In the centre of the hole is a metal rod or core the same diameter as the pipe. When the metal begins to solidify the press rises and forces the

soft, hot lead through a die, the diameter of which corresponds with the interior diameter of the pipe. The total pressure used is about 400 tons, distributed over a 14- or 16-inch cylinder.

Block-tin pipes are made in the same way as lead, except that they are cold-pressed. Most of the block-tin pipe is used in soda fountains, or to convey beer, or in chemical works.

CAST-IRON PIPES. The general process of casting iron is described under **FOUNDING**. It may be said here that in some of the foundries the core is made by winding a spindle with a machine-made hay rope. Over the rope two or three layers of clay are packed, successively, after which the clay is shaped in a lathe, then dried in an oven. This core shapes the interior of the pipe. For the exterior a pattern is placed in a compartment known as a flask. Around the pattern tempered clay and sand are rammed to form a mold for the exterior of the pipe. The flask is then placed in an oven to dry the sand and clay, after which it is placed in a

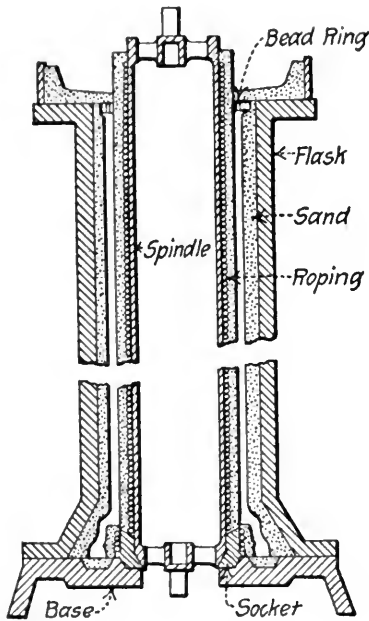

MOLD FOR CASTING IRON PIPE.

vertical position, the core centred within it, and the space between the core and the mold filled with molten iron. After the core is drawn and the pipe removed the latter is coated to prevent corrosion. The standard length of cast-iron pipe is 12 feet, and its diameter ranges from about 2 to 60 inches, with occasional larger sizes. The great thickness of shell, which of course increases with the diameter, makes very large pipe too heavy for use where ready means for handling it are not available. This is partly obviated by casting in shorter lengths.

CLAY, EARTHENWARE, OR TERRA-COTTA PIPE. Near the close of the eighteenth century the manufacture of drain tile began to assume importance in England. Other forms of clay pipe followed soon after, and then came the vitrified clay or glazed stoneware pipe now commonly

known as sewer pipe. A machine for the manufacture of clay pipe was built at Ottweiler, Rhenish Prussia, about 1858.

DRAIN TILES are commonly mere cylinders of baked clay, designedly porous, and without provision for making joints. Sometimes, however, a short length of semi-cylindrical baked clay is

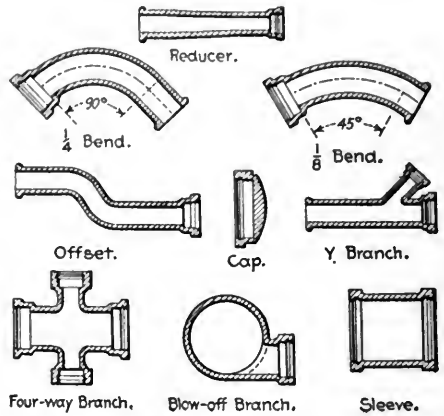

SOME OF THE MOST COMMON SPECIAL CASTINGS FOR USE WITH CAST-IRON PIPE.

laid over the abutting ends of the tiles. The standard vitrified clay or sewer pipe has sockets at one end for jointing, made of a little larger diameter than the pipe proper. Clay pipe is made by pressing or otherwise forcing the prepared clay (see **CLAY**) through a die, in the case of drain tile, and then cutting it into short lengths; or it is pressed in a mold, consisting of an outer shell, to form the exterior, and a core for the interior, besides which there is a special mold for the socket. After the socket is formed its mold is removed and the straight portion of the pipe pushed through.

To obtain a glaze, salt is placed in the fire holes of the kiln while the pipe is being baked. Upon being volatilized the salt combines with the silica in the clay. Drain tiles are quoted by manufacturers in diameters of 1½ to 12 inches, and are made in lengths of 12 to 15 inches. Vitrified pipes run from 2 to 36 inches in diameter, and are generally 2, 2½, or 3 feet long. There is a tendency to longer pipes, for the sake of reducing the number of joints. The lengths have to be restricted to 3 feet, to keep the pipes straight.

WOOD PIPES. Bored logs were used at Boston, in the first public water-supply system in the United States, in 1652, and at Bethlehem, Pa., in the pumping system of water-works built from 1754 to 1761. Most, if not all, these primitive wood pipes were simply logs with holes bored in their centres, and one end of each log tapered off to fit into the bore hole of the next log. Similar pipes are still used, but principally in the rural districts. Improvements have resulted in a style of pipe with a smooth circular interior and exterior, an asphalt-coated iron or steel band wound tightly around the pipe to give it strength, and a coating of asphalt over both the bands and wood for preserving the exterior from alternate drying and wetting. The joints are made by boring out one end of each

pipe to a larger diameter than the other, and turning down the other end to a like exterior diameter, then inserting the small end of one pipe in the large end of the next; or both ends of the pipe may be bored, as described, and the space thus formed may be filled by inserting a short length of pipe just thick enough so its inner side will be flush with the inside of the main pipe.

To avoid the limitations in size incident to bored logs, and to secure still greater facility in transportation and construction, particularly in rough country, pipes built up in place from wood staves are now used. In its present form wood stave pipe is composed of staves cut internally and on the edges (or radially) to form a conduit of the desired diameter. By breaking joints a continuous pipe is secured. The staves are held together and strength to resist any desired moderate pressure is secured by the use of steel bands or rods, provided with serew ends and nuts for tightening.

Since about 1895 smaller sizes of stave pipe, for which the construction just described is not suitable, have been made by winding them spirally with steel rods under tension by means of a machine; a little later small, wire-wound stave pipe was put on the market.

WOOD-FIBRE PIPES, in sizes from 1½ to 8 inches, in lengths of 5 feet, with screw coupling joints, are made and used for conveying gas, acids, and water, under a pressure of not more than 50 pounds. They are made from wood pulp. (See PAPER.) A thin sheet of pulp is wound around a core until the requisite thickness is obtained. The pipe thus formed is dried, impregnated with a wood preservative, and then has its ends turned in a lathe to form joints.

WROUGHT-IRON PIPES. The earliest wrought-iron pipes appear to have been made from an over-stock of gun barrels, early in the nineteenth century. The small end of one tube was serewed into the large end of the other. The pipes thus made were used to convey illuminating gas. The longitudinal joints were lap-welded. The increasing demand for wrought-iron gas pipe led to the adoption of butt-welded pipes of uniform size and thickness, united by sockets or couplings into which the ends of the pipe were serewed. Like the gun barrels, these pipes were welded by hand, a few inches at a time. In 1825 Cornelius Whitehouse invented a process of butt-welding which was, in its essentials, continued in use through the remainder of the century. He first rounded up the iron plate, or skelp, then heated half the length of the pipe and drew it through two dies by means of a chain. The dies pressed the heated metal together. This patent was bought by James and John Russell, pipe manufacturers, one of whom had just patented a process of butt-welding by pressing the edges together, but in which only a few inches could be welded at a time.

With the development of steam engineering larger and stronger pipes were demanded. The Russells bent their energies to meeting this demand by improving on the old lap-welding process already described. This appears to have been about 1835, but whatever the date, their process for lap-welding, like theirs for butt-welding, involved the main principles still followed. In the recent process of lap-welding pipe

and tubes the strips or plates of metal are heated, have their edges beveled or scarfed by passing through rolls, and then drawn through a die and formed with edges overlapping, ready to be welded. The partly made pipe, or skelp, is now heated a second time and welded by passing it through two rolls, the inner lap resting on a stationary mandrel, which corresponds to a blacksmith's anvil. Finally, the pipe thus made is straightened, threaded, serewed into a coupling, and tested by means of water pressure. Butt-welded pipes are now made by drawing a heated plate, by means of tongs, through a conical-shaped die, thus pressing the edges so firmly together that they unite. The further steps in the process are the same as for lap-welded pipe. Butt-welded wrought-iron pipe is made in small sizes, from ½ to about 1 inch in diameter, and is tested at an internal pressure of 300 pounds per square inch. Lap-welded pipe is made in sizes from 1¼ or 1½ to 30 inches in diameter, and is often subjected to very high pressures.

Pipes are also drawn from hollow or cylindrical ingots formed by passing a heated round billet through diagonal rolls and over a mandrel. By reheating and rolling under pressure the ingot is finally brought down to the desired diameter and thickness. It is then annealed, pickled, and cold-drawn, to give it the desired finish. In the Mannesman process, invented in Europe, and patented in America in 1887, pipe is rolled from a solid, but heated, bar or rod by means of two tapering rolls and a mandrel.

STEEL PIPES are made in the same general way as has been described for wrought iron. In addition, they are sometimes cast and are frequently riveted for large sizes, as described below.

In 1901 patents were granted for the *Bartlett-Kent process* of rolling large sizes of seamless steel pipe from hollow cast ingots or cylinders. The range of sizes proposed by the manufacturers is 12 to 30 inches in diameter, with shells from ½ to 1¼ inches thick. The essential parts of the machine are two sets of internal and two sets of external rolls, all placed at right angles to the axis of the pipe being rolled and all having curved surfaces corresponding to the inner and outer circumferences, respectively, of the ingot which is being rolled. There are three rolls in each set, making altogether contact with about one-half the respective surfaces of the ingot. The second set of rolls in each case is so placed as to come in contact with those portions of the ingot which are not touched by the first set. In addition, the ingots can be rotated through a part of their circumference. The machine is fully described in the *Iron Age* (New York) for April, 1901.

RIVETED WROUGHT IRON AND STEEL PIPES have their longitudinal and frequently their circular joints riveted, instead of welded. Wrought-iron sheets, rounded and riveted, have long been used for stovepipes, and in 1853 a California miner laid a 5 or 6 inch length of ordinary stovepipe for hydraulic mining. In a few years this sort of pipe, only heavier and better made, was in general use.

Both *spirally riveted* and *spirally welded steel pipe* have been used, and the former is still on the market. In each case plates of steel are

wound spirally to form a tube, spiral joints being heated and welded by a machine hammer in one case, and lapped and riveted in the other. The sections of pipe thus made are joined in the trench. Steel pipes with longitudinal locking bar joints have been used extensively in Australia, the chief instance, as well as one of the most remarkable pipe lines in the world, being the Coolgardie pipe line, which is 328 miles long and 30 inches in diameter. Water is pumped

pressure to both the plates and bars. The circular joints are made with sleeves. The contract for the line was let in 1898.

CEMENT PIPES AND CONCRETE PIPES are molded from the materials named. (See **CEMENT** and **CONCRETE**.) The cement pipe is made and shipped in sections. Concrete pipe is molded in place either by shifting along a movable mold and core, or by means of molds or forms consisting of an inner and an outer shell, between which the concrete is packed. During the last part of the nineteenth century steel rods and steel nettings were built into concrete pipe to give it greater strength.

PIPE JOINTS may be grouped as calked, screwed, flanged and bolted, and riveted. The calked joints are used almost wholly for vitrified clay pipe, other than drain tile, and are very largely used for cast-iron pipe. They are sometimes used for steel. Pipes with calked joints generally terminate in an enlarged, curved bell or socket at one end, and are either the same size and shape as the main pipe at the other end, or have a projecting ring. This smaller end is known as the spigot or bell. After one piece of pipe has been inserted in another, the space between the hub and the socket is packed with lead or with cement, the lead generally being used for cast-iron pipe. In place of a hub and socket, plain-ended pipe may be inserted in sleeves, or pipe of slightly larger diameter, and calked as described. Screwed joints are effected by threading the outer ends of the pipes and screwing them into or onto some form of coupling, also provided with screw threads. Flanged and bolted joints have a projecting ring at each end, with holes drilled through it, parallel to the axis of the pipe. Bolts are inserted in these holes. By using washers or packings of leather, rubber, or soft metal between the flanges, and by turning up the nuts on the bolts until they are tight, very tight joints can be made in this way. Riveted joints have been mentioned in the paragraph on riveted wrought iron and steel pipes. These joints, longitudinal as well as circumferential, may be made by lapping one edge over the other and riveting the two together; or the two metal edges may be butted against each other, a strap or band placed over the seam, and rivets inserted and headed each side of the seam. The requisite strength of joints is secured by decreasing the space between the rivets and by putting in two or three rows of the same.

BIBLIOGRAPHY. The literature of the subject is scattered through the engineering papers, proceedings of engineering societies, and books on the applied arts employing pipe. A paper by Jesse Garrett on "Making Cast-Iron Pipe" (*Journal of New England Water-Works Association*, Boston, September, 1896) contains some interesting historical matter relating to various kinds of pipes used to convey water, besides describing briefly the manufacture of cast-iron pipe. The journal named contains much other material on the manufacture and uses of the various kinds of pipes. See also: Crane, "Early History of Gas Pipes" (*Engineering Record*, New York, July 8, 1893), for the wrought-iron pipe; various committee reports on *Coating Cast Iron and Steel Pipes* (Proceedings of American Society of Municipal Improvements, Allegheny,

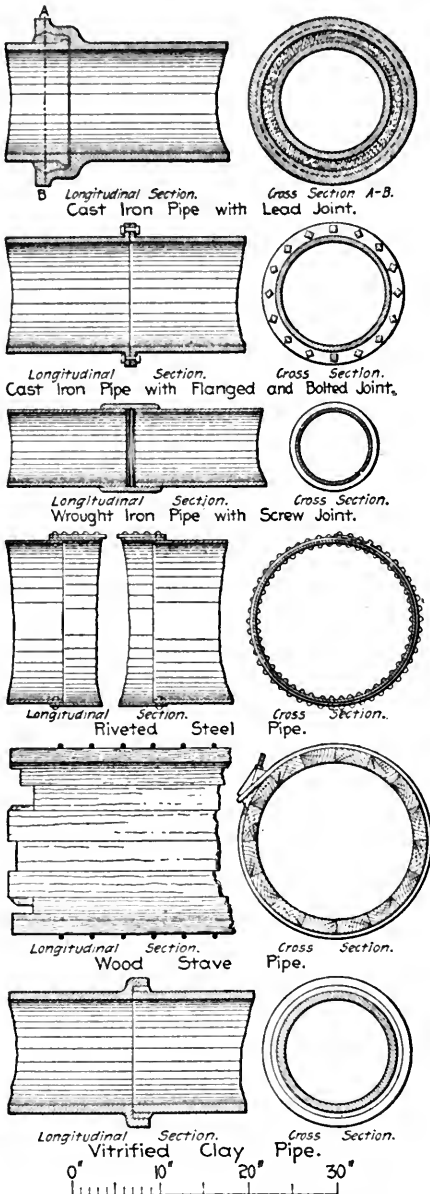

JOINTS FOR PIPE OF VARIOUS MATERIALS.

through it to supply gold fields in the interior, 1313 feet above the source of supply. The pipe is made by bending two plates to semicircular shape, and inserting their edges in steel bars with a groove on each side, then applying heavy

Pa., 1897 to 1900). For a few of the many uses of pipes, see HEATING AND VENTILATION; IRRIGATION; SEWERAGE; WATER SUPPLY; and WATER-WORKS.

PIPE-CLAY. A term applied to almost any fine clay (q.v.) comparatively free from iron and other impurities, having a grayish-white color, a greasy feel, and high plasticity. Some pipe-clays are used for the manufacture of tobacco-pipes and white pottery; others are employed for making sewer-pipe. Pipe-clays are common in the United States, and occur in many geological formations, notably the Cretaceous, Tertiary, and Carboniferous. See CLAY.

PIPEFISH. A name given principally to species of the family Syngnathidae, but also applied to various other species which, like the above, have a long, tubular snout. The body is long, slender, and covered with bony plates firmly connected, so as to form a sort of carapace. The tail is often long and slender, and sometimes is used as a prehensile organ. The fins are minute, the pectorals sometimes and the ventrals always wanting. Their food consists of small marine animals and the eggs of fishes; and they may be seen slowly moving about, with curious contortions, poking the long snout into

abundant along shore among the eel-grass, and when standing on their heads in the midst of it perfectly simulate one of the gently moving blades, and are thereby protected from observation. Like the sea-horse (q.v.), to which pipe-fishes are nearly related, the males have brood-pouches on the ventral side of the body, usually situated on the under side of the tail, but sometimes farther anterior, formed by two folds of the skin meeting and coalescing in the median line. The young are carried in this pouch until some time after they have escaped from the egg, going out and returning when alarmed, but at last are turned loose by the pouch bursting. There are about 15 genera and 150 species, small and sluggish, inhabiting the warmer seas, sometimes entering fresh waters. The common pipe-fish of the Atlantic coast is *Siphostoma fuscum*. Consult: Gunther, *Introduction to the study of Fishes* (London, 1880); Goode, *American Fishes* (New York, 1888).

PIPE LINES, OIL AND GAS. Wrought iron pipes jointed to form conduits of great length, used to transport petroleum oil or natural gas from the wells or fields to the point of utilization, or, in the case of oil, to the refinery or market. In the trunk lines the oil is pumped, often surmounting great elevations and requiring heavy pressures. Gas is often pumped, the frequency and intensity of pumping pressure increasing to a marked extent with the diminution of the pressure from the wells.

OIL PIPE LINES originated in the Pennsylvania fields. They were first suggested by Gen. S. D. Karns, in November, 1860. His idea was to lay a line from Burning Springs to Parkersburg, and let the oil gravitate to the Ohio River, where it could be loaded and shipped. The distance was about 36 miles. The line was never laid. In 1862 J. L. Hutchinson, of New York, laid a siphon over a hill from the Tarr Farm to a refinery at Plumer, Pa. In 1863 he laid a second line, three miles in length, through which he pumped oil from the Sherman well to a refinery. He placed 10-inch air chambers 50 to 100 feet apart. The joint leakage was so great that both these lines were abandoned.

The first successful line was laid in 1865 by Samuel von Syelle, of Titusville, Pa. Other lines followed and numerous companies were organized and consolidations effected. The new mode of transportation met with violent and riotous opposition from teamsters and others interested in hauling oil in wagons. In 1875 a 4-inch line, about 60 miles long, was laid from the lower oil country to Pittsburg. Up to this time most of the refineries had been located near the wells, but it being found more advantageous to locate the refineries on the seaboard and the Great Lakes, pipe lines were rapidly laid to the chief cities so situated in the northeastern part of the United States. The second pipe line of great length was laid from Bear Creek to Cleveland, Ohio. It was 111 miles long, 6 inches in diameter at the outset, and 5 inches in diameter after passing the final pumping station. By 1892 the National Transit Company, alone, had secured control of or built the following great trunk lines: Bear Creek to Pittsburg, 55 miles; Olean to Buffalo, 56 miles; Bear Creek to Cleveland, 111 miles; Colegrove to Philadelphia, 235 miles; Millway to Baltimore, 66 miles; Olean to New York, over 300 miles. Later, it added a

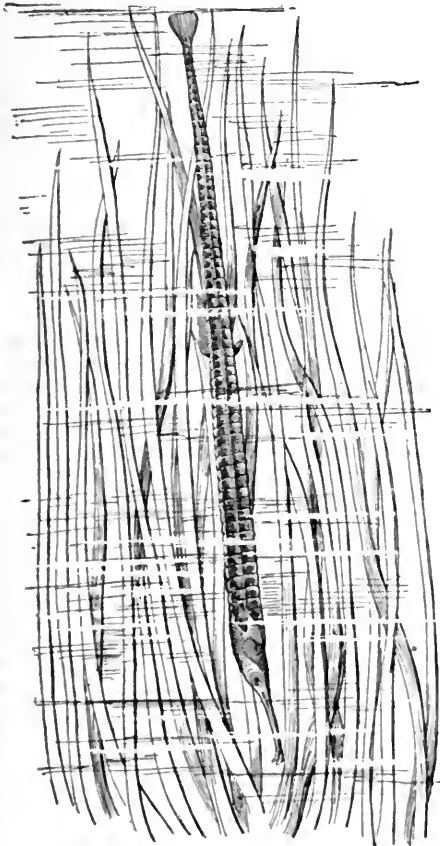

A PIPEFISH STANDING UPRIGHT IN EEL-GRASS.

every crevice in search of food, and sometimes assuming a vertical position with the head downward, poking into or stirring the sand. They

line from Lima, Ohio, to Chicago, eight inches in diameter and some 205 miles long, which has since been duplicated. Besides the National Transit Company there were a dozen or so other companies in 1892. In 1901 two companies controlled practically all the pipe line in the United States, but most of the mileage belonged to the National Transit Company. The extent of main, branch, and field pipes controlled by the National Transit Company (Standard Oil) has been placed by a representative of the company at as high as 35,000 miles.

At river crossings the pipe is either carried on bridges or laid on and anchored to the bed of the stream. At the Hudson River crossing a trunk line laid prior to 1893 is anchored to two sets of heavy chains, parallel to and some 25 feet from the pipe, held down by heavy weights. This line is inclosed in a second pipe. Across the salt marshes near New York the line is incased in concrete, to prevent corrosion.

The first oil pipe line was laid in Russia in 1879 to reach a refinery at the so-called Black Town of Baku. It was eight or nine miles long. In or about 1895 there were 22 pipe lines in Russia, some of which were eight inches in diameter. In July, 1900, a pipe line 143 miles long, from Mikhoilovo to Bohem, was put in use. It is for refined oil only, from the Baku deposits, supplementing the railway over a section where transportation is difficult.

PUMPS are required on the pipe lines, since these climb hills and mountains many hundred feet high. The pumps are of the high pressure, compound, condensing type, the later ones being high duty. (See PUMPS AND PUMPING MACHINERY.) The head under which the pumps work may vary, of course, with the topography of the country through which the line is passing, but it is largely dependent on the friction alone in long lines of small pipe.

NATURAL GAS PIPE LINES are often similar to the wrought iron lines described above, but they are also composed of riveted steel plates, and even of cast iron. Another variation from the oil pipe lines is the size of the gas mains, 16 to 24 inches or more in diameter, instead of 4 to 8 inches. It is said that the Chinese used bamboo pipes for natural gas and that a wooden main 20 miles long was laid from a well at West Brookfield, N. Y., to Rochester as early as 1865, or thereabouts. The general utilization of natural gas in the United States, and also the construction of gas pipe lines, followed the development of the petroleum oil industry. In 1872 gas was piped to Titusville, Pa., through a 2-inch and a 3¼-inch iron pipe line, 5½ miles long. In 1876 a 6-inch main, 17 miles long, was laid to Sharpsburg, Pa., from the Harvey well, in Butler County. The feeders to the pipe lines are 2 to 2½ inches in diameter. The main lines are 40 to 50 miles in length. The pressures in various fields originally ran from 300 to 1000 pounds per square inch, but of late they have fallen off, year by year, until in many cases they are only a small fraction of the initial. This has necessitated *pumping the gas*. The first pumps were installed by the People's Company, of Pittsburg, Pa., in 1890. Now nearly every company supplying gas to the larger cities is compelled to pump in winter. The pumping is generally effected by some standard form of air compressor, driven by compound or triple expansion steam

engines. The gas itself is generally used as fuel, but sometimes coal is used in order to husband the diminishing gas supply. About 1900 some large gas engines, one of 1000 horse-power, were installed to operate the gas compressors.

Where natural gas reaches a city under high pressure automatic pressure reducers are employed to reduce the gas to a uniform pressure of 10 to 50 pounds before it enters the city distributing mains. On each consumer's service pipe another reducing and regulating valve maintains a pressure of about one-half pound.

BIBLIOGRAPHY. Consult: Redwood (and others), *Petroleum* (London, 1896); Groves and Thorp, *Chemical Technology*, vol. ii., "Lighting" (New York, 1895); *The Mineral Industry*, vol. ii. (New York, 1893). For more detailed descriptions of particular oil fields and lines, see *Proceedings of the British Association for the Advancement of Science* (1885); and *Engineering News* (June 13, 1885). For gas pipe lines a slight amount of additional information may be obtained from *Cassier's Magazine* (February, 1898). See GAS, NATURAL; PIPE; PETROLEUM.

PIPER. A fish of the North Atlantic coast, one of the gurnards (*Trigla lyra*), which reaches three or four pounds in weight and is delicate food.

PIPERACEÆ (Neo-Lat. nom. pl., from Lat. *piper*, pepper), THE PEPPER FAMILY. A natural order of about 1000 species of dictyodendrous shrubs (a few almost trees) and herbs (some climbing), natives almost exclusively of the hottest parts of the globe, particularly of Asia and America. None of them are found in cold regions. Most of the species are called pepper, but some are also known by other names, particularly those of which the fruit is not used as a spice, but of which some part is otherwise employed as betel, cubebs, matiao, and ava. Pepper (q.v.) is the most important product of the order. The chief genera are Piper and Peperomia.

PIPERAZINE, known also as DIETHYLENE-DIAMINE, ETHYLENIMINE, PIPERAZIDINE, and DI-SPERMINE. A compound formed by the action of ammonia upon ethylene bromide or chloride. Its formula is $C_4H_{10}N_2$. It is also produced by the interaction of ethylene bromide and aniline upon the addition of a solution of potassium hydroxide, forming di-phenyl-piperazine. By treatment of this with sulphuric or nitric acid and distillation with alkalis piperazine is produced. It appears as white, odorless, tasteless, deliquescent crystals which are freely soluble in water. Its use in gout and the uric acid diathesis depends upon its property of uniting with uric acid to form a very soluble compound which is excreted in the urine instead of forming calculi in the kidney. Its use in connection with these seems to be prophylactic, as its claims to a solvent effect upon concretions already formed have been exaggerated.

PIPERIN (from Lat. *piper*, pepper), $C_{17}H_{19}NO_3$. A weak basic substance found in pepper. It may be obtained by heating powdered pepper with alcohol, in the form of colorless well-formed prisms, which are insoluble in cold water, but dissolve readily in alcohol and ether. On heating piperin with caustic potash solution, it breaks up into piperic acid, $C_{12}H_{10}O_4$, and a remarkable oily

base called *piperidin* ($C_5H_{11}N$). Piperin is used for making heliotropin and sometimes as a substitute for pepper.

PIPE ROLLS. A name applied to the great or annual rolls of the English Exchequer, written for the treasurer. They are so called because of their resemblance to a pipe, or on account of the favorite comparison of the public treasury to a reservoir, into which every branch of revenue flowed through these pipes. They were written by the treasurer's scribe, and controlled by the Chancellor's scribe. They contained a statement of the King's revenue, drawn up by the sheriff of one or more shires, and an account of the expenditures made by the sheriff in his office. The chief item of the revenue was the 'ferm' of the shire, which consisted of the King's income from the royal demesne, the yearly fines paid by the boroughs for their corporate privileges, and the fines decreed in the county courts. Other items were the Danegeld, a tax levied to resist the Northmen, the profits of the pleas of the Crown, the King's feudal income from reliefs, escheats, aids, and the proceeds of the tallage of the royal demesne.

The oldest extant pipe roll is that of 31 Henry I. (1131). These rolls extend from the second year of Henry II. (1156) till 1833, when the ancient system of the Exchequer was abolished, with but two breaks of a single year, and are among the most valuable of records, preserved in the Public Record Office. In 1883 the Pipe Roll Society was founded, with the intention of publishing all the pipe rolls. Its publications (17 vols., London, 1884-97) include the 5-24 Henry II., forming a combination with the publications of the Record Commission. The latter had in 1833 published the pipe roll of 31 Henry I. and the Chancellor's roll of 3 John; and in 1844 the pipe rolls 2, 3, 4 Henry II. and 1 Richard I. Consult Hall, *Introduction to the Study of the Pipe Rolls* (London, 1884).

PIPE VINE. See ARISTOLOCHIA.

PIPI, *pé'pé* (Brazilian name). The ripe pods of *Cesalpinia Paipae*, used in tanning, and not infrequently exported with *divi-divi* (q.v.), though being inferior to *divi-divi*, they are little exported separately. They are easily distinguished from the pods of *divi-divi* because they are straight instead of curved. The plants grow in the American tropics. See *CESALPINIA*.

PIPING CROW, or CROW-SHRIKE. One of the Australian shrikes of the genus *Gymnorhina*—large, black and white, insect-eating, showy birds, with loud, piping voices, alluded to in such local names as 'organ-bird' (*Gymnorhina hyperleuca*) of Tasmania, and 'flute-bird.' The latter (*Gymnorhina tibicen*) is very common throughout Australia and frequents the gardens and lawns, hunting for grasshoppers, of which it eats enormous quantities. Its intelligence, lively manners, and considerable vocal powers make it a favorite cage bird. Dealers call these birds 'Australian magpies.' Compare *ORGAN-BIRD*.

PIPIT, or PIPIT-LARK. See TITLARK.

PIPPA PASSES. A dramatic poem by Robert Browning (1841). Pippa, a girl from the silk-mills at Asolo, on a holiday passes several groups of people at a critical moment in the lives of all, and by snatches of her song, which they

overhear, changes the fate of each, and in one case her own.

PIPPI, *pip'pé*, GIULIO, commonly called GIULIO ROMANO (1492-1546). An Italian architect and painter, the chief follower of Raphael. He was born at Rome, and of his early life little is known, except that at an early date he entered the school of Raphael. Vasari says that Raphael loved him as a son, and we know that he left all his property to Giulio and Penni, another pupil. He was certainly the master's most important pupil, on whom he chiefly relied for the execution of his designs, and Giulio assisted in the *Stanza del Incendio*, the *Loggie* of the Vatican, and in the Villa Farnesina. (See RAFAEL.) He was also employed to paint easel pictures in Raphael's studio, especially such as were intended for foreign patrons, like the large Madonna in the Louvre and the so-called "Pearl" at Madrid. After Raphael's death he assisted in the *Sala di Costantino* in the Vatican, himself painting the chief composition, the battle picture; finished, together with Penni, the "Coronation of the Virgin," in the Vatican Gallery; and himself painted, in an admirable manner, the lower part of Raphael's "Transfiguration."

After Raphael's death Giulio was the acknowledged head of the school, and was as important in architecture as in painting. Unfortunately, his architectural works at Rome have been either spoiled by restoration or left incomplete; but we know that he designed and decorated for Cardinal Medici Villa Madama and Villa Lante, of which frescoes a few fragments are preserved in the Villa Borghese. The best of his easel pictures are, perhaps, the "Madonna with the Cat," in the Naples Museum; "Apollo and the Muses," Pitti Palace (Florence); and his masterpiece of this early period, "The Stoning of Saint Stephen," the altar piece of Santo Stefano, Genoa. Other examples, both religious and mythological, are in Rome, the Uffizi (Florence), the galleries of Vienna, Dresden, the National Gallery (London), and especially in the Louvre, which is rich in his works. Compared with Raphael, his independent works show an utter absence of religious feeling and a lack of grace. The forms are often coarse, though the drawing is good, and the color is marred by the use of deep black shadows and a dull brick red. His work, on the whole, shows a greater influence of Michelangelo than of Raphael.

In 1524 Giulio went to Mantua at the call of Duke Federigo Gonzaga, who placed him at the head of all his artistic undertakings, and raised him to the nobility. Here he developed a remarkable architectural activity, rebuilding whole quarters of the city. He built the ducal palace (1535-40), which was decorated after his designs, prominent among which were a series of frescoes of the Trojan War. Among his other architectural works were the great Church of San Benedetto, ten miles south of Mantua: the interior of the Cathedral of Mantua; his own tasteful house (1544) built around a simple court, and ornamented with a fine rustica facade; and the greatest of all his achievements, the Palazzo del Tè, just outside the city walls. Though enlarged from a stable for the Duke's stud, this palace is the best preserved example of a princely villa of the golden age of Italian art. It is a one-story rustica building, in the Doric style,

The entire interior is decorated with stucco and frescoes, after Giulio's designs, by his pupils. The great hall has realistic portraits of the Duke's favorite horses, which are epoch-making in animal painting. Most beautiful of all the decorations are those of the second hall, representing the "Story of Psyche." Two of the original drawings for this cycle, preserved in the Villa Albani, are, perhaps, his most charming work. Of the remaining rooms the most famous is that in which the "Fall of the Giants" through Jupiter's thunderbolts is represented in a very realistic manner. The scenes are not divided by frames or paneling, and the spectator stands in the midst of the catastrophe, which is so realistically represented as to create the impression that the walls are falling in with the giants.

The chief characteristics of Giulio's Mantuan work are profound antiquarian knowledge and a pronounced tendency toward realism. The action is exaggerated and mannered, and in such frescoes as the "Fall of the Giants," which greatly influenced contemporary painters, it is already Barocco. Of his later religious works the most remarkable are the designs for frescoes in Sant' Andrea, Mantua, and for Torbido's paintings in the Cathedral of Verona. Of his later easel paintings the "Adoration of the Kings," in the Louvre, and the "Madonna della Catina" (Dresden), in which the Christ child is naively represented as being bathed, were executed by his own hand. Pippi was also at the head of all the Duke's engineering undertakings, and in draining the marshes about Mantua he contracted a fever, from which he died at Mantua, November 1, 1546, just as he was about to return to Rome, after having been appointed architect-in-chief of St. Peter's. Consult D'Arco, *Istoria della vita et delle opere di Giulio Pippi* (Mantua, 1892).

PIPPIN. See PEPIN.

PIPPRA, pí'prá (Neo-Lat., from Gk. *πίπρα*, variant reading for *πίπρῶ*, *píprō*, woodpecker; otherwise explained as of possible South American origin). One of a group of non-oscine, passerine birds composing the family Pipridæ, many of which are also known as ant-birds and as manakins (q.v.). They are chiefly South American, but a few species extend north into Central America and Mexico. They are small birds, resemble titmice in their habits, and seek their food in low bushes and near the ground. The males are gorgeously colored, with glossy black, scarlet, yellow, and sky-blue; the females are dull greenish or some other inconspicuous color. They are thick-set birds, usually with short, square tails, and short, broad bills, the upper mandible hooked and notched at the tip. The true manakins (*Manacus*) have the chin feathers elongated like a beard. Pipras are most nearly related to the cotingas, rock cocks, and American flycatchers (qq.v.). See Plate of COTINGAS.

PIPSIS/SEWA. A small evergreen plant. See WINTERGREEN.

PIQUA, pik'wá. A city in Miami County, Ohio, 73 miles west-northwest of Columbus; on the Miami River and the Miami and Erie Canal, and at the junction of the Cincinnati, Hamilton and Dayton and the Pittsburg, Cincinnati, Chicago and St. Louis railroads (Map: Ohio, B 5). It has the Schmidlapp Free School Library. Piqua is an important industrial centre, noted

particularly for its manufactures of linseed oil. There are also large sheet steel mills, iron works, stove and range works, strawboard mills, a furniture factory, woolen mills, etc. Good water power for manufacturing is afforded by the river. Piqua is governed by a mayor, elected every two years, and a unicameral council. The water works are owned and operated by the municipality. Population in 1890, 9,090; in 1900, 12,172.

PIQUET, pé'ká' (Fr., piquet, peg). A game of cards, of great antiquity and considerable scientific possibilities. Its laws, as published in Hoyle's *Short Treatise on the Game of Piquet* in 1744, remained in force until the adoption of the rules of the Portland Club in 1873. It is played by two persons with a *cuchre* pack. Ace is highest and counts eleven, the other cards ranking as in whist. After cutting, the dealer gives the two top cards to his adversary, then two to himself, and so on until each has twelve cards. If the hand of either player contains no face card, it is called *carte blanche* (white card), and he scores 10 at once. The "elder hand" (the non-dealer) must discard one of his cards and take another from stock, but he may discard as many as five and take a like quantity. The younger hand must discard one also and may discard three. The players then announce the combinations of their cards, and each replies according to whether he has, or has not, an equal or greater number. "Good," "equal," or "not good," and scores "the point" according to the number of points the rules apportion to his combination. The play then proceeds, the leader of a counting card (ace, king, queen, knave, or ten) counting one for each card led, whether he wins the trick or not, and the winner of each trick leading for the next, as in most card games. The younger hand must, if possible, follow suit. If the leader wins the trick, the opponent counts nothing, but if he wins the trick he counts one. The winner of the last trick counts two. If one player wins more than half the tricks he adds ten to his count. If he wins all he adds forty. The variations of scoring and play for *carte blanche*, or a hand of only plain cards, *Point*, the strongest suit, *sequenc*, *quatorze*, *trio*, *pique* and *repique*, are too intricate to be described except by the laws of the game, for which consult Cady, *Piquet* (New York, 1896); "Cavendish," *The Laws of Piquet, with a Treatise on the Game* (London, 1882); "Aquarius," *Piquet and Cribbage* (London, 1883).

PIRACICABA, pé'rá-sê-ká'bá. A town of the State of São Paulo, Brazil, on the left bank of the Piracicaba River, 273 miles west of Rio de Janeiro, and on the São Paulo-Piracicaba Railway (Map: Brazil, H 8). The town carries on a brisk trade in coffee and sugar and utilizes the water power of the river for milling purposes. Its population in 1894 was about 5000.

PIRACY (ML. *piratia*, from Lat. *piratica*, piracy, fem. sg. of *piraticus*, from Gk. *πειρατικός*, *peiratikos*, relating to a pirate, from Gk. *πειρατής*, *peiratēs*, pirate, one who attacks or tries, from *πειράν*, *peiran*, to attempt, attack, from *πέρα*, *peira*, attempt, attack; connected with *πῶρος*, *poros*, passage, Skt. *par*, to cross, and ultimately with Eng. *fare*). Robbery on the high seas directed against the whole body of civilized States, rather than against any particular State. The

rules of international law provide that the penalty upon conviction may be death. But *piracy jure gentium*, or piracy as defined by international law, and piracy as described by the municipal law of a particular State, must be distinguished.

Three requirements are necessary to constitute an act of *piracy jure gentium*: First, it must be an act of adequate violence. It need not be necessarily an act of depredation. While the pirate is generally merely a robber, acts done by unauthorized persons for political ends have been deemed piratical, though the *animus furandi*, the intent, was wanting and there was no purpose of indiscriminate aggression upon the vessels of all nations. Thus a single act of violence is sufficient, as the successful revolt of a ship's crew against its officers. If they gain control of the ship, they are pirates; if their attempt fails and lawful authority is never superseded, the act is one of mutiny only, not piracy. Second, it must be an act done outside the territorial jurisdiction of a civilized State. Some authorities have held that an invasion from the sea upon the coast of a civilized State to ravage and destroy without national authorization is piracy. But being done within the territorial jurisdiction of the State, it is subject to the municipal law thereof and is outside the jurisdiction of the international code. Yet an act of similar character against an unappropriated island and the robbing of civilized persons there engaged in trade, or missionary work, would be piracy. Third, the perpetrators of the act must be without the authority of any recognized political community. Acts which when done under national authorization are lawful acts of war are, hence, piracy when not so authorized, and the possession of two or more incompatible commissions is deemed to have the same effect as the absence of any. So if in time of war a privateer procures letters from each belligerent and preys upon the commerce of both, she is a pirate; but if a cruiser having a lawful commission exceeds her authority in making captures, she is not a pirate, for the State authorizing her originally is held responsible for her acts. For purposes of authorization recognition of independence is not required; but recognition of belligerency is sufficient to validate a commission authorizing acts of violence for belligerent cruisers; but if such a community ceases to exist as a political unit, the commission is no longer valid.

Attempts have been made to bring acts done by vessels under commissions from a revolted community, which has not obtained recognition of belligerency, under the protection of this rule. Several instances have occurred where a disposition has been shown to treat as pirates persons guilty of accepting letters of marque and reprisal from one of two belligerents when the other was at peace with the nation of which the privateer was a subject, but such an attitude is at variance with the general usage of nations.

Piracy is punishable by any State which captures the perpetrators, that is, a State has jurisdiction to try and punish all pirates seized by its vessels. One of the attributes of an independent State is the power to regulate its own criminal code, and it may declare certain offenses to be *piracy* not so regarded by international law. Such are acts of piracy as defined by municipal statute. These laws can have binding force only in the jurisdiction creating them; and, while sim-

ilar regulations may be adopted by other States, in the absence of special agreement between them the officers of one may not arrest or punish subjects of the other for offenses committed beyond its jurisdiction, even though such acts are defined as offenses by the laws of the State to which the offender belongs. Thus, while the slave trade is declared to be piracy only by virtue of municipal law, efforts have been made to bring it under international jurisdiction by agreement between the powers. This has not been effectually done, although after much international difficulty and dispute as to the right of search, etc., an international convention was finally reached in 1890 as a result of the conference of the civilized States, called at the instance of the King of Belgium, which provided for a complicated system of measures of repression.

See such titles as HIGH SEA; MARE CLAUSTRUM; MUTINY; SLAVERY, etc. Consult the authorities referred to under INTERNATIONAL LAW; CRIMINAL LAW, etc.

PIRÆUS (Lat., from Gk. Πειραιεύς, *Peiraiicus*, Πειραιεύς, *Peiræus*). The port of Athens, situated on a rocky peninsula about 5 miles southwest of the city (Map: Greece, B 6). The nearest point in the shore line to Athens is the long sandy beach of Phalerum, bounded on the east by Cape Colias and on the west by a rocky peninsula, with two principal summits, one, Munyehia, at the northeast, close to the bay of Phalerum, the other, Acte, at the southern end of the cape. In this promontory are three harbors. The smallest is on the east side of Munyehia; the next in size is southwest of Munyehia and northeast of Acte; the third and largest is on the west side of the peninsula, north of Acte, and is a large basin with two smaller bays at each side, almost landlocked between Acte and a tongue of land projecting from Eëtiona, on the Attic coast. This harbor is supplied with modern docks and a portion of it is used by the Greek navy. Over one-half of the foreign commerce of Greece passes through Piræus, which is also a considerable manufacturing centre, producing mainly textiles, brandy, leather, paper, and macaroni. The population in 1896 was 42,169, making Piræus the second largest city of Greece. The earliest port of Athens was Phalerum, and the advantages of the Piræus were first observed by Themistocles (b.c. 493-492), who began to fortify it. It was not till after the Persian Wars that the peninsula was surrounded with lofty and strong walls, the mouths of the harbors narrowed by moles so that they could be easily closed by chains, and the whole connected with the city by the Long Walls. The city was laid out by the famous architect Hippodamus of Miletus, probably in the time of Pericles, in a regular system of broad straight streets crossing one another at right angles and broken by frequent open squares. Wharves, warehouses, and porticoes were built along the harborside and a merchants' exchange was provided for the display of samples. The great harbor was the scene of mercantile activity, the smaller harbors being reserved for the Athenian navy, and the remains of the ship-houses in which the triremes were hauled up can still be traced. With the decline and ruin of Athens during the Middle Ages the Piræus naturally was abandoned, and the present city has been built since Athens became the capital of

Greece. According to the accepted nomenclature, the smallest harbor, now Fanari, is the ancient Munychia; the next, now Pashalimani, is Zea; the great harbor was known as Cantharus. Recently, however, strong reasons have been advanced for identifying Phalerum with Fanari, Munychia with Pashalimani, and Zea and Cantharus with the bays on either side of the great harbor. Consult: Wachsmuth, *Die Stadt Athen im Altertum* (Leipzig, 1874, 1890); Milchhöfer, "Peiraieus," in *Baumeister's Denkmäler des klassischen Altertums* (Munich, 1889); Gardner, *Ancient Athens* (London and New York, 1902); and a Greek pamphlet by Angelopoulos, *περὶ πειραιῶς, καὶ τῶν λιμένων αὐτοῦ, On Peiraus and Its Harbors* (Athens, 1898).

PIRANESI, pē-rā-nā'zē. GIAMBATTISTA (1720-78). An eminent Italian engraver, born in Venice, October 4, 1720. He studied under his uncle, Matteo Lucchese, and with Vasi in Rome. He worked as architect in Venice for a short time, and then settled in Rome, where he produced an enormous number of plates. Toward the end of his life he was assisted by his sons, Francesco and Pietro, and his daughter, Laura. As architect he directed some restorations and decorations in Santa Maria del Popolo, and the priory of Malta at Rome. He was a member of the Academy of Saint Luke (1761) and an honorary member of the Society of Antiquaries in London. He died in Rome on November 9, 1798. His best plates are engravings of architectural ruins. They are characterized by Rembrandt-like contrasts of light and shade. He did not hesitate to restore, with his needle, the missing parts of the ruins he was engraving, and he added statues, tombs, vases, or any detail he thought necessary to bring out the pictorial and poetical interest of his work. He left about 2000 plates in 29 folio volumes. They are nearly always of large size, and are executed both with the burin and etched line. His masterpiece is the series known as *Le antichità romane*, 1800 plates (Rome, 1750; Paris, 1836 et seq.). Notable plates in this collection are: "Temple of Neptune at Paestum," "Arch of Constantine," "Arch of Septimius Severus," "Arch of Vespasian," "Temple of Apollo," "Baths of Diocletian," "Temple of Janus," "The Coliseum," "Villa of Maecenas," and the "Temple of the Sibyl at Tivoli."

PIRANO, pē-rā'nō. A seaport of the Crownland of Istria, Austria, on a peninsula in the Bay of Largone, 13 miles southwest of Trieste (Map: Austria, C 4). It contains an old castle, has a deep harbor and several dock-yards, and is the seat of considerable commerce. Wine, oil, glass, soap, and chemical products are manufactured. The salt works of Pirauo are among the most productive in Austria. Population, in 1890, 12,326; in 1900, 13,339, mostly Italians.

PIRATE, THE. A novel by Sir Walter Scott (1822). The scene is the Shetland Islands, visited by the pirate Cleveland, the son of the half insane Norna, though she mistakes Mertoun for her child until the secret is revealed at the close.

PIRATE BUG. A bug of the family Reduviidae, a large group comprising more than 2000 species, all of which are predatory in habits and feed upon other insects; also known as 'assassin bugs' and 'cannibal bugs.' With many species the

beak is so strong that it is capable of piercing the skin of human beings. (See CONE-NOSE.) A notable example is the 'wheel-bug' (*Arius cristatus*), called by the negroes in the South 'the Devil's riding horse.' The eggs, which look like miniature leather bottles standing on end and in hexagonal clusters, are attached to the bark of trees, and hibernates. The young bug emerges by pushing off the cap of the bottle. It has a blood-red abdomen, and in walking frequently elevates the hind end of the body, curling it forward. It feeds upon soft-bodied insects, such as plant-lice, but as it grows, attacks larger insects, and when full grown will destroy big caterpillars and even beetles. The full-grown bug is black in color and captures its prey by stealth. Its coloration is protective. In the more southern States it is an important factor in the destruction of numerous caterpillars which defoliate fruit and shade trees. Consult: Comstock, *Manual for the Study of Insects* (Ithaca, 1895); Howard, *The Insect Book* (New York, 1902).

PIRATE PERCH (so called from its voracity). A strange little fish of sluggish streams along the eastern coast of the United States and in the Mississippi Valley, which is related to the perches, but has been set apart in a suborder

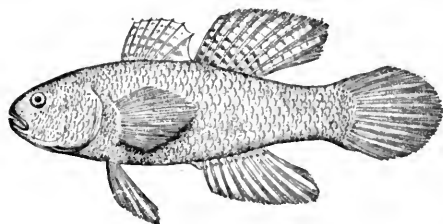

THE PIRATE PERCH.

Xenarchi. The single species (*Aphredoderus sayanus*) represents the only genus and family of this group, which appears to be a relic of an ancient type. Its color is dark olive, profusely speckled with darker points, which often make blackish streaks along the rows of the scales; two blackish bars cross the base of the tail; and the length is about five inches.

PIRAYA, pē-rā'yá, or **PIRAI**, pē-rí'. A South American fish. See CARIBBE.

PIRENE, pi-rē'nē. A spring at Corinth, sacred to the Muses. Various accounts are given of its origin, but the usual tradition makes it to have been struck out of the Acrocorinthus by Pegasus, who was captured by Bellerophon while drinking its waters.

PIRITHOUS, pi-rith'ō-ūs. King of the Lapithæ, and son of Ixion, or Zeus. At his marriage with Hippodamia the centaur Eurytus, while intoxicated, carried off the bride. In the consequent fight between the Lapithæ and Centaurs, Pirithous was aided by his friend Theseus, King of Athens, and subsequently, with his help, attempted to carry off Persephone from the lower world. For this both were bound to a rock by Plato, but Theseus was released by Hercules, while Pirithous was left to his punishment.

PIRKHEIMER, pirk'hī-mēr, WILIBALD (1470-1530). A famous German humanist. He was

born at Eichstädt, educated at Padua and Pavia, and on his return to Nuremberg (1497) became counselor to the Emperor Maximilian and held this post for twenty-five years. In 1522 he became counselor to Charles V., but soon after gave himself up entirely to scholarly studies. At the beginning of the Reformation Pirkheimer sided with Reuchlin, but he could not go so far as Luther, although he defended him at first, so that he finally took much the same position as Erasmus, with whom, as well as with Reuchlin, Celtes, Hutten, and especially Dürer, he was on most intimate terms. His scholarly activity was wide and embraced studies in mathematics, astrology, theology, and politics. He wrote an historical work, *Bellum Suitense*, dealing with the war in Switzerland in 1499, in which he had commanded the forces of Nuremberg (edited, with an autobiography, by Rück, Munich, 1895), and various translations from Greek into Latin. Consult: Hagen, *Wilibald Pirkheimer in seinem Verhältniss zum Humanismus und zur Reformation* (Nuremberg, 1882); Roth, *Wilibald Pirkheimer* (Halle, 1887).

PIRMASENS, pĕr'mā-zĕns. A town in the Rhine Palatinate, Bavaria, situated about 30 miles southwest of Speyer (Map: Germany, B 4). It has a Protestant church with a fine monument to Landgrave Louis IX. of Hesse. Its chief industry is the manufacturing of footwear, which is carried on on a large scale. Pirmasens is noted as the scene of a victory of the Prussians over the French, under Moreau, in 1793. Population, in 1890, 21,041; in 1900, 30,194, chiefly Protestants.

PIRNA, pĭr'nā. A town in the Kingdom of Saxony, Germany, situated on the left bank of the Elbe, about 11 miles by rail southeast of Dresden (Map: Germany, E 3). It has a number of churches dating from the thirteenth century, an old castle with an insane asylum, a realschule, a seminary for teachers, a school of navigation, and a municipal museum. The manufactures include leather, essential oils, enameled ware, pottery, various kinds of glass, etc. Pirna is first mentioned as a possession of the Bishops of Meissen in the tenth century. It attained considerable prosperity in the Middle Ages, but subsequently declined on account of the ravages of war. During the Seven Years' War the Saxons entrenched themselves in Pirna and were forced to capitulate to a superior force of Prussians on October 17, 1756. Population, in 1890, 13,852; in 1900, 18,295, chiefly Protestants.

PIRO, pĕr'ō. The name of two Indian tribes, one of North America, the other of the Southern Continent. (1) **PIRO**, a Pueblo tribe of Tañao stock, formerly occupying several villages along the Rio Grande, about the present Socorro and Magdalena, N. M., but now extinct, excepting a nearly Mexicanized remnant at Seneeu, Mexico. (2) **PIRO**, **CHUNTAQUIRU**, or **SIMIRINCHE**, a southern tribe of Arawakan stock (q.v.) occupying the headwaters of the Apurimac and Ucayali rivers, Central Peru. They were in part converted by the Jesuits between 1683 and 1727. They get the name of *Chuntaquiru*, 'palm tooth,' from their custom of dyeing their teeth black with the root of the chunta palm. They are expert boatmen and fishermen, and collect sarsaparilla and make manati oil for the traders. They dress in black cotton cloth.

PIROGUE, or **PERIAGUA** (Fr. *pirogue*, from Sp. *piragua*, canoe, from the West Indian name). A form of boat used on the Western rivers of the United States and in the West Indies and Central and South America. It is usually a 'dug-out' and made from a single log. But larger varieties are made from 'dug-outs' by splitting them in two and inserting one or more planks in the bottom to give greater width. When fitted with sails these boats usually have two masts which may be easily unstepped and taken down.

PIRON, pĕr'ōn', ALEXIS (1689-1773). A French poet and dramatist, famed for wit and epigram. He was born in Dijon, July 9, 1689, studied law, and in 1719 he went to Paris as secretary to Belle-Isle, grandson of Fouquet. With Piron's monologue in three acts, called *Arlequin Deucalion*, the comic opera got new life. *La métromanie* (1738) has, also, some dramatic merit. Piron's *Works* are in seven volumes (1776). The epigrams, often reprinted, are of most significance. Piron died in Paris, January 21, 1773.

PIROT, pĕr'ōt'. A town of Serbia, situated near the Bulgarian frontier on the railroad from Belgrade to Sofia, and 48 miles northwest of the latter city (Map: Balkan Peninsula, D 3). It is a fortified place of considerable strategic importance, and is noted for the manufacture of carpets. Population, in 1900, 10,421.

PISA, pĕz'ā. The capital of the Province of Pisa, in Tuscany, Italy, situated on both banks of the Arno, five miles east of the Mediterranean, 11 miles northeast of Leghorn and 49 miles west of Florence (Map: Italy, E 4). The equable climate favors Pisa as a desirable winter resort for persons having pulmonary troubles. The neighboring mountains (the Monti Pisani, five miles to the east) and the high ancient fortifications (over six miles in circuit) protect the city from winds.

It is defended by a citadel on the southwest. Its streets are quite regular and are well paved. The centre of life in Pisa, which is a quiet town, is the Lungarno—stretch of fine wide quays bordering both banks of the river from one end of the municipality to the other. Here are fine hotels and restaurants. The Arno is spanned by five bridges.

The glory of Pisa is the far-famed Piazza del Duomo with its cathedral, baptistery, Leaning Tower, and Campo Santo, all situated in the extreme northwest corner of the city. The splendid cathedral, or basilica, dates from 1063 and was restored at the beginning of the seventeenth century. It is a remarkably perfect example of the Tuscan-Romanesque. It is of white marble, varied with black and red stripes. It is crowned by a semi-dome which contains mosaics on gold ground by Cimabue and others. The façade rivals any in Italy. It is characterized by columns, arches, and galleries. In the interior are 68 antique columns taken by the Pisans in their wars with their enemies. Among the interesting contents is a handsome bronze lamp suspended in the nave, the swaying of which is claimed to have suggested the explanation of the pendulum to Galileo. The circular marble baptistery, adorned with numerous columns, stands in front of the cathedral. It belongs to the middle of the twelfth century. Its dome rises to a height of nearly 200

feet, and possesses a remarkable echo. The baptistery contains a Madonna by Giovanni Pisano, and a pulpit—a celebrated masterpiece—by Nicola Pisano. The beautiful marble campanile, or Leaning Tower (q.v.), rises in the rear of the church. The view from the top, reached by nearly 300 steps, is superb, embracing the Carrara and Apuan Mountains, the city, and the blue sea.

Northwest of the cathedral is the quadrangular Campo Santo (cemetery). It was laid out in the beginning of the twelfth century. Its soil was brought in ships from Mount Calvary, that the dead here might lie in truly consecrated ground. A decorative Tuscan-Gothic structure, planned by Giovanni Pisano, incloses the cemetery. On the outside are numerous flat arches borne by pilasters. Inside, an arched and covered colonnade surrounds the burial plot. Here are found very interesting and suggestive frescoes by Tuscan artists of the close of the mediæval era. Of these paintings the most remarkable is the "Triumph of Death." There is also a notable "Last Judgment." The monuments, sarcophagi, urns, friezes, memorial tablets, etc., in the cemetery proper are of exceptional interest. The Basilica San Paolo a Ripa d'Arno, founded by Charlemagne, but belonging in its present form probably to the thirteenth century, possesses a rich façade of yellow, gray, and black marble. Santa Maria della Spina is a beautiful little church in the French Gothic, dating from the same period and built for seamen. It was restored in 1872.

Among the palaces the attractive brick Gothic Agostini of the fifteenth century deserves mention, as does also the Toscanelli, where Lord Byron sojourned in 1822. In the Loggia de' Banchi is the present corn exchange. Near by is the Palazzo del Comune, containing the valuable Pisan archives. The university, founded in 1338, is in a huge building dating from the latter part of the fifteenth century. (See PISA, UNIVERSITY OF.) The municipal museum (founded in 1893) contains works by Tuscan masters, but nothing of great interest. The Palazzo Conventuale dei Cavalieri is at present a high normal school. The Academy of Fine Arts was founded by Napoleon in 1812. The Cateriniana Library contains about 60,000 volumes. Pisa has statues of the Grand Duke Leopold I., Garibaldi, Mazzini, and Grand Duke Cosimo I., by Giovanni da Bologna, near which last once stood the historic Tower of Hunger of horrible memory, described by Dante in the *Inferno*. (See GHERARDESCA.) The house where Galileo was born is shown.

Pisa is wealthy and in a thriving condition. Cottons are largely manufactured. Oil and marble from the vicinity constitute important shipments. The city was formerly a port on the sea, but the silting up of the Arno caused Leghorn to grow in importance. There are fine market halls, an extensive hospital, and four theatres. The rich gardened plain around Pisa, lined with lonely poplars, is interesting despite its flatness. The population of the commune of Pisa in 1901 was 61,321, of whom only about half resided within the city.

The city was probably of Etruscan origin. It fell to Rome in B.C. 180. The Romans embellished it and made it important. About A.D. 1000 it became a formidable commercial and naval rival of Venice and Genoa. Strongly religious, it played in that era a prominent rôle in the defense and

diffusion of Christianity, the Republic taking a conspicuous part in the Crusades. Its warring citizens took Sardinia from the Saracens, and finally destroyed their naval power in the Mediterranean. Corsica and the Balearic Islands fell to them. The city was in the full flower of its greatness in the twelfth and thirteenth centuries. It held the coast from near Genoa to the vicinity of Rome. It had many contests with Lucca and Florence; it was aggressively Ghibelline. But the fall of the Hohenstaufens was at length a blow to the city, and it met decisive defeat by Genoa in a great sea-fight off Meloria, near Leghorn, in 1284. A few years later the Genoese destroyed its harbor. It began to decline, gradually losing all its possessions, and in 1406 it fell under the sway of Florence. It shook off the Florentine yoke in 1494, only to be resubjected in 1509. Henceforth its history was part of that of the Florentine State and of Tuscany. About 1600 Pisa had only about 15,000 inhabitants. In the height of its prosperity it had no less than 150,000.

In art history Pisa earned a worthy name until supplanted by Florence. Its cathedral marks the beginning of Italian art of the Middle Ages. The only branch of art, however, in which Pisa left an important influence was architecture (particularly ecclesiastical architecture), though it gave no little impetus to sculpture, being the native city of Nicola Pisano and his son Giovanni. Consult Schübring, *Pisa* (Leipzig, 1902).

PISA, COUNCIL OF. A council held in the year 1409; not reckoned among the ecumenical councils. It was assembled in the time of the great schism which followed the removal of the popes to Avignon (see SCHISM, WESTERN; PAPACY), for the purpose of restoring the peace of the Church. The cardinals of both parties, desiring to put an end to the anomalous condition which existed, united to call a general council. Both claimants to the Papacy, Gregory XII. and Benedict XIII. (antipope), were notified by their adherents and requested to appear at its sessions. Both, however, refused and called synods of their own. The cardinals persisted, and proceeded to deliberate upon the case. Twenty-two of them were present, besides some 80 bishops and representatives of over 100 more, with a vast body of abbots, doctors, and other eminent ecclesiastics. After a formal citation of the rival popes the council, on their non-appearance, proceeded to declare them contumacious, and to examine their respective claims as though they had appeared. The result, after a protracted inquiry, was a decree by which they were both declared schismatics, and deposed from the Papal dignity, and their followers released from obedience. In the seventeenth session the cardinals entered into conclave to the number of 24, and unanimously elected Peter Philargi, who took the name of Alexander V. The council proceeded after his election to pass a number of decrees, for the purpose of giving validity to the acts done on either side during the schism. A vain attempt was made to obtain the submission of the still recalcitrant rivals, and it was resolved that a new council should be held within three years. The authority of this council, like that of the Council of Constance, is alleged by some Gallican divines to establish the superiority of a general council over the Pope. But the contention is made in reply that both these councils, and

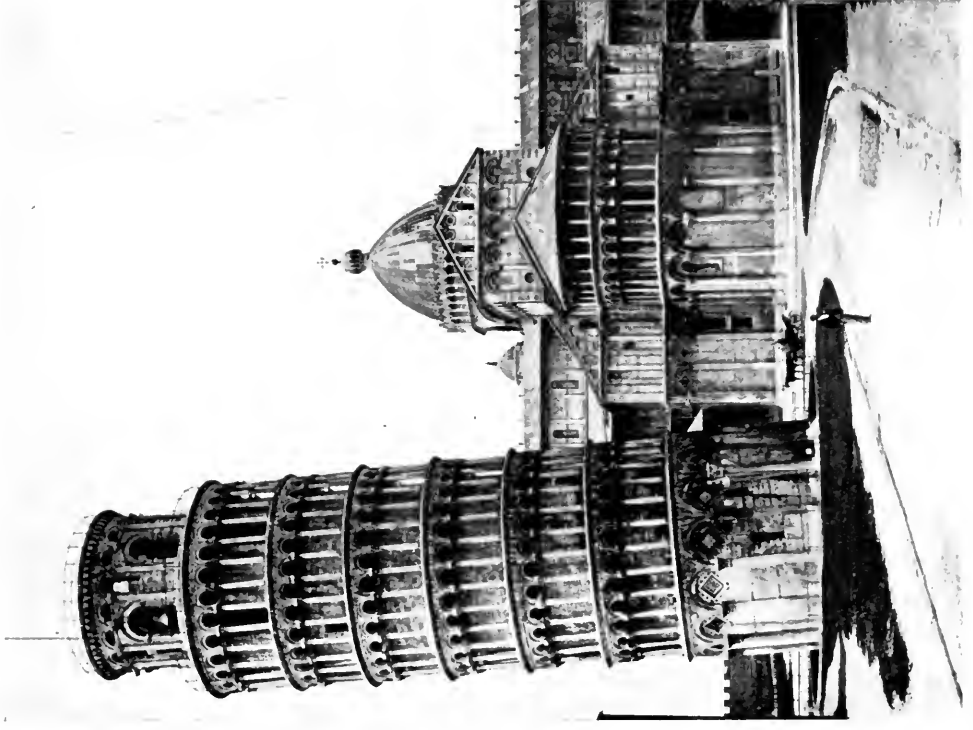

PISA
THE CAMPANILE (LEANING TOWER) AND CATHEDRAL

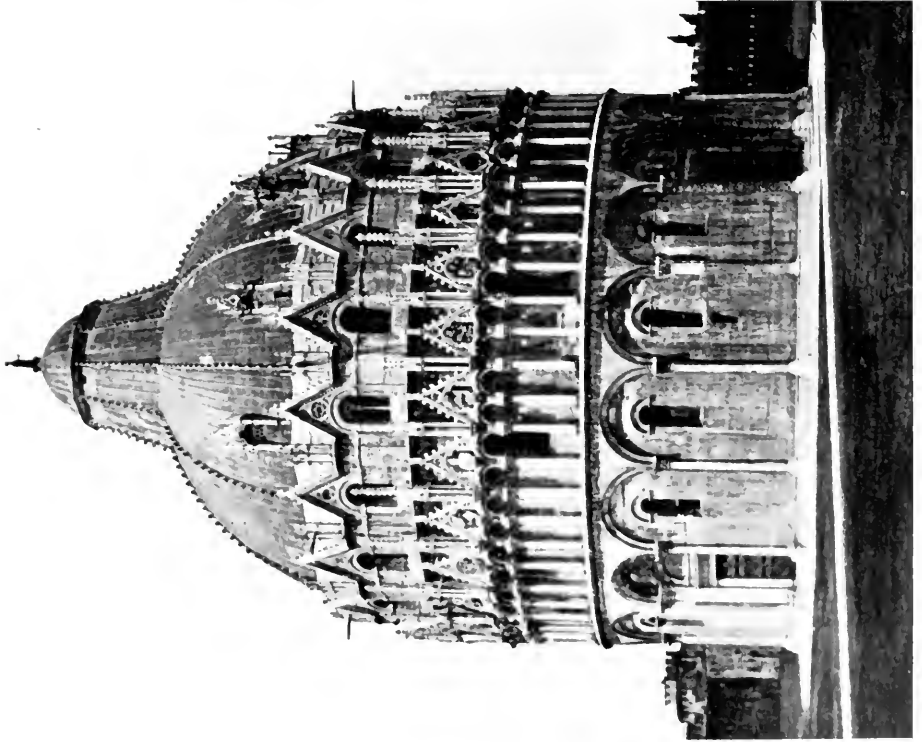

THE BAPTISTERY

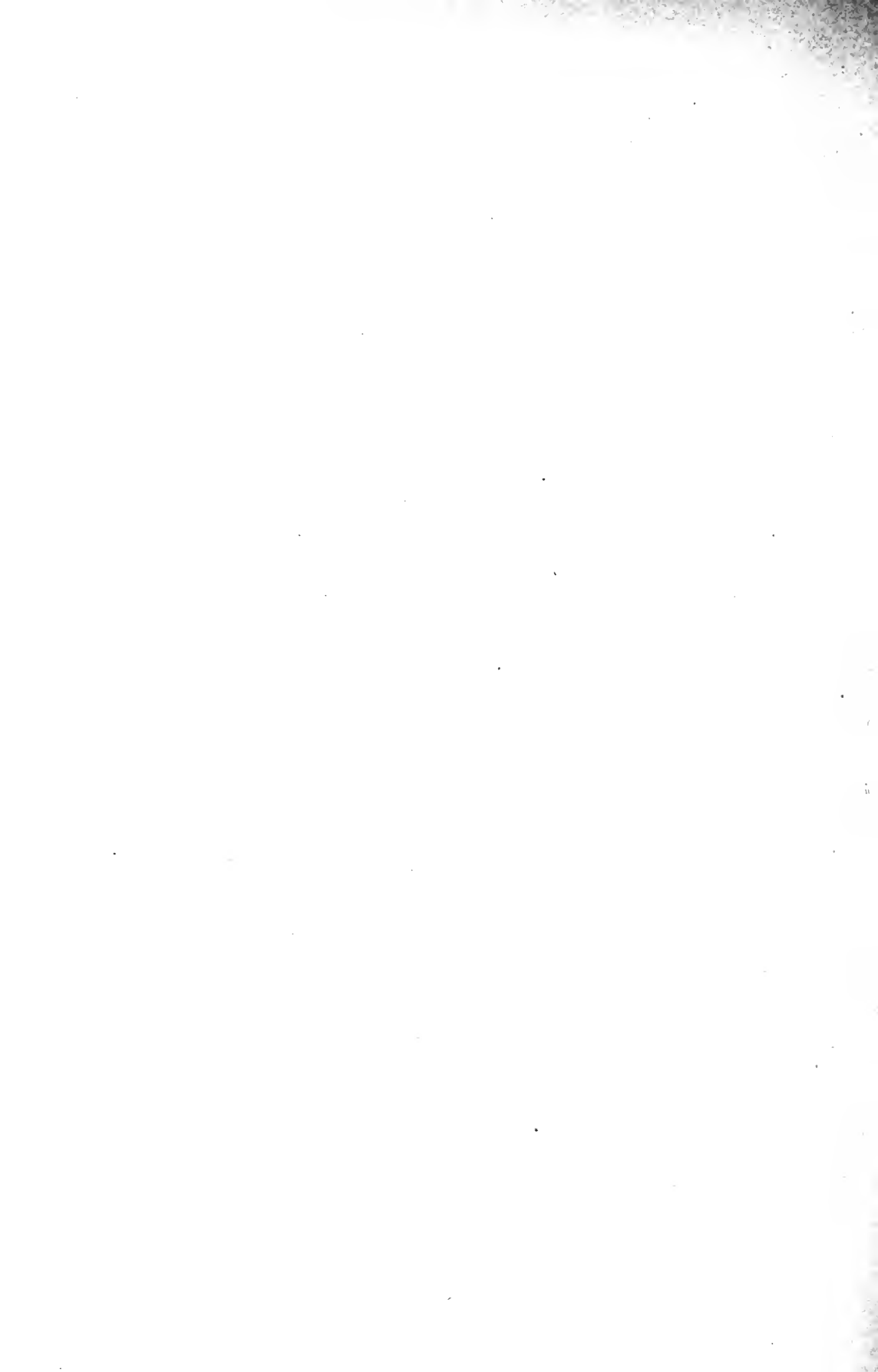

also that of Basel, must be regarded as abnormal assemblies, called to meet the special emergency of a disputed succession and of a doubtful pope, and that these principles cannot by any means be applied to the ordinary circumstances of the Church, or form a precedent by which to estimate the normal relations between a pope whose title is certain and undisputed and a general council regularly assembled in the ordinary circumstances of the Church.

There were two other councils at Pisa, in 1133, when Peter of Bruys was condemned, and in 1511, when certain cardinals endeavored to have Pope Julius II. condemned for not calling a general council to reform the Church.

PISA, UNIVERSITY OF. One of the oldest European universities. There existed at Pisa teachers of law and medicine as early as the twelfth century, but the real beginning of the university dates from the emigration of a large number of students and teachers from Bologna in 1338 on account of the Interdict of Pope Benedict XII. At the instance of the Pisans, Pope Clement VI. authorized the establishment of a Studium Generale, which was dissolved in 1359 for lack of funds. In 1364 a new authorization was obtained from Pope Urban V. for its re-establishment. With the loss of Pisan independence in 1406 the university ceased to exist, but it was opened again by Lorenzo de' Medici and flourished for a while. It soon went out of existence again. Cosimo I. de' Medici reopened it in 1543 and generously supported it. In 1544 a botanical institute, the first of its kind, was established and the university soon achieved considerable fame. With the decay of Italian universities it suffered the general fate. It was revived in 1808 by Grand Duke Leopold II. of Tuscany, who endowed it munificently. In 1839 it received a well-equipped physical institute. After the revolution of 1848 it was reduced to a mere natural science and mathematics section, but was reopened with all faculties in 1850 and has since maintained a high standing among Italian universities. In 1902 it consisted of the faculties of law, medicine-surgery, philosophy, and mathematics-natural science, and the engineering, pharmacy, veterinary, and higher agricultural schools. The attendance was 1074, and the library contained 130,000 volumes, 28,000 pamphlets, and 300 manuscripts.

PISACA, pē-shā'chā. The vilest and most malignant demons in Hindu mythology. In the Vedas they are opposed especially to the pitris (q.v.), and are frequently termed *kravyādas*, or eaters of raw flesh. They infest houses and villages, and as Agni (q.v.) is besought to restore the flesh which the Pisacas have devoured from the sick man, they seem to have been ghoulish in nature, and associated with ghosts of the malignant dead. In modern India the Pisaca is pre-eminently the spirit of a liar, adulterer, criminal, or lunatic. Sometimes, however, if the proper incantations be performed, this class of demons can be forced to cure diseases. The legendary accounts of the origin of the Pisacas vary. According to the earlier view, they, together with the Asuras and Rakshakas, were created by Brahma from the stray water which was scattered from the drops out of which gods, men, and other good beings had been formed. Other sources, however, regard them as the offspring of the *Prajapatis* or of *Prajapati* (q.v.) himself.

PISAGUA, pē-sā'gwā. A town of the Province of Tarapacá, Chile, on the Pacific Coast, 46 miles north of Iquique, with which it is connected by rail. It is the second city of the province, situated in a desert country, with a fair harbor, well-constructed streets, and modern houses. The great industry of the town is the shipping of nitre, which is brought by rail from the interior. Its population is about 8000. On April 18, 1879, Pisagua was bombarded and completely destroyed by the Chilean fleet, but after the cessation of hostilities was quickly rebuilt. Near the town (November 19, 1879) occurred a battle in which 6000 Chileans defeated the combined forces of Peru and Bolivia, numbering 11,000.

PISAN, pē'zān', CHRISTINE DE. See CHRISTINE DE PISAN.

PISANDER (Lat., from Gk. Πεισανδρος, *Peisandros*). A Greek poet. He was born at Camerus, in the island of Rhodes, and appears to have lived about B.C. 650, although some critics state that he was earlier than Hesiod, and was a contemporary of Eumolpus. He is remembered chiefly for his *Ἡράκλεια*, a poem in two books on the exploits of Hercules. In this Hercules was for the first time represented as armed with a club, and covered with a lion's skin, instead of the usual armor of the heroic period. By many it is believed that Pisander was also the first to fix the hero's labors at twelve, corresponding to the signs of the zodiac. The work was so highly praised by the Alexandrian critics that they assigned Pisander a rank among epic poets after Homer, Hesiod, Panyasis, and Antimachus. Only a few lines have been preserved.

PISANELLO, pē'zā-nē'l'ō, properly VITTORE PISANO (1380-1452). An Italian painter and medalist, who introduced the Renaissance into Verona. He was born at San Vigilio, near the Lake of Garda, in 1380. Concerning his early years and his art apprenticeship little is known. Certain features in his works point to Altieheri da Zevio as his master. He is to-day better known as a medalist. As such he invented a new process of casting medals and finishing them with the tool, and portrayed a number of contemporaries. Unfortunately, few of his paintings survive. He painted many works at Verona between 1417 and 1422, and in 1421-22 completed a fresco in the Sala del Gran Consiglio, Venice, where he was employed together with Gentile da Fabriano. His work at Pavia, in Saint John Lateran, Rome, and at Mantua has disappeared, and his easel pictures are extremely rare. His style may be best studied in the fresco on the arch of the Pellegrini Chapel in Sant' Anastasia, Verona, which has been made accessible through the Arundel lithograph, and in the "Vision of Saint Eustace," in the National Gallery, London. While pleasing in color, his compositions are dominated by the naturalistic tendency of the painter, and justify, when compared with contemporary works, the reputation he enjoyed as a depicter of birds, animals, and landscape. Consult: Heiss, *Les médailleurs de la Renaissance*, vol. i. (Paris, 1881); Spaventi, *Vittore Pisanello* (Verona, 1893); *Venturini, Gentile Fabriano e il Pisanello* (Florence, 1896).

PISANIO, pē-sā'nē-ō. The servant of Posthumus in Shakespeare's *Cymbeline*. He is sent

to murder Imogen; but, allowing her to escape, he deceives Posthumus, by means of a bloody handkerchief, into believing that she is dead.

PISANO, pō-zā'nō, ANDREA. See ANDREA DI UGOLINO.

PISANO, GIOVANNI (c.1250-1320). One of the greatest sculptors of mediæval Italy. He was a son of Niccolò Pisano, and was probably born at Pisa, where he entered his father's workshop as apprentice. His earliest recorded work is his share in the superb pulpit at Siena (1266-67). (See PISANO, NICCOLÒ.) The crowded composition and dramatic quality of his pulpit was probably due largely to Giovanni, who differed in these qualities from his father. This tendency was still held in check in such early works as the reliefs and statuettes of the fountain at Perugia (1274-78) and the decorations of Santa Maria della Spina at Pisa. It was fully developed in the pulpit of Sant' Andrea at Pistoia (1300), where the "Crucifixion" and the "Massacre of the Innocents" are particularly dramatic and tense, not to say exaggerated. This tendency to realism was also shown in the heads of many of his statues, which are character studies rather than types. A good instance of this, as well as of his love of allegorical subjects, is the group in the Campo Santo, Pisa, of four figures symbolizing the virtues characteristic of Pisa, whose figure crowns the group. The explanation of Giovanni's style lies in the fact that he was the first Italian sculptor thoroughly influenced by the Gothic transalpine school and that this influence came to him from Germany rather than France. One of his works, at least, the tomb of Pope Benedict XI, at Perugia, shows another influence, that of the Roman school, with its mosaics, its Gothic canopy and angels, and calm reclining figure. One of his most ambitious works, a large pulpit for the Cathedral of Pisa, has been reconstructed from remaining fragments. Aside from a "Madonna and Child" in the Cathedral of Florence, some few pieces attributed to him at Siena, Cortona, and Arezzo (where the monuments of Saint Margaret and San Donato are certainly not by his hand), the majority of his works are in the Campo Santo at Pisa. He influenced the style of the Pisan school of sculpture far more than his father, Niccolò, and his influence extended to Siena and other Tuscan cities.

The *Life of Giovanni* by Vasari would make of him, as in the case of his father, Niccolò, a prominent architect as well as sculptor, and with greater reason; from his design for the Campo Santo at Pisa, the façades of the cathedrals at Siena and Prato, if these are correctly attributed to him, he appears to have been the leader in the so-called round arch Gothic. The arcades of the Campo Santo are one of the masterpieces of Italian art. Consult: Perkins, *Tuscan Sculptors* (London, 1864); id., *Historical Handbook of Italian Sculpture* (New York, 1883); Dobbert, in Dohme, *Kunst und Künstler Italiens*, i. (Leipzig, 1878); and Marcel Reymond, *Le sculpture toscane* (Florence, 1900).

PISANO, GIUNTA. An early Italian painter. See GIUNTA PISANO.

PISANO, LEONARDO. The name sometimes applied to the Italian mathematician Leonardo Fibonacci (q.v.).

PISANO, NICCOLÒ (c.1206-78). An Italian sculptor and architect, generally regarded as the

founder of the Italian school of sculpture. His birthplace is a matter of dispute, some maintaining that he was a native of Apulia, whence he brought an art formed upon classical models. It is more likely, however, that he was born in Pisa, or in one of the two Tuscan towns called Puglia. Niccolò's study of the antique, especially of Roman sarcophagi, led him to treat the nude, to aim at rich effects of drapery, and at artistic grouping of figures. His earliest known work is a lunette at the Cathedral of Lucca representing a "Deposition from the Cross," the "Nativity of Christ," and the "Adoration of the Magi" (c.1237). His masterpiece is the famous six-sided marble pulpit of the baptistery at Pisa, finished in 1260; the body of the pulpit decorated with five reliefs rest on Corinthian columns. Between the reliefs are charming statuettes and the columns rest on lions. A figure of the high priest seems copied from that of an Indian Bacchus and others from a Roman sarcophagus, still in the Pisan Campo Santo. Among the bas-reliefs of the pulpit, which represent scenes from the life of Christ, those of the "Nativity" and "Adoration" are the finest. Niccolò's style here appears at its best, in broad, majestic, well-balanced figures, treated in very high relief. In 1265 Niccolò was commissioned to execute a similar pulpit for the cathedral at Siena, to which city he probably transferred his studio, as he was assisted in its execution by his son, Giovanni Pisano (q.v.), and his other pupils, Arnolfo (q.v.), Lapo Goro, and Donato. This pulpit was completed in 1268, and while even richer in form and sculpture than that at Pisa, has less unity of style. Meanwhile (1265) Niccolò had furnished a colleague, Guglielmo Agnelli, with the designs for a monumental carved marble shrine for the Church of San Domenico at Bologna, completed in 1267, the "Arca di San Domenico;" none of the reliefs or statues, however, was executed by his hand. Shortly before his death he designed, in 1274, and partly decorated with sculptures the beautiful public fountain at Perugia (see FOUNTAIN), completed by his son Giovanni; the statuettes rather than the reliefs are supposed to be by the father's hand.

As a sculptor Niccolò first freed Italian art from the shackles of imperfect technique, created individual types, and had an ideal of beauty. He was rather the culmination of the Romanesque epoch than the creator of a new style. His son Giovanni Pisano (q.v.) was the real founder of the Italian Gothic school of sculpture, slender, dramatic, and allegorical, in contrast to the heavy, calm, and classic style of Niccolò. Niccolò's works as an architect are less certain. The buildings attributed to him by Vasari, in his *Life of the artist*, are nearly all of problematic authenticity. He is known to have built in Pisa, and probably San Nicola (especially the tower) and Santa Caterina are by him; possibly even Santa Trinità in Florence. Consult: Dobbert, *Ueber den Stil Niccolò Pisanos und dessen Ursprung* (Munich, 1873); id., "Die Pisani," in Dohme, *Kunst und Künstler Italiens* (Leipzig, 1878).

PISANO, VITTORE. See PISANELLO.

PISAREFF, pē'sá-ryĕf, DMITRIY IVANOVITCH (1840-68). A famous Russian critic. Born at Znamenka, he graduated from the Saint Peters-

burg Classical Gymnasium, and took up philology. A successful review (1859) in the *Daen*, a magazine for girls, caused him to turn to literature. In 1860 he placed a translation of Heine's *Atta Troll* in Blagosvyetloff's monthly *Russian World*, of which he became coeditor. *Scholastics of the Nineteenth Century* made him the idol of the youth, who asserted that "thenceforth contemporary metaphysics and mysticism were dead." In May, 1862, the monthly was suppressed. In bitter mood Pisareff rewrote a suppressed review of his for an underground publication. As a result he was shut up for nearly five years in the Schlüsselberg fortress. All his best efforts, critical estimates of contemporary and preceding Russian authors, as well as his popularization of natural sciences, which exercised a powerful influence on the generations of the sixties and seventies, were written here. Given liberty in 1867, he went to recuperate on the shores of the Baltic, and lost his life while bathing. Rumors were rife that the Government had a hand in the matter. Pisareff's fame rests on his championship of two principles—emancipation of personality and utilitarianism. He has been berated as a savage utilitarian, advising poets "to make shoes and bake fish pies." In reality he demanded that when a writer could not say with Börne, "I write with the blood of my heart and the sap of my nerves," he should turn to more utilitarian work. Scientific achievements during the fifties, Mill's ardent plea for utilitarianism, and the liberation of serfs in 1861, account for Pisareff's ideas as well as for his popularity. Dying at twenty-eight, he left ten volumes of critical works (2d ed., 6 vols., Saint Petersburg, 1894).

PISCAT'AQUA. A river about 80 miles in length, forming the southern part of the boundary between Maine and New Hampshire (Map: New Hampshire, L 9). It empties into the Atlantic, forming at its mouth the harbor of Portsmouth.

PISCES, pîs'sêz (Lat., fishes). One of the main divisions, or phyla, of cold-blooded vertebrates, including the fishes in the more restricted sense. It is well marked off from the lampreys, which are commonly called fishes, and is characterized by the presence of persistent gills and the possession of paired appendages in the form of fins. See FISH.

PISCHEL, pîsh'cl, RICHARD (1849—). A German Sanskrit scholar, born in Breslau, and educated there and in Berlin. He was professor of Sanskrit in Kiel from 1875 to 1885, and then at Halle, and in 1902 went to Berlin. Pischel's especial field is classical Sanskrit, and more particularly the drama. He urges its independence from the Greek drama, and is particularly fortunate in his conjectures of dates and authors for famous plays. But he wrote as well on the Vedic period, publishing with Geldner three volumes of *Vedische Studien* (1889-1901), and on Prakrit grammar, *Hemacandra's Grammatik der Prakritsprachen* (1877-80); a Prakrit dictionary, *Hemacandra's Deçināmamāla*, with Bühler (1880); and *Grammatik der Prakritsprachen* (1900). His further work includes: *Kālidāsa's Çakuntalā*, the Bengali recension (1877); *Rudra'ta's Çrngāratilaka*, a rhetorical work (1886); *Die Heimat des Puppenspiels* (1900); and *Materialien zur Kenntnis des Apabhramsa* (1902).

PISCICULTURE. See FISH-CULTURE.

PISCINA, pîs-sî'nā (Lat., fish-tank). A water-tank, especially the cold plunge or swimming basin of a Roman bath. In ecclesiastical and modern usage, a small basin supplied with running water, particularly such a basin in a decorative setting applied to or set in a wall, as in the chancel of a church for the washing of the chalice after mass, or in the sacristy for the use of the clergy. These were often highly ornate in the mediæval and early Renaissance periods, consisting of a wall-niche, either single or double, richly adorned, containing one or two faucets, and a sculptured basin projecting from the wall.

PISÉ, pè'zâ', or **PISAY** (Fr., pounded, brayed, crushed). A material and a process of building which depends upon the adhesive character of many natural earths. Any soil which is found to pack in the hand may be used. Where the soil is very fat, with much clay in it, this construction is capable of enduring many years. The material is of the nature of unburned brick so much used in Western Asia in antiquity, but it is made up in the mass instead of being shaped in blocks for building. See BRICK.

PISEK, pîs'èk. A small town of the Crown-land of Bohemia, Austria, situated on the Wotawa, an affluent of the Moldau, 55 miles southwest of Prague (Map: Austria, D 2). It is still partly surrounded with walls, has an old castle, a gymnasium, a realschule, and schools of agriculture and forestry. The manufactures are woolen and cotton fabrics, iron wire, and musical instruments. Population, in 1890, 10,900; in 1900, 13,574.

PISEMSKI, pè'syëm-ské, ALEXEI FEOFILAKTOVITCH (1820-81). A Russian novelist, born in the Government of Kostroma. He was educated in Kostroma and at the University of Moscow. Until his retirement in 1874 he was in the Government service. His literary activity dates from *Boyarshchina* (1847). A long line of works followed, among which *Tyufyak* (1850), *A Love Match*, and the drama of peasant life, *A Bitter Lot* (1853), *Pitershehik*, and *A Thousand Souls* (1858), may be mentioned as the best. In all of these Pisemski appears as an over-sober realist, picturing life in its lower aspects without compassion or censure, and at times verging on cynicism. His hopeless pessimism discovers the basest motives in what appears to be respectable and good, as when in *A Thousand Souls* he drew only the vices and shortcomings of the whole liberal movement without a single attractive feature for relief. With a heart embittered by his critics, he published in 1863 his last great effort, *Turbid Sea*. The works following it, such as *Men of the Forties* (1869), *Whirlpool* (1871), *Burgesses* (1877), *Freemasons* (1878), and many plays, showed a falling off in his powers and received little attention from the critics. Grief at the death of his two sons, both professors at the Moscow University, hastened his end. His works were published in 24 volumes (Saint Petersburg, 1895).

PISGAH, pîz'gâ (Heb. *Pîsgâh*, boundary, from *pâsag*, to divide). A mountain of the Abarim range, east of the Dead Sea. It is to be noticed that Pisgah never occurs by itself in the Old Testament, but always with the definite article

in connection with 'top' or 'slopes.' In Deut. xxxiv. 1, the 'top of the Pisgah,' from which Moses reviewed the promised land, is identified with Mount Nebo (q.v.), and in the days of Eusebius *Fasga* was still used for the region of Mount Nebo. The double name may, for all that, point to varying traditions in regard to the incident in the career of Moses.

PISIDES, pis'-dēz (Lat., from Gk. Πισιδῆς), GEORGIOS. A Byzantine poet of the seventh century A.D. He was a Pisidian by birth, as his name signifies, but attained fame as a deacon of the Church of Saint Sophia in Constantinople, and as a keeper of the records in the same church. His poems, all in excellent iambic trimeters, are a *Hexameron*, a didactic cosmology; some hymns and epigrams; and three historical poems dealing with the wars against Persia, the siege of Constantinople in 626, and the victory of Heraclius over Khosru, and furnishing important data for the reign of Heraclius. The complete works are to be found in Migne, *Patrologia Græca*, vol. xxi.

PISID'IA (Lat., from Gk. Πισιδία). An ancient division of Asia Minor, bounded on the north by Phrygia, on the east by Cilicia, on the south by Pamphylia, and on the west by Lycia. It belongs to the modern Turkish Vilayet of Konieh. It was drained by the Cestus, Eurymedon, and Melas, the chief rivers of Pamphylia. The principal towns were Selge, Termessus, and Sagalassus. Antioch, sometimes called the Pisidian, seems to have been really in Phrygia. The wines of Amblada were celebrated, and salt and olives were chief productions. The country is wild and mountainous, abounding in picturesque scenery, and the inhabitants were bold and lawless freebooters who defied subjugation. The cities, however, were gradually Hellenized, and in Roman times the country seems to have enjoyed great prosperity, as is indicated by the splendid ruins at several places. Consult Lanckoronski, *Städte Pamphyliens und Pisidiens* (Vienna, 1890).

PISISTRATUS (Lat., from Gk. Πεισιστρατος, *Peisistratos*) (?-c.527 B.C.). The famous tyrant of Athens, son of Hippocrates and intimate friend of the lawgiver Solon, with whom he was closely related on his mother's side. He received an excellent education, and the charm of his manners as well as the generosity of his spirit was so great that, according to Solon, had he not been ambitious he would have been the best of the Athenians. But his desire for sovereign power led him to adopt a policy of artifice to attain his ends, which has deprived him of the reputation that the kindly character of his government might otherwise have obtained for him. Pisistratus first became prominent in connection with the war between Megara and Athens, which culminated in the capture of the Megarian seaport Nisæa and the island Salamis by Athens about B.C. 570-565. In this struggle he may have held the office of polemarch, and his ambition then spurred him to take advantage of the popularity thus gained to seize the sovereign power. He came forward as leader of one of the three parties into which Attica was then divided. These were the Pe-diaci (Πεδιακοί), or the Party of the Plain, consisting of the well-to-do landed proprietors; the Parali (Πάραλοι), the Party of the Sea-

board, to which belonged the wealthy merchant classes; and the Diacrii (Διάκριοι), the Party of the Highlands, chiefly a laboring population, jealous of the rich and eager for political equality. Pisistratus joined the Party of the Highlands, and attached to himself all the poorer citizens and the discontented by his liberal beneficence. When the time came for a decisive step, he drove into the market-place, and there, exhibiting certain self-inflicted wounds, called upon the people to protect him against his and their enemies, alleging that he had been attacked on account of his patriotism. Thereupon his followers, according to Plutarch, were ready to take up arms for him, a general assembly of the citizens was summoned on motion of Aristion, one of his supporters, and it was voted to allow him a bodyguard of fifty clubmen. Tradition says that Solon charged him with hypocrisy, but in vain. Pisistratus gradually increased the number of his armed attendants, and about B.C. 560, when he felt himself strong enough, he seized the Acropolis and established himself as tyrant over Athens. The leaders of the aristocratic party immediately fled from the city. What action Solon took is not definitely known; he died within two years after the establishment of Pisistratus's irresponsible rule. This rule, however, was not harsh or vindictive. Pisistratus attempted to continue unchanged the constitution laid down by Solon himself, and conferred many benefits upon the poorer citizens. But the parties of the Plain and the Seashore united against him, and in five years succeeded in driving him out. This coalition in turn was soon broken up, and Megacles, one of the leaders, made overtures to Pisistratus and secured his return. A family quarrel between them, however, caused a second expulsion of the tyrant about 550. He retired to Eubœa, where he remained for ten years, watching for his opportunity and making preparations to secure his return. He gained a following in many of the Greek cities, exploited the gold mines of Mount Pangæus, near the Strymon, and collected a force of mercenary soldiers. At length he was strong enough in friendship with other Greek States to attack Athens. When he landed at Marathon his adherents flocked to his standard, and after defeating the constitutional party he reestablished himself for the third time as tyrant about 540. He continued to hold this position without interruption until his death in 527 (528?). Then his power passed into the hands of his sons Hippias and Hipparchus (q.v.).

Pisistratus's rule was mild and beneficent. He reduced taxes, established the poorer citizens on estates, supplying them with the needed resources, cared for the old and the disabled, and extended Athenian influence abroad. He recovered Sygeum, which commanded the entrance to the Hellespont, and acquired the Thracian Chersonese. His administration is also famous for his encouragement of literature and the arts. Under his direction a splendid temple to Athena was erected on the Acropolis, the Lyceum was built, also a temple to Dionysus in Limnæ, and he established a new sanctuary for this god at the foot of the Acropolis. He began the great temple of Olympian Zeus, which was not finished till the reign of the Emperor Hadrian. He also carried through many internal improvements,

the most significant being that of the water supply. He purified Delos, the great shrine of the Ionian race, by removing all bodies buried within the sacred precinct. He made the Athenian religious festivals, in particular the great Panathenaic festival, more magnificent than they had ever been before. He had a new edition of the Homeric poems prepared by poets and scholars resident at his court.

PISO. A Roman family of the plebeian gens Calpurnia. The agnomina of the family were Frugi and Cæsonius. Its more important members are named below: LUCIUS CALPURNIUS PISO FRUGI, in B.C. 149, as tribune of the plebs, brought up the first law against extortion (*Lex Calpurnia de Repetundis*); in 133 was consul, and fought in the Servile War in Sicily, and was censor in 120. He opposed the reforms of the Gracchi. He is best known as author of an annalistic history of Rome down to his own time, of which a few fragments are published in Peter's *Historicorum Romanorum Reliquiæ*, vol. i. (Leipzig, 1870).—LUCIUS CALPURNIUS PISO CÆSONIUS was the father-in-law of Julius Cæsar, and in 58 became consul as a tool of the triumvir. He supported Clodius against Cicero, banished the latter, and was twice vehemently attacked by him for vicious administration of the Province of Macedonia. Having become censor in 50, Piso attempted to mediate between Cæsar and the aristocratic party, but was unsuccessful, and failing to join Cæsar in the Civil War, now won Cicero's hearty approbation. After Cæsar's murder Piso seems to have sided with Antony.—His son, who bore the same name (B.C. 48-A.D. 32), was high in the favor of Augustus and Tiberius; held the consulship (B.C. 15), and as prefect of the city (A.D. 17) was highly praised by Velleius Paterculus.—GNEUS CALPURNIUS PISO was consul with Tiberius (B.C. 7), and became his tool to check and harass Germanicus in the East, receiving the command of Syria (A.D. 18). He and his wife, Plancina, were suspected of poisoning Germanicus; Piso was abandoned by Tiberius, on whose orders he had acted, and in A.D. 20 committed suicide.—GAIUS CALPURNIUS PISO, a brilliant and popular young man, was robbed (A.D. 37) of his newly married wife by Caligula and banished by that Emperor. Under Nero he joined a conspiracy to murder the tyrant; on its discovery he opened his veins and died. He may be the Piso addressed in the panegyric *De Laude Pisonis*.—The last Piso to attain fame was LUCIUS CALPURNIUS PISO LICINIANUS, an adopted member of the family, who was named by Galba as his successor to the Empire, and was killed when Otho came to the throne (A.D. 69).

PISSARO, pè'sà'rò', CAMILLE (c.1830—). A French landscape and figure painter and etcher, born in Normandy, and the pupil of Melbye and Corot. He was already well known as a painter of Normandy landscape when the 'Impressionist' movement began, about 1874. He joined the innovators and went with Monet to England, where he was influenced by Turner. For a time he was head of the off-shoot from the 'Impressionists,' called the 'Possibilistes,' but afterwards his style became more general again. Like Monet, he is a painter of sunshine, and by preference sunshine in Normandy, and, like Millet, he is the

painter of the peasant and the field. Afterwards, he also painted the boulevards and the Parisians, always bathed in light and fresh with vibrant color. His works in the Luxembourg include "Les toits rouges," "Potagers," "Chemin montant à travers champs," "La brouette," "La moisson," "Cheminus sous bois," and "Le lavoir."

PISSELEU, pès'lè', ANNE DE, Duchess d'Estampes (or Etampes). See ESTAMPES.

PISTACHE, pîs-tâsh'. A genus of trees. See PISTACIA.

PISTACIA (Lat., from Gk. *πιστάκη*, *pistakê*, pistachio-tree, from Pers. *pistâ*, pistachio-nut). A genus of trees of the natural order Anacardiaceæ, having dioecious flowers without petals and a dry drupe with a bony stone which splits into two valves when ripe, exposing the bright green oleaginous kernel, which is used to flavor culinary preparations, ices, etc. The pistacia or pistachio tree (*Pistacia vera*), a native of Persia and Syria, but now cultivated in Southern Europe and Northern Africa, and in many places naturalized, attains a height of about 20 feet, has pinnate leaves, flowers in racemes, ovate fruit about the size of an olive. In the south of Europe and in the East, pistachio-nuts, sometimes



PISTACHIO-NUTS (*Pistacia*).

called green almonds, are much esteemed, and are exported to some extent, although they very readily become rancid. Oil is expressed from them for culinary and other uses. In cultivation one male tree is allowed to five or six fertile ones. The mastic tree, or lentisk (*Pistacia lentiscus*), yields the gum resin called mastic (q.v.). It is a native of the countries around the Mediterranean. The turpentine tree (*Pistacia terebinthus*) yields the turpentine (q.v.) known in commerce as Cyprus turpentine, Chian turpentine, or Scio turpentine, which resembles honey in consistency, is greenish yellow, pleasant-smelling and mild-tasting, and in its properties resembles the turpentine of the pines, but lacks acidity. The tree is about 30 or 35 feet in height, has pinnate leaves, of about three pairs of leaflets and an odd one; flowers in compound racemes; and nearly globular fruit. The kernel of the fruit is oleaginous and pleasant. The batoum tree (*Pistacia atlantica*), a round-headed tree of about 40 feet in height, a native of the north of Africa, produces a fruit much used by the Arabs, and a gum resin of pleasant aromatic smell and agreeable taste. This is chewed to clean the teeth and sweeten the breath. The fragrant oil of the kernels of *Pistacia olcosa*, a

native of Cochin-China, is used by the people of that country to impart a perfume to ointments.

PISTIL (from Lat. *pestellum*, *pestillus*, pestle). The central organ of an ordinary flower, containing the ovules, and developing into the seed-case. See FLOWER.

PISTOIA, pè-stō'yà, or **PISTOJA**. A city in the Province of Florence, Italy, situated at the foot of the Apennines, 20 miles northwest of Florence by rail (Map: Italy, E 4). It is well built, and it is surrounded by lofty and well-preserved walls. The city played a prominent part in the early history of architecture and sculpture, and many of its churches bear marks of the influence of the Pisani. The cathedral, built in the twelfth and thirteenth centuries, contains a remarkable silver altar and a monument to Cardinal Portogruerra, considered as the first work in marble by Verrocchio. Sant' Andrea, one of the oldest churches of Pistoia, is noted for its pulpit, the work of Giovanni Pisano, and San Francesco al Prato is remarkable for its frescoes of biblical scenes. The ancient palaces of Pistoia are especially interesting. The Ospedale del Ceppo is beautifully decorated with terracotta reliefs (dating from the sixteenth century) and medallions representing biblical scenes. The Palazzo del Comune and the Palazzo Pretoria are both in the Italian-Gothic style of the fourteenth century. There are an imposing bishop's palace, a seminary, an academy of sciences, and two libraries. The principal manufactures are iron and steel wares, especially fire-arms, silks, linens, woollens, paper, and glass. Pistols are said to have been first made here, whence the name. Population (commune) in 1881, 51,552; in 1901, 62,606.

Pistoia is the Roman *Pistoria* where Catinus was defeated in B.C. 62. It was the scene of much factional strife between the Ghibellines and the Guelphs. In the fourteenth century it became subject to Florence.

PISTOL (OF. *pistole*, from It. *pistola*, pistol, dagger, from *Pistoia*, from Lat. *Pistoria*, a town in Italy, near Florence). This member of the small-arms group was developed soon after the invention of the wheel-lock, in the desire to supply horse soldiers with a firearm. The result was a weapon called the pistol, which was first manufactured at Pistoria, in Etruria, about 1540, by Camillo Vettori. At their first appearance they were distinguished by very short barrels, and heavy, clumsy butts, which, surmounted by enormous caps, were very nearly at right angles with the barrel. It was not long, however, before the butts were lengthened out almost in a line with the barrels. The great majority of the pistols used in the sixteenth and seventeenth centuries were fitted with wheel-locks, for which they were best adapted. *Daggs* was the name of a peculiar and heavy pistol in common use toward the middle of the seventeenth century. German manufactured pistols of the wheel-lock type had also been adopted by many of the important cavalry corps of continental Europe, foremost among whom were the *Ritters* of Prussia. (See CAVALRY.) It is to dueling, however, that the pistol is indebted for nearly all the improvements since made in its effectiveness; for while occasional slight alterations have been made in the general pattern, the exterior appearance and method of handling the dueling

pistol of the nineteenth century was practically identical with that of the eighteenth. For military and sporting purposes, the pistol has experienced many strange shapes and designs during its evolution into the modern revolver. The earliest type seems to have been an arquebus with four chambers, a specimen of which is in the Tower of London Armory, and which is said to have been the personal property of Henry VIII. It belongs to the early part of the sixteenth century and has a barrel 2 feet 9 inches long, and the chamber 7½ inches, the bore being about ½ inch. There is a separate flash pan for every chamber, which is covered with a gliding lid and moved in rotation underneath the serpentine. The barrel, which is secured to the spindle, is strengthened by a rod fastened to its top, and the other extremity fixed to the butt of the gun. The lock consisted of a serpentine, passing through the stock and secured by a pivot. The serpentine extended below and behind the pivot, and thus formed a trigger, which on being pressed allowed the serpentine to fall into the flash pan, the weight of the trigger acting as a balance, and restoring it to its original position. In every instance the chamber had to be moved round by hand. Devices for the combination of firearms with some other form of weapon have been frequent from the days of the first discovery of firearms up to the beginning of the twentieth century.

The combination most frequently used has been the pistol and battle-axe, examples of which in the fifteenth century are not uncommon. The Dresden Museum is especially rich in examples of these and similar weapons. Combinations of pistols and daggers were also frequently met with between the fifteenth and eighteenth centuries; since then and up to the present day, inventions are constantly being recorded which have the same principle for their base. In 1896 a patent for a combined dagger and pistol was issued from the English Patent Office, and about the same time a pistol-lance was being advocated in both Russia and Germany, as an essentially effective cavalry weapon. The invention of the revolver, which is discussed under its own head, caused the pistol to be used principally for dueling and target shooting, and excellent weapons were made for these purposes. The revolver with its six or seven shots served as an important, valuable military weapon on account of its effectiveness at close range, but at the beginning of the twentieth century the indications were that the automatic pistol would replace the revolver for war purposes. Many of the British officers in the Boer War of 1899-1902 were equipped with automatic pistols, while in countries like Germany, where the officers' equipment is supplied by the Government, a self-loading pistol is rapidly taking the place of the revolver. The four best known types are the *Mausers*, the *Burchardt-Lugers*, the *Colts*, and the *Mannlicher*. Probably the best European example is the Burchardt-Luger, operated by the utilization of the gas arising from its discharge, which is made to operate the mechanism, open the breech, extract and expel the cartridge, reloading and reclosing the breech for a new discharge. The firer merely replenishes the mechanism when necessary, and pulls the trigger. It is capable of firing 103 shots per minute, or 48 in 28 seconds. It is of 7.65 millimeters (0.301 inch) in calibre, and

PISTOLS AND REVOLVERS

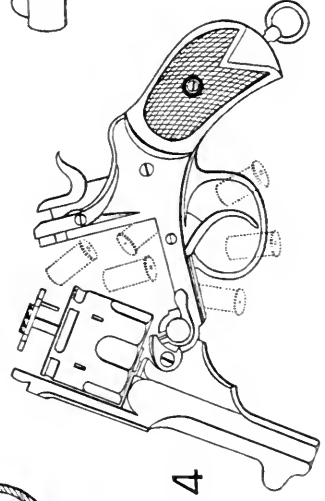
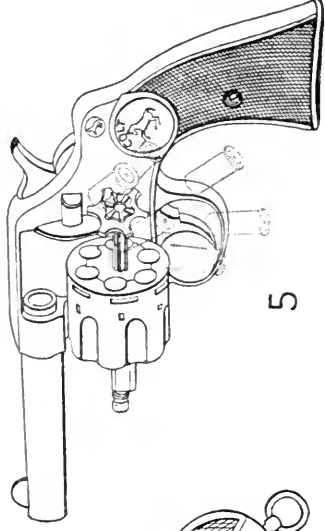
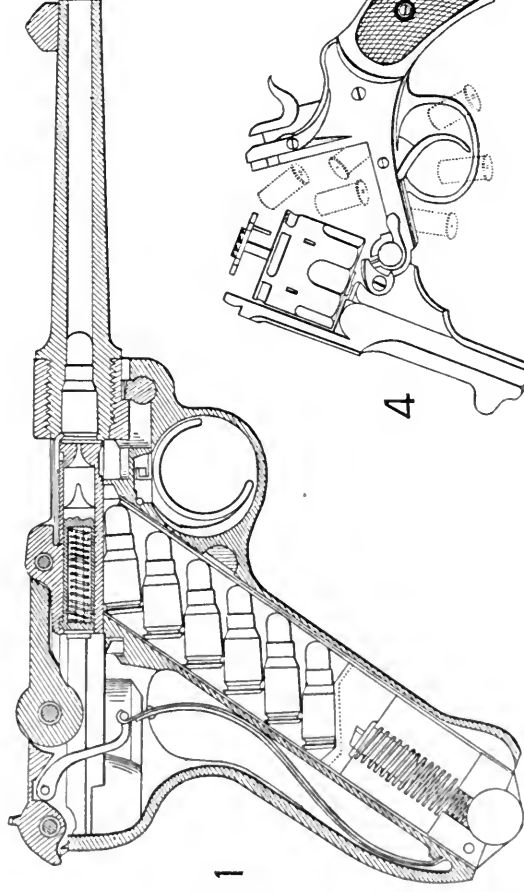
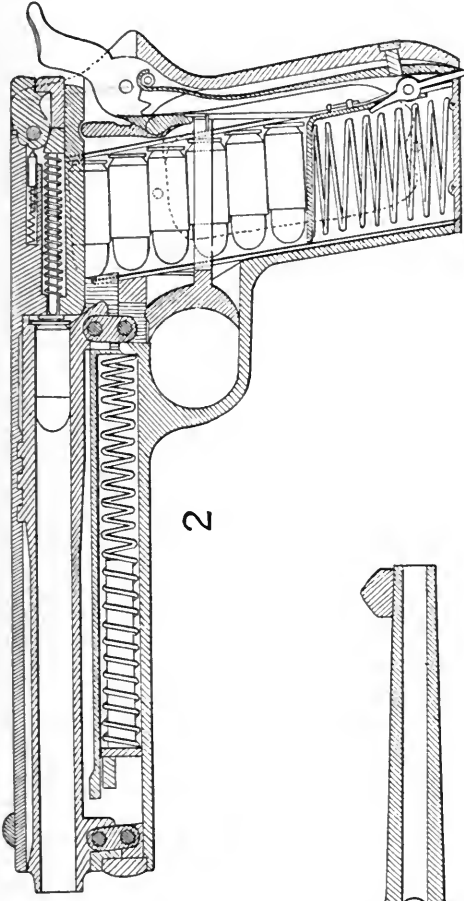
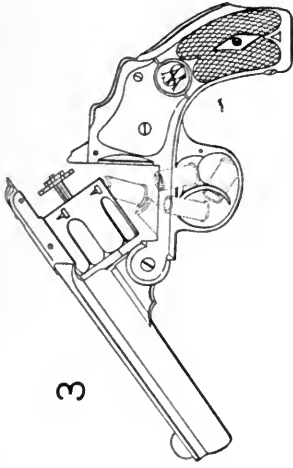

1. BORCHARDT-LUGER AUTOMATIC PISTOL
2. COLT AUTOMATIC PISTOL

3. SMITH AND WESSON ARMY REVOLVER
4. WEBLEY, MARK IV, ARMY REVOLVER
5. WEBLEY, MARK IV, ARMY REVOLVER

has a length of barrel of 120 millimeters. At the moment of firing the gas, acting on the base of the cartridge case, forces back the barrel and breech casing, causing them to slide along the grooves of the frame. The detachable breech follows the movement, but both breech and barrel are firmly connected. The cartridge case, which is operated by the extractor, strikes against the ejector projecting out on the interior right wall of the breech casing and is expelled, thus making way for the top cartridge of the magazine, which is forced in front of the cylinder by an interior spring. A double spring compressed by the recoil forces the detachable breech sharply forward. The trigger is pressed, the firing pin released, and the cartridge exploded. When the magazine is exhausted, the lug of the magazine presses a separate spring projecting in the frame and catching in the notch of the cylinder. At the same time the breech, instead of moving forward, is held in an elevated position in the rear. The line of sight being concealed, the firer is made aware that his weapon is empty. The pistol is recharged with a fresh magazine, which is inserted in the butt, an operation which may be instantly performed, and as the weapon may be kept in use for a considerable time without cleaning, this constitutes one of its greatest values. The most important American invention is the *Colt automatic pistol*, invented by J. M. Browning. It consists of three principal parts: the *frame*, the *barrel*, and the *sliding cover*. In the first are contained the trigger, the hammer, mainspring, and magazine; the *barrel* is secured to the frame by two strong links; and the *sliding cover* works in grooves on the sides of the frame, and, in the firing position, is locked to the barrel by three ribs, the tops of the latter fitting into corresponding grooves in the slide. Its calibre is 0.38 inch. The magazine is a metal slide which is loaded into the stock of the pistol from below and held in like position by clips, so that, like the Burchardt-Luger pistol, it may be instantly loaded. To load the chamber and make ready to fire, the slide is held with the thumb and the forefinger of the right hand, the pistol being held in the left hand. The slide is drawn back smartly, a movement which cocks the hammer, while the return action forces the uppermost cartridge of the magazine forward into the chamber and closes the breech. It has a safety device known as the firing-pin lock, which is also a rear-sight and must be raised. This device being raised and one cartridge discharged, the force of the powder gases causes the slide and barrel to recoil together about two-tenths of an inch until the barrel is stopped, forced downward by the two links already mentioned, and unlocked from the sliding cover. The slide, still moving upward, cocks the hammer, ejects the empty shell sideways, and compresses the recoil spring. The moment it arises at its rearmost position the slide is forced forward by means of a recoil spring, and, encountering the second cartridge on its way, carries it forward into the chamber of the barrel, the latter part of its motion carrying the barrel forward and upward. After this the slide engages automatically with the barrel, and the weapon is ready for the next shot. See the article REVOLVER for descriptions of modern revolvers and pistols; and SMALL ARMS for automatic and other firearms.

PISTOL. A character in Shakespeare's *Henry IV.*, *Henry V.*, and *Merry Wives of Windsor*, a braggart and blusterer, the follower of Falstaff and husband of Dame Quickly.

PISUM. The generic name of the pea (q.v.).

PITAKA, pī'tā-kā (Pali, basket). Any one of the three divisions of the Buddhist Scriptures. The three pitakas, collectively termed *tipitaka* or *pīṭakattaya*, 'basket-triad,' are the *Vinaya-pīṭaka*, or Basket of Discipline, the *Suttapīṭaka*, or Basket of Discourses, and the *Abhidhamma-pīṭaka*, or Basket of Metaphysics. The *Vinaya-pīṭaka* is composed of five works, the *Bhikkhuvibhanga* (Monk's Division), *Bhikkhuni-Vibhanga* (Nun's Division), *Mahāvagga* (Great Chapter), *Culla-Vagga* (Little Chapter), and *Parivāra-Pāṭha* (Concluding Text). While much of this is dry and technical, it has many passages of interest. The *Sutta-Pīṭaka* is the most important of the three for the philosophy and folklore of Buddhism. It is composed of the following five books: *Digha-Nikāya* (Long Collection), *Majjhima-Nikāya* (Medium Collection), *Saṃyutta-Nikāya* (Connected Collection), *Anguttara-Nikāya* (Add-One Collection), and *Khuddaka-Nikāya* (Little Collection), which is subdivided into fifteen parts, *Khuddaka-Pāṭha* (Little Text), *Dhammapada* (Religious Sentences), *Udāna* (Out-Breathing), *Itivuttaka* (Thus Said), *Sutta-Nipāta* (Descent of Aphorisms), *Vimāna-Vatthu* (Palace-Stories), *Peta-Vatthu* (Ghost-Stories), *Thēra-Gāthā* (Stanzas of the elders), *Thēri-Gāthā* (Stanzas of the Female Elders), *Jātaka* (Birth-Stories), *Niddōsa* (Exposition), *Paṭisambhīdā-Magga* (Way of Analysis), *Apadāna* (Achievement), *Buddha-Vanisa* (Lineage of the Buddha), and *Cariya-Pīṭaka* (Basket of Conduct). The last pitaka is of all the least interesting. It is composed of seven books, *Dhamma-Saṅganī* (Enumeration of Duties), *Vibhanga* (Division), *Kathā-Vatthu* (Subject of Discourse), *Puggala-Paṇṇatti* (Manifestation of Persons), *Dhātu-Kathā* (Discussion of Elements), *Yamaka* (Two-fold), and *Paṭṭhāna* (Cause). Consult Warren, *Buddhism in Translations* (Cambridge, Mass., 1896).

PITAVAL, pē'tā'vāl', FRANÇOIS GAYOT DE (1673-1743). A French legal writer. He entered the army, but afterwards studied jurisprudence, and in 1713 became an advocate at Paris. He is chiefly known for the compilation of *Causes célèbres et intéressantes* (20 vols., 1734-43). From him a similar collection, begun by Hitzig and Häring at Leipzig in 1842, took the name *Der neue Pitaval* (2d ed., 36 vols., 1857-72; new series, 24 vols., 1866-91).

PITCAIRN, JOHN (c.1740-75). A British soldier born in Fifeshire, Scotland. He entered the marine service and became captain in January, 1765, and major in April, 1771. For seven years he was stationed in Boston, and won the respect of the citizens. He was sent by General Gage to destroy the military stores collected at Concord, April 19, 1775. The minutemen at Lexington, refusing to disperse at his order, were fired upon and seven were killed. Major Pitcairn maintained until his death that the soldiers fired after the colonists. In the battle of Bunker Hill, June 17th, he was first in the third and fourth charges, and was mortally wounded by a negro soldier. His widow was allowed a pension of

£200 by the British Government, and his son, DAVID, became a distinguished surgeon.

PITCAIRN ISLAND. One of the most easterly of the Polynesian islands, and the southernmost member of the Low Archipelago. It lies in the Pacific Ocean, in latitude $25^{\circ} 3'$ S. and longitude $130^{\circ} 18' W.$, is about 2 miles long and 1 mile broad, and consists of a mountain surrounded by coral reefs. Pitcairn was discovered by Carteret in 1767, but remained uninhabited till 1790, when it was settled by a company consisting of nine mutineers from H. M. S. *Bounty* (see Blich, William), and 18 natives from Tahiti—6 men and 12 women. During the ten years following their settlement the island was a scene of disorder and lawlessness. In the year 1808 the sole survivors of the original settlers were one Englishman by the name of John Adams (formerly Alexander Smith), 8 or 9 women, and several children, the rest having fallen victims to disease and violence. The elements of disorder having been removed, the island began to grow under the wise management of Adams. In 1808 Pitcairn was visited by an American sealing ship, and in 1815 by H.M.S. *Britain*, whose captain was very favorably impressed with the peace and good order prevailing on the island. In 1839 it was formally taken possession of for the British Crown, and in 1855, when the number of inhabitants had reached 200, which was more than the island could maintain, they petitioned the British Government to be removed to Norfolk Island (q.v.), which was done in the following year. Since then some of them have returned to Pitcairn, whose present population is about 125. Consult: Murray, *Pitcairn Island* (London, 1885); Barrow, *Mutiny of the Bounty* (London, 1831); Brodie, *Pitcairn's Island* (London, 1850).

PITCH (assimilated form of *pick*, AS. *pician*, Ger. *picken*, to pick; connected with Eng. *pipe*). That characteristic of a sound which is determined by the rapidity of the vibrations producing it. In music there are two kinds of pitch, *absolute pitch*, which is the position of a tone considered in reference to the whole range of musical tones, and *relative pitch*, which is its position as compared with some other single tone. In ascertaining the relative pitch of a tone, C is considered the standard or starting tone, and the pitch of the tone in question is found by progressing from C either by skips of perfect fifths (quints) or by skips of major thirds (tierces). Tones determined by the former method are called *quint tones*, those found by the latter *tierce tones*. Relative pitch is, however, practically never used except for scientific purposes, since the difference in pitch between every tierce tone and its corresponding quint must be carefully calculated. For ordinary purposes the musical scale is divided into a series of octaves, to represent the absolute pitch of the notes. The absolute pitch of any tone is dependent upon the number of vibrations taking place in a second. Each musical sound is produced by a series of vibrations recurring on the ear at precisely equal intervals; the greater the number of vibrations in a given time the more acute or higher is the pitch. In stringed instruments the pitch is dependent upon the length, thickness, and degree of tension of the strings; the shorter and thinner a string is the greater its tension and the higher the pitch of the note. In wind instruments, where the

notes are produced by the vibration of a column of air, the pitch is dependent upon the length of the column set in motion; the shorter the column of air the higher the pitch becomes. The lowest tone used in music (C¹) is given by the largest-pipes of modern organs and has sixteen and one-half vibrations per second; but this tone is so unmusical that it is used only in conjunction with its overtones. The practicable range of musical tones is from C² (32 vibrations per second) to C⁴ (4096 vibrations per second). The note C² is the basis of modern pitch, and the history of pitch is a chronicle of the variations in the number of vibrations per second which have been assigned to that note; for, strange to say, there is no absolute standard of pitch. We have no record of what pitch was used early in the history of modern music, but at the time of Guido d'Arezzo (q.v.) the treble C seems to have had somewhere around 500 vibrations per second. Our first exact idea of pitch is gained from the sizes of organ pipes which were in use in the sixteenth century, and from these we find that it differed considerably according to localities. Different pitches were also used for secular and sacred music. Early in the seventeenth century, however, a 'mean' pitch was introduced, and for about two centuries this was an approximately standard pitch, since C only varied during that time from 498 to 515 vibrations a second. This is the so-called *classic pitch*, for it was during this period that the great masters of music lived. But with the growth of the orchestra and the increased importance of wind instruments, the pitch was gradually raised in order to obtain more sonorous effects; and various efforts were made to counterbalance the difficulties involved by a varying scale of pitch. In 1834 a congress of physicists at Stuttgart adopted *Scheibler's pitch* (true C-528). In 1859 a French commission of musicians and scientists reported in favor of C-522. This is the widely used *French pitch*. In 1887 it was formally adopted by the Vienna Congress, and is now often called *International pitch*. *Philosophical pitch* (C-512) is used considerably in theoretical calculations. *Concert pitch* was a high pitch of about C-540, much used in concert and operatic work during the middle of the nineteenth century. See **ACOUSTICS; MUSIC**; and consult Ellis, *The History of Musical Pitch* (London, 1880).

PITCH. See **TAR.**

PITCH AND HITCH. An indoor game played by teams of five on each side, with disks of galvanized metal $2\frac{3}{8}$ inches, in diameter, which are pitched from a distance of 10 yards into a receiver, a round rubber cup placed on the floor, having an opening at the top 5 inches in diameter. If the disk goes into and remains in the receiver it counts 1 point to the pitcher; if it goes in and springs out again, it counts 10 points. If on the pitch it falls outside the receiver, it does not count at all. The disks outside the receiver have to be picked up by pressing over them an inverted rubber cap fixed at the end of a rod. If any disk in transit falls out of the rubber cup, it counts 1 against the player for each fall. Each player pitches 12 disks in each of the innings comprised in the game. There are senior and junior leagues of clubs playing the game, with headquarters in Brooklyn.

PITCHBLENDE. The common name for the mineral uraninite (q.v.).

PITCHER, THOMAS GAMBLE (1824-95). An American soldier, born at Rockport, Ind. He graduated at West Point in 1845, and was assigned to the infantry. During the Mexican War he won the brevet of first lieutenant. He was promoted to be captain in 1858, and during the Civil War participated in the defense of Harper's Ferry (June, 1862), and the Virginia campaign of the same year, until the battle of Cedar Mountain (August 9, 1862), where he was severely wounded. For his gallantry on this occasion he was brevetted major in the Regular Army. Three months later he was commissioned brigadier-general of volunteers, but saw no further active service. On March 13, 1865, he was brevetted lieutenant-colonel, colonel, and brigadier-general in the Regular Army, for gallant and meritorious services during the war, and on July 28, 1866, was commissioned colonel of the Forty-fourth Infantry. From 1866 to 1870 he was superintendent of the United States Military Academy, and from 1870 until 1877 was governor of the Soldiers' Home near Washington. The next year he retired from the service, and from 1880 until 1887 was superintendent of the New York Soldiers' and Sailors' Home.

PITCHER PLANT. A plant whose leaves are modified so as to form pitchers, as in *Sarracenia*. See CARNIVOROUS PLANTS; NEPENTHES.

PITCHSTONE. An igneous rock of glassy or lithoidal texture, rich in contained water. To this abundance of water in their composition pitchstones owe their lustre, from which they receive their name. The term pitchstone is not used to indicate any particular composition of rock, but rather to designate a texture which may occur with rocks of any chemical composition, though it is developed in larger masses in the case of magmas of siliceous composition. From obsidian pitchstone differs in containing much water, while obsidian (q.v.) is nearly or quite water-free. The most remarkable pitchstones occur upon the island of Arran, Hebrides, and near Meissen, Saxony.

PITCHURIM BEAN. The seed of a tropical tree. See GREENHEART.

PITESCI, pē-tēsht'y'. A town of Rumania, situated on the main railroad, 65 miles northwest of Bucharest (Map: Rumania, E 2). It has some trade. Population, in 1899, 15,570.

PITH (AS. *pīpa*, pith). The central cylinder of soft tissues (parenchyma) inclosed by the woody cylinder of dicotyledonous and gymnospermous plants. It frequently dies, decays, and leaves the stems hollow, as in the elder.

PITHECAN'THROPUS (Neo-Lat., from Gk. *πίθηκος*, *pithēkos*, ape, monkey + *ἄνθρωπος*, *anthrōpos*, man). An organic genus combining the structural characters of man and the higher apes or monkeys. The type and sole species is *Pithecanthropus erectus*, founded by Eugene Dubois in 1894 on a calvarium (skullcap), two upper molars, and a femur found in marine Pliocene deposits near Trinil, Java, in association with bones of about a dozen extinct mammalian species. The cranium has been discussed critically by more than a score of the world's leading anatomists, of whom about one-fourth

regard it as simian, about one-third as human, and the others (including Baker, Dubois, Gill, Haeckel, Manouvrier, Marsh, Nehring, Pettit, and Verneau) as an intermediate form. All agree that if human it is more ape-like in form and size, and that if simian or pithecoïd it more nearly approaches the human type, than any other known cranium. The capacity is estimated at about, or slightly above, 900 cubic centimeters, that of the largest known anthropoid apes being 500 to 600, that of the Neanderthal skull (as estimated by Huxley) 1236, and the average human cranium running from about 1300 to 1600, with an extreme range of about 1100 to 2200. The teeth combine human and simian characters, while the femur clearly indicates an habitual erect attitude. The genus is of special interest as representative of the 'missing link' much discussed by students of human development during the third quarter of the nineteenth century; indeed, its characters were pre-vised by Haeckel, who in 1886 applied the name *Pithecanthropus* to the still hypothetical form, and by McGee, who in 1892 pointed out that the assumption of the erect attitude was necessarily the first essential step in the development of the human genus from lower forms. Dubois's earlier publications, including *Pithecanthropus erectus, eine menschenähnliche Uebergangsform aus Java*, are not readily accessible; a later paper, read before the Berlin Anthropological Society and printed in the *Anatomischer Anzeiger*, vol. xii., was translated and widely reprinted, in the *Smithsonian Report* for 1898 and elsewhere.

PITHO (Gk. *Πεθώ*). The Greek goddess of persuasion, called by the Romans Suada or Suadela, and considered the daughter of Aphrodite, in whose train she appears with Eros and the Graces.

PITHOM. One of the store-cities which, according to Ex. i. 11, were built by the Israelites during the Egyptian bondage. Through the excavations conducted by Naville in 1883 for the Egypt Exploration Fund, it has been identified with the Egyptian city of Per-Tum, 'Abode of Tum' (Coptic Pethōm), whose site is occupied by the mound of Tell-el-Maskhntah, or 'Hill of the Statue,' so called from a sculpture found there representing Rameses II. standing between the gods Rê-Harmachis and Tum. It is situated in the Wādī Tūmflāt, about 12 miles from Ismailiah, near the railway station Rameses. Pithom seems to have been built by Rameses II. to serve as a base of supplies for his armies operating in Asia, and was strongly fortified. Naville found there the remains of a great quadrangular wall of brick inclosing a space of about 55,000 square yards, within which were the ruins of a temple and a number of chambers constructed for the storage of grain. In later times, especially under the Ptolemies, the city was a place of considerable importance, and it was still in existence at a late date under the Roman Empire. By the Greeks it was called Heroopolis. Consult Naville, *The Store-City of Pithom and the Route of the Exodus*, Memoir I. of the Egypt Exploration Fund (3d ed., London, 1888).

PITKIN, TIMOTHY (1766-1847). An American lawyer, politician, and historian. He was born in Farmington, Conn., graduated at Yale

in 1785, studied law, and was admitted to the bar. He was for five years Speaker of the Lower House of the State Legislature, and was a member of Congress from 1805 to 1819. He is remembered, however, chiefly as the author of *A Statistical View of the Commerce of the United States of America* (1816), and a *Political and Civil History of the United States from 1763 to the Close of Washington's Administration* (2 vols., 1828), both of which are written with great care, and though now largely superseded by other works, are still frequently consulted by students of American history.

PITMAN, BENN (1822—). An American stenographer and artist, born at Trowbridge, Wiltshire, England, the younger brother of Isaac Pitman (q.v.). He came to the United States in 1853, and settled in Cincinnati, Ohio, in the same year. He at first published his brother's shorthand text-books, giving him credit for the system; but in 1857, when Isaac and his co-laborers made certain changes in the system, he refused to adopt them. During the Civil War he did some official reporting for the Government, and afterwards devoted himself to professional reporting until 1873. Pitman's artistic instinct, which had manifested itself in many ways, found distinct expression in 1873, when he became connected with the Cincinnati School of Design as teacher of descriptive art in its various phases, and especially of wood carving. In this latter field he introduced what has since become known as the 'Pitman School of Wood Carving,' which provides for the treatment of naturalistic designs and admits of very beautiful effects in wood sculpture. Although he abandoned his formal connection with the Cincinnati School of Design in 1877, he continued to do more or less art work, and his influence as an artist came to be considerable, particularly throughout the middle West.

PITMAN, CHARLES (1796-1854). An American Methodist minister. He was born near Cookstown, N. J., and entered the Philadelphia Conference in 1818; he had important appointments and served as presiding elder in three districts successively; he was corresponding secretary of the Missionary Society of the Methodist Episcopal Church, 1841-50. He was known as one of the most eloquent preachers of his denomination. Consult Malmsbury, *The Life, Labors, and Sermons of Rev. Charles Pitman* (London, 1887).

PITMAN, SIR ISAAC (1813-97). The inventor of the Pitman system of phonography. He was born at Trowbridge, Wiltshire, England; was educated at the normal college of the British and Foreign School Society of London; in 1832 began to teach a school at Barton-on-Humber, Lincolnshire, and was afterwards master of several other schools. In 1837 he published *Stenographic Sound-hand*, an exposition of the phonographic method, to the improvement and diffusion of which he directed every effort. When the English Government offered a prize of £200 for the best method of collecting the pence for prepaid letters, Pitman submitted a proposal to collect the postage by means of stamps, which should be engraved in small squares of an inch space, and plates to be 20 inches by 12, making 240 squares, the price of which at one penny a stamp would be £1; he also pointed

out the advantage to the public of being able to transmit small sums by means of such stamps. In 1842 he established the weekly *Phonographic Journal*, afterwards named the *Phonetic Journal*, which he edited for more than fifty years. For many years Pitman was greatly interested in the subject of reform in English spelling, and issued a number of pamphlets advocating radical measures. He was knighted in 1894, in recognition of his services to stenography. Consult Reed, *Biography of Isaac Pitman* (New York and London, 1890). For a description of his system, see **SHORTHAND**.

PITO, See **CHICA**.

PITONI, pè-tò'nè, GIUSEPPE OTTAVIO (1657-1743). A composer of the Roman school, born at Rieti. He was a pupil of the famous Pompeo Natale at Rome, and afterwards studied counterpoint under Foggia. Throughout his life he was connected in various musical capacities with most of the important churches of Italy, and at the time of his death was church *maestro* of San Marco, Rome. Most of his compositions have remained in manuscript and have been carefully treasured by the churches to which they belong. During his lifetime only one book of motets (1697) was printed. One of his most famous compositions is a *Dixit* arranged for sixteen parts, or four choirs, which is sung annually during Holy Week in Saint Peter's, Rome. He died in Rome.

PITRA, pè'trà', JEAN BAPTISTE (1812-89). A French ecclesiastic and author, born near Autun. He taught rhetoric in the seminary at Autun before he became a Benedictine monk at Solesmes. He was made cardinal in 1863 and librarian at the Vatican six years afterwards. His writings include: *Vie de Saint Léger* (1846); *Spicilegium Solesmense* (1852-60); *Hymnographie de l'église grecque* (1867); *Juris Ecclesiastici Græcorum Historia et Monumenta* (1864-68); and *Triodon Katanaction* (1879).

PITRÉ, pè'trà', GIUSEPPE (1843—). An Italian folklore scholar, born at Palermo. He was educated at Palermo and made a special study of the antiquities, traditions, dialects, and national songs of his native land, and was one of the founders of the *Nuove Effemeridi Siciliane* (1868). Besides his contributions to French and Italian reviews, he published *Biblioteca delle tradizioni popolari siciliane* (19 vols., 1870-95); *Curiosità popolari tradizionali* (10 vols., 1885-91); and *Bibliografia delle tradizioni popolari d'Italia* (1894).

PITRI, pit'rè (Skt. *pitṛ*, father). A term in Hindu religion applied to three classes of divine beings. In the Rig-Veda the pitris are the souls of the righteous dead who dwell with Yama (q.v.), and to whom sacred balls of rice and flour together with water are duly offered. (See **SRADDHĀ**.) In the Atharva-Veda they are divided into higher and lower classes, the older manes being in general the more venerated and blessed. After the Vedic period the pitris lose their importance as distinct objects of cult, although sacrifices are still offered to them in India. In its second usage, the term is applied to the ten Prajapatis or progenitors of mankind. (See **PRĀJAPĀTI**.) In the later Hindu period, however, the pitris denoted a much larger class of semi-divine beings. Manu (q.v.) enumerates various classes of pitris, those who were the

ancestors of the gods, those who were the ancestors of the demons, and those from whom the four castes proceeded. The Puranas divided the manes generally into seven classes, three of which are without form, or composed of intellectual, not elementary substance, and assume what forms they please, while the four other classes are corporeal.

PIT RIVER INDIANS. A group of small tribes, at present supposed to constitute a distinct linguistic stock, which Hale in 1846 designated as the Palaihnihan, occupying the volcanic mountainous region along Pit River, a head stream of the Sacramento, in northeastern California. From their custom, not known among other California tribes, of digging deep pitfalls for trapping deer, the river is said to obtain its name. The pitfalls, which were dug along deer trails and at watering places on the river, caused so many losses of cattle to the early settlers that the Indians were finally compelled to abandon the practice. The northern tribes of the group were of very low type, mentally and physically, due largely to the thinning out of the best specimens by the constant raids of the slave-hunting Modoc, but those lower down the stream were much superior, and were extremely warlike and hostile until crushed by General Crook. The position of woman was very low. When twins were born one was usually destroyed. Notwithstanding all this, they had strong affections and were extremely kind to the helpless. Cremation was the most common funeral method. They number now about 1100, of whom a few families are on Round Valley reservation, California, whither they were deported after one of the early wars; 80 persons, former captives and slaves of the Modoc, are on Klamath reservation, Oregon; and the main body, about 1000 in number, are still roaming about Pit River, having never come under agency control.

PITSCOTTIE, ROBERT LINDSAY OF (c.1500-65). A Scottish chronicler, born at Pitscottie, Ceres Parish, Fife. Connected with the noble family of Lindsays, he was a landowner in his native place, and chiefly is remembered for his *Chronicles of Scotland*, which cover a little-known period—the reigns of James II. and III. Their value rests not in accuracy, but in picturesqueness of style and dialect, and in the description of people and events, which are interesting, if not accurate. Sir Walter Scott in *Marmion*, and Mrs. Oliphant in *Royal Edinburgh* (1891), are indebted to Pitscottie's *History*, which was first printed in 1728, and a better edition of which was prepared by G. Dalrymple in two volumes in 1814.

PI-TSI. A tuber-bearing plant. See SCIRPUS.

PITT, WILLIAM, first Earl of Chatham (1708-78). A famous English statesman, often referred to as the elder Pitt. He was born in Westminster on November 15, 1708, and was educated at Eton and Trinity College, Oxford, but he never took a degree, for he was afflicted with gout from an early age, and was advised to travel, which he did for a short time. Nevertheless the disease never left him, and throughout life it remained a very serious hindrance. In 1731 he became a cornet in the army, and in 1735 entered Parliament for Old Sarum, the typical example of the 'rotten' boroughs. Soon after entering Parliament he was dismissed from

the army for supporting Frederick, Prince of Wales, in his course of opposition to King George II., and his biting satire made him also very obnoxious to the powerful minister, Robert Walpole. Almost from the very beginning Pitt was a power among the Commons on account of his oratorical abilities, and he contributed much to bringing about the downfall of Walpole in 1742. Thereafter he opposed the foreign policy of Carteret, especially the practice of paying subsidies to the Continental powers. His policy became very popular among the people; the Duchess of Marlborough left him in 1744 a legacy of £10,000, and in 1765 Sir William Pynsent, an eccentric gentleman, struck also with admiration for Pitt's patriotism, left him his whole estate. Late in 1744 some of Pitt's associates obtained seats in the Cabinet of Pelham, but the King had not yet forgiven Pitt. In 1746 the Government resigned, but shortly resumed power, and Pitt was appointed joint Vice-Treasurer of Ireland, and in the same year he was given the lucrative office of paymaster-general of the forces, and became a member of the Privy Council. At this time he received great praise for declining the special emoluments which usually went with the position of paymaster-general. In 1755, when Henry Fox (afterwards Lord Holland) was made Secretary of State, Pitt vigorously opposed the foreign policy of the Newcastle Cabinet, and as a consequence he was dismissed from office. Meanwhile the Seven Years' War (q.v.) had begun, and though Frederick the Great (q.v.) was gaining victories on the Continent, the English campaigns in America and elsewhere were unsuccessful. Hence in 1756 the King had to call upon Pitt, who had become the popular idol, to carry on the Government. A new Cabinet was formed of which the Duke of Devonshire was the nominal Prime Minister, but all real power was vested in Pitt. The latter immediately began vigorous measures to carry on the war, but the King did not give him loyal support and finally dismissed him on April 6, 1757. He had, however, to recall him almost immediately in response to the demands of the nation, and Pitt was given full control of foreign and military affairs.

Pitt's war policy was characterized by unusual vigor and sagacity. French armies were defeated everywhere—in India, in Africa, in Canada, on the Rhine—and French fleets disappeared from the seas. Pitt was practically absolute ruler of Britain, and the populace bestowed on him the title of the 'Great Commoner.' A change came, however, with the accession of George III. in 1760. Pitt was forced to take Lord Bute into the Cabinet, and was finally compelled to resign on October 5, 1761. As some recompense for his important services, Pitt received a pension of £3000 a year, and his wife, sister of George Grenville (q.v.), was given the title of Baroness Chatham. Until 1766 Pitt remained out of office, occasionally employing his eloquence to defeat obnoxious measures of the Government, and he opposed vigorously the various acts to tax the American colonists. On July 30, 1776, Pitt succeeded in forming a new Ministry to succeed the Rockingham Cabinet, and, as his health was very poor, he took the sinecure office of Privy Seal, and was created Viscount Pitt and Earl of Chatham. His acceptance of the peerage was very unpopular, and he also lost considerable influence, because

his impassioned eloquence was unable to move such a small body of men as were accustomed to attend the House of Lords. Ill health prevented Chatham from taking an active part in the Ministry, of which he was nominally the head, and he resigned on October 14, 1768, never to hold office again.

Chatham, however, did not cease to take an interest in public affairs. He spoke strongly against the arbitrary and harsh policy of the Government of Lord North toward the American colonies, and did his utmost to procure an amicable settlement of the differences, declaring that "England had no right under heaven to tax the colonists." But when America entered into a treaty with France, and it was proposed to remove the Ministers and make peace on any terms, Chatham, though in a dying state, appeared in the House of Lords, and in a powerful address protested against the disruption of the Empire and the implied prostration of Great Britain before France. It was the orator's last effort; exhausted by speaking, on rising again to reply to a query addressed to him, he suddenly fell back into the arms of his friends. He died a few days later, May 11, 1778. He was honored with a public funeral in Westminster Abbey, where a statue was erected to his memory at the public expense. In addition, the Government gave £20,000 to pay his debts, and conferred a pension of £4000 a year on his descendants.

Pitt's appearance was dignified and imposing, and added greatly to the attractiveness of his oratory, which was of the most powerful kind. His uprightness and irreproachable character compelled the admiration of his enemies; but his affectation and haughtiness frequently disgusted his friends. He had an intense love of country, his ambition being to make his native land safe against all contingencies.

Macaulay's "Chatham" is a very interesting essay. Consult also: Thackeray, *History of the Earl of Chatham* (2 vols., London, 1827); Cobbett, *Parliamentary History* (London, 1806-20); Horace Walpole, *Letters* (9 vols., London, 1880); id., *Memoirs of the Reign of George II.* (3 vols., London, 1848-51); Green, *William Pitt, Earl of Chatham* (London, 1901); Lecky, *History of England in the Eighteenth Century* (6 vols., 3d ed., London, 1883-90).

PITT, WILLIAM (1759-1806). A celebrated English statesman, often referred to as the younger Pitt to distinguish him from his father, William Pitt, first Earl of Chatham. He was born May 28, 1759, on his father's estate at Hayes. His mother was a sister of the well-known statesman George Grenville (q.v.). Pitt, on account of his delicate health, was educated at first at home, but when fourteen years of age he was matriculated at Pembroke Hall, Cambridge. He graduated in 1776, receiving an M.A., and then studied law, and in 1780 was admitted to the bar. In the same year he was elected to Parliament, taking his seat on January 23, 1781. He immediately joined the party that had followed his father, and hence was in opposition to the Government of Lord North. His maiden speech made a very favorable impression; and when in 1782 Rockingham formed a new Administration, Pitt was offered a well-paying subordinate position, but, though poor, he declined it. He had decided that he would accept nothing except a Cabinet office.

On May 7, 1782, Pitt made his first motion for a reform in the representation to Parliament. The motion was lost by a narrow margin, the vote being 161 against 141. The reformers did not make so good a showing again until 1831. Three months after his accession to office, Rockingham died, and Lord Shelburne became Prime Minister, while Pitt, though only twenty-three years of age, became Chancellor of the Exchequer. The Cabinet was met by a formidable coalition led by Charles James Fox (q.v.) and Lord North, and in 1783 Shelburne resigned. George III. offered Pitt the Premiership, but he declined, as he was not certain of the consistent support of the dominant factors in Parliament. The result was a coalition Ministry under the Duke of Portland, in which Fox and North were the leaders. Pitt on May 7, 1783, again brought forward the question of Parliamentary reform, but, though his plan this time was a definite and well-ordered one, the motion was lost by 293 to 149.

After Parliament had been prorogued Pitt visited the Continent, and was well received. On December 19, 1783, the coalition Ministry was dismissed after the defeat of a bill in the House of Lords, which aimed to transfer the Government of India to Parliament. Thereupon Pitt assumed the Premiership in the face of a powerful opposition in the House of Commons. His position was a desperate one. The House of Commons resented the interference of the King, whose action was of doubtful constitutionality. Between December 17, 1783, and March 8, 1784, Pitt was defeated in 16 divisions. The only recourse was either to resign or to order a new election; but Pitt postponed the election as long as possible. When at last he saw that the current of popular opinion had set in his favor, he dissolved Parliament, and the election proved to be a triumph for his Administration, he himself being returned for the University of Cambridge, for which he sat for the rest of his life.

Pitt was twenty-five years old at this time and the most powerful subject that England had had for generations. He ruled absolutely over the Cabinet, and was at once the favorite of the sovereign, of Parliament, and of the nation; and henceforth his life is identical to a great extent with the history of England. When Parliament met, Pitt's first work was the ordering of the finances, for there had been enormous deficits for many years. In this he was very successful. In 1784 he established a new constitution for the East India Company, the Board of Control being instituted. In 1785 he introduced his third reform bill, providing for the purchase of seventy-two 'rotten boroughs,' but the bill failed to pass, and the outbreak of the French Revolution soon after put an end for many years to serious attempts at Parliamentary reform. Pitt was the first British statesman to attempt to put into practice the principles enunciated in 1776 by Adam Smith. His bill, however, providing for free trade between England and Ireland failed in 1785. In the following year Pitt was successful in negotiating a liberal commercial treaty with France. In 1792 he supported Wilberforce's proposal for the abolition of the slave trade, but he could not carry the House of Commons with him. In the war between France on the one side and Austria and Prussia on the other he maintained strict neutrality so long as he was able, but the Paris massacres

of September, 1792, and the execution of Louis XVI. in January, 1793, so outraged the feelings of the English people that peace could no longer be maintained. In February the French Convention declared war against England. While the English were successful on the sea, Pitt opposed the French on land principally by means of heavy subsidies to his Continental allies, thus inaugurating the system which was followed throughout the Napoleonic wars. In his persistent enmity toward Napoleon he was opposed throughout by his great rival, Fox. While the financial difficulties caused by the outbreak of the war with France were at their height Irish affairs also became very perplexing. Pitt desired to relieve the Catholics of the disabilities under which they were laboring, but George III. compelled him to withdraw all such schemes. In 1800-01 a Parliamentary union with Ireland was effected, but it by no means allayed discontent. In order to relieve some of the financial difficulties of the nation, Pitt created a 'sinking fund,' which at considerable cost maintained the credit of the Government. Meanwhile Napoleon had defeated Austria in Italy, while Russia became neutral, so that England was left to struggle with France alone. In 1801 Pitt resigned because the King refused to accept his Catholic emancipation measures. He loyally supported the new Ministry of Addington in its attempt to make a permanent peace, which resulted in the Treaty of Amiens in 1802. When Pitt was no longer able conscientiously to aid Addington he withdrew from active participation in affairs. His health was poor and his finances were in disorder. On May 16, 1803, war was declared by England against France, and Pitt at once reappeared to aid his country. He criticised the weakness of the Government, and on May 10, 1804, again became Prime Minister. Pitt's vigorous measures resulted in the third great coalition against France, but, though the victory of Trafalgar cheered him the defeat of Austria and her ally, Russia, at Austerlitz on December 2, 1805, proved his death-blow. Shortly before he died he uttered the prophetic words, so well known: "Roll up the map of Europe; it will not be wanted these ten years." He died January 23, 1806, and was buried on February 22d in Westminster Abbey. His work did much to bring about the ultimate downfall of Napoleon, and in many respects Pitt may be considered England's greatest Prime Minister.

BIBLIOGRAPHY. Pitt's *Speeches in the House of Commons* have been published in three volumes (London, 1817); while an account of his parliamentary career is to be found in the *Parliamentary History*, 36 vols. (ib., 1803-10); and in Hansard, *Parliamentary Debates*. Consult also: Macaulay, "William Pitt" (one of the essays); Stanhope, *Life of William Pitt*, (2d ed., London, 1862); which is the best work on this subject; Rosebery, *William Pitt* in "Twelve English Statesmen Series" (ib., 1891); Sergeant, *William Pitt* (ib., 1882); Lecky, *History of England in the Eighteenth Century*, vols. iv. viii. (ib., 1882-90); May, *Constitutional History of England* (ib., 1863-65); Mahan, *Influence of Sea Power Upon the French Revolution, 1793-1812* (ib., 1893).

PITT, WILLIAM (1773-1857). See AMHERST, EARL OF.

PITTA (from Telegu *pitta*, a small bird). One of a group of passerine birds, known as *brèves* by the French. The characteristics are brilliant plumage, a very short tail, long legs, with scutellated tarsi, and, generally, a strong bill. They were long supposed to be allied to the thrushes, and several were called 'ground-thrushes' and 'ant-thrushes' in the books; but they are now understood to be more nearly related to the American flycatchers. Nearly 50 species have been described, inhabiting the Malay archipelago, China, India, and Australia, while one species occurs in western Africa. Their habits are terrestrial chiefly, and they live amid rocks and brush, hunting mollusks and insects among the fallen leaves, or digging for worms and ants. They are shy, quick, and not as often seen as their plaintive, whistling notes are heard. All are small birds of gaudy plumage, which shows such colors as scarlet, blue, and green. They make their nests on the ground and lay spotted eggs. Consult: Newton, *Dictionary of Birds* (London, 1893); Evans, *Birds* (New York, 1901); and authorities on Indian, Malayan and Australian ornithology. See Plate of COTINGAS, etc.

PIT'TACUS (Lat., from Gk. *πιττακός*, *Pittakos*) (c.B.C. 652-569). One of the Seven Wise Men of Greece. He was born at Mitylene in the island of Lesbos, and was a son of Hyrrhadus, a Thracian, and a Mitylenean mother of good family. He is celebrated as a soldier, statesman, philosopher, and poet. About B.C. 612, in conjunction with the brothers of the poet Alcaeus, he overthrew and killed Melanchrus, the despot of Mitylene. A few years later, about 606, he was engaged, at the head of the Mitylenean forces, in fighting the Athenians for the possession of the coast of the Troad near Sigeum. Though neither side was decisively victorious, Pittacus slew with his own hand the Athenian commander Phryno. For his services he would take but a small piece of land, which he dedicated to sacred uses; at a later time it was known as the *Pittacean Land*. On the banishment of Alcaeus, who was the leader of the aristocratic party, Pittacus, as being the most prominent democrat in the city, was in 589 chosen *asymnetes* (*ἀσυμνήτης*) or ruler with absolute power for ten years. As dictator he reestablished security and peace in the state, and enacted various laws. He is said to have died about 569. Of his poetry a few lines only have been preserved by Diogenes Laertius.

PITT DIAMOND. A famous stone, originally weighing 410 carats, now reduced to 136¾ carats, and considered the most brilliant and perfect diamond in existence, being valued at nearly \$2,500,000. It was found in the Parteaal mines of India, and was sold by a sailor to Thomas Pitt, Governor of Fort Saint George and grandfather of the first Earl of Chatham. It was sold in 1717 to the Duke of Orleans and hence received the name of Regent Diamond. During the French Revolution it was pledged in the hands of a Berlin merchant, and was afterward set in the hilt of Napoleon's sword. It is still among the regalia of France. See Plate of DIAMONDS.

PIT'THEUS. The father of Æthar, mother of Theseus. He was king of Troezen and a teacher of oratory.

PITTI PALACE. A celebrated Florentine palace of the Early Renaissance, now used as a royal residence. It is the largest palace except the Vatican in Italy, and one of the most imposing in the world. A typical Florentine palace of the fifteenth century, part fortress, part residence, it became a model for such structures. The imposing character of the façade is due to the use of rough-hewn stone, giving a massive effect, and to the simple and harmonious proportions of the three stories. This effect is heightened by its situation upon a hill on the left bank of the Arno; behind it are the beautiful Boboli Gardens.

The palace was designed in 1440 by Brunelleschi for Luca Pitti, then chief magistrate of the Republic. Brunelleschi lived to complete the first story and after Luca's fall the building was not resumed until the palace was purchased by the ducal family and made their residence. In 1568 Ammanati was employed to make a new design to replace Brunelleschi's lost plan. To him is due the celebrated court of the palace—a rather unfortunate attempt to use rustic work with pilasters. The wings of the façade date from 1620, being an addition to Brunelleschi's more simple plan, and the building was not completed till 1830.

Within the palace, and open to the general public, is one of the most important collections of paintings in the world, although numbering but 500 specimens. It is especially rich in Florentine masters of the fifteenth century, and possesses fine examples of Andrea del Sarto, Giorgione, Titian, Tintoretto, besides six of the very best Raphaels. Other European schools are represented by Dürer, Rembrandt, Rubens, Van Dyck, Murillo, and Velazquez.

PITTSBURG. The metropolis of western Pennsylvania, the second city of the State, and the county seat of Allegheny County. It is situated at the junction of the Allegheny and Monongahela rivers where they unite to form the Ohio, in latitude 40° 32' north and longitude 80° 2' 38" west (Map: Pennsylvania, B 3). It is 275 miles west of New York, 350 miles northeast of Cincinnati, and 450 miles east of Chicago. These distances are in a straight line. The mean average temperature is 53° F., the mean for January being 31° and for July, 75°. The altitude at the river level is 703 feet.

Although eleventh in population, according to the census returns, Pittsburg ranks fifth in commercial and industrial importance among the cities of the United States. This is due to the fact that surrounding the city proper are two other cities—Allegheny and McKeesport—and about fifty boroughs, at least thirty of the latter, as well as both cities, being closely allied with Pittsburg, and, for all business purposes, portions of it. An act of Legislature, approved in April, 1903, provides a method whereby these municipalities may be combined with Pittsburg. The ultimate aim of the bill is to make the city co-extensive with the county, which now has a population of over 800,000. The city proper contains 38 wards and has an area of 28.39 square miles. The original city occupied restricted limits between the Allegheny and Monongahela, but absorption of territory lying to the east greatly enlarged its bounds. A number of boroughs on the south side of the Monongahela River were

annexed in 1872, and are now connected with the old city by four free bridges. Several other boroughs have been since absorbed. Allegheny, which lies across the Allegheny River from Pittsburg, is connected with it by numerous toll bridges.

Pittsburg is the centre of the iron, steel, and glass industries of the United States. It is also the largest shipping point for bituminous coal, upon which its wealth is founded. The Pittsburg coal district, embracing an area of 14,000 square miles, is the richest coal field in the world. It is from the excessive consumption of coal in its mills and furnaces that Pittsburg derives its sobriquet, "The Smoky City." As a manufacturing city Pittsburg is best known, and until recent years it possessed all of the unattractive characteristics of such a community. Recently, however, great progress has been made, and fine streets, splendid boulevards, a system of parks, costly residences, and other evidences of municipal and civic pride have come into existence. In the older portion of the city the streets are narrow, ill arranged, and much congested, owing to the restrictive limits placed upon the district by the rivers. The chief retail streets are Fifth Avenue, Sixth, Wood, and Smithfield streets. Lower Liberty and Penn avenues are largely devoted to wholesale houses. Fourth Avenue is the local Wall Street, and here, as on other principal thoroughfares, are many splendid buildings. The residential portions of the city, being of recent development and less confined by natural boundaries, have wide, well-shaded streets, arranged with some regard for system. The most costly residences are in the Bellefield, Shadyside, East Liberty, and Squirrel Hill districts. Among the finer streets are portions of Fifth and Penn avenues, the chief thoroughfares between the downtown and East End districts; North Highland, Ellsworth, and Center avenues.

The city has about 450 miles of streets, of which 256 miles are paved, principally with asphalt or block stone. There are 323 miles of sewers, including 45 miles of brick. All the streets are covered by city water mains, save those on the South Side, which is supplied by a private company. Natural and artificial gas is piped to all parts of the city. For a decade previous to 1895 natural gas was the principal fuel in the mills and factories, but, owing to a decrease in the supply, the larger factories have been forced to resume the use of coal. Natural gas still forms the favorite fuel for domestic purposes. An extensive system of street railways, operated by electricity, connects the city with the surrounding towns. All the lines in Pittsburg and Allegheny and many of those reaching to the boroughs have been consolidated under one management.

BUILDINGS. Among the prominent public buildings are the Allegheny County court house and jail, erected in 1884 at a cost of \$4,000,000, granite structures facing on Fifth Avenue and connected by a 'Bridge of Sighs' across Ross Street. The post-office building on Smithfield Street is a splendid specimen of architecture. The rooms occupied by the United States Circuit and District courts are finished in mahogany, magnificently carved. The United States Engineer, Collector of Internal Revenue, Surveyor of the Port, and other Federal officials have their offices in this building. Chief among the many

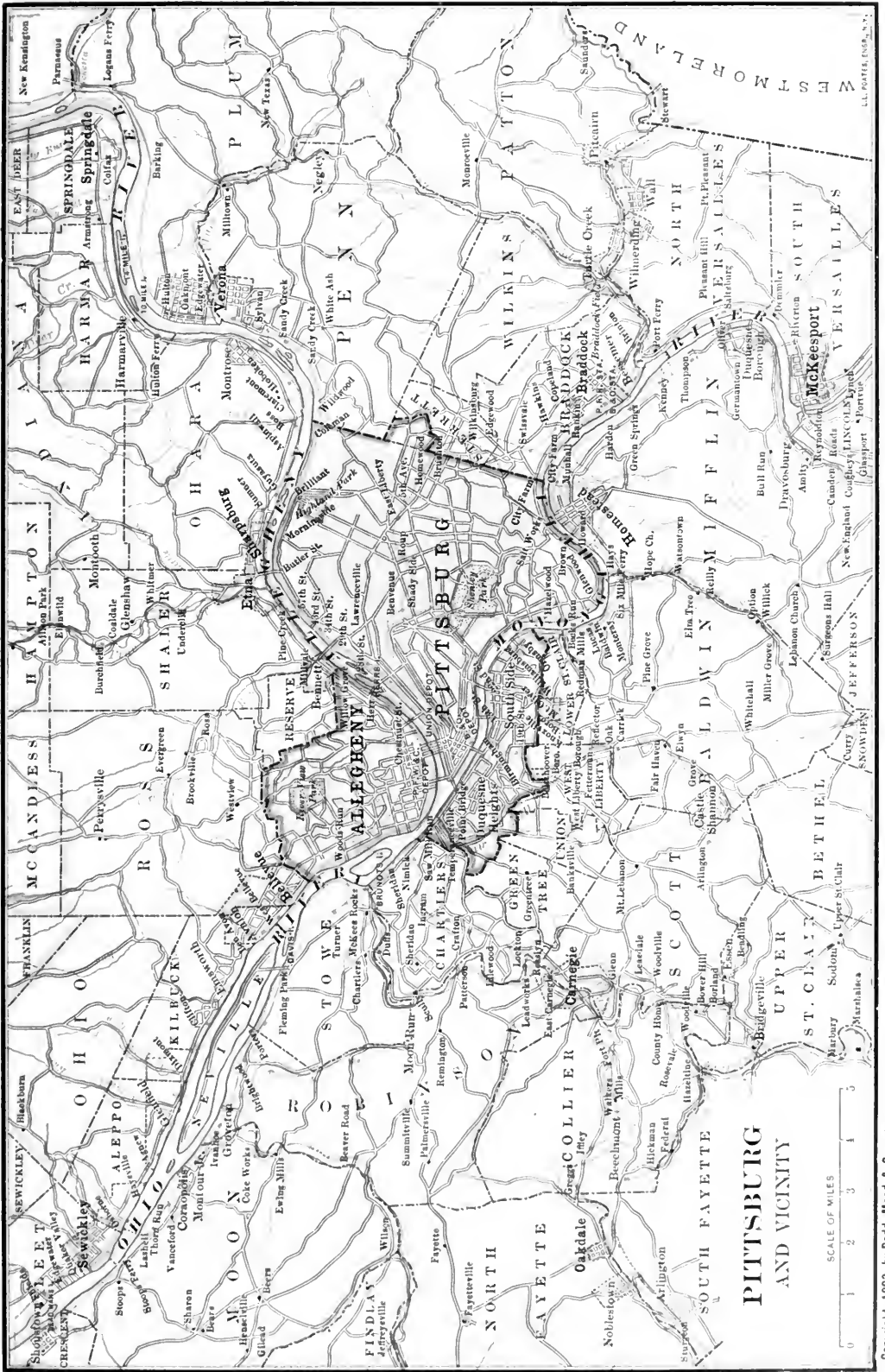



handsome office buildings for which Pittsburg is noted is the Frick Building, at Fifth Avenue and Grant Street. It is of granite, 20 stories high, and finished throughout in marble and mahogany. It is one of the most luxurious public office buildings in the world. The Farmers' Deposit National Bank Building, 24 stories high, is little inferior. Among other handsome edifices of the 'skyscraper' type are the Carnegie, Park, Tradesmen's, Peoples' Bank for Savings, Arrott, and Empire. The Bank of Pittsburg and the Pittsburg Stock Exchange have artistic homes. Among the notable ecclesiastical structures are the new Saint Paul's Cathedral in Bellefield, Trinity Church (Protestant Episcopal), First and Third Presbyterian churches, Church of the Ascension (Protestant Episcopal), East Liberty Presbyterian, Christ Methodist Episcopal, Saint Augustine's (Roman Catholic), Sixth United Presbyterian, and Calvary (Protestant Episcopal). The finest hotels are the Schenley, Lincoln, and Henry.

PARKS. Pittsburg's system of parks originated in 1890, when Mrs Mary E. Schenley deeded to the city more than 400 acres of land in the heart of the residential district. This was named in her honor. Since that time the city has acquired several other tracts of land for park purposes, and the system now includes 1000 acres, all within the city limits. Additions to Schenley Park have increased its size to 440 acres. It contains the Phipps Conservatory and the Hall of Botany, both gifts from Henry Phipps; a music pavilion, several fine bridges, a bronze statue of E. M. Bigelow, the 'Father of the Parks,' a notable pair of panthers in bronze, and three shelter houses. Highland Park, one of the most picturesque parks in the country, has an area of 441 acres. It contains city reservoirs Nos. 1 and 2, zoölogical gardens, the gift of the late C. L. Magee, two shelter houses, and several statues. The principal entrances at Highland and Stanton avenues are graced by handsome sculptures. The other parks, all small, are: Herron Hill, Central, Friendship, Holliday, West End, Grandview, McKinley, and Second Avenue. Connecting Schenley and Highland parks with the downtown district are Grant and Beechwood boulevards, 10½ miles long, and forming, with the roadways in the parks, a continuous drive of more than 20 miles in length.

PUBLIC INSTITUTIONS. Chief among the public institutions of the city are the Carnegie Free Library and the Carnegie Institute, situated at the Forbes Street entrance to Schenley Park. They were presented to the city by Andrew Carnegie. The first tender was made in 1881, but it was not until 1886 that Councils accepted the offer. The building, for which Mr. Carnegie gave \$1,100,000, was completed in 1895. It contains the Central Free Library and the Carnegie Institute, the latter comprising a museum, gallery of fine arts, and music hall. The library and institute are affiliated, but not identical, the former being maintained by the city, while the latter has an endowment of \$2,000,000 from Mr. Carnegie. The city appropriates \$131,000 annually for the maintenance of the central and branch libraries. The central library contains 104,500 volumes, and five branches, in various parts of the city, have an aggregate of 55,500 volumes. In the gallery of fine arts are a permanent collection of 50 paintings, many of which

were bought at the annual exhibitions given there, 19 plaster casts of famous sculptures, and 170 reproductions of antique bronzes. The museum has a large collection of wide scope. In the music hall is a fine pipe organ, and here are given every week two free recitals. The hall is also the home of the Pittsburg Orchestra, which gives a course of concerts each winter. The music hall is self-supporting. The library and institute are to be much enlarged. The city has just acquired the necessary ground, and Mr. Carnegie has placed \$5,000,000 at the disposal of the trustees. The building will cover three and one-half acres.

The Pittsburg Exposition Society occupies a large building between Duquesne Way and the Allegheny River, at the Point. Here a general exposition is held each autumn, lasting for six weeks. The largest general hospital in the city is the West Penn. on Twenty-eighth Street, which has a department for the insane at Dixmont. Other large hospitals are the Mercy, Homeopathic, Saint Margaret's Memorial, Passavant, Charity, South Side, and Eye, Ear, and Throat. All these, save the last named and Saint Margaret's receive State aid. Among the charitable institutions are the Church Home (Protestant Episcopal), Saint Joseph's Protectory for Boys (Roman Catholic), Home for Incurables, Florence Crittenton Home, Home for the Aged (Roman Catholic), Free Dispensary, House of the Merciful Saviour, Saint Paul's Orphan Asylum (Roman Catholic), now located at Idlewood; Old Ladies' Home (United Presbyterian), at Wilkinsburg; Odd Fellows' Home for Widows and Orphans, at Ben Avon. The principal cemeteries are Allegheny, Homewood, and Southside (Protestant), and Saint Mary's and Calvary (Roman Catholic). The smaller burying-grounds are numerous, perhaps the most interesting being that surrounding Trinity Church, Sixth Avenue, where many of the prominent pioneers of the community repose.

EDUCATIONAL INSTITUTIONS. Pittsburg has a well-equipped educational system, which includes 86 ward and three high schools. In 1903 the number of teachers and principals was 1044, and the total enrollment of pupils 40,868. The expenditures for educational purposes were \$1,658,716. The control of the ward schools is vested in district school boards, the districts usually being coextensive with the wards. The Central Board of Education, composed of one representative from each district board, has direct control of the high schools and regulates the preparatory courses of study. Each district makes its own tax levy. The bonded indebtedness of the various school districts in 1903 was \$1,957,000. The Central Board annually appropriates money for kindergartens and summer schools, which are partly supported by civic societies. The private educational institutions of the city include the Pittsburg Academy, Pittsburg College of the Holy Ghost (Roman Catholic), Academy of Our Lady of Mercy (Roman Catholic), for girls, Bishop Bowman Institute (Protestant Episcopal), Pennsylvania College for Women, Shadyside Academy, Kindergarten College, departments of law, medicine, dental surgery, and pharmacy of the Western University of Pennsylvania, Institution for the Blind, and, in the suburb of Edgewood, the Institute

for the Deaf and Dumb; also numerous parochial schools.

In 1901 Andrew Carnegie offered to present to the city a free institute of technology. The offer was accepted, the city agreeing to furnish the site and maintain the school. In 1903 a site, costing \$350,000, was bought near the free library.

COMMERCE AND INDUSTRY. Pittsburg has been since its foundation the natural transfer point between the East and West. It is a port of entry, and its imports for the year ending March 31, 1903, amounted to \$1,504,705. The city's rapid growth, however, is due to its industrial activities, and these owe their supremacy to the abundant fuel supply. Coal and coke form the largest items in the immense freight tonnage of Pittsburg, a tonnage which surpasses that of New York and Chicago combined, and which has no equal in the world. The railroad freight for 1902 exceeded 80,000,000 tons, while the water tonnage approximated 9,500,000 tons. The manufacturing interests of the city date back to the close of the eighteenth century. Iron-working and glass-making were early engaged in, and glass and steel are still the leading products. According to the census of 1900 Pittsburg had invested in manufacturing within its municipal limits \$193,162,900, and the annual product was worth \$203,261,251. In adjoining cities and towns were plants with an invested capital of about two-thirds of the corresponding amount given above. The Greater Pittsburg produces annually 3,500,000 tons of pig iron, or about 22 per cent. of the entire output of the country. Finished products include wire, nails, boiler and hull plate, rails, angle iron, sheet, tinned sheet, tools, agricultural implements, stoves, engines, boilers, plumbing and sanitary supplies, enameled ware, electrical machinery, tubes, armor plate, projectiles, and air brakes. The manufactures of iron and steel have overshadowed the activities in other lines, which, however, are important. In 1900 the value of the glass product was \$2,778,847. The largest cork factory in the world is in Pittsburg. The output of manufactured copper is 500,000 pounds annually. In the production of electrical cable for underground use Pittsburg leads the country. Among other industries of importance are the manufacture of pottery, brick, shot and lead pipe, jewelry, asbestos, shoes, tobacco and cigars, mirrors, malt and spirituous liquors, clothing, oleomargarine, rubber, and aluminum. In these employments and others 69,977 workmen were engaged in 1900. The number of manufacturing establishments was 1938. A large business is done in petroleum products, several refineries being in the city.

The transportation facilities of Pittsburg include the Pennsylvania, Vanderbilt, and Gould systems of railways, the independent Pittsburg, Bessemer and Lake Erie, and Buffalo, Rochester and Pittsburg roads, and the rivers. The Pennsylvania system includes, from the east, the main line of the Pennsylvania Railroad, the Buffalo and Allegheny Valley division, the Pittsburg, Virginia and Charleston, the Baltimore and Ohio, and the West Penn; from the west, the Pittsburg, Fort Wayne and Chicago, the Erie and Pittsburg, the Cleveland and Pittsburg, the Pittsburg, Cincinnati, Chicago and Saint Louis, and the Pittsburg and Western roads, with their branches. The Vanderbilt system reaches the

city from the west by way of the Pittsburg and Lake Erie Railroad, while the Gould interests are penetrating to the city through an extension of the Wabash from the west. The most extensive freight yards are at Piteairn on the Pennsylvania Railroad, Versailles on the Baltimore and Ohio, McKee's Rocks on the Pittsburg and Lake Erie, Conway on the Pittsburg, Fort Wayne and Chicago, Sheridan on the Pittsburg, Cincinnati, Chicago and Saint Louis, and at Twenty-eighth Street on the Buffalo and Allegheny Valley division. The Pennsylvania system has a large union station at Tenth and Liberty streets, used by all its roads except the Baltimore and Ohio and the Pittsburg and Western. The Pittsburg and Lake Erie also has a fine new station on the South Side.

The rivers are of great importance commercially. The Monongahela runs through the richest coal fields of the Pittsburg district, and is improved throughout its entire length. In 1897 the Federal Government purchased seven locks and dams from the Monongahela Navigation Company for \$3,761,615. It already owned two locks and dams above these, and Congress soon afterwards authorized the construction of six more at a cost of \$1,200,000 to give slack-water navigation from Pittsburg to Fairmont, W. Va., a distance of 130 miles. Three locks and dams, to cost \$1,500,000, are under construction on the Allegheny River, which will give 22 miles of slack-water navigation. On the Ohio River, Davis Island dam, constructed at a cost of \$940,000, affords a harbor for the city. Six dams are being constructed at an estimated cost of \$5,525,000, and five more have been authorized by Congress. The project contemplates the creation of a nine-foot stage of water between Pittsburg and Cairo, Ill., at an ultimate cost of \$50,000,000. The traffic on these rivers is enormous, consisting chiefly of coal and manufactured iron. Of the 9,500,000 tons of freight on the rivers each year, 5,500,000 tons are coal. Pittsburg has 144 steam vessels, with a total tonnage of 39,476, on its marine register, but the barges, in which most of its shipping is done, are not registered. Their tonnage is estimated to be in excess of 2,500,000 tons. Considerable business in lighter freights and passengers is done on the Monongahela and Ohio rivers by fast packets. The Allegheny is devoted chiefly to lumber-rafting.

The export trade of Pittsburg is large and is growing rapidly. Coal is being shipped by river to New Orleans, and by rail to New York and Philadelphia for export. Manufactured iron and steel also are exported in immense quantities.

GOVERNMENT. The government of Pittsburg is vested in a mayor and a bicameral city council. The title of the chief executive was changed from mayor to recorder by an act of Legislature passed in 1901, regulating the government of second-class cities, and his powers were much enlarged, but in 1903 the former title was restored. He now appoints, with the consent of Select Council, the city treasurer, directors of the departments of public works, public safety, charities, and the department of law, as well as five police magistrates. Councils elect their own presiding officers and the city clerks. The comptroller is chosen by popular vote. The city has a pension fund for the benefit of veteran employees of the police and fire bureaus, and a dis-

ability fund for the assistance of those killed or injured while on duty. The police administration is, under the director of the department of public safety, in the hands of two coordinate bureaus, police and detectives. The fire department is under the control of a chief engineer. Its equipment is excellent, but the water supply at present is inadequate, and insurance rates are accordingly high.

MUNICIPAL FINANCES. The total assessed valuation of the city in 1903 was \$375,163,051. The gross bonded indebtedness was \$21,391,201, and the net debt \$15,740,838. The limit of indebtedness is fixed by law at seven per cent. of the assessed valuation. The real estate owned by the city, exclusive of school properties, is valued at \$17,406,206, the water plant forming the largest single item—\$5,969,300. The water supply is drawn from the Allegheny River, and is not good. The electors have authorized the construction of an extensive sand filtration plant from the proceeds of a bond issue. The parks are valued at \$3,436,835; the bureau of fire properties at \$815,000; the bureau of police properties at \$203,400; and the municipal hall at \$870,000. The total revenue of the city for the fiscal year ending January 31, 1903, applicable to general expenditure, was \$7,094,204. Of this sum the department of public works expended \$1,394,745, including \$235,000 for the repaving of streets. During the same period \$886,000 expended for the paving and sewerage of new streets was paid by the owners of abutting property. The department of public safety expended \$1,387,035, the principal items of which were for fire and police protection. The department of charities maintains a city farm at Marshalsea, and on this and for outside relief expended \$131,352. The appropriation for interest and sinking fund was \$1,595,834. The city maintains a municipal hospital for contagious diseases, and was one of the first in the country to engage in the production and free distribution of diphtheria antitoxin serum.

POPULATION. The growth of Pittsburg during the past few decades has been very rapid. In 1900 the city's population was 321,616. In 1800 it was but 1565. The population by succeeding censuses follows: 1810, 4768; 1820, 7284; 1830, 12,542; 1840, 21,115; 1850, 46,601; 1860, 49,221; 1870, 86,076; 1880, 121,799; 1890, 238,617. Of the population in 1900, 236,738 were native born and 84,878 foreign born, while 171,225 were of foreign parentage. The preponderance of the iron and steel industries draws a large foreign population to the city and vicinity. The colored population is large, in 1900 having been 17,195.

HISTORY. As early as 1730 the confluence of the Allegheny and the Monongahela rivers became a centre of trading operations with the Indians. France and England were rival claimants to the region, and on the English side both Pennsylvania and Virginia asserted jurisdiction. While on his mission to warn the French away from the Allegheny Valley, Washington visited the site of Pittsburg in November, 1753. He wrote in his journal: "I spent some time in viewing the rivers and the land in the forks, which I think extremely well situated for a fort, as it has absolute command of both rivers." In the interest of the Ohio Company (q.v.), Captain Trent, with a few Virginia militia, began to build a fort at this place, in February, 1754. On

April 17th a force of 700 French and Canadians forced the Virginians to leave. The works were completed and enlarged by the French and named Fort Duquesne. In an effort to retake the place a strong British expedition under General Braddock met disastrous defeat at the hands of the French and Indians, eight miles from Fort Duquesne, on July 9, 1755. In 1758 General Forbes, moving from Philadelphia, led an army of 7500 against Fort Duquesne. A party of 800, under Major James Grant, attempted to surprise the fort on the morning of September 14th, but was overwhelmed and routed. The site of this defeat is a hill in the business centre of the city, now occupied by the Court House and the Frick Building. Forbes by November 24th was within fifteen miles of Fort Duquesne. The French then burned the fort and fled. Forbes occupied the place on November 25th and named it "Pittsburgh," in honor of England's Prime Minister. A small garrison remained over winter, and in 1759 General Stanwix constructed Fort Pitt. During Pontiac's war in 1763 the fort was vigorously besieged by the Indians from June 27th to August 6th. Col. Henry Bouquet, with 500 British regulars, marched from Carlisle to the relief of the fort, defeated the Indians at Bushy Run, 30 miles east of Pittsburg, after a two days' fight, and reached the fort on August 9th. In 1764 Bouquet erected a brick block-house a short distance from the fort, and this is the only structure of colonial times remaining at Pittsburg. It is owned and preserved by the Daughters of the American Revolution.

In 1768 John Campbell laid out a small plan of lots near the fort, whereon cabins were erected by sufferance of the fort's commander. The title to the country surrounding Pittsburg was bought from the Iroquois in 1768, and in April, 1769, the Penns opened a land office, but sold nothing within the manor of Pittsburg. Titles under Pennsylvania were not popular, but a strong emigration set in from Virginia. Washington, on a journey down the Ohio River to seek bounty lands for his soldiers, visited Pittsburg in October, 1770. He then wrote: "The houses, which are built of logs, and ranged in streets, are on the Monongahela, and I suppose may be about twenty in number and inhabited by Indian traders." In 1772 Fort Pitt was evacuated by the British, but two years later it was occupied by Virginia militia and Virginia authority was established. Virginia courts were held in Pittsburg in 1775-76 and Virginia governed the country until the boundary dispute was adjusted in 1781. During the Revolution Fort Pitt was garrisoned by Continental troops, who were occupied in frequent excursions against the Indians. The Penns began the sale of lots in the manor of Pittsburg in 1784, in which year Arthur Lee thus described the place: "Pittsburgh is inhabited almost entirely by Scots and Irish, who live in paltry log houses. There are in the town four attorneys, two doctors, and not a priest of any persuasion, nor church, nor chapel, so that they are likely to be damned without the benefit of clergy. The place, I believe, will never be very considerable." Allegheny County was erected in 1788, and the court house was established at Pittsburg. The opening of the Northwest Territory gave an impetus to trade, but Pittsburg's real growth did not begin until the close of Indian hostilities in 1795. In 1794

Pittsburg took an active part in the Whisky Insurrection (q.v.), houses being burned, large meetings of the disaffected held, and destructive fires, supposedly incendiary, breaking out, so that troops had to be sent here to enforce the law. Pittsburg became a borough in 1794 and a city in 1816. In 1796 its population was but 1400. The making of window glass began in 1796, and during the first ten years of the nineteenth century ship-yards, foundries, the first bank, cotton factories, and shops for metal-working came into existence. The Pennsylvania Canal was opened to Pittsburg in 1834, and the era of activity and prosperity that followed was only temporarily checked by the fire of 1845, which destroyed property valued at \$6,000,000. In 1877, during the great railroad strike, property valued at more than \$3,000,000 was destroyed by the rioters.

Consult: Craig, *Olden Time* (Pittsburg, 1846-48); Craig, *The History of Pittsburg* (ib., 1851); Albach, *Annals of the West* (ib., 1856); McKnight, *Our Western Border* (ib., 1875); Chapman, *The French in the Allegheny Valley* (Cleveland, 1887); Thurston, *Allegheny County's Hundred Years* (Pittsburg, 1888); Darlington, *Fort Pitt and Letters from the Frontier* (ib., 1892); Withers, *Chronicles of Border Warfare* (Cincinnati, 1895); *Frontier Forts of Pennsylvania* (Harrisburg, 1896); Hassler, *Old Westmoreland: A History of Western Pennsylvania During the Revolution* (Pittsburg, 1900).

PITTSBURG. A city in Crawford County, Kan., 130 miles south of Kansas City; on the Atchison, Topeka and Santa Fe, the Missouri Pacific, the Saint Louis and San Francisco, and the Kansas City Southern railroads (Map: Kansas, II 4). It has extensive coal-mining interests, being situated in the centre of productive coal fields and near the great mineral district of southwestern Missouri. There are also shops of the Kansas City Southern, a foundry and machine shops, brick and sewer pipe plants, lumber and flour mills, grain elevators, a packing house, etc. The city maintains a public library. Settled in 1876, Pittsburg was incorporated in 1880. It is governed by a mayor, elected biennially, and a unicameral council. Population, in 1890, 6697; in 1900, 10,112.

PITTSBURG LANDING, BATTLE OF. See SHILOH, BATTLE OF.

PITTSBURG ORCHESTRA. The permanent orchestra of Pittsburg, Pa. It was founded in 1895, and is maintained by public subscriptions guaranteed by a few public-spirited citizens. It has a membership of about seventy, and ranks with the great orchestras of America. Frederick Archer was its first conductor. In 1898 Victor Herbert became its conductor and brought the organization to a high degree of efficiency.

PITTSFIELD. A city, including several villages within its corporate limits, and the county seat of Berkshire County, Mass., 150 miles west of Boston; on the Boston and Albany and the New York, New Haven and Hartford railroads (Map: Massachusetts, A 3). Its site in a hill-girt valley of the Berkshires, over 1000 feet above sea level, is of great natural beauty. In the vicinity are several picturesque lakes. There are public parks, one of which, in the heart of the city, has the fine statue of "The Color Bearer." Among the noteworthy structures are the court

house, built of white marble, the Crane Art Museum, the Berkshire Athenaeum, the latter containing a public library of 36,000 volumes and the rooms of the Berkshire Historical Society; the House of Mercy and the Henry W. Bishop Training School for nurses, and the Berkshire County Home for Aged Women; the high school, the Berkshire Life Insurance Building, and the Berkshire County Savings Bank. The city is the headquarters of the Agassiz Association (q.v.). Pittsfield is an attractive residential place and a popular summer resort. It is known also for its manufacturing interests. As shown by the census of 1900, \$6,085,000 was invested in the various industries, which had a production valued at \$7,136,000. The leading establishments are woolen mills, a silk mill, foundry and machine shops, shoe factory, works making electrical machinery and supplies, paper mills, etc.

The government, under a charter of 1895, is conducted by a mayor, chosen annually, and a bicameral council that elects most administrative officers. The school committee is chosen by popular vote. The mayor appoints license commissioners. The water-works are owned and operated by the municipality. Settled in 1743 as Pontoosuck or Boston Plantation, Pittsfield was incorporated as a town under its present name in 1761 and in 1891 was chartered as a city. Longfellow stayed for a time at the Appleton House here and Oliver Wendell Holmes and Herman Melville lived in the vicinity. Population, in 1890, 17,281; in 1900, 21,766. Consult Smith, *The History of Pittsfield* (Boston, 1876).

PITTS/TON. A city in Luzerne County, Pa., ten miles southwest of Scranton; on the Susquehanna River, above the mouth of the Lackawanna, and on the Lehigh Valley, the Central of New Jersey, the Delaware and Hudson, the Lackawanna, and other railroads (Map: Pennsylvania, F 2). Situated in the anthracite region of the State, it is engaged principally in mining and preparing coal for market, the coal traffic being very important. There are also valuable deposits of fire clay in the vicinity. The manufacturing establishments include foundries and machine shops, stove and engine works, knitting mills, flour, paper, and lumber mills, breweries, terra-cotta and brick works, etc. Pittston is one of the leading commercial and industrial centres of this region. West Pittston (q.v.), across the river, is more distinctly a residential section. The city maintains a public library. Laid out in 1768 and named in honor of William Pitt, Pittston was settled about 1770, was incorporated as a borough in 1803, and was chartered as a city in 1894. Population, in 1890, 10,302; in 1900, 12,556.

PITUITARY BODY (Lat. *pituitarius*, relating to phlegm, from *pituita*, phlegm; connected with *spuere*, Gk. *πρῦεν*, *ptyein*, Lith. *spiauti*, Lett. *splaut*, OChurch Slav. *plivati*, *plynti*, Goth. *speivan*, OllG. *spūvan*, Ger. *speien*, AS. *speican*, Eng. *spue*, and ultimately with Eng. *spit*). The hypophysis of the brain, often called the pituitary body, is an appendage of the lower side of the twixt-brain in vertebrates. Its origin shows that it is a compound body, the different parts of which arise from different areas in the embryo. When fully developed the pituitary body consists of three parts, a stalk, an anterior and

a posterior lobe. This stalk arises as an evagination of the floor of the 'twixt-brain and is called the infundibulum. Its distal portion subsequently develops into the posterior lobe. In the lower vertebrates the stalk and posterior lobe are clearly made up of nervous tissue, but in the higher animals the posterior lobe contains very little nervous substance. The anterior lobe arises as an evagination or outgrowth of the upper surface of the mouth, and only secondarily comes into connection with the other parts. It has a very characteristic structure, contains no nervous elements, and resembles very closely a ductless gland. In no living vertebrate does the hypophysis have any known function, and even if it be granted that it is homologous with the subneural gland of tunicates, its actual use to the animal, either past or present, would still be an open question. Numerous theories have been proposed to account for its structure and function, but none have met with very general acceptance. The most recent (1903) is that the pituitary body is in intimate nervous connection with the suprarenal capsules, and through them regulates the amount of oxygen absorbed by the blood. But this view is not adequately supported by clinical or experimental evidence.

PIT VIPER. See CROTALIDÆ.

PIT'YRIASIS (Neo-Lat., from Gk. *πυρραία*, *pityriasis*, from *πυρον*, *pityron*, bran). An exfoliation of the skin in bran-like scales, regarded by some dermatologists as a condition occurring in several skin disorders, by others as a separate disease. Excessive formation of dandruff (*furfuracea*) is called *pityriasis simplex* or *pityriasis capitis*, or *pityriasis of the scalp*, by some. The popular skin affection known as *pityriasis* embraces four varieties: (1) *Pityriasis rubra* is characterized by a gradual dissemination of papules over the trunk and upper extremities, especially upon the dorsal aspect of forearms and phalanges. The papules are bright red and slightly brownish, and are succeeded by large red spots or plaques. Changes occur in the surface of the skin incident to the scratching which the itching necessitates. (2) *Pityriasis rosca* is similar to *pityriasis rubra*, with perhaps greater infiltration of the skin, although the erythema is less. A macular form is also described. (3) *Pityriasis nigra* has been observed in children born in India and brought to England. The eruptive papules are black. (4) *Pityriasis versicolor*, or *tinea versicolor* (q.v.), is characterized by the occurrence of brown or dark yellowish patches over the trunk, and is confined to the body, where it is covered by clothing. It is due to a parasite, the *Microsporon furfurans*.

Pityriasis infantilis and *pityriasis scnilis* are forms of eczema (q.v.). *Pityriasis tabescentium* is seborrhæa (q.v.). The treatment of these diseases must be left to a physician. Consult Kaposi, *Pathology and Treatment of Diseases of the Skin* (New York, 1895).

PIT'YU'SÆ. The southwestern group of the Balearic Islands, consisting of the islands of Iviza and Formentera (qq.v.) and a number of small, uninhabited islets.

PI-TZŪ WO, pē'tsōō wō'. A small seaport on the east coast of the peninsula of Liao-tung (q.v.). It lies north of Ta-lien-wan, in latitude 39° 18' N., and longitude 122° 18' E.,

has many large warehouses and considerable trade, and is included in the territory leased by Russia along with Port Arthur (q.v.). The harbor is well sheltered by a semicircular reef, but is shallow.

PIURA, pē-ōō'rā. The northernmost department of Peru, bounded by Ecuador on the north, the Peruvian Department of Amazonas on the east, Cajamarca and Lambayeque on the south, and the Pacific Ocean on the west (Map: Peru, A 5). The area is estimated at 16,825 square miles. The eastern part is mountainous, with fertile valleys; the western is mostly desert land. Cotton is grown to some extent and some minerals are found, of which the petroleum deposits are exploited. The population was officially estimated in 1896 at 213,900. The capital is Piura (q.v.).

PIURA. The capital of the Department of Piura, Peru. It is situated 20 miles from the coast and 80 miles southeast of Cape Blanco (Map: Peru, A 4). It is a well-built town with a beautiful garden-plaza containing a marble statue of Liberty. It is an important cotton market, and is connected by a railroad with the port of Payta (q.v.). Population, about 12,000. Piura was the first permanent settlement made by Pizarro.

PI'US. The name of ten popes. PRUS I., Saint, Pope 140-154. Little is known of his pontificate; perhaps the most authentic record of it is that contained in the Muratorian Fragment, which assigns the writing of the *Shepherd* by Hermas, his brother, to his pontificate. See HERMAS, SHEPHERD OF.—PIUS II., better known generally as Æneas Sylvius, Pope 1458-64. He came of the noble family of Piccolomini in Siena, and was born in 1405 in the village of Corsignano, afterwards called Pienza from his Papal title. His early life was not free from serious irregularities, but he made amends by his subsequent decorous conduct; and his eminent abilities as a canonist led to his being employed, when but twenty-six years of age, as secretary to the Cardinal-Bishop of Fermo, an appointment which, though it lasted but a short time, led to further employment and brought him commissions of the highest importance in connection with the Council of Basel (q.v.). On the election of the antipope Felix V. (Duke Amadeus VIII. of Savoy), in 1439, he was chosen one of the deputation to notify him of his election, and became his secretary, in which post his eminent literary abilities were conspicuously useful. Having been sent as ambassador to the Emperor Frederick III., he was induced to accept office in the Imperial Chancery. This opened the way for further steps in the diplomatic career of which his prudence took advantage. On a mission to Rome in 1445 he declared himself decidedly for Eugenius IV. and attached himself to his interests. Having at last decided to take holy orders in that year, he was made Bishop of Triest in 1447 and of Siena in 1449, remaining, however, in the Imperial service until 1455. A year later he was made a cardinal by Calixtus III. On the death of this pontiff, in 1458, after a conclave lasting only three days, Æneas Sylvius was elected his successor. As Pope he devoted himself to rousing Christendom to a war against the Turks. He called a congress of princes to meet at Mantua in 1459, and appeared in person to preside over

it, but little came of it for the time. Undeterred by discouragements, he pursued his purpose, and had planned to go in person against the Turks; but, seized with illness at Ancona, where the fleet was to assemble, he died August 14, 1464. The literary reputation of Aeneas Sylvius has partially eclipsed the historical fame of the Pope. He was one of the most eminent scholars of his age, in many ways a type of the Renaissance learning. The most interesting portion of his works is the collection of his letters, which are full of details characteristic both of the writer and of his age. He left also some partly autobiographical commentaries (republished by Lesca, Rome, 1894). Others of his works, the novel *Lucretius et Eurypalus* and his dialogues on the authority of general councils and in defense of the Council of Basel, he formally retracted. Consult his *Life* by G. Voigt (Berlin, 1856-63); by Weiss (Graz, 1897); and an essay on him in Creighton, *Historical Essays and Reviews* (London, 1902).

PIUS III., Pope 1503, Francesco Todeschini. He was a nephew of Pius II., who made him Bishop of Siena and cardinal in 1460. He was employed by subsequent popes in various important missions, and succeeded Alexander VI., but only lived a month after his election.—PIUS IV., Pope 1559-65, Giovanni Angelo Medici or Medeghino. He was born in 1499, studied medicine and law, and devoted himself to the latter as a profession. Later he went to Rome and entered on an ecclesiastical career, being named archbishop (1545) and cardinal (1549) by Paul III. Elected Pope after a conclave lasting more than three months, he entered upon a heritage of many troublesome questions. The principal significance of his pontificate lies in his reassembling of the Council of Trent, which Paul IV. had thought to have practically completed its task. It was finally closed, after further sessions lasting over nearly two years, in December, 1563, and the bull confirming its decrees was issued January 26th following. The well-known creed called the Creed of Pius IV. or the Tridentine confession of faith was issued by Pius as an embodiment of all the doctrines defined in the council. (See PIUS IV., CREED OF.) Pius exerted himself vigorously to carry out the reforming decrees of the council, though much of this work was reserved for the following pontificate. He died December 9, 1565, in the arms of his nephew, Charles Borromeo (q.v.), whom he had made a cardinal.—PIUS V., Saint, Pope 1566-72, Michele Ghislieri. He was born in 1504 at Bosco, near Alessandria, entered the Dominican Order at fourteen, and after the completion of his studies was employed in various capacities, educational and administrative. Paul IV. made him Bishop of Sutri in 1556, cardinal in 1557, and grand inquisitor in 1558. His main task as Pope was to enforce the reforming decrees of the Council of Trent. Auster and self-denying in his personal life, he expected equal devotion on the part of others, and met opposition with unflinching firmness. He republished the bull *In vena Domini* (q.v.) in a more rigorous form, and excommunicated and attempted to depose Elizabeth of England for her refusal to submit. The resources of the Papacy were employed to assist the Catholic cause against the Huguenots in France and to protect Christendom from the Turks. With Spain and Venice, Pius organized the Holy League against the Turks, who were signally defeated in the

naval battle of Lepanto. He completed the Roman catechism, and published thoroughly revised editions of the missal and breviary. He was canonized by Clement XII. in 1712. Consult Falloux, *Histoire de saint Pie V.* (3d ed., Paris, 1858).

PIUS VI., Pope 1775-99, Giovanni Angelo Braschi. He was born of an impoverished but noble family in 1717, and early entered the ecclesiastical service, being made a cardinal in 1773 by Clement XIV., whom he succeeded two years later. He maintained the position of the Church with uncompromising firmness against the Emperor Joseph II. and his brother, Leopold I. of Tuscany (afterwards Emperor Leopold II.); but his greatest troubles came from the aggressions of the French Republic. In 1793 a popular tumult in Rome, which was caused by the imprudence of a French political agent named De Basseville, and resulted in his death, gave the Directory some years later an opportunity for hostile demonstrations. In 1796 Bonaparte took possession of the legations and afterwards of the March of Ancona, and by a threatened advance upon Rome extorted from Pius, in the Treaty of Tolentino (February, 1797), the surrender of these provinces, which were constituted part of the Cisalpine Republic. Finally the Directory ordered an advance upon Rome; Berthier entered the city February 10, 1798, where the Roman Republic was proclaimed, and ten days later the Pope, refusing to renounce his temporal sovereignty, was seized and carried off to Siena and later to the Certosa near Florence. On the threatened advance of the Austro-Russian army in the following year, he was transferred to Grenoble, and finally to Valence on the Rhone, where, worn out by age and the rigor of confinement, he died, August 29, 1799, after the longest pontificate until then recorded.

PIUS VII., Pope 1800-23, Gregorio Luigi Barnaba Chiaramonti. He was born at Cesena in 1742, and entered the Benedictine Order at the age of sixteen, and was employed in teaching philosophy and theology at Parma, and afterwards at Rome. He was appointed Bishop of Tivoli, and in 1785, being created cardinal, was transferred to the See of Imola. Upon his election to the Papacy in 1800, Rome was restored to the Papal authority, and in July of that year Pius VII. entered his capital; and in the following year the French troops were withdrawn from the Papal territory, with the exception of the legations. From this time forward Pius, ably seconded by his Secretary of State, Cardinal Consalvi, was destined to occupy a prominent place in the political as well as the ecclesiastical affairs of Europe. Bonaparte had resolved to restore religion in France on the ancient basis of connection with Rome. With this view, he entered into negotiations with Pius VII. for the establishment of a concordat suited to the new order of things which had arisen. It was agreed to at Paris, July 15, 1801; ratified in Rome, August 14th; and published in Notre Dame on Easter Sunday, 1802. But, simultaneously with the concordat, and as if forming part of the same arrangement, was published a code of what were called 'organic laws,' seriously affecting the discipline of the Church with regard to marriage, the clergy, and public worship, which had never been submitted to Pius, and to which he not only had not consented, but to

which he found himself compelled to offer every opposition. For the first year which succeeded the publication of the concordat, no occasion of difficulty arose; but conflict of principles was in the end inevitable. In 1804 Bonaparte, having resolved on assuming the Imperial crown, invited Pius to come to Paris for the purpose of crowning him, and the Pope, although with much hesitation, consented. He took advantage of his visit to demand the recall or modification of the articles of the code, but without success; and although, during his visit to Paris, he was treated with great distinction and reverence, his relations with Napoleon from that date began to assume a less friendly character. The French Emperor now proceeded from one petty outrage to another, until finally, in February, 1808, the French troops, under General Miollis, entered Rome and took possession of the Castle of Sant' Angelo, and on April 2d a decree was issued annexing the provinces of Ancona, Fermo, Urbino, and Macerata to the Kingdom of Italy. Pius, besides protesting against the usurpation, declared himself a prisoner in the French hands, and confined himself to his palace. Finally (May 17, 1809) the usurpation was consummated by a decree annexing Rome and all the remaining Papal territory to the French Empire. This was the signal for the Pope abandoning his policy of forbearance. On June 10th Pius issued a bull of excommunication, directed (without naming Napoleon) against the perpetrators and abettors of the invasion of the rights and the territory of the Holy See. Soon afterwards the French Emperor ordered the removal of the Pope from Rome; and Pius, without offering any resistance beyond the declaration that he yielded to force, was removed, first to Florence, then to Grenoble, thence for a longer time to Savona, whence, in June, 1812, he was finally transferred to Fontainebleau. During this prolonged captivity Pius firmly but quietly resisted every effort to compel or seduce him from his policy. At Fontainebleau he was treated with much external respect; and on Napoleon's return from the Russian campaign, in December, 1812, orders were given that the cardinals, with certain exceptions, should be admitted to the presence of the Pope. Under much pressure, both from the Emperor himself and from the ecclesiastics to whom the Emperor confided his plans, Pius was induced to sign a new concordat, an important provision of which was the recognition of the annexation of the Roman States to the Empire. Having obtained the concession, Napoleon at once permitted the absent cardinals to return, and of these many remonstrated so earnestly against the concordat that, on March 24th, Pius wrote to revoke his consent. Napoleon took no notice of the revocation; nor was it till after the disasters of 1813 that he began to seek an accommodation. Pius refused to treat until he should be restored to Rome; and on January 22, 1814, orders were sent for his immediate return to his capital. Unattended by his cardinals, he was escorted to Italy, and remained at Cesena until the campaign of the spring of 1814 placed Paris in the hands of the Allies, when Pius reentered Rome amid the gratulations of the people. During the Hundred Days he was again compelled to leave it; but, after the campaign of Waterloo, he finally resumed possession, which was undisturbed for the rest of his life, and extended to

the whole of the ancient territory, including the legations. His last years were devoted to measures of internal administration, and marked by much wisdom and moderation. Pius repressed with great vigor the disorder and brigandage which the long wars had encouraged, and the secret societies, especially that of the Carbonari (q.v.). In 1814 he formally restored the Order of Jesuits (q.v.). His private life was a model of gentleness, simplicity, and benevolence. Consult his *Life* by Mary Allies (London, 1901); Cardinal Pacea's *Historical Memoirs* (Eng. trans. by Sir George Head, London, 1850); Artaud, *Histoire du pape Pie VII.* (2 vols., Paris, 1836); D'Haussonville, *L'église romaine et le premier empire* (5 vols., 5th ed., Paris, 1870); Celani, *Il viaggio di Pio VII. a Parigi* (Rome, 1893).—PIUS VIII., Pope 1829-30, Francesco Xaverio Castiglioni. He was born at Cingoli, near Ancona, in 1761. He held in succession the bishoprics of Montalto, Cesena, and Frascati, and was made cardinal in 1816. During his brief pontificate he opposed the slave-trade in Brazil, civil marriages in Prussia, and the attacks on the Church emanating from Freemasons and Bible societies. Consult: Artaud, *Histoire du pape Pie VIII.* (Paris, 1844); Wiseman, *Recollections of the Last Four Popes* (London, 1858).

PIUS IX., Pope 1846-78, Count Giovanni Maria Mastai-Ferretti. He was born at Sinigaglia, May 13, 1792, and intended to enter the Papal Guards, but symptoms of an epileptic tendency caused him to abandon a military life. He took holy orders, and became Archbishop of Spoleto in 1827, Bishop of Imola in 1832, and cardinal in 1840. He was elevated to the Papal chair on June 16, 1846, two weeks after the death of Gregory XVI. Pius IX. took hold of the reins of government in the pontifical dominions, imbued with a sense of the evils, political, economic, and social, under which his semi-medieval realm had been laboring, and with a patriotic desire to raise Italy from her political degradation. He entered at once on a course of reforms, resolving to extirpate all abuses of administration in his State, to secularize the local administration, and to extend the rights of self-government. His first steps were to dismiss his Swiss guards and to grant a general amnesty. The latter measure unfortunately had the effect of bringing together a body of men whom exile had imbittered against the existing state of things. The Pope extended his innovations to every department of the administration, not sparing the ecclesiastical institutions and the clergy. At the same time he exerted himself strenuously to improve the economic condition of his people, and to promote their intellectual progress. His subjects were permitted to make their voice heard in public assemblies and in the press. His policy awakened enthusiasm among the friends of progress throughout Europe, Protestants and Jews, as well as Roman Catholics. Pius IX. was inspired with the dream of a free Italy, and sought to realize the ideal set forth by Gioberti of a federated Italy under the moral primacy of the Pope. But the programme which he embraced was far from satisfying the demands of the revolutionary party represented by Mazzini and his followers, and Austria was ready to combat with force of arms

a policy which threatened to subvert her dominion in Italy.

In April, 1847, the Pope announced the institution of a *consulta*, an advisory body consisting of deputies from the provinces. When it assembled in November, Pius IX. found that he had created a mouthpiece of radical demands, vehemently set forth and backed by the populace, which he was utterly unable to satisfy. A few months later the February Revolution of 1848 overthrew the Orleanist monarchy in France, and the Papal States were borne along on the flood of revolution which swept over Europe. Pius IX. was forced, while yet unprepared for it, to grant a regular constitution to his subjects, which was promulgated on March 14, 1848. It was an anomalous creation, providing for a triple machinery of legislation—a consistory of cardinals, an advisory council appointed by the Pope, and a Parliament of two chambers. A few days after this event Lombardy and Venice rose against the Austrians, and Charles Albert, King of Sardinia, embarked upon a war for the liberation of Italy. Pius IX. was dragged against his will into a struggle with the House of Hapsburg, which was to prove utterly futile. On June 11th the Papal forces were compelled to surrender to the Austrians at Vicenza. On July 25th the King of Sardinia met with disaster at Custoza. The revolutionary elements now obtained complete mastery in Rome. On November 15th the Pope's Prime Minister, Count Rossi, was assassinated as he was about to open the session of the Parliament. Violent demonstrations took place daily to compel the Pope's assent to measures which he repudiated. He at first confined himself in the Quirinal, and on November 24th fled secretly from Rome, taking refuge in the Neapolitan fortress of Gaeta. A republic was proclaimed in Rome in February, 1849. Pius IX. from his exile addressed a remonstrance to the various sovereigns. In April a French expedition, sent to restore the Papal authority, landed at Civitavecchia, which surrendered on July 2d, after a month's siege. The Pope's government was re-established, and in 1850 he again entered upon the administration. He now declared that, in view of the unsettled condition of Italy and the failure of many of his early measures of improvement, he could not proceed with the reforms which he had contemplated. With Cardinal Antonelli as Secretary of State, the course of the Papal Government became intensely reactionary. In 1860, after the war for the unification of Italy, the Romagna, the Marches, and Umbria were annexed to the dominions of Victor Emmanuel, but Pius persistently refused to cede any portion or to enter into any compromise.

His ecclesiastical administration continued very active, and proceeded upon the strongest assumption of the right of independent action on the part of the Church. He re-established the hierarchy in England, sanctioned the establishment in Ireland of a Catholic university, and condemned the principles upon which the Queen's colleges in that country were constituted. He concluded with Austria a concordat much more favorable to Church authority than the existing ecclesiastical laws had permitted. (See CONCORDAT.) In 1854 he issued a decree propounding as a doctrine of the Church the dogma of the Immaculate Conception (q.v.) of the blessed

Virgin Mary. The most important event of his pontificate was the convocation of the Vatican Council (q.v.), at which bishops from all parts of the Catholic world assembled in December, 1869. This was the first Church council since that of Trent had crystallized Roman Catholic dogma and practice to meet the Reformation attack. It was adjourned in July, 1870, after it had proclaimed the decree of the infallibility (q.v.) of the Pope when on a subject of faith or morals he issues a decree *ex cathedra* to the universal Church. Soon after the adjournment, the Italian army occupied Rome, which was made the capital of the Kingdom of Italy. Pius renewed with all solemnity his oft-repeated protest, and, refusing all proposals of accommodation, from that date declared himself a captive in the Vatican, to which he strictly confined himself until his death, February 7, 1878. Consult: Pugeois, *Histoire de Pie IX.* (Paris, 1877-86); and *Lives* by Maguire (London, 1878) and Shea (New York, 1878).

PIUS X., Pope 1903—, Giuseppe Sarto. He was born at Riese, near Venice, June 2, 1835, in a humble station, his grandfather having been a soldier in the Papal army under Gregory XVI. His whole life, until his elevation to the Papacy, was passed in Northern Italy. He studied at Treviso and at Padua, and was ordained priest in 1858. His faithful performance of his parochial duties won the favor of his superiors and caused his appointment as chancellor of the diocese in 1875 and vicar-capitular two years later. In 1884 Pope Leo XIII. named him Bishop of Mantua, and in 1893 created him cardinal and Patriarch of Venice. His appointment to the patriarchate gave rise to an animated dispute with the Italian Government, which claimed the right, as the successor of the Republic of Venice, to nominate the Patriarch. This claim was denied by the Holy See, and Monsignor Sarto's personal qualities finally gained the approval of the Government. In the administration of his important diocese he proved himself a strong and competent prelate, reforming a number of abuses which had crept in in the course of time. He won the veneration of all his people, especially by his devotion to the poor and the modesty and simplicity of his life. He was elected Pope on August 4, 1903, after six fruitless ballots had been taken, by fifty-five out of sixty-one votes, his two leading competitors having been Cardinals Rampolla (q.v.) and Gotti (q.v.). He entered upon his pontificate with the reputation, not only of a deeply religious man and a wise administrator, but of a learned scholar and friend of the arts. It was through him that Don Luigi Perosi, the priest composer, was first brought to public attention. The fact of his assuming the name of Pius was taken as an indication that he intended to maintain the generally conservative policy of Pius IX., and to continue the protest of his two predecessors against the occupation of the Papal States by the Italian Government, despite the fact that his personal relations with the House of Savoy had been uniformly friendly.

PIUS IV., CREED OF. The dogmatic formula drawn up by a commission of members of the Council of Trent as a summary of its decisions, and promulgated by Pope Pius IV. at the end of 1564 in the bull *In sacrosancta*. Its formal acceptance is required of all priests and teachers

in the Roman Catholic Church, as well as of all converts to that communion. It begins by embodying the Nicene Creed, and proceeds to the later more elaborate definitions. Successive articles declare belief in apostolical and ecclesiastical traditions and all other observances and constitutions of the Holy Roman Church; the Holy Scriptures according to that sense which the Church has held and does hold; seven sacraments of the new law instituted by Christ and necessary for the salvation of mankind, though not of every one; the definitions of the Council of Trent concerning original sin and justification; the doctrine of a true, proper, and propitiatory sacrifice in the mass, transubstantiation, and the reception of Christ whole and entire under either kind; a purgatory, the souls detained in which are helped by the prayers of the faithful; the veneration and invocation of the saints reigning together with Christ, and the veneration of their relics and of sacred images; the power and use of indulgences; and the position of the Holy Catholic Apostolic Roman Church as the mother and mistress of all churches. It concludes with a promise of fidelity to this faith and of obedience to the Bishop of Rome, successor to Saint Peter, Prince of the Apostles and Vicar of Jesus Christ. Its full text may be found in Schaff, *Creeeds of Christendom* (New York, 1877-78).

PIUS IX., ORDER OF. A Papal order of merit with two classes, founded by Pius IX. in 1847. It is conferred on the nobility for virtue and merit. The decoration is an eight-pointed blue star with gold flames between the arms. The device is *Virtuti et Merito*. Members of the order have a dark-blue uniform embroidered in gold. See Plate I. of ORDERS.

PIUTE. A name loosely applied to various small bands of Shoshonean stock (q.v.), scattered over the arid region between the Rocky Mountains and the Sierras, from the Colorado almost to the Columbia, in Nevada, northwestern Arizona, eastern California and Oregon, western Utah, and southern Idaho. According to Powell, who took a census of the bands in 1873, the name properly belongs only to those living in or adjoining southwestern Utah, while those now gathered upon Pyramid Lake and Walker River reservations in Nevada, popularly and officially recognized as Piute, are really of another tribe and language, which he calls Paviotso. Still others he classes with the Shoshoni and Banak. As there is practically no tribal cohesion, and but few cultural differences among the various bands, the only classification must come from a close study of the dialects. A few bands, as the Chemehuevi along the Colorado in northwestern Arizona, and the Mono in the Sierras of eastern California, have acquired a separate tribal recognition. Those of Oregon and the north are frequently known also as Snakes. See SHOSHONI. The meaning of the popular name is unknown; they themselves pronounce it in three syllables, *Pai-u-ti*. Those on Walker River Reservation, and probably the others as well, designate themselves by the common Shoshonean term *Nūma*, 'People.'

Living in a country too barren, as a rule, for agriculture or large game, the Piute subsisted chiefly upon wild seeds, berries, and roots, grasshoppers, and jack rabbits, with fish and ducks from the few scattered lakes. Their houses

were the so-called *wikiups*, low, dome-shaped or elliptical structures open at the top, covered with mats woven from rushes, and equipped with a variety of well-made baskets, but otherwise destitute of furnishing. They formerly went nearly naked, excepting in the coldest weather, when they wrapped around their bodies thick blankets woven from jack-rabbit skins cut into strips with the hair left intact. Their ordinary weapons were the bow and arrow and club. They did not use the lance or shield, and very few owned horses. The dead were usually cremated. Although stolid and apparently of low mental type as compared with the Plains tribes and their kindred, the Banak and Ute, they seem to hold their own well in the presence of civilization, and several of their men have at different times acquired reputation and influence far beyond their own boundaries. The Ghost Dance religion, the greatest Indian religious movement of modern times, originated among the Piute of Walker River Reservation. Some of the bands were hostile up to 1864, since which time treaties of peace have been made and a large number assigned to reservations. As a people they are now efficient workers among the whites, avoid the vices of civilization, wear citizen's dress, are healthy and apparently increasing. Those officially designated as Piute are in California, near Fort Bidwell, 200; in Oregon, Klamath and Warm Springs agencies, 185; in Utah, near Saint George, 100; in Nevada, Pyramid Lake, Walker River, and Wester, Shoshoni agencies, 1300; "not under an agent," about 3700.

PIXIS, pik'sis, THEODOR (1831-). A German historical and genre painter, born at Kaiserslautern. While studying law at the University of Munich, he took up painting at the Academy under Foltz and Wilhelm von Kaulbach, and after his return from a sojourn in Italy (1856-58), executed in the National Museum, at Munich, three mural paintings of episodes in the history of Charles X. and Charles XI. of Sweden (1859-61). Besides a series of cartoons to German folk songs and illustrations to Milton's *Paradise Lost*, a cycle of twelve paintings to Kinkel's epic poem *Otto der Schütz*, and a "Wagner Gallery" (1868-94), forty-five cartoons and paintings to Wagner's operas are among his most meritorious works. Subsequently he painted also portraits and especially charming scenes from child life. His easel pictures include "Huss at Constance Saying Farewell to His Friends" (1856, Bern Museum); "Calvin Visiting Servet in Prison" (1862); "The Thespian Chariot in a Scrape" (1873); "Arrival of Itinerant Actors" (1876); and "In Front of a Jeweler's Shop."

PIXLEY-FULFORD, ANNIE (1855-93). An American actress. She was born in New York, but she began her career as a singer in California. She was married to Robert Fulford in 1871 and made her debut on the dramatic stage in San Francisco in 1876. She appeared in New York in 1878. Her best-known part was that of M'Iss in the dramatization of Bret Hart's story. She died in London, November 8, 1893.

PIZARRO, pē-zār'rō, Sp. pron. pē-thār'rō, FRANCISCO (c.1470-1541). The conqueror of Peru. He was the illegitimate son of Gonzalo Pizarro, a prominent soldier in the army of the great captain Gonzalo de Córdoba, and was born at Trujillo, in Extremadura, Spain, where he

passed his boyhood earning his living as a swineherd. In 1509 he sailed for America with Ojeda, whose fortunes he followed for several years. In 1519 he settled down on a small land holding in the new city of Panama. Three years later he formed a partnership with Diego de Almagro (q.v.) and Father Luque to explore the country discovered by Andagoya to the south of the isthmus. A first expedition in 1524 accomplished nothing, and a second in 1526, undertaken with the assistance of Gaspar de Espinosa, threatened to ruin the partners. Enough of the country was seen, however, to prove that it contained much wealth, and so Pizarro landed on the island of Gallo, not very far from the equator, while Almagro returned for assistance. The sufferings of the men had been so great, however, that the Governor at Panama sent a vessel to bring them all back. Pizarro refused to embark, and drew on the sand with his sword the famous dividing line, beyond which he declared lay labor, hunger, thirst, sickness, and every kind of danger, but also the chance for glory and heroic achievement. Thirteen men crossed to stand by him, while the rest went back to Panama. Pizarro maintained himself for several months until the arrival of Almagro, and then they continued to explore the mainland as far as the Gulf of Guayaquil. Convinced that his resources were insufficient to embark upon the conquest of this highly civilized region, Pizarro collected irrefutable evidences of its wealth, and then went back to Panama, whence he proceeded to Spain in 1528. Charles V. granted him authority to conquer and govern this territory with the title of *Adelantado*. Pizarro enlisted a considerable force, including his four brothers. In 1530 he was back at Panama, and in January, 1531, he started for the real conquest of Peru. Landing at Tumbez, he learned of the weakened condition of the country, which the struggles between Atahualpa and Huascar, sons of the Inca Huayna Capac, had made an easy prey for a foreign conqueror. At Tumbez Pizarro was joined by Hernando de Soto. From this place Pizarro marched to Cajamarca, which was reached November 15, 1532. There Atahualpa came to meet him as a result of an exchange of friendly messages. Realizing his danger, surrounded as he was by many thousands of native warriors, Pizarro arranged that when Atahualpa had entered the great central inclosed courtyard of the village the Spaniards should suddenly attack the Peruvians from all sides. Atahualpa was secured as a prisoner (November 16, 1532), to be held as hostage for the safety of the force, scarcely a hundred strong. The native forces rapidly disintegrated, and Atahualpa, despite the ransom which he collected, estimated at \$17,500,000, was killed. A hundred and fifty fresh troops came from Panama with Almagro, and the country was rapidly reduced to subjection, except for scattered native bands which kept up the struggle for independence. Cuzco was occupied in November, 1533, and in January, 1535, Lima, the first of several towns founded by Pizarro, was formally organized. Meanwhile Hernando Pizarro, the eldest of the brothers, had gone to Spain with the royal fifth of Atahualpa's ransom. He returned in 1535 with various honors for the conquistadores, the title of Marquis for Francisco, and a grant of the Chilean region for Almagro. The conqueror devoted himself to the

development of the country, and was apparently succeeding quite as well as an administrator as he had done as a soldier, when the outbreak of the natives under Manco Inca (q.v.) in 1536 forced him to take up arms again. In the defense of Cuzco Juan Pizarro, perhaps the most brilliant fighter of the family, was killed. Almagro meanwhile returned from Chile, and as soon as the natives were driven off claimed Cuzco as lying within his territory. By a sudden attack he captured Hernando and Gonzalo Pizarro, and occupied Cuzco. After repeated negotiations and an interview which served only to add to the bitterness between the two former partners, the Marquis agreed to give up his claim to Cuzco on condition that his brother Hernando—Gonzalo having escaped—should be released. As soon as Hernando had arrived safely at his brother's camp Francisco declared war on Almagro. The latter, too old and infirm to mount a horse, directed his army from a litter. On the plain of Las Salinas, in April, 1538, the Pizarros completely defeated him. Almagro was caught and, his efforts to bribe his guards becoming known, ordered to be strangled or garroted, the recognized method of execution. The Marquis took up his headquarters in Cuzco and again began to develop the mining and other resources of the country. Hernando in 1540 returned to Spain to defend their actions, but the friends of Almagro had won the royal ear, and he was imprisoned, remaining for twenty years in nominal confinement at the Castle of Medina del Campo. The Marquis returned to Lima in 1540, and busied himself with administrative affairs. While at dinner, on Sunday, June 26, 1541, he was surprised by a band of conspirators under Juan de la Rada, who had united to champion the cause of Almagro's son and avenge the father's murder. Deserted by his guests, Pizarro defended himself until mortally wounded, made a cross with his blood on the floor and died as he kissed it. Prescott's *History of Peru* is principally an account of the career of Pizarro, and gives the standard version of the events of the conquest. It should be compared with Markham, *Peru* (Chicago, 1892), which embodies the results of later documentary studies.

PIZARRO, GONZALO (c.1505-48). A Spanish conquistador, brother of Francisco Pizarro. He was active in assisting his brother in the conquest of Peru, and after his escape from Almagro, who threatened to execute him (see preceding article), fought in Charcas, and in 1539 became Governor of Quito. He was sent in 1541 by the Marquis to investigate rumors of a land of cinnamon beyond the Andes. After a remarkable journey over the mountains the cinnamon trees were found, with no possible means of getting their product to a market. As the explorers were threatened with starvation, a boat was built in which Orellana (q.v.) started down the Napo River to seek food. Failing in this, Orellana deserted his chief, and became famous for making the first voyage down the Amazon. Pizarro eventually succeeded in getting back to Peru with a small remnant of his force. After the death of the Marquis Gonzalo remained in Peru to look after the interests of the family. When Blasco Nuñez Vela came from Spain with the title of Viceroy to assume the government of Peru and enforce the "new laws," doing away

with abuses in the treatment of the Indians, Gonzalo was persuaded to head a revolt against the Viceroy (1544). He occupied Cuzco, gathered a considerable army, and marched on Lima, capturing the city. The royal audiencia recognized Pizarro as Governor of Peru, and on October 28, 1544, he made a formal entry into Lima. The Viceroy returned from Panama, but was defeated at Anaquito, June 18, 1546, and all the royal party recognized Pizarro or left Peru. Gonzalo devoted himself to developing the mining regions, founding cities, and making large agricultural grants to settlers. In the spring of 1547 Pedro de la Gasca arrived with a powerful force to reestablish the royal power. Gonzalo, mustering his forces, marched against the royalists near Lake Titicaca, where he completely defeated them, October 26, 1547. Gasca soon collected his forces and marched on Cuzco. The armies met on the plain of Saesahuana, April, 1548, and as the battle was about to begin most of Gonzalo's best troops went over to the enemy. Realizing the situation, Pizarro followed surrendering himself. Gasca promptly called a council of war, which condemned Pizarro to death, and he was beheaded a few days afterwards.

PIZARRO. A melodrama by Sheridan, produced in 1799. It was taken from Kotzebue's drama *Die Spanier in Peru*, with some alterations, and became very popular on account of its patriotic sentiments.

PIZZICATO, pèt'sè-kä'tò (It., twitched), abbreviated *pizz.* A word used in music for stringed instruments to denote that the strings, instead of being played as usual by the bow, are to be twitched with the fingers in the manner of a harp or guitar. The letters *c. a.* (*col arco*, with the bow) indicate that the use of the bow is to be resumed.

PLACE, FRANCIS (1771-1854). An English reformer. He was apprenticed to a maker of leather breeches and himself worked at that trade and as a tailor. In 1794 he joined the London Corresponding Society, a reform club, and for three years was prominent in its work. After ten years of retirement (1797-1807) he returned to politics, made the acquaintance of William Godwin, Robert Owen, Jeremy Bentham, James Mill, and many others, and about 1812 began indirectly a great work, acting as tutor or coach to various Parliamentary reformers, among whom Joseph Hume should be mentioned. In 1824 he procured the abolition of the provisions against workingmen's combinations. Seven years afterwards he was interested in the Reform Bill, and by his placard, "Go for Gold and Stop the Duke," brought on a brief run on the Bank of England and contributed to the causes preventing Wellington's forming a Cabinet. With Roebuck he wrote various political pamphlets in 1835. Consult Wallas, *Life of Francis Place* (London, 1898).

PLACE, plàs, VICTOR (1822-75). A French Assyriologist and diplomat, born in Paris. He entered the Foreign Office in 1839, acted as consular agent in Naples, Gibraltar, and Haiti, showing himself able and brilliant, but grasping and self-seeking. In 1851 he became consul at Mosul, succeeding Botta, whose work of excavation at Khorsabad he continued in conjunction with Oppert and Fresnel. His discoveries, especially regarding Assyrian architecture, the large use made of

colored enameled bricks on the lower parts of city walls, and the variety and brilliance of borders and figure decorations on these mural facings, were very valuable. The actual spoils of the excavations were loaded on a float buoyed with bladders, but in spite of these precautions they were lost in the river near Basra and could not be recovered. Place was highly honored by the Academy of Inscriptions on his return to France in 1855, and became consul-general at Jassy in Moldavia, a post from which he was soon removed because of his abuse of power. He was sent to Adrianople in disgrace, but in 1870 was transferred to New York, where he took advantage of his office and his country's need, bought defective rifles for the French army, and charged so high a price for them that he made more than 600,000 francs for himself before he was discovered. He was twice tried in Paris, and was sentenced to ten years' imprisonment in 1872, but was pardoned by Thiers. Place's *Ninivé et l'Assyrie* (1867-70), text 2 vols., plates 1 vols.) is an authority on Nineveh.

PLACENTA (Lat., flat cake). The after-birth—a spongy vascular mass attached to the uterus before the birth of a young animal and expelled after labor is completed. It is the structure that unites the fetus to the wall of the maternal uterus. It occurs in all mammals except the egg-laying Ornithorhynchus and Echidna, though only rudimentary in the marsupials. It presents a variety of forms among the different mammals. Thus in the pig, mare, and the Cetacea it is diffused over the whole interior of the uterus and is termed *diffuse*; in ruminants it is attached in scattered segments over the uterine wall, *cotyledonary*; in certain of the Edentata, the elephant, and Carnivora it occurs as a zone around the uterine surface, *zonary*; in most of the Edentata, the Insectivora, and Rodentia it is found as a circular disk, *discoidal*; while in the monkeys and man, being first arranged in scattered patches and later as a disk, it is known as *meta-discoidal*. The placenta is formed in its greater part from hypertrophy and other changes in those chorionic villi which chance to be in contact with the uterine surface when fetation begins. The development of these adherent villi produces what is known as the fetal portion of the placenta, while the decidua serotina (see FŒTUS) furnishes the maternal portion. Around the placental villi are developed vascular spaces in which certain arteries and veins from the uterine wall communicate freely. The villi being thus immersed in the maternal blood, osmotic interchange takes place between the fetal and maternal circulations. On gross inspection the placenta presents itself as a round or slightly oval disk from six to eight inches in diameter and from three-quarters to an inch in thickness. Its weight is about a pound. The fetal surface is smooth and covered by the amniotic membrane, which is reflected from the cord on to the placenta at its centre and again from the placental margins to the uterine wall. The maternal surface is deep red, rough, and irregular, and divided by numerous grooves or sulci. A close inspection shows this surface to be covered by a fine delicate membrane which dips down into the sulci and which is the stripped-off cellular layer of the decidua serotina. Attached to the fetal surface of the placenta, usually at its centre, but occasionally

at or near its margin, is the umbilical cord. The cord is a whitish semi-transparent structure of an average length of about twenty inches and a diameter about that of the little finger. It consists of two arteries and a vein twisted upon one another and surrounded by a peculiar substance called from its consistence the jelly of Wharton, which gives the cord its characteristic appearance.

The function of the placenta is both respiratory and alimentary. It aerates the fetal blood by gaseous interchange of oxygen for carbon dioxide and other gaseous waste products. (See CIRCULATION; and BLOOD.) In its nutritional function it supplies material for the rapid growth of the fetus, at the same time removing the products of tissue decomposition. The placenta is subject to several pathological abnormalities in form and attachment, to inflammation, and to degenerative changes. For their detailed description, and for the treatment of that dangerous form of misplacement known as placenta previa, consult: Jewett, *The Practice of Obstetrics* (New York, 1900); *American Systems of Gynecology and Obstetrics* (ib., 1899).

PLACENTA. In plants, the region to which ovules are attached in a plant ovary. It sometimes appears as a mere thickening of the walls, or as a more decided projection from the walls—parietal; sometimes several are united in a central column—axial. These distinctions are important distinguishing characters of certain natural orders. The number of placenta corresponds with double the number of carpels, each carpel normally producing two rows of ovules.

PLACENTIA. The ancient name for Piacenza (q.v.).

PLACE OF WAILING. An inclosed place near the Mosque of Omar in Jerusalem, where the Jews congregate on Friday to lament the fall of Israel and pray for its restoration. The wall at which they gather is believed to be the only remaining part of Solomon's temple.

PLACETAS, plā-sā'tās. A town of the Province of Santa Clara, Cuba, 22 miles southeast of the city of Santa Clara, and connected by rail with the coast towns of Caibarien and Sagua la Grande (Map: Cuba, F 4). It is in the midst of an extensive sugar-producing region. Its population in 1899 was 5409.

PLACIDE, plā-sēd', HENRY (1799-1870). A noted American comedian, born in Charleston, S. C., September 8, 1799. He was the son of a French dancer, and his training for the stage began in childhood. After several years in the South he made his appearance in 1823 at the Park Theatre, New York, as Zeckel Homespun, one of his most popular characters, and for the next twenty years he was a member of the Park Theatre company. Here and afterwards as a star he seems to have won the unmingled admiration of the critics in rôles as varied as those of the fat boy in *Pickwick*, Sir Harcourt Courtly in *London Assurance*, Sir Peter Teazle, Dr. Ollapod, and Grandfather Whitehead. After his retirement in 1865 he settled in Babylon, L. I. where he died, January 23, 1870. Consult: Ireland, *Records of the New York Stage* (New York, 1866-67); Keese, *A Group of Comedians* (ib., 1901).

PLACID'IA. See HONORIUS, and VALENTINIANUS III.

PLACODERM (from Gk. πλάξ, *plax*, tablet, plate + δέρμα, *derma*, skin). An order under the subclass Ganoidei in the older classifications of fossil fish. It included genera in which the head and forward part of the trunk were covered by heavy plates; for example, *Pterichthys*, *Bothriolepis*, *Coccosteus*, *Dinichthys*. The group was based on superficial resemblances, and it has been broken up and the genera distributed among other orders. See OSTRACODERMI; LUNGFISH; ΔΙΠΝΟΙ; and articles on the genera mentioned above.

PLACOIDEI, plā-koi'dé-i (Neo-Lat. nom. pl., from Gk. πλακώδης, *plakōdēs*, flat, from πλάξ, *plax*, tablet, plate + εἶδος, *eidos*, form), or **PLACOID FISHES.** An order of cartilaginous fishes, in the classification proposed by L. Agassiz, characterized by having 'placoid' scales, irregular plates of hard bone, not imbricated, but placed near together in the skin. These scales or plates are of considerable size in some fishes, but in others they are very small tubercles, as in the dogfish, of which the skin forms fine-grained shagreen. The term is no longer in scientific use.

PLACOPHORA (Neo-Lat. nom. pl., from Gk. πλάξ, *plax*, plate, tablet + φέρειν, *pherein*, to bear). A division of Mollusca, containing only the chitons. The modern chitons are descendants of a race which, though never represented by any considerable number of species or individuals, began in the early Paleozoic and persisted with little change of form down to the present day. The first are known in the Ordovician rocks, they are scattered through the Silurian and Devonian, and they attained a slight prominence in the Carboniferous. The Paleozoic species number about 20, and they are distinguished from those of the Mesozoic and Tertiary by the less perfect articulation of their valves and lesser degree of ornamentation of the surfaces of their shells. Few Mesozoic species are known and the group is represented in the Tertiary by about 50 species that show very close relationship to the modern forms.

PLA'GIARY, Sir FRETFUL. A vain and irritable character in Sheridan's play *The Critic*, intended to ridicule Richard Cumberland, the dramatist.

PLAGIAULAX. A genus of Jurassic mammals, typical of the family (Plagiaulacidæ), known only from lower jaws fossilized in the English Purbeck beds, which imply an animal of the size of a small rat and representing the primitive multituberculate type of dentition. (See illustration.) It is believed the rodent-like incisor teeth did not grow from persistent pulps, and they have no anterior coating of enamel. The centre of the two molars on each side is hollowed, and the raised rim is biset with tubercles. Associated genera are *Bolodon*, *Allodon*, and *Ctenacodon*, the last named based on lower jaws found in the Laramie formation of Wyoming.



PLAGIAULAX MINOR.
Right lower jaw, showing molars (m) and premolars (p).

Woodward says that the family does not seem to have become extinct until early Tertiary times, for two other genera, *Neo-plagiulax* and *Ptilodus*, are known from the lower Eocene of France and New Mexico respectively.

PLA'GIOCLASE (from Gk. *πλάγιος*, *plagios*, oblique + *κλάσις*, *klasis*, fracture, from *κλάν*, *klan*, to break). A name originally introduced by Breithaupt and applied by him to the triclinic feldspars of the albite-anorthite series of minerals contained in the feldspar group. See **FELDSPAR**.

PLAGIOSTOMI, plāj'ī-ōs'tō-mī (Neo-Lat. nom. pl., from Gk. *πλάγιος*, *plagios*, oblique + *στόμα*, *stoma*, mouth). A suborder of cartilaginous fishes, including the sharks and rays. See **ELASMOBRANCHII**.

PLAGUE (Lat. *plaga*, plague, destruction, injury, blow, from *plangere*, connected with Gk. *πλήσσειν*, *plēssein*, Lith. *plakti*, to strike, and possibly with Goth. *flōkan*, OHG. *fluohhōn*, Ger. *fluchen*, to curse), **PESTIS**; **PESTIS BUBONICA**; **PESTIS INGUINALIS**; **BUBONIC PLAGUE**; **BLACK DEATH**. An acute infectious disease caused by the presence of a specific microbe and characterized by the enlargement and suppuration of lymphatic glands.

HISTORY. Under **BLACK DEATH** is given the history of plague to and including the pandemic of 1334 to 1351, when China, India, Persia, Russia, Germany, Italy, France, England, and Norway were devastated, and many millions of deaths resulted. Proust is authority for the statement that between the eleventh and fifteenth centuries at least thirty minor epidemics of the disease appeared in different parts of Europe. A grave and important epidemic was traced from Syria to Marseilles in 1720, when 86,000 people fell victims to the plague in that city. During the epidemic of 1770-71, which probably passed from Jassy through Kiev, 80,000 persons lay dead of the scourge in Moscow alone. Early in the nineteenth century Constantinople became the seat of two severe epidemics, one in 1803, with 150,000 deaths, and the other in 1813, with 110,000 deaths. The Balkan peninsula was visited by the dread disease on several occasions between 1814 and 1841; Greece suffered in 1828, and the southern part of Italy in 1815. Russia, in the neighborhood of Astrakhan, was swept by an epidemic from 1877 to 1879. While Europe was passing through this history and finally emerged from the shadow of the plague in 1879, Africa and Asia were suffering terribly. Kitasato reports 21 epidemics between 1783 and 1844 in Egypt. Tripoli suffered in 1874, as did also Arabia. In the river valleys of the Tigris and Euphrates outbreaks of plague occurred in 1773, and several subsequently and as lately as 1876, from which date it raged until 1895. The plague in Persia has been intermittent and of frequent occurrence; perhaps the epidemic of 1876-77 is most noteworthy, because it was the source of the Russian infection in 1877. In India the disease has been endemic for centuries, although reliable and accurate accounts date only from 1815. Its record since that date has been unbroken. Bombay has been a special sufferer since 1896. To trace or chronicle the course and outbreaks of the plague in China is very difficult. The greatest visitation of the scourge, in 1342 and the following years, has been

described. (See **BLACK DEATH**.) There were outbreaks of the disease in 1850, 1866, 1871 and 1872, and subsequently. The pandemic of 1894 continues. It has been learned since Japan annexed Formosa that plague has existed in the latter country for a very long time.

CAUSE. Plague is not caused by filth, overcrowding, diseased grain, or inundations. It is always caused by the presence of the plague bacillus, or *Bacillus pestis*. The microorganism was discovered independently by Kitasato and Yersin in 1894. It is a small oval rod, short and thick, with rounded ends that take stain more readily than the central portion, showing the 'pole staining.' The bacilli are found in pairs or singly, and, in cultures, arranged in chains. They do not form spores and are motile. They occur in enormous numbers in the smaller glands (buboes), in the spleen, and after death in the blood. The lower animals, especially rats, are infected in large numbers from the dust in pest-laden houses. The unsanitary conditions under which the affected individuals live give ample opportunity for the direct or indirect transmission of the disease from patient to patient. Flies and other insects carry it. (See **INSECTS, PROPAGATION OF DISEASES BY**.) Kitasato considers that the bacillus may enter the body by the skin surface, through cracks or wounds, by the respiratory passages, or by the alimentary canal.

SYMPTOMATOLOGY. Two forms of the dread disease are described—*pestis major* and *pestis minor*. *Pestis minor* includes various pathological conditions, all of favorable prognosis, presumed to be caused by the plague infections. Slight fever, slight swelling of the glands, or local tenderness with trivial systemic involvement, constitute the attack. In other cases, prostration, headache, vertigo, and gastro-intestinal disturbances occur. Those cases occurring in houses in which plague has been found, and during a plague epidemic, are considered to be related to the scourge; but no bacteriological examinations have verified the suspicions. *Pestis major* (the severe or ordinary plague) may be of one of the following five varieties: (1) Bubonic, (2) pneumonic, (3) septicæmic, (4) pyæmic, or (5) local inoculation. An average attack of ordinary bubonic plague presents the following course: The period of inoculation lasts from three to seven days. The period of invasion, or prodromal period, varies from 24 to 48 hours in length, and during it the patient suffers with chills, fever, weakness, lassitude, vertigo, headache, and vomiting. Bubo development follows, with staggering gait, tremulous speech, and great restlessness; a temperature of 104° F. or higher; a full pulse, averaging 130 to the minute; a dry granular tongue covered with a yellow velvety fur, but with a red margin; an anxious and pallid face; constipation; and the enlargement of glands in the neck, groins, or axilla, constituting the buboes. Following the appearance of the buboes occurs a fall in temperature and pulse rate, and this generally on the second or third day of the disease. After a remission of a little over two days, the fever ascends to 103° or 105° F., at which point it remains for seven days, during which time the bubo reaches its full development. After 10 days the temperature falls. Emaciation and exhaustion are extreme. The patient may now die of heart failure, in syncope; or of

hemorrhage, of peritonitis, of jaundice, of hyperpyrexia; or he may recover after about two months' convalescence. The buboes often suppurate, or become necrotic, sometimes involving considerable areas of surrounding tissues. Sometimes foci of broncho-pneumonia are found in the lungs, each focus surrounded by a congested pulmonary tissue. Occasionally the alveoli are found full of sanguinolent fluid which is swarming with plague bacilli. Or, multiple abscesses and pulmonary infarcts are noted. These cases in which lung involvement is prominent are called pneumonic plague.

PROGNOSIS, MORBIDITY, AND MORTALITY. In the vast majority of cases the prognosis of the disease is extremely unfavorable, much depending on the character of different epidemics. Septicæmic and pneumonic cases are almost always fatal. After convalescence, weakness and a neurasthenia may persist for a long period. The rate of mortality varies much. In certain epidemics from one-half to three-quarters of an entire population has perished. In the Hong Kong epidemic of 1894 the mortality was 95 per cent. In Bombay during 1896 and 1897 it was 50 to 60 per cent., while during 1898 to 1901 it averaged 80 per cent.

PROPHYLAXIS. As the eliminated bacilli may enter the healthy individual directly by cutaneous infection, by inhalation, or by ingestion (as has been abundantly proved), or may enter indirectly, by means of flies, fleas, rats, etc., it is evident that inspection, isolation, and disinfection must be employed to prevent or limit an epidemic of plague. Among the preventive methods are general hygiene, good drainage, clean water-supply, cleanliness in dwelling houses, and cleanliness of streets. Isolation of the sick must be early employed, and infected dwellings must be thoroughly disinfected, as also wearing apparel, bed linen, etc. Formaldehyde gas is probably the most thorough and convenient disinfectant. Chloride of lime is recommended for disinfecting feces, as well as for covering dead bodies of human beings, as well as of all animals dying during an epidemic. Isolation of the convalescent must be continued, according to Kitasato, for a month after apparent recovery; for the plague bacilli are found in the blood for a period varying from three to four weeks after the cessation of all symptoms of the disease. Rigid quarantine may be necessary during an epidemic.

Specific prophylaxis may be employed before or during an invasion of the dread disease by means of 'Yersin's antipest serum' or 'Haffkine's prophylactic fluid.' The serum devised by Yersin is blood serum taken from horses that have been inoculated with the plague. Hypodermic injection of the serum causes immediate immunity, which unfortunately lasts only 12 to 14 days. A difficulty in securing acquiescence in repeated injections at once arises, and as a popular treatment it is under a disadvantage. Haffkine's fluid is a culture of the *Bacillus pestis* rendered virulent by special methods, the bacilli, after abundant growth, being killed by an exposure to a temperature of 70° C. for several hours. Inoculation with Haffkine's fluid has the advantage of conferring immunity lasting from a few days to several months. Calmette, director of the Pasteur Institute at Lille, France, states that a single inoculation of three cubic centi-

eters of Haffkine's fluid a month old establishes immunity only after the seventh day and for a variable period thereafter. A great disadvantage in the use of the prophylactic fluid lies in the facts that during immunization the person is more susceptible to plague; and that if he already had contracted even a mild attack, the inoculation would be fatal. Authorities recommend the provision of antipest serum for prompt use in order to arrest an epidemic in the first cases, and the employment of Haffkine's fluid to inoculate the people dwelling in localities threatened with an invasion of the disease.

TREATMENT. The treatment of plague has been in the past mainly symptomatic. Early administration of calomel, followed by antipyretics, tepid sponging, alcoholic stimulants, ether, camphor, ammonia, and digitalis have all been of benefit in mild cases. Incision of the bubo and excision of suppurating and sloughing glands have been practiced. But the best results have been obtained from the use of Yersin's serum. It has increased recoveries 15 per cent., besides being an unquestioned preventive. In Belgium, India, in 1900-01, where a systematic test of the prophylactic was made, 61.4 per cent, was the mortality. In the fall of 1899, Lord Curzon, Viceroy of India, who gave personal attention to the plague hospitals and segregation camps, enthusiastically advocated inoculation with Haffkine's fluid, and set an example by having himself and his party inoculated, which was of great value in preventing panic and in encouraging proper measures for protection.

RECENT SPREAD OF THE PLAGUE. The scourge reached England in 1899, in the person of a sailor from Calcutta, who was landed at Plymouth. To the same port a coal-trimmer from Bombay was brought, suffering from plague. In England, in 1900, there were four cases, with two deaths; in 1901 there were 14 cases and 11 deaths. Eleven cases were reported in Glasgow in 1900, with one death. New York City was reached by the plague in November, 1899, on a coffee steamer from Santos, Brazil, aboard of which two men were sick with plague on reaching quarantine. There was no spread of the disease. In December, 1899, the fell disease appeared in Honolulu, Hawaiian Islands, probably brought from Japan. There were four cases and two deaths. In 1900 the islands reported 84 cases, with 64 deaths; in 1901, 13 fatal cases. In 1900, of two cases reaching the port of New York, one proved fatal in quarantine; in 1901 a stoker on a steamer from Calcutta appeared at quarantine as a case of plague. Undoubted bubonic plague was uncovered in November, 1900, in the Chinese quarter of San Francisco, and a large area was declared infected. Great difficulty was experienced by a special commission which explored this quarter, and which finally reported in 1901 that there had been in all 42 fatal cases of the plague in San Francisco. Manila, P. I., furnished a few cases of plague in 1899, and in 1900 there were 399 cases, with 281 deaths, reported from the Philippines; while in 1901 the figures reported were 497 cases, with 375 deaths.

The United States Marine Hospital Service prepares at its hygienic laboratory a quantity of the prophylactic fluid of Haffkine, for distribution to national, State, and local quarantine officers throughout this country. The Pasteur In-

stitutes at Lisbon and at Paris distribute anti-plague serum to different parts of Europe.

PLAGUE, CATTLE. A disease of cattle. See **TEXAS FEVER.**

PLAGUE YEAR, JOURNAL OF THE. An imaginary narrative by Daniel Defoe (1722) of the plague of London in 1665, so vivid and realistic that it has often been taken as actual history.

PLAGUES OF EGYPT. A series of miraculous signs and judgments by which, according to Exodus vii. 8-xi. 10; xii. 29-xiv. 26-29, Moses and Aaron proved that they were messengers of Yahweh, Israel's God, and punished the people of Egypt for the King's obstinate refusal to let the Israelites go into the wilderness to celebrate a festival. Ordinarily the plagues are regarded as 10 in number, viz.: (1) The turning of the river into blood, (2) frogs, (3) lice, (4) flies, (5) murrain, (6) boils, (7) hail, (8) locusts, (9) darkness, (10) the slaying of the first-born. It is evident, however, that the author of Exodus iv. 9 looked upon the turning of water into blood as the third sign, two others having preceded, the change of a rod into a serpent and the serpent into a rod again, and the hand turning leprous and being restored. All scholars are agreed that the narration is composite. Although the original Yahwistic and Elohist (see **ELOHIST AND YAHWIST**) narratives have not been preserved intact in the priestly redaction (see **HEXATEUCH**), it is possible to discern the general characteristics of each. The Yahwist made Moses merely the proclaimer of each sign, which then was wrought by Yahweh himself, while the Elohist made Moses stretch forth his hand and bring the evil upon Egypt. The Yahwist seems to have told of seven plagues, viz. the waters smitten, the frogs, the flies, the murrain, the hail, the locusts, and the death of the first-born. Of the Elohist plagues only the turning of the water into blood, the hail, the locusts, the darkness, and the death of the first-born seem to have been retained, though it is possible that this document also contained another pentad, viz. the rod and the serpent, the leprous hand, the frogs, the lice, and the boils. It is generally recognized that the flies and the lice are the same plague, and also that the murrain and the boils are only variants. The priestly editor naturally introduced Aaron and his rod, and otherwise combined and retouched the narration so as to emphasize the contrast between the Egyptian magicians and the chosen representatives of Israel's God. It is to be noticed that the Yahwistic story, which is probably of Judean origin, has least of a distinctive Egyptian setting, while the Ephraimitish author of the Elohist narrative here as elsewhere reveals more familiarity with Egypt. The priestly redaction, which dates from the Persian period, reflects a crystallized tradition as to Israel's deliverance from Egypt and the triumphant conflict with heathen idolatry and magic. The attempt to save the number 10 probably found in the Elohist may account for the separation of the rod and serpent sign and the awkward fact that the threatened sign of the leprous hand is not carried out. The increasing evidence that there was a State in North-western Arabia called by the Assyrians Muzri has led some critics and historians to the view that the scene of these plagues was originally laid not in Egypt, but in this Arabian Muzri,

south of Syria. It seems to be in harmony with the view that the Judean story, supposed to be the earliest, presents a series of calamities that may befall any country. There is no natural succession depending on the local phenomena of Egypt. The miraculous element is indeed present, all such evils being regarded as direct blows struck by an angry deity. But the memory of some extraordinary sufferings of the people in Muzri connected with or causing the departure of Moses' clan may well have been the historic nucleus of the story. Canon Cheyne thinks of the sacrifice of the first-born by the Muzrites as the occasion of the migration of those who preferred to redeem their first-born. If this were so, the demand to go away to celebrate the leap-feast, at which the firstlings of the animals but not men were offered, would possibly be a part of the original tradition. But the story of Jephthah's offering (see **FESTIVALS**; **JEPHTHAH**) seems to show that the substitution of redemption for actual sacrifice was introduced at a later time. It has been maintained that especially the so-called priestly writer bases his plagues throughout upon the order in which such occurrences would naturally come in Egypt in the course of the year. It is extremely doubtful, however, whether the story in any form connected the change of the water into blood with the discoloring of the Nile water as it rises at the end of June. This was not a calamity, but the earnest of great blessings. The heaping up of dead frogs would naturally cause various plagues. But it is evident that to these authors each plague is a fresh miracle. Consult: Dillmann, *Exodus and Leviticus* (Leipzig, 1880); Holzinger, *Exodus* (Tübingen, 1900); Baentsch, *Exodus-Leviticus* (Göttingen, 1900); Macalister in the *Hastings Dictionary of the Bible*, vol. iii. (New York, 1900); Cheyne in *Encyclopædia Biblica*, vol. iii. (London, 1902).

PLAICE (OF. *plais*, Fr. *plaise*, Sp. *platiya*, from Lat. *platessa*, flatfish, plaice, from Gk. *πλάρῆς*, *platys*, flat. Lith. *platus*, broad, Skt. *prthi*, wide, from *prath*, to spread out). (1) A European flounder (*Pleuronectes platessa*) rather broad in proportion to its length; the upper surface of the body and the fins olive-brown, marked with large bright orange spots; a row of similar spots on the dorsal fin and on the anal fin. The plaice inhabits sandy and muddy banks, not in very deep water, feeds on worms, mollusks, small crustaceans, and young fishes, and ordinarily weighs seven or eight pounds. It is taken both by lines and trawl nets, and its flesh is highly esteemed. (2) In America the name is locally applied to the summer flounder (*Paralichthys dentatus*; see **FLOUNDER**), an extensive account of which is given in Goode, *Fishery Industries*, sec. i. (Washington, 1884). See Plate of **FLAT-FISH AND FLOWNERS**.

PLAIDEURS, plá'dēr', LES. The only comedy of Racine (1668). It was suggested by the *Wasps* of Aristophanes, and ridicules the customs and abuses of the French legal profession. Its three acts abound in amusing situation and sparkle with wit.

PLAIN (OF. *plain*, from Lat. *planum*, level ground, plain, neu. sg. of *planus*, level, even; connected with Lith. *plónas*, flat, OPruss. *plonis*, threshing-floor, OLat. *palma*, Gk. *πλάμη*, *plamé*, flat of the hand, *πλαξ*, *plax*, plain, *πλανᾶν*, *planan*,

to wander, OHG. *flah*, Ger. *flach*, flat. OHG. *rluor*, Ger. *Flur*, AS. *flōr*, Eng. *floor*, OIr. *lār*, floor). An expanse of level or gently sloping land. In contrast with a plateau, the surface of a plain is disposed at a low elevation, generally less than 1000 feet, although no sharp line of division can be drawn between the two. The Great Plains of the United States have an elevation on the western border of 2000 feet or more. In respect to their origin, plains may be classed as marine, lacustrine, fluvial, and plains of denudation. *Marine plains* are formed by the deposition of sediment beneath the sea. The debris brought down by rivers to their mouths is carried seaward by tides and currents and distributed over a wide area. Thus in time a broad belt of sedimentary strata accumulates along the margins of continental lands, and these sediments may subsequently be raised into land. The Coastal Plain (q.v.) which extends along the Atlantic and Gulf borders of the United States and the North German Plain have been formed in this manner. The marine origin may be demonstrated by the character of the fossils included in the strata. *Lacustrine plains* occupy the basins of former lakes whose disappearance may have been brought about in various ways. The celebrated Vale of Kashmir in Northwestern India and the great Hungarian Plain are covered with fine sediments that were deposited in bodies of fresh water before the outlets had been cut down. In Nevada and Utah there are extensive lacustrine plains which have been laid bare owing to a change of climate from moist to arid conditions, and similar plains are known to occur in Central Asia. A peculiar type is that illustrated by the valley of the Red River of the North; during the Glacial period a great lake was formed here only to disappear with the retreat of the obstructing ice-sheet. (See LAKE, LAKE AGASSIZ.) *Fluvial plains* are built up by the deposition of silt along the borders and at the mouths of rivers. The Mississippi, the Nile, the Ganges, and most of the large rivers of the world have constructed extensive fluvial plains. (See FLOOD-PLAIN; DELTA.) *Plains of denudation* owe their origin to erosion. When land has acquired considerable elevation above the sea the surface is dissected by the action of running streams which are constantly engaged in widening and deepening their channels. This process when carried to completion results in the reduction of the divides between the streams, producing a broad lowland whose surface lies but little above sea level. If the former elevations are still indicated by unconsumed hills the lowland is called a peneplain. The plain thus produced may again be elevated and once more subjected to the process of dissection and base-leveling. The great plain of Central Russia and the lowlands bordering the Appalachians have probably been formed in this way. See GEOGRAPHY; PHYSIOGRAPHY.

PLAIN, THE. In the history of the French Revolution, the moderate party in the Legislative Assembly and Convention, so called in contradistinction from the Mountain (see MONTAGNARDS).

PLAIN CHANT. A term applied to the ecclesiastical chant of the Roman Catholic Church. This style of music was used in the Church from the earliest times. It has certain characteristics which distinguish it from any other known music.

All the melodies have a stateliness and quiet dignity rendering them particularly appropriate for the use of the Church. The tempo is moderate, and each melody is written in one of those tonalities known as the Church modes. (See MODES.) For the notation a staff of four lines is used, and the notes are all black and square or lozenge-shaped. For the history and development of this system of plain chant notation, see MENSURABLE MUSIC and MUSICAL NOTATION.

The origin of plain chant has been the subject of much speculation, but the best authorities now agree that it seems exceedingly probable that the chants of the early Christian Church were either taken directly from or modeled after those of the Hebrews. This supposition is borne out by the information we possess regarding the performance of the music during the first three centuries of the Christian Era; for the singing was antiphonal, i.e. a precentor intoned the melody and the chorus answered. We have the testimony of Philo, a Hebrew writer of the first century, that the psalms in the Christian Church were rendered by a double chorus singing in alternation. It does not seem probable that these old psalms should have been sung to any other music than the old tunes. This music is scarcely more than emphatic declamation moving within the compass of a fifth; only the cadences present a little more melodic variety. The use of instruments was strictly forbidden, because these played an important part in the religious cult of the pagans. This prejudice against instruments lasted for centuries. Plain chant, the only form of music ever officially sanctioned by the Church, never made use of instruments. Even the complicated polyphonic works of the school of the Netherlands and the great Roman school banish instrumental accompaniment. It is only with the rise of the school of Venice toward the end of the sixteenth century that instruments find their way into the Church. When the plain chant melodies arose harmony was utterly unknown, and, consequently, the whole theory of music turned about melodic progression. Choral singing meant nothing else than singing in unison. As long as the persecutions compelled the early adherents of the faith to worship secretly in the catacombs, it was impossible to establish a universal liturgy. However, the melodies were preserved among the various congregations and handed down from generation to generation by oral tradition, though we can scarcely doubt that in the course of time the original melodies became more or less distorted. When, after the conversion of Constantine in 312, Christianity became the State religion, free intercourse between the different congregations became possible. Choirs were formed and received special training, so that congregational singing disappeared more and more. At the Council of Laodicea in 367 a decree was passed prohibiting any one but the regularly trained singers from singing in church. In the beginning of the fourth century Pope Sylvester established a singing-school at Rome, which resulted toward the end of the same century in the composition of original hymns. Some of the oldest of these hymns are attributed to Saint Hilary, who was Bishop of Poitiers about 335. Saint Ambrose, Bishop of Milan, who died in 397, devoted all his energies to the arrangement and systematizing of all the then known plain chant melodies. To him is also ascribed the introduction of the

four authentic modes, which he selected from among the seven octave species of Ptolemy, because these four most closely resembled the character of the ancient psalm-tones. Although the four authentic modes correspond to the Greek Phrygian, Dorian, Hypo-Lydian, and Hypo-Phrygian modes, the Greek names were discarded and the appellations *protos*, *deuteros*, *tritos*, and *tetartos* substituted. Saint Ambrose also composed a great number of original hymns, such as: *Deus, creator omnium*; *Æterne rerum conditor*; *Veni, redemptor gentium*; *Jam surgit hora tertia*. See AMBROSIAN CHANT.

After the death of Saint Ambrose the original purity of plain chant melodies was corrupted. When in 590 Gregory I. became Pope, church music was in a deplorable state. Recognizing the fact that music is one of the greatest aids to religion, Gregory began his reforms by establishing the *Schola Cantorum*, which in a very short time rose to an institution of the highest importance and for centuries preserved the ancient traditions. Since the time of Saint Ambrose a large number of new hymns had been composed. The old monotony of the chants had given place to a more varied melody, and this naturally led to an extension of the compass beyond the original fifth. The four original or authentic modes were no longer sufficient. Gregory is credited with having established the four *psalmodies* to meet the demands of the advanced art. Besides, he also selected the chants that were to be sung on every day throughout the Church year. The texts and melodies he ordered to be written in a book called *Antiphonarium*, which was declared to be the absolute authority in matters of church music. The system of notation employed in this book is that known as Neumes (q.v.), consisting of various signs placed above the syllables without employment of a staff. After plain chant had thus been reformed it spread with astonishing rapidity over all Europe. Especially Charlemagne was instrumental in promulgating this *Cantus Romanus*; for at diets held at Aix-la-Chapelle in 803 and Diedenhofen in 805 he issued strict orders to introduce this manner of singing in all the dioceses of his empire, and established singing-schools in various cities, as Soissons, Toul, Orleans, Cambrai, Lyons, and Dijon. Even before the accession of Charlemagne singing-schools had been founded at Fulda and Saint Gall, but as new hymns were constantly being written, the purity of the style was almost certain to suffer. Thus in 1323 Pope John XXII. was obliged to issue a bull restraining musicians from unlawful innovations. Acting upon the recommendation of the Council of Trent, Pope Gregory XIII. in 1576 took active steps towards a purification of the style of church music. But by that time the art of music had made enormous strides; polyphonic music had arisen. Although the new music had never been officially sanctioned, it was not only tolerated, but was favored. Composers were in the habit of taking the old plain chant melodies as a *cantus firmus* for the tenor, against which the other voices were set contrapuntally. Many composers had little scruple in distorting the original melodies to suit their purpose. But a greater danger to church music arose from the fact that it became customary to substitute popular secular melodies for the plain chant. At this time Palestrina established the true polyphonic

church style. This is founded upon the church modes; simplicity and noble dignity are its fundamental principles, as they ever have been the principles of plain chant. Since the time of Palestrina no new melodies have been added to the large stock of plain chant. Composers have devoted their talents to polyphonic music, but the old plain chant melodies have remained in constant use up to the present day. The custom at High Mass is to sing the *Kyrie*, *Gloria*, *Credo*, *Sanctus*, and *Agnus Dei* in polyphonic or modern harmonic style with instrumental accompaniment. The Introit, Gradual, Tract (or Sequence), Offertory, and Communion, if sung by the choir, are sung in unison to the old plain chant melodies, to which the organ supplies the harmonies strictly in accordance with the rules governing the church modes. The *Sursum corda*, Preface, and *Pater noster* are set to the ancient unvarying melodies. The advance of musical archaeology during the past century has done much toward the restoration of the plain chant melodies to their original purity. Pope Pius IX. ordered the Sacred Congregation of Rites to revise and publish, with the sanction of the Holy See, the entire treasure of plain chant melodies. The first volume appeared in Ratisbon in 1871, and within ten years the work of revision was completed.

The discovery and study of old manuscripts during the last half of the nineteenth century has brought to light many facts formerly not known. Some scholars cast doubt upon the work commonly ascribed to Gregory I. But the old tradition was not seriously shaken until the learned F. A. Gevaert in 1890 published his book, *Les origines du chant liturgique de l'église latine*, in which he attacks with weighty arguments the position ascribed to Gregory in the development of plain chant. But this was only the precursor of another book, *La mélodie antique dans le chant de l'église latine*, which appeared in 1895. The first work had raised a host of opponents who were unwilling to surrender a thousand-year-old tradition. In the second book, a work of stupendous learning, Gevaert meets all objections with proofs drawn from various ancient manuscripts and even strengthens his original statements. The important points brought out by the investigation of Gevaert are as follows: (1) The claims made by the adherents of tradition in favor of Gregory cannot be established on any historical grounds. (2) It is a legend that originated during the reign of Charlemagne or slightly earlier. (3) It was not generally accepted until the eleventh century. (4) The work of the compilation and composition of the chants of the Liturgy was in reality the work of the Greek popes that occupied the Papal chair at the end of the seventh and the beginning of the eighth century. (5) The melodies of the *Antiphonale Missarum* received their final form between the accession of Leo II. (682) and that of Gregory II. (715). The Pope that was particularly active in this work was Sergius I. (687-701). (6) The *Antiphonale Officii* had received its final shape during the pontificate of Agatho (678-681). Each of these points Gevaert establishes on the strength of ancient documents of unquestioned authenticity.

For a technical exposition of the nature and history of plain chant, consult Gevaert's learned work already cited, *La mélodie antique dans le chant de l'église latine* (Ghent, 1895). Other works are: Haberl, *Magister Choralis* (Rat-

isbon, 1896); P. Wagner, *Einführung in die gregorianischen Melodien* (Freiburg, 1895); Briggs, *History and Characteristics of Plain Song* (London, 1891); Lootens, *La théorie musicale du chant grégorien* (Paris, 1895); Bonuzzi, *Metodo teoretico-pratico di canto gregoriano* (Solesmes, 1894); Pothier, *Les mélodies grégoriennes* (Tournay, 1880); Dickinson, *Music in the History of the Western Church* (New York, 1902).

PLAIN DEALER, THE. A comedy by William Wycherley, produced in 1674, printed in 1677. The plan was taken from Moliere's *Le Misanthrope*, but the tone of this repulsive story is quite different. The principal characters are the sea-captain, Manly, the Plain Dealer, the crafty and odious Olivia, and the comic Widow Black-aere and her son.

PLAINFIELD. A town including several villages, in Windham County, Conn., 16 miles northeast of Norwich; on the Quinebaug and Moosup rivers, and on the New York, New Haven and Hartford Railroad (Map: Connecticut, H 3). It has public libraries at Moosup and Plainfield villages, and in Plainfield village is the old Plainfield Academy, which was one of the best known in New England toward the close of the eighteenth century. The chief industrial establishments include cotton and woolen mills, thread and yarn factories, a foundry, and wagon shops. The government is administered by town meetings. Plainfield, originally called Quinebeag, was settled about 1691 and was organized as a town in 1699. Population, in 1890, 4582; in 1900, 4821.

PLAINFIELD. A city in Union County, N. J., 24 miles west by south of New York City, of which it is a residential suburb; on the Central Railroad of New Jersey (Map: New Jersey, D 2). It is picturesquely situated at the base of the steep wooded ridge known as First Mountain, is well laid out, and has public parks, the Muhlenberg Hospital, and a public library with more than 20,000 volumes. Plainfield is also an important industrial centre, its manufactures including printing presses, machine tools, silk and cotton goods, carpets, kid gloves, chamois, clothing, lumber, products, carriages, etc. Population, in 1890, 11,267; in 1900, 15,369.

PLAINTIFF (OF, *plaintif*, complaining, from *plainte*, complaint, from Lat. *placatus*, lamentation, beating of the breast in grief, from *plangere*, to strike). Under the common law system of pleading and modern codes, a person who institutes or maintains a civil action or proceeding against another, who is called the defendant. Where a proceeding is commenced by petition, as in a surrogate's court, the moving party is usually called the 'petitioner.' In many jurisdictions a party commencing an action in equity is called the complainant, but under most systems of reformed procedure no distinction of this sort is made. A plaintiff may be one who prosecutes an action on his own behalf, or who does so as a representative for the benefit of another, in which case he adds to his name a description of his official or representative capacity, as 'A. guardian *ad litem* of B. an infant, etc.'

A person who brings an action in a representative capacity is sometimes called a plaintiff *ad litem*. A person who maintains a proceeding or action in an admiralty court is called a libellant.

Consult the authorities referred to under **PLEADING**.

PLAN. A drawing or design representing a horizontal section of a building. It is distinguished from an elevation which represents a vertical section, and best shows the extent of a structure and the distribution of the area into the component parts.

PLANA, plā'nā, GIOVANNI ANTONIO AMEDEO, Baron (1781-1864). An Italian astronomer. He was educated at the Paris Polytechnic School. He held the chair of mathematics at the Alessandria artillery school, 1803-11, and in the latter year became professor of astronomy at the University of Turin. In 1813 he was made director of the Turin observatory. His most important works are *The Theory of the Attraction of Elliptical Spheroids* (1810) and *Theory of the Movement of the Moon* (1832). He was a member of the French Academy.

PLANA'RIA (Neo-Lat. nom. pl., from Lat. *planarius*, flat). A genus of platyhelminthes (flatworms) characterized by having a flat oval body covered with cilia. They live in fresh water.

PLANCHÉ, plān'shā', JAMES ROBINSON (1796-1880). An English playwright and antiquary, born in London February 27, 1796. He wrote for the London theatres more than 200 successful pieces. His first play was a burlesque, *Amoroso, King of Little Britain* (1818); his last was *King Christmas*, a masque (1871). He was at the height of his reputation from 1840 to 1850, when he was bringing out his burlesques and Christmas pieces for Madame Vestris at the Lyceum. Planché had already gained a reputation for his knowledge of costume and heraldry. In 1829 Planché was elected fellow of the Society of Antiquaries, and in 1843 was one of the founders of the British Archæological Society, to which he contributed many papers. In 1866 he was made Somerset Herald. He died at Chelsea, May 30, 1880. Among his valuable works are *Costumes of Shakespeare's King John* (1823-25); *The History of British Costumes* (1834); *Regal Records* (1838); *The Pursuivant of Arms, or Heraldry Founded Upon Facts* (1852); and *A Cyclopædia of Costume* (1876-79). In 1879 appeared *Extravaganzas* in five volumes, and in 1881 *Songs and Poems*. Planché also published collections of fairy tales translated from the French and German. Consult his *Recollections and Reflections* (1872).

PLANCHE, plānsh, JEAN BAPTISTE GUSTAVE (1808-57). A French critic. He was born in Paris, was educated at the Collège Bourbon, and in 1831 began contributing to the *Revue des Deux Mondes*. He was subsequently connected with the *Journal des Débats* (1832), and was an associate of Balzac on the *Chronique de Paris*. He bitterly attacked the works of Victor Hugo and other writers of the Romantic School. His works include *Portraits littéraires* (1836), *Nouveaux portraits littéraires* (1854), and *Etudes sur les arts* (1855).

PLANCHETTE, plān'shēt' (Fr., little board). A heart-shaped board seven or eight inches at its greatest breadth and length, mounted on two pantograph wheels, about two inches high at its widest part, while a pencil fastened at the apex forms its third support. Placed upon a table with a sheet of paper under it, and one or

two persons with the necessary qualifications having their hands upon it lightly, it begins to move and write answers to questions sometimes of a puzzling character. These answers are asserted by believers in spiritualism to be communications from the spirit world.

PLANCK, plänk, KARL CHRISTIAN (1819-81). A German philosopher, born at Stuttgart, and educated in philosophy and theology in Tübingen. In 1844 he became tutor and librarian at the theological seminary there, and lecturer on philosophy at the university. From 1856 to 1869 he was professor at the gymnasium of Ulm, and in 1879 he became principal of the seminary in Maulbronn. Planck defends in his numerous writings the speculative system of philosophy as opposed to that of empiricism. His chief work is *Die Weltalter* (1850), in which he treats of the system of pure realism and subjective idealism. In his *Anthropologie und Psychologie auf naturwissenschaftlicher Grundlage* (1874), he vigorously combats the theories of the atomists and materialists, and he takes his stand against Darwinism in *Wahrheit und Flachheit des Darwinismus* (1872).

PLANÇON, plän'sôn', POL (1860—). A French basso, born in the Ardennes. He was sent to Paris by his parents and there, despite his own inclinations, entered a business house. Through the friendship of Theodor Ritter he was enabled to study music, and finally entered the Ecole Duprez and devoted himself entirely to music. In 1881 he made his debut in *Les Huguenots* at Lyons. Two years later he appeared at the Paris Grande Opéra as Mephisto in *Faust*, in which rôle, as well as that of Ramfis in Verdi's *Aïda*, his success was pronounced. He created the rôles in Saint-Saëns's *Ascanion*, in Massenet's *Le Cid*, and in Gounod's *Sapho*, upon its revival in 1893. He appeared for a number of seasons at the Metropolitan Opera House in New York, where he was a prime favorite.

PLAN'CUS, LUCIUS MUNATIUS. A Roman politician and soldier. He was born at Tibur, near Rome. In youth he was one of Cicero's pupils in oratory, and later was an officer of Cæsar in the Gallie wars. After the assassination of Cæsar, Plancius at first favored Brutus, but soon went over with four legions to Antonius. In B.C. 42 he was consul with Lepidus. In the contest between Antonius and Octavianus he sided with the latter, and proposed in the Senate to confer upon him the title of Augustus. Plancius was a man of some literary taste, and to him one of Horace's odes is addressed.

PLANE (Lat. *planum*, level ground, plain, neu. sg. of *planus*, level, flat, plane, plain). A surface which is determined by any three of its points not in a straight line. A plane surface is said to have zero curvature. When two planes intersect, their intersection is a straight line. The inclination of one plane to another, or the dihedral angle (see ANGLE) between the planes, is measured by the plane angle whose arms lie in the respective planes and are perpendicular to their intersection. When this angle is a right angle, the planes are perpendicular to each other. As a result of the definition, a plane is determined by a straight line and a point not in that line, or by two intersecting lines or by two parallels. A group of several planes having a com-

mon line of intersection is called an axial pencil. Several planes having a common point of intersection are called a sheaf of planes.

PLANE FIGURES. Any combination of coplanar points and lines is called a plane figure. See POLYGON.

PLANE (OF., Fr. *plane*, from Lat. *planatus*, from Gk. *πλατῆνος*, plane tree, from *πλατός*, *platys*, flat, Lith. *platus*, Skt. *prthu*, broad, from *pruth*, to spread out; so called from the broad, flat leaves), *Platanus*. The only genus of the natural order Platanaceæ, tall, large trees of which there are only four or five species. The flowers are in globose, small, pendulous, long-stalked catkins, which give the tree a peculiar appearance in winter. The species of plane are natives of temperate climates in the Northern Hemisphere; have deciduous large palmate leaves, and smooth whitish bark, which annually scales off in large pieces. The Oriental plane (*Platanus orientalis*), a native of Greece and the East, early used by the Greeks and the Romans as an ornamental tree, is extensively planted for shade and ornament in various regions. Few trees better endure the atmosphere of large cities. A tree is reported on the banks of the Bosphorus, which is 141 feet in circumference at the base, extends its branches 45 feet from the trunk, and is believed to be more than 2000 years old. The wood of the plane, when young, is yellowish-white; when old, it is brownish, fine-grained, takes a high polish, and is esteemed for cabinet-making. The tree thrives best in a rich alluvial soil in the vicinity of water. The North American plane, sycamore, or buttonwood (*Platanus occidentalis*), is very



PLANE TREE OR BUTTONWOOD.

similar and is probably the largest deciduous tree of the United States. It abounds on the banks of the great rivers of the Middle States, where it attains a height of 100 to 150 feet and 10-15 feet in diameter. Its timber is not very valuable, and is very liable to decay. Two other species occur in the Southwest, the Californian sycamore (*Platanus racemosa*) and the Arizona sycamore (*Platanus Wrightii*). The name plane tree is commonly given in Scotland to the sycamore or great maple (*Acer pseudo-platanus*), which resembles the plane tree in its foliage. See MAPLE.

PLANE (Fr. *plane*, from ML. *plana*, plane, from Lat. *planare*, to plane, level, from *planus*,

level, flat, plane, plain). A tool used for rendering the surface of wood smooth and level. It consists of an oblong block of wood or metal with an opening through the centre; this opening is square on the upper side, and is always large enough to admit the cutting instrument; it diminishes down to a mere slit on the under side, just wide enough to allow the cutting edge of the plane-iron and the shaving of wood which it cuts off to pass through. The essential part of the tool is the plane-iron, a piece of steel with a chisel-shaped edge, and a slot in its centre for a large-headed screw to work and to attach to it a strengthening plate. In the older wooden planes it was held in place by the hard-wood wedge. By driving in the wedge, the irons are held very firmly in their place, and they are so adjusted that only the fine sharp chisel-edge of the cutting-tool projects through the slit in the bottom of the body of the plane, so that when the tool is pushed forward by the force of the hand the cutting edge pares off all irregularities, until the wood is as smooth as the under surface of the plane. In the iron planes now used the iron is held in the block and adjusted by a screw. There are many modifications in this tool, which can have its cutting edge and under surface made to almost any contour, so that moldings of all kinds may be made. The two commonest are the jack-plane, for rough work, and the smoothing-plane, for finishing off plane surfaces. For planing machines, see METAL WORKING MACHINERY and WOOD-WORKING MACHINERY.

PLANE CURVE. See CURVE.

PLANE OF POLARIZATION. See LIGHT.

PLANER TREE (named in honor of J. S. Planer, a German botanist of the eighteenth century). A moderately sized elm-like tree (*Plataner aquatica*), found on swampy lands in the Southern United States. It supplies a useful hard timber. *Zelkova acuminata* and *Zelkova crenata*, tall, handsome trees which furnish excellent timber, were formerly included in this genus, which is now considered monotypic.

PLANE SAILING. See SAILINGS.

PLANE-TABLE. An instrument used to fill in the details of topographical work (see SURVEYING), and, on account of the ease and rapidity with which it can be operated, popular where only a moderate approach to accuracy is required. The plane-table consists essentially of a mounted drawing-board bearing an alidade or ruler surmounted by a telescope whose line of sight is parallel in azimuth to the ruler. In orienting the table a declinator, or compass box, and a plumbing arm serve to place a given point on the table over that on the ground which it represents, and to cause a line of the drawing on a paper mounted on the board to lie in or parallel to the vertical plane through its counterpart on the ground. After the paper has been attached to the table it is then leveled and oriented as already described. The observer then sights successively at other different objects in the area under survey, revolving the telescope and ruler in azimuth and drawing corresponding lines along the edge of the ruler at each position. All of these lines pass through the given point and give the angular direction of the different objects in the field. The plane-table is then taken to a second station located at some place previously sighted and whose dis-

tance from the first can be measured by stadia, chain, or tape, and is there set up and oriented as before. The distance from the first station to the second is set off at the desired scale on the line connecting the two points, and the telescope is directed at the same objects as were sighted at from the first station, as well as

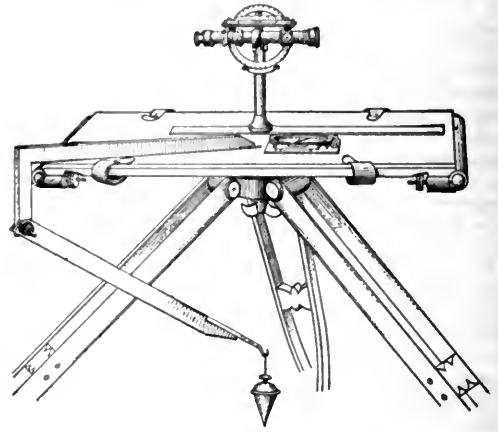

PLANE-TABLE.

others not visible from the first point, and new lines are ruled. The instrument is then taken to other points which are given by the intersection of the various lines ruled on the paper, and the positions of the various objects in the area under survey are determined. In this way it is possible to fill in the detail work of a topographical survey with great rapidity and sufficient exactness for most map work. See SURVEYING.

PLANETARIUM (Neo-Lat., from Lat. *planeta*, from Gk. *πλανήτης*, *planētēs*, wanderer, wandering star, planet, from *πλανῆς*, *planēs*, wanderer, planet, from *πλάνη*, *planē*, a wandering; connected with Lith. *plónas*, thin, Lat. *planus*, level, flat, plane, plain). A machine much employed by astronomers in the seventeenth and eighteenth centuries, and first constructed by Huygens and Römer, for the purpose of exhibiting clearly the motion of the heavenly bodies in conformity with the Copernican doctrine. The planetarium exhibited only the orbital motions of the planets about the sun, either in circles or ellipses, and with constant or varying motions, according to the perfection of the machine. It was later improved by the addition of a combination of the tellurian and the lunarian, which exhibited both the motion of the moon about the earth and the earth round the sun, with the principal phenomena (such as the succession of day and night, the varying length of each, eclipses, and the motion of the moon's apogee and nodes) which accompany these motions. A satellite machine was also invented to illustrate the motions of Jupiter's satellites. All these machines were later combined in the orrery (q.v.), which exhibits in the best manner possible the varied motions and phenomena of the bodies in the solar system; but this whole class of instruments have ceased to possess practical usefulness, and have been relegated to astronomical museums.

PLANETOIDS (from Gk. *πλανήτης*, *planētēs*, wanderer, wandering star, planet + *εἶδος*, *eidos*, form), or ASTEROIDS. A numerous group

of very small planets which, with one exception, travel in orbits lying between those of Mars and Jupiter. Till the first year of the nineteenth century they remained undiscovered; but for some years before their existence had been suspected, mainly owing to the remarkable hiatus in the series of the planetary distances when compared with the law of Bode (q.v.). On the first day of January, 1801, the first of them was detected by Piazzi at Palermo, and his success roused the astronomers to search for more planets. Their search was successful, for Olbers (q.v.) discovered two in 1802 and 1807, and Harding one in 1804; but as all researches for some time subsequent to 1807 were unavailing, astronomers gradually allowed themselves to settle down into the belief that no more planetoids remained to be discovered, when the detection of a fifth by Hencke in 1845 revived the hope of fresh discoveries, and from this period no year (excepting 1846) has passed without adding to the list. And since the application of photographic processes to observation, the number known to astronomers has increased with great rapidity. The first photographic asteroid was found by Wolf, of Heidelberg, Germany, December 20, 1891, and was named by him *Brucia*, in honor of Katharine Wolff Bruce, of New York, who contributed to the endowment of the Heidelberg observatory. *Brucia* received the number 323 in the list of planetoids. Since 1892 only a few planetoids have been found visually, though the total number in the list has been extended from 232 to over 500. It will be seen, therefore, that photography has almost completely replaced the visual telescope in this kind of observation.

The magnitudes of the planetoids have not been very accurately ascertained, but it is certain that they are exceedingly small compared even with Mercury, the smallest of the other planets, the diameter of the largest among them having been measured by Barnard as 485 miles, while most of the others are very much smaller than this. They also differ, generally speaking, from the rest of the planets in other respects; their orbits are of greater eccentricity, are inclined to the ecliptic at a greater angle, and are interlaced in a most intricate manner, crossing each other so frequently as to form, when viewed perpendicularly, a kind of network. The consequence of this is that a mutual eclipsing of the sun at different periods by two planetoids must be of very frequent occurrence. After the first two or three of these bodies had been discovered, the opinion was propounded by Olbers that they were but the fragments of some large planet, and this hypothesis received corroboration from the intimate connection which was shown to subsist among them; but this hypothesis is now rejected by most astronomers, and their existence is explained by the nebular hypothesis. See *NEBULE*.

Decidedly the most interesting planetoid is the one discovered August 13, 1898, by Witt of Berlin, and which has received the number 433 and the name *Eros* (q.v.). This small planet possesses the remarkable orbital peculiarity that at perihelion it passes considerably within the orbit of Mars, and thus approaches the earth nearer than any other known body except the moon, and is therefore especially well suited for the determination of solar parallax by the planetoid method. By means of long photographic exposure Wolf and Dugan, during May and June, 1903, dis-

covered eight planetoids, provisionally indicated by 1903, LQ to LX. See *PARALLAX*.

PLANETS. Those solid spherical bodies which belong to our solar system, and revolve in elliptic orbits round the sun. The name planet is of considerable antiquity, and was applied to these dependents of the sun to distinguish them from the other luminous bodies which stud the sky and present to the naked eye no indication of change of relative place (see *STARS*), while the planets seem to wander about among them. The planets at present known are, in the order of their distance from the sun, Mercury, Venus, the earth, Mars, the planetoids, Jupiter, Saturn, Uranus, and Neptune. Six of these, Mercury, Venus, the earth (which was not, however, then reckoned a planet), Mars, Jupiter, and Saturn, were known to the ancients; Uranus was discovered by Sir William Herschel (q.v.) in 1781; and Neptune, after having its position and elements determined theoretically by Leverrier and Adams, was discovered by Galle in 1846. The planetoids of which over 500 are now known, have all been discovered since January 1, 1801. Six of the planets, the earth, Mars, Jupiter, Saturn, Uranus, and Neptune, are attended by one or more satellites; Uranus (generally), Neptune, almost all the planetoids, and all the satellites except our moon, are invisible to the naked eye. The visible planets can be at once distinguished from the fixed stars by their clear, steady light, while the latter have a sparkling or twinkling appearance. The comparative proximity of the planets may be proved by examining them through a telescope of moderate power, when they appear as round luminous disks, while the fixed stars show as mere points of light even in the most powerful telescopes. The planets as observed from the earth move sometimes from west to east, sometimes from east to west, and at times remain stationary at the point where the apparent motion changes from the one direction to the other. This irregularity in their movements was very puzzling to the ancient astronomers, who invented various hypotheses to account for it. (See *PROLEMAIC SYSTEM*; *EPICYCLE*.) The system of Copernicus, by assuming the sun, and not the earth, as the centre of the system, explained with admirable simplicity what seemed before a maze of confusion, by showing that the planetary *apparent* motions are merely a result of real motions belonging to the planets in general and to the earth carrying the observer.

The planetary orbits differ considerably in their degrees of eccentricity, the planetoids, Mars, and Mercury being most, and the larger planets least, eccentric. No two planets move exactly in the same plane, though, as a general rule, the planes of the larger planets most nearly coincide with that of the ecliptic. The latter are consequently always to be found within a small strip of the heavens extending on both sides of the ecliptic (q.v.); while the others have a far wider range. Pallas, one of the planetoids, has an angular elevation of orbit equal to 34° 41' above the ecliptic. According to Kepler's laws (see *ASTRONOMY*), the nearer a planet is to the sun the shorter is the time of revolution. The arrangement of the planets in the solar system bears no known relation to their relative size or weight, for though Mercury, Venus, and the earth follow the same order in size and distance

from the sun, yet Mars, which is farther from the sun, is much smaller than either the earth or Venus; and the planetoids, which are still farther off, are the smallest of all. Jupiter, which is next in order, is by far the largest, being about one and one-half times as large as all the others together; and as we proceed farther outward the planets become smaller and smaller.

With reference to their distance from the sun, as compared with that of the earth, the planets are divided into *superior* and *inferior*; Mercury and Venus are consequently the only inferior planets, all the others being superior. The inferior planets must always be on the same side of the earth as the sun is, and can never be above the horizon of any place (not in a very high latitude) at midnight; they are always invisible at their superior and inferior conjunctions, except when, at the latter, a transit (see TRANSIT OF VENUS) takes place. The superior planets are likewise invisible at conjunction, but when in opposition they are seen with the greatest distinctness, being then due south at midnight.

A trans-Neptunian planet, owing to disturbances produced on the outer planets, is suspected to revolve outside the orbit of Neptune. Even before the discovery of Neptune it was suggested that the Uranian disturbances were not due to a single exterior planet alone. The matter was investigated by Todd (q.v.) in 1877. He computed the probable elements and searched the heavens on "30 clear, moonless nights, between November 3, 1877, and March 5, 1878." Every effort to find the hypothetical planet has, however, so far proved fruitless. Consult Todd's account in the *American Journal of Science* (September, 1880).

In astronomical tables, almanacs, etc., the planets are for convenience denoted by symbols instead of their names, as follows: Mercury, ☿; Venus, ♀; the earth, ♂; Mars, ♀; the planetoids, in the order of their discovery, ①, ②, ③, etc.; Jupiter, ♃; Saturn, ♄; Uranus, ♅; Neptune, ♆; the sun, ☉; the moon, ☾.

For a table of the periods, distances, size, density, etc., of the planets, see SOLAR SYSTEM. See also the several planets under their respective names. For the hypothetical planet Vulcan, see VULCAN; for the elements necessary to determine the orbit of a planet, see ORBIT. For theories regarding the origin of the system, see COSMOGONY; NEBULÆ.

PLANIM'ETER (from Lat. *planum*, level ground, plain + *μέτρον*, *metron*, measure). An instrument for automatically measuring the areas of maps and plans. The first usable planimeter seems to have been constructed in 1814 by a Bavarian engineer named Hermann (1785-1841). This was followed by an ingenious device invented by a Swiss engineer, Opikoff, in 1827, and perfected ten years later by Ernst of Paris. The next notable type was the polar planimeter made by the firm of Amsler-Laffon of Schaffhausen (1854) and known as Amsler's planimeter. This well-known instrument consists of two arms hinged at one end, the outer end of one being a pointed support and that of the other a tracing pencil. The latter arm also bears a graduated cylinder which rolls on the paper, its axis being parallel to the arm. To obtain the area of a figure the instrument is moved bodily about the pointed support on the first arm, while the tracer of the other arm de-

scribes the perimeter of the area, and the graduated cylinder records the required area. This and the 'Wetliche Linearplanimeter,' now manufactured in Vienna, are the best planimeters now made. The mathematical principles involved may be found in works on surveying. The best description of the Amsler planimeter is given in Bauernfeind's *Elemente der Vermessungskunde* (7th ed., Stuttgart, 1890). Consult, also, Amsler, *Ueber die mechanische Bestimmung des Flächeninhalts* (Schaffhausen, 1856). The latest improvements on the polar planimeter have been made by Hohmann and Coradi in their 'Präzisions-Polarplanimeter,' and by Coradi in his 'Kugel-Rollplanimeter,' on which consult Lorber, *Zeitschrift für Vermessungswesen* (vols. viii. and xvii., Stuttgart, 1884, 1888), and Amsler-Laffon, 'Planimeterkonstruktionen,' in the *Zeitschrift für Instrumentenkunde* (4. Jahrg., 1884), and *Das Momentenplanimeter* (Zürich, 1875). For the history of the subject, consult: Trunck, *Die Planimeter; deren Theorie, Praxis und Geschichte* (Halle, 1865); Bauernfeind, in Dinger's *Polytechnisches Journal* (vol. cxxxvii.); and Favaro, in the *Allgemeine Bauzeitung* (1873).

PLANIM'ETRY (from Lat. *planum*, level ground, plain + Gk. *-μετρα*, *-metria*, measurement, from *μέτρον*, *metron*, measure). That portion of geometry which treats of the measurement of plane areas. See PLANIMETER; MENSURATION.

PLANING MACHINE, or **PLANER**. See METAL-WORKING MACHINERY; WOOD-WORKING MACHINERY.

PLANKTON (Neo-Lat., from Gk. *πλαγκτός*, *planktos*, wandering, from *πλάζω*, *plazein*, to wander). A collective term for the free floating or swimming organisms in oceans, lakes, or rivers. The oceanic plankton is more interesting and important than that of lakes and of rivers, inasmuch as it forms the basis for all oceanic life. Among the more important forms which are found in the plant plankton are blue-green algae, bacteria, and diatoms. The colors of certain waters are due to plankton organisms. For example, the Red Sea is colored by a red alga. Diatoms are found in especial abundance in the colder seas. Among the more interesting structures and life habits of the plankton plants there may be noted a high development of adaptations for active movements through the water, a type of structure which is found in plants only among the lower forms. Another very striking feature of the plankton is its periodicity; at various seasons its constitution varies widely and the plankton organisms are known to rise and sink more or less periodically. The mechanism involved in these movements is not known.

In zoölogy the term is restricted to the pelagic life which drifts, the actively swimming surface forms constituting a separate assemblage—the 'nekton.' It consists mainly of 'jellyfishes' (Medusan, Siphonophora, and Ctenophora), ascidian, especially the salpæ (q.v.), and a great variety of pelagic larvæ and minute crustacea with feeble powers of locomotion that are carried along almost passively by the oceanic currents. Much of this occurs in innumerable flocks, and sometimes tinges large areas of the sea by its color, or causes them to glow with phosphorescence; and it furnishes food to many surface-feeding pelagic animals.

PLANQUETTE, plän'kët', ROBERT (1850—). A French composer of light opera, born in Paris. He studied at the Paris Conservatory, and wrote at first mediocre songs. His success came with his adoption of the *Musiquette*, a genre in which he wrote sixteen very successful operettas between 1873 and 1892, one of those best known in America and England being *Les cloches de Corneville* (1877), also known as *The Chimes of Normandy*. Others scarcely less popular are *Nell Gwynne* (1884), *La crémaillère* (1885), and *The Old Guard* (1887), written for the English stage. His music is light and graceful and thoroughly representative of the school which claims as its exponents Lecocq, Audran, Serpette, Banès, Vas-seur, and Victor Roger.

PLANTAGENET. A royal house of England which succeeded to the throne in 1154 in the person of Henry, son of Geoffrey, Count of Anjou, and Matilda, daughter of Henry I. (see HENRY II.), and ruled in the direct male line till 1399. The name of Plantagenet is commonly said to have been applied to Geoffrey of Anjou from his habit of wearing sprigs of broom (*planta genesta*) in his cap. The house gave to England some of its ablest rulers, and the period of the later Plantagenets especially is important for the development of the Parliament and the determination of the general character of English constitutional growth. The monarchs of this line were: HENRY II. (1154-89); RICHARD I. (1189-99); JOHN (1199-1216); HENRY III. (1216-72); EDWARD I. (1272-1307); EDWARD II. (1307-27); EDWARD III. (1327-77); RICHARD II. (1377-99). With the death of the childless Richard II. in 1399 the crown passed to the House of Lancaster (q.v.), descended from John of Gaunt, fourth son of Edward III., and therefore in reality a branch of the House of Plantagenet. The Lancastrian monarchs were forced to contend against the claims of the House of York (q.v.), similarly descended from a son of Edward III. (See also ROSES, WAR OF THE.) The line of York attained the throne in the person of Edward IV. (1461-83), but with the death of his brother, Richard III. (1483-85), the crown passed to the House of Tudor (q.v.).

PLANTAIN (OF., Fr. *plantain*, from Lat. *plantago*, plantain; connected with *planta*, plant) COOKING BANANA, ADAM'S FIG (*Musa paradisiaca*). An herb of the natural order Scitamineæ. It is a native of India, but is widely cultivated in the tropics for its fruits, which resemble those of the banana, but are less sweet and less pleasant to eat uncooked. It is one of the most important of tropical fruits, since a very large part of the human race use it as a principal food. In habit of growth it resembles the banana (q.v.).

PLANTAIN-EATER. Either of two West African birds of the turaco family, Musophagidæ, which have serrated bills and feed on fruits, especially that of the bananas. Both are birds of the size of a crow, are handsomely colored, and form the genus Musophaga. The name is sometimes extended to various other genera. See TURACO.

PLANT-BREEDING. The art of improving plants by crossing and selection. In general plants tend to reproduce their main characters unchanged, but their long recognized tendency to vary has prompted much experimentation, which, with the undirected variation, has resulted in the

production of many cultivated varieties, strains, and races. In some cases the variation appears on a part of a single individual and can be traced to no apparent cause. Such variations are usually called sports, and, when desired, are propagated by artificial asexual methods, which consist of the indefinite propagation of a single individual by cuttings, grafts, layers, etc. This method is one of the simplest and in some respects the surest method of plant-breeding, since as a rule sports are less plastic than other variant forms. The principal objection raised against the method is the weakness supposed to follow long continued asexual propagation. Familiar examples of this type of breeding are the weeping willows and elms, cut-leaved birches and maples, variegated foliage plants, etc. Selection, a second method, consists in the saving of seed from only such individuals as exhibit qualities not possessed by all, undesirable forms being destroyed. Plants grown from seed tend to vary greatly because of the action of diverse factors. As with many varieties of grapes, apples, and other fruits, some seedling may exhibit sufficient merit to be propagated without further selection by the asexual methods mentioned. Usually, however, the progeny shows only a slight improvement over the parent plant, and selection must be continued until the ideal is approximated or an improvement secured that is worth commercial introduction.

Associated with selection, and in many cases preliminary to it, is fertilization which may result, from the transportation of pollen by wind or insects in a natural cross, as in numerous hybrids of oak, willow, etc., occurring in nature. Or there may be an artificial transfer of pollen for a definite purpose. Variations are often introduced by this means and the desirable variant propagated and improved by long continued selection. Since Darwin's time the superabundant nutrition of plants has been held to be a prominent cause of variation. A large part of the work of improving sugar beets, potatoes, tomatoes, cereals, etc., has been along these lines. The usual method of artificial pollination is to remove the immature stamens from the flower to be fertilized unless the pistil is known to be sterile to pollen of the same variety of plant. When the stigmas of the emasculated flower are ripe, pollen from a related plant is placed upon them, and the flower covered with fine gauze or a paper bag to prevent an accidental application of other pollen. When the fruits or seeds are mature, they are collected, and planted when the usual season for planting arrives. From the progeny of such a fertilization individuals that differ from both parents are selected as the basis of new varieties. When a desirable form is found, it is subjected to further cultivation and selection, attention being given to keep the selection always along one line, since any deviation will likely result in the ultimate failure of the experiment. In making selections the individual plant and not any particular portion of it must be the unit of selection. In following out this improvement thousands of individuals will probably have to be discarded. It is said that an American carnation-grower destroyed more than 60,000 plants that he had reared to flowering to secure a single new desirable variety.

In plant-breeding the following principles are laid down: Thorough knowledge of the plant, a preconceived ideal established and maintained throughout, large numbers of seedlings should be

employed in all selection experiments, and fixed characters should be selected as far as possible. A knowledge of the following correlations will aid the plant-breeder: Small foliage is usually associated with small fruit; dwarf seedlings produce poor plants; pale-colored foliage is usually an accompaniment of light-colored fruit, flowers, etc.; large individuals are incompatible with numerous specimens, great productiveness with extreme earliness, and very great size with intense coloration. By paying attention to these principles a skillful plant-breeder can influence almost at will the external characters of form and color and the internal qualities of flavor, perfume, and chemical composition. It is quite as possible, however, for varieties to degenerate under selection as to improve, and this fact shows the importance of making the proper selection and constantly keeping it in mind in subsequent selections.

Hitherto plant-breeders have made great progress in methods of procedure, and have produced many new varieties of fruit, grain, and flowers, but have learned little of the principles controlling and limiting the production of new varieties. Serious efforts are being made by many investigators to establish a scientific basis for plant-breeding experiments. In August, 1899, an international conference of hybridists was held in London under the auspices of the Royal Horticultural Society of England. This meeting, which was attended by many of the leading plant-breeders and scientists interested in the subject, served to arouse activity on the part of many and the literature of the subject has since considerably increased. De Vries, Correns, Tschermak, Bateson, Hays, Spillman, and others have written extensively of their work in the generation of new varieties, and have sought to deduce laws governing the phenomena of variation. This awakened energy led to the almost simultaneous discovery by Correns, De Vries, and Bateson of a paper entitled "Versuche über Pflanzenhybriden," published in 1865 by Gregor Mendel, who showed that nearly constant numerical ratios could be obtained among the types produced by hybridization. As yet the reason why some characters are transmitted and others are not is not clearly understood, but so far as Mendel's work is concerned the approximate proportions in which certain prominent characters will appear in the offspring can be foretold. In the cross-breeding experiments of Mendel two characters were selected, called respectively the dominant and the recessive. If these characters have been well fixed in the parent plant, they will appear in the hybrid offspring in a regular mathematical proportion, which may be represented briefly by the formula 1D: 2DR: 1R. In these D and R continue to exhibit pure dominant and recessive characters and the 2DR furnishes the true crosses which continue to vary in the same proportion as in the formula. This applies to crosses of plants whose ancestors are equally pure and fertile. Most of the exceptions to the so-called Mendellian law can probably be explained by either of these possible sources of error. For a full discussion of Mendel's law, consult Bateson, *Mendel's Principles of Heredity* (London, 1902).

In 1902 a second International Conference on Plant Breeding was held in New York City, under the auspices of the New York Horticultural Society. Papers were read by many of the foremost plant-breeders of the world, and the results

of numerous experiments were shown by the originators of many new varieties of cereals, fruits, and flowers. The papers are printed in the *Transactions of the society* and a brief abstract of them is given in *Experiment Station Record*, xiv., p. 208. For further information, see *New Jersey Experiment Station Report for 1901*, in which the plant-breeding work of the American Experiment Stations is summarized; United States Department of Agriculture *Year Books*, 1897, 1898, 1899; *Experiment Station Record*, vols. vi., xi., xiv., Correns, *Botanische Zeitung*, 1900; De Vries, *Die Mutations-Theorie* (Leipzig, 1901); Weldon, *Biometrika*, vol. i., part 2 (1902); Tschermak, *Zeitschrift für landwirtschaftliches Versuchswesen in Oesterreich* (1900-01); Vernon, *Variation in Animals and Plants* (New York, 1903). See BREEDS AND BREEDING, paragraph *Plant-Breeding*.

PLANT-BUG. Any one of several families of true bugs, which feed upon plants by extracting the sap through the beaks. The Coreiidae are a very large and important family, containing more than 1500 species. The squash-bug (q.v.) of vegetable gardens is a representative of this group, as also is the box-elder plant-bug (*Leptocoris trivittatus*), a species which frequently damages the box-elder trees that, because of their rapid growth, are commonly planted on Western tree claims. The Pyrrhocoridae are a much smaller group, but include several well-known species. The red-bug or cotton-stainer, which does considerable damage to cotton in Florida, as well as to the orange groves, is a prominent example. The family Lygaeidae is another of the largest families of plant-bugs, comprising more than 1300 species distributed in 13 subfamilies and 208 genera. About 175 species are known in the United States. The most prominent member of this family is the chinch-bug (q.v.). The bordered plant-bug (*Stiretus anchorago*) is a brilliant species which preys on the larvæ of the Colorado potato-beetle, and is sometimes called the 'potato-bug enemy.' See COTTON INSECTS. Consult: Comstock, *Manual for the Study of Insects* (Ithaca, 1895); Howard, *The Insect Book* (New York, 1902.)

PLANT-CUTTER. One of the tanager-like birds, related to the cotingas (q.v.), and to the American fly-catchers. They constitute a small family (Phytotomidae), and show some remarkable anatomical peculiarities. The bill is short, strong, conical, with lateral margins finely serrated. The intestine is short, an unusual condition in vegetable-eating birds. They live in pairs or in small flocks and commit depredations in orchards and gardens by cutting off plants, buds, and fruits. They also catch insects. There are three species, all natives of temperate South America, the best-known of which is the 'rara' (*Phytotoma rara*) of Chile, of the size of the common thrush, and of reddish brown and white plumage. It has a short low flight, and a disagreeable rough note. See Plate of COTINGAS, ETC.

PLANTIGRADE ANIMALS (from Lat. *planta*, sole of the foot + *gradi*, to walk). Animals that have the foot so formed that the whole sole touches the ground in walking. Man and the bear are examples. The term is used in opposition to 'digitigrade,' or walking on the tips of the toes, like the horse and dog. Between plantigrade and digitigrade animals all sorts of gradations intervene.

PLANTIN, plān'tān', CHRISTOPHE (1514-89). An eminent French printer, born at Saint-Aver-tin. In 1555 he set up at Antwerp a printing establishment which soon became one of the most celebrated of the time. The most noted of all his publications is the *Biblia Polyglotta* (8 vols., 1568-73). His books were noted for the accuracy of their text and the beauty of their topography and embellishments. Consult Debaecker and Ruelens, *Annales Plantiniennes, 1555-89* (Paris, 1865), and the *Life* by Rooses (Antwerp, 1892).

PLANTIN-MORETUS, MUSÉE. An important museum in Antwerp containing a rare collection, illustrating the art of printing. The names are those of Christophe Plantin, and his son-in-law and successor, Moretus. Plantin's printing office after 1579 was carried on in the present building until 1875, when the house with its contents was purchased by the city. The museum includes a composing room, printing room, and library, with interesting apparatus and specimens of ancient work, and the residence of Plantin, with antique tapestry, furniture, paintings, and porcelains.

PLANT-LOUSE. See APHID.

PLANT PHYSIOLOGY. The study of the functions of plant organs. See PHYSIOLOGY OF PLANTS.

PLANTS (AS. *plante*, from Lat. *planta*, plant). In law, specifically, such vegetable growths as are not included in the terms emblements, crops, or growing trees, except nursery trees. The term includes bushes, shrubs, and nursery trees. Where plants are set out by a landlord they become part of the real estate and cannot be removed by a tenant at the termination of his lease, although he may alter the position of them, or remove a reasonable number of them in the ordinary course of husbandry during his term. Where a tenant sets out plants they become attached to the real estate, unless they are for the purpose of temporary growth and sale, as the trees and other plants in a nursery. For example, a tenant could not remove, at the termination of his lease, berry bushes which were intended to produce annual crops, although he had set them out at his own expense. See EMBLEMENTS.

PLANTS, FOSSIL. See PALEOBOTANY.

PLANT SOCIETY, or ASSOCIATION, or COMMUNITY. An assemblage of plants growing in a common habitat under similar life conditions. See ECOLOGY; DISTRIBUTION OF PLANTS.

PLAQUEMINE, plāk'mēn'. A town and the parish seat of Iberville Parish, La., 85 miles west-northwest of New Orleans; on the Mississippi River, and on the Texas and Pacific Railroad (Map: Louisiana, D 3). It has considerable trade in cotton, lumber, and sugar, and manufactures of lumber and lumber products. The water-works are owned and operated by the municipality. Population, in 1890, 3222; in 1900, 3590.

PLASENCIA, plā-sēn'thē-ā. An ancient but much decayed town of Western Spain, in the Province of Cáceres (Map: Spain, B 2). It is very picturesquely situated on a rocky promontory on the bank of the Jerte, and is surrounded by the remains of a double line of walls with 68 towers. An aqueduct of 53 arches leads into the town, where there is a Gothic cathedral, unfinished and disfigured by late additions. Plasencia

was once a flourishing city; its population in 1900 was only 7965.

PLASMA (Lat., from Gk. *πλάσμα*, formation, molded figure, from *πλάσσειν*, *plassein*, to form). The fluid portion of the blood, rich in proteids. After the removal of the blood from the arteries and veins a part of these proteids separate by coagulation and form the blood-clot, which is composed of fibrin, leaving a fluid poor in proteids, and called the blood-serum.

The term is also given by Haeckel to the protoplasm of cells surrounding the nucleus; or in the case of the monera, which are supposed to have no nucleus, to the unorganized protoplasm constituting such organisms. Cells are defined by Haeckel as bits of plasma containing a nucleus.

PLASMA. A crypto-crystalline variety of quartz that is of a bright green to dark green color. Plasma is somewhat rare, and the best specimens come from India and China. Among the ancient Romans it was highly prized, and was carved by them into ornaments of various kinds, and finely engraved specimens have been found among the ruins of ancient Rome. The variety used by the ancients is believed to have come from Mount Olympus in Asia Minor.

PLASMO'DIUM (Neo-Lat., from Gk. *πλάσμα*, *plasma*, formation, molded figure + *εἶδος*, *eidos*, form.) The vegetable body of a slime mold, consisting of a mass of naked protoplasm sometimes covering several square inches, and crawling about like a gigantic amoeba. It is one of the most favorable subjects for studying the behavior of protoplasm. See MYXOMYCETES.

PLASMOLYSIS (Neo-Lat., from Gk. *πλάσμα*, *plasma*, formation, molded figure + *λύσις*, *lysis*, resolution, from *λύειν*, *lyein*, to loose). The shrinkage of the protoplasm, due to the extraction of water from the cell sap by a solution of

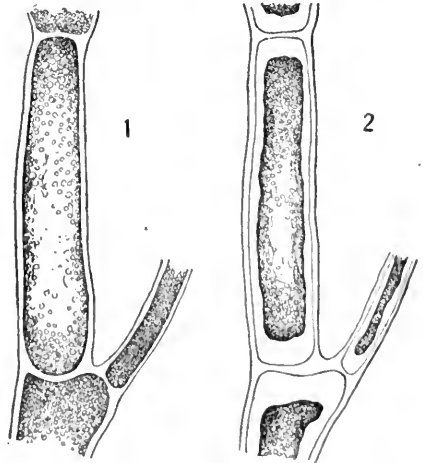

PLASMOLYSIS.

A cell from a filament of alga (*Cladophora*) before (1) and after (2) plasmolysis with sugar solution.

higher osmotic pressure in contact with the cell. The mature plant cell consists of a mass of protoplasm, inclosing one or more droplets of cell sap (vacuoles) and surrounded by a membrane called the cell wall. Under certain conditions, which are also those of activity, the layer of protoplasm is held so firmly against the cell wall

by the osmotic pressure of the substances dissolved in the water occupying the vacuoles that it is usually stretched until its resilience equals the osmotic pressure within (Fig. 1). If such a cell be surrounded by a solution having an osmotic pressure greater than that of the cell sap, water will be withdrawn from the latter, the protoplasm will shrink, and the cell wall, by its elasticity, will follow the shrinking protoplasm until it has reached its unstretched dimensions. If the withdrawal of water still continues, the protoplasm will continue to shrink, but the cell wall may be strong enough to maintain its form. Thus the protoplasm will be withdrawn from contact with the wall, a condition ordinarily taken to indicate the beginning of plasmolysis, but in reality a later stage (Fig. 2). If the cell wall be very thin it may collapse upon the shrinking protoplasm, folding and wrinkling irregularly. Should withdrawal of water continue, the protoplasm may shrink up into a small mass, the vacuole disappearing completely. When the amount of protoplasm in the plasmolyzed cell is relatively small, the protoplasm may happen to divide into two or more parts, a possibility which is taken advantage of for experimentation upon the functions of the nucleus. See OSMOSIS; TURGOR.

PLASSEY, pläs'sè, or **PLASSI**. A small town of British India, on the Bhagirathi River, 75 miles north of Calcutta (Map: India, E 4). It is celebrated for the great victory gained by Clive (q.v.) over the numerically superior forces of Siraj-ud-Daula, Nawab of Bengal, June 23, 1757, a victory which laid the foundation of British supremacy in India. The actual site of the battle has been washed away by the river.

PLASTER. See GYPSUM; BUILDING.

PLASTER, PLASTERING. See BUILDING, section on *Lathing and Plastering*.

PLASTER OF PARIS. A cementing substance which is prepared by partial calcination or dehydration of gypsum. This mineral is chemically a hydrated sulphate of lime and contains 46.6 per cent. of sulphuric acid, 32.5 per cent. of lime, and 20.9 per cent. of water, corresponding to the formula $\text{CaSO}_4 + 2\text{H}_2\text{O}$. When heated to a temperature above 128°C . but less than 360° , gypsum loses a definite portion of its water corresponding to one and one-half equivalents, and then has the composition $(\text{CaSO}_4)_2 + \text{H}_2\text{O}$. The material thus treated is known as plaster of Paris, or commonly plaster, and has the property of hardening or setting when water is added. If the calcination is conducted at a heat greater than 360° , however, the gypsum loses all of its water and becomes inert. The set of plaster of Paris is due to its uniting with water again to form gypsum which assumes a crystalline form.

In the manufacture of plaster of Paris, the gypsum may be quarried and burned directly in kilns, which is the method usually practiced in Europe, or the gypsum may be ground to a fine powder and then calcined in kettles, this being the general practice in the United States. The improved form of kiln consists of a cylindrical chamber with brick or stone walls and a fire-pit at the bottom. The gypsum blocks are loosely placed around and above the fire-pit so that the gases may circulate through all parts of the chambers before passing out of the top of the

kiln. Coal is used as fuel. In the plaster mills of the United States the gypsum is ground in a buhrstone mill or some form of disintegrator and is then run into a calcining kettle set in stonework. The kettle has a diameter of about eight feet and holds about seven tons of ground gypsum. During the process of calcination the powder is stirred by revolving arms so that the whole mass may be burned evenly. Coal and oil are used as fuel. For the purpose of delaying the set of gypsum plaster, which ordinarily requires from six to ten minutes, it is mixed with some form of 'retarder,' such as glue, soda, sorghum, etc., and is then sold as 'cement wall plaster.' The time required for hardening these special plasters varies from two to six hours.

The principal uses of plaster of Paris are for the manufacture of stalf, which is employed in the construction of temporary buildings, and for wall plaster. Owing to its greater hardness and durability, it is much superior to lime for construction purposes. The production of plaster of Paris in the United States in 1901 was 412,908 short tons, valued at \$1,377,570, the greater part being made in Kansas, Iowa, Michigan, and New York. The domestic industry is exceeded only by that of France. Consult Grimsley, "Technology of Gypsum," in *The Mineral Industry*, vol. vii. (New York, 1899). See GYPSUM.

PLASTERS (AS. *plaster*, OHG. *pflaster*, Ger. *Pflaster*, from OF. *plastre*, *plaietre*, *emplastre*, Fr. *plâtre*, *emplâtre*, from Lat. *emplastrum*, from Gk. *ἐμπλαστρον*, *emplastron*, *ἐμπλαστον*, *emplaston*, plaster, from *ἐμπλάσσειν*, *emplastsein*, to plaster, from *έν*, *en*, in + *πλάσσειν*, *plastsein*, to form). Tenacious preparations for external application, solid at ordinary temperatures, but pliable and adhesive at the temperature of the body. Most plasters have as their base a compound of olive oil and litharge, constituting the lead plaster of the pharmacopœia; others owe their consistence and adhesiveness to resinous substances, or to a mixture of these with wax and fats. These substances, alone or impregnated with medicinally active materials, are spread in a thin layer upon linen, muslin, or leather. Formerly this spreading was done by hand, but of late years the work is accomplished entirely by machinery, which distributes the plaster mass with great evenness, and perforates or makes porous the finished product. Since the introduction of machinery india-rubber has been largely employed in the adhesive composition. There are thirteen plasters recognized by the United States Pharmacopœia: lead, ammonia and mercury, iron, mercury, opium, soap, resin, arnica, capsicum, belladonna, pitch, isinglass, and cantharides, besides many unofficial varieties. Besides their generally protective properties, these plasters have special therapeutic actions dependent upon the active ingredient. Opium plaster, for example, is anodyne, as is also belladonna; lead and arnica are soothing and astringent; mercury, alterative; capsicum is used as a counter-irritant, and cantharides as a blistering agent. Court plaster consists of a solution of isinglass thinly spread upon silk, previously coated with tincture of benzoin. It is employed as a dressing to protect slight cuts or abrasions and must be moistened before application. Gold-beaters' skin is similarly used. In surgery adhesive plaster is extensively used for its mechanical effect to reinforce

weak muscles, to keep dressings in place, to cover ulcers, to limit effusions, etc.

PLASTIDS (from Gk. πλαστός, *plastos*, molded, from πλασσειν, *plassein*, to form), or **CHROMATOPHORES**. Living organs of the cell, usually imbedded in the cytoplasm, of various form, having functions differing according to their ultimate mode of development. They differ from the nucleus in form and composition, and in multiplying by direct division. They are of three kinds—chloroplasts, chromoplasts, and leucoplasts. Chloroplasts (q.v.) contain chlorophyll and carotin, with often other subordinate pigments which add their special tint to the general yellow-green of the ordinary chloroplast; chromoplasts (q.v.) have usually a red or yellow color, due to a predominance of carotin; leucoplasts (q.v.) are colorless and have as their special functions the formation of starch grains, proteid granules, or oil drops, out of material absorbed from the adjacent protoplasm. The oil-formers have been distinguished as elaioplasts. Multiplication of plastids by direct division consists in the severance of the protoplasmic matrix into two parts by its contraction, which continues near the middle until the two portions are completely disjoined. Plastids are minute and undifferentiated in embryos, and take on special form and character under the influence of the external conditions. Thus, plastids which develop near the surface of the plant are likely to form chlorophyll and become chloroplasts; those which develop in subterranean organs or thick aerial parts are likely to become leucoplasts and act as starch or proteid formers; while the plastids in flower leaves, the fruit, or even those in the root (e.g., the carrot) may develop as chromoplasts. See **CELL**; **MITOSIS**.

PLATA, plá'tá, RIO DE LA. The estuary of the combined Paraná and Uruguay rivers (qq.v.) in South America. It forms a large marine inlet between the republics of Uruguay and Argentina (Map: Argentina, J 14). It is 143 miles wide at its mouth and tapers gradually inland for a distance of 200 miles to the delta of the Paraná. The Plata is the outlet for an enormous volume of water, amounting during floods to over two million cubic feet per second. Vast quantities of sediment are also brought down by the two rivers, and are gradually filling up the estuary, which formerly extended more than 100 miles farther inland. Shoals are everywhere forming rapidly, and, together with the strong currents and violent storms, make navigation dangerous. The best natural harbor on the estuary is Montevideo; artificial harbors have been constructed at La Plata and Buenos Ayres by means of jetties projecting beyond the shallows which line the Argentine shore. The Plata estuary was discovered in 1509 by Diaz de Solis, and received its present name ('silver river') from Sebastian Cabot.

PLATĒ'A, or **PLATĒÆ** (Lat., from Gk. Πλάταια *Plataia*, Πλαταιαί, *Plataiai*). An ancient city in the extreme southeastern part of Bœotia, on the borders of Attica, at the foot of Mount Cithæron. Involved in war with its powerful neighbor Thebes, it sought help of the Spartans and was referred to Athens, as a nearer ally, apparently about B.C. 500. Received and defended by the Athenians, the Plataeans showed their gratitude by coming with their whole force to the help of

the Athenians at Marathon. For this they suffered severely in B.C. 480 when Xerxes destroyed the town. The great victory of the Greeks near the town in the following year restored them under a national agreement that guaranteed their independence. Their devotion to Athens brought on them the hatred of the Thebans, who made an unsuccessful attempt to take the town by surprise in 431, at the opening of the Peloponnesian War, and when it was finally forced to surrender to the Spartans (B.C. 427) after two years' siege, secured the death of the defenders. Restored after the Peace of Antalcidas (B.C. 387), it was once more destroyed by the Thebans in 373. Finally under Alexander the Great it was again rebuilt, but sank into insignificance, though it was still of some importance in the time of Justinian, who rebuilt its walls. The present walls seem to belong to the later city and inclose a much greater circuit than can have belonged to the fifth-century town. For a full discussion of the topography of the neighborhood, with detailed maps, consult Grundy, *The Battle of Plataea* (London, 1894).

PLAT-BAND (Fr. *platband*, *plattbande*, OF. *plattebande*, lintel, flat band). In architecture, a flat fascia or band, with less projection than breadth, between curvilinear moldings.

PLATE, SHEFFIELD. A kind of table ware made by coating a baser metal with silver. Previous to the introduction of electro-plating, the method generally pursued was that which has acquired the name of *Sheffield plating*, from the large extent to which it was carried on in that town. It consisted in soldering on to one or both sides of an ingot of the baser metal a thin plate of silver. The ingot is always of an oblong shape, and is most carefully prepared on the surfaces which are to receive the silver, so that nothing shall prevent the complete union of the two. The soldering is a process requiring much care and nicety; the plates of silver are thinly coated with a concentrated solution of borax, and are then applied to the prepared surfaces of the ingot, to which they are firmly bound with iron wire, and then placed in the *plating-furnace*, and subjected to a strong heat. This furnace is so arranged that the interior can be constantly watched, and when the proper temperature is attained the workman knows the exact instant to withdraw it. The act of soldering is almost instantaneous, and fusion would immediately follow if the ingot was not quickly withdrawn. When cooled, the wire is taken off, and the ingot is taken to the rolling-mill, where it is passed backward and forward, of course with the silver above and below, until it is rolled out into a sheet of the exact thickness required. However thin it may be made, it is found that the relative thickness between the ingot and its layers of silver is always the same. Practically all plating of metals is now performed by the process of electroplating. See **ELECTRO-CHEMISTRY**, **INDUSTRIAL**; **TABLEWARE**, **SILVER-PLATED**.

PLATEAU, plá-tó' (Fr., diminutive of *plat*, plate). An elevated area of fairly level land with approximately horizontal strata. The chief difference between a plain and a plateau is that the plateau is higher; but this very difference in altitude gives the streams a chance to cut deeper valleys than in a plain. Plateaus are almost uniformly associated with mountains, being

great blocks of strata uplifted during mountain folding with little disturbance of the layers. Thus the uplift that formed the Western Cordilleras raised the plateau known as the Great Plains, which rises gently from the Mississippi to an elevation of 4000-6000 feet at the base of the Rockies; the Colorado Plateau, between the Rockies and the Sierra Nevada, 6000-9000 feet high; and the Columbia Plateau of Oregon and Washington. West of the Appalachians, and uplifted with them, is the Allegheny Plateau, 2000 feet or more in height, which extends from eastern New York to Tennessee and includes hilly central New York, western Pennsylvania, West Virginia, eastern Kentucky, and Tennessee. The uplift of the Himalayas has formed the lofty plateau of Central Asia, which rises from 10,000 to 13,000 feet. Plateaus are frequently so sculptured by denudation as to resemble mountains in form as well as in height, as in the case of the Catskills, a part of the Allegheny Plateau. Their tops, however, form an even sky line, their strata are nearly horizontal, and it is only the excessive denudation, carving deep valleys, that has given them the mountainous appearance. For such dissected plateaus the name pseudo-mountains has been proposed. Where sculptured plateaus are adjacent to mountains it is often difficult to tell where the plateau leaves off and the true mountain begins.

Because of their elevation, plateau streams have great cutting power and often form deep gorges, and, in arid regions, cañons, of which the best example is the Grand Cañon of the Colorado. In arid regions the plateau topography is typically angular. The walls of the cañons consist of alternate precipices and talus slopes, as resistant and weak rock layers are encountered, and between the streams are flat-topped areas, capped by resistant strata, and known in Western America as mesas if large, and as buttes if small. It is this flat-topped condition of the plateau, faced by steep slopes, that has given rise to the name tableland as a synonym for many plateaus in arid lands. Plateaus, in moist climates, where the work of weathering and erosion is greater, are far less rugged and angular.

By reason of their height, plateaus are generally cool, and, because of their association with mountains, they are often arid, having rain-bearing winds cut off by the higher land near by. Plateaus are not infrequently deserts, for other reasons. The high plateau region of Africa and Arabia, for example, is traversed by the drying trade winds the year round and has little or no vegetation. Often the only parts of a desert plateau capable of supporting human life are the alluvial fans, on which streams flow from the adjacent mountains for a short distance before losing themselves in the sand. Portions of many plateaus, for example that of the Columbia, would be capable of cultivation if the water could be led out of the cañon valleys. In temperature there is often great range, from the warm base to the cool or cold top. This is well illustrated in the plateau of Mexico, which rises from a tropical climate to that of the cool temperate zone. Difference in temperature is accompanied by a decrease in evaporation and an increase in precipitation, so that the tops of high plateaus are often forest-covered, as in the case of the Colorado Plateau, which rises from the desert region of western Arizona.



When the strata of deeply dissected plateaus contain mineral deposits, like the coal of western Pennsylvania and West Virginia, they are important mineral-producing regions, because the mineral deposits are exposed where the deep valleys cut into the horizontal strata. In the Allegheny Plateau such valleys have cut down fully 1000 feet, while in the Colorado Cañon the horizontal layers are revealed for over 6000 feet. Agriculture is not usually highly developed on plateaus, partly because of the climate, partly because of the ruggedness. Grazing is the most widespread industry on arid plateaus, as in the Western United States, where large areas are occupied only by scattered ranchmen. Consult: Davis, *Physical Geography* (Boston, 1898); Tarr and McMurry, *Physical Geography* (New York, 1897). See MOUNTAIN.







PLATEAU, JOSEPH ANTOINE FERDINAND (1801-83). A Belgian physicist. He was born in Brussels and was educated at Liège. At the foundation of the University of Ghent in 1835 he became professor of experimental physics and astronomy, a position he occupied until 1871. His researches were largely carried on in the field of optics and he devised the anorthoscope and other apparatus. His work is most remarkable inasmuch as much of it was accomplished while he was suffering from total blindness brought on by experimental work about 1840. He invented the experiment which has since been known by his name to illustrate molecular forces, in which a mixture of alcohol and water is made of the same density as olive oil and a drop of the latter placed in it. The oil will assume a spherical shape, to which it will always return. He also originated the interesting experiment in which wire frames are immersed in soapy water and then films produced which intersect in straight, sharp lines. These and other experiments are described in *Statique des liquides soumis aux forces moléculaires*, published in 1873. Professor Plateau also prepared a bibliography of the subjective phenomena of vision to the end of the eighteenth century.

PLATED WARE. See TABLEWARE, SILVER-PLATED.

PLATE MARKS, or HALL MARKS. The legal impressions made in Great Britain on watch-cases, jewelry, and gold and silver plate, after the material has been assayed at the various Government assay offices. In the case of jewelry the marks are, with a few exceptions, optional. There are four distinct kinds of plate marks: (1) the standard or quality mark, (2) the mark of a particular office at which the article was assayed, (3) the mark by which the date of marking may be ascertained, and (4) the maker's private mark. Formerly if the article was dutiable the head of the reigning sovereign was also added, but in 1798 watch-cases were exempted from this rule, and in 1890 the practice was entirely abandoned. The standard mark of the London office is a lion passant  for sterling silver; a crown

with the figures 22  22 for 22-carat gold; and the crown with the figures 18 for 18-carat gold. Up to 1845 a lion passant was likewise the standard mark of 22-carat gold, and from 1697 to 1723, during which time the quality of standard silver was raised from .925 to .959, the

standard mark was a lion's head, and the hall mark a figure of Britannia. The standard mark at Edinburgh is a thistle ; at Glasgow, a lion rampant ; at Dublin, a harp crowned , with the figure 22 added in the case of 22-carat gold.

The hall marks of some of the particular assay offices are: London, a leopard's head, crowned up to 1823 ; Edinburgh, a castle ; Glasgow, a tree, a fish, and a bell ; Dublin, a figure of Hibernia ; Chester, a sword between three wheat sheaves ; Birmingham, an anchor  . In addition,

the Sheffield office is designated by a crown; Exeter, by a castle with three towers; York, by five lions on a cross; and Newcastle, by three castles.

The date-marks of the Goldsmith's Hall, London, which are changed annually on May 30th, are the first 20 letters of the alphabet, each series differing in some slight detail (either in the style of the letter or in the shape of the shield on which they are placed) from a former series. The date-marks of Birmingham, which are changed annually in July, are also letters of the alphabet.

The character of the maker's mark was optional up to 1697, when it was fixed as the first three letters of his surname. Since 1739 the mark has been the initials of the maker's Christian name and surname. Watch-cases of foreign make when marked in Great Britain bear special stamps. In Switzerland there are various plate marks, but the regulations concerning them are not comprehensive, and English marks are accepted in place of the Swiss.

BIBLIOGRAPHY. Consult: Britten, *Watch and Clock-Makers' Handbook* (London, 9th ed., 1896); Chaffer, *Handbook to Hall Marks on Gold and Silver Plate* (ib., 1898); Cripps, *English Plate Marks* (ib., 1882); id., *Old English Plate* (ib., 1886).

PLATEN-HALLERMUND, plät'en häll'ēr-mūnt, AUGUST, Count (1796-1835). A distinguished German poet, born at Ansbach. Educated in the Corps of Cadets and the Pages' Institute at Munich, he entered the Bavarian army in 1814, took part in the campaign of 1815, but, wearied afterwards by the dreary monotony of garrison duty, he obtained a furlough and, provided with a stipend, devoted himself to philological and philosophical studies, first at Würzburg (1818-19), then until 1825 at Erlangen, where Schelling exercised a lasting influence upon him. He had early turned to Oriental studies and as a fruit thereof published in 1821 *Ghaselen*, a collection of poems in Oriental forms, which was followed in 1824 by *Neue Ghaselen*, both series winning a favorable comment from Goethe. A visit to Italy in 1824 inspired *Sonnette aus Venedig* (1825), the finest collection of sonnets in the German tongue, remarkable for classic beauty of form. Bitterly opposed to Romanticism as he found it, he appears nevertheless under romantic influence in his dramatic poem *Der glä-*

serne Pantoffel (1824), welded out of the fairy tales of Cinderella and Snowdrop, in the comedy *Der Schatz des Rhampsinit* (1824), and in his later epic *Die Abbassiden* (1834), based on stories from the *Arabian Nights*. The extravagances of German Romanticism, however, kindled his wrath, and he satirized the 'fate tragedy' effectually in *Die verhängnissvolle Gabel* (1826), a fork here taking the place of the dagger by which, in the typical fate tragedy, the family ancestress comes to grief, and a dozen descendants being stabbed by the 'fatal fork' before the close of the drama. The command of language and mastery of versification distinguishing this literary comedy are even excelled in *Der romantische Edipus* (1829), directed more especially against the lack of form in Romanticism and its tendency to experiment with new and unwieldy metres, the chief target of Platen's satire here being Immermann (q.v.), parodied as "Nimmermann." In 1826 Platen had made Italy his permanent home and thence only twice visited his native land. During his last sojourn in Germany in 1833 he published the historical drama *Die Liga von Cambrai* and *Geschichten des Königreichs Neapel von 1414 bis 1443*. He died at Syracuse, Sicily. Platen was no genius, but a poet of exquisite taste, whose later verses are models of formal virtuosity in their complex rhythms and technical polish of rhyme. His best biography is to be found in his *Tagebücher*, edited by Laubmann and Sehefler (Stuttgart, 1896-1900). Consult also: Minckwitz, *Graf Platen als Mensch und Dichter* (Leipzig, 1838); Gildersleeve, *Essays and Studies* (New York, 1890); Besson, *Platen, étude biographique et littéraire* (Paris, 1894); and Greulich, *Platen's Litteraturkomödien* (Bern, 1901).

PLATHANDLER, plät'händ'lēr. A Dutch name in South Africa for the curious clawed toad (*Xinopus calcaratus*), which is distinguished by having strong metatarsal claws and minute eyes. These small frogs, which are tongueless, are peculiarly aquatic, never leaving the water except when forced to change their locality on account of drought or scarcity of food. Specimens have been naturalized in England, where their habits and methods of breeding have been well studied. Consult Gadow, *Amphibia and Reptiles* (London, 1901).

PLATINA, plät-tē'nà, BARTOLOMMEO DE (1421-51). An Italian humanist and historian. He was born at Piadena (Lat. form Platina, hence his name), near Cremona. His family name was Sacchi. In 1464 he became an abbreviator at the Papal courts, but with many of his colleagues was removed the same year on the accession of the new Pope, Paul II. For his boldness in pleading that the abbreviators held their office for life he was imprisoned for four months, and again in 1468 on the charge of conspiracy. Sixtus IV. appointed him superintendent of the Vatican library in 1475, and he retained the position till his death. At the invitation of Sixtus he wrote the lives of the popes, from Saint Peter to Paul II. inclusive. This work, originally in Latin, was published at Venice in 1479, and has been repeatedly reprinted and translated. The later portions, which rest upon the testimony of contemporaries and his own experience, are considered the best. The English translation of 1685 was revised by Benham and published in the *Ancient*

and *Modern Library of Theological Literature* (2 vols., London, 1885).

PLATING. See ELECTRO-CHEMISTRY, INDUSTRIAL; and ELECTRO-PLATING.

PLAT'INIRID'IUM (Neo-Lat., from *platinum* + *iridium*). A native alloy of iridium with platinum and allied metals that crystallizes in the isometric system, has a metallic lustre, and is silver-white in color. It is found chiefly with platinum ores in the Urals and in Brazil; also in the gold alluvial deposits of the Pacific Coast.

PLATINUM (Neo-Lat., from *platina*, from Sp. *platina*, platinum, from *plata*, silver, plate, from *plato*, flat, from Gk. *πλάτεις*, *platys*, flat, wide, broad; connected with Lith. *platus*, broad, Skt. *prthu*, wide, from *prath*, to spread out). A metallic element, the existence of which was first made known in Europe by Antonio de Ulloa in 1736. It was first described by Watson in 1750. It is found native, usually alloyed, however, with iron, palladium, rhodium, iridium, osmium, and other metals, generally in grains and scales in alluvial deposits in South America, the Urals, in Borneo, Santo Domingo, and New Zealand; also in small quantities in the gold washings of the Pacific Slope. A few irregular lumps or nuggets have been found, one of which, now in the Demidoff cabinet in Saint Petersburg, weighs 7837 kilograms. For the preparation of pure platinum the commercial metal may be melted with 6 parts of pure lead and the finely divided alloy treated with dilute nitric acid. The residual black powder may then be dissolved in dilute aqua regia, the solution precipitated with dilute sulphuric acid, and the filtrate further precipitated with an excess of ammonium chloride and some common salt. This precipitate is in turn heated with the acid sulphates of potassium and ammonium, and on cooling the resulting mass is treated with hot water, which leaves nothing but pure platinum behind. The commercial metal is usually obtained by a somewhat complicated wet process, although it is possible to obtain it more or less pure also by a dry process.

Platinum (symbol Pt.; atomic weight, 194.89) is a grayish-white metal with a specific gravity of 21.48 at about 17.6° C. It fuses at about 2000° C. (3630° F.). It is very malleable and ductile, becoming soft and workable at a temperature far below its melting-point. Wires have been drawn that are one twelve-hundredth of an inch in diameter. Molten platinum absorbs oxygen, which it gives off when rapidly cooled. Red-hot platinum also occludes hydrogen, to the extent of about five times its own volume, and retains it indefinitely after cooling. *Spongy platinum* is finely divided metallic platinum which possesses a very large surface compared with its mass and is able to condense large quantities of oxygen. It is readily prepared by igniting ammonium-platinum chloride. It forms a porous mass which may be polished with a burnisher. Of similar nature is *platinum black*, that is usually prepared by heating a solution of platinum chloride in potash and alcohol. It absorbs more than 800 times its volume of oxygen. Platinum forms alloys with most of the metals, some of which, such as the alloy with 10 per cent. iridium, have found use in the arts, especially for the purpose of making standard weights and measures. Metallic platinum is employed in making crucibles and similar utensils for labora-

tory use, and as it is not attacked by acids, vessels of it have been used in sulphuric acid works. It also finds extensive application in the manufacture of incandescent electric lamps, being the only metal that can be used to pass through the glass lamp bulbs making a tight joint. Methods have been proposed for its electrolytic deposition, but they have not been generally adopted. It has been used in Russia for the coinage of high values of money. During 1900 400 Troy ounces of metallic platinum, valued at \$2500, were mined in the United States.

Platinum combines with oxygen to form a platinum oxide or monoxide (PtO), which gives rise to a series of platinum salts, a platinum-platinic oxide (Pt₂O₄), and a platinum oxide or dioxide (PtO₂), which yields a series of platinic salts. The most important of the platinum salts is the platinic chloride or platinum tetrachloride, which is a brownish red deliquescent salt, a solution of which is used in the laboratory as a reagent. Of considerable interest to the chemist are also the so-called platinum bases, which are compounds of platinum salts with ammonia.

METALLURGY. The extraction of platinum from the ore consists first in concentrating the ore by washing; the further treatment may be conducted either in the wet way or the dry way. The dry method does not produce pure platinum, but its alloys with iridium and rhodium, and the production of pure platinum requires the use of the wet method. Electrolysis is used to separate metallic platinum from its alloys with gold. Two methods of dry extraction have been used. One consists in melting the ore in a vessel made of lime and remelting the button thus obtained; the second method is to melt the ore with galena and litharge in a reverberatory furnace and scoriafy the lead-platinum alloy obtained in order to remove the lead. Finally the platinum is fused into an ingot in the lime furnace. The wet method of extraction consists essentially in bringing platinum into solution with aqua regia, precipitating from this solution platinum-ammonium chloride by means of ammonium chloride and ammonia, and then decomposing the compound and separating the platinum at red heat. The wet method is the principal method of platinum refining now employed. Physically metallic platinum has an almost silver white lustre, is ductile and malleable in a high degree, is about as hard as copper, and has a tenacity between that of gold and of copper. For a concise treatment of the metallurgy of platinum, consult: Howe, *Bibliography of the Metals of the Platinum Group, 1748 to 1896* (Washington, 1897); Schnabel, *Hand-book of Metallurgy* (New York, 1898).

PLAT'NER, JOHN WINTHROP (1865—). An American theologian and Church historian, born in Lee, Mass. He graduated at Yale University in 1885, and at Union Theological Seminary in 1893, studied in Berlin, then was instructor in Union Seminary (1895-96), in 1896 became assistant professor of ecclesiastical history at Harvard, and in 1901 accepted a similar chair at Andover Theological Seminary. He contributed articles on historical theology to the *New International Encyclopedia*.

PLATNER, SAMUEL BALL (1863—). An American classical scholar, born in Unionville, Conn., and educated at Newark Academy and

at Yale University. After five years as instructor in Latin and French in Utica, N. Y., in 1890 he became assistant professor of Latin in Western Reserve University, where he became full professor in 1892. He was chosen secretary of the managing committee of the American School of Classical Studies in Rome in 1898, was professor there in 1899-1900, and for the year 1900-01 was president of the American Philological Association. He wrote *Selections from the Letters of the Younger Pliny* (1894) and *The Topography and Monuments of Ancient Rome* (1903).

PLATO (Lat., from Gk. πλάτων, *Platōn*) (c.427-347 B.C.). A Greek philosopher, born probably May 7, B.C. 427, on the island of Ægina, a dependency of Athens, where his father held an estate. His real name was Aristocles. His father claimed descent from Codrus; his mother, Perictione, from Solon. The known facts of his life are few. He received the education in music and gymnastics of a well-born Athenian youth, under the limitations imposed by the virtual state of siege created for Athens by the Peloponnesian War. His writings are sufficient evidence that he absorbed all the culture of his age; poetry, art, pre-Socratic philosophy, the Sophistic enlightenment (see SOPHISTS) in a synthesis, as Emerson says, "without parallel before or since." We may believe the tradition that he distinguished himself in gymnastics and wrote poetry. The poems he is said to have burned when, at the age of twenty, he experienced the higher inspiration of the philosophic muse through Socrates.

For a youth of Plato's birth and endowments, politics would have been the natural career. Two of his dialogues are named from his kinsmen Charmides and Critias, who were prominent in the oligarchy of the so-called Thirty Tyrants which dominated Athens in the year 404-03. The experiences of that year disenchanting him forever with regard to the rule of the 'Fair and Good,' as they called themselves. The judicial murder of Socrates by the restored democracy in the year 399 and the increasing license and weakness of popular rule through the fourth century further embittered his spirit and developed the conviction that all existing forms of government were mere partisan factions, and that there was no hope of salvation for the cities of Greece until "either philosophers should become kings or kings philosophers." The philosopher whose lot was cast in fourth century Athens could exercise active citizenship only in the city of the ideal, "of which a pattern is laid up in heaven"—the City of God of later Græco-Roman and early Christian idealism. The powers and social aspirations that might have made a great statesman and leader of men found expression in the *Republic* and *Laws*, the masterpieces of Plato's maturity and old age. After the death of Socrates Plato is said to have left Athens and to have traveled extensively in Greece, Southern Italy, Sicily, and even Egypt and Northern Africa. About the year 388 he is said to have visited the court of Dionysius the Elder, tyrant of Syracuse, who, offended by his freedom of speech, contrived to have him sold into slavery at Ægina on his voyage home. The story adds that he was at once ransomed by friends. Modern conjectural scholarship tries to trace in Plato's writings the chronological succession of Megarian, Italo-Pythagorean, Egyptian, and Sicilian influences experi-

enced in these voyagings. But we really know nothing beyond the presumption that he was much absent from Athens during the ten years that followed Socrates's death. At the age of forty, about the year 387, he established the 'Academy,' which, with the rhetorical school of Isocrates, made Athens in very deed the 'educator of Hellas,' and was the beginning of that 'university life at Athens' which continued for eight centuries. The name is derived from the hero Academus, adjoining whose shady precinct and gymnasium on the road to Eleusis, one mile from Athens, was the small estate which Plato dedicated to the uses of the school. By Plato's will, the institution was probably perpetuated as a religious foundation sacred to the Muses, and this organization was imitated in the Lyceum of Aristotle, the 'garden' of Epicurus, and the Museum of Alexandria. Here for forty years he taught, debated high and subtle questions with his favorite pupils, and "curled and combed the style of his dialogues" until his death in the year 347. Among his most famous pupils were Speusippus, his nephew, who succeeded him as scholar; Xenocrates, the successor of Speusippus; Aristotle (from the year 367), the orators Demosthenes, Hyperides, and Lycurges, the astronomer Eudoxus of Cnidos, and many other eminent men from all parts of Greece. The inner life of the school we can only divine. From Plato's sneers at the Sophists, who took pay for spiritual gifts, we may infer that no tuition fees were exacted. We may conjecture that some of the most abstract and metaphysical dialogues, as the *Parmenides*, the *Sophistes*, the *Politicus*, the *Philebus*, are idealizations of actual discussions in the school, as the *Charmides*, *Lysis*, *Protagoras*, and *Gorgias* are reflections of real conversations in the gymnasias and public resorts frequented by Socrates. A famous passage of the *Phædrus* exalts the spoken above the lifeless written word, and Plato, like those two other great artists in language, Renan and Ruskin, affected to hold mere literary virtuosity in light esteem. Contemporary writers of comedy represent the students of the Academy as dandified young coxcombs, and jest about the obscure 'idea of good,' and the scientific definition of the cucumber by dichotomy, much as the paragraphist of the modern newspaper alludes to transcendentalism and the 'beanfulness of the bean.' From this remote and sphered course, Plato was drawn into the turmoil of real life by his two visits to Syracuse in the years 367 and 366 and shortly after. The younger Dionysius had succeeded his father as tyrant of Syracuse, and Dion, his kinsman by marriage, whose friendship Plato had won in his first visit, cherished the illusion that, under suitable guidance, the youthful ruler might develop into the philosopher king postulated in the *Republic*. The failure of the experiment, the banishment of Dion as its result, the expedition organized in the year 359 by Dion with the aid of pupils of the Academy against Dionysius, whom he drove into exile in turn, his assassination by his fellow pupil Callippus, and the anarchy into which Syracuse was plunged as a consequence, furnished abundant matter for those inclined to blaspheme philosophy and scoff at the scholar in politics, and may plausibly be conjectured to have contributed to the mood of embitterment and disillusion that prevails in the great work of Plato's declining years, the *Laws*.

The pathos of Plato's old age has been beautifully expressed by Wilamowitz (*Aristoteles und Athen*, vol. i., p. 330). But credible anecdotes illustrative of the esteem and love in which he was held by his fellow citizens and numerous pupils soften the picture. If some illusions were gone, the grasp of thought and the synoptic command of experience remained to the end, and in reading his later works we feel that, like the aged Cephalus in the *Republic*, the man stands on the heights of a noble life "with a glimpse of a height that is higher." The *Laus* lacks the inimitable Attic grace of the *Symposium* and the *Phædo*, but the thoughtful reader finds compensation in the breadth of its survey of human life and Greek institutions, its intense moral and religious earnestness, the solemn detachment of its resigned and stately melancholy. As Jowett finely says: "The wings of his imagination have begun to droop, but his experience of life remains, and he turns from the contemplation of the eternal to take a last sad look at human affairs."

Plato's extant writings (including probably all he ever published) are arranged by the rhetor Thrasyllus (first century A.D.) in nine tetralogies or groups of four. One member of the ninth group is constituted by the thirteen letters which are almost certainly spurious, though some historians now defend the genuineness of the seventh epistle because of the interesting and plausible account which it gives of Plato's relations with the court of Syracuse. Of the thirty-five dialogues, the *Hipparchus*, on the love of gain; the *Erastus* and the *Theages*, on philosophy; the *Minos*, on law; and the *Epinomis*, a sort of supplement to the *Laus*, are generally acknowledged to be spurious. Many reputable scholars still doubt the genuineness of the *Aleibiades I.*, on the nature of man; the *Alcibiades II.*, on prayer; the *Hippias I.*, on the beautiful; the *Hippias II.*, on falsehood; the *Ion*, on Homer and poetical inspiration; the *Menexenus* or Funeral Oration; and the *Kleitophon*, a fragment. The acceptance or rejection of these seven minor works affects very slightly our total impression of Plato's thought and art.

The dialogues vary in length from the twenty-two pages of the *Crito* to the four hundred and eighteen pages of the *Laus*, and in manner from the lively dramatic representation of a possible conversation in a Greek gymnasium (the *Lysis* on Friendship, the *Charmides* on Temperance), to the didactic exposition in perfunctory dramatic form of an obscure problem of logic or metaphysics (*Sophistes*, *Parmenides*), a theory of the universe (*Timæus*) or a project for the reformation of society, education, and law (*Republic*, *Laus*). The dialogue form arose naturally out of the Greek drama, the Athenian habit of discussion, and its practice by Socrates. Its history has been written by Hirzel (*Der Dialog*, Leipzig, 1895). It was employed by other disciples of Socrates as well as by Plato, and specimens of such dialogues are included in Xenophon's *Memorabilia* of Socrates. The form is sometimes purely dramatic, as in the *Euthyphro* on holiness, or the *Gorgias* on rhetoric; sometimes, as in the *Republic*, it is that of a narrated dialogue, which permits description and comment as in the modern novel. Socrates is the principal speaker in all except the *Sophistes*, *Politicus*, *Parmenides*, *Timæus*, *Critias*, and the *Laus*, in which last he does not appear at all.

One of the chief problems of recent Platonic

scholarship is the determination of the dates of the dialogues through statistical study of the style (Lutoslawski, *Origin and Growth of Plato's Logic*), by tracing the development of Plato's thought, or by the aid of casual historical allusions. The results, though affirmed with confident dogmatism, cannot be verified. The *Laus* and *Timæus* are known to be late. The *Republic* belongs to Plato's middle age. The minor dramatic dialogues are presumably as a whole early. The severely metaphysical *Sophistes*, *Politicus*, and *Philebus* probably follow the *Republic* rather than precede it, as older scholars believed. But the unity and consistency of Plato's thought as a whole, and the tradition that he revised and corrected his greater works to the end, lessen the significance of these researches.

The perennial charm of Plato resides precisely in the baffling combination which he presents of consummate artist and subtle metaphysician. We may say roughly that the dialogues have three chief aims: (1) The ideal portraiture of the master Socrates (see SOCRATES); (2) the dramatic portrayal of the practice of discussion, the 'game of question and answer,' as it has been called, which played so large a part in Athenian life; (3) the exposition of doctrine. Plato is the Shakespeare of ideas. All ideas are allowed to speak for themselves on his stage with something of the dramatic fairness that seems to justify every personage, from his own point of view, upon the stage of Shakespeare. And though it is not so difficult to determine in this dramatic conflict of ideas the beliefs seriously defended by Plato as it is to observe the habitual preferences that define Shakespeare's personality, it is still very difficult. The hasty reader will accept as Platonic definitions distinctions, arguments, and fallacies that have a purely dramatic significance. He will interpret as marking stages in the development of Plato's own thought professions of ignorance or bewilderment which the Socratic irony employs merely to ensnare pretentious self-sufficiency, to stimulate youthful thought, or as a dramatic prelude to the favorite Socratic moral: "Let us re-examine the whole question together." He will take literally Socrates's affectation of following whithersoever the wind of discussion may blow, and, dazzled by the kaleidoscopic shiftings of suggestion and interesting ideas, he will be skeptical of the existence of any underlying unity of thought and purpose.

Instead of falsifying Plato's teaching by forcing it into the framework of an artificial system, it is better simply to enumerate a few of the dominant conceptions and aims that preserve its unity and consistency amid all its apparent variations. There is first dialectic—the faith which he shared with Socrates in the value of rational discussion, if not as the organon of absolute truth, at least as the only protection against the errors and confusions of untested opinion. Both Plato and Socrates believe that, as John Stuart Mill phrases it, "there is no knowledge, and no assurance of right belief, but with him who can both confute the opposite opinion and successfully defend his own against confutation." Many of the most entertaining passages of the dialogues are mere dramatic illustrations of the inability not only of the average man, but of the most brilliant sophists and rhetoricians of the day to do this (*Gorgias*, *Protagoras*). They could bandy abstractions implying praise or

blame, and discourse eloquently of virtue and the education that fitted men for life. But they could not define the terms they used, or defend the coherency and consistency of their opinions against objectors. They were unable to make the preliminary distinctions and classifications requisite for the intelligent discussion of such questions as 'Can virtue be taught?' (*Meno*) or 'Is pleasure or knowledge the good?' (*Philebus*). They had opinions, but no knowledge. Dialectic was said to have been 'invented' by Zeno, the author of the famous fallacies disproving motion; and the Athenians of the fifth century were subtle and skillful disputants. But the rules of the game (the principles of elementary logic) had never been formulated, and Socrates was the first to play it with system and conscious mastery. He demanded definitions of general terms and confirmed or refuted them by apt induction and generalization from simple pertinent instances. So great was his skill that, as Xenophon affirms and Plato illustrates, he could deal with an opponent as he pleased. None could escape the network of argument which he wove. Plato inherited from Socrates his intense conviction of the difference between untested opinion and reasoned knowledge, and, starting from the Socratic logic of the definition and simple induction, he worked out in concrete examples the details of the logic of consistency so that all that remained for Aristotle was to codify them and add the formulas of the syllogism. In the prosecution of this task Plato was confronted by certain quibbles about being and not being, the one and the many, the whole and the part, rest and motion, the reality or unreality of abstract ideas, which from one point of view are mere verbal fallacies, from another are problems of psychology and metaphysics. To interpret aright the more metaphysical and abstract dialogues, we must remember that, whether Plato succeeded or failed in solving metaphysical problems which are still debated, he never lost sight of his main object, the removal of the verbal fallacies from the pathway of practical logic. Familiarity with the Aristotelian logic makes this seem a trifle to us. But to accomplish it for the first time was one of the greatest achievements of human genius.

A second fundamental Platonic thought is the postulate that the art of conduct, of individual and social life, ought to be as truly scientific as are the various arts and sciences that deal with material things. To emphasize this thought, Plato makes use of the favorite Socratic comparison or confusion of the virtues and the arts. As there is an art of carpentry or shoemaking known only to him who has mastered it, so 'virtue,' the art of happiness, of conduct, the 'political' or 'royal' art, must be conceived as a specific form of knowledge demanding a special training in its possessor. To the end or aim of the 'royal art' all partial and particular ends would be subordinated—it would be an 'idea of good' in which all particular goods, virtues, and utilities have their ground. Many of the minor dialogues illustrate the inability of the average disputant to apprehend any such larger end, or to define particular virtues and ends in relation to it. Others refute the pretensions of the sophists, rhetoricians, and politicians who claim to teach or practice the art of life and government, but in fact teach only the opinions of the multitude—the humors of the many-headed beast, or

the knack of persuasive speech, or the tricks by which the politician seizes the helm of the ship of state, though he has never learned to steer. Even the few virtuous and judicious statesmen of whom Athens boasts are guided not by knowledge, but by right opinion or happy instinct, which, in the corruption of the existing social order and the absence of all systematic and effective teaching of 'virtue,' must be said to come to them by grace divine (*Meno*).

The *Republic* contains the positive and constructive application of these ideas. There Plato expounds his ideal of a city in which the end of government is not the domination of a faction, nor the multiplication of wealth, nor doing as one likes, but the virtue and consequently the true happiness of the individual citizen, and the order and harmony of the whole. The chief means to this end is justice—the division of labor generalized to mean the proper distribution of function among the three faculties of the soul, the appetites and desires, the emotions and passions, and the ruling reason, and answering to this the severe limitation to their proper work of the corresponding groups of the population—the industrial, the military, and the governing classes—determined by birth only in so far as birth is found to involve natural aptitude. The rulers, the embodied reason of the State, are selected by severe tests from the warriors. Absolute disinterestedness is secured by forbidding them to hold private property and by the paradoxical community of wives and offspring. In order to master the 'political art,' they must supplement the ordinary education in music and gymnastics by a prolonged discipline in mathematics, astronomy, and dialectic, which, as Plato expresses it in a poetical figure, the source of much later mysticism, will enable them to apprehend the 'idea of good,' the cause of light and truth and being in the intelligible world, as the sun is in the world of matter. In the *Republic*, as everywhere, the logical skeleton of Plato's ethical and political theory is clothed with an eloquence nobly employed in the assertion of the ideal aims of life as against base, sensuous, and sordid views of happiness and success. And many readers who care nothing for the abstract logic of Plato's ethical philosophy will be charmed or inspired by the preacher and prophet—his impassioned faith in the moral order of the world, his denunciation of materialistic, sensationist, and hedonistic philosophies, his affirmation in poetical myth and allegory of the hope of immortality and the inevitableness of the judgment of God.

Space fails to speak further of these things; of the vague but devout theism which, without breaking formally with the established polytheism, Plato everywhere professes; of the sage and serious doctrine of Platonic love set forth in the *Phædrus* and *Symposium*, whereby sensuous passion is made the prefigurement and symbol of spiritual exaltation and of all aspirations toward the good, the true, and the beautiful; of the fantastic poetical physics of the *Timæus* with its startling glimpses of the latest truths of science; of the puritanic banishment of Homer from the ideal State, in strange and pathetic contradiction to the poetical fervor of Plato's own temperament and his theory of the divine inspiration of poesy; of countless other things that secure Plato his place not only in the litera-

ture of philosophy, but in that of religion, mysticism, poetry, and æsthetic criticism.

But a word must be said of the theory of ideas with which most expositors of Plato begin and which might be made the centre of the Platonic philosophy. Taken literally, it is the assertion of the astounding paradox that reality belongs not to the individual thing, this book, this tree, this man, but to the general idea of book, tree, or man. The individual things are but the fleeting, perishable copies of the Form or Idea which abides in changeless unity forever, and is the sole object of real knowledge. Primarily, this is merely a paradoxical logic of general terms, which, employed with Plato's unflinching consistency, serves as well as the reverse mode of speech that alone seems reasonable to us. In the second place, it is a manifestation of the plasticity of the Greek imagination which in Plato, as in the mythology and on the stage of Aristophanes, refuses to deal with ideas as algebraic counters, but since they are real forces in thought, life, and speech, treats them as veritable things and persons. In the third place, it is a metaphysical doctrine with regard to the *noumenon* or reality behind the veil of sense which all philosophies that acknowledge an absolute, whether in being or cognition, are compelled to assume. Only those who are willing to affirm that sense is all can consistently condemn as absurd Plato's assertion that ultimate realities are more akin to our ideas than to our sensations and perceptions. Many passages show that Plato saw, as clearly as his modern critics see, the conflict of this doctrine with common sense. But metaphysics is not common sense. The ideas were the only alternative, he thought, to the philosophy of Heraclitus that all things are in perpetual flux, which Plato interpreted to mean, in modern phrase, that reality is merely 'the permanent possibility of sensation.' It is because he would not accept this doctrine that Plato clung to the ideas; not, as we are so often told, because in the infancy of human thought he did not 'understand' the processes of generalization and abstraction.

Associated with the theory of ideas is the poetical doctrine of reminiscence or recollection. The soul has beheld the ideas in a previous stage of existence. "Our birth," as Wordsworth says, "is but a sleep and a forgetting." Learning, experience, is the re-collection of the ideas through the suggestions and association of their imperfect copies in this world. We have never seen two things absolutely equal, but we recollect the idea and ideal of pure equality from the proximate equals of experience. Mathematical truths can be elicited from an uneducated man by skillful questioning (*Meno*). The idea of beauty alone has a not wholly inadequate embodiment on earth. Hence the peculiar ecstasy of the thrill which the aspect of beauty stirs in the lover. It awakens immortal memories of the soul's beatific vision of the idea.

Plato's writings exercised an inestimable influence on Aristotle, the Stoics, Cicero, Plutarch, the Neo-Platonists, the Christian Fathers, the earlier scholastics, the philosophy and poetry of the Renaissance in Italy and England, and on the nineteenth-century revival of historical and philosophical studies in Germany. His influence is rather increasing than diminishing in the higher literature and scholarship of our own time. Nor is it likely soon to wane. To borrow his own

half mystical imagery, he purges the eye of the soul, that it may discern spiritual truth, and converts it from the observation of the transient shadows of the fire-lit cave, to the contemplation *sub specie æternitatis* of the abiding forms of pure being illumined by the idea of good.

BIBLIOGRAPHY. The best critical edition of the text is that of Schanz, still incomplete. Good and convenient texts abound—in the Teubner Series, in the Didot Bibliotheca, and that now in course of publication at Oxford. The chief complete annotated edition is that of Stallbaum with Latin notes, parts of which have been re-edited by other scholars. Campbell's *Theætetus*, *Sophistes*, and *Politicus*, Jowett and Campbell's *Republic*, Archer Hind's *Phædo* and *Timæus*, and Bury's *Philebus* are well known. School and college editions of the *Apology* and *Crito*, the *Protagoras*, *Georgias*, *Meno*, and *Euthyphro* abound. Jowett's translation (3d ed.) supersedes all others for English readers. Grote's four volumes of summary and comment cite the literature down to the year 1866. The volume on Plato in the last edition of Zeller's *History of Greek Philosophy* is the fullest scholarly treatment of the whole subject. Professor Ritchie's *Plato* (New York, 1902) is a readable sketch. For the right understanding of Plato, however, the best guide is Mill's review of Grote (*Dissertations and Discussions*, vol. iv., p. 227), supplemented where unsympathetic by Pater's *Plato and Platonism* (New York, 1893), and Emerson's essay in *Representative Men*.

PLATO'DA. See PLATYHELMINTHES.

PLATOFF, plä'töf, MATVEI IVANOVITCH, Count (1751-1818). A Russian general and hetman of the Cossacks of the Don. He was born on the banks of the Don, August 17 (6), 1751, and was of Greek descent. In 1765 he entered the Russian Army and distinguished himself in the wars against Turkey and France, so that in 1801 he was appointed by Alexander I. hetman of the Cossacks, and lieutenant-general in the Russian Army. As commander of the Russian irregular cavalry, he took a prominent part in the further wars with France and Turkey. In the War of 1812, after the French had evacuated Moscow, Platoff hung upon their rear with the utmost pertinacity, wearying them by incessant attacks, cutting off straggling parties, capturing their convoys of provisions, and keeping them in a state of continual terror and apprehension. French historians state that Napoleon's army suffered more loss from the attacks of Platoff's Cossacks than from privation and exhaustion. After crossing the Prussian frontier he occupied Marienwerder and other cities. On May 28, 1813, he defeated Lefebvre at Altenburg. After the defeat of the French at Leipzig he inflicted great loss upon them in their retreat, and subsequently gained a victory over them at Laon. His undisciplined bands committed great depredations everywhere, but Platoff was loaded with honors by the monarchs who were warring against France. Alexander made him a count in 1812.

PLATONIC BODIES. See POLYHEDRON.

PLATO OF TIVOLI, or TIBURTINUS (c.1120). A translator of Arabic mathematical manuscripts. He is known chiefly for his translation of the trigonometry and astronomy of Al Battani. Among his contemporaries are Gerard of Cremona, Athelard of Bath, and John of Seville,

likewise known for their translations of Arabic mathematical manuscripts into Latin.

PLATOON (Fr. *peloton*, platoon, tennis-ball, diminutive of *pelote*, OF. *pelote*, *pelotte*, ball, from ML. *pilota*, diminutive of Lat. *pila*, ball). A term formerly used to designate a body of troops who fired together. In its modern sense, in the United States Army, it is practically half a company of infantry. The company is divided into two platoons, and each platoon into two sections. Two or three squads constitute a section, the squad consisting of four files, a corporal and seven privates, the corporal being the squad leader. The first lieutenant is in command of the first platoon, and the second lieutenant of the second platoon. The term is obsolete in the British Army, that of *half-company* being substituted.

PLATT, CHARLES ADAMS (1861—). An American landscape architect, painter, and etcher. He was born in New York City, and studied at the schools of the National Academy of Design and the Art Students' League from 1878 to 1880. In 1882 he went to Paris, where he worked for four years under Boulanger and Lefebvre, and exhibited at the Salon. His best paintings include "Clouds," which was awarded the Webb prize offered by the Society of American Artists, and "Snow," awarded a bronze medal at the Paris Exposition of 1900. He also received a medal at the Buffalo Exposition of 1901. As an etcher he produced some good work, selecting his subjects principally from the lives of Dutch fishermen and from scenes in Holland.

PLATT, ORVILLE HITCHCOCK (1827—). An American legislator and political leader, born at Washington, Conn. He received an academic education, studied law, and was admitted to the bar in 1849. He practiced law at Meriden, was clerk of the State Senate in 1855-56, and the next year became Secretary of State of Connecticut. He was elected as a Republican to the State Senate in 1861 and to the State House of Representatives in 1864 and 1869, the latter year being chosen Speaker. He succeeded William H. Barnum, Democrat, in the United States Senate on March 18, 1879, and was reelected in 1885, 1891, 1897, and 1903. On February 25, 1901, he reported from the Committee on Relations with Cuba an amendment to the Army Appropriation Bill which required the new Republic to place itself under the protection of the United States. This amendment was accepted by Cuba and was made part of its organic law.

PLATT, THOMAS COLLIER (1833—). An American political leader. He was born at Owego, N. Y.; studied at the Owego Academy, and was a member of the class of 1853 in Yale College, but withdrew in his junior year on account of ill health. He then went into business, became president of the Tioga National Bank, and invested largely in lumbering in Michigan. He was clerk of Tioga County in 1859-61, and a member of Congress from 1872 to 1876. In 1879 he was made secretary and director of the United States Express Company, and in 1880 became its president. He also acted as president of the Southern Central and other railways. In 1880 he was appointed a quarantine commissioner at the port of New York. In 1881 he was elected United States Senator, but within a few months both he

and Senator Roscoe Conkling, his colleague from New York, resigned because President Garfield did not defer sufficiently to their wishes in making appointments in New York. The immediate occasion of their resignation was the appointment by Garfield of W. H. Robertson as collector of the port of New York City. (See CONKLING, ROSCOE; and ROBERTSON, W. H.) In an appeal to the Legislature for reelection they were both defeated. Platt eventually gained virtual control of the Republican Party in New York and was again elected to the Senate both in 1897 and in 1903. He has been a delegate to all Republican national conventions since 1876 as well as a member of the National Republican Committee.

PLATTDEUTSCH, plät'doich, or Low SAXON. The language spoken in Northern Germany from the border of Holland to the frontier of Lithuania. It is distinguished on the one hand from Low Franconian, which includes the language of Holland, Dutch proper (see DUTCH LANGUAGE), and, on the other hand, from Middle and Upper German, which are grouped together under the name High German. In common with other Low German languages, Plattdeutsch is distinguished from High German by the fact that its surd mutes have not passed through the second or High German sound-shifting. (See GRIMM'S LAW.) There is, however, no definite line of demarcation, some of the Middle German dialects not having shifted *p* and *t*. The best criterion of distinction is the so-called *ich-line* which starts on the Belgian border south of Limburg and runs in a northeasterly direction, crossing the Rhine at Benrath (between Düsseldorf and Cologne), the Elbe south of Magdeburg, the Oder just above Frankfort, and finally reaches the Slavic frontier in the Province of Posen near Birnbaum. To the north of this line the first personal pronoun has the form *ik*, to the south *ich*. Within its district Plattdeutsch is generally spoken by the lower classes, while High German is the language of the school and pulpit, and as a rule of the educated classes.

Plattdeutsch is not a homogeneous language, but consists of a number of different dialects which may be divided into two main groups: (1) Northeast Saxon, in Oldenburg, Bremen, Hamburg, Hanover, Brunswick, Holstein, Mecklenburg, Brandenburg, Pomerania, and East Prussia; (2) Westphalian, in Westphalia and the Principality of Waldeck. During the nineteenth century the dialect of Mecklenburg acquired especial prominence through the writings of Fritz Reuter.

Historically Low Saxon is divided into (1) Old Saxon or Old Low German, extending from the ninth to the twelfth century; (2) Middle Low Saxon, from the twelfth to the end of the sixteenth century; (3) Modern Low Saxon, Plattdeutsch, or Modern Low German, from 1600 to the present time.

In the Old Saxon period the principal literary monument is the *Heliand* (q.v.), a religious epic of nearly 6000 lines in alliterative verse, written about 830 at the request of Louis the Pious. Several fragments of a versification of the first chapters of the Book of Genesis, an interlinear version of the Psalms, and various other smaller fragments of a religious character have been preserved, besides a number of glosses and proper names. Old Saxon may also lay partial claim to the *Hildebrand's Lay*, the most famous of all

old German ballads, as it is written partly in this dialect.

The most noted prose document of the Middle Low Saxon is the *Sachsenspiegel*, a compilation of Saxon common law, made by Eyke von Repchow between 1224 and 1230, and which became the model for law books in other parts of Germany. From 1350 through the fifteenth century there is an extensive Low German literature, which is mainly religious in character, consisting largely of legends of the Church and collections of hymns. Among secular poems may be mentioned *Reincke der Vos* (Lübeck, 1498) and *Flore und Blankflur*. About the middle of the seventeenth century Low Saxon ceased to be a literary language, the last Low Saxon Bible appearing at Goslar in 1621. In modern times what little literature has appeared has been of a decidedly dialectical character. Especially prominent are Fritz Reuter (q.v.), best known for his humorous novel *Ut mine Stromtid* and the poem *Hanne Nüte*, and Klaus Groth (q.v.), a writer of lyric poems, as the *Guickborn*.

Consult: Heyne, *Kleine altsächsische und altniederfränkische Grammatik* (Paderborn, 1873); Gallé, *Altsächsische Grammatik* (Halle, 1891); Schlüter, *Untersuchungen zur Geschichte der altsächsischen Sprache* (Göttingen, 1892); Holt-hausen, *Altsächsisches Elementarbuch* (Heidelberg, 1899); Schmeller, *Glossarium Saxonum* (Munich, 1840); Kögel and Brukner, "Geschichte der althoch- und altniederdeutschen Litteratur," in Paul, *Grundriss der germanischen Philologie*, vol. i. (2d ed., Strassburg, 1897 et seq.); Lüb-ben, *Mittelniederdeutsche Grammatik mit Chrestomathie und Glossar* (Leipzig, 1882); Schiller and Lüb-ben, *Mittelniederdeutsches Wörterbuch* (6 vols., Bremen, 1871-81); Lüb-ben and Walther, *Mittelniederdeutsches Handwörterbuch* (Norden, 1885-88); Jellingk, "Mittelniederdeutsche Litteratur," in Paul, vol. ii. (see above); Krüger, *Uebersicht der heutigen plattdeutschen Sprache* (Enden, 1843); Marahrens, *Grammatik der plattdeutschen Sprache* (Altona, 1858); Wiggers, *Grammatik der plattdeutschen Sprache* (2d ed., Hamburg, 1858); Esehenhagen, *Zur plattdeutschen Sprache* (Berlin, 1860); Gilow, *Leit-faden zur plattdeutschen Sprache* (Anklam, 1868); Dauneh, *Ueber die niederdeutsche Sprache und Litteratur* (Berlin, 1875); Zelling-haus, *Zur Einteilung der niederdeutschen Mundarten* (Kiel, 1884); Gädertz, *Das niederdeutsche Schauspiel* (Hamburg, 1894); Mentz, *Bibliographie der deutschen Mundartenforschung* (ib., 1892); *Jahrbuch des Vereins für niederdeutsche Sprachforschung* (Leipzig, 1875 et seq.).

PLATTE, or **NEBRASKA**. The principal river in Nebraska, and one of the largest tributaries of the Missouri. It is formed by the North and South Platte Rivers, which rise in the Rocky Mountains, and unite in Lincoln County, Neb. (Map: Nebraska, G 2). The North Platte has its source in northern Colorado, flows north into Wyoming, and then southeast into Nebraska. The South Platte rises in central Colorado, and flows northeastward to the junction. From there the main river flows eastward in two large curves through a broad and fertile alluvial bottom, entering the Missouri at Plattsmouth, 17 miles south of Omaha. Its total length, including the North Platte, is about 900 miles, but, although the main river is more than half a mile wide it is quite too shallow to be suited for navigation.

The South Platte is extensively used for irrigat-ing purposes.

PLATTENSEE, plät'ten-zâ. The largest lake of Hungary. See **BALATON, LAKE**.

PLATTER, plät'tër, THOMAS (1499-1582). A Swiss printer, scholar, and educator, born at Grenchen, near Visp. He was a goat herder in his boyhood; then, getting a little learning from a priest, saw Germany as a traveling scholar; and, returning to Switzerland, studied under Myconius at Zurich. His devotion to Zwingli spurred him to the study of Greek and Hebrew. At Basel he learned the rope-maker's trade, and worked at it at the same time that he was professor of Hebrew. His greatest claim to fame rests on his autobiography, written at his son's request in fourteen days, when the father was seventy-three. It gives a remarkable picture of the times, which is supplemented by that of his son, **FELIX PLATTER** (1536-1614), a doctor of medicine and instructor at Basel. The two biographies are edited by Heman (Gütersloh, 1882). Consult Boos, *Thomas und Felix Platter* (Leipzig, 1878).

PLATTEVILLE. A city in Grant County, Wis., 135 miles west by south of Milwaukee; on the Chicago, Milwaukee and Saint Paul and the Chicago and Northwestern railroads (Map: Wisconsin, C 6). It is the seat of a State normal school with a library of 5700 volumes. The surrounding country is largely agricultural, but possesses important lead-mining interests. In the city are manufactories of wagons, creamery products, beer, cigars, etc. The water-works are owned by the municipality. Platteville was settled in 1827. Population, in 1890, 2740; in 1900, 3340.

PLATTSBURG. A village and the county-seat of Clinton County, N. Y., 167 miles north by east of Albany; on Lake Champlain, at the mouth of the Saranac River, and on the Delaware and Hudson and the Chateaugay railroads (Map: New York, G 1). It is picturesquely situated on Cumberland Bay, which affords a fine harbor, and is an attractive resort, as well as the centre of a large territory popular in summer. Plattsburg is the seat of a State Normal and Training School, and has a public library and four other libraries. The Plattsburg Barracks (q.v.) are among the largest in the United States. There are also to be mentioned the Federal Government building, the court-house and jail, and homes for aged women and the friendless. The Catholic Summer School of America (q.v.) convenes at Cliff Haven, two miles south of the village. Plattsburg is a port of entry for the Champlain customs district, the trade of which in 1901 comprised exports valued at \$7,714,000 and imports to the amount of \$3,763,000. It controls extensive lumber interests, and among its industrial establishments are lumber mills, wood pulp mills, foundries and machine shops, flouring and woolen mills, a manufactory of sewing machines, etc. The various industries, in the census year of 1900, represented a total capital of \$2,210,000, and had products valued at \$1,455,000. The water-works are owned and operated by the municipality. Population, in 1890, 7010; in 1900, 8434.

Plattsburg was settled in 1784 by a company from Poughkeepsie and Long Island headed by Zephaniah Platt and was incorporated in the fol-

lowing year. Off Valeour Island, near by, on October 11, 1776, occurred the first naval battle ever fought between British and American fleets, Benedict Arnold (q.v.) being in command of the latter and Sir Guy Carleton of the former. Arnold was defeated. During the War of 1812 Plattsburg was the headquarters of the United States forces on the northern frontier, and on September 11, 1814, in Plattsburg Bay Commodore McDonough defeated a British fleet in the famous battle of Lake Champlain (see CHAMPLAIN), while on the land General Macomb repulsed a superior British force. In 1849 and again in 1867 Plattsburg suffered severely from fire, the greater part of the business portion being destroyed each time. Consult Palmer, *History of Plattsburgh* (Plattsburgh, 1877).

PLATTSBURG BARRACKS. A United States military post, established in 1838 and occupying a reservation of 679 acres in extent, on the west side of Lake Champlain, one mile from Plattsburg, N. Y., which is the post-office and telegraph station. The post has quarters for a regiment of infantry. United States troops were first stationed on the ground in 1812.

PLATTSMOUTH. A city and the county-seat of Cass County, Neb., 21 miles south of Omaha; on the Missouri River at the mouth of the Platte, and on the Missouri Pacific and the Chicago, Burlington and Quincy railroads (Map: Nebraska, J 2). It has a public library; and among its finest buildings are the court-house, opera house, and the high school. The industrial establishments include the Burlington Railroad shops, brick and terra-cotta works, and cigar factories. There is considerable trade with the tributary region, which is interested mainly in agriculture and stock-raising. Platts-mouth is governed by a mayor, elected biennially, and a unicameral council. Population, in 1890, 8392; in 1900, 4964.

PLATYCERAS, plá-tis'ér-as (Neo-Lat., from Gk. πλατύς, *platys*, flat, broad + κέρα, *keras*, horn). A genus of fossil snail shells of the gastropod family Capulidæ, found in rocks of Upper Cambrian to Triassic age. They are shaped somewhat like a liberty cap with the apex of the shell enrolled in a close spiral of small size and with the outer or body whorl of the shell rapidly enlarging to an irregularly expanded aperture. *Platyceras* is most abundant in the Niagara, the Devonian, and the Subcarboniferous formations, and the genus is more or less an index fossil of Devonian age. The genus *Orthonychia* includes straight or slightly rounded platycerid shells of Silurian to Carboniferous age. Consult: Keyes, "The *Platyceras* Group of Paleozoic Gastropods," in *American Geologist*, vol. x. (Minneapolis, 1892); "Attachment of *Platyceras* to Palæocerinoidea, and Its Effect in Modifying the Form of the Shell," in *Proceedings of the American Philosophical Society*, vol. xxv. (Philadelphia, 1888).

PLATYHELMINTHES (Neo-Lat. nom. pl., from Gk. πλατύς, *platys*, flat, broad + ἕλμινς, *helmins*, worm), or **PLATODA**. A phylum of invertebrate animals (flatworms), easily recognized by the absence of a body-cavity and anus. There is no blood system, the results of digestion being carried to the different parts of the body by branches of the intestine. The body is flattened dorso-ventrally, so that it is often thin and leaf-like. The surface is covered with cilia in most

of the free-living forms, but in parasitic forms is usually smooth and somewhat chitinous. The muscular system is well developed and remarkably complex, so that almost any sort of movements are possible to these worms. The digestive system is usually very well developed and highly varied, but in some forms is wholly wanting. The nervous system consists of a ganglion above the œsophagus, and two lateral nerve cords, connected by transverse commissures. Other longitudinal trunks are sometimes present, and rarely the transverse commissures are wanting. A very characteristic and remarkable set of fine tubes ramifies through the body and apparently serves as an excretory system. Sense organs of various kinds occur in the free-living forms, but are usually wanting in those which are parasitic. Occupying a large part of the body, and often nearly the whole space inside the skin, are the reproductive organs, and the fertilization of the egg is in almost all cases internal. The *Turbellaria* are hermaphroditic. The eggs are very numerous, provided with considerable yolk and covered by a shell, but some planarians multiply by fission, and when cut in pieces each piece may eventually become a well-formed planarian. The young undergo a metamorphosis and development sometimes very complex. The phylum is usually divided into three classes: (1) *Turbellaria*, free-living flatworms, with the surface ciliated; (2) *Trematoda*, parasitic, usually leaf-like, flatworms having a well-developed digestive system; (3) *Cestoda*, the tapeworms, usually elongated, jointed, and without a digestive system. Consult Parker and Haswell, *Text-book of Zoölogy* (New York, 1897). See **FLATWORM**; **CESTODA**; **TREMATODA**.

PLATYRHINI. The American monkeys. See **MONKEY**.

PLATYSTROPHIA (Neo-Lat. nom. pl., from Gk. πλατύς, *platys*, broad, flat + στρόφιον, *strophion*, band). A hinged brachiopod very abundant and eminently characteristic of the Middle Ordovician formations, of which it is a well-known index fossil. Its shell is transversely elongated, with a long straight hinge line and low hinge areas. The convex valves are of about equal size, and their surfaces are marked by a number of strong angular radiating folds. Two species, *Platystrophia lynx* and *bifurcata*, with numerous varieties, are common in the Trenton and Cincinnati groups of North America, and in equivalent strata of Europe and elsewhere. This genus was originally included under *Orthis*.

PLAUVEN, plou'én. A town of Saxony, Germany, on the White Elster, 21 miles southwest of Zwickau (Map: Germany, E 3). Most of its public buildings are modern. Among the most noteworthy are the castle, dating from the seventeenth century, the Rathaus, and the theatre. The educational institutions include a gymnasium, a realschule, a seminary for teachers, and a number of special schools. Plauen occupies a prominent place among the manufacturing cities of Germany, being the chief centre for the production of white cotton goods, namely lace curtains, muslin, cambric, mull, batiste, various embroidered goods, etc. It also manufactures machinery, safes, pianos, paper, beer, etc. The population of the town increased from 47,007 in 1890 to 73,891 in 1900. The inhabitants are principally Protestants. The manufacturing of white goods was

introduced at the end of the sixteenth century from Switzerland.

PLAUTIA, plā'shī-ā (or **PLOTIA**) **GENS**. A Roman plebeian tribe, several members of which became consuls. It embraced the family names Hypsæus, Proculus, Silvanus, Venno, and Venox.

PLAUVTUS, **TITUS MACCIUS**. The greatest comic poet of ancient Rome. He was born c.254 B.C. at Sarsina, a village of Umbria. It is probable that he came to Rome while still a youth, and there acquired a complete mastery of the Latin language in its most idiomatic form, as well as an extensive familiarity with Greek literature. It is uncertain whether he ever obtained the Roman franchise. His first employment was with the actors, in whose service he saved an amount of money sufficient to enable him to leave Rome and commence business on his own account. What the nature of this business was, or where he carried it on, we are not informed; we know, however, that he failed in it, and returned to Rome, where he had to earn his livelihood in the service of a baker, with whom he was engaged in turning a hand-mill. At this time—a few years before the outbreak of the second Punic War—he was probably about 30 years of age; and while employed in his humble occupation, he composed three plays, which he sold to the managers of the public games. The proceeds enabled him to leave the mill and turn his hand to more congenial work. The commencement of his literary career may, therefore, be fixed c. 224 B.C., from which date he continued to produce comedies with wonderful fertility, till 184, when he died in his seventieth year.

Of his numerous plays—130 bore his name in the last century of the Republic—only 20 have come down to us. Many of them, however, were regarded as spurious by the Roman critics, among whom Varro (in his treatise *Quæstiones Plautinæ*, cited by Gellius) limits the genuine comedies of the poet to twenty-one. With the exception of the twenty-first, these Varronian comedies are the same as those we now possess. Their titles, arranged (with the exception of the *Bacchides*) in alphabetical order, are as follows: (1) *Amphitryo*, (2) *Asinaria*, (3) *Aulularia*, (4) *Captivi*, (5) *Curculio*, (6) *Casina*, (7) *Cistellaria*, (8) *Epidicus*, (9) *Bacchides*, (10) *Mostellaria*, (11) *Menæchmi*, (12) *Miles*, (13) *Mercator*, (14) *Pseudolus*, (15) *Pænulus*, (16) *Persa*, (17) *Rudens*, (18) *Stichus*, (19) *Trinummus*, (20) *Truculentus*, (21) *Vidularia*. As a comic writer, Plautus enjoyed immense popularity among the Romans and held possession of the stage down to the time of Diocletian. The vivacity, the humor, and the rapid action of his plays, as well as his skill in constructing plots, commanded the admiration of the educated no less than of the unlettered Romans; while the fact that he was a national poet prepossessed his audiences in his favor. Although he laid the Greek comic drama under heavy contributions, and 'adapted' the plots of Menander, Diphilus, and Philemon with all the license of a modern playwright, he always preserved the style and character native to the Romans and reproduced the life and intellectual tone of the people in a way that at once conciliated their sympathies. The admiration in which he was held by his contemporaries descended to Cicero and Saint Jerome; while he has

found imitators in Shakespeare, Molière, Dryden, Addison, and Lessing, and translators in most European countries. The best complete translation of his works into English is that by Thornton and Warner (5 vols., 1767-74); there is another by Riley (London, 1880), and a partial translation in the original meter, by Sugden (London, 1893). Unfortunately the text of the extant plays is in such a very corrupt state, so defective from lacune, and so filled with interpolations, that much yet remains to be done by the grammarian and the commentator before they can be read with full appreciation or comfort. Ritsehl and his disciples gave the text its first exhaustive recension, on which are based the modern editions, such as those of Ussing (5 vols., Copenhagen, 1875-86) and Goetz and Schoell (3 vols., Leipzig, 1893-96). Among the many good editions of separate plays, with commentary, may be mentioned those of Brix, Lorenz, Morris, Palmer, and Tyrrell. Consult Sellar, *Roman Poets of the Republic* (Oxford, 1881).

PLAYA, plā'yā (Sp., shore). The name given to mud-plains formed by the deposition of silt in temporary lakes. In arid regions, such as the Great Basin, water collects in the valleys during the dry season forming shallow lakes, which shrink or entirely disappear with the recurrence of dry weather. The sediment left by evaporation consists of finely divided rock-débris impregnated with salt and becomes very hard under the sun's heat. The Black Rock Desert, in northwestern Utah, is an example of a playa.

PLAYERS' CLUB, **THE**. A social club in New York City composed of men identified with American art, literature, painting, sculpture, architecture, the drama, etc., as well as prominent bankers and lawyers. Its creation was due in a great measure to the liberality of the tragedian Edwin Booth (q.v.), to whom the club is indebted for its handsome club house at 16 Gramercy Park, New York City. It was purchased by Mr. Booth for \$75,000, and entirely remodeled. The work was completed in 1888, and on December 31st of that year it was formally presented, furnished and equipped for all the needs of club life. The club had been organized after the purchase of the building. Its affairs are managed by a board of nine directors, who must be identified with literature and the drama, and at least five of the body must be actors, dramatic writers, or theatrical managers.

PLAYFAIR, **JOHN** (1748-1819). An English mathematician and geologist, born at Benvie. He was taught by his father until he was 14 years of age, when he was sent to Saint Andrews, where he made rapid progress, especially in mathematics and natural philosophy, graduating in 1765. He entered the ministry in 1770, but still devoted his leisure time to mathematical studies, and in 1779 he contributed to the *Transactions of the Royal Society* a paper "On the Arithmetic of Impossible Quantities." In 1785 he became professor of mathematics, jointly with Dr. Adam Ferguson, in the University of Edinburgh. He became secretary of the physical class in the Edinburgh Royal Society in 1789, and later general secretary, which post he held till his death. In 1805 he exchanged the chair of mathematics for that of natural philosophy. In 1807 he became a fellow of the Royal Society. A few years before his death he traveled through France,

Switzerland, and Italy, for the purpose of studying the geological and mineralogical features of these countries. From 1804 onward he was a frequent contributor to the *Edinburgh Review*. Among the subjects reviewed are "Mudge's Trigonometrical Survey" (1805); "Mechain and Delambre, Base du système métrique décimale" (1808); "Le Compte rendu par l'Institut de France" (1809); "Lambton's Indian Survey" (1813); "Laplace, Essai philosophique sur les probabilités" (1814); "Baron de Zach, Attraction des montagnes" (1816); "Kater on the Pendulum" (1818). All of these were reprinted in the fourth volume of the collected edition of his works, edited by James G. Playfair (4 vols., 1822). He also contributed several articles to the *Encyclopædia Britannica*. For the *Transactions* of the Royal Society of Edinburgh he wrote among other memoirs: "On the Origin and Investigations of Porisms" (1794); "On the Trigonometry of the Brahmans" (1798). He also edited Euclid's *Elements* (1795), and wrote *Outlines of Natural Philosophy* (2 vols., 1812-16), and *Illustrations of the Huttonian Theory of the Earth*.

PLAYFAIR, LYON, first Baron PLAYFAIR (1818-98). A British scientist and statesman, born at Chunar, in Bengal. He was educated at Saint Andrews and at Glasgow, where he took a course in chemistry. After studying under the celebrated German chemist Liebig, he was in 1843 appointed honorary professor of chemistry at the Manchester Royal Institution. In 1858 he was appointed to the chair of chemistry in Edinburgh University. In 1868 he was returned to Parliament as a Liberal from the Scotch universities, and in 1873 he was appointed postmaster-general and became a privy councillor. In 1892 he was raised to the peerage as Baron Playfair of Saint Andrews, and was appointed a lord in waiting. He wrote *Science in Its Relation to Labor* (1853); *On Primary and Technical Education* (1870); and *Science in Relation to the Public Weal* (1885).

PLAYGROUND, PUBLIC. See PARKS AND PLAYGROUNDS.

PLAYING CARDS. See CARDS.

PLAYS. See DRAMA.

PLEA (OF. *plait, plaid, play*, Fr. *plaid*, from Lat. *placitum*, decree, suit, plea, opinion, from *placere*, to please). In common-law pleading, the defendant's answer or defense, consisting either of a denial of the facts alleged in the declaration, or a confession that they are true and a statement of new facts by which their legal effect is avoided, or of facts tending to defeat the action itself. A *plea* is distinguished from a *demurrer* in that the latter admits the facts alleged in the declaration, but denies their sufficiency in law to constitute a cause of action; whereas a *plea* raises only a question of fact in the manner indicated in the above definition.

Pleas are usually classed as 'peremptory' and 'dilatory,' according to their purposes and nature. A peremptory plea is one which brings in issue the merits of the controversy, either by denying absolutely the facts alleged in the declaration, when it is known as a 'plea in bar,' or by confessing that the facts alleged by the plaintiff are true, and setting forth new facts, which, if true, will defeat the alleged cause of action. The latter

is known as a plea in confession and avoidance. A dilatory plea is one which attacks the action itself because of some defect in pleading or practice, and therefore does not involve the merits. See NONSUIT.

In criminal cases only pleas of 'guilty' or 'not guilty' are allowed. In equity pleading a special answer of the defendant attacking the particular action is also called a plea. It differs from a demurrer in equity in that it attacks something not apparent on the face of the bill, and it does not put in issue the merits of the action.

In England, where common-law pleading has been abolished, the Judicature Acts (q.v.) provide that the defendant's answer shall be known as the 'statement of defense,' and this is analogous to a plea. The term 'Pleas of the Crown' was formerly used to designate criminal prosecutions in the name of the sovereign. In the United States wherever code pleading prevails the term plea is no longer employed, a defense of fact being presented by an answer. However, the divisions of pleas are often referred to by courts and attorneys as descriptive of the nature of a defense set forth by an answer. See PLEADING.

PLEADING (from *plead*, from OF., Fr. *plaid-er*, from OF. *plait, plaid, play*, Fr. *plaid, plea*). As a generic term, the written allegation of facts upon which a party to any legal proceeding founds his claim or demand or his answer or defense thereto. Used in a broader sense, the term signifies the system of legal rules and principles applicable to the written pleadings in a legal proceeding.

Pleading is only one of the successive steps in a proceeding at law by which one party asserts or enforces his rights against another, all together being comprehended by the term procedure (q.v.). Originally the pleadings in an action at common law were oral, as is evidenced by many peculiarities of the common-law procedure of a later date; but as early as the reign of Edward III. we find that the pleadings were in writing and usually in Latin.

Pleading at law, however, ultimately developed into a system of highly technical and formal rules requiring the greatest precision in their application, and often by their very formality and rigidity defeating rather than aiding justice. Although remedial statutes were passed as early as the reign of Elizabeth, no attempt at a general reformation of the system was made until 4 William IV., c. 42, in 1834. At a later date in the United States various forms of statutory or code pleadings were adopted.

The principles upon which any system of pleading are necessarily based will, perhaps, be best understood by referring briefly to the more essential elements of the common-law system. The primary object of the pleadings in an action at common law was to raise a single issue or dispute upon either a point of law or of fact. In the former case a question was raised for decision by the court, usually after argument upon the question of law involved and submission of briefs by opposing counsel. In the latter, a question was raised for decision by the jury after hearing evidence tending on the one side to prove and on the other to disprove the fact in dispute. And upon the decision of the court or a verdict of the jury final judgment was entered determining the rights of the parties to the controversy.

The first step toward accomplishing the object

of pleading after service of summons or mandate of the court upon the defendant was the filing of the declaration (known in modern practice as the complaint) in court. In the declaration the facts were required to be stated according to their legal effect only, and it was not permissible to set out the evidence on which the plaintiff relied. Owing to the tendency of the early lawyers to adopt fixed forms of statement and to their adherence to precedent, the declaration was required to conform to one of a limited number of rigid forms, and if a plaintiff could not adapt the state of facts upon which he based his right to recover to one of these forms, he was without remedy. See FORMS OF ACTION.

After the plaintiff had filed his declaration it was then incumbent upon the defendant to make some statement of his defense; otherwise, after a certain period, judgment would be taken against him by default. If the defendant conceived that the declaration, if taken as true, did not show sufficient grounds to justify the plaintiff's recovery (or, as it was said, did not state a cause of action), he could submit the question of its sufficiency to the court as a matter of law by filing a demurrer to the declaration. (See DEMURRER.) If, however, the defendant wished to deny any of the allegations contained in the declaration, he might do so by filing a formal denial, his pleading in that case being known as a plea by way of traverse. An issue of fact was thus raised for decision by the jury.

It might happen, however, that the defendant, while admitting the truth of all the allegations in the declaration, and admitting that it was legally sufficient, relied upon the existence of new or other facts sufficient to excuse him from the liability charged in the declaration, in which case his plea took the form of a confession and avoidance (q.v.). The plaintiff might then plead, setting up either a demurrer to the plea or a denial with the effect already described; or he in turn might plead by way of confession and avoidance and thus cast upon the defendant the burden of pleading again. In every case the pleadings were thus continued until a single issue of law or fact was raised, and the determination of that issue determined the rights of the parties to the litigation. Any plea of a defendant, such as has been described, setting up some matter of defense to the plaintiff's claim was known as a plea in bar or as a plea to the merits. It might happen, however, that the defendant wished to insist upon some matter which, though not a complete defense to the plaintiff's claim, was sufficient to show that the action was brought in an improper manner, as that the plaintiff was a married woman and had not joined her husband as plaintiff, or that the court had no jurisdiction, or that the defendant was not properly named. Such a plea was known as a plea in abeyance. The effect of a plea in abeyance, if successful, was to cause a dismissal of the plaintiff's action without prejudice to a second action if properly brought. If unsuccessful the defendant was allowed to plead again to the merits.

The successive pleadings in an action, beginning with the plaintiff's pleading, were named the declaration, plea, replication, rejoinder, sur-rejoinder, rebutter, and sur-rebutter. Although theoretically possible, it was not usual for the proceedings to continue beyond the rebutter or sur-rebutter.

Upon the trial of an issue of fact, as the character of the issue was determined by the pleadings, it necessarily followed that the relevancy of all evidence offered at the trial was also primarily determined by the pleadings. Upon the entry of judgment all the pleadings in the case, together with the judgment constituting the judgment roll, were filed with the clerk of the court, thus constituting a complete permanent record of the case.

Owing to the highly technical and formal nature of the common-law system, the practice grew up of deciding the rights of litigants upon purely formal grounds, and judgment was frequently taken against a party upon demurrer because he had failed to state a perfectly valid claim or defense in the proper form. This was corrected to some extent by the statute of 27 Eliz., c. 5, sec. 1, which provided that no advantage should be taken of defects of form, except by a special demurrer which should state specifically the formal defect objected to. The statute 4 Anne, c. 16, sec. 1, was enacted for more effectively accomplishing this result, and 15 and 16 Vict., c. 76, sec. 50-52, abolished the special demurrer and required all defects of form to be taken advantage of by motion before trial. This is generally the modern practice. The statute of Anne referred to allowed the defendant to plead several pleas to the same declaration, thus breaking down to some extent the principle of singleness of issue. Through laxity of practice also the defendant was allowed in his plea to make use of a general denial, known as the general issue, the effect of which in most actions was ultimately not only to deny all the essential allegations of the declaration, but to allow the defendant at the trial to prove many matters of affirmative defense. An attempt was made by statute, 4 Wm. IV., c. 42, to avoid the confusion and the frequently illogical results of this complicated system by authorizing the judges of the common-law courts to adopt certain rules modifying the common law of pleading as it then existed. These rules, known as the Hilary rules, were promulgated in 1834 and had for their principal object the narrowing of the general issue so as to make it conform more closely to a logical denial of the allegations in the complaint. These rules, however, did not succeed in accomplishing the desired result, and seem only to have added to the confusion into which the subject had fallen. The law was substantially revised by 15 and 16 Vict., c. 76, and modern legislation has been enacted in all of the United States in which the common-law system has been retained.

Following are the more essential changes:

Matters of form are required to be taken advantage of by motion before trial, otherwise they are deemed to have been waived. Singleness of issue is not required, the defendant being allowed to use the general denial and to plead several matters by way of confession and avoidance. In many jurisdictions the number of successive pleadings is limited. Decisions upon demurrers are not necessarily final, the defendant being usually allowed to plead to the merits in case his demurrer is overruled.

Great freedom of amendment is allowed, a party being allowed to correct a defective pleading by amendment on application to the court,

even at the trial of the action, if the rights of his opponent will not be prejudiced by the amendment. There are also many minor changes, the general object being to make the system more simple and just in its application, and to avoid the determination of rights upon purely formal grounds.

PLEADING AT CRIMINAL LAW. At common law pleading in criminal actions was in its essentials substantially like pleading in civil actions, although much less elaborate.

The first pleading was called the indictment (q.v.). To this the accused might interpose a demurrer, as in civil actions, and with like effect, except that if the demurrer were overruled he was allowed to plead to the indictment. All matters tending to show that the accused was not guilty of the offense charged might be shown under the oral plea *not guilty* or the plea *nolo contendere*, which was equivalent to guilty, except that it was not an admission by the defendant which could be used against him in evidence in a civil suit for the same act. After the plea no further pleading was necessary. The plea of abatement or previous conviction or acquittal of the same offense were required to be specifically pleaded as a plea by way of confession and avoidance; and to these the prosecution might demur with the same effect as a demurrer to a plea in abatement in a civil action.

Pleading at criminal law has been subjected to fewer statutory changes than pleading in civil actions. In some States less formality is required than at common law, and final judgment cannot be entered upon purely formal grounds. Formal defects may be cured by amendment, but there can be no amendment to matter of substance in an indictment, otherwise an amended indictment would not satisfy the requirement that the indictment must be found by the grand jury.

EQUITY PLEADING. The system of pleading adopted in equity by the English Court of Chancery was derived partly from the common-law system and partly from the civil-law system as administered by the English ecclesiastical courts.

The important features of the civil-law system which characterize equity pleading were: (a) the absence of the denial or traverse, the rule being that all the allegations in a pleading were deemed to be denied unless expressly admitted by a subsequent pleading, which was exactly the converse of the common-law rule by which all the allegations in a pleading were deemed to be admitted unless expressly denied; and (b) the practice by which a party to the litigation could compel his opponent to testify, or give discovery, as it was called, in advance of argument or trial as to the matters alleged in the first party's pleading.

The plaintiff's pleading in an equity action is called the bill. In effect it is a petition addressed to the court asking that subpoena issue compelling the defendant to answer the bill. Formerly bills in equity were prepared with great formality and were usually composed of nine distinct parts. Of these, however, only four are important in modern practice, and two of these may be dispensed with. The essential parts are the statement of facts and the prayer for relief.

For the purpose of obtaining discovery the plaintiff might state in his bill at great length

the evidence upon which he relied in support of his claim. This was known as the charging part of the bill. He might also ask specific questions founded upon the stating and charging parts of the bill, which he required the defendant to answer. This was known as the interrogatory part of the bill. After the appearance of the defendant, failing which a decree would be taken against him by default, he was required to answer the bill. The answer, which was required to be under oath, might set out at length any matters of defense, however numerous, relied upon by the defendant, but he was required to make discovery or give testimony by answering fully and specifically the charging and interrogatory parts of the bill.

In early times other pleadings might follow the answer as at common law, but ultimately the answer came to be the last substantial pleading, and was followed only by a formal plea always of the same tenor and used only to indicate that the parties were at issue.

In case it became necessary for the plaintiff to meet any of the allegations in the answer, this was accomplished by amendment. Upon the testimony taken before a master in chancery, and upon the answer, which was deemed to be not only a pleading, but in effect evidence introduced by the plaintiff, the decision and final decree of the Court of Chancery were based.

Equity pleading borrowed from the common law the use of the demurrer and the plea, with practically the same effect.

In the courts of equity of the United States, which, in accordance with the Constitution and statutes of the United States, are distinct from the courts of common law, the same system of pleading is used as in the English Court of Chancery as it has here been outlined. The pleading in the United States courts is, however, subject to modification by rules of court. The same system of equity pleading also obtains in those States in which the distinction between courts of equity and of law has been maintained, notably New Jersey.

CODE PLEADING. The supposed difficulty in satisfactorily modifying or reforming the common-law system by mere statutory revision or amendment led in many of the United States to legislation abolishing the common-law system of pleading and creating or attempting to create a purely statutory form of pleading to be used in both law and equity actions. This step was first taken by the Legislature of New York, which adopted in 1848 the New York Code of Civil Procedure, which has served as a model for similar legislation in most of the other States adopting code procedure. A substantially statutory form of pleading and practice was also adopted in England by the Judicature Acts of 1873 and 1875. Under the codes discovery in equity actions is abolished. The pleader is allowed to plead the facts upon which he relies without formality. The pleadings are limited to two unless the defendant pleads a counterclaim, i.e. an independent action against the plaintiff, in which case the plaintiff may reply to it. The plaintiff's pleading is called a complaint, or in some States a petition, and in England a statement of claim. The defendant's pleading is called an answer, or in England a statement of defense. The defendant may demur to the plaintiff's complaint or to his reply to

defendant's counterclaim, and the plaintiff may demur to defendant's answer or counterclaim, and if the demurrer is overruled, the litigant is generally allowed to plead to the merits. Formal defects can only be taken advantage of by motion before trial, and great freedom of amendment is allowed. Despite its apparent simplicity, the code system has given rise to many difficulties not unlike those existing under the common-law system, and the question of further reform is still being agitated.

Consult: Gould, *Treatise on the Principles of Pleading in Civil Actions* (6th ed., Albany, 1898); Perry, *Common Law Pleading, Its History and Principles* (Boston, 1897); Story, *Commentaries on Equity Pleadings* (10th ed., Boston, 1892); Phillips, *Principles of Pleadings in Action Under the Codes of Civil Procedure* (1897); Beale, *The Law of Criminal Pleading* (Boston, 1899). Consult, also, the authorities referred to under CIVIL LAW; EQUITY; LAW, CRIMINAL; CODE; etc.

PLEASANTON, plēz'ən-ton, ALFRED (1824-97). An American soldier, born in Washington, D. C. He graduated at West Point in 1844, and was assigned to the dragoons, with whom he served on the frontier and in Mexico. In 1855 he was promoted to a captaincy, and in February, 1862, was promoted to be major in the Second Cavalry, and participated in the Peninsular campaign, his command covering the retreat of the Federal army to Yorktown (August 18-19, 1862). He was commissioned brigadier-general of volunteers in July, 1862, and during the succeeding Maryland campaign he commanded the advance cavalry division. In the battles of South Mountain and Antietam his troops took conspicuous part. He participated in the battle of Fredericksburg, and at Chancellorsville especially distinguished himself by checking the flank attack of the Confederates on the Federal right. On June 7, 1863, he was given command of the cavalry corps of the Army of the Potomac, which he led in the Pennsylvania campaign that terminated at Gettysburg (July 1-3, 1863), where, on July 2d, he was brevetted colonel in the Regular Army for gallant and meritorious services. The next year he was transferred to the West, where he defeated General Price at Maraisdes-Cygnès (October 25, 1864), and drove the Confederates out of Missouri. He was brevetted major-general in the Regular Army in 1865, and on January 15, 1866, was mustered out of the volunteer service with rank of major-general. Two years later he resigned from the army, and after holding the positions of collector of internal revenue and commissioner, became, in 1871, president of the Terre Haute and Cincinnati Railroad.

PLEASURES OF HOPE. A poem by Thomas Campbell (1799), discussing the burning questions of the time, the French Revolution, the partition of Poland, and negro slavery. Though very successful in its day, it is tedious and rhetorical.

PLEASURES OF MEMORY. A didactic poem by Samuel Rogers (1792), the only want of which, Hazlitt remarked, is that of taste and genius.

PLEASURES OF THE IMAGINATION. A poem by Mark Akenside (1744), a didactic analysis of the pleasure excited by what is great, wonderful, and beautiful.

PLEBEIANS (OF. *plebeien*, Fr. *plébéien*, from Lat. *plebeius*, relating to the common people, from *plebs*, common people; connected with *plenus*, full, Gk. *πληθῆναι*, *plimlénai*, Skt. *pur*, *prá*, to fill, OChurch Slav. *plünü*, Lith. *pilnas*, OIr. *lán*, Goth. *fulls*, OHG. *fol*, Ger. *voll*, AS., Eng. *full*). The common people of Rome; one of the two elements of which the Roman nation consisted. Their origin, as a separate class, is to be traced partly to natural and partly to artificial causes. The foundation of Rome, probably as a frontier emporium of Latin traffic (according to Mommsen's suggestion), would bring about the place a number of inferior employees, clients, or hangers-on, of the enterprising commercial agriculturists who laid the primitive basis of the material and moral prosperity of the city. These hangers-on were the original plebeians or non-burgesses of Rome, whose numbers were constantly increased by the subjugation of the surrounding cities and States. Thus, tradition states that, on the capture of Alba, while the most distinguished citizens of that town were received among the Roman patricians, the greater part of the inhabitants, likewise transferred to Rome, were kept in submission to the *populus* or patricians of Rome—in other words, swelled the ranks of the plebeians. Similar transfers of some of the inhabitants of conquered towns are assigned to the reign of Ancus Martius. The order of plebeians thus gradually formed soon exceeded the patricians in numbers, partly inhabiting Rome, and partly the adjoining country. Though citizens, they were neither comprehended in the three tribes, nor in the *curiæ*, nor in the patrician *gentes*, and were therefore excluded from the *comitia*, the senate, and all the civil and priestly offices of the State. They could not intermarry with the patricians.

The first step (according to traditionary belief) toward breaking down the barrier between the two classes was the admission, under Tarquinius Priscus, of some of the more considerable plebeian families into the three tribes. Servius Tullius divided the part of the city and the adjacent country which was inhabited by plebeians into regions or local tribes, assigning land to those plebeians who were yet without it. The plebeian tribes, with tribunes at their head, formed an organization similar to that of the patricians. The same king further extended the rights of the plebeians by dividing the whole body of citizens, patrician and plebeian, into five classes, according to their wealth, and forming a great national assembly called the *comitia centuriata*, in which the plebeians met the patricians on a footing of equality; but the patricians continued to be alone eligible to the senate, the highest magistracy, and the priestly offices. These newly acquired privileges were lost in the reign of Tarquinius Superbus, but restored on the establishment of the Republic. Soon afterwards the vacancies which had occurred in the senate during the reign of the last King were filled up by the most distinguished of the plebeian equites, and the plebeians acquired a variety of new privileges by the laws of Valerius Publicola. The encroachments on those privileges on the part of the patricians began the long-continued struggle between the two orders, which eventually led to the plebeians gaining access to all the civil and religious offices, acquiring for their decrees (*plebiscita*) the force of law. Under the Hor-

PLECTOGNATH FISHES

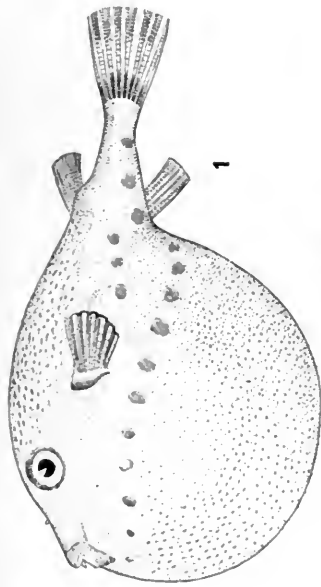

1

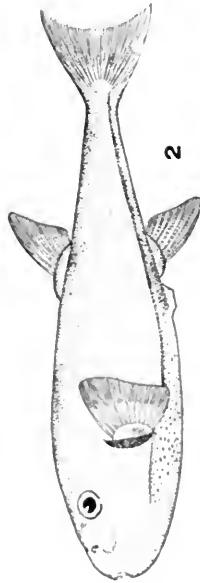

2

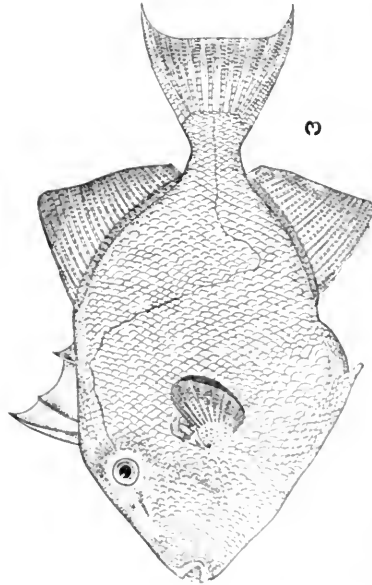

3

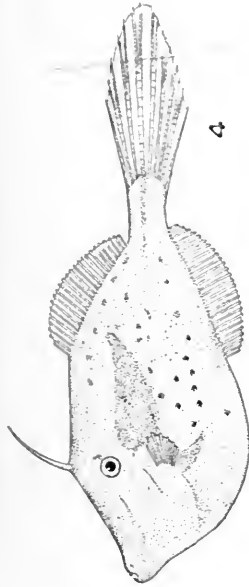

4

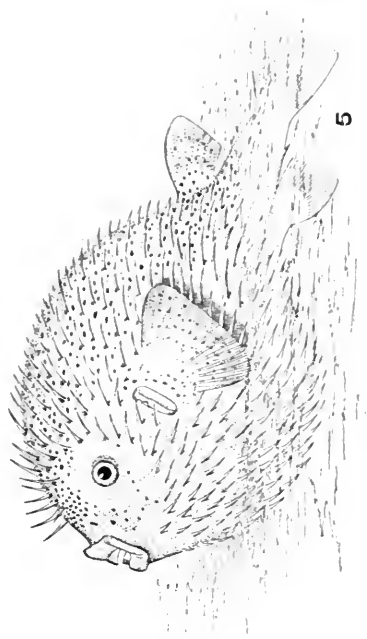

5

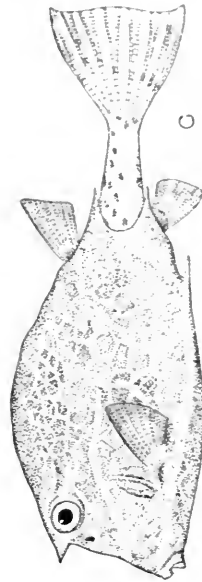

6

1. A WEST INDIA GLOBEFISH (*Spheroides Spengleri*) puffed out.
 2. SMOOTH PUFFER (*Lagocephalus laevigatus*).
 3. TRIGGER-FISH (*Ballistes Carolinensis*).

4. FILEFISH (*Alutera scripta*).
 5. PORCUPINE-FISH (*Diodon hystrix*) puffed out.
 6. TRUNKFISH (*Lactophrys tricomis*).



tensian law (B.C. 286) the two hostile classes were at last amalgamated in one general body of Roman citizens with equal rights. Henceforth the term *populus* is sometimes applied to the plebeians alone, sometimes to the whole body of citizens assembled in the *comitia centuriata* or *tributa*, and *plebs* is occasionally used in a loose way for the multitude or populace, in opposition to the senatorial party. See PATRICIAN; ROME, HISTORY.

PLEBISCITE (Fr. *plébiscite*, from Lat. *plebiscitum*, decree of the people, from *plebis*, gen. sg. of *plebs*, people + *scitum*, decree, from *scire*, to know). The name given, in the political vocabulary of modern France, to a decree of the nation obtained by an appeal to universal suffrage. Thus, Louis Napoleon, for example, was made Emperor by a *plébiscite*. The word is borrowed from the Latin. (See PLEBEIANS.) The same institution has recently been making its way to the United States. (See REFERENDUM.) In almost every State the validity of certain measures is made dependent upon the approval of the electorate.

PLECOPTERA (Neo-Lat. nom. pl., from Gk. *πλέκω*, *plekein*, to twist + *πτερόν*, *pteron*, wing). An order of insects comprising the stone-flies. See STONE-FLY.

PLECTAMBONITES (from Gk. *πλεκτός*, *plektos*, twisted + *ἀμβών*, *ambōn*, ridge). A genus of brachiopods with shells of semicircular outline, dorsal valve concave and ventral valve convex, with long, low hinge areas, and with the shell surface marked by fine regular radiating ribs. Two species are common and well-known index fossils. *Plectambonites sericeus*, the earlier characteristic Ordovician species, has a wider, less convex form, with the ribs all of about the same size; while *Plectambonites transversalis* of the Silurian has a rounder, more convex form with several delicate ribs inserted between larger ribs. Both these species are found occupying their relative positions in the Ordovician and Silurian rocks of North America, Europe, and Asia.

PLECTOGNATHI (Neo-Lat. nom. pl., from Gk. *πλεκτός*, *plektos*, twisted + *γνάθος*, *gnathos*, jaw). A group of bony fishes, having the skeleton less perfectly ossified than in osseous fishes generally. It contains many highly aberrant forms, such as the globe-fishes. The maxillary bones are coëssified with the premaxillaries. The skin is usually tough or well armed with bony plates or spines. The fins are small, the spinous dorsal fin sometimes and the ventral fins always wanting. These fishes are for the most part passive creatures and depend upon their armature for protection. The order contains three suborders, namely, Sclerodermi, Ostracodermi, and Gymnodontes, and includes such forms as the trigger-fishes, trunk-fishes, puffers, etc. See Plate of PLECTOGNATHI FISHES.

PLECTOSPONDYLI (Neo-Lat. nom. pl., from Gk. *πλεκτός*, *plektos*, twisted + *σπόνδυλος*, *spondylos*, *σφόνδυλος*, *sphondylos*, backbone). A group of teleost fishes, which consists entirely of fresh-water forms, and includes about eight families, to which belong the majority of all the fresh-water fishes of the world. The essential character of the order, as defined by Jordan (*Fishes of North America*, Washington, 1896),

lies in the modification of the anterior vertebræ, as in the Nematognathi, but the opercular bones are all present and the skin bears scales. It contains the three well-marked suborders, Evertognathi (the carps, minnows, suckers, etc.), Heterognathi (the tropical characnids, etc.), Gymnototi (Gymnototidæ, etc.). Compare OSTARIOPHYSI.

PLECTRUM (Lat., from Gk. *πλήκτρον*, *pléktron*, instrument for striking, from *πλήσσειν*, *plēssein*, to strike). A small instrument made of ivory, tortoise-shell, metal, or wood, used for plucking the strings of certain musical instruments, like the zither and mandolin. In olden times it was simply held between the fingers, but now it is generally provided with a ring to slip over the thumb.

PLEDGE (OF. *plege*, Fr. *pleige*, OIt. *pieggio*, pledge; of uncertain etymology, perhaps ultimately from Lat. *præbere*, *præhibere*, to offer, from *præ*, before + *habere*, to have). Personal property delivered by one person to another to be held by him as security for the performance of an obligation, usually the payment of a debt. The term also denotes the legal transaction involved in making a pledge. The common-law pledge corresponds to the *pignus*, or pawn, under the civil law, although it cannot certainly be said that the common-law pledge was adopted from the civil law.

A pledge is distinguishable from a mortgage in that the relation of the pledgor and pledgee is that of bailor and bailee, the legal interest of the bailee being his right to possession of the pledge with power to sell it upon non-payment of the debt.

Any personal property actually in existence and capable of delivery into the possession of the pledgee may be pledged. Future property (that is, property not yet in existence, as a ship yet to be built or cloth yet to be made) cannot be pledged. An agreement, however, for the pledging of future property creates a valid equitable lien which a court of equity will enforce whenever the property comes into existence. The so-called inchoate or potential property which the common law regarded as present legal property, although in fact not in existence, as crops planted but not grown, or the wool to be grown upon sheep actually in existence, might also be pledged, while the mortgagee at common law acquired title to the mortgaged property.

The pledgee has a right to retain possession of the pledge only until the debt is paid or obligation performed. He is bound to exercise due or reasonable care in preserving and protecting the property pledged. Whenever the debt or obligation is due, he is entitled to sell the pledge and apply the proceeds to the payment of the debt, turning over the surplus, if any, to the pledgor. Before selling the property he is required to give fair and reasonable notice to the pledgor, and the sale should be made in such a manner as to secure the best price for the property. The usual method is by public auction at the place where property of the class pledged is usually sold. Notice of the sale and any particular method of sale may be waived by the pledgor. Equity also exercised its jurisdiction to foreclose a pledge by directing a judicial sale of the property pledged, thus giving to the pledgee a remedy in addition to his common-law right of

sale. An unauthorized sale or misappropriation of the pledge by the pledge amounts to a conversion of the property for which the pledgor may bring his action in trover or replevin.

In many States the law of pledge is regulated by statute, and in nearly all the States the power of one in the possession of personal property to pledge it is much affected by the Factor Acts (q.v.).

Consult: Colebrook, *The Law of Collateral Securities* (2d ed., Chicago, 1898); Jones, *The Law of Pledges* (2d ed., Boston, 1901); Tyler, *The Law of Usury, Pawns, or Pledges* (2d ed., Albany, 1882). Compare HYPOTHECATION.

PLÉIADE, plá'yád'. A name assumed by a group of scholarly French poets of the sixteenth century, seven in number, of whom Jean Daurat was master and Ronsard the best poet. The others were Belleau, Baif, Du Bellay, Jodelle, and Pontus de Thiard. Like seven Greek poets in the third century B.C. at Alexandria, they took the name *Pléiade*, from their number, on making their first declaration of principles, *La défense et illustration de la langue française*, by Du Bellay (1549). This aimed at a revival of classical studies, in the spirit of Petrarch, yet national and patriotic rather than erudite. Of the ethical and philosophic phases of the French Renaissance they were quite innocent, but its humanism reaches in them its fullest expression. (See BELLAY; BELLEAU; JODELLE; RONSARD.) Consult Pellissier's chapter on the *Pléiade* in Petit de Julleville's *Histoire de la langue et de la littérature française*, which has a good bibliography (Paris, 1896 et seq.); and essays by Brunetière in the *Revue des Deux Mondes* (ib., 1900 et seq.).

PLEIADES (Lat., from Gk. Πλειάδες, Πληιάδες). In Greek legend, according to the most general account, the seven daughters of Atlas and Pleione, the daughter of Oceanus. Of their story there seems to have been no canonical version, but various local legends were adopted by different writers. According to some they committed suicide from grief, either at the death of their sisters, the Hyades, or at the fate of their father, Atlas (q.v.); according to others, they were companions of Artemis (Diana), and being pursued by Orion (q.v.), were rescued from him by the gods by being translated to the sky. All agree that, after their death or translation, they were transformed into stars. As only six of these stars are easily visible to the naked eye, the story was told that Sterope hid herself from shame that she alone had married a mortal, while her six sisters were the loves of different gods. Others said that Electra, mother of Dardanos by Zeus, had withdrawn in grief at the fall of Troy. Their names are Electra, Maia, Taygete, Aleyone, Celeno, Sterope (the invisible one), and Merope. To the Greeks the constellation was important, since with their heliacal rising in May the navigation began, and with their setting in November it was supposed to close. They also served as guides for seed-time and harvest.

In astronomy the name designates a group of six stars placed on the shoulder of Taurus, the second sign of the Zodiac, and forming, with the polestar and the twin, Castor and Pollux, the three angular points of a figure which is nearly an equilateral triangle. Many believe, from the uniform agreement that the Pleiades were seven in number, that the constellation at an early

period contained seven stars, but that one has since disappeared—not a very uncommon occurrence.

PLEIOCENE EPOCH. See Pliocene Epoch.

PLEIOSAURUS, or **PLIOSAURUS.** See PLEIOSAURUS.

PLEISTOCENE PERIOD (from Gk. πλείστος, *pleistos*, most, superlative of πῶλος, *polys*, much many + καινός, *kainos*, new). The name introduced by Sir Charles Lyell to designate that period of geologic time which intervened between the end of the Tertiary and the beginning of the historic period. Within the last few years no other section of the earth's crust perhaps has received so much attention as the strata included under this name, and this is particularly true in America. The term Pleistocene is commonly used as synonymous with Quaternary, although some geologists tend to make two divisions of the Quaternary, namely, Pleistocene and recent. Other terms which are used are Post-Tertiary, Glacial Period and Ice Age. One of the most marked features of the Pleistocene was its cold climate and the great development of continental glaciers which formed and spread over a large portion of the globe as a result of these climatic conditions. The faunal and floral characters of the Pleistocene were not sufficiently different from those of the Pliocene to have permitted making it a separate division of geologic time on this account, for in those regions which were not covered by the ice-sheet we find that plant and animal life apparently continued on uninteruptedly from the Pliocene into the Pleistocene.

According to Geikie, there were six glacial and five interglacial stages in Europe, while in the United States Chamberlain considers that there were five glacial and four interglacial stages. The thickness of the continental ice-sheet must no doubt have been enormous, and in some of the mountainous districts in the east we find evidence of its presence on the mountains to a height of several thousand feet. The deposits formed by the ice at different localities and under different conditions are very varied, and are known under a variety of names, such as oskars, kames, over-wash plains, moraines, etc. The term drift is a general one applied to the deposits laid down either by the ice or by the waters flowing from it. The classification proposed by Chamberlain for the drift deposits is as follows:

Wisconsin till sheets (earlier and later).

Interglacial deposits (Toronto?).

Iowan till sheets,

Interglacial deposits.

Illinois till sheets,

Interglacial deposits (Buchanan).

Kansan till sheets,

Interglacial deposits (Aftonian).

Albertan drift sheets.

In the coastal plain region of the Atlantic States there occurs a great series of Pleistocene gravels and sand, known as the Columbian formation. These are the brick clays still extensively worked around Philadelphia, Baltimore, and Washington.

The Pleistocene period was marked by a depression of the land along the Atlantic coast and a temporary drowning of many of the river valleys, such as those of the Hudson River and of the Saint Lawrence. The subsequent elevation gave

rise to many lines of raised beaches which are represented in the terraces in the Hudson Valley and along Lake Champlain. A similar submergence occurred along the Pacific coast.

The animal and plant life of the Pleistocene was in some cases decidedly Arctic in its nature, but many species existed which are still living. The mammals were especially abundant. Those of North America included mastodons, elephants, tapirs, horses, and sabre-toothed tigers, as well as a giant beaver, while in South America the sloths were extraordinarily developed, some being equal in size to an elephant. In Europe the remains of the mammoth, hairy rhinoceros, the great cave-bear, and the Irish deer have been found.

BIBLIOGRAPHY. Stone, "The Glacial Gravels of Maine and Their Associated Deposits," *United States Geological Survey, Bulletin 34* (Washington, 1891); Leverett, "The Illinois Glacial Lobe," *United States Geological Survey, Bulletin 38* (Washington, 1899); Chamberlain, "Preliminary Paper on the Terminal Moraine of the Second Glacial Epoch," *United States Geological Survey, Third Annual Report* (Washington, 1883). See also various articles in the volumes of the *American Geologist, Journal of Geology, American Journal of Science, Bulletin of the Geological Society of America*, etc. See GLACIAL PERIOD.

PLENER, plá'nér, ERNST, Elder von 1841—). An Austrian statesman, son of Ignaz von Plener. He was born at Eger, and was educated at Vienna and Berlin. He served in the diplomatic corps (1865-73), and then entered the Imperial Diet, where he joined the Left, and supported Andrassy's policy in the Balkans (1878). He succeeded Herbst as head of the German Liberals, both in Prague and Vienna, and in 1888 was chosen leader of the party called "United German Left." From 1893 to 1895 Plener was a member of Taaffe's Cabinet as Minister of Finance, and in 1900, after five years at the head of the Court of Accounts, he entered the House of Lords. He wrote on English economic conditions, and a sketch of Ferdinand LaSalle (1884), as well as some valuable speeches delivered in the Bohemian Diet on the Bohemian school and language question (1886).

PLENER, IGNAZ, Edler von (1810—). An Austrian statesman. He was born in Vienna, studied law, and entered the governmental service, in which he showed much ability in finance. In 1859 he was made privy counselor; a year afterwards received the portfolio of finance and planned various important reforms, reviving the Bank Acts and the Ministry of Commerce before his resignation in 1865; and in 1867 he entered the Liberal Centralist Cabinet of Giskra as Minister of Commerce. This post he held until the fall of the Cabinet in 1870. He was a member of the Lower House until 1873, when he was appointed to the House of Lords. Plener was an ardent defender of a personal income tax, which he proposed in 1880 as a solution of financial difficulties.

PLENIPOTENTIARY. See ENVOY.

PLEROME (from Gk. πλῆρωμα, plērōma, a filling). The central embryonic region in stems and roots. It develops into the stele, in which the vascular system appears. See STEM.

PLESHTCHEYEFF, plësh-chá'yěf, ALEXEI (1825-93). A Russian poet, born at Kostroma, and educated at the University of Saint Petersburg. His first volume of poetry, published in 1845, was well received. In 1849 he became involved in a political complication, was accused of conspiracy against the Czar, and sentenced to be shot, but Nicholas I. commuted the death sentence to banishment to Orenburg, where Pleshtcheyeff enlisted in the army as a private soldier. Having distinguished himself in the Caucasus during the Crimean War, he was pardoned in 1857, and in 1872 made his home in Saint Petersburg. From this time he produced much original poetry and also translated poems of Heine, Byron, and Tennyson. In 1887 he published a complete collection of his verse.

PLESIOSAURUS (Neo-Lat., from Gk. πλῆσιος, plēsios, near + σαῦρος, sauros, lizard). A peculiarly interesting fossil marine reptile of the order Sauropterygia, found in the Liassic rocks of Europe. The order Sauropterygia comprises a number of reptiles which began as small amphibians in the Trias and culminated in the Cretaceous as larger forms fully adapted to marine habits of life. They had short thick lizard-like bodies, very long, flexible necks, small heads, and powerful tails. The early members had elongated limbs adapted for crawling on land, which became shortened and assumed paddle-like form in the later genera, but which never so thoroughly degenerated to fin-like organs as did those of the analogous group of ichthyosaurs (q.v.). Two families are recognized: *Nothosauridae*, comprising small more primitive forms, having five-toed feet with the normal number of finger bones or phalanges; *Plesiosauridae*, comprising large animals with paddle-shaped limbs

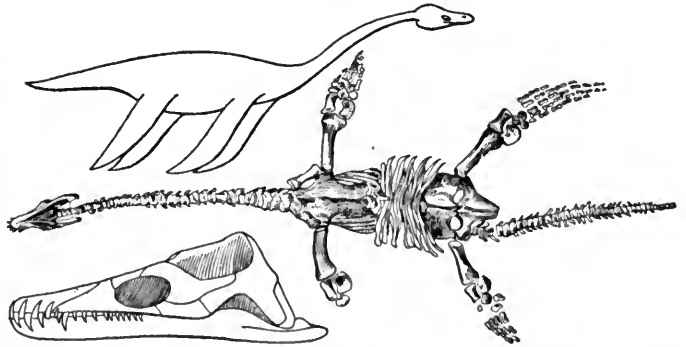

THE PLESIOSAURUS.

Outline of *Plesiosaurus dolichodeirus*, fossilized skeleton, and enlarged view of skull.

and the digits lengthened by an increased number of phalanges, and with the pectoral girdle enlarged to form a protective covering for the thorax. *Lariosaurus* and *Nothosaurus* from the Triassic of Europe are the important genera of the first family; and *Plesiosaurus* from the Liassic of Europe and *Cimoliosaurus* from the Cretaceous of America and New Zealand are representative of the second family.

The genus *Nothosaurus*, which attained a length of about ten feet, had a long flattened skull and small eyes near the middle of the head. The teeth were numerous, small and regular in the posterior portion of the jaws, but large and recurved, like spreading tusks, in the front. *Plesiosaurus* had a proportionately smaller head of triangular form and a neck which in some species exceeded in length the remainder of the body, and which was supported in the different species by from 25 to 40 cervical vertebrae. The teeth are not so numerous as in *Nothosaurus*, and are larger, recurved, and interlocking. The pelvic and pectoral limbs are remarkably similar to each other in form, and the phalanges of both were imbedded in cartilage which filled out the form of the paddle just as in the ichthyosaurs. These creatures varied from 10 to 20 feet in length, and they must have been very abundant in the Liassic seas of England and Germany, where finely preserved skeletons of them have been obtained. Twenty-five species are known in the Lias of England alone. *Pliosaurus* is a gigantic plesiosaur with a skull nearly five feet long and teeth twelve inches long, found in the English Upper Jurassic, and it is possibly a synthetic type between the ichthyosaurs and the plesiosaurs. American representatives of the plesiosaurs have been found in the Upper Jurassic beds of Alabama, New Jersey, Kansas, and Wyoming, and have been described under the names *Cimoliosaurus*, *Megalneusaurus*, *Elasmosaurus*, *Doliehorhynchops*, etc. A skeleton of Cope's *Elasmosaurus* from the Upper Cretaceous of Fort Wallace, Kansas, lacking the head, measures 42 feet in length, of which the neck, with 72 vertebrae, occupies 22 feet. Some of the American examples have afforded interesting evidence of the feeding habits of these creatures. Stones of various sizes from one-quarter inch to four inches diameter were found in the position of the stomach, and are supposed to have been swallowed by the animals as aids to digestion. One specimen had 125 such stones in its stomach. Plesiosaurs, as Cuvier expressed it, combine the paddles of a whale, the head of a lizard, and a long neck like the body of a serpent. They were powerful animals, swimming freely about the shallow seas of Jurassic and Cretaceous times, and feeding upon the fish and smaller marine reptiles, for preying upon which their long necks and numerous spreading teeth admirably fitted them.

BIBLIOGRAPHY. Von Zittel and Eastman, *Textbook of Palaeontology*, vol. ii. (New York and London, 1902); Williston, "A New Plesiosaur," etc., *Transactions of the Kansas Academy of Science*, vol. xii. (Topeka, 1890); id., "An Interesting Food Habit of the Plesiosaurs," *Transactions of the Kansas Academy of Science*, vol. xiii. (Topeka, 1893); id., "North American Plesiosaurs, Part I.," *Field Columbian Museum, Publication 73, Geological Series*, vol. ii., No. 1 (Chicago, 1903).

PLESSIS, plēs'sè', JOSEPH OCTAVE (1763-1825). A Roman Catholic prelate of Canada. He was born at Montreal. He entered the priesthood in 1801, was appointed coadjutor to Mgr. Denauet, Bishop of Quebec, and succeeded to the bishopric upon the death of that prelate in 1806. He obtained a royal charter for Nicolet College, where he instituted classical training, and founded the primary schools of Quebec. The British

Government did not immediately recognize his elevation to the office of bishop, claiming the right of nomination to the office within the province which the French Government had formerly possessed. But the Bishop successfully maintained his position in the controversy, and in 1818 he was summoned to the Executive Council of Canada by his episcopal title. In 1818 Quebec was made an archbishopric, but the Government never gave recognition to this titular advancement. He always showed great attachment to the British Crown and enthusiastically supported the Imperial relation. Consult his *Life* by Ferland (Quebec, 1864); and Kingsford, *History of Canada* (Toronto and London, 1888-98).

PLEURA (Neo-Lat., from Gk. πλεῦρά, rib, side). The name of a very delicate serous membrane externally investing the lung, which, after inclosing the whole organ, except at its root, where the great vessels enter it, is reflected upon the inner surface of the thorax or chest. That portion of the pleura which is in contact with the surface of the lung is called the *pleura pulmonalis*, or visceral layer, while that which lines the interior of the chest is called the *pleura costalis*, or parietal layer, and the space intervening between these two layers is called the *cavity of the pleura*. Each pleura is a closed sac, and quite independent of the other. The central interspace between the right and left pleuræ is termed the *mediastinum*, and contains all the viscera of the thorax excepting the lungs. The inner surface of each pleura is smooth, glistening, and moistened by a serous fluid; the outer surface is closely adherent to the surface of the lung, to the roots of the pulmonary vessels as they enter the lung, to the upper surface of the diaphragm, and to the walls of the chest. The lobes of the lungs are separated from one another by involutions or in-foldings of the visceral layer. The use of these serous sacs is much the same as that of the *peritoneum* (q.v.); each pleura retains the lung and to a certain extent the greater vessels in position, while it at the same time facilitates, within certain limits, the movements of those parts which are essential to the due performance of the act of respiration.

PLEURACANTHUS (Neo-Lat., from Gk. πλεῦρόν, *pleuron*, rib + ἀκανθα, *akantha*, spine). A fossil shark-like fish found in the Carboniferous and Permian rocks of North America, Europe, and Australia. The body was long and tapering, with a linguatè diphycercal caudal fin. The dorsal fin extended almost the entire length of the back and was separated from the upper lobe of the caudal fin by only a slight notch. On the top of the head was a long, posteriorly directed strong spine, which was hollow and armed with longitudinal rows of barbs. The pectoral and pelvic fins were large and there were two small anal fins. Several complete skeletons of this fish have been found in the European Carboniferous rocks.

PLEURISY (Fr. *pleurésie*, from Lat. *pleuritis*, *pleuritis*, from Gk. πλεῦρις, *pleurisy*, from πλεῦρά, *pleura*, rib). An inflammation of the pleura, the serous membrane investing the lungs. This membrane, like the pericardium (q.v.) and the peritoneum (q.v.), consists of two layers, a visceral and a parietal, the former closely attached to the lungs, and the latter applied to

the interior of the chest wall. These two layers are normally everywhere in contact and move upon each other freely during respiration, a lubricating fluid being secreted for this purpose. A space between the visceral and parietal portions of the membrane, called the pleural cavity, exists only under pathological conditions, and may be occupied either by air or fluid.

Pleurisy may be acute or chronic, primary or secondary, plastic (dry) or characterized by an effusion of fluid. It occurs after exposure to cold; as a secondary process in acute diseases of the lung, as pneumonia, which is always accompanied by a greater or less amount of dry pleurisy; as a result of injuries; or as an effect of rheumatism. The most frequent cause, however, is tuberculosis; recurrent attacks of pleurisy are almost always tubercular in character.

In the dry or plastic form of pleurisy the affected area of the membrane becomes congested and opaque, roughened, and covered with a sheathing of lymph, of variable thickness. The process may be arrested at this point, the exudate be absorbed, and complete recovery take place; or the plastic exudate may become organized and produce permanent adhesions between the two pleural layers. These adhesions are in the form of patches or bands, and in proportion to their extent limit the movements of the lungs in the chest cavity.

In pleurisy with effusion there is thrown out a varying amount of sero-fibrinous fluid, pale yellowish in color, or brownish at times from extravasated blood. In composition this closely resembles the serum of the blood. The effusion may be so small in quantity as to cause no symptoms and escape notice. When considerable in amount, the lung is compressed, the heart and other organs displaced, and respiration and circulation seriously interfered with. Small quantities of fluid are readily absorbed, but large effusions may persist for months unless reduced by surgical means. In some cases the effusion is limited to the diaphragmatic portion of the pleura (diaphragmatic pleurisy); in others only the portion between the lobes of the lung is involved (interlobular pleurisy). A hemorrhagic effusion sometimes occurs during the course of certain malignant fevers and in cachectic states of the body.

A pleuritic exudate may become infected by pus-producing bacteria which multiply very rapidly and soon convert the fluid into a purulent material. This condition is called empyema, and is a very grave complication. The pleural cavity is converted into what is practically a large abscess, which may evacuate itself by burrowing through the lung substance to a bronchial tube and being coughed up; or it may penetrate the chest wall; or make its way through the diaphragm into the peritoneal cavity and set up a general peritonitis. The affection is more common and less fatal in children than in adults. In the former a favorable result may be expected, particularly if the pus is evacuated early. Some cases recover spontaneously.

The most prominent symptoms of pleurisy are chills, fever, stitch in the side, and a dry, unproductive cough. The pain is at first severe, and is exaggerated with every movement of the body, by coughing, sneezing, etc. Respiration is difficult and shallow, and the patient lies upon his

back or on the healthy side. After effusion has taken place pain is less marked, and the patient lies on the affected side, in order to give the healthy lung full play. In addition to these symptoms there exist general malaise, weakness, loss of appetite, and a quick pulse. Empyema is marked by irregular temperature, chills, and sweats.

The physical signs of dry pleurisy are impaired motion on the affected side and a friction sound caused by the rubbing together of the inflamed surfaces. When the effusion has occurred, this sound disappears, there is a loss of pulmonary resonance, and dullness or flatness on percussion over the area occupied by the effusion. The side involved is larger than the other, the intercostal spaces are obliterated or bulge. The heart may be displaced upward or to one side, so that the apex beat is felt out of its normal place, or entirely hidden behind the sternum.

A sero-fibrinous pleurisy may persist for months, and the lung, from the long-continued pressure, become permanently contracted, so that when the fluid is absorbed or drawn off it fails to return to its normal dimensions and to fill the whole cavity. Adhesions may help to produce this condition.

The treatment of dry pleurisy comprises rest in bed, saline catharsis, and relief of pain by the administration of sedatives or by counter-irritation in the form of a mustard plaster or the application of the electro-cautery. Strapping the chest with long strips of adhesive plaster gives comfort by limiting respiratory movements. Pleurisy with effusion requires a somewhat different plan of treatment. To favor absorption of the exudate, the diet is made light and dry, and daily concentrated doses of Epsom salt are given to promote elimination. The skin and kidneys are also kept active with diaphoretic and diuretic medicines. Mild counter-irritation with mustard or iodine is useful in the later stages. When the effusion is large and resists all ordinary methods of treatment, aspiration of the fluid or part of it is practiced. This is accomplished by puncturing the chest wall with a hollow needle attached to a suction pump. The operation is simple and not painful, and is sometimes done merely to determine the nature of the exudate. The fluid is withdrawn slowly, the amount depending on the size of the effusion. In some cases a quart or more can be abstracted with safety. Frequently the withdrawal of a small amount will be followed by spontaneous absorption of the remainder. Purulent pleurisy—empyema—is treated by making an incision into the chest wall and allowing the pus to escape, washing out the cavity and draining it. This operation dates from the time of Hippocrates and is not a serious procedure. The cavity is gradually filled by the expansion of the lung and the falling in of the chest wall. Sometimes it is necessary to remove portions of one or more ribs. Expansion of the lung is promoted by systematic breathing exercises.

PLEURISY ROOT. One of the milkweeds. See BUTTERFLY-WEED.

PLEURODYNIA (Neo-Lat., from Gk. *πλευρά*, *pleura*, rib + *δύνη*, *odynē*, pain). A rheumatic affection of the intercostal muscles on one side, characterized by acute pain in the side upon taking a full breath or coughing, and by tenderness on pressure. The respiratory movements

are restricted as much as possible on account of the pain. The disease is difficult to distinguish from intercostal neuralgia, in which disease, however, the pain is usually more limited and paroxysmal, and there are tender points along the course of the nerves. If it happens to be attended by a slight febrile excitement and a cough, pleurodynia closely resembles pleurisy (q.v.), but the physical signs of the latter affection are wanting. The pain may be completely relieved by strapping the chest with strips of adhesive plaster. Mild counter-irritation and stimulating liniments are very often useful. The general treatment is that of rheumatism (q.v.).

PLEURONECTIDÆ. See FLATFISH; FLOUNDER.

PLEUROPNEUMONIA (Neo-Lat., from Gk. πλεῦρά, *pleura*, side + πνευμονία, *pneumonia*, pneumonia), LUNG PLAGUE, LUNG FEVER, PERIPNEUMONIE (Fr.), LUNGENSEUCHE (Ger.). A malignant contagious disease of cattle, characterized by an inflammatory process accompanied by exudation on the pleura and in the lungs. The disease has been recognized in Europe since the close of the eighteenth century. Domestic cattle, the buffalo, and the yak are most susceptible to it. Goats, pigs, horses, and carnivora are very resistant, and man is immune. It occurs at present in Europe, Asia, Africa, and Australia. It has been eradicated from Great Britain, the last case having been observed in 1896. The disease was introduced into the United States in 1843, and was finally eradicated through the efforts of the Bureau of Animal Industry in 1892. Consult Law, "The Lung Plague of Cattle," in the *Farmers' Veterinary Adviser* (Ithaca, N. Y., 1892).

PLEUROTOMARIA (Neo-Lat. nom. pl., from Gk. πλεῦρον, *pleuron*, rib + τομάριον, *tomarion*, diminutive of *τόμος*, *tomos*, cut, slice, from τέμνειν, *temnein*, to cut). The typical genus of Pleurotomaridae, a family of scutibranchiate gastropods. While quite rare at the present time, this genus was abundantly represented in the seas of the Paleozoic, Mesozoic, and Cenozoic eras. Its ancestral form is apparently the genus Raphistoma, a small shell of the early Ordovician, with low spire and sharply angular whorls. Pleurotomaria itself, with elevated spire and prominent slit band, made its appearance in the Silurian, and with a great variety of forms and allied genera it attained its maximum in the seas of Mesozoic time, since when it has been gradually declining to the present time. This large genus, embracing several hundred species, is split up into a number of subgenera. One of the most important allies of Pleurotomaria is the Paleozoic genus Murchisonia (q.v.).

PLEVNA, plév'ná, or **PLEVEN**. A town of Bulgaria, situated on a tributary of the Danube and on the Sofia-Varna Railway, about 85 miles northeast of Sofia (Map: Balkan Peninsula, E 3). The town has a considerable trade in cattle and wine. It is connected by a branch railway line with the Danube. Population, in 1900, 18,709.

Plevna is famous for the rôle which it played in taking the Russo-Turkish War of 1877. Garrisoned only by a small Turkish force at the beginning of the war, the place became, after the taking of Nikopoli by the Russians (July 16,

1877), the centre of operations in the western part of the theatre of war in Bulgaria. Just as the Russians were preparing to march toward Sofia, Osman Pasha arrived with a part of his army at Plevna. The Turkish forces at that point now amounted to 17,000 men with 58 guns, and the Russians dared not advance leaving this unexpected enemy in their rear. On July 20, 1877, an assault by a comparatively small force of Russians was repulsed, their loss being about 2800 men. The result of the first assault revealed to the Russians the strength of the Turkish forces at Plevna, and accordingly the Russian forces were increased to about 32,000 men, with 176 guns. The second attack, on July 30th, led by General Krüdener, was also unsuccessful, and the Russians lost over 7000 men. The besieging army was augmented by about 35,000 Rumanians, while the Turkish forces were also increased to about 36,000 men, with 70 guns. On September 7th the bombardment was resumed, and in a desperate assault on September 11th General Scobelev captured three trenches, but was compelled to abandon them on the following day. The Russians and Rumanians lost nearly 16,000 men between September 7th and 11th, and it was then decided to invest the town by a large army and compel its surrender by cutting off its supplies. These operations were successfully carried out under the direction of Tottleben, and the besieged army, which had by that time been increased to about 45,000 men, soon began to suffer from lack of supplies and ammunition. Osman Pasha finally decided to break through the Russian chain, and accordingly crossed the Vid with his entire army on the night of December 9-10, and after an unsuccessful attack was thrown back toward the river, but, unable to cross the stream, surrendered unconditionally after a hard fight, in which he himself was wounded. The Russians took 40,000 prisoners and 77 guns. The total loss of the besieging army in killed and wounded was about 40,000 men.

Consult: Osman Pasha, *Défense de Plevna, d'après les documents réunis par Mouzaffer Pasha et Taalat Bey* (Paris, 1889); Herbert, *The Defense of Plevna* (London, 1895).

PLEXIMETER. See PERCUSSION.

PLEYEL, plé'el, IGNAZ (1757-1831). An Austrian composer, born in Ruppersthal, near Vienna. He studied music under Wanhal and Haydn, and made in early life an extensive tour of Italy to hear the works of the best composers. In 1783 he was made kapellmeister of the Strassburg Cathedral, and there composed most of the works on which his popularity rests. In the winter of 1791-92 he was engaged as the conductor of the London Professional Concerts. He returned to Strassburg and subsequently went to Paris (1795), and after a successful career in that city as a publisher of music and pianoforte manufacturer under the firm name of Pleyel, Wolff et Cie, retired to an estate which he had purchased near the capital. His compositions, consisting of quartettes, concertantes, and sonatas, are full of agreeable melodies, sometimes light and trivial, but occasionally giving evidence of genius. He died on his own estate, near Paris.

PLIANT, DAME. A pretty, silly widow in Ben Jonson's comedy *The Alchemist*.

PLIANT, SIR PAUL. A henpecked, stupid husband in Congreve's *Double Dealer*. Lady Pliant is a handsome, silly woman who rules her old husband and presumes on his blindness.

PLICA (Neo-Lat., from Lat. *plicare*, to fold), **TRICHOMA**, **PLICA POLONICA**. A condition in which the hair of the scalp, the beard, or the hair of the pubes becomes matted together, forming a stiff mass or a firm rope, which is exceedingly difficult to disentangle. The condition is observed among the inhabitants of Galicia, Posen, Poland, and Silesia, and is due to neglect, especially during illness. It was formerly regarded as a disease. Naturally, such a mass becomes easily infested with fungi and vermin. Superstition prevents cutting or combing the hair, as the matting is believed to prevent sickness and misfortune.

PLIMSOLL, plim'sol, SAMUEL (1824—). An English reformer, known as 'The Sailor's Friend.' He was born and educated in Bristol. As a coal dealer in London he began to take an interest in the carrying trade and to remark upon the risks to sailors in being shipped upon over-laden or unseaworthy vessels, largely insured. As a member of Parliament (for Derby), and by his book *Our Seamen* (1873), he aroused so much discussion of the abuses that his measures for reform ultimately were adopted. His *Cattle Ships* (1890) was written with a view to reformation in that branch of the merchant service, and his name is remembered by the 'Plimsoll mark' on all ships above which they must not be laden. See **LOAD LINE OF VESSELS**.

PLINTH (Lat. *plinthus*, from Gk. πλινθος, brick, tile, plinth). The square member at the bottom of the base of a column. Also the plain projecting band forming a base of a wall.

PLINY THE ELDER, GAIVS PLINIUS SECUNDUS. The author of the celebrated *Historia Naturalis*. He was born in the north of Italy, probably Novum Comum (*Como*), A.D. 23. Whether it was his birthplace or not, Novum Comum was certainly his family's place of residence, since he had estates in its neighborhood. While still young he was sent to Rome, where his ample means and high connections secured him the best education. At the age of twenty-three he entered the army, and served in Germany as commander of a troop of cavalry under Lucius Pomponius Secundus, of whom, in later life, he wrote a memoir. He traveled over nearly all the frontier of that extensive province, visited the Chauci and the sources of the Danube, composed during the intervals of military duty his treatise *De Iaculatione Equestri*, and commenced a history (afterwards completed in twenty books) of the Germanic wars. On his return to Rome in 52 with Pomponius, he entered on the study of jurisprudence; but his pleading was unsuccessful, and, accordingly, he retired to his native place. There he wrote his *Studiosus*, a treatise in three books on the training of a young orator from the nursery to his entrance on public life, and apparently intended to guide the education of his nephew; also his grammatical work, *Dubius Sermo*, in eight books. Shortly before Nero's death we find him a procurator in Spain, where, in 71, he heard of his brother-in-law's decease, and of his being intrusted with the guardianship of his nephew, Pliny the Younger, whom he adopted on his return to Rome before 73. Ves-

pasian, the reigning Emperor, whom he had known while in Germany, received him as one of his most intimate friends; and it was at this period that he completed, in 31 books, and brought down to his own time the Roman history of Aufidius Bassus. His mode of study at this time was a model of systematic assiduity. He would begin his studies by candle-light in autumn at a late hour of the night, and in winter at one or two in the morning. Before daybreak he would call on the Emperor, for whom he would proceed to execute various commissions; this done he would return home and resume his studies. A slender meal would follow; after which he would take notes or extracts from the books which were read to him. The practice of jotting down important facts or observations was habitual with him, and he was often heard to say that there was no book, however bad, from which some good could not be got. A cold bath, followed by a light meal and a short sleep, occupied another interval, after which he would study till the *cena*, or dinner-time. Even at this meal some book was read to him on which he would make comments. When on a journey, again, he was never without a secretary at his elbow, provided with a book and tablets. By this mode of life he collected an immense mass of materials, from which he compiled his great *Historia Naturalis*, published about 77. No fewer than 160 *volumina* of notes were found at his death, two years afterwards. At the time of the great eruption of Vesuvius, which overwhelmed Herculaneum and Pompeii, in 79, he was stationed off Misenum, in command of the Roman fleet. Eager to examine the phenomenon more closely, he landed at Stabia, where he was suffocated by the vapors caused by the eruption. He was, as his nephew tells us, corpulent and asthmatic, and so sank the more readily. None of his attendants shared his fate. The story of his death is described in two letters of his nephew, Pliny the Younger, to Tacitus, written many years after the event (v., 16 and 20).

Of all his works, only his *Historia Naturalis* has come down to us. It comprehends astronomy, meteorology, geography, mineralogy, zoölogy, botany, everything, in short, which is a natural or non-artificial product. Moreover, the work is interspersed with digressions on such subjects as human institutions and inventions, and the history of the fine arts. It is divided into 37 books, the first of them being a dedicatory epistle to Titus, with a table of contents of the remaining books, and embraces, as we are told in the preface, 20,000 matters of importance, extracted from about 2000 volumes. Its scientific merit is not great. There is little attempt at philosophical arrangement; the observations are nearly all taken at second hand, and show small discrimination in separating the true from the false, or the probable from the marvelous. His meaning is often obscure, owing to his lack of personal acquaintance with the matters of which he treats and his failure to grasp the true sense of the authors whom he cites or translates. But the work is a great monument of industry and research, and most valuable as supplying us with details on a great variety of subjects as to which we have no other means of information. The best critical editions of the text are those of Sillig (8 vols., Gotha, 1851-58); Jan (Leipzig, 1875-80); and Mayhoff (a recension of Jan,

Leipzig, 1875-97). There is an old English translation by Holland (London, 1601), and a more recent one, in Bohn's Library, by Bostock and Riley (London, 1855-57). Pliny's chapters on the history of art are edited, with commentary, by Jex-Blake and Sellers (London, 1896).

PLINY THE YOUNGER (GAIUS PLINIUS CÆCILIUS SECUNDUS). A nephew of Pliny the Elder, and son of Gaius Cæcilius. He was born at Novum Comum (Como), A.D. 62. He was still young when he lost his father, and was adopted by his uncle, under whose care, and that of his mother, Plinia, and his tutor, Virginius Rufus, his education was conducted. Passionately devoted to literature, he wrote a Greek tragedy at the age of thirteen. He studied eloquence under Quintilian, and became so famous for his literary accomplishments that he acquired the reputation of being one of the most learned men of the age. His oratorical powers were also considerable; in his nineteenth year he began to speak in the Forum, and his services as an advocate before the court of the centumviri and the Roman Senate were in frequent request. He held numerous official appointments; served, while a young man, as *tribunus militum* in Syria, where he listened to the teaching of Euphrates the Stoic, and Artemidorus; was afterwards *quæstor Cæsaris*; was prætor about 93, and consul in 100, when he wrote his *Panegyricus*, an adulatory eulogium of the Emperor Trajan. He was appointed, in 103, proprietor of the Province Pontica or Bithynia, an office which he vacated in less than two years; and he also discharged the function of curator of the banks and channel of the Tiber. He was twice married, his second wife being Calpurnia, granddaughter of Calpurnius Fabatus. Our knowledge of Pliny the Younger is mainly derived from his letters or *Epistulae*, of which there are ten books. He collected them himself, and probably wrote many of them with a view to publication. They hold a high place in epistolary literature, and give us many interesting glimpses into the life of their author and his contemporaries. Pliny himself appears in them to considerable advantage, as a genial and philanthropic man, enamored of literary studies, and fond of improving his estates by architectural adornment. His ample fortune was liberally bestowed, and his slaves always found in him an indulgent master. He never enjoyed robust health; but of the time or cause of his death we know nothing. Of his letters, one of the most interesting is the one to the Emperor Trajan (Book x., 97), written while Pliny was Governor of Bithynia, and asking for instruction in regard to the policy to be pursued against the stubborn sect of Christians; this is one of the earliest notices of the Christians in Roman writers. The best editions of Pliny's *Panegyricus* and *Epistulae* together are those of Schæfer (Leipzig, 1805) and Keil (ib., 1892); of the *Epistulae* alone, that of Gierig (ib., 1806). Of English translations, there are the *Panegyricus* by Bond (London, 1724) and the *Epistulae* by Melmoth (ib., 1746); 10th ed. 1805) and Lord Ormery (ib., 1752). An excellent sketch of Pliny's life by Rendall is printed in Mayor's edition of Book iii. of the *Epistulae* (ib., 1880).

PLIOCENE EPOCH (from Gk. *πλειών*, *pleiōn*, more, comparative of *πολύς*, *polys*, much, many

+ *καιρός*, *kainos*, new). The name given by Sir Charles Lyell to the uppermost division of the Tertiary system. Pliocene rocks are not extensively developed in America, but in Europe they are of great importance. Along the Atlantic coast of the United States isolated areas have been found from Virginia southward to Florida; and similar patches occur on the Pacific coast, the Merced series of the San Francisco peninsula having a thickness of nearly 6000 feet. In the interior there are a number of Pliocene basins in which fresh-water strata were deposited. The Goodnight and Blanco stages of Texas and similar strata in Kansas, Oklahoma, and Oregon were laid down in fresh-water lakes. The Pliocene of Europe comprises extensive deposits in Spain, France, Italy, Sicily, and Greece, and smaller areas in Belgium, Northern France, and England. The life of the Pliocene epoch is quite modern in character, although many species of both plants and animals are no longer existent. The rhinoceros, horse, llama, sloth, mastodon, and peccary inhabited North America at that time, while the European fauna included many forms which resemble those living at present in Africa. See TERTIARY SYSTEM.

PLIOSAU'RUS (Neo-Lat., from Eng. *pliocene* + Gk. *σαῦρος*, *sauros*, lizard). A gigantic Plesiosaurus with large head and short neck. See PLESIOSAURUS.

PLOCK, plótsk. A government occupying the northwestern part of Russian Poland, bounded by Prussia on the north. Area, 3674 square miles. The surface is slightly elevated toward the north and slopes toward the valley of the Vistula. The chief rivers are the Vistula, which forms the southern and western boundaries of the government, and the Narev. The soil is well adapted for agriculture, which is the chief occupation. Rye, potatoes, oats, and beets are the principal agricultural products, the last named being raised for the beet-sugar mills in the governments of Plock and Warsaw. Stock-breeding is also important. The manufacturing industries are confined mostly to the production of sugar, flour, spirits, and trimmed lumber. Population, in 1897, 556,877.

PLOCK. One of the oldest cities of Russian Poland and capital of the Government of Plock, picturesquely situated on the right bank of the Vistula, about 60 miles west-northwest of Warsaw (Map: Russia, B 4). It is a pretty town with a fine public garden, a town hall, a cathedral founded in the twelfth century, two gymnasias, a seminary for teachers, a theatre, and a number of libraries. The manufacturing industries are of little importance, but there is a considerable trade in grain, which is carried by the Vistula to Germany. Population, in 1897, 27,073. Plock is mentioned in connection with the introduction of Christianity into Poland in the tenth century. It was the capital of the mediæval Principality of Masovia.

PLOCK'HORST, BERNHARD (1825—). A German historical painter, born at Brunswick. Having practiced drawing and lithography in Berlin and Dresden, he took up painting in 1850 at Munich under Piloty, and in 1851 studied in Paris under Couture. A visit to Belgium and Holland in 1854 was followed by a sojourn in Italy, especially at Venice, whereupon he settled first at Leipzig, then in Berlin, whither he re-

turned after having been professor at the School of Art in Weimar from 1866 to 1869. His religious paintings excel in lofty conception, great truthfulness and depth of expression, and a masterly technique, placing him in the front rank as a colorist. Foremost among them is the "Contest of Archangel Michael with Satan for the Body of Moses" (1861-66) in the Cologne Museum, and other noteworthy specimens include "Mary and John Returning from Christ's Tomb," in the Löwenstein Gallery at Moscow; "Christ and the Adulteress," "Mater Dolorosa" (1860), both in the Leipzig Museum; and "Resurrection" (1867), in the Cathedral at Marienwerder. Among his more recent works may be mentioned "Christ's Entry into Jerusalem" (1892) and "Abide with Us" (1895). Of several meritorious portraits, those of Emperor William I. and Empress Augusta (1876) are in the National Gallery, Berlin.

PLOESTI, plô-ès'té. A town of Rumania. See **PROYESHTI**.

PLOMBIÈRES, plôn'byâr'. A fashionable watering-place in the Department of Vosges, France, 13 miles south of Epinal (Map: France, N 4). It is picturesquely situated in a deep valley on the Aurgonne and is celebrated for a number of mineral and thermal springs, known since the time of the Romans. The place was embellished by Stanislas Leszczynski in the eighteenth century, and by Napoleon III. in the nineteenth. There are sumptuous public and private bath-houses, a hospital founded by Stanislas, two large hotels, a casino, a park, and promenades. Population, in 1901, 1830. At Plombières in July, 1858, occurred the secret meeting between Napoleon III. and Cavour which led to the conclusion of an alliance between France and Sardinia against Austria. See **ITALY**; **CAVOUR**.

PLONGÉE, plôn'zhâ' (Fr., plunged). In military science, a term meaning a slope toward the front. The plongée of a shell in artillery fire is that part of the curve of the trajectory between its highest altitude and the point at which it strikes the earth. In fortification the plongée is the superior slope of the parapet toward the front. The slope of the latter varies from 1 in 9 to 1 in 4.

PLÖNNIES, plë'nëz, **LUISE VON** (1803-72). A German lyricist and religious poet, born at Darmstadt. Her sketches of travel in Belgium, published in 1847, won her election to the Brussels Royal Academy. Her lyric ability is best shown by her translations: *Britannia* (1843), *Englische Lyriker des 19. Jahrhunderts* (1863), and *Sav-etri* (1862; 3d ed. 1867); as well as by her original works: *Gedichte* (1844); a sonnet sequence, *Abälard und Heloise* (1849); and *Die sieben Raben* (1862; 3d ed. 1866). Of her religious poems the best known are: *Lilien auf dem Felde* (1864); a drama, *Maria Magdalena* (1870); and *David* (1873).

PLÖNNIES, **WILHELM VON** (1828-71). A German military writer, son of Luise von Plönnies. He was born in Darmstadt, entered the Hessian infantry at sixteen, fought in the campaign of 1848-49 in Baden, and resigned in 1861. In belles-lettres he made himself known by a version of *Kudrun* (1853), by the poems *Immortellen des Schlachtfeldes* (1870) and *Schwanelieder* (1871), and by a humorous novel, *Leben,*

Wirken und Ende des Generals Leberecht vom Knopf (1869; 2d ed. 1877; written under the pseudonym Ludwig Siegrist). His works on fire-arms are very valuable. They include: *Neue Studien über die gezogene Feuerwaffe der Infanterie* (1861-64), *Das Zündnadelgewehr* (1865), *Hinterladungsgewehre* (1867), and, with Weygandt, *Die deutsche Gewehrfrage* (1871).

PLON-PLON, plôn' plôn'. A name given to Prince Napoleon, son of Jerome Bonaparte, in allusion to his cowardice in the Crimean War. The word is a corruption of *plomb-plomb* (lead).

PLOTINUS (Lat., from Gk. Πλωτῖνος). The most original and important philosopher of the Neo-Platonic school. He was born at Lyeopolis, in Egypt, about A.D. 205; but such was his utter indifference to things human, "being ashamed almost to live in a body," that he never would divulge even his parentage. He would never allow his birthday to be celebrated, although he gave feasts on those of Socrates and Plato; nor would he ever permit a painter or sculptor to perpetuate his features, or, as he called it, to produce the image of an image—the body being to him only a faint image of existence. His body was altogether contemptible in his eyes; he would see no physician in his illness, and was very sparing in the use of food, refraining from meat, often even from bread. Strangely enough, his desire for the study of philosophy did not arise within him before his twenty-eighth year, when he repaired to Alexandria, and there, after having sat at the feet of the great masters for some time without feeling satisfied with their teachings, he at last became acquainted with Ammonius Saccas, and in him found the desired teacher. For ten years he zealously attended his lectures, and although he had agreed, with two fellow-students, never to make known aught of Ammonius's teachings to the world, he yet became the chief representative and author of that school, less as a pupil than as an independent thinker, who, taking his stand upon its theorems, developed them to their full extent. In 242 he joined Gordianus's expedition to Persia, in order to devote himself to the philosophy of India and Persia; but the Emperor being murdered in Mesopotamia, he had to repair hurriedly to Antioch, whence, in 244, he went to Rome. His lectures here were attended by crowds not only of eager youths, but of men and women of the highest circles. Not only Platonic wisdom, in Neo-Platonic garb, but asceticism and the charm of a purely contemplative life, were the themes on which he, in ever-new variations, and with an extraordinary depth and brilliancy, held forth; and such was the impression his earnestness made upon his hearers, that several of them really gave up their fortunes to the poor, set their slaves free, and devoted themselves to a life of study and ascetic piety. Dying parents intrusted their children and money to him, well knowing that a more honest guardian, and one more anxious for his charges, could not be found. It is hardly surprising to find that his contemporaries coupled with his rare virtues the gift of working miracles. At the age of sixty he thought of founding an aristocratical and communistic commonwealth on the model of Plato's Republic, and obtained from the Emperor Gallienus a grant of two cities in Campania as a site for his 'Platonopolis;' but courtiers prevented the fulfillment of this promise. Plotinus died in

270. at Puteoli (now Pozzuoli), when sixty-six years of age.

Plotinus's system was based chiefly on Plato's theorem of the ideas; only that while Plato assumed the ideas to be the link between the visible and the invisible, or between the supreme Deity and the world, Plotinus held the doctrine of emanation, that is, the constant transmission of powers from the absolute to the creation, through several agencies, the first of which is 'pure intelligence,' whence flows the 'soul of the world,' whence, again, the souls of 'men' and 'animals,' and finally 'matter' itself. Men thus belong to two worlds, that of the senses and that of pure intelligence. It depends upon ourselves, however, to which of the two worlds we direct our thoughts most and finally belong. The ordinary virtues, as justice, moderation, valor, and the like, are only the beginning and very first preparation to our elevation into the spiritual realm; purification, or the exercise of *purifying* virtues, is a further step, to which we attain partly through mathematics and dialectic; and the abandonment of all earthly interests for those of intellectual meditation is the nearest approach to the goal. The higher our soul rises in this sphere of intellect, the deeper it sinks into the ocean of the good and the pure, until at last its union with God is complete, and it is no longer thought but vision and ecstasies which pervade it. He held a mysterious belief in a kind of metempsychosis, by which souls, not sufficiently purified during life, return after death, and inhabit, according to their bent, men, animals, or even plants. He further held views of his own respecting gods and demons, whom he divided into different classes, according to their degrees; and professed faith in mantie, astrology, and magic, the conviction of the truth of which sciences he derived from his theory of the harmony in the intellectual world reflected by the material world. Yet it is clear from his dicta on these subjects that he did not believe in these so-called sciences in the gross sense of the herd, but that he had a vague knowledge of those mysterious laws of attraction and repulsion which go through nature. Plotinus's philosophy, which, as it were, tried to combine all the systems of Anaxagoras, Parmenides, the Pythagoreans, Plato, and Socrates, and the Stoa into one, was the last and boldest attempt of the ancient Greek world to explain the mystery of the creation and of existence. Its influence upon modern philosophy is remarkable. From Spinoza to Schelling, the reminiscences of Plotinus, irrespective of the drift of particular parts of their systems, recur constantly. See NEO-PLATONISTS.

Plotinus's works were well-nigh forgotten, when Marsilius Ficinus first published a Latin paraphrase of them (Florence, 1492), which was followed by the *editio princeps* of the original (Basel, 1580 and 1615). The first critical edition, however, is due to Creuzer (Oxford, 1835, 3 vols.). Others are those of Dübner (Paris, 1855), Kirchoff (1856), and Volkmann (Leipzig, 1883-84). Parts of his works were translated into German by Engelhard (1820); into English by Taylor (1794 and 1817); into French by Bouillet (1861). Consult: Kirchner, *Die Philosophie des Plotinus* (Halle, 1854); Richter, *Neuplatonische Studien* (ib., 1864-67); Brenning, *Die Lehre vom Schönen bei Plotin* (Göttingen, 1864); Kleist, *Plotinische Studien* (Hei-

delberg, 1883); Pisynos, *Die Tugendlehre des Plotin* (Leipzig, 1895).

PLOUG, plô. PARMO CARL (1813-94). A Danish poet and politician, born in Kolding. As editor of the *Fædreland* (the Fatherland) from 1841 to 1881, he used his pen to uphold the national Scandinavian spirit. He was a member of the constitutional convention in 1848-49, and from 1854 to 1857 of the Folkething. His popular student songs were published under a pen-name as *Poul Rytters Viser og Vers* (1847), and in 1861 his complete poems, *Samlede Digte*, appeared. His later volumes of verse, erotic and patriotic, were *Nyete Sange og Digte* (1869), *Nye Digte* (1883), and the posthumous *Eftertætte Digte* (1895).

PLOVER (OF. *plover*, Fr. *pluvier*, from ML. *plurarius*, plover, from Lat. *pluvia*, rain, from *pluere*, to rain; connected with Gk. πλείν, *plein*, Skt. *plu*, *pru*, to swim, and ultimately with Lith. *plusti*, Lett. *pludet*, AS. *fleostan*, OHG. *fliozzan*, Ger. *fliessen*, to flow; so called because the bird appears during the rainy season). A limicoline bird of the subfamily Charadriinæ, of the large shore-bird family Charadriidæ, having a bill somewhat like that of a pigeon, with a convex horny terminal portion, behind which it is contracted; the legs not very long, naked a little above the tarsal joint; the wings rather long and pointed, the first quill-feather the longest; and usually only three toes. The species are about 60 in number, found in every quarter of the globe, and many are migratory and of very wide range. They chiefly frequent low moist grounds, where they congregate in flocks, and feed on worms, insects, and the like, and some of them are table delicacies. The golden or yellow plover (*Charadrius dominicus*) is 11 inches long, blackish, speckled with yellow at the tips and edges of the feathers; the throat, breast, and belly black in summer, whitish in winter. It is a bird of passage in the United States, breeds in the far north, and winters in Central and South America, going even as far as Patagonia. Some account of its remarkable flights is given under MIGRATION OF ANIMALS. In the Eastern United States it is more common in fall than in spring. It makes an artless nest, little more than a slight depression of the ground, and lays four eggs. The parent birds show great anxiety for the protection of their young, and use various stratagems to divert the attention of an enemy. The ringed plover (*Ægialitis hiaticula*), a much smaller bird, is found in Greenland and the Arctic regions of America, but is most abundant in the northerly parts of the Old World. It occurs at almost all seasons on sandy and shingly flats, from which the sea retires at ebb-tide. It is often to be seen also on the banks of large rivers, lakes, and ponds. It is grayish-brown above, whitish beneath, with a collar of white round the neck, and below it a black—in winter, a brown—collar; the head marked with black and white; a white bar on the wing.



BEAK OF THE GOLDEN PLOVER.

In the United States six species exist, all

PLOVERS

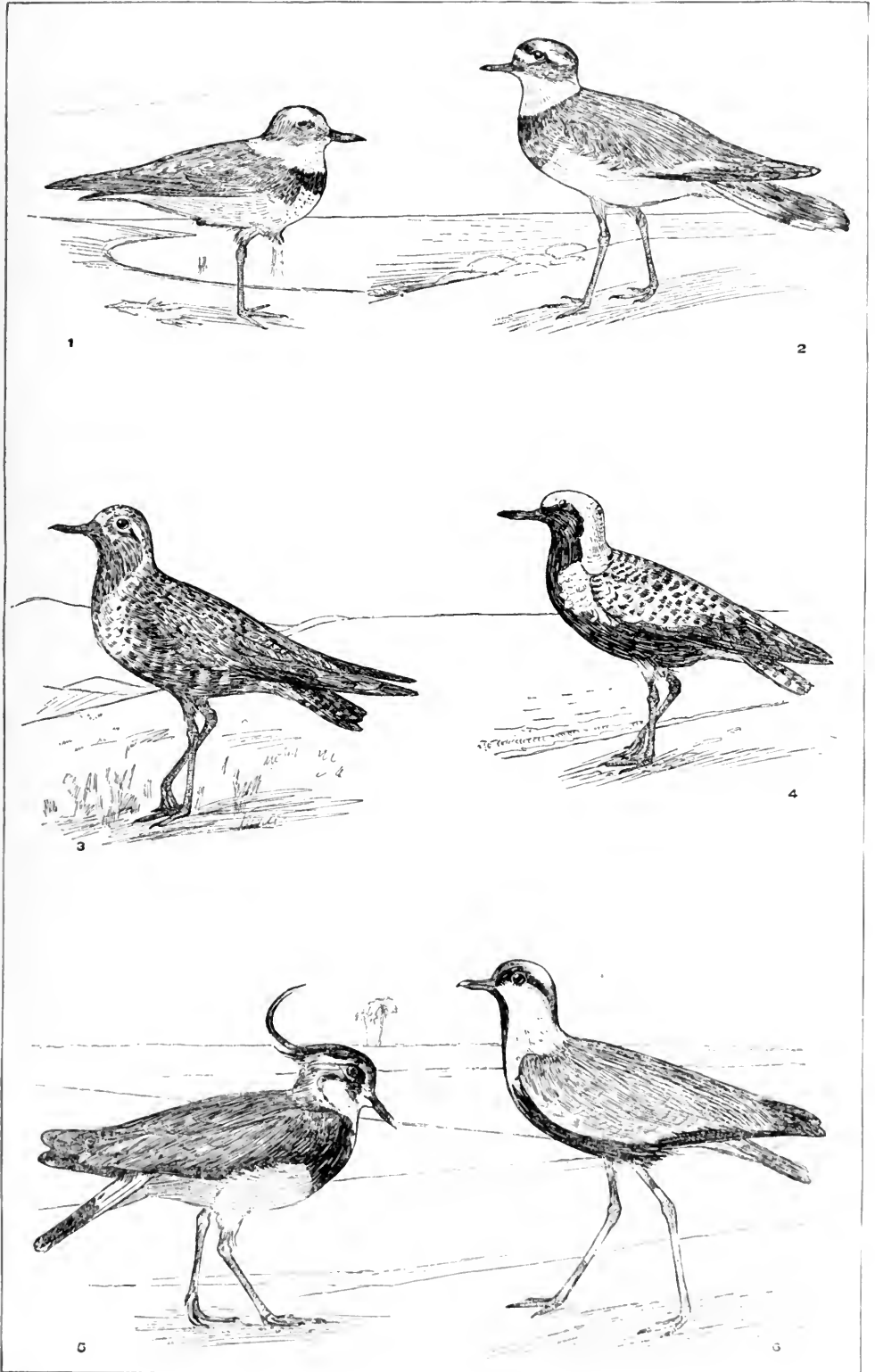

1. WILSON'S PLOVER (*Ægialitis Wilsonia*).
2. KILDEER (*Ægialitis vociferus*).
3. AMERICAN GOLDEN PLOVER (*Charadrius Dominicus*).

4. BLACK-BELLIED PLOVER (*Charadrius squatarola*).
5. LAPWING (*Vanellus vanellus*).
6. EGYPTIAN SPUR-WINGED PLOVER (*Hylopterus spinosus*).



closely resembling the ringed plover, of which the semipalmated or 'ring-neck' (*Egialitis semipalmata*) is the American analogue. The largest and best known is the kildeer (q.v.). The piping plover (*Egialitis meloda*) is found along the Atlantic coast, and is notable for the musical quality of its notes. The snowy plover (*Egialitis nivosa*) is a handsome species found in the Southwestern United States. All of the ring-plovers lay their three or four eggs in a depression in the ground; the eggs vary in color from creamy-white to olive-drab, heavily marked with blackish-brown. In the Western United States occurs the mountain plover (q.v.), which differs from the others in the absence of any black belt or markings on the neutral surface. The 'beetle-head' or black-bellied plover (*Charadrius squatarola*) is a nearly cosmopolitan form, recognizable in any plumage by the small hind toe and the rounded scales on the front of the tarsus. It is nearly a foot long, and in full plumage is a very handsome bird, black and white contrasting in its plumage to make it notable. It breeds in the Arctic regions and winters in the tropics. The bird known to American sportsmen as the 'upland plover' is not a plover at all, but a sand-piper (*Bartramia longicauda*).

Several remarkable birds of this group belong in South America, Africa, and Australasia. One of these is the Egyptian 'spur-winged' plover (q.v.); see also CROCODILE-BIRD.) Another is the strange 'crook-billed plover' of New Zealand. (See WRYBILL.) Closely allied to them are the European and Asiatic 'lapwings,' and the South American 'teru-teru' (q.v.) of the widespread genus *Vanellus*. Consult: Dresser, *Birds of Europe* (London, 1881); Seebohm, *Birds of Asia* (ib., 1888); Buller, *Birds of New Zealand* (2d ed., ib., 1888); Shelley, *Birds of Egypt* (ib., 1872); Sharpe and Hudson, *Argentine Ornithology* (ib., 1888); Walsingham, "Shooting," in *Badminton Library* (ib., 1889); Elliot, *Shore Birds of North America* (New York, 1895); Lefringwell, *Shooting on Upland, Marsh, and Stream* (Chicago, 1890). See Plate of EGGS of WATER and GAME BIRDS; and Plate of PLOVERS.

PLOW, PLOWING (AS. *plōh*, OHG. *pfluoh*, Ger. *Pflug*, plow; connected with Longobardic *plorum*, and possibly with Gk. *γλωχιν*, *glōchin*, projecting point). In all countries where agriculture is in an advanced state, the first agricultural operation in order and importance is the breaking up of the soil by inverting the upper stratum of earth upon which the plants grow. Such an operation also buries and destroys weeds; leaves the surface clean, unencumbered, and in a condition favorable for weathering; increases the storage capacity of the soil for water; but also assists percolation and thus aids in drying and warming the soil.

To the unobservant, the plow seems a simple and even primitive tool; yet it is the product of slow evolution and much mechanical skill. The plow in primitive form probably antedates history. The Old Testament mentions plows shod with iron or bronze, but except in Western Europe and America little progress has been made in improving the implement since the time of Herodotus. One of the earliest types of plows is shown in Fig. 1; a type of the ordinary modern plow in its simple form in Fig. 2. As will be seen, the modern plow consists of several parts—

a beam, by which the plow is drawn, which may be of wood or metal; two handles, usually wood, for guiding. To the end of the beam a clevis or bridle is attached for convenience in hitching the team and regulating the depth and width of furrow, and near the outer end a small adjustable wheel (frequently omitted) for assisting in steadying the plow and regulating the depth of the furrow. Behind this is a coulter for cutting the furrow slice at the side. This coulter takes various forms—a miniature plow or jointer, a stout iron knife, or a revolving disk with sharp edge. Back of the coulter is the plow proper, consisting of a strong cast-iron frame (standard or sheath) firmly fastened to the beam and braced by the handles in rear. To this frame

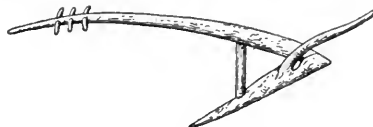

FIG. 1. PRIMITIVE PLOW.

is attached a pointed share for cutting the furrow slice at the bottom, a mold-board for turning the furrow slice, and the land-side opposite the mold-board, which presses against the side of the furrows and helps to steady the plow.

The first patent for a plow is said to have been obtained by Joseph Foljamb in 1730, and Jethro Tull about this time invented a plow designed especially to pulverize the soil thoroughly, an idea embodied in modern plows of the best

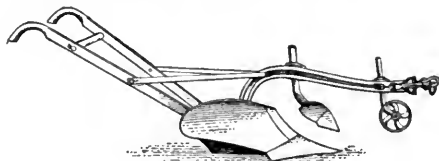

FIG. 2. AMERICAN PLOW.

type. Figure 3 shows the Rotherham plow used in Holland at the beginning of the eighteenth century, and afterwards introduced into England.

In attempts to improve the plow the mold-board, which raises and turns the furrow slice and which appeared in the plows of the Netherlands during the seventeenth century, has probably received more attention than any other single part. Thomas Jefferson, who published his views in 1798, and James Small in 1802, were among the first to attempt to establish the proper lines of the mold-board upon a mathematical basis.

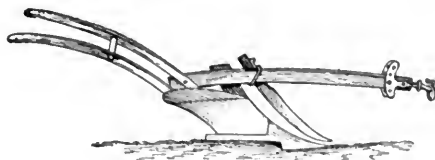

FIG. 3. EARLY DUTCH PLOW.

As determined by the shape of the mold-board, ordinary plows are of two main types, (1) 'sod-plows' with long sloping mold-board which turn a narrow, flat furrow without pulverizing the furrow slice, but which bury vegetation, manure, etc., effectually; and (2) the 'stubble

plows,' with short, steep overbanging mold-board, which break up the furrow slice and pulverize the soil. English plows are generally of the first type. The modern American plow is generally of the second type, although plows of the first type are made and used to a considerable extent for special purposes in America. It may be said to date from September 1, 1819, when Jethro

employed for water-furrowing, etc.; the hillside or swivel plow, which is provided with a reversible mold-board, so that the team may walk in the opposite direction, but always place the furrow against the one previously turned. Another special form of plow is the double-furrow or gang plow (Fig. 4), which consists of an iron frame, usually mounted on a wheel or wheels, carrying two or more plows, one set a little to the rear of the other, and at the distance it is desired the width of the furrow should be. The sulky plow (Fig. 5) has also come into extensive use, the object of such plows being to lessen friction and reduce the labor of the plowman. The draught of such plows, however, was found by Sanborn to be not materially less than that of the ordinary swing plow. The first patent for sulky plows in America was granted to H. Brown in 1844, but practical plows of this type were not made until about 1864, and the manufacture of such plows is still in a state of evolution, although numerous forms are found on the market. The disk plow (Fig. 6), which is a comparatively recent invention, is attracting wide attention on account of its effective work under certain conditions. The principal feature of this plow in its more perfect form is a tempered steel disk

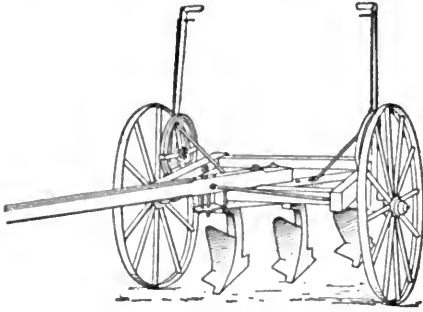

FIG. 4. MOUNTED GANG PLOW.

Wood of Scipio, New York, took out a patent for an improved cast-iron plow having the mold-board (of pulverizing type), share, and land-side cast in three separate pieces so that they could be replaced by new parts when worn. Anderson found that 55 per cent. of the draught of the plow is consumed in cutting the furrow slice, 12 per cent. in turning it, and 33 per cent. by the sole and land-side. Since such a small percentage of the energy required in plowing is consumed by the mold-board, it would seem to be economy to make this of such form that it will disintegrate the furrow slice as completely as possible. Such breaking of the furrow slice makes it easier for the tillage implements following the plow to fine the soil thoroughly without disturbing the buried sod and vegetation. A further important advantage of the work of such plows is the increased opportunity afforded to the soil for weathering.

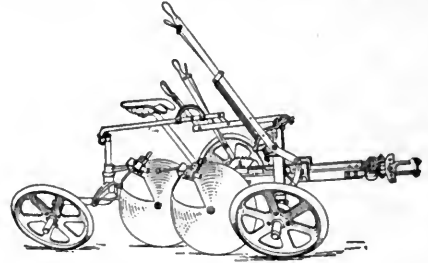

FIG. 6. DISK PLOW.

25 to 30 inches in diameter, and usually set at an angle to the furrow and to the surface so as to turn and pulverize the soil. It is kept from clogging and assisted in pulverizing the soil by an adjustable scraper. The disk is carried by a steel framework mounted on wheels and provided with a seat for the driver and levers for control and adjustment of the plow.

The idea of the use of engines and machinery to plow the ground seems to have originated with David Ramsey and Thomas Wildgosse in 1618, but the motive power they proposed to use is not made clear. Francis Moore in 1769 first attempted to use the steam-engine for this purpose. The history of practical steam plowing dates from the invention of Fowler, assisted by Smith, in 1854. The inventions along this line have included plans for engines traveling over the surface of the ground, drawing plows or other cultivating implements along with them; engines working on tramways, and drawing implements after them; engines moving along opposite headlands, and working implements between them by means of wire ropes and stationary engines driving implements also by means of wire ropes. The steam plows used most widely in England belong to two classes—double-engine and single-engine or 'direct' and 'round-about' (Figs. 7 and 8). Gang plows carried on wheels are usually employed in these systems, the plows being in two series facing in opposite directions

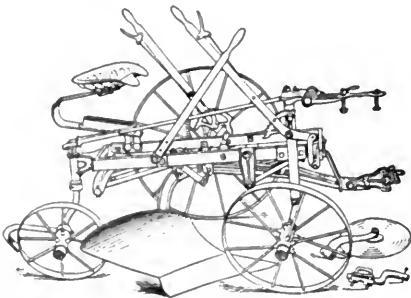

FIG. 5. SULKY PLOW.

There are numerous other kinds of plows used for special purposes, such as trench or ditching plows, which are made on the same principle as the common plow, but larger and stronger, so as to bring up a portion of the subsoil to the surface; or subsoil plows, which have no mold-board, and merely stir and break up the subsoil, thus facilitating drainage. These plows are not used so much as formerly. There are also double mold-board plows, which are merely common plows with a mold-board on each side, em-

and so arranged that when one series is in operation the other is elevated above the soil. The steam plows used in America are of the gang class drawn by a traction engine as shown in Fig. 9. Attention of American inventors has been directed mainly toward developing a cheap, light, and durable engine of suffi-

The time and manner of plowing will be determined by the special object to be attained. In soils more or less impervious to water it is advisable to plow to different depths at different seasons of the year in order to prevent the formation of hardpan, which occurs when plowing to the same depth for several seasons, due to the

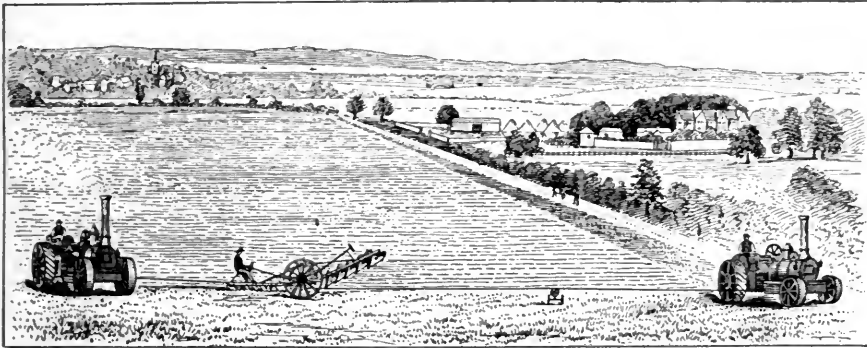

FIG. 7. DOUBLE-ENGINE OR DIRECT METHOD OF STEAM PLOWING.

cient traction and adapted to different kinds of land. On the Western wheat ranches there has, according to Taylor, been "developed a special form of engine for plowing, harvesting, and similar work. These engines have assumed a tri-cycle form, the weight of the boiler and engine

pressure of the plow and the trampling of the teams. If the soil is very pervious it is sometimes desirable to promote this formation of hardpan to arrest a too rapid percolation of water. Plowing promotes aëration of the soil and nitrification (q.v.), and otherwise improves

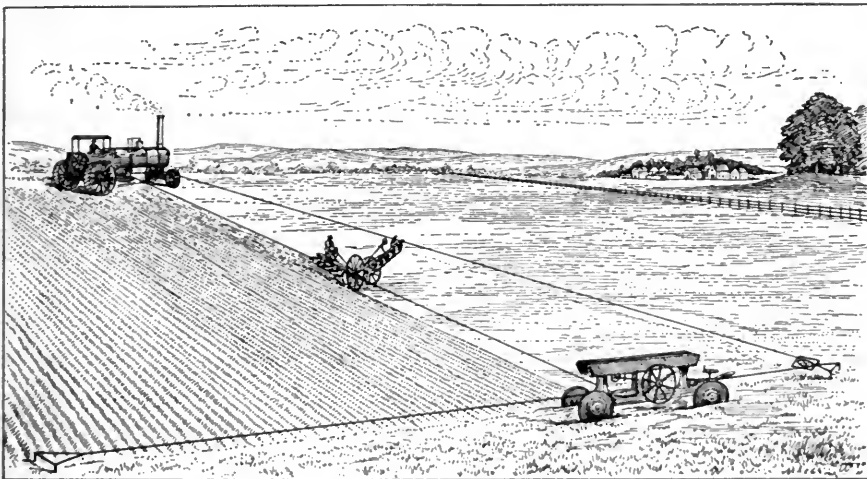

FIG. 8. SINGLE-ENGINE OR ROUND-ABOUT METHOD OF STEAM PLOWING.

resting on two very high, wide tread wheels with a third wheel of castor type in front for easy steering. A high-pressure, force-draught boiler is used, and small, high-speed engines, developing from 40 to 80 horse-power. Such engines draw from 12 to 18 twelve-inch plows, and turn over 25 to 40 acres per day." A system using electricity on the trolley plan has been introduced in Germany with some success. It is claimed for the better systems of steam and electric plowing that they are cheaper and more efficient than the ordinary methods. This may be true where horses and feed are expensive, fuel cheap, and lands level and otherwise well suited to these systems, but that it is universally true remains to be demonstrated.

the physical and chemical condition of soils, resulting in increased productiveness. A deep tilled layer of soil is desirable, but this should be brought about gradually, since the plowing should not be so deep as to bring up raw subsoil. Plowing to a greater depth than 6 or 7 inches is rarely desirable. The time and manner of plowing will be determined by climatic conditions, character of soil, and kind of crop to be raised. Sod may be plowed wetter than stubble land. In midsummer and fall deep plowing is desirable, in early spring rather shallow plowing is usually best. Manures and similar material should not be turned under deeply in the spring. If there is danger of too rapid evaporation, surface tillage should follow very closely

after plowing. Fall-plowed land should generally be left rough. Unless the soil has very good natural drainage the plowed land should have open furrows from 10 to 15 paces apart. Thorough and deep plowing is most economically performed with a large sulky plow with three or more horses (Fig. 5), except when the fields are small.

ment as counsel for those of his own faith, Bishop Bonner being one. His present reputation, however, rests chiefly on a series of reports of trials, *Les Comentaires*, etc. (London, 1571; trans., Dublin, 1792; London, 1816), written in law French, made by him and extending over the entire period of his connection with the bar. They are valuable as a careful and clear record of early

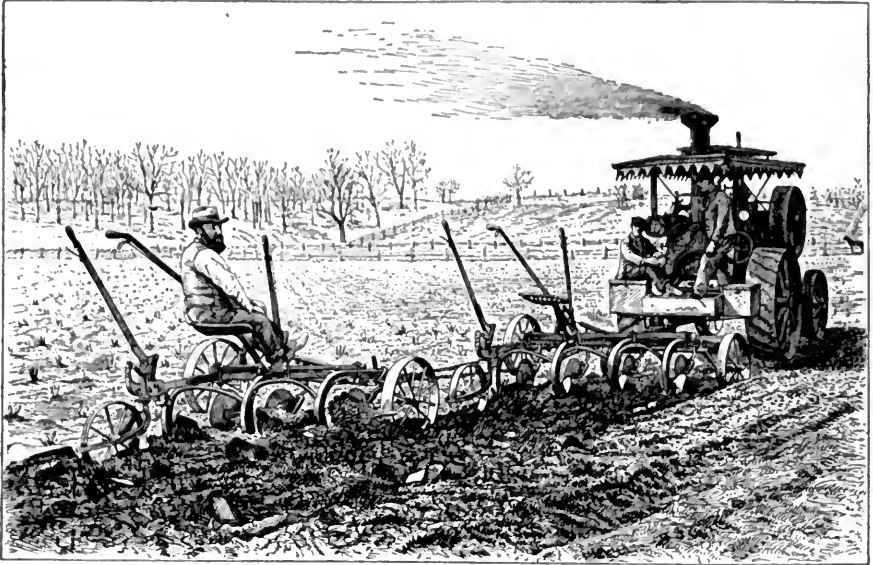

FIG. 9. AMERICAN METHOD OF STEAM PLOWING.

Consult: Roberts, *Fertility of the Land* (New York, 1897); Brooks, *Agriculture*, vol. i. (Springfield, 1901); King, *Physics of Agriculture* (Madison, 1901); Ardrey, *American Agricultural Implements* (Chicago, 1894); Missouri Experiment Station Bulletin No. 32, *Plows and Plowing* (Columbia, 1888); Utah Experiment Station Bulletin No. 2, *Plow Trials* (Logan, 1890); United States Census Report 1860, volume on Agriculture.

PLOW'DEN, EDMUND (1518-85). An English jurist. He was born at Plowden, Shropshire; studied at Cambridge for three years, and in 1538 entered the Middle Temple, where after several years of close application to legal studies he was called to the bar. He took an active part in public affairs, and was one of the council of the Marches of Wales in the first year of Queen Mary's reign, and later sat several times as a member in Parliament; he was one of the 39 who, in 1554-55, withdrew from Parliament because dissatisfied with its proceedings, and against whom the Attorney-General filed informations. Plowden defended his case, and the matter was dropped. Upon the death of Mary and the accession of Elizabeth, Plowden failed to receive any further political preferment because of his faithful adherence to the Roman Catholic Church; but he retained his reputation as the greatest lawyer of his day and a most fearlessly upright public man. During his early career he was twice a reader of the Middle Temple, and he was its treasurer at the time when its present fine library was begun. (See *INNS OF COURT*.) He frequently appeared in court against the Govern-

precedents, and for the light they throw upon early legal procedure and development. Besides these he wrote *Les Quares del Monsieur Plowden* (London, trans., 1662). Consult: Fuller, *The Worthies of England* (London, 1662); Granger, *Biographical History of England* (1824); Wallace, *The Reporters* (Boston, 1882); and such books as Strype, *Works*; Murdin, *State Papers*; Jones's *Index*, etc.

PLOWMAN'S TALE, THE. A rhyming ballad by an unknown poet, written about 1395, printed as a Canterbury tale in Thynne's second edition of Chaucer, 1542. It is a denunciation of Roman Catholicism in the story of a dispute heard by a plowman between a griffin (Rome) and a pelican (Lollardism).

PLOW MONDAY, or ROCK MONDAY. The name of the Monday after Twelfth Day, or the close of the Christmas holidays, when the work of the plow is supposed to start again. In England in some places the day is devoted to rustic sports. A plow is dragged from door to door by plowmen, who ask for contributions.

PLOYESHITI, plô-yësh'té, or **PLOESTI** (Rum. *Ploesci*). A town of Rumania, capital of the District of Prahova, 38 miles north of Bucharest (Map: Balkan Peninsula, F 2). It is advantageously situated in a petroleum-bearing district and is rapidly increasing in commercial importance. Its educational institutions include a lycée, a school of arts and crafts, an institution for teachers, and a commercial school. Ployeshiti is an important military centre. Population, in 1900, 42,687.

PLÜCKER, plük'ër, JULIUS (1801-68). A German mathematician and physicist, born at Elberfeld. After holding positions at the universities of Halle and Berlin he became professor of mathematics at Bonn (1836). Plücker produced works of very great importance in the field of analytic geometry. In his *Analytisch-geometrische Entwickelungen* (2 vols., 1828, 1834) he developed the dual relation between modern analysis and pure geometry. The *System der analytischen Geometrie* (1835) deals extensively with the classification of cubic curves. His *Theorie der algebraischen Curven* (1839) contains the famous 'six equations' relating to the singularities of higher plane curves. (See CURVE.) This was followed by his *System der Geometrie des Raumes in neuer analytischer Behandlung* (1846; 3d ed. 1852). From 1847 onward Plücker devoted his attention to physics, and he became professor of this science at Bonn. He devoted his attention especially to the magnetic properties of gases and fluids, to the electric luminosity of rarefied space, and to the phenomena of the spectroscope and the Geissler tubes. In 1865 Plücker once more turned his attention to mathematics and invented what is now called line geometry. He died before he had finished the publication of a work on this subject, containing his theory of 'complexes' and 'congruences' (see CONGRUENCE), but it was completed by his pupil and assistant, Klein, under the title *Neue Geometrie des Raumes gegründet auf die Betrachtung der geraden Linie als Raumelement* (1868-69). His scientific memoirs were published in the *Proceedings* of the Royal Society of Science at Göttingen. He was also a contributor to the *Philosophical Transactions* of the Royal Society. Among the papers contributed are: "On a New Geometry of Space" (1865, vol. 155); "On the Magnetic Induction of Crystals" (1858, vol. 148); "On the Spectra of Ignited Gases" (1865, vol. 155). Consult: Clebsch, *Zum Gedächtnis an J. Plücker* (Göttingen, 1872); Dronke, *Julius Plücker* (Bonn, 1871). His *Gesammelte Abhandlungen* have been published in two parts by the Royal Society of Göttingen (Leipzig, 1895-96).

PLUM (AS. *plūme*, *plyme*, OHG. *pflūmo*, *prūma*, Ger. *Pflaume*, from Lat. *prunum*, plum, *pruna*, plum-tree, from Gk. *πρῶνον*, *prounon*, *πρῶνον*, *prounnon*, plum, *πρῶνη*, *prounē*, *πρῶμηνη*, *proumnē*, plum-tree). Small trees or shrubs belonging to the genus *Prunus*, and extensively cultivated as orchard fruits in temperate regions. The fruit is distinguished from the peach, its near relative, by its smooth skin and unwrinkled stone. It is larger than the cherry and is further distinguished from it by the bloom covering it. There are three main groups of widely cultivated plums: (1) Domestic or European plum (*Prunus domestica*); (2) Japanese plum (*Prunus trifoliata*); and (3) native American plums, cultivated only in America having been derived largely by selection during the closing years of the nineteenth century from numerous native species, the most important of which are: Americana types, from *Prunus Americana*, commonly found from the Atlantic west to the Rocky Mountains and south to the Gulf; the Wild Goose or Hortulana types, from *Prunus hortulana*; and Chickasaw types, from *Prunus angustifolia*. The domestica varieties

were the first plums cultivated in the United States. They thrive in the regions north of Pennsylvania and west to the Great Lakes and on the Pacific Slope, where the American prune industry has reached its greatest development. The European plum (*Prunus domestica*) is native to Eastern Europe and West-Central Asia. Another plum native to Southern Europe and extensively grown as a stock is the myrobolan or cherry plum (*Prunus cerasifera*). There are but very few cultivated varieties of this species. The Japanese plums are native to China. They stand next in commercial importance to the European plums. Many varieties ripen much earlier than the European plums.



WILD PLUM (*Prunus Americana*).

The fruit is very firm and stands shipment well, and the trees are not so susceptible to black knot and the curculio. They were first introduced in America about 1870, and have rapidly become popular in the United States, where they can be grown much farther south than the European plums. There are many varieties of most of the above species of plums now in cultivation, and in addition a large number of named hybrids.

Plums true to variety are propagated usually by budding the seedlings in August or September. Whip grafting is used to some extent and has proved especially valuable in working plums on peach roots. They may also be top-worked in the same manner as apples. Plums, as a rule, do best in a deep rather heavy soil with an open subsoil. The domestica prefer a heavy clay soil, while the Japanese varieties and some of the hybrids may be grown on light sandy soils. Most varieties may be set in the orchard when one year from the bud or graft, but with the European plums two-year-old trees are preferred. Waugh and other investigators have shown that for all practical purposes native American plums and Japanese varieties are sterile to their own pollen and will not produce fruit unless the trees are mixed in the orchard with other varieties. Plums are set in the orchard about 15 feet apart each way. A few varieties require 20 feet each way. Pruning the plum is confined largely to the formation of the head during the first two or three years' growth in the orchard, and afterwards to removing dead and crossed branches. The plum orchard in America is usually plowed in early spring and kept well cultivated until the middle of summer, when it is seeded to some cover crop. In some of the Northwestern States mulching with straw, marsh hay, etc., has been found preferable to cultivation. A moderate amount of barnyard manure applied every second year has been found beneficial in the plum or-

chard, and wood ashes on soils deficient in potash and lime. Most varieties of plums tend regularly to overbear, and thinning has been found necessary to secure the finest fruit, especially with the American varieties. The plums are left to stand two or three inches apart. They are marketed as soon as they become well colored. In the United States the eight-pound grape basket makes one of the most satisfactory packages.

PLUM DISEASES. Plums and cherries are often attacked by the same fungi. Leaf blight or shot hole is due to the presence of one or both of two fungi, *Cylindrosporium padi* and *Septoria cerasina*, in the leaves, the symptoms being alike on both plum and cherry. Circular purplish spots one-eighth inch in diameter appear; later the tissues become brown and break out from the leaves, leaving holes as though made with shot. In severe cases the leaves turn yellow and the trees are defoliated. This disease can be prevented by spraying the trees with Bordeaux mixture at intervals of two weeks from the time the leaves appear until July. Another disease to which the plum and cherry are subject is the black knot or plum knot, due to *Plowrightia morbosa*, which appears as a serious pest only upon sour cherries and upon plums. When mature the black knots are rough wart-like excrescences upon the branches. At first they are yellowish in color, but soon become darker, the surfaces having a velvet-like appearance. This soon disappears and the knots grow still darker, in winter becoming black. The fungus is spread by its spores, which, lighting upon a branch in a crevice in the bark, soon infest the limb. It also remains alive during winter, the mycelium remaining in the twigs and branches. The infested branches should be cut and burned, and where knots are on large limbs or upon the tree trunks they may be cut out or painted with kerosene. After careful pruning the trees may be sprayed during the growing season with any good fungicide (q.v.) to prevent any spores that may find lodgment from germinating. A disease peculiar to the plum is that known as plum pockets, due to attacks of *Exoascus pruni*. The fruit is infected soon after blossoming and begins to swell until it becomes an inch or two in length. At first the 'pocket' is light in color, but finally becomes dark brown or black, and the fruit falls to the ground. It is usually hollow and bladdery in appearance, hence the name. The walls of the fruit are thickened, but it contains no stone or pit. The leaves and stems are also attacked, the affected parts assuming swollen distorted shapes. This disease can be controlled to some extent by thorough use of fungicides. Applications should be made before the buds have opened and again just after the flowers have fallen.

For an account of plum culture in America and descriptions of the varieties grown, consult: Waugh, *Plums and Plum Culture* (New York, 1901); Goff, *Culture of Native Plums in the Northwest* (Wisconsin Agricultural Experiment Station Bulletins 63 and 87); Bailey, *The Cultivated Native Plums and Cherries* (New York, Cornell Experiment Station Bulletin 38); id., *The Japanese Plums in America* (ib., Bulletins 62, 106, 139, and 175); Waugh, *The Pollination of Plums and Hybrid Plums* (Vermont Experiment Station Bulletins 53, 67, and 75, and references for 1896-1901). See Colored Plate of DRUPES.

PLUM, BEACH (*Prunus maritima*). A species of plum growing upon the Atlantic coast from New Brunswick to Virginia, and appearing again in Michigan along the lake. As a class beach plums are of little value for their fruit, a single named variety only being listed. For ornament, however, the group has greater merit, as the blossoms are rather large and showy and the fruits are of high color when ripe.

PLUM, DATE. See PERSIMMON.

PLUMBAGO. See GRAPHITE.

PLUMBING (from *plumb*, from OF. *plomb*, *plom*, Fr. *plomb*, from Lat. *plumbum*, lead). In its broadest sense, the pipes and fixtures within houses or other buildings used to supply water, gas, and heat, including in the latter steam and hot water, and also the pipes used to remove liquid wastes from buildings; or the mechanic art of providing the pipes and fixtures named. A more restricted and more common use of the term includes only the water supply and house drainage systems, leaving gas fitting and steam and hot water fitting in two separate classes. (See GAS, ILLUMINATING; and HEATING AND VENTILATION.) The early plumber worked in lead, providing pipe systems for water supply, applying sheet lead for roof coverings and setting window glass. Later lead pipe was adopted for other purposes, notably for gas services, and for removing household wastes. Hence the name plumber, originally applied to a worker in lead. Later yet lead was largely replaced by other metals. (See PIPES.) To-day the plumber and the gas, steam, and hot water fitter employ lead, wrought-iron, brass, copper, and the various kinds of plated pipe, including nickel-plated goods. Vitrified clay or sewer pipe is not used in good plumbing, at least not in buildings, but vitrified pipe is almost wholly used to connect the house and street sewerage systems.

WATER SUPPLY. The pipe leading from the street main to the building is called the house

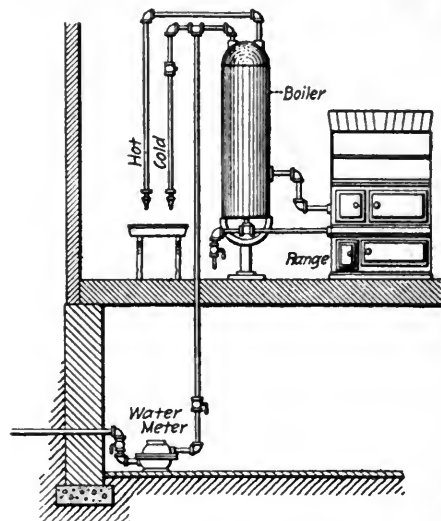

KITCHEN BOILER AND CONNECTIONS.

connection or *service pipe* and is frequently laid, at least as far as the curb or sidewalk line, by the water department. The service pipe, and the water pipe system within the house as well, may

be of lead or wrought iron; or if the building be large, the main piping may be of cast iron. In highly finished, expensive work, brass or nickel-plated pipe is sometimes used, and copper may be employed for hot-water piping. As some waters attack and decompose lead and give rise to lead poisoning, the materials for services and house piping should be chosen accordingly. (See SANITATION and WATER-WORKS.) A valve at the sidewalk enables the water department to turn on or shut off the water to the consumer at will, and another valve, just inside the cellar wall, permits the householder to control the house supply from that point also. The water

butler's pantry, and, in large houses and semi-public and public buildings in various other places. Most commonly they are of iron, and have hot and cold water. *Laundry tubs* are placed in a separate room or in the kitchen, and consist of two or more rectangular compartments, with the front side sloping, provided with hot and cold water, and composed of soapstone, artificial stone, cement, iron, or other material, with or without hinged wooden covers. The chief essential in the material for laundry tubs is lack of porosity, on which account wood, with its high absorbing quality, is unsuitable. *Set wash bowls* are provided in bathrooms and lav-

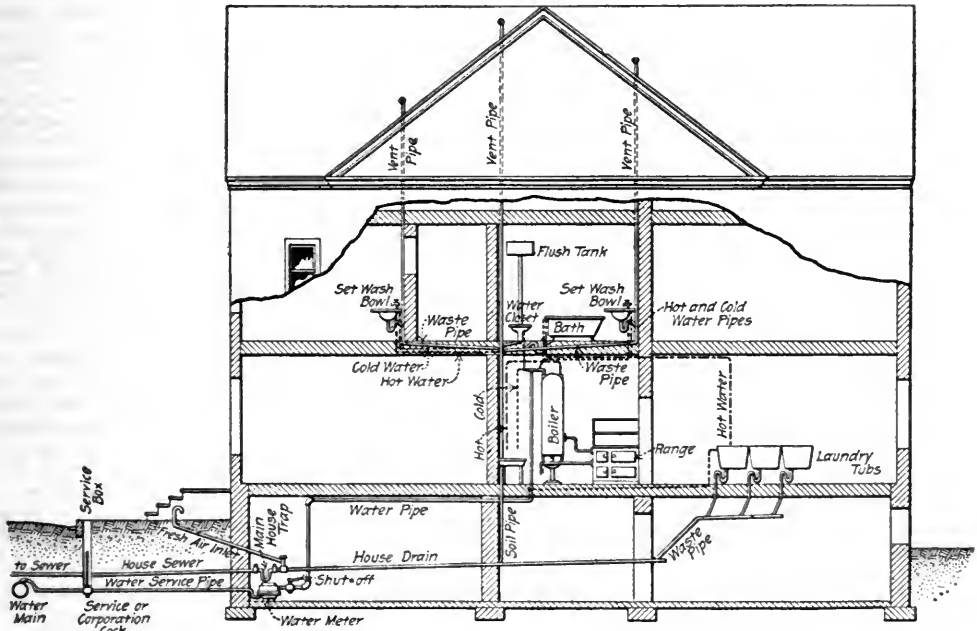

WATER SUPPLY AND DRAINAGE OF A DWELLING.

meter, if employed, is generally placed just inside the latter shut-off valve. Except in the smaller and cheaper houses the water piping is mostly in duplicate, one set of pipes being for hot and one for cold water. The water is heated by circulating through a pipe or a *water back* at the rear of the kitchen range, from which it goes for storage to the kitchen or range boiler. These boilers are made of wrought iron, steel, or copper, with riveted joints, and should be tested to withstand a high pressure. When the water supply is liable to be inadequate at times, or when the direct pressure is too heavy for safety to the plumbing, a *tank* is provided in the upper part of the building. Great care is necessary to secure and maintain water-tightness. Tanks must be provided with automatic valves to insure a constant supply therein, and to prevent water going to the tanks when full; also with overflow or waste pipes.

FIXTURES. The various faucets, sinks, and other similar appliances connected with a plumbing system are called fixtures. *Faucets, cocks, or valves* are provided at each place where water is to be drawn. (See VALVES.) It is important that these should be of high grade to prevent leakage. *Sinks* are provided in the kitchen, the

atories, in the private rooms of hotels, and sometimes, but less frequently than formerly, in the sleeping rooms of private dwellings. Probably they are most commonly of marble, but cast iron and steel, both painted and enameled, and porcelain are also employed. *Bathtubs* are of polished sheet copper, formed on wood, of solid copper, of painted or enameled cast iron, and of porcelain. *Shower baths, sitz baths, and foot baths* are for the special purposes indicated. *Water-closets*, so called because matter deposited into them is flushed out by a discharge of water, are most commonly of glazed earthenware, although in cheap work cast iron is sometimes used. The old-fashioned pan water-closet was one of the most unsanitary of all plumbing fixtures, and thousands are still in use. It consisted of a metal pan, hinged so as to drop downward and discharge its contents into the pipe with which it was connected. It was a centre for filth and bad odors, and is no longer tolerated where sanitary principles are understood. The valve and plunger closets, operated as indicated by their names, were but little better, and are also out of date. Most of the approved forms of water-closets now in use depend for their action upon the sudden discharge of a few gallons

of water, generally from a tank located above the closet. The discharge is generally effected by pulling a hanging chain attached to a lever and valve, but in the case of closets in public places the tanks may discharge automatically. Recently, however, attachments have been introduced by flushing water-closets without the use

lighted, ventilated, and warmed. *Sill or hose cocks* are faucets or valves, with a provision for attaching hose, provided at convenient points for sprinkling lawns and washing sidewalks. In some localities they, or the hose so used, are called *pave washes*.

HOUSE SEWERAGE or DRAINAGE includes everything required to remove fouled water from the house to the sewer. The pipes from each separate fixture are known as *waste pipes*; they run to one or more *soil pipes*, the soil pipe being the vertical run of pipe from the highest fixture to the cellar; the *house drain* extends from the foot of the soil pipe to a point near the cellar wall, and the *house sewer* from the latter point to the street sewer. Waste pipes, particularly short runs from washbowls and minor fixtures, may be of lead, but, generally speaking, cast or wrought iron is preferable for important wastes. All soil pipes and the house drain should also be of cast iron. Heavy pipe should be used throughout. The house sewer should be of extra heavy iron through and a short distance beyond the foundation, after which vitrified clay is permissible. All soil and waste pipes should be carried up through the roof. Traps are placed below each fixture and a main trap is generally set just inside the cellar wall. All main traps should have *fresh air inlets* or a pipe extending from the inner end of the trap to the outer air. This provides for a circulation of air through the house drain and soil pipe. An increasing number of sanitary engineers favor the omission of the main trap, thus insuring a thorough ventilation of the house and street sewerage system through the numerous soil pipes at one extremity and the street manholes at the other. The object of a trap is to prevent foul air from the house or street sewerage system from entering the house. To this end the simplest and most common practice is to form a water seal by making a bend in the pipe shaped like the letter U or like the letter S, the former being called a U-trap and the latter an S-trap. *Bell traps* are formed by inverting a bell or cup over the upper and open end of a pipe, the whole being so adjusted that the edge

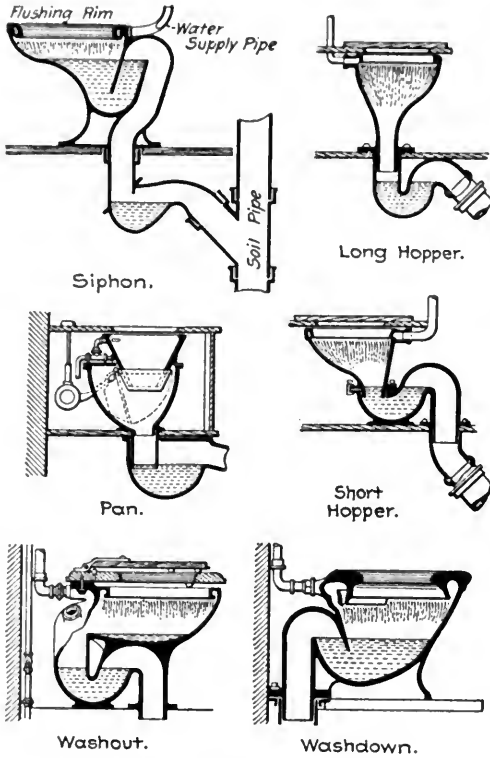

TYPES OF WATER-CLOSETS.

of a tank, the water supply being controlled by a valve, operated by a short lever, near the closet seat. In either case the water thus liberated displaces the water previously standing in the bowl or hopper of the closet or else sets it in motion by siphonic action, carrying the wastes with it. By this means the closet is kept fairly clean, particularly the most exposed portions, and the parts not thoroughly clean are always wet. There is an almost endless variety of closets. Some of the most approved patterns are shown in section by the accompanying illustrations. Water-closet *flush tanks* are generally of wood, lined with copper, and provided with a float valve, a water supply, and a flush pipe. The closet seat is of hard wood. *Urinals* are provided in public places, and consist of either bowls or vertical slabs of non-porous material, inclosed in stalls and provided with flushing water. *Latrines* are a series of water-closet stalls connected with a long trough or common flushing chamber below. They are chiefly employed for barracks and institutions. The terms *bathroom* and *water-closet* are frequently employed to designate the compartments which contain a bathtub, water-closet, and set washbowl. Such rooms should always open to the outer air, or at least into a large air-shaft, and be well

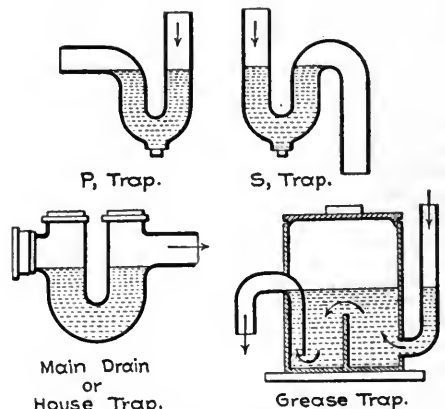

TYPES OF TRAPS.

of the pipe is always submerged. *Grease traps* may be described as enlargements on waste pipes to retain grease instead of allowing it to pass on and clog the sewers. They are most commonly used on the waste or drain pipes of large

kitchens. *Vent pipes* were formerly run from the back of each trap to a connection with the outer air, to give a back air pressure on the trap and lessen the danger from siphonage. Obviously, such a pipe from every trap greatly complicates a plumbing system, and trap vents are now omitted on much of the best work in the United States. Regarding the omission of both main traps and trap vents it should be said that there is little need for them on well designed and built house and street sewerage systems, because the wastes are speedily removed and in well-ventilated sewers the air is comparatively good.

GENERAL CONSIDERATIONS. Simplicity, accessibility, a high grade of material throughout, heavy weights for pipes, and good workmanship are the essentials of plumbing. To secure these, plumbing should be designed only by the most competent sanitary engineers, and should be under the rigid supervision of efficient municipal inspectors. All plans for plumbing should be filed with the plumbing inspector or health department. The hydraulic pressure test should be applied when the rough plumbing has been completed, and the smoke or peppermint test when the fixtures are set.

BIBLIOGRAPHY. Gerhard, *Sanitary Engineering of Buildings* (New York, 1899), and *House Drainage and Sanitary Plumbing* (New York, 1882); Chapin's *Municipal Sanitation in the United States* (Providence, 1901) is valuable on account of its extracts and summaries based on plumbing ordinances. See GAS; HEATING AND VENTILATION; SEWERAGE; WATER-WORKS.

PLUM CURCULIO. A weevil (*Conotrachelus nenuphar*) especially injurious to the plum. See PLUM INSECTS.

PLUME, CAPTAIN. The leading character in Farquhar's comedy *The Recruiting Officer*; a dashing soldier who marries Sylvia, an heiress, and leaves the service.

PLUMED KNIGHT. A nickname of James G. Blaine, first given by Colonel Robert G. Ingersoll in 1876, in nominating Blaine for the chairmanship of the Republican convention. The phrase became a favorite nickname, and Blaine was thereafter regularly depicted in cartoons under this character.

PLUME MOTH. A moth of the family Pterophoridae, a group of wide distribution and probably numerous in species, but the insects are very small and very delicate and are seldom collected. The wings are usually divided after the fashion of a hand into fingers, so as to form feathers. The hind wings are more completely divided than the front, which sometimes are not parted more than once or twice. There is much variety in the habits of the larvæ and pupæ; some are covered with hair and live exposed upon leaves, and some have hairy pupæ, while in some cases there is a slight cocoon. Some larvæ are curiously armed and protectively colored. About 65 species are known in the United States. One of the commonest forms (*Oxyptilus perisceledactylus*) is yellowish-brown in color. The larvæ hatch in the spring and feed upon the leaves of the grape, of which they fasten several together. The caterpillars live either singly or in companies of two or three in such habitations, changing to pupæ early in June.

The species of the family Orneodidae are also included in the term 'plume moth,' since the

wings are divided as in the Pterophoridae, but much more greatly divided, each wing being split into six plumes. Only one species (*Orneodes hexadactyla*) occurs in the United States, and it is also found in Europe and Canada.

PLUM'ER, WILLIAM SWAN (1802-80). An American clergyman. He was born at Griersburg (now Darlington), Beaver County, Pa., graduated from Washington College, Virginia, in 1822, and studied divinity at Princeton Theological Seminary. In 1826 he was licensed to preach, receiving his ordination as evangelist the following year, and from the beginning of his licentiate till 1829 he labored as evangelist in Virginia and in North Carolina. He then became pastor of the Tabb Street Church, Petersburg, Pennsylvania, and held successive pastorates at Richmond, Baltimore, and Allegheny. From 1865 to 1867 he was pastor of the Second Church, Pottsville, Pa. For eight years succeeding 1837 he owned and edited *The Watchman of the South* (Richmond, Va.). From 1854 to 1862 he held a professorship in the Western Theological Seminary, Allegheny, Pa., and from 1867 to 1880 in the Theological Seminary at Columbia, S. C. He published over twenty-five volumes, including commentaries on the Psalms, Romans, and Hebrews, and sermons, tracts, and pamphlets in large number.

PLUMIER, plu'myá', CHARLES (1646-1704). A distinguished French botanist, born at Marseilles. He studied botany under the celebrated Joseph de Tournefort (q.v.), and in 1689 visited the West Indies. On his return he published *Description des plantes de l'Amérique*, with numerous plates (1693). At the King's request, he twice again visited North America in 1693 and 1695. In 1703 appeared his *Nova Plantarum Americanarum Genera*. When about to sail the fourth time for America, in order to investigate the subject of Peruvian bark (cinchona), he died at Cadiz. A work that is still often consulted is his treatise on the ferns of America, which appeared in the year after his death. It contains 172 engraved plates. He wrote extensively in miscellaneous publications on the plants, birds, and fishes of America. A genus of South American plants, *Plumeria*, several of which are cultivated for their fragrance, was named by Tournefort in his honor. See Haller's *Bibliotheca Botanica*.

PLUM INSECTS. The most notable of the insects which damage the plum in the United States is the plum curculio (*Conotrachelus nenuphar*), a species which for many years has destroyed almost the entire crop over large sections of the country. It is a small, rough, grayish or blackish beetle, about one-fifth of an inch long, with a black, shining hump on the middle of each wing case. The female lays her eggs in the young fruit shortly after they are formed, making with her long snout a small cut through the skin, running in the snout to a depth of about one-sixteenth of an inch. In this cavity the egg is placed. She then cuts a crescent-shaped slit through the skin in front of the hole so as to undermine the egg and leave it in a flap, the object being apparently to cause the piece around the egg to wilt and thus to prevent the growing fruit from crushing the egg. The larva is a white, footless grub which feeds upon the flesh of the fruit, feeding for the most part about the

stone. It reaches full growth in from three to five weeks. The fruit meantime has become diseased, and has fallen prematurely to the ground. The larva leaves the fallen fruit, enters the ground to a depth of from four to six inches, and transforms to pupa in an earthen cell, issuing in from three to six weeks in the adult condition. The insect is single-brooded and hibernates as an adult. The beetles emerge from hibernation when the trees are about to blossom, feed for some time by puncturing the twigs and buds, and lay their eggs in the fruit soon after it is formed. The best remedies consist in spraying the trees with an arsenical mixture during the feeding-time of the beetles, and afterwards in jarring them, causing the beetles to fall from the branches, when they are caught in cloth receptacles and destroyed. This jarring method is carried on with great success in some of the largest orchards in the country.

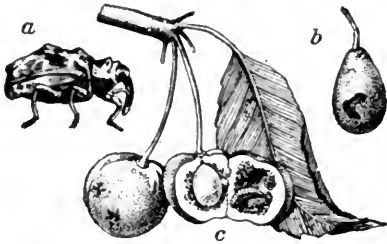

PLUM CURCULIO (*Conotrachelus nenuphar*) AND ITS WORK. a, Adult beetle; b, a young plum attacked by the larva; c, cherry affected by the larva.

Very few other insects are specifically connected with the plum. The larva of one of the sphinx moths (*Sphinx drupiferarum*) feeds upon the foliage, and a number of other species are found more or less abundantly eating the leaves. None of them, however, are ever sufficiently abundant to cause marked damage. As mentioned under PEACH INSECTS, the peach-tree borer sometimes attacks the trunks of plum trees. Another weevil occasionally damages the fruit, and this species, the 'plum gouger' (*Coccotorus scutellaris*), is especially abundant in parts of the West. It appears in the spring, about the same time as the plum curculio, but, instead of cutting a crescent-shaped flap, bores a round hole in the fruit like the puncture of a pin. The larva, instead of feeding around the stone of the fruit, works its way through the soft shell of the stone and feeds upon the kernel.

Consult Saunders, *Insects Injurious to Fruits* (Philadelphia, 1889).

PLUMMER, CALEB. A poor old toy-maker in Dickens's *Crieket on the Hearth*, who pretends to his blind daughter Bertha that he is young and happy, and that their wretched home is a palace.

PLUMPTRE, plümp'trê, EDWARD HAYES (1821-91). An English scholar. He was born in London, August 6, 1821; educated at University College, Oxford; became fellow of Brasenose in 1844; was chaplain at King's College, London, 1847-68; professor of pastoral theology there, 1853-63; professor of the exegesis of the New Testament, 1864-81; assistant preacher at Lincoln's Inn, 1851-58; prebendary of Saint Paul's, 1863-81; Boyle lecturer, 1866; became rector of Pluckley, 1869, and vicar of Bickley, 1873; was one of the Old Testament company of revisers

appointed by Convocation, 1869-74; became Dean of Wells, 1881. Besides volumes of verses, *Lazarus and Other Poems* (1864), *Master and Scholar* (1866), *Things New and Old* (1884), he published poetical translations of Sophocles (1865), Æschylus (1868), and of Dante's *Divina commedia* and *Canzoniere* (1886-87), the latter particularly helpful in its notes. In prose, besides contributions to various commentaries, dictionaries, and periodicals, he wrote *Christ and Christendom* (1867); *Biblical Studies* (1870); *Movements in Religious Thought: Romanism, Protestantism, and Agnosticism* (1879); *The Spirits in Prison* (1884); *Life and Letters of Bishop Ken* (1888); and *Wells Cathedral and Its Deans* (1888). He died in Wells, February 1, 1891.

PLUNK'ET, WILLIAM CONYNGHAM (1765-1854). A British advocate, orator, and statesman, born at Enniskillen, Ireland. He graduated at Dublin University in 1784, studied law in London, was called to the bar in Ireland (1787), and made King's counsel ten years later. He sat in the Irish Parliament for the last two years of its existence (1789-1800), and was denounced as a renegade when he became Solicitor-General (1803). Attorney-General for Ireland in Pitt's Government (1805), he was elected in 1807, and sat again in 1812-22 in the English House of Commons, where he made his mark as the most eloquent Protestant pleader for Catholic emancipation. Once more Attorney-General for Ireland (1822), he became a peer and Chief Justice (1827) and was Lord Chancellor of Ireland from 1830 until 1841, when he retired. Consult the memoir by F. Douglass How (New York, 1901).

PLURALISM (from *plural*, OF. *plurel*, Fr. *pluriel*, from Lat. *pluralis*, relating to many, from *plus*, OLat. *pleor*, more; connected with Gk. *πλεων*, *pleiōn*, more, *πολυς*, *polys*, much, many, Skt. *puru*, OPers. *paru*, OIr. *il*, Goth., OHG. *filu*, Ger. *viel*, AS. *fedu*, archaic Eng. *feel*, many, and ultimately with Eng. *full*). In canon law, the possession by the same person of two or more ecclesiastical offices, whether of dignity or of emolument. Pluralism has been held unlawful from the earliest times, and is forbidden by many ancient councils, as Chalcedon (451) and the second of Nicea (787), on the ground of the impossibility, in ordinary cases, of the same individual adequately discharging the duties of more than one office. The rule by which dispensations from the law of residence are to be regulated, as well as the penalties for its violation, whether on the part of the patron or on that of the recipient, have formed the subject of frequent legislation. In general, it may be said that the canon law regards as incompatible (1) two benefices each having the cure of souls; (2) two 'dignities'; (3) a 'dignity' and a cure of souls; (4) a cure of souls and a simple benefice requiring residence. In other cases than these the Pope is held to have the power of dispensing. Although a constant effort was made to prevent abuse, the evasions of the law were formerly frequent, especially for noble or learned persons, but now are very rare in the Roman Catholic Church. The English law, before the Reformation, in the main coincided with the canon law, and the legislation of Henry VIII. preserved the same general spirit, only substituting the dispensing power of the

Crown for that of the Pope. Consult: Schulte, *Lehrbuch des katholischen und evangelischen Kirchenrechts* (Giessen, 1886); for England, *The Statutes Revised*, vol. viii. (London, 1894).

PLURALISM. In philosophy, a term used to designate any theory that states the universe in terms of more than one ultimate principle. Its antonym is monism (q.v.), when used in the stricter sense.

PLUSH (Fr. *pluche, peluche*, plush, shag, from Lat. *pilus*, hair). A variety of woven cloth, having a long shaggy pile on the upper surface. Although woven like velvet, it differs from it in the greater length of the pile, and in its not being clipped or shorn to a uniform length. Formerly it was made of a double warp, one thread being usually double worsted yarn, the other, intended to form the pile, of goat's hair, and the filling of worsted; occasionally only worsted was used. Now it is made very extensively of silk and cotton, the silk taking the place of the goat's hair to form the pile. This silk plush is the material used for making gentlemen's hats, instead of beaver-hair, as formerly. It is also worked in colored silks, for many articles of ladies' attire. A variety made of mohair is much used for upholstery. Recently the Tussah silk, a wild silk of India, has been extensively used in the manufacture of plush. See WEAVINGS.

PLUTARCH (Gk. *πλούταρχος, Ploutarchos*) (c.46-c.125 A.D.). An encyclopædic writer and a charming type of the Greek gentleman and scholar of Roman times. He was born at Chæronea, in Bœotia, the country of Hesiod and Pindar, to whom he often alludes. His writings introduce us to a pleasant circle of kinsmen and friends, his grandfather Lamprias, his father, brother, and four sons, his wife, Timoxena, to whom he addresses a beautiful 'consolation' on the death of their little daughter, his Roman friends, Sossius Senecio, Metrius Florus, and Junius Arulenus Rusticus. His biography must be collected from his works. He was a student at Athens at the time of Nero's visit to Greece, A.D. 66. Later he traveled in Greece, Egypt, and Italy. He visited Rome more than once, and remained there for some time in the reign of Vespasian, enjoying the friendship of prominent men, lecturing on moral philosophy and gathering the materials for his historical works. Real mastery of the Latin language and genuine insight into Roman institutions he never attained. He established himself for the last of his life at Chæronea, paying frequent visits to Athens, and to Delphi, where he exercised priestly functions. At Chæronea he held the office of archon and that of building inspector, recording his experiences perhaps in the treatise on the precepts of government and the essay on the question whether an old man ought to take part in politics. Greek moral philosophy being at that time the best substitute for religion, he became to many friends and young people a guide, philosopher, spiritual director, and physician of the soul, a rôle which a generation earlier Seneca had assumed with more self-consciousness and display at Rome. He recalled old memories of Rome and Athens in his 'table talk.' He wrote out his old lectures and gave new ones to the young people of an informal school that gathered about him. He composed dialogues in the manner of Cicero rather than of Plato. He continued his historical studies and

published his parallel *Lives* of Greeks and Romans. These, the best known of his writings, have been called 'the food of great souls,' because of their power to kindle emulation in youth, and the enormous influence which, through Amyot, Montaigne, and Shakespeare, they have exercised upon modern literature. Forty-six of them are extant, arranged in twenty-two sets. They cover all classical antiquity from Theseus-Romulus and Lycurgus-Numa to Demosthenes-Cicero and Alexander-Cæsar. They were not composed in the order of chronology or of their present arrangement. There are in addition four single biographies. The formal comparisons that follow most of the pairs are often somewhat forced. They stirred Shakespeare's sense of humor and provoked the delightful parody of Captain Fluellen's comparison of King Henry to Alexander on the basis of the resemblance of Macedon to Monmouth. They may be spurious, as the comparison was a recognized form of rhetorical exercitation. The *Lives* are avowedly character sketches with a moral, rather than severe historical studies. But they belong to the small category of the world's books which are read by all educated men, not merely consulted by scholars, and whose influence spreads in ever widening circles. Our knowledge of antiquity owes more to Plutarch than to any other one writer, and in the loss of his sources it is hardly necessary to add that the *Lives* become our primary authority for countless facts of history.

Hardly less interesting, though less known than the *Lives*, are the multifarious discursive or didactic essays and dialogues (some of them spurious) grouped under the title of *Moralia*. These comprise: The nine books of Table Talk or Symposiaca, a curious illustration of the playful pedantry that was accounted good conversation in later Græco-Roman cultured circles; edifying moral disquisitions enlivened by anecdote and quotation on such topics as "How a Young Man Ought to Read Poetry," "How to Distinguish a Flatterer from a Friend," "On Exile," "On Superstition," "Rules for the Care of the Health," "Advice to the Married," etc.; more elaborate essays or dialogues on religious or philosophical topics—"The Banquet of the Seven Wise Men," "On Isis and Osiris," a chief source of our knowledge of Egyptian religion; "On the Failure of the Oracles," "On the Genius of Socrates," "On the Contradictions of the Stoics," "On the Creation of the World Soul in Plato's *Timæus*." Plutarch's intimate knowledge of Plato lends a certain unity and seriousness of tone to all this discursive literary productivity. He was widely read also in the literature of the Stoics and Epicureans, but mainly to refute them when they diverged from Plato. His religion, too, if we make allowance for the temper of the age and for suggestions derived from later philosophies, is best characterized as a mild, vague Platonic theism. Literal interpreters, insisting on the doctrine of demons and the allegorical mysticism, exaggerate his credulity and superstition. As a true Platonist, he is greatly concerned for edification and shrinks from shocking any genuine religious faith. Hellenic patriotism required him to deal gently with Greek polytheism and the Greek oracles. He makes extensive and fantastic use of the allegorical methods of the Stoics and Philo for the reconciliation of the philosophy with both Hellenic and barbarian

myths. But the method in his hands is often obviously a mere exercise of literary ingenuity. And in the final test he will be found, like all true Platonists, to affirm little if any rigid dogma, and to make no concessions to concrete superstition.

Plutarch's style is that of an intelligent widely read man, familiar with the vocabulary of philosophy and the sciences, and more concerned for his matter than his manner. He does not affect Attic purism, and the tawdry rhetoric of his age has no attractions for him. He died somewhere between A.D. 120 and 130.

BIBLIOGRAPHY. The entire text may be found in the Teubner series, and also in the Didot *Bibliotheca* with Latin translation. Wyttenbach's unfinished 16 volume edition of the *Moralia* with *Index Græcitas* (Oxford, 1795-1830) is indispensable to the student. Gréard's *De la morale de Plutarque* (Paris, 1866) is a readable study. Volkmann's *Leben, Schriften und Philosophie des Plutarch* (Berlin, 1873) is scholarly and exhaustive. See also, Trench, *A Popular Introduction to Plutarch* (London, 1873), and the account in the last volume (on the Provinces) of Mommsen's *History of Rome*. The so-called Dryden's translation of the *Lives* revised in five volumes by A. H. Clough is a stock book. North's version from the French of Amyot was reëdited by Wyndham in 1895. The *Moralia* may be read in the traditional translation revised by W. W. Goodwin (Boston, 1874-78).

PLUTEUS, plū'té-ūs (Lat., parapet, partition, penthouse. In classical architecture, a section of a parapet or a slab filling up the space between two columns; an inclosure around an altar or other low screen.

PLUTO (Lat., from Gk. Πλούτος, *Ploutōn*, wealth). In Greek mythology, the god of riches, son of Demeter and Iasion. According to the legend Zeus blinded him so that he might not be able to discriminate in his gifts, and in the *Plutus* of Aristophanes he appears as a blind old man. In art, however, he was usually represented as a child, and in the arms of some goddess, such as Tyche (Fortune) or Athena Ergane (the Worker) or Eirene (Peace). A copy of the celebrated statue of Eirene and the infant Plutus by the Athenian artist Cephisodotus is to be found in the so-called Leucothea of the Glyptothek in Munich.

PLUTO (Lat., from Gk. Πλούτων, *Ploutōn*, from πλούτος, *ploutos*, wealth). The Roman name for the Greek god of the lower world, properly HADES. Two conceptions may be distinguished. One chiefly prominent in poetry represents him as the grim and implacable ruler beneath the earth; an enemy of all life, invisible, terrible, not to be appeased by sacrifice or prayer. His kingdom, though provided with palace and all else that belong to his state, is gloomy and full of horrors, while from it none ever escape. The other conception seems rather found in some aspects of his cult and in popular belief. It is best expressed through his name Pluto, and considers the ruler of the lower world as the owner and bestower of the products which are hidden in his kingdom, especially of the grain. This aspect seems prominent in the cult of Eleusis, and it is significant that the name Pluto first occurs in Attic poets of the fifth century B.C. Naturally Hades is not prominent in the myths. He was

considered a son of Cronos and brother of Zeus and Poseidon, to whom the depths of the earth and the kingdom of the dead were assigned after the overthrow of the Titans. From the Cyclops he received his cap of invisibility, which belongs to him as the thunderbolt to Zeus and the trident to Poseidon. In his chariot he suddenly burst from the earth and carried off Persephone (see CERES), who became his queen and regularly shared his cult. It should be noted, however, that this cult is directed to Pluto, and to the milder aspect of the god. So far as can be seen only at Pylas in Elis was there a sanctuary of Hades. This was only opened once a year, and then could only be entered by the priest. In art Hades is not a frequent figure, and no distinct type was developed to distinguish him. In general he differs from Zeus only in his expression, which is dark and stern, with his hair hanging heavily over his brows. He is also fully and even heavily draped. Of course in such scenes as the rape of Persephone modifications appear, and sometimes a wolf's head helmet seems to represent the cap of invisibility.

In Rome the worship of Dis Pater and Proserpina was introduced in B.C. 249 in consequence of various omens, and games were held on three nights in the Campus Martius, accompanied by the sacrifice of black cattle. These games, according to the vow, were repeated in B.C. 146, and later were modified by Augustus. The place where the sacrifices were offered was called *Tarentum*, and the altar was twenty feet below the level of the ground and only exposed to view on these occasions. Proserpina may have been an Italian goddess, but this joint cult is certainly of purely Greek origin, and almost certainly borrowed from Tarentum.

PLUTO MONKEY. A West African monkey (*Cercopithecus Pluto*), one of the guenons of Angola, which is distinguished by the reddish-black color of the under parts and generally dark fur. The forehead has a white band and the cheeks bear bushy gray whiskers.

PLUTONIC ROCKS (from Lat. *Pluto*, god of the lower world). The name given to those igneous rocks which have consolidated at considerable depths in the earth and have subsequently been brought to the surface by the denudation and removal of the overlying strata. As a class they are contrasted with the volcanic rocks which have solidified at or near the surface. Most of the coarse-grained igneous rocks, especially granites, are of plutonic origin.

PLUVIOSE, plū vē óz' (Fr., rainy). The name given to the fifth month of the French Republican calendar, beginning on January 20th, 21st, or 22d and ending on February 19th, 20th, or 21st.

PLUVIUS. An epithet of Jupiter as the giver of rain.

PLYMLEY, PETER. An assumed name under which Sydney Smith published a series of vigorous letters in defense of Catholic emancipation (1807-08).

PLYMOUTH, plīm'úth. An important seaport, Parliamentary and county borough, in the southwest of Devonshire, England, 231 miles west-southwest of London (Map: England, B 6). It stands in the Bight of Plymouth Sound between the estuaries of the Plym and Tamar. To

the west is Stonehouse, a township and coast-guard station, and still farther west is Devonport (q.v.), the great naval and military station. United by continuous lines of houses, they form an aggregation known as 'The Three Towns,' which constitutes one of the most important ports in England. Plymouth proper, which covers an area of one square mile, may be called the city, and Devonport the west end; while Stonehouse is an intermediate district, containing chiefly factories, barracks, victualing yards, hospitals, and other institutions. Plymouth extends from Mill Bay on the west to the mouth of the Plym on the east. Its site is somewhat rugged and uneven; an eminence forming the suburbs runs along its northern side, and another eminence, partly occupied by the citadel, fronts the Sound. The chief buildings are the Royal Hotel, comprising an immense inn, assembly-rooms, a theatre, and the athenaeum; the public library, containing in its Cottonian collection 300 sketches by the old Italian masters; Saint Andrew's Church, the tower of which dates from 1490; and Charles Church (1646-58), dedicated to 'Saint Charles the Martyr.' There are several important educational establishments, some of which are endowed, and many charitable institutions. The Guildhall and municipal buildings form a group of handsome Gothic buildings. The city contains an arsenal, a dock-yard, and other Government buildings, and a marine biological laboratory. Mill Bay and Sutton Pool are two small inlets of the Sound, in which lie all the merchant vessels bound for Plymouth proper. Between these inlets, and running along the shore, is the eminence or high plateau of land called the Hoe, embellished with interesting monuments. From this ridge, whence the approach of the Spanish Armada is said to have been first descried, magnificent shore and sea views may be obtained. Its eastern end is occupied by the citadel, which commands the entrance of the Cutwater (the lower estuary of the Plym) and of Sutton Pool. Mill Bay on the west is so deep that vessels of 3000 tons can lie at the pier at low water. The principal industries are ship-building and fisheries; the manufactures are unimportant, the chief being of chemicals, but as a naval station, the centre of the Devonshire and Cornwall trade, and as a holiday and health resort, Plymouth holds a prominent position. It carries on a considerable trade with the West Indies, South America, Australia, the Cape, the Baltic, and the Mediterranean. It has fine docks, harbors, and extensive quays, and a magnificent breakwater completed in 1841 protects the Sound with its spacious inner anchorage. The principal exports are lead, tin, copper, and granite; imports, agricultural products and timber. Plymouth was the first English town incorporated by Act of Parliament, its charter dating from November 12, 1439. It owns the oldest municipal water-works in England, originated in 1585 by Sir Francis Drake, the navigator, then Mayor of the town. It owns also profitable real estate, the Royal Hotel already mentioned, abattoirs, markets, a refuse destructor, the heat of which is utilized to generate electric light and power, electric tramways, suburban artisans' dwellings connected by tramways which carry workmen to any part of the town for a penny, baths, and wash-houses, and maintains free libraries, technical school, museum and art gallery,

the Hoe Park and pleasure grounds, a hospital ship, a borough hospital, and a lunatic asylum. The population of 'The Three Towns' in 1901 was 182,971, having tripled since 1821; that of Plymouth proper was 107,509.

Plymouth, described by Leland as being, in the reign of Henry II., "a mene thing, an inhabitation of fishars," was called by the Saxons Tameorworth (town on the Tamar); after the Conquest it was called Sutton (south town); and it was not till the reign of Henry VI. that it received the name of Plymouth (mouth of the Plym). During the fourteenth and fifteenth centuries it was frequently attacked, and set on fire by the French, and in 1512 an act was passed for the strengthening of its defenses, which since then have been greatly increased, until now the entire shore of the Sound is well defended by cannon, while a cordon of inland forts, constructed at immense cost, surrounds the Three Towns at a distance of from two to three miles. Plymouth witnessed the departure of Drake's noted expedition to circumnavigate the world in the reign of Elizabeth, and her fleet went forth from here to encounter the Spanish Armada. The *Mayflower*, when she sailed for America, landed at Plymouth, whence she finally set sail on September 6, 1620. During the Civil War the town successfully sustained a siege of four years for the Parliamentary cause, and was the first large town to proclaim William of Orange King. Consult: Worth, *History of Plymouth, from the Earliest Period to the Present Time* (Plymouth, 1871); Williams, *Plymouth* (ib., 1898).

PLYMOUTH. A town, port of entry, and the county-seat of Plymouth County, Mass., 37 miles southeast of Boston; extending for 18 miles along Plymouth Harbor, an arm of Massachusetts Bay, and along Cape Cod Bay, and on the New York, New Haven and Hartford Railroad (Map: Massachusetts, F 4). It is the oldest town in New England, having been the landing-place of the Pilgrims. Among the features of interest are the so-called Plymouth Rock, now covered by an open granite structure; Burial Hill and Cole's Hill, where many early settlers were buried; Pilgrim Hall, with its collection of paintings and relics; and the National Monument to the Pilgrims, dedicated in 1889. A statue of "Faith," 36 feet in height, is mounted on a granite base, 45 feet high, and is surrounded by massive tributary figures of 'Morality,' 'Law,' 'Freedom,' and 'Education.' Morton Park is the chief pleasure ground; and there is a public library with over 13,000 volumes. Plymouth is a well-known summer resort, and is of considerable industrial importance. The principal manufactures include cordage, tacks, rivets, woolen and knit goods, duck, stoves, foundry products, rubber goods, wire, etc. Plymouth Harbor is large but shallow, and there is little commerce other than coastwise trade. A number of vessels are employed in the fisheries. The government is administered by town meetings. There are municipal water-works. Population, in 1890, 7314; in 1900, 9592. Consult: Davis, *History of the Town of Plymouth* (Philadelphia, 1885); *Records of the Town of Plymouth* (Plymouth, 1889-92); and, especially for early history, Bradford, *History of Plymouth Plantation*, last ed. (Boston, 1898). See MASSACHUSETTS.

PLYMOUTH. A town and one of the county-seats of Grafton County, N. H., 51 miles north by west of Concord; on the Pemigewasset and Baker rivers, and on the Boston and Maine Railroad (Map: New Hampshire, II 7). Situated in a region noted for its scenic attractions, Plymouth is a popular summer resort. It is the seat of the State Normal School, and has the Holderness School for Boys and a public library. There are manufactures of shoe pegs, buckskin gloves, sporting goods, lumber, veneer goods, and butter. Nathaniel Hawthorne died here, and the old court-house is famous as the scene of Daniel Webster's first appearance as a lawyer. Population, in 1890, 1852; in 1900, 1972.

PLYMOUTH. A town and the county-seat of Washington County, N. C., 162 miles east of Raleigh; on the Roanoke River, near Albemarle Sound, and on the Atlantic Coast Line Railroad (Map: North Carolina, F 6). It has a State normal school (colored), and is the trade centre for a fertile section, the chief products of which are cotton, peanuts, tobacco, rice, farm produce, and lumber. Population, in 1890, 1212; in 1900, 1011.

PLYMOUTH. A borough in Luzerne County, Pa., four miles west of Wilkesbarre; on the Susquehanna River, and on the Delaware, Lackawanna and Western Railroad (Map: Pennsylvania, E 2). It is interested principally in coal-mining and in the coal trade, being situated among the rich anthracite fields of the State. There are also some manufactures, the chief products including mining drill machines, miners' squibs, hosiery, silk, etc. Plymouth was settled in 1768 by the Susquehanna Company, and until the close of the Pennamite-Yankee War in 1799 was claimed by both Connecticut and Pennsylvania. Population, in 1890, 9344; in 1900, 13,649. Consult Wright, *Historical Sketches of Plymouth, Pennsylvania* (Philadelphia, 1873).

PLYMOUTH BRETHREN. A religious sect which sprang into existence in the British Islands during the first half of the nineteenth century, and has extended itself throughout the British dominions and in certain parts of the Continent of Europe, particularly among the Protestants of France, Switzerland, and Italy, and in the United States of America. They do not use the name themselves, preferring to be called simply Believers, Christians, or Brethren. Their origin seems to have been due to a reaction against exclusive high-church principles in the Church of England and similar tendencies in other churches, and against a dead formalism associated with 'unevangelical' doctrine. While several communities appeared almost simultaneously in various places, the foundation of the body is generally ascribed to the labors and influence of John Nelson Darby, from whom on the Continent of Europe they are commonly known as Darbyites. Darby was born in London in 1800; he was graduated B.A. at Trinity College, Dublin, in 1819, and was called to the Irish bar in 1825. He withdrew from the Church of Ireland because of conscientious scruples regarding the scripturalness of church establishments; he also believed that denominational distinctions and a regular ministry should be discarded. He found others who shared his views, notably Anthony Norris Groves, a student at Trinity College, and an association was formed in Dublin in 1828.

Another was soon organized in Plymouth, and the fact that Providence Chapel in that town was the first regular place of meeting gave rise to the name Plymouth Brethren in 1830. Darby continued to labor as an evangelist, unconnected with any Church, in England and on the Continent, until his death in 1882. He preached in English, French, and German, wrote voluminously, and edited a quarterly periodical, *The Christian Witness*, which for a number of years was the official organ of the Brethren. His collected writings have been published in 32 volumes (London, 1867-83).

The doctrines of the Plymouth Brethren are Calvinistic. They emphasize original sin, predestination, the efficacy of Christ's sacrifice, the merit of His obedience, the power of His intercession, the gracious operations of the Holy Spirit in regeneration and sanctification. Millenarian views are also generally entertained. They practice the baptism of adults without regard to previous infant baptism. They hold meetings for Bible study and prayer, and observe the Lord's Supper weekly on Sunday. Their most distinctive peculiarity is their refusal to recognize any form of Church government or any office of the ministry; they insist on the equal right of every male member of the Church to prophesy or preach. They do not build churches, but meet in halls or private houses. A great schism took place among them during Darby's lifetime because of doctrines preached at Plymouth and Bristol concerning the human nature of Christ, and they have been frequently divided on narrow lines. There are four divisions in the United States (consult Carroll, *The Religious Forces in the United States*, New York, 1893). They number about 300 meetings in the United States and 100 in Canada. Consult the biographies of eminent members of the sect, as that of A. N. Groves (by his widow, London, 1856); Henry Craik (by Taylor, ib., 1866); the writings of B. W. Newton and W. Kelly; Guinness, *Who Are the Plymouth Brethren?* (Philadelphia, 1861); Dorman, *The Close of 28 Years of Association with J. N. Darby* (London, 1866); Henry Groves, *Darbyism, Its Rise and Development* (ib., 1866). For hostile criticism, consult Carson, *The Heresies of the Plymouth Brethren* (ib., 1862); Reid, *Plymouth Brethrenism Unveiled and Refuted* (Edinburgh, 1875); Croskery, *Plymouth Brethrenism, a Refutation of Its Principles and Doctrines* (London, 1879). Consult also Teulon, *The History and Teaching of the Plymouth Brethren* (ib., 1883); Neatley, *A History of the Plymouth Brethren* (ib., 1901).

PLYMOUTH CHURCH. The church in Brooklyn, N. Y., made famous by the long pastorate of Henry Ward Beecher, which lasted from 1847 until his death, forty years later. The original building was burned in 1849, when the present plain brick church was erected, seating 2800 people, and containing one of the largest organs in America.

PLYMOUTH COLONY. See MASSACHUSETTS.

PLYMOUTH ROCK. A ledge of rock in Plymouth harbor, Massachusetts, on which the Pilgrims are said to have stepped when disembarking in 1620. It is looked upon with veneration and celebrated in literature as a symbol of New

England principles. A beautiful granite canopy has been erected upon the rock.

PLYMOUTH ROCK. A breed of domestic fowls, popular and numerous throughout the United States, in several varieties. It is of large size, and has admirable qualities for market purposes. The favorite variety is the 'barred,' of a grayish-white color, every feather marked with many curving black bands. There are also clear white and clear buff varieties. The standard weight of the cock is 9.50 pounds; of hens, 7.50 pounds. See Colored Plate of FOWLS.

PLYMOUTH SOUND. A beautiful inlet of the English Channel between Cornwall and Devonshire, forming the harbor of Plymouth and Devonport, which is an important British naval station (Map: England, B 6). See PLYMOUTH, and the article BREAKWATER.

PLYMPTON, plimp'ton, GEORGE WASHINGTON (1827—). An American engineer and educator, born in Waltham, Mass. He graduated as a civil engineer from the Rensselaer Institute, Troy, N. Y. in 1847; was appointed professor of engineering and architecture in Cleveland University (1852), and the following year took the chair of mathematics in the New York State Normal School. He occupied a similar position in the State Normal School at Trenton, N. J., from 1857 till 1863, when he was made professor of physical science in the Brooklyn Polytechnic Institute, and six years afterwards took the same chair in the New York Cooper Union, of whose night schools he assumed direction in 1879. He was also professor of chemistry and toxicology at Long Island College Hospital, Brooklyn, from 1864 to 1886. His publications include *The Blowpipe* (1859), *The Starfinder* (1878), and *The Aneroid* (1880).

PLYNLIMMON, or **PLINLIMMON**. A mountain of Wales, on the boundary between the counties of Montgomery and Cardigan, 2481 feet in height. Although only 12 miles from the coast, it is in the midst of a wild waste of moor and bog, and on its slopes are the sources of the rivers Wye and Severn.

PNEUMATIC CLOCKS. See CLOCK.

PNEUMATIC DISPATCH (Lat. *pneumaticus*, from Gk. *πνευματικός*, *pneumatikos*, relating to wind or air, from *πνεύμα*, *pneuma*, air, wind, spirit). The name given to a method of sending mail matter, telegraphic dispatches, parcels, etc., through a tube by means of air pressure. The matter to be transported is placed in a carrier so designed as to fit closely the inside of the tube while being free to move, this carrier being propelled forward by introducing air under pressure behind it or by exhausting the air in front of it. Pneumatic dispatch was conceived as early as 1667 by Denis Papin, who, in a paper read before the Royal Society of London in that year, described a plan to exhaust the air from a tube in such a way that an interior piston would be propelled in the direction of the suction and haul a carrier attached to it by means of a chord. The first practical results with pneumatic dispatch, however, seem to have been obtained by Medhurst, an Englishman, who first described his system in a pamphlet published in 1810. Medhurst was followed by a score or more of inventors, some of whom achieved mechanical success, but it was not until 1853-54, when a

tube 220 yards long was built in London by the Electric and International Telegraph Co., to convey telegraph dispatches, that a practical working pneumatic system was put in actual operation for commercial purposes. This system was designed by Josiah L. Clark, and employed a tube 1½ inches in diameter, in which the carriers were dispatched in one direction only. This system was improved by C. F. Varley, who succeeded Mr. Clark as the engineer of the company named, and who increased the diameter of the tubes to 2¼ inches, and operated the carriers in both directions, using vacuum for sending in one direction and compression for sending in the other direction.

The next improvement in pneumatic dispatch was made by Siemens Bros., of Berlin, Germany, who proposed a circuit system in which two tubes were used, the 'up' tube being connected to the 'down' tube at the distant end; the air was compressed into one end of the circuit and exhausted at the other end, and furthermore it was kept in constant circulation, so that carriers were dispatched by inserting them into the tube without stopping the air current. To stop the carriers at intermediate stations, a wire screen could be inserted across the tube which would permit the air to pass, but would stop the carrier. The apparatus for sending and receiving carriers consisted of two short sections of tube attached to a rocking frame so that either could be swung by hand into line with the main tube. One of the tube sections was open at both ends and was used for dispatching carriers; a carrier was placed in it, then it was swung into line with the main tube, when the air current passing through swept the carrier along. The other tube section contained a perforated screen at one end and was used to receive carriers; when it was swung into line the air passed along through the screen, but the carrier was caught.

The first extensive application of the Siemens system was made in Berlin, Germany, in 1865, when a circuit was built between the telegraph station and the Exchange requiring 5670 feet of 2½ inch wrought-iron tube. This experimental line proved so successful that the system was rapidly extended until in 1897 there were 33 stations and 28 miles of tubes in use. In extending the system the Siemens system of operation was discarded; air was not kept constantly circulating, but power was stored up in large tanks, some being exhausted and others filled with compressed air. The exhausted tanks were permanently connected with the closed tubes, which were opened when required for use, and the tanks containing compressed air were connected to the tubes when messages were sent. The tubes were laid in circuits, including several stations in a circuit, and the carriers traveled only in one direction around the circuit. In 1866 the first stretch of pneumatic tube was laid in Paris and the system has been gradually extended since. As in Berlin, the tubes were laid in circuits, but instead of operating the circuit from a single power station each station of the circuit has a power plant and the sections of tubes between any two stations can be operated independently of the rest of the circuit. The carriers are run in trains, each train being propelled by a piston which pushes the rear carrier of the train, and these trains are dispatched every 15 minutes. Every train stops at all stations, where the carriers for that station are taken out and others

for succeeding stations are inserted. The speeds of the trains are from 15 to 23 miles per hour. Vienna, Austria, has a pneumatic dispatch system resembling that of Paris.

The London system of pneumatic dispatch differs from those of Continental cities just mentioned chiefly in being a radial system instead of a circuit system. The tubes radiate from a central power station to substations located at various points. In 1897 the system comprised 42 stations and 34 miles of tubes. The first London tube was installed by Siemens Bros., in 1870, but the present lines have been greatly improved over the original construction. Other British cities which have systems of pneumatic dispatch are Liverpool, Manchester, Birmingham, Glasgow, Dublin, and Newcastle. Mention should be made of the atmospheric railway built in London in 1863, from Euston to a station in Ever-shalt Street, 1800 feet, and extended in 1872 from Euston to the General Post-office, 14,204 feet. The original tunnel was a single tunnel flat on the bottom and D-shaped in section $2\frac{3}{4}$ feet high and $2\frac{1}{2}$ feet wide. The carriers were cradle-like boxes fitting the tunnel and they were moved at a speed of 17 miles per hour. The second line built was a double tunnel line each 4 feet high and $4\frac{1}{2}$ feet wide. These atmospheric railways were used to carry the mails for a time, but were found to be slow and expensive and were abandoned.

1893 the United States Post-office Department installed pneumatic dispatch between its main post-office and its substation at the Bourse, Philadelphia. This line is 2974 feet long, with tubes eight inches in diameter, and the carriers travel at a speed of about 25 miles per hour. This system has since been extended to reach the terminal stations of the Pennsylvania and the Philadelphia and Reading railways. In 1897-98 there were installed 6.83 miles of pneumatic dispatch connecting the general post-office in New York City with the Brooklyn post-office, the Grand Central Station, and intermediate substations. As the result of the experience with these lines, Congress, by an act dated June 2, 1900, ordered a committee of experts to be appointed to investigate and report upon the cost, construction, and utility of such systems for these and other large cities. This committee investigated these questions for eleven large cities and submitted a voluminous report in 1901.

The Batcheller system, which was first installed at New York and Philadelphia, on the lines in use in 1901, employed compressed air at a pressure of from five to ten pounds. The compressed air may be furnished by any improved type of air compressor or high-pressure blower and forces the carriage through a cast-iron pipe which is bored true and smooth and carefully jointed. The tubes, which are six and eight inches in diameter, are laid in a double line to facilitate

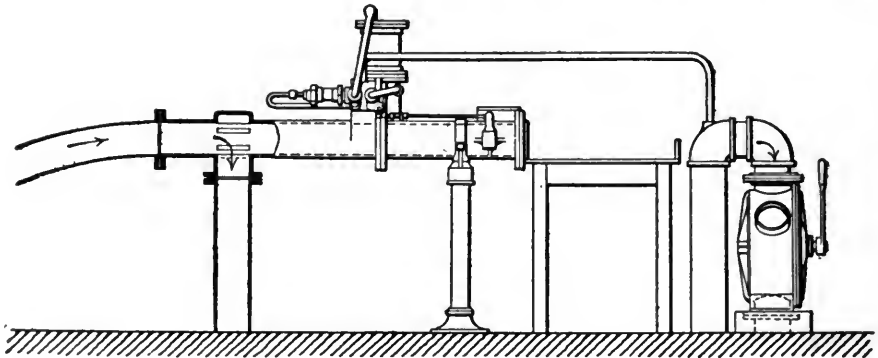

SENDING AND RECEIVING APPARATUS.

Perhaps the first attempt at pneumatic dispatch in America was made by A. E. Beach, who invented and exhibited a full-size working model of an atmospheric railway in 1867. Some years later Mr. Beach began the construction of an atmospheric railway tunnel under Broadway, New York City, and had completed a short distance of tunnel when the work was abandoned. In his working model Mr. Beach used a tube six feet in diameter through which a car seating ten persons was propelled by air pressure generated by a fan. This is the only attempt actually made in America at atmospheric railway construction. The use of pneumatic dispatch has, however, become quite extended. Perhaps the most extensive use of small pneumatic tubes in stores for dispatching cash to and from a centrally located cashier's desk. Seamless brass tubing is generally used and the power is supplied by rotary blowers. The Western Union Telegraph Company has pneumatic dispatch systems in use in New York and Chicago, and similar private systems are in use elsewhere. In

traffic in opposite directions. The carriers are symmetrical in form, of the shape shown in the illustration, and of a diameter about one inch less than that of the tube. A door in the end of each carrier gives access to the interior. They are from 16 to 30 inches in length and weigh from 7 to 16 pounds. Near each end are placed packing rings of cotton fabric secured to the



SECTION OF CARRIER.

main body by metal collars so as to insure a close fit in the tube. These packing rings are lubricated by vaseline, which makes easy running possible. The sending and receiving apparatus, which is located at each end and also at intermediate stations on the line, is shown in the il-

Illustration. In the sending apparatus two sections of the tube are supported in a swinging frame so that either can be brought into line with the main tube, through which there is a constant current of air. After a carrier has been placed in an iron trough it passes into an open tube section and is then swung into position so that it is in line with the main tube and the carrier is swept along by the pressure. The car-

riers usually have a headway of from five to fifteen seconds each, and may be dispatched automatically. There are various forms of receivers, the use of which depends upon various conditions of atmospheric pressure. The action of the receiving apparatus is automatic, and as soon as a carrier arrives in the receiving chamber the latter is tilted and the carrier is discharged and the receiving chamber returned to its normal horizontal position. Automatic apparatus is also employed at the intermediate stations and the carriers designed for a particular station are turned aside from the main line tube. The use of pneumatic apparatus is constantly increasing and there are cities in the United States in which it is being installed for the transmission of small packages.

to discharge a quantity of high explosive. The most successful pneumatic gun, the invention of Capt. E. L. Zalinski, U.S.A., is designed to discharge projectiles loaded with a high explosive, such as dynamite, the shock of the discharge being kept low by the use of air. Pneumatic guns have not been taken up by governments, because it is felt that the problem of projecting a mass containing high explosives is not thoroughly solved by such means. See AIR GUN; ORDNANCE.

PNEUMATICS. The branch of mechanics which treats of the properties of gases, either at rest or flowing, and of solids immersed in gases. See GASES, GENERAL PROPERTIES OF.

PNEUMATIC TOOLS. The name given to a class of portable, self-contained motor tools (generally hand tools), for metal and wood working, operated by compressed air. Pneumatic tools are of two types, viz. percussive tools and rotary tools. In the first type work is done by rapidly repeated percussive blows and in the second type by a rotary or boring action. The motive power used in both is air under pressure, and the motor is contained within the tool. The variety of purposes to which pneumatic tools are put is very great; a recent authority has stated that there are between 70 and 80 different styles of such tools in use and that new appliances are being constantly discovered. Some of the general mechanical operations to which such tools are applied are hammering, ramming, calking, chipping, riveting, shaving, drilling, boring, screwing, clipping, carving, and expanding tubes. As will be seen, these operations are nearly all of the sort which permit the primary mechanical actions of the tool—percussion and rotation—to be employed without modification. It will be sufficient for a general understanding of pneumatic tools, therefore, to describe briefly typical percussive and typical rotary tools.

PERCUSSION TOOLS. The mechanism employed for utilizing compressed air to secure percussive

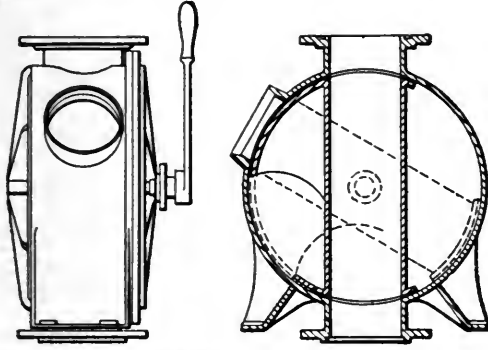

SENDING APPARATUS. -

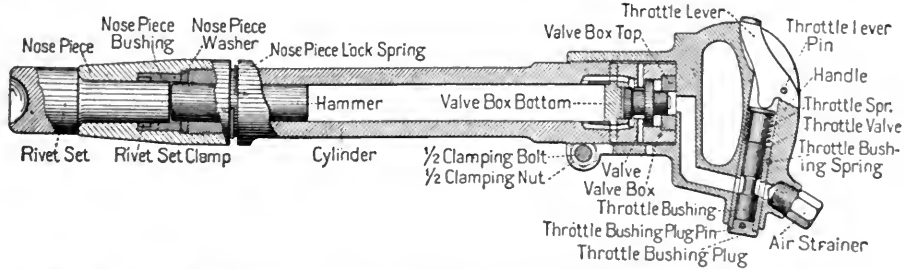

SECTION OF KELLER PNEUMATIC HAMMER ARRANGED FOR RIVETING, SHOWING OPERATING PARTS.

BIBLIOGRAPHY. For a comprehensive description of the Batcheller pneumatic dispatch system, particularly as installed at Philadelphia, Pa., see Batcheller, *The Pneumatic Dispatch Tube System* (Philadelphia, 1897). The results and conclusions of the committee appointed to investigate the subject of pneumatic dispatch for the Post-office Department have been published by the Postmaster-General under the title of *Pneumatic Tube Service* (Washington, D. C., 1900).

PNEUMATIC GUN. A gun in which the expansive force of air under pressure is employed

action is essentially the same in all pneumatic tools of this type, and it will be sufficient to describe the mechanism in one of them only, and for this purpose the hammer will perhaps serve best. The pneumatic hammer consists essentially of a cylinder containing a piston which, by means of suitable cylinder inlet and exhaust openings for air under pressure, is made to reciprocate back and forth in the cylinder. A tool is inserted into the front end of the cylinder loosely in such a way that the reciprocating piston or hammer strikes its near end at each forward stroke, the

action being exactly analogous to that of a man driving a chisel with a hand hammer. The rear end of the cylinder terminates in a handle by which the tool is held by the operator. Compressed air is conveyed to the cylinder by means of a suitable connection or a flexible hose. The variety of constructions by which the piston stroke is actuated and controlled is large, but generally speaking all pneumatic hammers may be classed either as valveless hammers or valve hammers, one of the former class, the Keller tool, being shown in the diagram and in various application on the accompanying plate. The valveless hammers have no valve beyond the striking piston, this being itself a valve to effect the proper admission of air to alternate ends of the working cylinder. In the valve hammers a reciprocating valve, working either at right angles to or parallel with the striking piston, acts in combination with it to regulate the inlet and the exhaust of the compressed air.

There are several constructions of both valveless and valve hammers, each of which is controlled by patents owned by the manufacturers of such tools. The general characteristics and comparative merits of the two forms of construction may be summarized as follows: Valveless hammers have essentially a short stroke, and although economical in air consumption in relation to the number of blows given, they do not compare with valve hammers in giving powerful blows, which are necessary in heavy chipping and riveting. Owing, however, to their simple construction, they have probably a longer life than valve hammers, and for such purposes as beading flues, light calking and chipping, and especially carving in stone, they compare very favorably with their rivals. The speed of the valveless hammers is very high, being from 10,000 to 20,000 strokes per minute. The speed of valve hammers for ordinary work ranges from 1,500 to 2,000 blows per minute, although they can be driven much faster. Their stroke is considerably longer than that of valveless hammers, and the blow struck is correspondingly greater. These characteristics of valve hammers make them most suitable for general and heavy clipping, calking, and riveting. This comparison is a fair summary of recent engineering opinion on the subject, but advocates of one or the other form naturally contest the claims of its opponents. The preceding description has referred particularly to hammers; by replacing the hammer tool struck by the piston as above described with sharpened or otherwise specially formed tools we have the hammer converted into a tool for chiseling, chipping, beading, calking, riveting, etc. In operation the apparatus is held by the handle so that the tool presses firmly against the work; air pressure is then turned on by pressing a trigger or thumb lever on the handle and the reciprocating piston begins to strike the tool, which is thus caused to cut or hammer the work in front of its nose. As previously stated, the blows are exceedingly rapid, their sound coming to the ear as a continuous buzz, and they depend for their effect upon their great frequency rather than upon their individual energy. Pneumatic percussion tools are made in a variety of sizes, but with the exception of riveters their weight and dimensions are kept small enough to permit them to be manipulated by hand. As specially designed for rivet-

ing work the percussive pneumatic tool requires brief special description. Any of the regular hammer tools may be used for riveting in connection with a holder-up for supporting the butt of the rivet, but such work is more effectively accomplished by heavier tools having a longer stroke. The yoke riveter is another common form and consists of a U-shaped yoke having at the end of one arm an inwardly projecting holder-up. The yoke riveter is made in several modifications designed for special purposes and requires generally to be handled by chain or pneumatic hoists or other power. (For illustration, see METAL-WORKING MACHINERY.) In clipping tools the stroke of the piston is reduced enormously in speed and it is provided with a piston rod which acts on a suitable hinged link construction to convert its rectilinear motion into a pincer-like movement of the clipping edges or jaws. In the forms of percussion pneumatic tools described the intensity of air pressure used is from 80 lbs. to 100 lbs. per square inch for all work except riveting, where it is usually increased up to 125 lbs. per square inch.

ROTARY TOOLS. Rotary pneumatic tools, commonly called portable pneumatic drills, are used for drilling and boring wood and the analogous operations of reaming, tapping, tube-expanding,

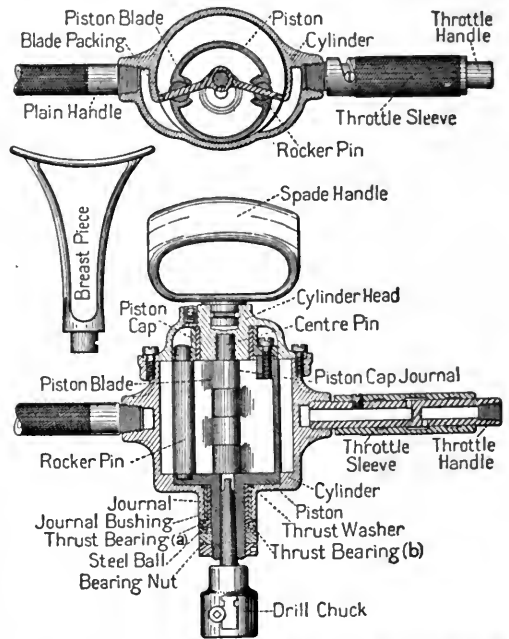

KELLER PNEUMATIC DRILL OPERATED BY ROTARY MOTOR.

screwing nuts on bolts, boring cylinders and Corliss engine valve seats; also for turning crank pins, grinding steam-pipe joints, and cleaning castings. The method by which compressed air is utilized for driving the drills is generally by means of single or double acting cylinder motors, the cylinders of which are sometimes fixed and sometimes oscillating, which actuate suitable mechanism for turning the bit and are inclosed in the body of the drill. Rotary motors are also used, and an example of one of these, the Keller tool, is shown diagrammatically in the illustra-

PNEUMATIC TOOLS

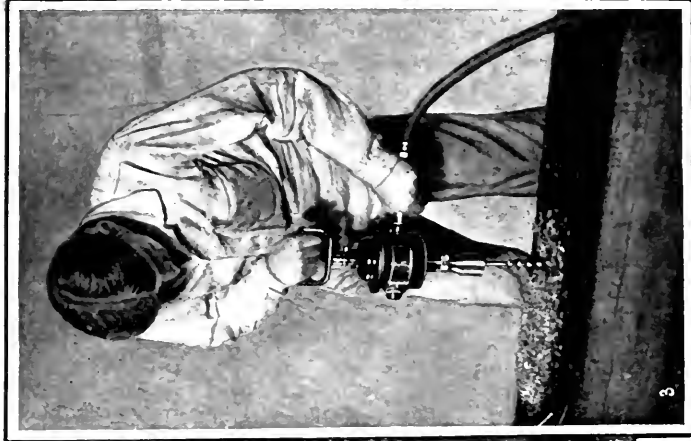
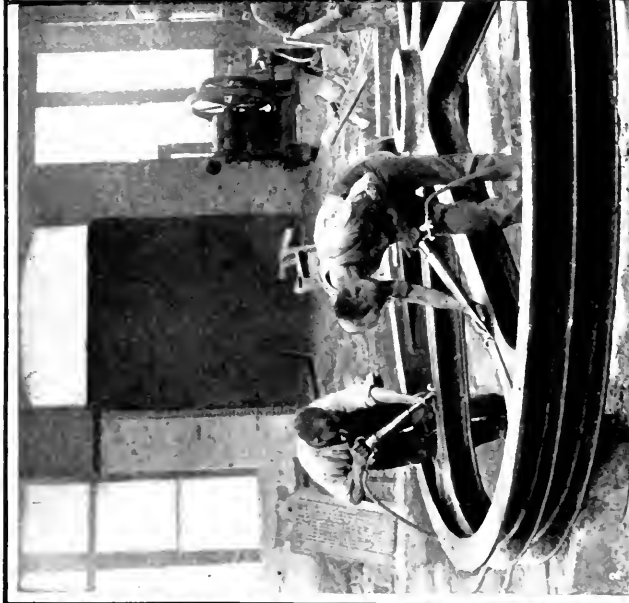

1. EXPANDING BOILER TUBES

2. CHIPPING CASTINGS WITH PNEUMATIC CHIPPING HAMMER.

3. WOOD-BORING

4. PNEUMATIC RIVETING HAMMER.

5. CALKING A BOILER.



tion and in actual use on the accompanying plate. Pneumatic drills are made in a large number of sizes from light drills suitable for small holes up to machines of two or three horse-power. They work with from 60 pounds to 80 pounds air pressure. For performing different kinds of work, assuming the size to be ample, the only change necessary is the substitution of the proper tool (drill, auger, saw-bit, reamer, etc.) in the tool-holder. A description of the motor construction of several well-known tools will give a fair idea of this mechanism. In the Little Giant drill the motor consists of four single-acting cylinders arranged in pairs and coupled to opposite ends of a crank shaft. The crank shaft carries pinions which gear with spur wheels on the tool shaft. The entire mechanism is inclosed in a shell shaped like the section of a circular cylinder. The Whitelaw drill has two double-acting oscillating cylinders geared to a crank shaft which carries a single pinion gearing with a spur wheel on the tool shaft. In the Boyer piston drill the motor is in the form of a three-cylinder single-acting oscillating engine, the cylinders being carried in a rotary frame, which, since the cylinder pistons are coupled to a fixed crank, rotates and by means of suitable gears causes the tool shaft to rotate. The motor mechanism is all inclosed in a cylindrical casing. Air is piped to these rotary tools by flexible hose exactly as in the case of percussion tools.

The use of pneumatic tools has been most highly developed in the United States, but it is extending rapidly in European countries. Their particular field of usefulness is in performing work formerly performed by hand, because of the inability of transporting the ordinary heavy shop tools to the work. For example, in riveting the connections of metal bridges during erection in the field the work has to be done on stagings and scaffoldings high in the air. These positions are inaccessible to heavy shop riveting machines, and until the advent of the pneumatic tool such work was of necessity performed by hand; the portable pneumatic riveter can be used in almost any place where hand riveting is possible with a gain in all things in which machine work surpasses hand work.

PNEUMOGASTRIC (nū'mō-gās'trik)
NERVE (from Gk. πνεύμων, *pneumōn*, lung + γαστήρ, *gastēr*, stomach), or PAR VAGUM. A nerve which derives the first of its names from its supplying the lungs and stomach with nervous filaments, and the second from the wandering course which it pursues. It emerges from the medulla oblongata by eight or ten filaments, which unite and form a flat cord that escapes from the cavity of the cranium (in association with the glossopharyngeal and spinal accessory nerves) by the jugular foramen. In this foramen it forms a well-marked ganglionic swelling, while another is observed immediately after its exit from the skull. The nerve runs straight down the neck between and in the same sheath as the internal jugular vein and the carotid artery. Below the root of the neck its course is different on the two sides; the right nerve, running along the back of the œsophagus, is distributed to the posterior surface of the stomach, and finally merges into the solar plexus, while the left nerve runs along the front of the œsophagus to the stomach, sending branches chiefly over its anterior surface.

From anatomical considerations, based on the

distribution of this nerve, and from the results of experiments on animals, it may be concluded that this is a mixed nerve, containing filaments both of sensation and motion. The pulmonary branches exercise a most important influence upon the respiratory acts, for when the pneumogastrics on both sides have been divided above the giving off of the pulmonary branches, the most severe dyspnoea comes on, the number of respirations is much diminished, and the animal breathes as if it were asthmatic; after a short time the lungs become congested and finally consolidated, while the bronchial tubes are filled with a frothy serous fluid; and if the cut ends of the nerves are kept apart, the animal never survives above three days. The gastric branches influence the movements of the stomach, while their destruction does not materially affect the secretion of the gastric juice of further digestive reactions. Loss of voice and difficulty of breathing have been frequently traced to the pressure of an aneurism or other tumor on the recurrent or inferior laryngeal. The sympathy which exists between the digestive and the respiratory and circulating organs is explained by the anatomical relations of this nerve. For example, both asthma and palpitation of the heart are often to be traced to some deranged state of digestion. Vomiting may be excited by irritation of the central or the distal extremities of the nerve. In disease of the brain the vomiting, which is often an early symptom, is caused by irritation of the central extremity; while, on the other hand, by introducing emetic substances into the stomach the vomiting is produced by the irritation of the peripheral (or distal) filaments.

PNEUMONIA, nū-mō'nī-ā (Neo-Lat., from Gk. πνευμονία, disease of the lungs, from πνεύμων, *pneumōn*, lung, from πνέω, *pnéō*, to breathe). An inflammation of the substance of the lung. There are three well-defined forms: Acute lobar pneumonia, broncho-pneumonia, and chronic interstitial pneumonia.

Acute pneumonia is called *lobar* because it involves usually an entire lobe or successive lobes of the lung; *croupous* from the character of the exudation into the air cells or alveoli. The disease is due to a specific germ, the *Pneumococcus* or *Diplococcus pneumoniae*, although streptococci and staphylococci are always found with it. It is infectious and in a measure contagious, and sometimes occurs epidemically in institutions and houses. It is apt to attack persons in a depressed physical or mental condition; it is more prevalent in the spring and autumn than at other times, and is a disease of adults up to middle age. Unlike most specific fevers, one attack does not confer immunity, but rather predisposes to others. Pneumonia begins with a chill, high fever, and a severe pain in the side, attributable to the accompanying pleurisy. As the malady progresses, there is a cough, with a viscid, airless, rusty sputum, later becoming yellow. Respirations are rapid and shallow, 40 or 50 to the minute; the pulse is also rapid, the cheeks flushed, and the general prostration extreme. There are in addition headache, sleeplessness, and sometimes delirium. These symptoms continue with more or less severity until the crisis occurs, from the fifth to the eleventh day, when the temperature falls quite suddenly, almost to normal, and rapid improvement sets in. In a few cases a crisis does not occur, but the temperature declines gradu-

ally. Death takes place in fatal cases from heart failure, due to toxemia. During the progress of pneumonia, the affected portion of the lung goes through three stages. In the first or stage of hyperæmia, the lung is congested, has a reddish brown color, and there is a slight exudation into the air cells. It is heavier than normal and contains less air. This stage lasts from one to three days, and is followed by the stage of exudation or red hepatization. In this the lung is red (resembling, when cut into, a section of liver), sinks in water, and the air sacs are completely filled with viscid, fibrinous fluid mixed with blood corpuscles. In from three to seven days the stage of resolution or gray hepatization sets in. The exudate filling the alveoli now undergoes liquefaction and is partly absorbed and partly expelled by acts of expectoration. This stage may endure from one to three weeks. Sometimes resolution is delayed, the exuded material undergoes purulent transformation, and single or multiple abscesses of the lung result. Pneumonia is a self-limited disease, and treatment is therefore not directed toward cutting short an attack, but toward keeping up the patient's strength, supporting the heart, and reducing the temperature. It is particularly in the second stage that the patient is in danger, when the fever is at its height and the heart embarrassed. Alcohol, strychnine, and straphanthus are the most useful cardiac stimulants, and cold sponging and cold packs or baths the usual methods of reducing the fever. During the third stage expectorants are exhibited to assist in bringing up the exudate, and during convalescence tonics are given to build up the strength and restore the wasted tissues.

Broncho-pneumonia (catarrhal or lobular pneumonia) attacks principally young children and old people by an extension downward of a bronchitis. It often occurs as a complication of the eruptive fevers, especially measles, and of whooping-cough. The disease affects the mucous membrane lining the finer bronchial tubes (whence it has been called capillary bronchitis) and the air cells. These become blocked up by a yellowish mucoid material and larger or smaller portions of the lung are deprived of air. The symptoms of this variety of pneumonia are similar to those of the croupous form, except that the temperature rises more gradually and the rapidity of respiration is out of all proportion to the amount of tissue involved. The disease may be acute, subacute, or chronic in its course, and nearly one-half of the cases die. The treatment is designed, as in croupous pneumonia, to keep up the strength, and assist in the expectoration of the toxic material. A steam kettle is kept going in the sick-room, poultices are applied to the chest, and expectorants and a nourishing liquid diet are given throughout the attack.

Chronic interstitial pneumonia (cirrhosis of the lung) is a comparatively rare disease, found in miners, stone-cutters, grinders, and others whose occupation necessitates the inhalation of irritating particles. It sometimes follows acute pneumonia in which resolution has been delayed, and generally terminates as a tuberculous process. There is an overgrowth of the fibrous framework of the lung at the expense of the respiratory elements. The organ shrinks sometimes to half its normal size, and is heavy and tough in consistence. There is always an associated chronic bronchitis, with cough and ex-

pectoration. The course of the disease is slow, extending over ten or fifteen years. The treatment of this disease consists in placing the patient under the best possible hygienic and climatic conditions—a warm climate in the winter and a bracing one in the summer, with the administration of tonics, such as cod-liver oil, iron, and quinine.

Among animals the horse perhaps most frequently exhibits symptoms characteristic of pneumonia. Bad ventilation, improper attention to the needs of the animal, etc., are frequent causes. Remedies are similar to those used for the human subject.

PNOM-PENH (*Fr. pron. pnôn'pên'*). The capital of the French protectorate of Cambodia, 130 miles northwest of Saigon, on the Mekong River (Map: French Indo-China, E 5). The most noteworthy features are the palace of the Buddhist priests, the Government buildings, and the pagoda. The shelling of cotton seeds is an important industry, and the town is also a prominent trade centre. Population, about 50,000.

PNYX, níks (Lat., from Gk. πνύξ). A hill and ancient place of assembly, whose exact location is not known, in Athens.

PO (anciently *Padus* and *Eridanus*). The largest river of Italy, flowing through Piedmont and Lombardy, and along the southern borders of Venetia. It rises on Monte Viso, in the Cottian Alps, and flows in a general easterly direction through the great valley between the Alps and the Apennines, emptying into the Adriatic Sea after a course of 390 miles (Map: Italy, F 3). It falls very rapidly in its extreme upper course, its ultimate sources being at a height of 6000 feet. In the lower half of its course, however, it is a comparatively sluggish stream, flowing over a raised alluvial bed so that its surface is higher than the surrounding country, and its banks have to be protected by dikes, which extend continuously from Cremona to the delta. These levees, however, do not follow the smaller windings of the river, but cut across peninsulas, which, though unprotected, are cultivated, but are submerged at every considerable rise of the river. The volume of water discharged by the river is nearly equal to that of the Rhine. The greater part is received from the Alps, and nearly one-half comes from the series of large lakes on the southern slope of the mountains. The principal tributaries from the left are the Dora Riparia, Dora Baltea, Sesia, the Ticino, the outlet of Lago Maggiore, the Adda from Lago di Como, the Oglio from Lago d'Isèo, and the Mincio from Lago di Garda; from the right the Po receives the Tanaro, Trebbia, Taro, and Panaro. Since the Po is fed exclusively by mountain torrents, the quantity of sediment carried by its current is enormous, the absolute quantity being nearly equal to that carried by the Mississippi. As a result of this the delta of the Po grows with nearly the same rapidity as that of the great American river; it advances into the Adriatic at the rate of more than 200 feet per year. The delta and the surrounding country consist of unhealthy marshes, and there are scarcely any towns on the lower course of the river. The chief cities on its banks are (ascending) Cremona, Piacenza, Casale Monferrato (the head of navigation, 337 miles from the mouth), and Turin. The plain of the Po is of great fertility.

POA, pō'á. See MEADOW GRASS.

POACHING (OF. *pocher*, from *poche*, pocket, probably from Ir. *poc*, Gael. *poca*, pocket, or less probably connected with OF. *pocher*, *poucher*, to thrust, hit, and ultimately with Eng. *pochard*, which see for etymology). In English criminal law, the act of unlawfully trespassing on another's lands for the purpose of killing or taking game, or for the purpose of catching fish. It embraces a variety of statutory offenses, with respect to game and fish, by persons having no sporting rights. These statutes were enacted in the interests of the public, primarily for the purpose of protecting game and fish which are valuable for food. Such animals are not treated by English law as the subjects of larceny, and, but for special legislation, persons taking them from another's lands would be liable only to a civil action for trespass. English game and poaching statutes make such taking a crime. The existing legislation on this topic begins with the Night Poaching Act, 1828 (Geo. IV., c. 69), and the Day Poaching Act of 1831 (1 and 2 Geo. IV., c. 32). These were called forth by the rapid increase of poaching which followed the close of the Napoleonic wars. Such increase has been ascribed to the distress prevailing in agricultural districts during the third decade of the last century, and to the large number of turbulent spirits thrown out of military employment and cast back into the ranks of ordinary laborers. The acts referred to above made poaching a crime instead of treating it, in its various forms, as an offense which could be condoned by a money penalty. They also legalized the sale of game which had been lawfully captured or killed.

POACHING GAME. By the Night Poaching Act, it is provided that any person unlawfully trespassing in search of game by night—i.e. between the first hour after sunset and the first hour before sunrise—shall for a first offense be committed by the justices to the house of correction for three months, or in some cases for six months; for a second offense shall be committed for six months, or in some cases for twelve months; and for a third offense shall be guilty of a misdemeanor and be imprisoned for two years. In case such night poachers are found on the lands and in the act, the owner or occupier of the land or his servants may arrest the poachers and take them before justices. If the night poacher, when arrested, use firearms, sticks, or offensive weapons, he shall be guilty of a misdemeanor and be punishable by two years' imprisonment in addition. In case of three or more night poachers being armed with guns, bludgeons, or other offensive weapons, each is guilty of a misdemeanor, and is liable to imprisonment for three years. Poachers have no right to kill game on the highway any more than in fields or inclosures, for the owners of the adjoining land are entitled to the game on the highway.

By the Day Poaching Act, whoever unlawfully goes upon lands not his own to pursue or kill game of any kind is liable to a penalty of £2. When a poacher is found trespassing on lands in search of game, the person entitled to the game there, or the tenant, or a gamekeeper, or servant of either, may demand the poacher's name and place of abode, and if it is refused, may arrest such poacher, and take him before a justice of the peace; but the poacher must be taken within twelve hours before the justice, otherwise he is

entitled to go at large. It is only the persons named (and not any one of the public, or even a constable) who can arrest the poacher, and it can only be done when he is caught in the act on the very lands; for if the poacher clear the fence, and go on to other lands, he cannot then be arrested at all. If the poacher when convicted does not pay the penalty within the time fixed by the justices, he may be committed to the house of correction for a period not exceeding two calendar months. The party may appeal against his conviction to the Court of Quarter Sessions; but he must either remain in custody in the interval or give security for the costs.

By the Poaching Prevention Act, 1862 (25 and 26 Vict., c. 114), which applies to the United Kingdom, if a constable now meet a suspected poacher on the highway, whom he has reason to suspect of coming from land where he has been poaching, such constable may stop and search the poacher; and if game, or implements for taking game, are found on him, may seize and detain them, and summon him before the justices. When before the justices, if it be proved by circumstantial evidence or otherwise that such game was procured by poaching, or that the implements were used, the poacher may be fined in a penalty of £5, besides forfeiture of the game, and guns, nets, and other implements which he may have so used. The person convicted may appeal if he chooses to the next Quarter Sessions, or in certain cases to the Court of King's Bench. With regard to the poacher's property in the game he kills, it is only in those cases where he is caught in the act and on the spot that the game can be taken from him; and this, for obvious reasons, seldom happens. In all other cases the general rule applies that whoever first catches (whether legally or illegally) a wild animal is entitled to the property in it; and as game is in the category of wild animals, the poacher is entitled to keep the game, except where it was both started and caught on one and the same person's lands.

POACHING FISH. The law of fisheries is not uniform in the United Kingdom. In England the general rule is that any one of the public may fish freely in the sea and in all navigable rivers; and where he can fish he can catch salmon as well as every other kind of fish. But there is an exception to this general rule, which consists in this, that as the Crown could before Magna Charta (which took away such right) legally grant a several or exclusive fishery in the sea or navigable river to an individual, and as this was, in point of fact, often granted, it follows that it is not uncommon to find, even at the present day, an individual, generally the lord of an adjacent manor, still claiming a several fishery in these places. If he can prove that he has exercised this exclusive right as far back as one or two centuries, it will be inferred that his right dates from before Magna Charta, and therefore will be legal. When such is the case the public have no right to fish even in a navigable river or the sea at the specified places, the sole fishery being vested in this individual owner. In streams not navigable the rule is that each riparian owner—i.e. the owner of the lands on the bank of the stream—has a right to a several or exclusive fishery up to the middle line of the stream. If he is owner on both sides of the stream, then he has the exclusive fishery in the whole of the stream, so far as his lands extend. As to ponds, whoever is owner of

the soil is the owner of a several fishery there, unless he has let it to another. As to lakes, it is not clearly ascertained how the fishery is to be divided between the owners of the lands abutting thereon, but much will depend on the title to the lands and the subsequent user. As a general rule, there is no such thing as a right in the public to fish anywhere except in a tidal river or the sea, and that is subject to the exception of an individual claiming a several fishery, as before mentioned. It is often supposed that, at all events, if a highway adjoins a private stream, any one may fish in the stream or angle there; but this is a delusion. Nobody is entitled to use a highway for the collateral purpose of either fishing or poaching, the use of the highway, so far as the public are concerned, being confined to the purposes of traveling or transport.

The general rule as to all several—i.e. exclusive—fisheries is that whoever goes and poaches the fish commits an offense, for which he may be summoned before justices and fined £5 over and above the value of the fish taken; and if the fishery where he poaches is adjoining the dwelling house of the owner of the fishery it is a still higher offense, for it is then an indictable misdemeanor. Whenever a fish-poacher is caught in the act of poaching, he may be at once apprehended, not only by the owner of the fishery, but by anybody; but this can only be done while he is on the spot or near it, for if he escape to the highway or to other lands before being arrested, he cannot then be apprehended, but can only be summoned before justices in the usual way. In this respect a privilege is given to anglers, for in no case can these be arrested if angling during the daytime; they can only be summoned for the offense. Though anybody may arrest the fish-poacher, still it does not follow that the fish poached can be taken from the poacher; on the contrary, the rule is the same as with reference to game, that whoever first catches the fish, whether legally or illegally, is entitled to keep it; and though game can on certain occasions be taken from the poacher, this is by reason of an express provision in the Game Act; but there is no similar provision as to poached fish, so that the poacher, whatever other punishment he may incur, does not lose his fish. With regard, however, to the poaching implements, such as nets, it is provided by an express section of the Larceny Act, 1861 (24 and 25 Vict., c. 96, s. 25), that the owner of the fishery or land where the poacher is caught, or his servant, may demand, and if refused, may seize, the net, rod, line, hook, or other implement used for taking the fish, but no other person can seize these.

The laws of Scotland as to poachers of fish differ in some respects from those of England. In Scotland salmon belongs *prima facie* to the Crown, not merely in rivers, but on the seacoast. Hence, the public have no right to fish with nets even in the sea, except by leave of the Crown, or of the grantee of the Crown at the spot in question. Where a salmon-river belongs to several proprietors, the rule is that none can fish by using fixed engines; but the only legal mode is the mode of fishing by net and coble (or boat). Whoever poaches salmon in a river, lake, or within a mile of the seashore incurs a penalty of £5, besides forfeiting the boat, net, or other engine used to catch the fish. While the law is as above stated with respect to fishing salmon with

nets, a grant from the Crown is required to enable even a riparian owner to angle for salmon. As regards other fish than salmon, the general rule is that the riparian owner is entitled to catch all the fish he can, provided he do not interfere with the superior right of some Crown grantee of the salmon-fishery. A person who poaches trout or other fresh-water fish with a net, or by double rod-fishing, or cross-line fishing, or set-lines, etc., incurs a penalty of £5, besides forfeiture of the fish caught. And he may be arrested if he is net-fishing, but not if he is fishing in another way. Moreover, a mere angler of trout, though a poacher, cannot be arrested, nor yet punished by any penalty, though he is liable to an action at law, which, however, is virtually no remedy at all. So, in the case of all poachers of trout (except angling poachers, who can neither be arrested, nor yet have their fish or fishing-rod taken from them by force), the owner of the fishery, or any person authorized by him, may seize the nets, boats, and fishing implements if the poachers are found on the spot. In Ireland the law applicable to poachers of fish is the same as in England. Consult: Woody, *Game Laws of England* (London, 1896); Paterson, *Treatise on the Fishing Laws of the United Kingdom* (ib., 1878); Oke, *The Whole Law as to Game Licenses and Poaching* (ib., 1897); "Poaching," *173 Quarterly Review* (ib., 1891); Stephen, *History of the Criminal Law of England* (ib., 1883).

POCAHONTAS (c.1595-1617). A celebrated Indian 'Princess,' daughter of Powhatan (q.v.). She is first mentioned in the *True Relation* (1608) of Capt. John Smith (q.v.) as "a child of tenne yeares old, which not only for feature, countenance, and proportion much exceedeth any of the rest of his [Powhatan's] people, but for wit and spirits the non-pareil of his country." She seems to have formed an attachment for the whites—especially for Smith—and to have been a frequent visitor at Jamestown until Smith left in October, 1609, when her visits ceased. In April, 1612, while at the village of her uncle, the 'King of Potowomek,' she was lured aboard an English vessel by Captain Argall, and was taken to Jamestown as a hostage for the return of several white prisoners and some stolen property. Here she was converted to Christianity and in April, 1613, was baptized and christened Rebecca. In April, 1614, she was married to John Rolfe (q.v.), with whom, two years later, she went to England, where she was received with great enthusiasm, as the daughter of an American 'King.' Then it was that the celebrated story about her rescue of Captain Smith first appeared. In a letter to the Queen (1616) Smith asserted that in 1607, when he, a captive among the Indians, was about to have his brains knocked out against a large stone, Pocahontas had "hazarded the beating out of her owne braines" to save his, and had on another occasion warned the English of a threatened Indian attack, besides furnishing food to the famishing colonists. It is for this rescue story, much elaborated and embellished by Smith in his *Generall Historie* (1624), that Pocahontas is chiefly remembered. Until Charles Deane attacked it in 1859, it was seldom questioned, but, owing largely to his criticisms, it soon became generally discredited. In recent years, however, there has been a tendency to retain it. Pocahontas died March 29, 1617, at Gravesend, and was there buried, the following

curious entry being made in the parish records: "1616 (1617), May 2 j, Rebecca Wrothe wyff of Thomas Wrothe, gent. a Virginia lady borne, here was buried in ye chauncell." Pocahontas and Rolfe had one son, Thomas, who, after living for many years in England, migrated to Virginia. From him many prominent Virginia families, including the Bollings, the Murrays, the Guys, the Whittles, the Robertsons, the Elbridges, and that branch of the Randolphs from which sprang John Randolph of Roanoke (q.v.), trace their descent. For arguments opposing the rescue story, consult Deane's edition of Smith's *True Relation* (1866), Neil's *Virginia Company in London* (1869), and Henry Adams's *Chapters of Erie and Other Essays* (New York, 1871); for arguments in its favor see: Arber, *Smith's Works* (1884); Poindexter, *Capt. John Smith and His Critics* (1893); W. W. Henry, *Proceedings of the Virginia Historical Society* (1882); and John Fiske, *Old Virginia and Her Neighbors* (1897). Consult, also: Eggleston and Seelye, *Pocahontas* (New York, 1879); and Robertson and Brock, *Pocahontas and Her Descendants* (1887).

POCATELLO. A city and the county-seat of Bannock County, Idaho, 134 miles north by west of Ogden, Utah; on the Port. Neuf River, and on the Utah Northern and the Oregon Short Line railroads (Map: Idaho, C 4). It is a division headquarters of these lines and has large railroad machine shops. The soil of the surrounding region is of volcanic origin, and has been made very productive by means of irrigation. Mining, stock-raising, and agriculture constitute the leading industries. The Academy of Idaho is located here. Pocatello is the second largest city in the State, having, in 1900, a population of 4046.

POCETTI, pò-chét'tè, BERNARDINO BARBATELLI (1542 or 1549-1612). An Italian painter, born at Florence, where he was a pupil of Michele di Ridolfo del Ghirlandajo. He enjoyed great reputation as a painter of grotesques, whence he was also named "Bernardino dalle grottesche," and after his return from Rome, where he had assiduously studied the works of Raphael and other great masters, executed a great number of mural paintings in Florence and throughout Tuscany, revealing himself as a graceful figure painter, who enriched his historical compositions with beautiful landscapes, sea views, fruits and flowers, besides magnificent draperies and tapestries, which he imitated to perfection. In Florence some of his frescoes may still be seen in Santissima Annunziata, in Santa Maria Novella, in the Monastery of San Marco, in the Certosa, in the Uffizi, and in the Pitti Palace. His finest ceiling pieces are reproduced in *Deckenmalereien des ersten Korridors der Uffizien zu Florenz* (Berlin, 1897).

POCCI, pò'chè, FRANZ, Count (1807-76). A German poet, artist, and musician, born at Munich and educated in law at Landshut and his native city. His first publications to attract attention were *Bildertöne für das Klavier* (1835) and *Sechs altdeutsche Männelieder* (1835), and he afterwards wrote many popular hunting and student songs. His further publications include *Dichtungen* (1843), *Dramatische Spiele* (1883), and *Gevatter Tod* (1855). He is, however, chiefly remembered by his literary-artistic productions for children, such as *Rosengärtlein* and *Lustiges Bilderbuch*.

POCHARD (also *poker*, formerly *poachard*, *poard*, from *poach*, from OF. *pocher*, *pucher*, Fr. *pocher*, to thrust, hit, from L.Ger. Dutch *poken*, to thrust, from Gael. *puc*, Ir., Corn. *poe*, push; OF. *pocher*, *poucher*, is also explained as from *pouce*, *poutec*, thumb, from Lat. *pollex*, thumb, from *pollere*, to be strong). An Old World sea-duck (*Aythya farina*), with a long, broad, and very flat bill, the wings short, and the tail short and rounded. It is smaller than the mallard, but rather larger than the widgeon. The head and neck are bright chestnut, the eyes red. The wind-pipe of the male, in all the pochards, terminates in a labyrinth composed partly of bone and partly of membrane. It breeds in far northern regions, and in winter migrates southward, even as far as Bengal. It is highly esteemed for the table. The canvasback and the redhead (qq.v.) of the United States are closely allied species. The pochard is also known as 'dun-bird' and 'poker.' See DUCK.

POCKET GOPHER, or POUCHIED GOPHER. Any gopher (q.v.) of the family Geomyidæ,

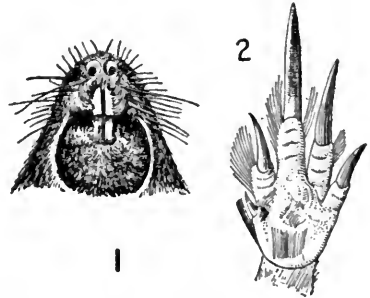

POCKET GOPHER.

1, The face, showing openings on each side of the cheek-pouches; 2, left fore foot, showing great digging claws.

characterized by their large cheek pouches, which are furry inside and open outside of the mouth. The 'salamander' of the Southern States and the

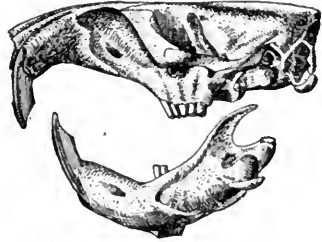

SKULL OF POCKET GOPHER.

common gopher of the Western prairies are examples. Consult *North American Fauna*, No. 8 (Department of Agriculture, Washington, 1898).

POCKET MOUSE. A mouse of the American family Heteromyidæ. They have external cheek-pouches, lined with fur and opening at the angles of the lips. Several forms live upon the arid plains of the Western United States and Mexico. The true pocket mice are small, grayish, nocturnal animals, that come out of their burrows only at night to gather seeds and the like, which they carry in their cheek-pouches into their holes and store there for winter use. Another genus includes the larger, brush-tailed, far-leaping kangaroo-rat (q.v.).

POCO, pō'kō (It., little). A term much used in music, as *poco animato*, rather animated; *poco forte*, abbreviated *pf.*, rather loud; *poco a poco* signifies by degrees, little by little; *poco a poco crescendo*, becoming loud by degrees; *poco a poco rallentando*, becoming slower by degrees.

PO'COCKE, or **POCOCK**, EDWARD (1604-91). An English Oriental scholar. He was born at Oxford, graduated B.A. from Corpus Christi College, Oxford, in 1622, and received priest's orders in 1629. He early turned his attention to Oriental studies and had the best teachers that England could supply. In the Bodleian Library he discovered a manuscript of the Syriac version of the New Testament, containing four epistles (II. Peter, II. and III. John, and Jude), which had been missing in the earlier editions, and published them under the title *Versio et notæ ad quatuor epistolas syriacæ* (Leyden, 1630). In 1629 he was appointed chaplain to the English 'Turkey Merchants' at Aleppo, and arrived at his post in October of the following year. He remained there for more than five years, during which time he mastered the Arabic language and continued the study of Hebrew, Syriac, Samaritan, and Ethiopic. He cultivated friendly relations with the natives and was extraordinarily successful in collecting valuable manuscripts. He performed the duties of his post faithfully, and in 1634, when the plague raged in Aleppo, remained in the town when others fled to the mountains. In 1636 Pococke returned to England to accept from Archbishop Laud an appointment as the first professor of a new Arabic 'lectureship' at Oxford. The following year he again went to the East to study and collect more manuscripts. For nearly three years he resided at Constantinople, returning to England in 1641. During the Civil War and the Commonwealth his connection with Laud and Royalist sympathies exposed him to much annoyance. His college presented him to the living at Childrey, Berkshire (1642), where his parishioners cheated him and quartered soldiers at the rectory. The revenues of the Arabic lectureship were illegally seized, but by the exertion of John Selden and other friends, Pococke was reinstated. He was made professor of Hebrew (1647), with a canonry, of which he was deprived in 1650, while allowed to retain his professorships through the unanimous interposition of all the heads of houses, masters, and scholars at Oxford. In 1655 a plan to deprive him of his living was defeated through the influence of John Owen and other enlightened men, who urged "the infinite contempt and reproach which would result from such treatment of a man whom all the learned, not of England only, but of all Europe, admired for his vast learning and accomplishments." During these troublous times Pococke steadily pursued his studies, and strove to fulfill all duties incumbent upon him, but professed that "to do anything that may ever so little molest the quiet of my conscience would be more grievous than the loss, not only of my fortunes, but even of my life." He published his great work, the *Specimen Historiæ Arabum*, at Oxford in 1649 (2d ed. by Joseph White, 1806). This work marks an epoch in Arabic studies, and all later scholars have borne testimony to its erudition and sound scholarship. Other works of the same period are the *Porta Mosis*, an edition of the six prefatory discourses of Maimonides on the

Mishna, with Latin translations and notes (1655); the *Contectio Gemmarum*, a Latin translation of the *Annals* of Eutychius (1658); and a treatise on *The Nature of the Drink Kauri or Coffee*, Described by an Arabian Physician (1659). He gave much assistance in the preparation of Walton's Polyglot (1657). At the Restoration he was reinstated in his canonry of Christ Church, and thenceforth lived in quiet and ease at Oxford, but with no abatement of his devotion to study. He published several works, the most important of which were his commentaries on the Minor Prophets (Micah and Malachi, 1677; Hosea, 1685; Joel, 1691). He died September 10, 1691. Pococke's life was written by the Rev. Leonard Twells and prefixed to his edition of *The Theological Works of the Learned Dr. Pococke* (2 vols., London, 1740).

POCOCKE, RICHARD (1704-65). An English clergyman and traveler. He was born at Southampton, and studied at Corpus Christi, Oxford. In 1725 he was appointed precentor of Lismore and in 1734 Vicar-General of the Diocese of Waterford and Lismore. The appointment was made during his absence, for from 1733 to 1736 he traveled through Europe to Greece. His passion for travel became established, and upon his return home he made tours through some of the southern counties of England, and came to be known as "Pococke the traveler." In 1737 he set forth upon a long journey to Egypt and the East, from which he returned in 1742, shortly afterwards publishing in folio *A Description of the East and of Some Other Countries*: vol. i., *Observations on Egypt* (1743); vol. ii., in two parts, *Observations on Palestine, or the Holy Land, Syria, Mesopotamia, Cyprus, and Candia* (1745). This work was dedicated to the Earl of Chesterfield, and earned for the author the Archdeaconry of Dublin (1755). In 1756 he was made Bishop of Ossory, and one of his first labors was the restoration of the beautiful cathedral church of Saint Canice in Kilkenny. He became interested in the study of Irish antiquities and wrote *An Account of Some Antiquities Found in Ireland* for the London Society of Antiquarians, which was published after his death in the second volume of the *Archæologia* (1773). Pococke made several journeys to Scotland, and in 1760, having prepared himself by extensive reading, he set out on a tour that led him as far as the Orkneys, from which he returned by the east coast, visiting, describing, and sketching nearly all the abbeys, ruins, and places of interest on his route. Between April and October he traveled 3391 miles on horseback. The accounts of his Scottish travels did not appear until brought out by the Scottish History Society, *Tours in Scotland, 1747, 1750, 1760*, edited, with a biographical sketch by Kemp (1887). Pococke's interests were not exclusively devoted to antiquarian research. He established the Lintown factory in 1763 to further the Irish linen trade, and left a bequest for its maintenance. As Pococke College it is still perpetuated under the Incorporated Society for Promoting English Protestant Schools in Ireland. In 1765 he was translated to the Bishopric of Meath. Accounts of his travels in England, Scotland, and Ireland were republished between 1888 and 1891.

PODAGRA. See GOUT.

PODARGE, pō-dār'jē (Lat., from Gk. ποδάργη, swift-footed). One of the Harpies (q.v.).

PODBIELSKI, pōd'bè-él'ské, THEOPHIL VON (1814-79). A Prussian general. He was born at Kopenick, studied at Liegnitz, and entered the army in 1831. He was quartermaster-general of the army in Schleswig and Holstein, held the same post in the war with Austria, after serving as director of the General Department of War, and is best known for his dispatches from the field in the Franco-Prussian war, when he was again quartermaster-general. Podbielski was appointed inspector-general of artillery after the close of the French campaign.

PODBIELSKI, VICTOR VON (1844—). A German officer and statesman, born at Frankfort-on-the-Oder. He was trained for the army in Berlin and in 1862 joined the Eleventh Lancers. During the Franco-German War he served on the general staff of the Tenth Army Corps, later acted as major-general of the Thirty-fourth Cavalry Brigade, and was promoted to be lieutenant-general in 1896. He entered the Reichstag in 1893 and allied himself with the Conservative Party, and in 1897 succeeded von Stephan as head of the Imperial postal service, distinguishing his administration by many reforms. In 1898 he was made Privy Councilor, and in 1901 he became Prussian Minister of Agriculture.

POD CORN. See MAIZE.

PODESTÀ, pō-dēs-tà' (It., power). A term applied to the chief magistrate in the mediæval States of Italy. The office of podestà appears to have been first instituted in the twelfth century, when the Emperor Frederick Barbarossa, having for a brief term reestablished the Imperial authority in Lombardy, placed officers with almost supreme power over the various towns. When the Lombards afterwards rose in rebellion against Frederick, the office was abrogated, but it was soon revived by themselves. As the chief cause of the appointment of the podestà was the jealousy that existed between the richer citizens and the nobles, he was usually a citizen of some neighboring State, who had formed no entangling alliances. During his term of office he was prohibited from cultivating any intimate connections in the city which he governed. The podestà usually held office for a year only, but occasionally his power became so great that he secured reelection during a succession of years and was the despotic ruler of the city.

PODGORZE, pōd-gōr'zhe. A town in the Crownland of Galicia, Austria, on the right bank of the Vistula, opposite Cracow (Map: Austria, F 1). It has brickyards, cement and leather factories, salt works, and a good trade in trimmed lumber and eggs. Population, in 1890, 13,100; in 1900, 18,100, mostly Poles, and more than one-third Jews.

PODIEBRAD, pō'dye-brád, GEORGE (1420-71). King of Bohemia from 1458 to 1471. He was born at Podiebrad in 1420, the son of a Bohemian noble, Herant of Podiebrad and Kunstatt. He adhered to the moderate party of the Hussites during the reign of Sigismund; but when, on the death of that monarch, the Catholic barons (1438) carried the election of Albert V. of Austria (II. of Germany), Podiebrad allied himself with the Utraquists, who offered the sovereignty of Bohemia to Casimir, brother of Ladislas III., King of Poland. From this time Podiebrad's influence gradually increased, and in 1444 he became the

leader of the party of Utraquists, and was made administrator of the realm during the minority of the child King, Ladislas Posthumus, the son of Albert. In 1448 he obtained possession of Prague, and in 1452 was acknowledged Regent by the whole of Bohemia. Ladislas Posthumus died in 1457, and in 1458 Podiebrad was chosen his successor, and was crowned May 7, 1459. He strove to bring about a peaceful settlement of the religious discussions that had desolated the land, and agreed secretly to lead the country back to the Roman Catholic Church. When, however, he failed to fulfill this promise, upholding the Utraquists, he was excommunicated by Pope Pius II. in 1463 and by the successor of that pontiff, Paul II., in 1466. The Catholics of Bohemia were incited to insurrection, and Matthias Corvinus (q.v.), King of Hungary, the son-in-law of Podiebrad, was induced to invade Bohemia. The Hungarians were surrounded at Wilimow, and forced to cease from hostilities. In spite of the magnanimity shown by Podiebrad on this occasion, Matthias acted falsely toward him, and in the following year had himself crowned King of Bohemia and Margrave of Moravia. Podiebrad instantly summoned the Bohemian diet, and proposed to the assembled orders that they should take Ladislas, son of Casimir IV., King of Poland, as his successor, while his own sons should merely retain the family possessions. By this means he obtained the Poles for allies; the Emperor Frederick III. also declared in his favor, while his Catholic subjects were reconciled to him, so that the Hungarians found it advisable to conclude a peace. Podiebrad died March 22, 1471. Consult: Jordan, *Das Königthum Georgs von Podiebrad* (Leipzig, 1861); Bachmann, *Böhmen und seine Nachbarländer unter Georg von Podiebrad* (Prague, 1878).

PODIUM (Lat., from Gk. *πόδιον*, *podion*, little foot, diminutive of *πούς*, *pous*, *foot*). In classic architecture, a continuous base or pedestal in the form of a wall not broken by steps like the base of a Greek temple, but distinguished, like an enlarged pedestal, merely by a base at the bottom and a corona at the top. It was generally used to support rows of columns, or as the base of a sepulchral or memorial monument. Its name was extended to the basement of the outer wall of the interior of an amphitheatre or circus.

PODOCARPUS (Neo-Lat., from Gk. *πούς*, *pous*, *foot* + *καρπός*, *karpos*, *fruit*; so called from the thick stalk which, unlike the case of other conifers, supports the fruit). A genus of trees of the natural order Conifere. The leaves, like those of the allied ginkgo tree, have a remarkable resemblance to the fronds of ferns. The species are natives of New Zealand and the South Sea Islands and the Indian Archipelago. Some of them are valuable timber trees, e.g. *Podocarpus cupressina*, of Java and the neighboring islands and the South Sea Islands, a beautiful species 50 or 80 feet tall, with spreading pendulous branches, and yellow wood that takes a fine polish. *Podocarpus Totarra*, the totarra or totarra pine, is the most valuable timber tree of New Zealand, in the southern parts of which country its trunk has been known to attain a diameter of 12 feet. Its wood is equal to the best Baltic pine in durability and for shipbuilding. The wood of *Podocarpus clata*, the gagali of the

Fijians, is peculiarly elastic. It abounds in Queensland and New South Wales, where it becomes 100 feet in height and two to three feet in diameter. The timber is free from knots, soft, close-grained, and easily worked, and is much used for cabinet and joiners' work. A shrubby species, *Podocarpus spinulosa*, also a native of Australia, produces an edible fruit. See DACRYDIUM.

PODOLIA, πόδω'lyá. A government of South-western Russia, bounded by the Government of Volhynia on the north, Kiev on the east, Kherston and Bessarabia on the south, and the Austrian Crownland of Galicia on the west (Map: Russia, C 5). Area, 16,240 square miles. The region is traversed from northwest to southeast by two ranges of hills separated from each other by the valley of the Bug. The Dnieper flows along the southwestern boundary. The climate is moderate, the annual temperature at Kamenetz-Podolsk, the capital, averaging 48.4°. Podolia has a rich black soil yielding considerable quantities of grain for export. Besides cereals there are raised tobacco and large quantities of sugar beets for the local sugar mills. The chief products of the house industry are textiles. In 1896 there were in Podolia about 5200 manufacturing establishments, with 28,500 employees and an output valued at more than \$19,000,000. The principal manufactured products are sugar (in the production of which Podolia is exceeded only by the Government of Kiev), spirits, flour, and tobacco. Population, in 1897, 3,031,500, including over 240,000 Roman Catholics, and nearly 400,000 Jews.

PODOPHYLLIN (from Neo-Lat. *Podophyllum*, from Gk. πούς, *pous*, foot + φύλλον, *phyllo*, leaf, so called because the five or seven divisions of the leaf bore a fancied resemblance to the foot of some animal). The name commonly given to the resin obtained by means of rectified spirit from the root of *Podophyllum peltatum*, or May-apple, a plant common throughout the United States. This resin, which occurs as a pale greenish amorphous powder, has (as well as the root from which it is derived) been introduced into the United States pharmacopœia. It is an active purgative, and seems to have the power of relieving the liver by exciting copious bilious discharges. As its activity seems to vary in different patients, it is better to begin with a small dose of half a grain, which may be combined with extract of henbane (hyoseyamus) to prevent griping. Podophyllin is very soluble in alcohol and moderately so in ether. *Picropodophyllin* is said to be the constituent to which the purgative properties of the resin are due.

PODOPHYLLUM (Neo-Lat., from Gk. πούς, *pous*, foot + ύλλον, *phyllo*, leaf). A genus of plants of the natural order Berberidaceæ. *Podophyllum peltatum*, called May-apple, mandrake (q.v.), hog-apple, and wild lemon, is a common perennial plant in moist woods of North America. Its solitary white flower in the axil of the two leaves is followed by an oval, smooth, yellowish, succulent, mawkishly sweet, subacid fruit, which is not generally considered agreeable.

PODSNAP, Mr. A character in Dickens's *Our Mutual Friend*, a type of a heavy British gentleman, perfectly satisfied with the ways of Providence, which represented exactly his own views. His wife was a bony, hard-featured

woman in a majestic headdress, and his daughter, whom he called 'the young person,' was a quiet, inoffensive girl.

POE, EDGAR ALLAN (1809-49). An American poet and prose writer, born in Boston, January 19, 1809. The grandson of a prominent patriot during the War of the Revolution, the son of an actor whose wife was his superior in charm if not in power on the stage, Poe shared for several years the wandering life and vicissitudes of his parents, but after his mother's early death was adopted by Mrs. John Allan, the wife of a business man of Richmond, Va. The boy's personality gave promise of fascinating qualities, and he was given the best educational opportunities within the reach of his adopted parents. He was sent to a good school in Richmond; was taken to England in 1815 and placed in the Manor House School in the neighborhood of London, amid surroundings which made a deep impression on his sensitive imagination. In one of his most striking sketches, "William Wilson," he recalled in vivid description the school, the village, and the old church to which the boys were paraded twice on Sunday. In 1820 the Allans returned to Richmond and Edgar read the classics and studied French under a pedantic Irish teacher, learning with great quickness, versatile, fond of reading, somewhat given to satirical comment on his fellows, agile and vigorous in movement and courteous in manner. In 1826 Poe entered the University of Virginia, which had just been established by Thomas Jefferson at Charlottesville on new and promising lines of organization and methods of work. In the schools of ancient and modern languages in which he studied, Poe gave his attention chiefly to Latin, Greek, Spanish, French, and Italian. Heavy drinking and card-playing for money were popular forms of dissipation among students, and Poe's life was not free from excesses. There is, however, no foundation for the reports of excessive indulgence in these vices; he seems to have been neither better nor worse than many of his contemporaries. At the end of the first session he won honors in Latin and French, but his irregularities offended Mr. Allan, and Poe was placed in his adopted father's counting-room. The work was very distasteful to him, and he soon made his escape from its drudgery to reappear in Boston, where his earliest volume, *Tamerlane, and Other Poems*, was brought out by an amateur publisher in 1827. The influence of Byron was then at its height, and Poe's work showed how sympathetically he had studied the English poet whose mastery of the lyric form has given him a foremost place among the singing poets. The verse in the little volume was notable neither for power nor promise of original thought, but it was full of poetic feeling, of sensitiveness to the melody of words, and of rich imagery. In May, 1827, Poe enlisted in the United States Army as a private soldier, served two years with fidelity, was honorably discharged, secured a reconciliation with Mr. Allan, and furnished more substantial evidence of his possession of original power by the publication of "Al Araaf" and other minor poems in Baltimore in 1829. Mr. Allan married a second time in October, 1830, having previously, by way of settling his wayward ward in life, secured for him an appointment to the Military Academy at West Point. Poe was then twenty-one

years of age, a ready French scholar, had read widely if not wisely, and was a good mathematician. He was, however, neglectful of his military duties, was often under arrest, and at the end of six months was dismissed from the Academy by court-martial. He was penniless and could no longer look to Mr. Allan for aid. In March, 1831, another volume from his hand appeared, this time in New York, under the title *Poems*. All the poems save six which had appeared in the previous volume were reprinted, with important changes in several instances, and six additional pieces were given to the public. Among the latter were "The Valley of Unrest," "The City in the Sea," "Lenore," "To Helen," and "Israfel." No poetry of kindred beauty had appeared in America, and in certain respects those remarkable poems have not been surpassed. They showed a wonderfully sensitive ear for verbal notation, a touch so delicate and sure that it may be described as magical, and an imagination at once sombre and beautiful. An artist by temperament and by imitation, Poe had no lessons to teach, no truths to enforce. He cared supremely for beauty for its own sake; and so completely did he master the resources of verse that he was able, by mere collocation of sound, to produce an almost hypnotic effect, to throw a spell over his readers the secret of which resides in the beguiling of the ear quite as much as in the awakening of the imagination.

The poet's activities were henceforth concentrated on the task of supporting himself with his pen—a task which was rendered exceedingly difficult, not by lack of opportunities or of friends, but by irregularities of life and a restive, sensitive, and capricious temperament. In Baltimore, where he next endeavored to secure a foothold, he found friends and made his first popular success by winning a prize of \$100 offered by *The Saturday Visitor*, a monthly literary journal, for the best prose story. The story selected by the judges was "A Manuscript Found in a Bottle." Poe was then living with his father's widowed sister, Mrs. Clemm, whose daughter Virginia, then eleven years old, he married two years later. In the meantime Mr. Allan had died without any recognition of his adopted son in his will, and the poet was at last compelled to face life with such resources as nature had given him. These were ample if they had been wisely directed and husbanded. He had proved himself a master of lyrical poetry and of the short story, and he was beginning to write criticism of a new order in America. He was also drinking too often and too freely, and his abnormally sensitive nervous organization was seriously affected and finally shattered by an indulgence which to men of more vigorous physique would have been of slight physical importance. The uncertainty of his life, the pronounced strain of melancholy in his temperament, the brooding intensity of his imagination, the weakness of his will, and the terrible strain of his wife's long illness contributed to make him the victim of a habit against which he fought at times with desperate courage, and for long periods with success. He was never, except for short periods, what is known as a dissipated man; but strong drink of any kind was a poison to him and the least indulgence prostrated him.

From Baltimore Poe removed to Richmond, which he always regarded as his home and where

he found congenial and helpful friends. As editor of *The Southern Literary Messenger* he secured the happiest conditions which he was to know. He was an indefatigable worker, producing stories, poems, and critiques with ease, and at this time with evident pleasure. To this period belong a number of his most characteristic tales of fantasy: "Berenice," "The Fall of the House of Usher," "Ligeia," "Eleonora," "The Masque of the Red Death." These tales were not without forerunners in other literatures, but they combined a quality of imagination, a skill in taking possession of the imagination of the reader, and a perfection of form which have given them a place by themselves in the literature of the world. They close in upon the mind, by a subtle use of suggestion and repetition, until a purely phantasmal world becomes real and abnormal figures take on the semblance of life. The skill with which the transition from the actual to the phantasmal is effected is the supreme triumph of Poe's art in fiction. The men and women who appear in these tales are all phantoms, without warmth, passion, character; they, and the realm in which they move, are stamped with unreality. Poe's great limitation lies in the narrowness of his range and the lack of deep-rooted vitality in the creatures of his imagination. He deals habitually with abnormal aspects of life and phases of experience. His landscapes, characters, incidents are all in the realm of fantasy. These characteristics place him in the ranks of the modern Decadents, whom he has deeply influenced; but he differs widely from the men who have followed his lead in the absolute purity of his thought and imagination.

In 1835 literature of high quality was being produced in the United States, but public taste was uneducated, and crude, sentimental, and cheap fiction was widely read. In the columns of *The Southern Literary Messenger* Poe began to print criticism of a kind and quality which was new to most American readers. He broke away entirely from the trammels of provincialism in taste and judgment, and applied to current writing the standards of the literature of the world. His handling of "Norman Leslie," a popular novel of the day, arrested attention by reason of its vigor, its sarcasm, its disclosure of a genuine gift for analysis and appraisal of literary values. The critic, it was evident, was not averse to the use of the keenest weapons, but used them for high purposes. He was bent on exposing literary pretension and breaking the influence of mediocrity in American letters, and he rendered a genuine service to sound taste and therefore to the development of good literature by his critical work. He lacked the spiritual insight of critics of the highest class, but he had wide acquaintance with the best in literature, rare power of analysis, and a very delicate sense of form. Above all, he was largely free from provincial prejudices and capable of judging a work of art on its merits. He recognized the genius of Hawthorne at the very start; he was quick to set its full value on Tennyson's early verse; he discerned the significance of Bryant, Lowell, and Cooper. His occasional failure to comprehend the spirit and method of a contemporary was most strikingly shown in his unfortunate attack on Longfellow, whom he accused of plagiarizing.

Poe had many opportunities, but his temperament made it impossible to establish comfortable and permanent working relations. In 1837, when a disastrous financial panic was at its height, he arrived in New York with very ambitious purposes, but with no resources. "The Narrative of Arthur Gordon Pym," published the following year, added nothing to his reputation and little to his income. The autumn of 1838 found Poe in Philadelphia, where he wrote two of his most characteristic pieces, "Silence" and "The Haunted Palace." The poem shows an ethical feeling which no other work from the same hand reveals. Two volumes made up of stories and sketches appeared in 1839, and contained some of the most original work which America has produced.

"The Fall of the House of Usher," "Ligeia," "William Wilson," and "Silence" exhibit Poe's power of invention, vividness of imagination, and skill as an artist at their best; and in perfection of form these prose pieces rank with "Israfel," "To Helen," and "The City in the Sea." To this period belong also those tales of ratiocination which are among the best of their kind and have borne fruit in an abundant harvest of similar or imitative stories. "The Gold Bug," "The Purloined Letter," "The Mystery of Marie Roget," and "The Murders of the Rue Morgue" are on a lower order of imagination than the tales of fantasy, but they are marvelous pieces of invention.

During this period Poe was undergoing the torture of uncertainty with regard to his wife, whom he devotedly loved, and who was continuously and often desperately ill. Under this strain his power of resistance grew weaker, he yielded more easily and frequently to the craving for stimulants, and his unusual power of concentration gradually relaxed.

The position of editor of *Graham's Magazine*, in which he had revealed editorial ability of a high order, was given up or lost, and in 1844 Poe returned to New York with very little money and with a great sorrow impending in the near future. He was still, however, to achieve some of his most striking successes. In 1845 "The Raven," which gave him his immense popular reputation, appeared, and was followed by "The Bells" and "Ulalume." No American poems are more widely known, and in none is his marvelous command of the subtle resources of sound, his magical use of vowels, of repetition, of parallelism, so skillfully used to convey definite and striking effects. His collected poems were published at this time under the title, *The Raven, and Other Poems*, and in the preface to the collection is a piece of autobiography. "Events not to be controlled," he wrote, "have prevented me from making at any time any serious effort in what, under happier circumstances, would have been the field of my choice." He was then living in a cottage at Fordham, near New York; and there, in January, 1847, his wife died, and the poet was prostrated by a long illness. He was cared for by friends and finally recovered a degree of strength, but he was really a shattered man. He wrote "Eureka: A Prose Poem," marked by his characteristic inventiveness, put the finishing touches on "The Domain of Arnheim," and delivered a few lectures; but both his mind and his will bore traces of his great suffering. In June, 1849, he went to Richmond, was ill as the result of excesses in Philadelphia, was

shown much kindness and recovered something of his old spirit in the capital of Virginia. Late in September he started to return to New York. The story of the next few days will never be clearly told; but on an afternoon in the week following his departure from Richmond he was found in a drinking-place in Baltimore, taken to a hospital in an unconscious condition, and died four days later.

Of the three forms of Poe's literary activity his criticism, while of high importance at the time, is of least value; his prose tales have taken their place in the literature of the world by reason of their originality of motive and their finished art; while his poetry remains the most distinctive expression of his genius. In two important studies, "The Poetic Principle" and "The Rationale of Verse," he declared that truth gives expression to the intellect and passion to the heart, while beauty is the language of the soul. Beauty is, therefore, the highest form of creative activity; passion and truth are involved in it, but its chief aim is to produce a definite and convincing impression of its own nature by stimulating the imagination. He defined poetry as "the rhythmical creation of beauty," and laid down the law that beauty is essential to lyrical perfection in the phrase "a long poem does not exist." He also held that a marked quality of metre or rhythm ought to characterize all verse.

BIBLIOGRAPHY. Numerous editions of Poe's work have appeared since his death. That of Griswold (2d ed., 4 vols., New York, 1856) is prefaced by a biography which later writers consider prejudiced to the point of calumny; and the biography in the Stoddard edition (6 vols., new ed., New York, 1895), while deprecating Griswold's extreme view, is also biased. The Diamond edition (Boston, 1874) has a sketch by Gill. Later editions are by Ingram (2d ed., 4 vols., Edinburgh, 1880; New York, 1894); Stedman and Woodberry (10 vols., Chicago, 1895), a scholarly and complete edition; and the Virginia edition by Harrison, with notes by Stewart (17 vols., Boston, 1902), in which is included, in addition to the complete works of the poet, all the obtainable information as to his life, and a full bibliography. Poe's *Tales* have been translated into French by Baudelaire and are in his *Œuvres complètes*, vols. v.-vii. (Paris, 1878-82). There are also German and Spanish translations. The *Poems* have been published separately with memoirs by Hannay (London, 1865), Blanchard (ib., 1857), and Briggs (New York, 1859). Of the numerous biographies, Whitman, *Edgar Allan Poe and His Critics* (New York, 1860); Gill, *Life of Edgar Allan Poe* (5th ed., ib., 1880); and Ingram, *Edgar Allan Poe: His Life, Letters, and Opinions* (2d ed., London, 1886), are answers to Griswold's assertions. The *Life* by Didier (New York, 1877) is not entirely trustworthy. There are essays by Baudelaire prefixed to volumes v. and vi. of his *Œuvres complètes*, above mentioned, and by Stedman, in *Poets of America* (New York, 1880). The most critical *Life* is by Woodberry, in the "American Men of Letters Series" (Boston, 1885). A selection from Poe's correspondence, edited by Woodberry, appeared in the *Century Magazine*, vol. xxvi. (New York, 1894).

POE, ORLANDO METCALFE (1832-95). An American soldier, born at Navarre, Ohio. He graduated at West Point in 1856, and entered the

corps of topographical engineers. In 1861 he served for a time as chief engineer of the Department of Ohio, but later was made colonel of the Second Michigan Volunteers, and in 1862 took part in the Virginia and Maryland campaigns. On November 29th he was made brigadier-general of volunteers. The next spring he was transferred to the West as chief engineer of the Central District of Kentucky, and was Burnside's chief engineer during the defense of Knoxville (November 18-December 4, 1863), when he earned the brevet of major in the Regular Army. In 1864 he was appointed chief engineer of Sherman's army, participating in the invasion of Georgia and the campaign which ended with the surrender of General J. E. Johnston. He was brevetted brigadier-general in the Regular Army in 1865, and was commissioned colonel of engineers in 1888. After the Civil War he was for a number of years secretary of the United States Board of Lighthouse Commissioners, and had charge of the construction of many important river and harbor works, among them the Spectacle Reef and Stannard Rock Lighthouses and the great lock on the Sault Ste. Marie.

PŒCILE (Lat., from Gk. ποικιλῆ, *poikilē*, variegated). The name given, because of the paintings which adorned it, to a famous *stoa*, or portico, in Athens, from which the Stoics (q.v.) were named.

PŒNULUS (Lat., the young Carthaginian). A comedy by Plautus, imitated from the *Καρχηδόβιος* of Menander and produced in B.C. 189. The chief character is a Carthaginian who is stolen at an early age. He becomes enamored of one of two girls who eventually turn out to be his cousins. The play contains a famous Phœnician passage in Latin characters.

POERIO, pŏ-ā-rĕ-ō. CARLO. Baron (1803-67). An Italian patriot. He was born at Naples, December 10, 1803. In 1828 he joined the liberals of Naples and took part in the conspiracy of Avellino, for which he was imprisoned for a long time. He was concerned in the abortive attempt of 1847, but was discovered, and after the movement at Reggio was sent back to prison. The revolution which broke out at Palermo, January 12, 1848, set him at liberty, and he immediately gave himself to the organization of the famous demonstration of January 27, 1848, which brought about the Constitution of February 10th. Poerio was nominated director of police and Minister of Public Instruction; but he soon resigned. He was chosen Deputy to the Parliament. In 1849 the Government made extraordinary efforts to convict him of conspiring against it, but no valid case was made, and on the testimony of a suborned witness he was sentenced to twenty-four years' imprisonment. In January, 1859, Poerio and other political prisoners were put on board of a vessel in order to be transported to South America, but were transferred to an American ship, which landed them at Cork, whence they returned, by London, to Turin. In the following year Poerio was elected Deputy from Tuscany and took his seat in Parliament. When Garibaldi (q.v.) had driven out the Bourbon dynasty, Poerio returned to Naples. He became a member of the Privy Council, and subsequently vice-president of the Parliament. He died at Florence.

POETASTER, THE. A comedy by Ben Jonson (1601), attacking Marston and Dekker, to

which they retorted with *Satiromastix*. The scene is Rome in the time of Augustus; Marston appears as Crispinus, Dekker as Demetrius, and they are punished for conspiracy against Horace, representing Jonson.

POET AT THE BREAKFAST TABLE. **TIT.** A series of essays and poems by Oliver Wendell Holmes, contributed to the *Atlantic Monthly*, in 1871. These delightful sketches, in the vein of the *Autocrat* and the *Professor*, differ only in the seriousness of tone and subject.

POETICS (Gk. περί ποιητικῆς, *peri poiētikēs*). A fragmentary treatise by Aristotle on the philosophy of art, and especially of poetry. All we have of it (and possibly all that was ever written) is the discussion of epic poetry and the tragic drama, fortunately enriched with many allusions to the other arts; but restricted as it is, this treatise is unquestionably the most important work on criticism ever written, intrinsically as well as historically. Art, in Aristotle's conception, is 'imitation of life,' and its purpose is to give pleasure. This doctrine can be fully understood only in the light of Aristotle's metaphysical conceptions. He defines life as action or as an activity, and undoubtedly has in mind what elsewhere he calls the formal and moving causes, corresponding very closely to Plato's 'Ideas;' the 'imitation,' therefore, has a far subtler meaning than first appears, referring to the instinctive idealizations which underlie artistic embodiments, and form the essence of the artist's effort. Again, pleasure as the purpose of art must be understood to refer only to the finer satisfactions of taste; in no sense are gross enjoyments intended. Poetry, Aristotle held, appears as a result of a natural instinct and of native love of rhythm. At the same time the poet must have the "gift of metaphor," and this comes "not by art, but as a happy gift of nature." Perhaps the most acute of Aristotle's æsthetic theories is his explanation of the office of tragedy. This he finds to be a purgation of the passions, *katharsis*, through terror and noble pity. It is an exercise of the emotions in moderation, and so a relief of the tendency to emotional expression which men naturally have, without the wrack and strain which extreme emotion incurs. Hence it is akin to physical purgation, and is further a kind of pleasure because it contributes to that general temperance which was the Greek ideal of excellence. Consult: Butcher, *Aristotle's Theory of Poetry and Fine Art, with a Critical Text and Translation of the Poetics* (3d ed., New York, 1903).

POET LAUREATE. See LAUREATE, POET.

POETRY. See literatures of the various nations, as ENGLISH, FRENCH, GREEK, INDIAN, PROVENÇAL, etc. See, also, EPIC POETRY; LYRIC POETRY; PASTORAL POETRY; VERSIFICATION; RHYME; BLANK VERSE; EPIGRAM; MADRIGAL; SONNET; BALLAD; BALLADE; MINSTREL; TROUBADOUR; MEISTERSINGER; MINNESINGER. See, too, individual poems, such as the MAHABHARATA; VEDA; BEOWULF; ROLAND; NIBELUNGENLIED; VOLSUNGER SAGA, etc.

POETRY, SPASMODIC SCHOOL OF. A name sometimes applied to certain English authors of the nineteenth century whose writings are strained and unnatural in style. Of this class the best known are Philip James Bailey,

Alexander Smith, Sydney Dobell, and Gerald Massey (q.v.).

POETS' CORNER. The popular name given to a part of the south transept of Westminster Abbey containing the tombs and memorials of a number of Englishmen eminent in letters. The memorials include those of Chaucer, Dryden, Milton, Shakespeare, Spenser, Addison, Ben Jonson, Macaulay, Wordsworth, the American Longfellow, and others.

POEY, pŏ'a, **FELIPE** (1799-1891). A Cuban naturalist, born in Havana. In 1826 he went to Paris, where he studied zoölogy and aided in founding the Entomological Society of France. In 1833 he returned to Havana and devoted himself to the study of Cuban fauna, particularly fishes, of which he discovered many new species. In 1842 he was appointed professor of comparative anatomy and zoölogy at the University of Havana, a position which he held until his death. The most important of his publications are: *Memorias sobre la historia natural de la Isla de Cuba* (1860); *Reportorio fisico-natural de la Isla de Cuba*; and *Enumeratio Piscium Cubensium* (1875). His greatest work, *Ictiologia Cubana*, was still in manuscript at the time of his death.

POGE, CAPE. See CAPE POGGE.

POGGE, pŏ'ge, **PAUL** (1839-84). A German explorer of Africa, born at Ziersdorf, in Mecklenburg. In 1874 he joined Hoyer's expedition, and in December of 1875 alone reached Musamba, the capital of Muata Jamvo, the farthest point inland reached at that time by an explorer of the German Company. In 1880, with Wissman, he set out to explore the southern basin of the Congo. They separated at Nyangwe in 1882, and Pogge established a station near Mukenge. He died at Loando just as he was starting back to Europe. He wrote *Im Reiche des Muata Jamvo* (1880).

POGGENDORF, pŏg'gen-dŏrf, **JOHANN CHRISTIAN** (1796-1877). A German physicist, chemist, and editor. He was born at Hamburg, studied pharmacy, chemistry, and physics, and was connected with the University of Berlin from 1840 until his death, serving as professor from 1834. In 1838 he became a member of the Berlin Academy of Sciences. His chief discoveries were in connection with electricity and magnetism, but he is best known perhaps for the fact that from 1824 he edited the *Annalen der Physik und Chemie*, to which he contributed many important memoirs. In connection with Liebig and Wohler he prepared the *Handwörterbuch der Chemie* (Brunswick, 1837-51). He also published the *Lebenslinien zur Geschichte der exakten Wissenschaften* (Berlin, 1853), and *Biographisch-literarisches Handwörterbuch zur Geschichte der exakten Wissenschaften* (Leipzig, 1858-63, 2 vols.), subsequent editions of which have been issued. The *Geschichte der Physik*, edited by W. Barenten, was published in 1879. A biography of Poggendorf will be found in vol. elx. of the *Annalen*.

POGGIO BRACCIOLINI, pŏd'jŏ brä'chŏ-lĕ'nĕ, **GIOVANNI FRANCESCO** (1380-1459). A distinguished Italian scholar and author in the Renaissance period. He was born at Terranuova, near Florence, and after studying under John of Ravenna and Manuel Chrysoloras became a

copyist of manuscripts. His skill in that pursuit attracted the attention of the leading Florentine scholars, and at the age of twenty-two he entered the service of Pope Boniface IX. as Apostolic Secretary. He served in the same capacity under the seven succeeding popes (1404-53), attended the Council of Constance in 1414, and was present at the trial and martyrdom of Jerome of Prague, of which he wrote an almost sympathizing account. For the most part, however, he seems to have cared little for the important political and ecclesiastical movements of the period, and is remembered chiefly for his persevering and successful researches in various European monasteries where masterpieces of classic literature were lying unknown. Among the manuscripts he thus recovered were those of Quintilian (complete), the great philosophic poem of Lucretius, *De Natura Rerum*, seven orations of Cicero, twelve plays of Plautus, the commentaries of Aconius Pedianus, the history of Ammianus Marcellinus, Petronius, the *Dialogus* and *Germania* of Tacitus, and the fragment of Suetonius, *De Grammaticis et Rhetoribus*. Among his own works, all of which are in Latin, are a collection of *Letters* (1437); various moral essays, including *De Nobilitate Dialogus* and *De Varietate Fortunæ*; *Historia Florentina*, written in imitation of the style of Livy; and his most famous work, *Liber Facietiarum* (ed. by I. Liseur, Paris, 1878), a collection of violent and often indecent diatribes against the monks and clergy. The most scurrilous are those against Valla and Filelfo, with whom he was engaged in a long and bitter controversy. His works contain lively descriptions of the life and customs of various European countries, and valuable notes on the remains of antique art in Rome. He spent his last years at Florence, where he was chosen Chancellor. The material for the collection of French tales *Cent nouvelles nouvelles* (q.v.) was taken in part from the works of Poggio. His statue in the Cathedral of Florence is the work of Donatello. Consult the *Life* by Shepherú (Liverpool, 1802), and Symond's *Renaissance in Italy*.

POGO'DIN, MIKHAIL PETROVICH (1800-75). A Russian historian and archaeologist. Appointed professor at the Moscow University in 1830, he resigned in 1844 to devote himself to literature and the study of archaeology. His collection of Russian antiquities was bought by the Government. He published in 1841-56 a literary and political periodical called *The Mŏscovite*, in which he advocated Pan Slavism. His efforts in various kinds of literature are of little importance. Several monographs on special periods of Russian history, with his unfinished *Russian History* (7 vols., 1846-59), which is important for the material gathered, are his chief works of value.

POGY. The menhaden (q.v.).

POHL, pŏl, **RICHARD** (1826-96). A German writer on music. He was born in Leipzig, studied at Chemnitz and Karlsruhe, at Göttingen and Leipzig, taught in Gratz, and then devoted himself to music, living in Dresden (1852-54), in Weimar (1854-63), and in Baden-Baden from 1863 till his death. He edited the *Badeblatt* and (1856-60) *Anregungen für Kunst und Wissenschaft*. His musical critiques, some of which were published under the name *Hoplit*, did much to bring into favor the 'new German' school of

music. Pohl's chief works include: *Akustische Briefe* (1853); *Baireuther Erinnerungen* (1877); *Autobiographisches* (1881); *Richard Wagner* (1883); *Franz Liszt* (1883); *Hektor Berlioz* (1884); *Die Höhenzüge der musikalischen Entwicklung* (1888), as well as poems.

POHLE, pō'le, LEON (1841—). A German genre and portrait painter, born at Leipzig. He studied at the Dresden Academy (from 1856), then at Antwerp, under Van Lerius and under Pauwels at Weimar, and was appointed professor at the Dresden Academy in 1877. Having at first cultivated genre and history, he confined himself afterwards more and more to portraiture, and in this line produced such fine examples as the portraits of Ludwig Riecher (1872, Leipzig Museum, and 1880, National Gallery, Berlin), of the painter Karl Peschel (1880, Dresden Gallery), of the sculptor Hähnel, and of Baron Tauchnitz (both in the Leipzig Museum). Of his genre scenes, the Berlin Gallery contains an "Elegy," and the Dresden Gallery "Ecole Torniamenti."

POI. A fermented food product made from the starchy root of *Colocassia antiquorum*. It is very popular in the Hawaiian Islands. See Cocco.

POINCARÉ, pwān'ká'rā', JULES HENRY (1854—). A French mathematician and physicist, born at Nancy. He entered the Ecole Polytechnique in 1873, but left two years later to take up work in the School of Mines. He became an engineer in 1879, and in the same year doctor of sciences. In 1881 he was called to Paris, where in 1886 he became professor of mathematical physics and calculus of probabilities in the Faculty of Sciences. At the death of Tisserand (1896) he changed this chair for that of celestial mechanics. In 1887 he was made member of the Academy of Sciences at Paris, and after 1893 was a member of the Bureau of Longitudes (after 1898 its president). In 1889 he obtained the prize awarded by King Oscar of Sweden for a work on the problem of the three bodies (q.v.). Poincaré has become known as one of the greatest mathematicians produced by France in the last century. A disciple of Cauchy, he has carried out the investigations of the latter along the various lines of the theory of functions, and he has also applied his remarkable mathematical powers to profound researches in the domain of physics. He has introduced into mathematics a new class of transcendents, analogous to, but more general than, the elliptic functions, which he has named the Fuchsian functions in honor of Immanuel Fuchs (q.v.). He has also introduced in connection with these functions a new class of groups, also called Fuchsian. He has contributed to the theory of non-Euclidean geometry, to the theory of differential equations, and to various branches of higher algebra.

His works include: *Les méthodes nouvelles de la mécanique céleste* (3 vols., 1892-99); *Calcul des probabilités* (ed. by Quiquet, 1896); *Capillarité* (ed. by Blondin, 1895); *Cinématique et mécanismes potentiels et mécanique des fluides* (ed. by Guillet, 1899); *Electricité et optique* (2 vols., 1890-91); *Thermodynamique* (ed. by Blondin, 1892); *Leçons sur la théorie mathématique de la lumière* (2 vols., 1889-92); *Leçons sur la théorie de l'élasticité* (ed. by Borel and Drach, 1892); *Les oscillations électriques* (ed. by Maur-

rain, 1894); *Théorie analytique de la propagation de la chaleur* (ed. by Rouyer and Baire, 1895); *Théorie des tourbillons* (1893); *Théorie du potentiel Newtonien* (ed. by Le Roy and Vincent, 1899). Part of these works form his *Cours de physique* (13 vols., 1890). He has also published important memoirs on mathematics and physics in the *Journal des mathématiques pures et appliquées*, the *Journal de l'Ecole Polytechnique*, the *Transactions of the Philosophical Society of Cambridge*, *Scientia*, the *Acta Mathematica*, the *Mathematische Annalen*, and many other leading mathematical journals.

POIN'CIA'NA. A tropical tree. See C.ESALPINIA.

POIN'DEXTER, GEORGE (1779-1853). An American politician, born in Louisa County, Va. He studied law and began practice in Milton, Va. In 1802 he went to the Mississippi Territory, and in 1803 was appointed Attorney-General by Governor Claiborne. In 1806 he was in the Territorial Legislature, and prosecuted Aaron Burr when the latter was arrested in 1807. This year he was also elected delegate to the United States House of Representatives, and served two terms. In 1813 he was appointed United States judge of the Territory. In 1817 he presided over the committee to prepare a Constitution for the State, and was chosen its first Representative in Congress. Here he distinguished himself by his defense of General Jackson's course in Florida. In 1819 he was chosen Governor of the State and while in office prepared *The Revised Code of Laws of Mississippi* (1824). In 1830 he was appointed and then elected to fill out an unexpired term as United States Senator. Meanwhile his admiration for President Jackson had cooled, and he was even charged with complicity in the attempted assassination. He voted for Clay's resolution of censure for the President on account of the removal of deposits from the Bank of the United States, much to the surprise of his constituents. In 1835 he was defeated for reelection. Poindexter had great ability, but was violent, arrogant, and obstinate. As a result of one of his quarrels he killed Abijah Hunt in a duel (1811), in which he was accused of firing before the word.

POINDING, pind'ing (from *poind*, Scotch dialectic form of *pound*; connected with AS. *ge-pyndan*, Eng. *pind*, to shut up, impound, and with *pond*). In Scotch law, a method of satisfying a claim, under process of law, by seizing and selling the debtor's goods. Where a creditor has a claim which is considered a lien or burden on land, he may obtain a writ or warrant, known as a *debitum fundi*, authorizing the attachment and sale of such movables (q.v.) or chattels on the land as belong to the debtor. This is called 'real poinding.' 'Personal poinding,' or seizing any other personal goods of a debtor, is authorized by a special writ issued by an inferior judicial officer. Beasts of burden, plow animals, and agricultural implements must not be seized until all other goods of the debtor are exhausted. Another species of poinding is permitted corresponding to the English and American proceeding of 'impounding' cattle. (See POUND.) The proceedings for the collection of debts above described correspond to the English proceeding of distress and the American processes of attach-

ment and execution. See ATTACHMENT; DISTRESS; EXECUTION.

POINSETT, JOEL ROBERTS (1779-1851). An American diplomatist and official, born at Stotesburg, S. C. He was educated at Dr. Timothy Dwight's school at Greenfield, Conn., and in Great Britain, studying medicine at Edinburgh and military science at Woolwich. His father persuaded him to study law, but before returning to America Poinsett traveled extensively through Europe and Asia. In 1809 he was sent as United States Commissioner to South America to investigate the chances of the revolting provinces for independence. While he was in Chile the Spanish authorities of Peru, hearing that war had been declared against the United States, seized American merchantmen, but were forced by Poinsett at the head of Chilean soldiers to return them with apologies. On his return to America Poinsett was elected to the South Carolina Legislature, and strongly advocated internal improvements. From 1821 to 1825 he sat in the United States Congress as a Federalist, and advocated sending assistance to the South American republics. In 1822 he had been sent as special minister to Mexico, and from 1825 to 1829 was minister to that country. When the issues of nullification (q.v.) came to the front in South Carolina (1830-32) he became prominent in the 'Union Party' and opposed the idea of nullification vigorously. From 1837 to 1841 he was Secretary of War in Van Buren's Cabinet, and in 1840 secured the passage of the militia reorganization bill. He wrote many orations and essays, and founded an academy of fine arts in Charleston. He published *Notes on Mexico, Made in 1822; with an Historical Sketch of the Revolution* (1824).

POINSETTIA. A species of Euphorbia. See SPURGE.

POINT DE GALLE, pwān de gāl, or GALLE. The oldest commercial port of Ceylon, situated at the southwestern end of the island. 56 miles southeast of Colombo (Map: India, D 7). It lies at the foot of a range of rocky hills and is well laid out. The European town, inclosed by fortifications constructed during the Dutch occupation, contains a fine church and many other public buildings. The town has a good harbor, but it has lost its former commercial importance, and even the cocoanuts which are obtained chiefly in its vicinity are shipped to Colombo by rail. Point de Galle is the seat of a United States consular agency. The town was taken by the Portuguese in 1518 and attained commercial importance on account of the cinnamon monopoly. In 1642 it came into the hands of the Dutch, by whom it was strongly fortified. It passed to Great Britain in 1796. Population, in 1891, 33,590; in 1901, 37,326.

POINTE-À-PITRE, pwān'tá'pé'tr'. The principal seaport and largest town of the French West Indian island of Guadeloupe, situated about 20 miles northeast of the capital, Basse-Terre (Map: West Indies, R 6). It is a new town, built on the site of an old town destroyed by fire and earthquake, and is surrounded by a marshy district. It has a cathedral and a museum. The harbor is spacious and safe. It exports cocoa, sugar, and vanilla. It is in direct communication with France. The population is 16,500.

POINTER. A dog. See FIELD DOG.

POINT LEVI, là-vé'. A river port in Quebec, Canada. See LEVIS.

POINT PLEASANT, BATTLE OF. In American history, a battle fought October 10, 1774, at the mouth of the Great Kanawha River, in Virginia (now West Virginia), between about 1200 Virginians under Andrew Lewis and about 1000 Indians under the Shawnee chief Cornstalk, the former gaining a decisive victory, which closed 'Lord Dunmore's War.' Lewis had arrived at this point on October 6th, and had encamped to await the coming of Lord Dunmore, who was to join him with a force of 1000. Early on the 10th, however, Lord Dunmore having appointed another rendezvous, Lewis was preparing to cross the Ohio, when he was suddenly attacked by the Indians. After a fierce contest, lasting all day, each side fighting, Indian fashion, behind trees and boulders, the whites finally won. The battle has been regarded as one of the most stubborn and evenly contested ever fought between Indians and white men. Each side lost fully a fifth of its number, the loss of the whites being 75 killed and 150 wounded, Col. Charles Lewis being among the former; while that of the Indians, probably fully as great, was never accurately determined. The victory forced the Indians to make a treaty relinquishing to the whites a large tract of land south of the Ohio, while it kept the Northwestern tribes relatively quiet during the early part of the Revolution, threw open the Ohio route to Kentucky, and inspired the pioneers with renewed confidence. There is little historic basis for the claim, frequently made, that this should be regarded as the first battle of the Revolutionary War.

POINT D'APPUI, pwān' dāp'pwé' (Fr., point of touch). In military tactics, one of the points previously agreed upon where troops may rally or rendezvous, after an extended or scattered movement. In attack formation, it may be the point, or points, from which the actual attack is commenced.

POINTS OF THE ESCUTCHEON. See HERALDRY.

POIRÉ, pwá'rá', EMMANUEL (1858—). A French caricaturist, better known by his pen name, Caran d'Ache. He was born in Moscow, Russia. His first drawings were published in the *Chronique Parisienne*. Afterwards his work appeared in *Tout Paris*, *Vie Parisienne*, and various other publications. His drawings have been gathered in albums, such as *Psst* (1898), which contains his Dreyfus sketches. He is particularly happy in his portrayal of soldiers, and is a keen observer and an original draughtsman. He is said to have created the 'histoire sans légende' in France. His illustrations include those done for *La comédie politique* of Millaud. He also won much success with his pantomime *L'Épopée*, which celebrated the victories of Napoleon.

POISON (OF., Fr. *poison*, from Lat. *potio*, drink, *potio*, from *potare*, to drink). In law, any chemical which, if taken or injected into the human body, will cause some bodily harm or death. In most States the sale of poisons is regulated by statute. Common regulations are to require bottles or other receptacles containing poison to be plainly labeled 'Poison,' in addition to the scientific name of the drug, and to prohibit druggists from retailing certain poisons

POISONOUS PLANTS



COPYRIGHT, 1902, BY GOSB, MEAD & COMPANY

JULIUS R. ENGLER

- | | | | |
|---|--|--|---|
| 1 | POKEWEED - <i>PHYTOLACCA DECANDRA</i> | 4 | POISON IVY - <i>RHUS TOXICODENDRON</i> |
| 2 | JIMSON WEED - <i>DATURA STRAMONIUM</i> | 5 | POISON OAK - <i>RHUS TOXICODENDRON</i> |
| 3 | POISON SUMAC - <i>RHUS VENENATA</i> | 6 | BITTERSWEET, NIGHT SHADE - <i>SOLANUM DULCAMARA</i> |
| | 7 | WATER HEMLOCK - <i>CICUTA MACULATA</i> | |



without physicians' certificates or prescriptions for their use.

Poisoning is the crime of administering poison to a human being with intention to cause death or bodily harm. It is punished according to the result, as in other cases where one person is willfully or maliciously injured by another. Physicians may administer poisons as medicines in their discretion. Consult the authorities referred to under MEDICAL JURISPRUDENCE. See CRIME and the authorities there referred to.

POISON ALDER. See SUMAC.

POISON IVY. See IVY; SUMAC.

POISON OAK (*Rhus Toxicodendron*). An American shrub, feared because of its reputed poisonous qualities, said to be due to a non-volatile oil which produces itching, reddening, and swelling of the skin of certain individuals, but not of others. Saturated alcoholic solution of lead acetate (sugar of lead) is recommended as an antidote. See IVY; SUMAC.

POISON OF SERPENTS. See SNAKE; RATTLESNAKE; VIPER.

POISONOUS INSECTS. See INSECT, paragraph *Poisonous Insects*.

POISONOUS PLANTS. Vegetable substances reputed injurious to man and animals. This seemingly loose definition is rendered necessary because of the transitional state in which plants are with respect to popular belief, as the following facts sufficiently indicate: (1) Many plants formerly dreaded as violent poisons are now considered innocuous or inert, others unpleasant or unwholesome, still others edible, and some have even taken rank among our most important vegetable foods. (2) Certain plants, even among those used for food, are so feared by individuals that unpleasant physiological effects are observed whenever they are eaten, or in some cases even handled. These phenomena cannot, however, be attributed to the plants because they follow only in exceptional cases, and in these fear more or less well defined is an invariable precursor. (3) Still other species which in the individual have never produced untoward effects are, by hasty people, suddenly arraigned and condemned because of some observed physiological phenomenon supposedly due to eating or handling them. (4) Certain plants which produce no external effect upon or are even eaten freely by animals are feared by some people who consequently exhibit the phenomena they apprehend. (5) Lastly, immoderate indulgence of the appetite with many plants, probably with any plant, even one considered highly nutritive, may be followed by unpleasant or apparently even more serious symptoms; but these are the natural penalty for, and can legitimately be charged only to greed or gluttony.

Probably the best example of the first class is the tomato, which during the nineteenth century rose from the ranks of so-called poisonous plants, passing to the highest stage through the other stages indicated. As instances of the second and third groups the strawberry and celery are perhaps the best known; certain persons are afraid to eat the former, and others to handle the latter. Probably no plant so well represents the fourth category as does poison ivy, which is eaten

with apparent relish by horses, goats, and some other animals, but is feared by perhaps more people than any other American plant. Instances in the last group are of frequent individual experience.

Judging from these and other data that what is true of the past will be true in future, it is safe to predict that the plants now regarded as noxious will also be freed from the obloquy with which they seem to be smirched.

For descriptions of the plants illustrated on the accompanying Plate, see generic or common name titles.

POISONS. See TOXICOLOGY; ANTIDOTE.

POISON SUMACH. See DOGWOOD.

POISSON, pwä'sôn', SIMÉON DENIS (1781-1840). A French mathematician, physicist, and astronomer. He early took up the study of the descriptive geometry of Monge. At the age of seventeen he entered the polytechnic school at Paris, where he soon attracted the attention of his instructors, notably of Lagrange. He held various positions as examiner and professor in this institution for nearly forty years. He was also professor of mechanics on the Faculty of Sciences, member of the Bureau of Measures, and member of the Council of Public instruction (1820). He was made Baron by Napoleon and in 1837 became a peer. His scientific works and memoirs number over 300, and are devoted to mathematics, physics, and astronomy. The work enjoying the widest circulation is his *Traité de mécanique* (2 vols., 1811; 2d ed. 1833; German trans. 1835-36). His other notable works are: *Theorie mathématique de la chaleur* (1835; supplement 1837); *Recherches sur la probabilité des jugements en matière criminelle et en matière civile* (1837). His important memoirs on definite integrals and their applications to physics, on calculus of variations, and on probability were published in *Journal de l'Ecole Polytechnique* (1802-39); *Mémoires de l'Académie* (1811-43); *Connaissance des Temps* (1819-27); and in numerous other journals. Arago's works, volume ii., contain a complete list of Poisson's productions.

POISSY, pwä'sé'. A small town of France, in the Department of Seine-et-Oise, situated 10 miles northwest of Paris. It has a fine church which is one of the best examples of the transition style of the twelfth century. Poissy is the birthplace of Saint Louis (1215), and here in 1561 a famous religious conference was held between Catholics and Protestants. The town has important iron foundries. Population, in 1900, 7506.

POITIERS, pwä'tyá'. The capital of the Department of Vienne, and formerly of the Province of Poitou, in Western France. It is situated on a plateau-like peninsula formed by the junction of the Clain and the Boivre rivers, and on the Orleans Railroad, 58 miles southwest of Tours (Map: France, G 5). It is an old town with narrow, crooked, and ill-paved streets. Although it is a railroad junction, its commerce and industries are not very important. It is chiefly interesting on account of its ancient and mediæval remains and associations. It is preëminently a city of churches and ecclesiastical institutions. The cathedral is a Gothic-Romanesque structure of the twelfth century, with an imposing inte-

rior, but a rather heavy façade. There are several very old and interesting churches, such as the Temple Saint Jean, a baptistery built in the seventh century, and one of the oldest Christian monuments in France; the Church of Notre Dame la Grande, a Romanesque building of the eleventh century, with an elaborately decorated façade; and the Church of Sainte Radegonde, founded in the sixth century, rebuilt in the eleventh century, and containing the sarcophagus of the saint. Among the noteworthy buildings and places are the fine modern Hotel-de-Ville and the Parc de Blossac; the latter, situated at the southern end of the town, is bordered by mediæval ramparts and commands a fine view. At the northern end, near Pont Joubert, is a colossal gilded statue of Notre Dame des Dunes. Poitiers has a university with faculties of law, science, and philosophy, and a preparatory school of medicine and pharmacy. The municipal library contains 65,000 volumes and 460 manuscripts. There are museums of art, archaeology, and natural history. Population, in 1896, 38,518; in 1901, 39,886.

Poitiers was the capital of the Pietones or Pictavi, whence its modern name. The Romans called it Limonum. There are still a number of Gallic and Roman remains in the town and vicinity. Christianity was introduced in the third century and about 353 Saint Hilary became the first Bishop of Poitiers. In the fifth century the town fell into the hands of the Visigoths, whose King, Alaric II., was defeated by Clovis in battle near Poitiers in 507. In 732 Charles Martel checked the advance of the Saracens in the world-famous battle fought in the neighborhood. Near Poitiers, during the Hundred Years' War, the English, under Edward the Black Prince, gained a notable victory over the French under their King, John II., the Good, September 19, 1356. The French, whose forces outnumbered the English more than five to one, opened the battle with a furious charge, but were thrown back by a volley from the English archers, and totally routed by the onset of the English men-of-arms. The slaughter of French knights was large. King John was taken prisoner. See POITOU. Consult Ledain, *Histoire sommaire de la ville de Poitiers* (Fontenay-le-Comte, 1892).

POITOU, pwá'tōŏ'. A former province of Western France, now included within the departments of Vienne, Deux-Sèvres, and Vendée. The capital was Poitiers (q.v.). The ancient inhabitants of the region were the Pictavi or Pietones. It was overrun by the Franks in 507. Charles the Great placed Poitou under the jurisdiction of a count whose descendants, at the beginning of the tenth century, assumed the title of dukes of Aquitaine. It came into the possession of the English kings through the marriage of Eleanor of Aquitaine with Henry II. (q.v.), but was seized by the French King Philip Augustus in 1204. England held it again for about ten years after the Peace of Bretigny (1360), following the battle of Poitiers (1356). In 1416 it was permanently united with the French Crown.

POKANOKET. A North American Indian tribe. See WAMPANOAG.

POKE (*Phytolacca decandra*). A perennial herb of the natural order Phytolaccaceæ, native of North America, but distributed also in Northern Africa, the Azores, and the Hawaiian Islands

and China, and naturalized in Southern Europe. It is often called garget, pigeonberry, and seoke, and is found generally in good soil of waste



FLOWERING STEM AND FRUIT OF POKE.

places, as uncultivated fields, often attaining a height of more than six feet. See PHYTOLACCA, and Colored Plate of POISONOUS PLANTS.

POKER, or DRAW POKER. A game of cards said to be derived from primero or prime, a favorite English game of the sixteenth century. In France during the following century primero became ambigu, and a little later another variation, called brag, sprang up in the west of England, from which poker is more directly descended in its American form. The game may be played by from two to six persons. A full pack is used and five cards are dealt to each player, one at a time, after which, beginning at the dealer's left, each one may discard any or all of his cards, calling for as many new ones as he discards. This is the draw, and the player holding the most valuable hand is the winner. Beginning with the lowest, the values are as follows: a pair, two pairs, three of a kind (i.e., three cards of the same value), a straight, or five cards in regular order (in determining the value of 'straights,' the ace ranks either below the two or above the king, but stands at the end); a flush, i.e., where all five cards are of the same suit; a full house, full hand, or full, which consists of three of a kind, and a pair together; four of a kind; a straight flush, in which the cards are all of the same suit; and the royal flush, in which the cards of the same suit are the highest obtainable. Of the various methods of keeping score in the game of poker the following is the simplest: Before the play is opened counters are divided in equal value among the players. Before examining a hand each player deposits in the pool a value in counters previously agreed upon. This is the 'ante,' after which each player in succession after looking at his hand determines whether or not he will play. If he decides to

play he is required to put up double the 'ante' or as much more as he wishes up to the value of his hand and the limit agreed on before the game commences. The player at his left has also the choice of staying out or depositing in the pool the same number of chips as the player who preceded him, in which case he is said to 'see' him; or he may 'raise' or 'go him better,' in which case he deposits in the pool more than did his predecessor. The next or third player has also the choice of staying out or 'raising' the preceding player, and so on with each in turn, one or more times around. Should all the players except one fall out, the one who remains takes the pool without showing his hand. Again, all the players in the game may 'see' the one that 'raised' last, in which case they are said to 'call' the player's hand. Should none of the others have a better hand they let the one who has been called take the pool without displaying their own hands, otherwise the higher hands are tabled and the winner takes the pool. It is sometimes agreed that the players who desire cards in the beginning of the game must add to their 'antes,' and sometimes players make bets before they make their draw. The 'ante' is large or small, according as the 'eldest' hand plays; the common method being to require each player to 'ante' twice as much as the eldest hand, who will then have to make good at his next turn the rest of the 'ante,' or else fall out of the game. 'Bluffing' is where a player bets high on a weak hand in the hope that the other players, thinking his hand justifies the bet, will stay out of the game and thus leave the pool to the 'bluffer.' Apart from 'bluffing' the only part of poker in which skill is requisite is in discarding. Thus, when a player holds four of a suit he will often discard the fifth in the hope of securing a 'flush.' Some idea of the strength of a player's hand is got by taking note of the number of cards he calls for.

POKOMOS, pō-kō'mōz. A Bantu nation of the Tana basin, British East Africa, long oppressed by the Galla and the Swaheli. They are of medium height and of light brown color. Their huts are of beehive shape on raised platforms along the river banks. They are monogamists, and are truthful. The Pokomos, in common with many other tribes of this region, are at a low stage of culture, having a loose type of social organization, a well-developed totemic system, and a firm belief in magic.

POKOMOS. A Central American Indian tribe. See **MAYA**.

POL, pól, WINCENTY (1807-72). A Polish poet, born at Lublin. Educated in a Jesuit college at Tarnopol, he thence went to Lemberg, where he came in touch with French Romanticism. After traveling through Poland, in 1830 he became professor of German at Wilna, and in the same year, throwing in his lot with the liberators, wrote his first patriotic songs. Returning from exile in 1849, he was professor of geography at Cracow until 1853. He was forced to resign from this post, but returned to Cracow after several years in Lemberg. In his last years he was totally blind. Pol's most popular work was *Songs of Our Land* (1843), which deals with the various elements of the Polish population, while his best book is probably *Pictures from Life and Travel* (1847). His genius was essentially lyric and simple, at its best in descriptions of nature

or of homely life. His collected works appeared at Lemberg (1875-78).

POLA, pō'lá. The chief naval station of Austria-Hungary, with one of the finest harbors in Europe, in the Crownland of Istria, on the Adriatic Sea, about 53 miles south of Trieste (Map: Austria, C 4). The bay, which is thoroughly sheltered, is spacious enough to accommodate a very large fleet. The town is strongly fortified by walls and a citadel, overlooking the bay. The entrance to the bay is commanded by two forts and by various other fortifications on the islands in the bay and on its shores. Here are the dockyards, dry docks, and repair shops of the Austrian navy, the headquarters of the Admiralty, a hydrographic bureau, and various technical institutions. The town has several very imposing Roman remains, among which are the well-preserved temple of Augustus and Roma, the colossal Imperial amphitheatre, which could seat 25,000 persons, and the Porta Aurea, a sumptuous triumphal arch, dating from the beginning of the Christian Era. The Marine Casino and the Monte Zaro, with the fine statue to Admiral Tegetthoff, form a delightful pleasure resort. Pola is an important commercial port. It has grown from 1100 inhabitants in 1851 to 45,052 in 1900 (including 7657 on garrison duty). About 40 per cent. of the population are Italians, the rest being mainly Serbo-Croats and Germans.

Pola is of very ancient origin. It was destroyed by Julius Caesar, but rebuilt by Augustus at the request of his daughter Julia, from whom it obtained its name, Pietas Julia. It was a station of the naval fleet and bore the name of Republica Polensis. It was taken by the Venetians in the middle of the twelfth century, and was destroyed in the struggle between Venice and Genoa. Its present prosperity dates from about 1855.

POLAK. See **POLAND**, paragraph on *Ethnology*.

POLAND, pō'land. A former kingdom of Europe, whose territory is now included in Russia, Austria-Hungary, and Prussia. At its greatest extent, previous to 1660, it had an area of about 375,000 square miles, with a population of about 15,000,000, and extended northward to the Baltic Sea and the Gulf of Riga; westward to Brandenburg; southward to Hungary, Moldavia, and nearly to the Crimea; and eastward so as to include most of the basin of the Dnieper. About six-sevenths of this area is now included in the Russian Empire, embracing Russian Poland (see **POLAND, RUSSIAN**), West Russia (Lithuania, Volhynia, etc.), a great part of Little Russia, Livonia, and Courland. The part of Poland belonging to Austria constitutes the Crownland of Galicia (q.v.). The parts of the kingdom incorporated in Prussia include Posen (q.v.), West Prussia (q.v.), and the District of Ermland (q.v.), in East Prussia. Before the final partition in 1795 the area of Poland was reduced to 94,164 square miles, with a population of 4,500,000.

ETHNOLOGY. The territory comprised in the Kingdom of Poland before its dismemberment was inhabited by four ethnic types. Poles, Little Russians (Ruthenians), White Russians, and Lithuanians. The Poles proper have been identified with the Polianes, a branch of the Lekhs dwelling on the Vistula in the sixth century. The great

Slav movement from the second to the sixth century A.D. had dispersed the tribes in all directions, toward the Baltic, beyond the Elbe, and into the Danube basin and the Balkan peninsula. By the twelfth century the Germans had in a great measure pressed back the Western Slavs to the banks of the Vistula, and the development of Polish power was forced to the east and south among the Slav groups.

Ethnically the Poles belong to the Western Slav group. The bulk of them live in Russian Poland and adjoining parts of Russia, Western Galicia, and the Prussian provinces of Posen and Silesia. They are below medium stature, their average height being 1.624 meters, and are mainly brachycephalic and blond. Deniker classes them in his fair, sub-brachycephalic, short, or eastern race, and sees among them traces of a secondary or Vistulian race, fair, mesocephalic, and of very short stature. Race fusion has energetically acted in this region among various sections of the Slavs, so that the Poles have the qualities coming from a good race mixture. Other Slavic tribes, as the Polaks or Podlachians in the Russian Government of Grodno, on the Polish frontier, and the Polesians of Western Russia have considerable Polish mixture. In Prussia, by the higher birth-rate and by the absorption of German elements, the Poles have increased remarkably, weeding out colonies of Germans in Polish districts, and planting colonies in other portions of the kingdom, notably in West Prussia and Silesia. Under this impulse they have taken to commerce and education with new energy. In some districts they are expropriating the German landlords and sending Polish peasants to take their places. The other fragments of the Polish kingdom in Russia and Austria also show this movement, though not with the same degree of progress as in Prussia.

HISTORY. Polish historians profess to go as far back as the fourth century, but the list of rulers which they give are probably those of separate tribes, and not of the combined race now known as Poles. At any rate, the history of Poland previous to the middle of the ninth century is too legendary to have much value. About 840 a kingdom was organized out of kindred tribes under the Piast line of rulers, whose origin is uncertain. Ziemowit, said to be the second ruler of the Piast dynasty, is considered to be the first ruler whose history is to any extent to be relied upon; and it was not till a century after, when his descendant Meczyzlaw (Miecislav or Mscislaw) I. (962-92) occupied the throne, and became a convert to Christianity, that Poland really came into the field of European history. Mieczyslaw divided his dominions among his sons; but one of them, Boleslaw (or Boleslas) I. (992-1025), surnamed the Brave, soon reunited the separate portions, extended his kingdom beyond the Oder, the Carpathians, and the Dniester, and carried on a successful war with the Emperor Henry II. Under him Poland began to assume unity and consistency. About the same time the distinction between the nobles or warrior class and the agriculturists was distinctly drawn. This was of the utmost importance in the development of Poland, as it created a sharply defined caste, a military aristocracy entirely out of sympathy with the peasantry, which became ultimately one of the most arrogant and oppressive in Europe. An important event was the foundation of the

archiepiscopal see of Gnesen in 1000. Shortly before his death Boleslaw exchanged the title of Pinst for King. He was succeeded by his son Mieczyslaw II. (1025-34), during whose reign the Danes, the Hungarians, and the Russians made themselves masters of various territories which had been occupied by the Poles. Under Casimir I. (1034-58) and his warlike son, Boleslaw II., the Bold (1058-81), Poland regained something of its former power. The latter monarch having with his own hands murdered the Bishop of Cracow (1079), the country was laid under the Papal interdict and Boleslaw fled to Hungary, where he died. Boleslaw III. (1102-39), an energetic monarch, conquered Pomerania, defeated the pagan Prussians, and defended Silesia against the Emperor Henry V. A division of the kingdom among his sons was productive of much internal dissension. Silesia was severed from Poland, principalities ruled by branches of the Piast dynasty being established there. Ultimately, Casimir II. (1177-94) reunited the severed portions, with the exception of Silesia, and established on a firm footing the constitution of the country. A senate was formed from the bishops, palatines, and castellans, and the rights of the clergy and the peasantry were accurately defined.

Soon after Casimir's death Pomerania emancipated itself from Polish rule. In the thirteenth century the Teutonic Knights subdued the heathen Prussians and established their dominion on the shores of the Baltic, becoming formidable neighbors to the Poles. The Mongols swept over the Polish territories in 1240, and defeated the Poles, Silesians, and Teutonic Knights in the battle of the Wahlstatt (April 9, 1241). This terrible invasion was followed by a period of general decadence, and for a while the Polish realm as such almost ceased to exist. Poland was divided into a number of independent principalities and their dissensions led to the loss of large districts. During this period many parts of the country began to be colonized by Germans, who did much for Poland by establishing industries and developing municipal institutions. Large numbers of Jews, persecuted in Western Europe, took refuge about this time in Poland. The country recovered under Ladislaw (Wladislaw) I. (1306-33), surnamed *Lokietek* (the Short), who abolished judicial abuses and illegally acquired privileges, and assembled the first Diet for legislative purposes. He carried on successful campaigns against the Teutonic Knights, supported by the Grand Prince of Lithuania, and came to be known as the 'father of his country.' Under him Cracow became the permanent capital of Poland. His son, Casimir III., the Great (1333-70), increased the power and prosperity of Poland by cultivating the arts of peace, amending the laws, and consolidating his territories by profitable exchanges with the neighboring powers. The Principality of Halicz (Galicia) was annexed to Poland. Extensive privileges were conferred on the Jews at a time when the nations of Western Europe were visiting on them the rigor of persecution. The foundations of the University of Cracow were laid. In the latter part of his reign Casimir fought successfully against the Tatars and Lithuanians. With Casimir the Piast dynasty became extinct. His nephew, Louis the Great, King of Hungary, succeeded him by the will of the deceased monarch and the election of

the Diet; but during his reign Poland was treated merely as an appanage of Hungary. After the death of Louis of Hungary without male issue (1382) Hedwig, daughter of Casimir the Great, was chosen Queen of Poland in 1384 by the Diet, and two years later she married Jagello (Jagellon), Grand Prince of Lithuania, who ascended the throne as Ladislas II. (q.v.), and founded the Jagellon dynasty, which ruled over Poland and Lithuania from 1386 to 1572, and under which Poland was at the height of its greatness. Jagello, at his accession, embraced Christianity, which was now introduced into Lithuania, hitherto a heathen country. Jagello inflicted a great defeat upon the Teutonic Knights at Tannenberg in 1410. He was succeeded in Poland by his elder son, Ladislas III. (1434-44), and in Lithuania by his younger son, Casimir. Ladislas, whom the Hungarians placed upon their throne, was overwhelmed by the Turks and slain in the battle of Varna. He was succeeded after an interregnum by his brother, Casimir IV. (1447-92), during whose reign the Teutonic Knights, by the Treaty of Thorn (1466), ceded West Prussia to Poland, and agreed to hold East Prussia as a Polish fief. Casimir rewarded the inferior nobles, or warrior class, with more extensive privileges, putting them on an equality of rank with the great chiefs of the realm, and at the same time necessarily oppressing the peasantry. Manufactures and commerce revived to a remarkable extent in the western provinces. The brief reigns of his two elder sons, John I. (1492-1501) and Alexander (1501-06), were marked only by the increased power of the Diet, which was steadily absorbing the real authority, and converting Poland from a monarchy to an oligarchy.

Sigismund I., surnamed the Great (1506-48), the youngest son of Casimir IV., raised the country to the utmost pitch of prosperity. Generous and enlightened, he was beloved by the masses, while his firmness and justice commanded the respect of the turbulent nobles. In a war with Russia, however, in the early part of his reign, he lost Smolensk. His son Sigismund II., Augustus (1548-72), was a worthy successor to his father. During his reign the extraordinary privileges of the higher nobles were curtailed or abolished. Lithuania was finally joined indissolubly to Poland, the union being proclaimed by a Diet held at Lublin in 1549. There was but one Diet for the united realm, which was to be converted into an elective monarchy on the death of the reigning King, who had no heirs. Lithuania retained, however, her own army, treasury, and laws. Lithuania was at the same time reduced in area by the annexation of Podlachia, Volhynia, and the Ukraine to Poland. Livonia was ceded to Poland by the Knights Sword-bearers and successful wars were waged against the Russians and the Turks. The Polish realm then stretched across Central Europe from the Baltic Sea to the Dniester, with its western boundary less than 90 miles from Berlin, and its eastern frontier about 150 miles from Moscow, covering an area of more than 370,000 square miles. The population almost doubled under the two Sigismunds. The Reformation spread rapidly in Poland, but its progress was arrested by the Jesuits, who persuaded the nobles that their interests lay in the preservation of the Catholic hierarchy. With the death of Sigismund Augustus in 1572 the Jagellon dynasty became extinct and Poland

passed under the régime of elected kings. The election was by the two chambers of the Diet, the Senate or Chamber of the Chief Nobles, and the Chamber of Nuncios, or Representatives of the Inferior Nobles. The Diet sat only six weeks, and its decisions were required to be unanimous; so that if the *liberum veto* (the right of forbidding the passing of any measure) were freely exercised even by a single member, all legislation was at a standstill. More unnatural still was the recognized right of any number of nobles to confederate for the purpose of effecting their will by force of arms.

This singular constitution produced the most inefficient government that was ever established in a great State. Political factions could hamper all action in great national crises, and the so-called republic became a most pernicious oligarchy. In the *liberum veto* might easily be found the seed which produced the final disintegration. The first elective monarch was Henry of Valois, Duke of Anjou (1573-74), who had barely assumed the crown when he laid it down to become King of France as Henry III., and was succeeded by Stephen Báthory (1575-86), Voivode of Transylvania. Stephen's successor, Sigismund III., Vasa (1587-1632), was the son of John III. of Sweden by a daughter of Sigismund I. His claims to the crown of Sweden, which he wore for a time, brought on wars with that kingdom. Gustavus Adolphus carried on victorious campaigns against the Poles in 1621-29 and conquered Livonia. After Sigismund III., under whom Warsaw supplanted Cracow as the Polish capital, came his two sons, Ladislas IV. (1632-48) and John Casimir (1648-68). The imprudent attempts of the sovereigns of the House of Vasa to amend the Constitution only excited the suspicion of the nobles, and led to a further curtailment of royal authority. In 1648 the Cossacks, goaded by oppression, rose in rebellion under Bogdan Chmielnicki (q.v.), put themselves under the protection of Russia (1654), and ever afterwards proved themselves the most inveterate enemies of the Poles. In 1655 Charles X. of Sweden invaded Poland while the Poles were engaged in war with Russia, and in 1656 he was joined by Frederick William, the Great Elector of Brandenburg. The Poles at first fought victoriously under Czarnecki, but in July, 1656, they were vanquished in a great battle at Warsaw. In 1657 Brandenburg went over to the side of Poland, which then renounced its suzerainty over the Duchy of Prussia (East Prussia). In the Peace of Oliva, in 1660, Poland formally ceded Livonia to Russia, and the Ukraine beyond the Dnieper was given up to Russia in the Treaty of Andrussovo, in 1667. Michael Wisniowiecki (1669-73), the son of one of the ablest Polish leaders, but himself an imbecile, was elected as successor to John Casimir, who had abdicated the throne. A war with Turkey, concluded, in spite of the victories of John Sobieski, by an ignominious peace, was the chief event of his reign. In 1674 the crown was conferred on John Sobieski, who shed lustre on the Polish arms by overthrowing, in conjunction with the German princes, a vast Turkish army in front of Vienna in 1683, and saving the Hapsburg capital. His reign, however, was productive of little good to the internal administration. He died in 1696 and the French Prince de Conti was elected and proclaimed King. Lack-

ing efficient support from France, Conti renounced the office; and Frederick Augustus I. of Saxony, surnamed the Strong, a protégé of the House of Austria, entered Poland at the head of a Saxon army, and was chosen King as Augustus II. (1697-1733). Augustus never identified his interests with those of his Polish subjects. The Treaty of Karlowitz, in 1699, brought the last struggle between Poland and Turkey to a close and restored to Poland a large part of the Ukraine. In 1700 Augustus entered into an alliance with Russia and Denmark for a joint attack upon Sweden, then under the rule of Charles XII. This conflict brought nothing but misfortune. The war with Sweden was unpopular in Poland; in fact, the Poles of the eastern provinces received Charles with open arms; but his attempt to force upon them Stanislas Leszczyński as their King deeply wounded their national pride. At Altranstädt in 1706 Augustus was compelled to abdicate, but after the defeat of Charles XII. by Peter the Great at Poltava, in 1709, he returned, supported by Russia, and Russian as well as Saxon troops were maintained in the country in spite of the protest of the people.

This beginning of Russian interference was a visible mark of the decline of Poland. The Polish army was reduced at the instance of Peter the Great, and the evil example of the Saxon Court brought in immorality, prodigality, and effeminacy. Protestants were persecuted and excluded from public office. The election of Augustus III. (1733-63) was accomplished by the most shameless bribery and under the compulsion of Russian troops, and led to the War of the Polish Succession. (See SUCCESSION WARS.) His reign was of the same character as that of his predecessor. Toward its close the more enlightened of the Poles entered into a league to promote the establishment of a well-organized hereditary monarchy. But the conservative or republican party was equally strong, and relied on Russian influence, which was used to continue the divisions in the country. Catharine II. of Russia determined at the beginning of her reign to control Poland or take it, as it barred the way to the accomplishment of her great ambition, to bring Russia fully into the circle of the Western powers. On the death of Augustus III. she, acting in harmony with Frederick of Prussia, put forward as a candidate for the Polish throne Stanislas (Augustus) Poniatowski, an old lover of her own. This roused the national spirit of the Poles to intense opposition. The monarchic party, led by Prince Czartoryski, had succeeded in abolishing the *liberum veto* and in otherwise strengthening the Government. Catharine, in alliance with Prussia, seized the pretext furnished by the oppression of religious dissidents of the Protestant and Greek communions by this dominant party, and appeared as the champion of religious liberty. Russian troops entered the country and forced the election of Poniatowski (1764). The Confederation of Bar (so called from Bar in Podolia) was formed in 1768 by a few zealous patriots, and entered upon a vigorous resistance to Russia. Similar confederations were organized, and Turkey seized the occasion to attack Russia. To avoid the danger of a general war and to obtain compensation for the inevitable seizure of Polish territory by Russia, the governments of Prussia and Austria proposed a treaty of parti-

tion, which was concluded at Saint Petersburg, August 5, 1772. Russia acquired a part of the old Lithuania, comprising an area of 42,000 square miles, with a population of 1,800,000; Prussia took West Prussia without Danzig and Thorn, and the district on the Netze, 13,000 square miles, with 415,000 inhabitants; and Austria received Galicia and Lodomeria, 27,000 square miles, with 2,700,000 inhabitants.

Members of the Polish Diet were freely bribed to consent to the cessions. The old anarchical Constitution with the *liberum veto* was restored. The country was now aroused to a sense of its danger; and the result was the adoption of the admirable Constitution of 1791, which gave political rights to the cities, civil rights to the peasantry, and rendered the kingly authority hereditary. Frederick William of Prussia promised the Polish patriots support against Russia. Catharine II., however, by intrigues and bribery, won a small number of the higher Polish nobility, who formed the Confederacy of Targowitza (May, 1792), and protested against the new Constitution as derogatory to the ancient liberties. Catharine, thus armed with a pretext for interference, invaded Poland with an overwhelming army. The Poles fought bravely under Kosciuszko (q.v.) and won a victory over the Russians at Dubienka (July 17, 1792); but King Stanislas, after pledging his loyal support to the nation, gave his adhesion to the Confederacy of Targowitza. A Prussian army now entered Poland, and the country, its strength broken, was subjected to a second partition (July 17, 1793). Russia took a large part of Lithuania, half of Volhynia, Podolia, and the portion of the Ukraine which had remained with Poland—96,000 square miles, with about 3,000,000 inhabitants. Prussia appropriated the westernmost part of the kingdom, 22,000 square miles, with 1,100,000 inhabitants. A Diet convened at Grodno was compelled to sanction this 'cession.' A general rising of the Polish people to resist this dismemberment of their country took place in 1794. Kosciuszko was made dictator and drove the Russians from Warsaw, but dissension among the Poles ruined their cause at the moment of seeming triumph. The Russians and Prussians reentered the country with increased numbers, and on October 10, 1794, Kosciuszko was decisively defeated and taken prisoner at Maciejowice by the Russians. On November 8th Suvaroff entered Warsaw, and Polish resistance came to an end. The third and last partition (October 24, 1795) distributed the remainder of the country. Russia taking 45,000 square miles, with 1,200,000 inhabitants; Prussia, 21,000 square miles (including the capital, Warsaw), with 1,000,000 inhabitants; and Austria, 18,000 square miles, with 1,000,000 inhabitants. King Stanislas resigned his crown and died at Grodno as a pensioner of Russia in 1798. Napoleon, who promised the restoration of Poland and thereby gained the support of the patriots, was hailed with satisfaction, but all that Napoleon accomplished was the establishment, by the Treaty of Tilsit (1807), of the Duchy of Warsaw, formed out of the Polish territories taken by Prussia in 1793 and 1795. This State received a fairly liberal constitution, and King Frederick Augustus of Saxony as its nominal head, the real power being exercised by the French Emperor. The duchy was increased by Western Galicia, ceded by Austria in the Treaty of Schönbrunn, in 1809. The Poles

furnished a considerable contingent to the French armies. The disaster to the French in Russia in 1812 and the advance of the allied army in 1813 put an end to the existence of the duchy. The partition of Poland was rearranged by the Congress of Vienna in 1815. Prussia retained West Prussia and recovered the western portion of the territory embraced in the Duchy of Warsaw, which region was constituted into the Grand Duchy of Posen; Austria recovered the territory which she had taken in the first partition of Poland in 1772 (Galicia); Russia was secured in the possession of all the territories that she had appropriated in the three partitions; out of the bulk of the Duchy of Warsaw was created a new Kingdom of Poland, which was to be united with the Russian Empire by a personal union. The city of Cracow, with a small surrounding territory, was erected into a republic, which was placed under the protection of the Great Powers. This final partition of Poland gave Russia 220,500 square miles, Prussia 26,000 square miles, Austria 35,500 square miles. Of the portion which was to belong to the Emperor of Russia, about 49,000 square miles were included in the new Kingdom of Poland.

Alexander I. of Russia first granted a liberal constitution, a separate standing army, and liberty of the press. This, however, did not prevent the Polish nobles from conspiring for the restoration of the liberties of their country. Secret societies, as elsewhere in Europe, fomented the revolt, and a general insurrection of the people, headed by the aristocracy, took place. On November 29, 1830, a military insurrection broke out at Warsaw, and in a short time the Russians were driven from the country. The leadership of the movement was assumed by a number of nobles, most prominent of whom was Prince Adam Czartoryski (q.v.). Chlopicki (q.v.) was appointed dictator. In January, 1831, the independence of Poland was proclaimed, and Czartoryski was made head of the national Government, Chlopicki having laid down his dictatorship. A Russian army under Diebitsch invaded the country. The Poles fought with their wonted bravery and for months kept the enemy at bay, but their main army, under Skrzynecki, was defeated at Ostrolenka on May 26th. Paskevitch, who succeeded to the command of the Russian forces on the death of Diebitsch, carried on the war with vigor, and was aided by the inveterate dissensions among the Poles. Warsaw was taken on September 8th, and the Polish armies sought refuge on Prussian and Austrian soil. Dilatoriness on the part of the military leaders and the delay occasioned by fruitless negotiations with Emperor Nicholas had proved fatal errors.

There followed for those who had participated in the rebellion imprisonment, banishment, confiscation, and enforced service in the Russian army. From this time all self-government in Poland was suppressed. The liberal Constitution of 1815 and laws were abrogated; strict censorship of the press and the Russian spy police system were established in all their vigor; the country was robbed of its rich literary collections and works of art; and the most severe and arbitrary measures were taken to Russianize the people. Large numbers of Poles were forced to take refuge in France and elsewhere, where they carried on an active revolutionary propaganda, and some of them played an important part in

the struggle for liberty in other countries. (See BEM; DEMBINSKI. The year 1846 witnessed another effort on the part of the Poles to shake off the yoke that had been imposed upon them. The movement did not proceed far. In Prussian Poland (Posen) it was promptly checked by the arrest of Mieroslawski (q.v.) and other leaders, while in Galicia the peasantry (in great part Ruthenians) rose against the nobles, the leaders in the outbreak, and massacred many of them. In the same year the Republic of Cracow was incorporated with Austria. In 1848 there was an insurrection in Posen, which was quickly suppressed. After the accession of Alexander II., of Russia, in 1855, the condition of the Poles was considerably ameliorated, and an act of amnesty brought back many of the expatriated Poles.

The Czar evinced by his acts his readiness to make far-reaching concessions to his Polish subjects, but in spite of this there were violent revolutionary demonstrations in 1861, which were repressed with bloodshed. In 1862 a régime of partial autonomy was inaugurated under the guidance of Marquis Wielopolski, a member of the Polish aristocracy; but the Russian Government was not trusted by the Poles, and a revolutionary fever had taken hold of the youth, which found vent in fresh outbreaks and in attempts to assassinate the Viceroy Constantine (brother of the Czar) and Wielopolski himself. The Russian Government proceeded to stern repressive measures, and in January, 1863, resorted to a barbarous expedient in order to quell the revolutionary spirit—a wholesale conscription, suddenly executed, which should at one stroke remove the patriotic young men from the field of their activity. This measure, which could be but partially carried out, brought matters to a crisis and the country rose in insurrection. This movement differed from the preceding uprisings in that it was largely a democratic agitation and was carried on under the guidance of a secret revolutionary committee. This body issued its first proclamation in February, 1863, and a week afterwards Mieroslawski raised the standard of insurrection on the Posen frontier. The principal commander of the patriots was Langiewicz. It was little more than a mere guerrilla war, and no great or decisive conflicts took place. The sympathy of Europe was largely enlisted on behalf of the Poles, but the remonstrances of the Powers were wholly disregarded by the Czar's Ministers. The Poles fought heroically against desperate odds. The national committee continued to guide the revolt and resorted to terrorism, even assassination, to carry out its measures and enforce obedience. The overwhelming numbers of the Russians soon carried everything before them, and early in 1864 the last sparks of the insurrection were stamped out. Large numbers of the patriots were executed and crowds were transported to Siberia. Lithuania and other parts of old Poland, not included in the so-called kingdom, were at once subjected to a process of Russification, which was carried out with extraordinary barbarity. By an Imperial ukase of February 23, 1868, the government of Poland was completely incorporated with that of Russia. Russian has been made the language of the administration and of the schools. To the Polish peasantry Russian government brought a boon in the shape of emancipation (1864). The Pan-slavists of Russia (see PANSLAVISM) regard agitation

for Polish nationality as treason to the greater cause of Slavic union. In spite of the measures directed against it, the Poles of Russia cling firmly to their nationality, and their authors and journalists keep alive their attachment to their native tongue. Galicia, where constitutional government exists under Austrian rule, is a great stronghold of Polish nationality, Craeow holding a place next to Warsaw as an intellectual focus of the people.

In Prussian Poland the struggle between Pole and German has been very active and has been fought out on an economic basis. It was Bismarck's policy to plant a Germanic population on Polish soil, and to this end vast sums were spent in buying up Polish estates, which were then peopled with German colonists. In spite of the strenuous efforts of the Government, however, the Poles have more than held their own. The national spirit has undergone a great revival and has united the nobility and the masses in opposition to the domination of the Prussians. The policy of Prussification has been pursued by the Government through the introduction of the German language in the schools, a measure which led to bitter dissatisfaction among the Poles and some slight disturbances in 1901.

BIBLIOGRAPHY. Of works in English, Dunham, *The History of Poland* (London, 1834), is compact and useful, especially in its earlier portions; Fletcher, *The History of Poland from the Earliest Period to the Present Time* (ib., 1831), is an interesting work, but less reliable than the preceding. Consult also: Wolski, *Poland* (London, 1883); Moltke, *Poland* (ib., 1885), translated from the German, a valuable sketch; Morfill, *The Story of Poland* (New York, 1893), in the Story of the Nations series. Lelewel, *Histoire de Pologne* (Paris, 1844), is a Polish plea, but standard. Salvandy, *Histoire de Pologne* (ib., 1855), is standard for Polish history up to the reign of John Sobieski; Röpell and Caro, *Geschichte Polens* (Hamburg, 1840-63), is the fullest and best of general histories of Poland. On special periods there are Brüggens, *Polens Auflösung; kulturgeschichtliche Skizzen aus den letzten Jahrhunderten der polnischen Selbstständigkeit* (Leipzig, 1878); Röpell, *Polen um die Mitte des 18. Jahrhunderts* (Gotha, 1876), an able treatise on the period 1697-1763; Rultrière, *Histoire de l'anarchie de Pologne* (Paris, 1807, 1819). On the revolutionary movements in Poland, see Rultrière, *Révolutions de Pologne* (Paris, 1862); Kunz, *Der polnisch-russische Krieg von 1831* (Berlin, 1890); Kozmian, *Das Jahr 1863* (Vienna, 1896). On the partitions, Ferrand, *Les trois démembrements de la Pologne* (Paris, 1864); Beer, *Die erste Teilung Polens* (Vienna, 1873); Bain, "The Second Partition of Poland," in the *English Historical Review* for April, 1891.

POLAND, RUSSIAN. An historical division of Russia, forming the westernmost part of the Russian Empire. It is bounded on the north by Prussia and the Russian Government of Kovno, on the east by the governments of Vilna, Grodno, and Volhynia, on the south by the Austrian crownlands of Galicia and Silesia, and on the west by Prussia, Silesia, and Posen. Poland is known officially as the *Privislinskira Gubernii*, or Governments on the Vistula, and consists of ten governments, Kalisz, Kielce, Lomza, Lublin,

Piotrkow, Plock, Radom, Siedlce, Suvalky, and Warsaw, with a total area of 49,159 square miles. The greater part of the country is a plain, rising in the south into spurs and foothills of the Carpathian Mountains. The chief river is the Vistula, which passes from south to northwest through the centre of the country, and with its branches waters the greater part of it, though the western part is drained by the German river Warta. The soil is fertile and one-half of the area of the country is arable land, while one-third is covered with forest. The principal crops are potatoes, rye, oats, and wheat. The raising of live stock, especially sheep and horses, is also important. Mining is carried on to a considerable extent in the southern highlands, and large quantities of coal and iron ore are produced. The total value of manufactured products amounts to \$125,000,000 annually. Commerce is facilitated by navigable rivers and over 1500 miles of railroad; the exports pass chiefly by way of Danzig, and consist principally of wheat, timber, wool, and cattle products. Although absolutely incorporated with Russia, Poland forms a separate general government, with a Governor-General residing in Warsaw. The total population in 1897 was 9,455,943, consisting chiefly of Poles, with about 1,000,000 Russians, 1,500,000 Jews, and a number of Germans. Russian is the official language and the language prescribed in the public schools. The Roman Catholic Church is adhered to by four-fifths of the inhabitants, and is officially administered by the Ministry of the Interior at Saint Petersburg. For further details, see articles on the separate governments; and for history, see **POLAND**.

POLAND, JOHN SCROGGS (1836-98). An American soldier, born in Princeton, Ind. He graduated at West Point in 1861, and was assigned as second lieutenant to the Second Infantry. In the Civil War he served in the Army of the Potomac until July, 1863, and was commissary of musters for the Department of Washington from September, 1863, to March, 1865. In June, 1862, he was promoted to be captain; in December, 1862, was brevetted major for gallantry at Antietam, Shephardstown, and Fredericksburg; and in May, 1863, was brevetted lieutenant-colonel for gallantry at Chancellorsville. In the battle of Gettysburg he was an aide on the staff of General Sickles. After the war he was an assistant professor at the Military Academy, first of drawing, then of geography, history, and ethics, and then again of drawing, until 1869; served on frontier duty for several years; and from 1881 to 1886 was head of the department of law at the United States Infantry and Cavalry School, Leavenworth, Kan. On the outbreak of the Spanish-American War in 1898 he was promoted to be brigadier-general of volunteers. He commanded for a time the Second Division of the First Army Corps at Chickamauga Park, Ga., and died of typhoid fever contracted there. He published a *Digest of the Military Laws of the United States from 1861 to 1868* (1868), *The Conventions of Geneva of 1864 and 1868*, and *Saint Petersburg International Commission* (1886).

POLAND-CHINA. A breed of hogs. See Hog, and Plate of Hogs.

POLANGUI, pò-lán'gè. A town of Southern Luzon, Philippines, in the Province of Albay

(May: Philippine Islands, H 6). It lies 20 miles northwest of Albany on the main road of the province, and on the Inaya River, in a situation very favorable for hemp traffic. Population, 10,050.

POLAR. See POLE AND POLAR.

POLAR BEAR. The white or ice bear of boreal regions. See BEAR.

POLAR CIRCLE, or ARCTIC CIRCLE. See ARCTIC.

POLAR CLOCK (from Neo-Lat. *polaris*, relating to the pole, from Lat. *polus*, from Gk. *πόλος*, *polos*, pivot, axis, pole, from *πέλωσθαι*, *pelesthai*, to be in motion; connected with Skt. *car*, to move). A form of polariscope invented by Sir Charles Wheatstone for telling the time of day, and based on the fact that light from the sun when scattered by the fine particles of the atmosphere becomes polarized. (See POLARIZATION OF SKYLIGHT.) This can be shown by looking at the sky through a plate of quartz or selenite and a Nicol prism, a series of colors being seen on revolving the Nicol. The effect is strongest if the apparatus is pointed toward the north pole of the heaven, and the succession of colors will follow from the motion of the sun, if the Nicol is allowed to remain stationary. In this way we can tell its position, and consequently the hour of the day, by the change in color. The polar clock, as described by Wheatstone, consists of a hollow conical tube so mounted that its axis can be brought parallel to the axis of the earth. At the base of the cone there is a glass disk, in the lower half of which there is a graduated semicircle divided into twelve parts representing the hours from six in the morning to six at night. This glass is fixed, but the conical tube itself can be rotated and contains at its larger end, adjacent to the glass disk just described, a second glass disk, on which at the centre are cemented a series of thin scales of selenite in the form of a star. These plates when viewed by polarized light exhibit strong contrasts of color. There is also on the glass an index, which is a prolongation of one of the principal sections of the selenite scales or plates. At the smaller end of the tube is mounted the Nicol prism with either of its diagonals making an angle of 45° with the principal section of the selenite plates. When seen through the Nicol the selenite will show a variety of rich colors, depending upon the position of the prism, but there will be two positions where the color will entirely disappear. At one of these positions a small disk of selenite will appear red, and at the other it will have the complementary color green, this effect being produced by placing the principal section of the small central disk $22\frac{1}{2}^\circ$ from that of the other sections of selenite forming the star. The time is ascertained by turning the tube on its axis until the color of the star entirely disappears, while the central disk remains red; the index should then point to the hour. Unlike the sun-dial, the polar clock need not be placed in the sun's rays; it may stand in the shade of a tree or building or at a window, and it may be used when the sky is overcast, unless the obscurity is too great. Consult: Spottiswoode, *Polarization of Light* (London, 1895); Hopkins, *Experimental Science* (New York, 1898); Müller, *Lehrbuch der cosmischen Physik*.

POLAR COÖRDINATES. See COÖRDINATES.

POLAR EXPLORATION. See POLAR RESEARCH.

POLAR HARE, or ARCTIC HARE. The American variety (*Arcticus*) of the European northern hare (*Lepus timidus*). See HARE.

POLARISCOPE (from Neo-Lat. *polaris*, relating to the pole + Gk. *σκοπεῖν*, *skopein*, to view). An instrument which consists of any combination of a means of producing polarized light, or 'polarizer,' and a device for testing the polarization of light, or 'analyzer.' In ordinary light (see LIGHT) the direction of vibration is changing millions of times per second. As a result of reflection, or refraction, the direction may be made to remain constant, and the light is then said to be 'polarized' plane, elliptically, or circularly, according as the motion of the ether particle is linear, elliptical, or circular.

When light is reflected from the surface of a transparent medium, as glass, at the 'polarizing angle,' the tangent of which is equal to the index of refraction of the medium, it is found to be plane polarized, and the plane in which the incident and reflected rays lie is called the plane of polarization. If such a polarized beam of light is allowed to fall upon a second similar mirror at the polarizing angle, it will enter the medium or be reflected according as the plane of this reflection is parallel or perpendicular to that of the first reflection. Polarization by reflection was discovered by Malus in 1810. As early as 1690 Huygens discovered that the two rays of light produced by the double refraction in calcite were polarized at right angles to each other.

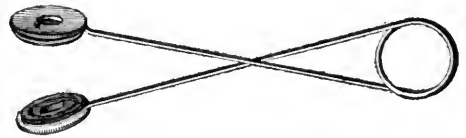

FIG. 1. TOURMALINE TONGS.

This apparatus consists of two plates of tourmaline so mounted as to revolve in their holders. The crystal or thin plate to be examined is placed between the two plates of tourmaline; the two plates act as polarizer and analyzer respectively.

Three methods of obtaining a beam of plane polarized light for experimental purposes are in general use, and are employed in polariscopes: (1) Reflection at the polarizing angle; (2) double refraction and the elimination of one of the beams, (a) by reflection (Nicol prism), (b) by sending it off to one side (Rochon prism, etc.); and (3) double refraction and the absorption of one beam, tourmaline plates. The Nicol prism (q.v.) is most generally employed in polariscopes and forms one of the best means for the production and detection of polarized light.

In a polariscope the polarizer and analyzer may be similar, or not. In the form devised by Norrenberg (Fig. 2) the polarizer is the mirror at the bottom of the apparatus, and the analyzer is a Nicol prism in the eye-piece at the top, or it may be that a bundle of thin plates of glass are used, as shown in the figure. When the plane of polarization of both polarizer and analyzer is the same, the ray which emerges from the polarizer will pass on through the analyzer, and they are said to be 'parallel' (Fig. 3); but if the two planes are perpendicular, then the beam

will all enter as the ordinary in the analyzer and be reflected and lost, and they are said to be 'crossed' (Fig. 4): the eye looking in at the eye-piece sees a dark field. If a plate of transparent



FIG. 2. NORREMBERG POLARISCOPE.

The polarizing mirror is shown in place, while above attached to the uprights are lenses for producing parallel, divergent, or convergent beams of light, and a support on which thin plates or other objects to be studied may be placed. The bundle of thin plates at the top used as an analyzer may be replaced by a Nicol prism, shown to the right at the base of the instrument, or by a mirror at the polarizing angle, shown to the left.

material be introduced between the polarizer and analyzer, it may happen that the field of the crossed combination will become light or colored. This will mean that the material has in some way affected the ray emerging from the polarizer so that it is no longer entirely cut off by the analyzer. Such substances are in general said

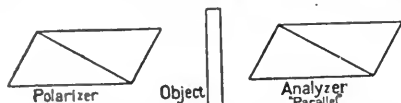

FIG. 3. POLARISCOPE WITH POLARIZING PRISMS PARALLEL.

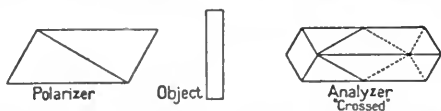

FIG. 4. POLARISCOPE WITH POLARIZING PRISMS "CROSSED."

to be 'double-refracting.' Substances which do not so affect the polarized beam are called 'isotropic' or 'single-refracting.' The double-refracting substances are generally crystalline and fall into two broad classes, uniaxial and biaxial. In certain double-refracting crystals there is one direction in which all light travels with the same velocity, and hence no double refraction occurs. This direction is called the optic axis and such substances are uniaxial. In biaxial crystals there are two directions, or optic axes,

along which all light travels with the same velocity, and around which the optical properties group themselves. Substances are studied in the polariscope in either parallel or convergent (or divergent) light, and the double-refracting media in general produce two beams from the original beam coming from the polarizer, and these two new beams, traveling with different velocities, are made to interfere when their components are brought into the plane of the analyzer. As white light is generally employed at the polarizer, and as the kind of interference is a function of the wave length, colors are usually seen at the analyzer. A complete study of these color phenomena, and their general behavior in the polariscope, make it possible to determine the identity of most minerals from their optical properties. This branch of optics has developed into microscopic petrography, which has so supplemented the other tools of the mineralogist and geologist that these sciences have been revolutionized.

Certain substances, as quartz parallel to the optic axis, solutions of sugar, tartaric acid, etc., possess the peculiar property of rotating the plane of polarization to an extent depending upon the wave length of the light and the thickness of the layer traversed. That is to say, if the polariscope is set 'crossed' and a plate of quartz cut perpendicular to the axis introduced, the eye-piece field will appear lighter if monochromatic light is used, and it will be necessary to rotate the analyzer in order to again obtain the dark field. This rotation may be clockwise as viewed from the polarizer, 'right rotating' or 'dextro-rotary,' or it may be the reverse, 'left rotating' or 'levulo-rotary.' If white light is used, colors will appear in the field of view, and the tint 'crossed' will always be complementary to that seen in the 'parallel' position. These colors are in general due to the fact that, as the rotation for different colors is different, certain ones will be passed through the analyzer and others cut off.

The rotation of the plane of polarization in solutions of cane sugar is made use of commercially on a very large scale in testing raw sugar for its content of crystallizable sugar. Very many forms of apparatus have been devised for this especial purpose. One of the more complicated, due to Soleil, is shown in Fig. 5; D is the tube in which the sugar solution is placed; C is a double quartz plate, half right and half left rotating, which affords a very sensitive means of setting the instrument to the same adjustment each time; B is the polarizer; A is a combination of a Nicol prism and a quartz plate, which by rotation enables the observer to correct for the color of the solution and obtain the most sensitive tint in the double quartz plate, C; F is the analyzer; G is a small Galilean telescope focused upon C; and E is the compensating system which corrects the rotation due to the solution instead of following it up. A plate of right quartz, *b*, is just neutralized by wedges of left quartz, *a*, when they are as shown at *a*. If the solution rotates right, then the wedges are slid together so as to offer an excess of left rotation over *b* and neutralize the right rotation of the solution. If the solution is left rotating, the wedges are slid apart and the excess of right rotation of *b* neutralizes the rotation of the solution. The motion of the wedges is controlled by a rack and pinion, and

is measured by a scale which may be made to read off percentage of sugar directly, provided a solution of certain standard strength and length is used. In 1845 Faraday demonstrated that a piece of glass in a strong magnetic field would rotate the plane of polarization in the direction in which the current of the electromagnet flows,

no polarization in fog, cloud, or dense haze. As there is an evident connection between the polarization of skylight and the quantity of moisture, haze, or smoke in the atmosphere, there have been numerous investigations of this subject both from an observational and a theoretical point of view.

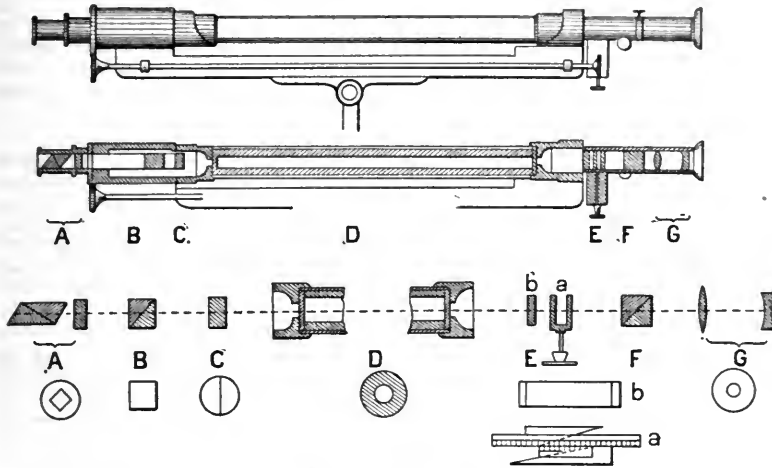

FIG. 5. POLARISCOPE FOR LIQUIDS.

and to an extent dependent upon the glass and the strength of the magnetic field. It has now been proved by Perkin and others that this is a rather common property of transparent media.

BIBLIOGRAPHY. Consult: Preston, *The Theory of Light* (London and New York, 1895); Spottiswoode, *Polarization of Light* (London, 1895); Thompson, *Light, Visible and Invisible* (New York, 1897); Mascart, *Traité d'optique* (Paris, 1889); Landolt, *Handbook of the Polariscope*, English translation by Robb and Veley (London, 1899).

POLARIZATION. A term used in physics with many applications, but generally to signify a property of matter or of the ether which has a definite direction. A magnet is said to be polarized; so is a dielectric under the action of electrically charged bodies. When, owing to the passage of an electric current through an electrolyte, there are chemical actions at the electrodes which oppose the current, the electrolytic cell is said to be polarized. When a definite characteristic is given ether-waves—e.g. if the vibrations are all in one plane, or if they are all in circles or ellipses—they are called polarized. See ELECTRICITY; LIGHT; VOLTAIC CELL OR BATTERY; POLARISCOPE.

POLARIZATION OF SKYLIGHT. The polarization of blue skylight was known to Huygens, and is evident to any one who will look at the sky through a prism of Iceland spar. After a systematic investigation of the distribution of polarized light in different parts of the sky, Arago (1811) discovered that a certain portion or spot in the sky shows no polarization. This point varies with the altitude of the sun. Subsequently similar points were discovered by Arago (1840) and Brewster (1842). The maximum polarization occurs in a narrow zone 90 degrees distant from the sun. Similar but feeble polarization occurs in moonlit skies. There is

water surfaces was impossible. Observations of skylight during recent total eclipses of the sun seem to have shown that the amount of polarized light increases during and just before and after totality. Such an effect might be produced either by the increased condensation of aqueous vapor, owing to the cooling of the atmosphere within the shadow of the moon, or by the fact that in place of the ordinary sunlight we now have to do with the polarized light from the solar corona.

The most acceptable theory as to the origin of the polarization is that started by the experiments of Tyndall on the reflection of sunlight from delicate clouds of vapor and perfected by Lord Rayleigh, who showed that when light is transmitted through a cloud of particles smaller than the wave length of the light, the latter is scattered laterally and polarized in the plane of scattering. In 1899 Rayleigh submitted the additional demonstration that not merely the grosser particles of dust and aqueous vapor, but even the molecules of oxygen and nitrogen, and probably those of other gases, take part in the process of scattering and polarization. Consult *United States Monthly Weather Review* (Washington) for September, 1900, where will be found a summary of recent work in this field and a bibliography.

POLAR RESEARCH. The polar regions comprise all lands and seas within the polar circles, extending northward from the Arctic Circle and southward from the Antarctic Circle to the respective poles of the earth. The barrenness of the land, often ice-covered and largely devoid of animal and vegetable life, with the extended and heavy ice-fields in the sea, has made exploration slow and hazardous.

MOTIVES OF POLAR RESEARCH. Exploration in the far north has been more extensive than that in the far south, chiefly because the Arctic is much nearer to the great maritime nations

The simplest and most accurate polarimeter for studying this phenomenon was devised in 1872 by Prof. E. C. Pickering, director of the Harvard College Observatory. Observations made with this apparatus seem to show that the reflection of the sunlight from the surface of the sea into the atmosphere produced a decidedly perceptible disturbance of the polarization of skylight as compared with that observed from interior stations where such reflection from

and its waters merge with those which in modern times have been the predominant highways of sea trade. The whale and seal fisheries of the north opened the great era of Arctic discovery in the seventeenth century. For 150 years after Henry Hudson in 1607 examined the long edge of the pack-ice from Greenland to Nova Zembla, the annals of the Dutch and English whaling trade provided nearly all information of the Arctic area.

The commercial instinct that led to the first great Arctic voyages had two distinct phases. One was the endeavor to extend the limits of the northern fisheries; and while the prosecution of the Arctic whaling industry added a vast sum to the wealth of the world—estimated at over \$600,000,000 in 200 years before the middle of the nineteenth century—it naturally resulted in largely extending our knowledge of the north polar world. The other phase was the desire to shorten the water route between the ports of West Europe and the rich Orient by finding either a northwest or a northeast passage between them. This ambition was a great stimulus to Arctic exploration from the days of Barents, Baffin, and Hudson near the opening of the seventeenth century till the time of Sir John Franklin in the middle of the nineteenth century.

The commercial incentives for polar exploration thus predominated until far into the nineteenth century and were strongest in the north near the seafaring nations, with the result that while the unknown area of the Arctic regions is now only about as large as European Russia, that of the Antarctic domain is double the size of Europe.

The fact that the largest discoveries of the eighteenth century were made by sailors, that period being an era preëminently of the survey of coast lines and the discovery of islands, had the effect of stimulating voyages both into Arctic and Antarctic territory for geographical purposes; but the era of scientific research in the polar regions scarcely began till the first half of the nineteenth century. The humanitarian impulse that led many expeditions to engage in the search for Sir John Franklin resulted in enormous additions to our knowledge of Arctic America. In recent years the avowed purpose of the most worthy expeditions has been scientific research.

EQUIPMENT. One of the important results of polar research is the present methods and outfit for work and life in the ice zones, evolved from the experience of three centuries. The problem of fairly comfortable and hygienic existence for white men in the polar regions has been solved. For more than 250 years white men in the Arctic suffered severely from scurvy. The food supplies long included large quantities of salt meat, and until recently the dietary of Arctic whalers and explorers was almost certain to breed scurvy. If they now fall victims to this disease it is the result of great carelessness or ignorance. The art of selecting and preserving foods of healthful and great nutritive quality for use on polar expeditions has been reduced to a science. The ships employed by explorers were formerly poorly equipped for battling with the ice; but the exploring craft of the present, of which the *Fram*, *Discovery*, and *Gauss* are the best examples, are believed closely to approximate the ideal type of vessel for ice navigation. They are built with

rounded sides, so as to offer as little hold as possible to the clutches of the ice-pack, and they provide comparatively comfortable accommodations for the men. The substitution of steam for sails, the larger use of dogs instead of men at the sledge ropes, the adoption of the snowshoe and Norwegian ski in snow work, the great improvements in sledges, the utilization of Arctic game for food and to a considerable extent of the methods of living, the boats, the snow houses, and some other appliances of the Eskimos, have been very helpful factors in recent exploratory work.

NORTH POLAR EXPLORATIONS.

Fully one-half of the area of the Arctic regions consists of well-known land, of which, however, only small portions in Northern Russia, Sweden, Norway, and Alaska are inhabited. Scattered Eskimo huts dot the seacoasts of the north coasts of America, the Parry Archipelago, and Greenland, and hunting bands of Samoyedes winter in Nova Zembla.

The archipelago of Franz Josef Land, New Siberia, Spitzbergen, and Wrangell Land in the Eastern Hemisphere, and all lands to the north of the 79th parallel in the Western world, are uninhabited, and exploration turns in these directions.

ROUTES OF EXPLORATION. The six main approaches to the unknown Arctic Ocean and its scattered islands are the Nova Zembla or Northeast Passage; the Franz Josef or Barents Sea; the Spitzbergen or Greenland Sea; Smith Sound; Lancaster Sound (Northwest Passage); and Bering Strait.

NOVA ZEMBLA (NORTHEAST PASSAGE). After the discovery of America came efforts to find northeast and northwest passages to India. Of early English explorers, Willoughby and Chancellor in 1553 opened Archangel Bay; but Willoughby and two of his three ships were involved in the first great Arctic tragedy, the leader and his 62 men perishing of scurvy during the winter; while Burrough (1556) and Pet (1580) discovered and explored the Waigat, the strait leading into the Kara Sea, south of Nova Zembla. Most successful of early voyages were the three expeditions of a Dutchman, Willem Barents. In 1594 he traced northeastward the coast of Nova Zembla to the Orange Islands, 77° north. Failing next year to pass the Waigat, Barents sailed in 1596 under Jacob Heemskerck, but parted from him and rounded the North Cape of Nova Zembla. In sailing south on the east coast the party was beset and obliged to winter in Icehaven, Barents Sea. After great privations they abandoned their ship in the summer and retreated by boat to Kola, Barents dying en route. This last voyage of Barents was one of the most important of all the journeys to the unknown Arctic frontier. He showed the terrific pressure of the polar pack upon the north coast of Nova Zembla, and the existence at least occasionally of much open water to the north, a fact that has expedited many voyages to and from Franz Josef Land. Out of Chancellor's voyage arose the Muscovy Company, to the incalculable advantage of English commerce. From Barents's voyage eventually resulted the Dutch whale fisheries.

Russian energy, taking up the problem, outlined between 1636 and 1648 great extents of coast line. Among the explorers who achieved prominence were Elisé Busa, who traveled

between Olenek and Yana, and Simeon Deshneff, whose voyage from Kolyma to Kamtchatka (1648) determined the separation of Asia and America. A century later came 'the great survey' and a score of expeditions. Chariton Laptieff and Tchelyuskin discovered the North Cape of Asia (1742). Dmitri Laptieff (1737-42) skirted the coast from the Lena to Cape Baranov, thirty degrees of longitude, thus practically completing the Asiatic coast line.

Adolf Erik Nordenskjöld solved the vexatious problem of the circumnavigation of Asia and Europe. Leaving Tromsø in the *Vega*, in June, 1878, Nordenskjöld passed the Waigat and Kara Sea, rounded Cape Tchelyuskin, skirted the New Siberian Islands, and was definitely stopped by ice only 110 miles from Bering Strait. Forced to winter to the east of Cape Szerde Kamen, Nordenskjöld reached Yokohama in 1879, having made without disaster the Northeast Passage.

Another phase of Asiatic exploration somewhat related to the Northeast Passage is that of the islands of the Siberian Ocean. Liakhoff (1770) first visited the island of his name, and later added two others to the New Siberian Archipelago. He was followed by Samkiff (1805), Sirovatskoff (1806), and Bjelkoff (1808), all ivory-hunters. The daring sled-journeys of Lieutenants F. v. Wrangell and P. F. Anjou (1820-23) skirted the New Siberian and Bear islands, but had no material results, there being only open sea at Anjou's farthest, 76° 37' north, 138° east. In 1881 a northerly extension of this archipelago was discovered by De Long, commander of the *Jeannette*, as is elsewhere stated. The most notable explorations of the New Siberian Islands, yielding a wealth of scientific data, are those of Baron Von Toll, now extending over many years.

Fridtjof Nansen, a Norwegian, in 1893 passed the Waigat in the *Fram* on a novel and hazardous attempt to explore the vicinity of the North Pole by a drift voyage. The Siberian Ocean was very open, and the *Fram* was not beset until she had reached a comparatively high latitude (78° 50' N., 134° E.), northwest of Sannikoff Island, about 200 miles east of the place where her predecessor, the *Jeannette*, sank in 1881. The *Fram*, under O. Sverdrup, drifted almost uninterruptedly west-northwest until she reached 85° 57' N., 70° E., when the course changed gradually to west and southwest to northwestern Spitzbergen, where she escaped the ice after a besetment of thirty-five months. Nansen left the ship with Lieutenant Johannsen in March, 1895, on a sledge trip to reach the Pole, but unfavorable ice conditions obliged their return from 86° 4' N., 96° E. They traveled south by sledge and by kayak as the sea opened, but it was 153 days before they reached Franz Josef Land. Building a hut, they lived on the plentiful game, and, starting for Spitzbergen in the spring, were, after a hazardous journey, saved by the Harmsworth-Jackson expedition near Cape Flora in the southern part of Franz Josef Land. The *Fram* found no land in the polar ocean, but in its place discovered that from 140° E. to 10° E. the sea is of great depth, with rich fauna. It had hitherto been supposed that this part of the polar sea was shallow. Nansen in his southward journey limited the northeast extension of Franz Josef Land and traced a part of its shores.

FRANZ JOSEF LAND. Two Austrians, C. Wey-

precht and J. Payer, opened this route while exploring the Barents Sea. Their ship, *Tegetthof*, beset in 76° 22' N., 63° E., drifted northward for a year, and in August, 1873, they saw the south shores of Franz Josef Land, where the ship was abandoned in 80° N. (1874), the party reaching Nova Zembla by boat. Payer by sledge journeys explored many of the islands of Franz Josef Land, and reached Cape Fligely, 81.5° N., 58° E. English explorers followed, and in two voyages (1880 and 1881) Leigh Smith covered the coast from 54° E., Payer's westerly point, to 42° E., and while wintering at Cape Flora, owing to the loss of his ship, the *Eira*, discovered rich fauna and flora. F. G. Jackson (1894-97) established his base at Cape Flora and made extensive explorations between 42° E. and 56° E. and to 81° 20' N. Jackson rounded Alexandra Land and conclusively proved that Franz Josef Land is composed of numerous islands of limited area. It may here be added that the discoveries of White Island (2000 feet high) by Kjeldsen (1876) and New Iceland (also a frowning, high land mass) by Johannsen (1887) indicate that Franz Josef is merely an extension of the great Spitzbergen Archipelago. W. Wellman, an American, unsuccessful in Spitzbergen in 1894, renewed his efforts to reach the Pole in 1898 by way of Franz Josef Land, when E. B. Baldwin, discovering Graham Bell Land, extended the archipelago to 65° E. The Duke of the Abruzzi (1899) reached, in the *Stella Polare*, 82° 4' N., northeast of Rudolph Island, and wintered in Teplitz Bay, 81° 47' N. He explored Austria Sound, while his assistant, Captain Cagni, starting for the Pole, reached 86° 34' N., 64° E., the most northerly point attained by man, and 236 statute miles from the Pole.

THE REGION OF SPITZBERGEN. In 1598 the Dutch, under J. C. Ryp and J. Heemskereck, discovered Bear and Spitzbergen islands, exploring the west coast of the latter as far as 79° 49' N. In 1607, in one of his most remarkable voyages, Henry Hudson, the English navigator, followed the west coast to 80° 23' N., crossed Greenland Sea, discovered Jan Mayen, and sighted East Greenland in 73° N. Hudson's discoveries led later to the very lucrative whale fisheries.

THE GREENLAND SEA. Numberless whalers explored every sound and inlet during the seventeenth and eighteenth centuries for commercial purposes. Efforts toward geographical exploration northward in this region have been singularly fruitless. Phipps (1773) reached 80° 48' N., 20° E., only 25 miles beyond Hudson (1607). Scoresby, the elder, attained, in 1806, 81° 30' N., 19° E. Nordenskjöld and Otter reached 81° 42' N., 18 E. Parry in his wonderful boat and sledge journey (1827) pressed on to 82° 45' N., 18° E., the highest ever attained in the Greenland Sea.

THE SPITZBERGEN ARCHIPELAGO. Scientific exploration of the archipelago began in the nineteenth century with Clavering and Sabine (1824), and the French commission, Fabre, Gaimard, Martins, and Marnier (1838). Most notable of countless explorations in recent years are the following: Torrell and Nordenskjöld (1861) first visited Northeast Land, reaching Cape Platen and Phipps Island, 80° 42' N.; Carlsson (1863) first circumnavigated Spitzbergen; Nordenskjöld (1872) first crossed Northeast

Land from Otter Island to Wahlenberg Bay; Leigh Smith (1871) traced and rounded Northeast Land to Cape Smith on the east coast, and reached $81^{\circ} 30' N.$, $18^{\circ} E.$; Conway (1896) crossed in several ways the main island, and surveyed 600 square miles of the ice-free interior. Danes Island (1897) was the base of the tragic balloon voyage of Andrée (q.v.).

Of easterly extensions of the archipelago, opinions widely differ as to Giles and Wiche Lands. Possibly White and New Iceland islands, already mentioned, are the Giles Land of 1707. Wiche Land of Edge (1617) is probably King Charles Land, which, rediscovered from Mount White by Nordenskjöld (1864), was first visited by Nilsen (1872).

EAST GREENLAND. Nor has this route to the far north been much more successful as regards East Greenland. After Hudson saw the coast in 1607, at $73^{\circ} N.$, it was observed occasionally by whalers as follows: Hamke (1654), $74.5^{\circ} N.$; Ruys (1655), $73.5^{\circ} N.$; Edam (1655), $70^{\circ} N.$; and Lambert (1670), $78.5^{\circ} N.$ W. Scoresby, Jr. (1822 and later), discovered Scoresby Sound and charted 800 miles of coast between 69° and $75^{\circ} N.$, giving the first correct idea of the coast. Sabine and Clavering (1823) explored the coast from Pendulum Island to Shannon Island, $75^{\circ} 12' N.$ Koldewey and Payer (1870) reached $77^{\circ} 1' N.$, the highest point attained by this route. What is more important, they discovered and explored Franz Josef Fiord, penetrating inland five degrees of longitude to $73^{\circ} 11' N.$, $26^{\circ} W.$ The Danish sea captain Wandel (1879) surveyed the coast from a distance of about six miles between 66° and $69^{\circ} N.$ Graah (1829), Holm (1883-85), and Ryder (1902) did excellent work south of the Arctic Circle; Peary's crossing is elsewhere mentioned. Naero (1900) reached $75^{\circ} 30' N.$, the highest by ship in modern times.

LANCASTER SOUND AND THE NORTHWEST PASSAGE BY SEA. The first great advance toward the Northwest Passage came through three voyages of John Davis, who discovered the strait afterwards named for him in 1585, reaching the vicinity of what is now Godthaab, Greenland. Failing in 1586, Davis in 1588 by a voyage of reckless daring reached Sanderson's Hope, about $72^{\circ} 12'$, and, turning westward in his tiny craft, passed through the dreaded middle ice of Baffin's Bay to the west shore. His discoveries covered West Greenland from Cape Farewell to Sanderson's Hope, and the American coasts from Labrador to Cumberland Island. He was followed by another great English sailor, William Baffin, in the *Discovery*, of only 55 tons, with which, reaching Baffin Islands, he crossed the bay of his name by the 'Middle Passage,' passed Cape York, and on July 5, 1616, was in Smith Sound in sight of Cape Alexander. His latitude of $77^{\circ} 45' N.$ remained unequalled in this sea for 236 years. Baffin added to geographical knowledge Ellsmere and Prudhoe lands, and the sounds of Smith, Jones, and Lancaster.

John Ross in 1818 penetrated Lancaster Sound some fifty miles, but, meeting heavy ice, mistook it for a closed bay. He was followed in 1819 by one of the ablest of Arctic explorers, William E. Parry, who opened to the westward a series of magnificent waterways: Lancaster Sound, Barrow Strait, Melville Sound, and Banks Strait, leading through the Parry Archipelago to the Arctic Ocean. Parry's route, along the 74th

parallel, was to the north of the magnetic pole, the compass variation changing gradually from $109^{\circ} W.$ to $180^{\circ} W.$, and thence to $166^{\circ} E.$ Land journeys of his party in 1820 explored the vicinity of their winter quarters at Melville Island. Parry's second voyage, only important in relation to Franklin's land journeys, explored (1821-23) Repulse Bay and Melville Peninsula. In his third voyage (1825) the *Fury* was lost in Prince Regent Inlet. The expedition of John Ross, of unprecedented length (1829-34), explored Boothia Felix Peninsula, the northern extremity of the American continent, and King William Land, together with adjacent waterways. Most important was the location by his nephew, James Clark Ross, of the north magnetic pole in $70^{\circ} 5' N.$, $96^{\circ} 44' W.$

The voyages of the Englishman Lyon (1824) to Repulse Bay and of Back (1836) to Hudson Strait were fruitless, and it remained for the Franklin expedition to solve the problem of the Northwest Passage, partly by its own efforts and largely through relief voyages. Successful Antarctic work had renewed interest in the Arctic, and Sir John Franklin was despatched from England with two ships and 129 men to make the Northwest Passage. Franklin, wintering in 1845 at Beechy Island, explored the adjacent regions to $77^{\circ} N.$ Sailing south to the west of North Somerset and Boothia, his ships were beset in September, 1846, near King William Land, in $70^{\circ} 5' N.$, $98^{\circ} 23' W.$, within 90 miles of the known sea off the American continent. The only recovered record found by Hobson of McClintock's party in 1859 shows that the ships were abandoned April 22, 1848, Franklin and 23 others having previously died. Captain Crozier with 105 men perished in an attempt to reach Fish River. Their route, via King William Land, Todd and Montreal islands, is marked by graves and skeletons. The party practically vanished from human knowledge until Rae, in 1854, and McClintock, in 1859, revealed its fate.

Franklin's absence caused many search expeditions, which were remarkably fruitful in the exploration of the American Arctic from the west coast of Greenland westward. The voyages from the Atlantic of James C. Ross, W. Penny, A. Stewart, John Ross, E. J. DeHaven, C. Forsyth, and W. Kennedy discovered no trace of the explorer, though they added something to geographical knowledge. The efforts of T. E. L. Moore and H. Kellett from Bering Strait were also fruitless, except for the discovery of Herald Island. More successful was the voyage (1850-53) of Captain Collinson, who navigated the *Enterprise* through ten degrees of longitude along the coast of America, and safely back to Bering Strait. Wintering in Cambridge Bay, Victoria Land, he explored its southern shore, looked across the sea where Franklin's ships had sunk, though that was unknown to him, and even picked up relics of the squadron.

R. McClure (1850-54) from Bering Strait carried the *Investigator* to Banks Land, which he explored, as well as Prince Albert Land to the east. Wintering three years, he finally abandoned his ship in Mercy Bay. Through a sledge party which was sent to seek him, McClure learned of Belcher's squadron at Beechy Island, and this he joined by sledge, thus making the only north-west passage. H. Austin's squadron, via Lancaster Sound from the Atlantic, first saw traces

of Franklin, Ommaney finding in August, 1851, three graves at Beechy Island. Brown, Ommaney, Osborn, Aldrich, Bradford, and McClintock of Austin's party traveled by sledge 3340 miles, and discovered 670 miles of coast to the westward of winter quarters at Griffith Island (1850-51). Edward Belcher commanded (1852-53) another squadron of five ships sent out by the British Admiralty. McClintock, Meham, Nares, Hamilton, Pim, and Domville fruitlessly searched adjacent lands in journeys that aggregated 5892 miles, of which McClintock, the greatest of Arctic sledgemen, traveled no less than 1401 miles. Belcher brought home McClure's crew from the *Investigator*, but had to abandon, in 1853, two of his own ships, the *Intrepid* and the *Resolute*. The latter, drifting south, was picked up in 1854 by an American whaler, was bought by the United States, and was refitted and returned to Great Britain. The nation having failed to find certain traces of Franklin, Lady Franklin sent McClintock in the *Fox* on a search expedition. Beset in Baffin's Bay, McClintock, after a winter drift of 1200 miles, pushed on in the next summer (1858), and, following Peel Sound, wintered at Port Leopold. McClintock, Hobson, and Young, covering the whole field in sledges in 1859, discovered 800 miles of coast and unraveled the mystery. Boothian natives with Franklin silver led to the finding of boats, sledges, tents, and skeletons on King William Land, and finally of a written record. This told of Franklin's besetment and death, of the abandonment of the ships, and of Crozier's retreat toward Great Fish River.

THE NORTHWEST PASSAGE BY LAND. The Northwest Passage also involved land journeys, which began with Hearn's explorations from the Hudson Bay post, Fort Prince of Wales, in 1771, when, traveling with an Indian war party, he reached the mouth of the Coppermine, 67° 48' N. One of the Northwest Fur Company, Alexander Mackenzie, started from Fort Chipewyan to trace the waters of Slave Lake to the sea. Undeterred by tales of hardship and disaster, with Indian guides he reached, in July, 1798, Whale Island, 69° 14' N., at the mouth of the great river that bears his name. Mackenzie's successor, John Franklin, was the most notable figure associated, whether by land or sea, with the Northwest Passage. Coöperating with Parry, at sea, in 1819 Franklin pushed his advance posts by winter journeys to Fort Enterprise, 64° 28' N., 113° W. Accumulating supplies on the Coppermine, in 1821 he reached the mouth and explored the sea-coast eastward to Port Turnagain, 68° 18' N., 109° W., turning back the same day that Parry sailed out of Repulse Bay, 539 miles distant. In 1825, acting in concert with Beechy in Bering Strait and Parry in Lancaster Sound, Franklin established his base at Fort Franklin, Great Bear Lake. In 1826, reaching the mouth of the Mackenzie, Franklin coasted westward, while John Richardson explored to the east. Franklin was turned back at Return Reef, 70° 26' N., within 160 miles of Port Barrow. Richardson in a successful journey rounded Cape Bathurst, discovered Wollaston Land, and reached Cape Hope, 68° 58' N. He had traced the continental coast line through 20 degrees of longitude and 2 degrees of latitude, discovered a new land, determined tidal conditions, and made valuable geological and botanical observations.

In 1833 G. Back, wintering at Fort Reliance, Great Slave Lake, discovered the Great Fish or Back River, and the following year passed beyond its mouth to Port Ogle, at the east entrance of Simpson Strait.

In 1837 two employees of the Hudson's Bay Company, P. W. Dease and T. Simpson, operating from Fort Chipewyan, reached in 1837 Port Barrow to the west, and, wintering at Fort Confidence, explored in 1838-39 the continental shore line to the east, reaching Cape Herschel, 68° 41' N., 89° W. It remained for John Rae practically to complete the exploration of the north coast of America. From Repulse Bay, in 1846-47, Rae proved that Boothia Felix was a peninsular extension of North America, and connected with the discoveries of Parry and Ross by sea. It fell, however, to Capt. C. F. Hall, an American, in 1868 to trace the west coast of Melville Peninsula, the last unknown shore between the farthest of Rae in 1846 and of Parry in Fury Strait in 1825. In the Franklin search the northern coasts of America were examined by J. Richardson and Rae (1848-49); the latter visited Wollaston Land in a boat expedition which brought him within fifty miles of Franklin's farthest, the nearest approach to the Northwest Passage by sea. Rae in 1854 wintered at Repulse Bay, and the following April fell in with Eskimo, who gave him the first news of the Franklin disaster, reinforcing their story of the retreat on King William Land by silver bearing the Franklin crest. The last search for news of Franklin was made in 1878-79 by F. Schwatka and W. H. Gilder, who found in King William Land graves, skeletons, and relics.

SMITH SOUND. E. A. Inglefield by his voyage of 1859 opened waterways to the north, as he reached 78° 28' N., off Cape Sabine. He also penetrated far into Jones Sound and charted 600 miles of new coast. In 1853 Dr. E. K. Kane of Philadelphia pushed the *Advance* through Smith Sound into Rensselaer Harbor, 78° 3' N., 71° W. His surgeon, Dr. I. I. Hayes, traced the east shore of Grinnell Land to Cape Frazer, 79° 43' N., and W. Morton, a member of Kane's party, passing Humboldt glacier, reached Cape Constitution, 80° 35' N., whence he viewed Kennedy Channel to Mount Ross. In 1855 Kane abandoned his ship and retreated safely to Upernivik by boat. Hayes in the *United States* returned to Smith Sound in 1860, wintering his ship in Foulke Fiord and penetrating the inland ice some forty miles. In 1861 by a sledge journey he reached the vicinity of Cape Goode, Grinnell Land, about 80° 11' N. Captain Hall succeeded better, and in the *Polaris* (1871), passing Kennedy and Robeson channels, entered the Arctic Ocean near Repulse Harbor, 82° 11' N., the highest northing then attained by ship. Forced southward by ice, he anchored in Robeson Channel, under lee of a huge floeberg, explored adjacent parts of Greenland, and charted the Grinnell Land to its northern extremity beyond the 83d parallel. Hall died that autumn, and the *Polaris*, returning south in 1872, was wrecked near Littleton Island. Part of the crew under Captain Tyson drifted in the ice-pack five months, 1300 miles, and were saved off Labrador by the *Tigress*. Others wintering at *Polaris* boat-house were rescued in 1873 near Cape York.

George S. Nares in 1875 commanded a British squadron, of which the *Discovery* wintered in

Lady Franklin Bay, while the *Alert* was pushed into the Polar Sea to Floeberg Beach, 82° 25' N., on the northeast coast of Grinnell Land. The members of this party made several notable sledge journeys. L. A. Beaumont from Discovery Harbor extended the northern shores of Greenland from Cape Bryant to Cape Britannia. P. Aldrich traced Grinnell Land to Cape Columbia, 83° 7' N., and thence westward to Cape Alfred Ernest, 86° W., 220 miles of new coast. Lieutenant Areher explored a fiord of his own name. A. H. Markham, taking to the frozen sea, attained 83° 20' N., then the highest north.

Next came the American contribution to the international polar expedition under A. W. Greely, which primarily devoted itself to scientific observations, magnetic, meteorological, tidal, pendulum, etc., from 1881 to 1883. The commander explored the great glacial lake system of interior Grinnell Land. J. B. Lockwood and D. L. Brainard later crossed Grinnell Land to the southeast, discovered Greely Fiord, and extended that inlet to Cape Lockwood, about 83° W., 80° N. These inland journeys added about 6000 square miles of new land, developed fertile valleys, and plentiful animal life in a land thought to be largely ice-capped.

Lockwood and Brainard, accompanied by a supporting party to Cape Bryant, discovered a new archipelago north of Greenland, and attained 83° 24' N., 43° W. They located Cape Washington, 83° 35' N., 38° W., and determined that there was no land in the Arctic Ocean far beyond the 84th parallel. It was then the highest north ever attained, and Peary's explorations show this archipelago to be the most northerly known land. In 1884 the Cape Sabine region was explored by the Greely expedition, when F. Long discovered Schley Land, at the head of Hayes Bay. Nordenskjöld (1883) from Disco Bay reached an elevation of 6600 feet on the inland ice of Greenland in 68° 32' N., 43° W., more than half way to the east coast. Nansen's crossing (1888) was not a polar journey. The most persistent explorer of Smith Sound is R. E. Peary, who has passed parts of eight years therein. In 1886 he ascended the inland ice fifty miles from Disco. In 1892, with one companion, Eivind Astrup, he crossed from McCormick Bay to Independence Bay, 450 miles in a direct line. He repeated this trip in 1895. These difficult journeys, over an ice-cap 8000 feet high, defined the northeast limit of Greenland, 81° 37' N., 34° W., some 200 miles north of Lambert (1670) on the east coast. In his latest voyage (1898-1902) Peary established the continuity of Ellesmere and Grinnell lands, west of Hayes Bay, and also crossed from near Cape Hawkes to the vicinity of Greely Fiord on the west coast. In 1900, passing Cape Washington of Lockwood, he left the solid ground in 83° 39' N. (the most northern known land), and reached 83° 50' N. on the Arctic ice-pack. Peary's farthest east, 83° N., 35° W., determines the limitation of the northeast coast of the archipelago above Greenland. In 1901, leaving Cape Hecla, Grinnell Land, he attained 84° 17' N., 65° W., the record latitude in the Western Hemisphere. O. Sverdrup, wintering in the *Fram* in Kane Basin (1898-99) and in Jones Sound (1899-1902), proved the continuity of Ellesmere Land by tracing its western shores from Belcher's farthest in Jones's Sound to a point north of Greely's Fiord, within 60 miles of

Aldrich's farthest. Sverdrup also discovered and traced the coasts of three islands, to the westward of Ellesmere Land, the largest extending from about 79° to 83° N., and two others being between 78° and 80° N., and from 92° to 106° W.

BERING STRAIT. This was the last attempted route for polar exploration, but the results of expeditions that proceeded via Bering Strait are by no means unimportant. V. Bering's voyage of 1728 added nothing to the discoveries of Deshneff in 1648. The great English navigator James Cook attained in 1778 70° 44' N., near Icy Cape, Alaska. In 1826 Otto v. Kotzebue discovered Kotzebue Sound, not seen by Cook. The British expedition of F. W. Beechey reached by ship 71° 8' N., 164° W., while his boats under Elson attained Point Barrow, the most northerly point, except Boothia Felix, of the continent of America. The voyages of the *Enterprise* and *Investigator* are mentioned under the Northwest Passage. In 1849 H. Kellett, R.N., discovered Herald Island, and in 1855 John Rodgers of the American navy reached in that sea the highest point gained up to that time, 72° 5' N., 175° W. An American whaler, T. Long, discovered Wrangell Island, sailing along its south coast in 1867. The most daring and important expedition through Bering Strait was that under Commander G. W. De Long, who sailed in the *Jeanette* in 1879. Beset by the pack, he was unable to winter at Wrangell Land, but, drifting westward past its north coast, he exploded the theory that it was a continent extending across the North Pole. An east-by-north drift continuing, the De Long Islands were discovered in 1881, G. W. Melville landing on Jeannette Island, in 76° 47' N., 159° W. The *Jeannette*, crushed by ice, sank June 12, 1881, in 77° 15' N., 155° E. De Long retreated southward toward the New Siberian Islands, being carried while marching to 77° 36' N., 155° E., the most northerly point ever reached in that sea from Bering Strait. Separated by storm and entering the Lena Delta by different channels, De Long and Melville met different fates, the former perishing of starvation with most of his party, while Melville brought his men to safety and afterwards, by a sledge journey into the Delta, ascertained the fate of his leader. De Long perished, but his plan was taken up and pushed to success under the daring leadership of Nansen, described under the Nova Zembla route.

ANTARCTIC EXPLORATIONS.

Practically without land fauna or flora, uninhabited, and far from adventurous nations, the Antarctic Circle is rarely visited. James Cook (1773-1774) circumnavigated this ocean, entered the Antarctic Circle at four widely separated points, and reached 71° 10' S., 107° W. There are three recognized routes of exploration to the land lying south of Patagonia, of Kerguelen Island, and of Tasmania.

PATAGONIA. The first Antarctic discoverer, an American whaler, Nathaniel B. Palmer, in 1821, discovered the Palmer Archipelago, lying north of what is supposed to be a portion of the Antarctic continent. The mass of what is believed to be the mainland is now known to extend from 63° to 70° S. and to subtend 20 degrees of longitude. Palmer met in his voyage the Russian expedition under Bellingshausen, who in an extensive Antarctic voyage added several islets,

discovered Alexander Land, and approached the great ice-barrier. Weddell (1823) found open sea in 30° W. up to 74° 15' S., 34° 17' E., with no land seen. Biscoe (1831) discovered Adelaide and other islands, 67° S., 71° W., fronting Western Palmer Land, and gave to the mainland the name Graham Land. Larsen (1893) extended the east coast some 300 miles, to 68° 10' S., finding also two snow-free islands capped by active volcanoes. The Belgian De Gerlache (1897-99) discovered Belgica Strait, west of Palmer Land, explored adjacent regions, and determined the non-existence of the reported land of Walker and Cook 150° E. He also located a submarine and continental plateau, 75° to 103° W., 70° to 71.5° S., and attained 71° 36' S., 87° 39' W., with no land in sight. O. Nordenskiöld (1902) began a series of explorations east of Palmer Land.

KERGUELEN ISLAND. In a hazardous voyage J. Biscoe (1831) skirted one-third of the Antarctic Circle, and south of Kerguelen discovered Enderby Land, 47° S., 66° E. Others have here entered the circle, without seeing land: Bellingshausen 20° and 40° W. and Nares in the *Challenger* (1874) 68° 40' S., 78° E. The Germans under Dr. Drygalski in the *Gauss* set out from Kerguelen Island on January 31, 1902, and were frozen in the ice for nearly a year in 66° 30' S., 90° E. They proved the non-existence of Termination Land and discovered a new land, to which they gave the name of Kaiser Wilhelm Land. Its extent was not learned.

TASMANIA. The most important discoveries have been accomplished by this route. The first visitors were Cook (1773), who reached 67° 31' S., 142° 54' W., and Bellingshausen (1820), who reached 67° S., 170° W., neither seeing land. Balleny (1839) first discovered land, the Balleny Islands, 67° S., 163° E., and Sabrina Land, 66° S., 120° E., and attained at sea 69° S., 172° E. In 1839 C. Wilkes discovered land at six different points between 65° 20' and 66° 20' S., and 106° to 154° E., 75 miles of mountain ranges being in sight at once, all faced by an ice-barrier. Whether these are separate islands or the continent of Antarctica has been hotly argued. D'Urville, was sighted two of Wilkes's lands also, discovered, in 1840, Adélie Island, 67° S., 140° W.

In 1841 J. C. Ross discovered Victoria Land and traced its east coast to 77° S., a mountainous, ice-capped region, with two great volcanoes, Erebus and Terror, of which the first is active. Ross thence followed east (1843) for 300 miles an unbroken ice-barrier, about 200 feet high, to 78° 10' S., 161° 27' W., then the farthest south. In 1899 Borchgrevink wintered at Cape Adare, 71° 18' S., 170° E., and explored the adjacent ice-clad regions, finding five kinds of lichens and a few insects. His magnetic observations place the south magnetic pole in about 73° 20' S., 146° E., a displacement of over six degrees of longitude from the determination of J. C. Ross (1842), 72° 35' S., 152° 30' E. Borchgrevink also followed the ice-barrier, which had apparently receded some 40 miles in 60 years, and ascending it at 78° 34' S., attained on the ice 78° 50' S., 165° W. An English expedition under Scott spent the winter of 1902 in Victoria Land, and in the succeeding summer (January, 1903) the commander, with two members of his party, by a sledge journey, reached the latitude of 82° 17' S., 163° E., on the coast of Victoria

Land. Another expedition under Armitage penetrated the interior of Victoria Land, found the ice-cap thousands of feet in thickness, and attained to 77° 21' S. and 157° E.

BIBLIOGRAPHY. Arctic: Rundall, *Voyages Towards the North West, 1496-1631* (1859); Scoresby, *An Account of the Arctic Regions and of the Whale Fishery* (2 vols., Edinburgh, 1820); Parry, *Narrative of an Attempt to reach the North Pole, 1827* (London, 1828); Franklin, *Journey to the Shores of the Polar Ocean* (London, 1824); McClintock, *A Narrative of the Discovery of the Fate of Sir John Franklin* (London, 1859; 5th ed. 1881); Gilder, *Schwechat's Search for the Franklin Record* (New York, 1880); Richardson, *The Polar Regions* (Edinburgh, 1861); A. H. Markham, *The Great Frozen Sea* (London, 1878); Nares, *Narrative of a Voyage to the Polar Sea, 1875-76* (London, 1878); Reports on the six voyages of the *Willem Barents* in 1878-83 (Amsterdam and Haarlem, 1879-87); *Meddelelser om Grönland*, by various authors (16 vols., Copenhagen, 1879-95); *Manual of the Natural History, Geology, and Physics of Greenland and the Neighboring Regions*, published by the British Admiralty (London, 1875); *International Polar Scientific Publications*, 31 vols.; Heer, *Flora Fossilica Arctica* (7 vols., Zurich, 1868-80); *Flora Fossilica Gronlandia* (2 vols., ib., 1882-83); *Arctic Geography and Ethnology*, published by the Royal Geographical Society (London, 1875); Greely, *Three Years of Arctic Service* (2 vols., New York, 1886) and *Handbook of Arctic Discoveries* (Boston, 1896); Payer, *New Land Within the Arctic Circle* (2 vols., London, 1876); Nordenskiöld, *The Voyage of the Vega* (ib., 1881); De Long, *The Voyage of the Jeannette* (2 vols., ib., 1883); C. Ryder, *Isfornholdene i Nordhavet 1877-1892* (Copenhagen, 1896); Nansen, *Farthest North* (2 vols., London, 1897); Peary, *Northward Over the Great Ice* (2 vols., New York, 1898); Duke of the Abruzzi, *On the Polar Star in the Arctic Sea* (2 vols., ib., 1903).

Antarctic: Wilkes, *Narrative of the United States Exploring Expedition*, in 1838-42 (Philadelphia, 1845); D. Urville, *Voyage au Pôle Sud et dans l'Océanie* (Paris, 1845-47); Ross, *Voyage of Discovery and Research in the Southern and Antarctic Regions*, in 1839-43 (London, 1847); Rainaud, *Le Continent Austral, Hypothèses et Découvertes* (Paris, 1893); Murdoch, *From Edinburgh to the Antarctic*, in 1892-93 (London, 1894); Bull, *The Cruise of the Antarctic to the South Polar Regions*, in 1894-95 (London, 1896); Fricker, *Antarktis* (Berlin, 1898), translated as *The Antarctic Regions* (London, 1900); Cook, *Through the First Antarctic Night*, in 1898-99 (New York, 1900); Bernacchi, *To the South Polar Regions* (London, 1901); *The Antarctic Manual*, published by the Royal Geographical Society (London, 1901); Chun, *Aus den Tiefen des Weltmeeres* (Jena, 1900); Borchgrevink, *First on the Antarctic Continent* (London, 1901); Neumayer, *Auf zum Südpol* (Berlin, 1901); Gerlache, *Quinze mois dans l'antarctique* (Paris, 1902); Balch, *Antarctica* (Philadelphia, 1902).

POLAR WHALE. The Greenland or 'right' whale. See WHALE.

POL DE MONT, pôl de mônt (properly KAREL MARIE POLYDOOR DE MONT) (1857-). A Flemish poet and critic, born at Wambeke, Brabant. He was educated at the Mechlin Seminary, and

afterwards at the University of Louvain, and became professor of the Dutch language and literature in the Athenæum at Tournai, and (1882) at Antwerp. His chief works are: *Waarheid en Leven* (1877), *Jongelingsleven* (1878), *De eerste mensch* (1879), *Lentesotternijen* (1881), *Loreley* (1882), *Fladderende Vlinders* (1885), *Zanna* (1886), a comedy in verse, *Claribella* (1893), and *Iris* (1894), besides biographies of Hendrik Conscience (1883) and of Jan van Beers (1886).

POLDER, pól'dēr (Dutch, morass). A name given in the Netherlands to that portion of dry land which was formerly below the level of the sea or the nearest river, and has been reclaimed by building a dike, called a ringvaart, around the region to be drained and brought under cultivation. On such an embankment machinery for lifting water is placed and worked by wind or steam power. Successive embankments and canals are built as the work proceeds. In North Holland in the Schermer polder four such embankments and intermediate canals were necessary in order to reclaim the lowest part of the polder. A large portion of the cultivated land of the Netherlands has thus been reclaimed from the ocean. The largest of the finished polders is that which occupies the former site of the Haarlem Lake and covers about fifty thousand acres, or about eighty square miles. At the present time still larger polders are in the course of being drained.

POLE. In geography, one of the two extremities of the axis round which the earth revolves. They are therefore situated the one on the north and the other on the south side of the equator, and equidistant from all parts of it, or in latitude 90° north and latitude 90° south, respectively. They are called the North and South poles of the earth. In astronomy, the poles, which, for distinction's sake, are denominated *celestial* poles, are those points in the heavens to which the earth's axis is directed, and round which the heavens seem to revolve. The celestial poles are valuable points of reference to astronomers and geographers, so that the determination of their position in the heavens is a matter of the greatest importance. Unfortunately, no stars mark their exact situation (see **POLE STAR**), though there are minute telescopic stars only a few seconds from the North Pole. The position of the polar point is determined in the following manner: A bright star (generally the Pole star) is selected, and its position in its upper and its lower culminations (q.v.) is accurately noted, with the meridian circle (q.v.); the point midway between these two positions of the star is the pole of the heavens. The observation of the two positions of the star must be corrected for refraction, and it is for this reason that the Pole star is selected, since the effect of refraction is much the same in both positions of the star. The term 'pole' has, however, a wider application in astronomy, as in spherical geometry, denoting the extremities of a line passing through the centre of a great circle perpendicular to its plane; thus, we have the poles of the horizon (zenith and nadir), the poles of the ecliptic, the poles of a meridian. Pole in physics denotes those points of a body at which its attractive or repulsive energy is concentrated. See **TERRESTRIAL MAGNETISM**.

POLE (of a magnet). See **MAGNETISM**.

POLE, REGINALD (1500-58). The last Roman Catholic Archbishop of Canterbury. He was born at Stourton Castle, Staffordshire, in March, 1500, the son of Sir Richard Pole, by Margaret, Countess of Salisbury, daughter of the Duke of Clarence, the brother of Edward IV. His early education was received from the Carthusians at Sheen, whence, being liberally provided for by Henry VIII., he passed to Magdalen College, Oxford, and, although still a layman, received several valuable preferments through the favor of the King. For the further prosecution of his studies he went, in 1521, to the University of Paris, and thence to Padua, where he formed the friendship of a distinguished group of scholars and friends, all of whom subsequently took a leading part in public affairs—Contarini, Bembo, Sadoleto, and others. In 1527 he returned to England, where the highest ecclesiastical dignities awaited his acceptance. In 1529-30 he was in Paris, where he collected opinions favorable to Henry VIII.'s divorce from Catharine of Aragon, but on his return he courageously endeavored to dissuade the King. In 1532 Pole was again on the Continent, whence he issued his *Pro Ecclesiasticæ Unitatis Defensione* (1536), taking strong grounds against the divorce. At the end of 1536 he went to Rome, where he was ordained deacon and made a cardinal. In February, 1537, he was appointed Papal legate to England, but his commission was not then discharged. His position had greatly enraged Henry, whose resentment fell upon his elder brother, and upon his aged mother, the Countess of Salisbury. During the rest of Henry's reign Pole remained in exile. The Papacy, for the maintenance of whose authority in the cause of the injured Catharine Pole was regarded as a martyr, treated him with distinguished favor. He was employed in many affairs of the highest importance, being sent as legate, in 1537, to France and the Low Countries, from both which States Henry VIII. in vain demanded his extradition. He also took an active part in the discussion on the Interim, and when the Council of Trent was opened, he was appointed one of the three legate-presidents who acted in the name of the Pope, Paul III. On this pontiff's death in 1549, Pole was all but elected to succeed. For some time after this he resided chiefly in a monastery, near Verona, in comparative retirement, until the accession of Mary called him back to active life, as the main instrument of the reconciliation of England with the Papacy. On November 24, 1554, Pole solemnly entered London as legate, possessing in equal degree the confidence of the Queen. In the arduous charge thus intrusted to him he acquitted himself with much prudence, and, considering the circumstances of the time, with singular moderation. In the severities which marked the later history of Mary's reign it is all but certain that Pole had no share. He was ordained priest March 20, 1557, and consecrated Archbishop of Canterbury two days after, and later made chancellor of the universities of Oxford and Cambridge. On the difficult and critical question of the disposal of the Church property confiscated by Henry VIII., Pole, who saw the necessity of moderation, was for a time at issue with the Pope; but his representations were successful in producing a more moderate policy, and the work of reunion appeared to proceed with every prospect of a complete and permanent issue, when it

was interrupted by the death of the Queen, November 17, 1558. Pole died within twelve hours afterwards. Besides the treatise *De Unitate*, already mentioned, he is also the author of a book *De Concilio*, and of other treatises on the authority of the Roman pontiff and the reformation of England, and of many important letters, full of interest for the history of the time. Consult his *Life* by A. Zimmermann (Regensburg, 1893); also a study of the first and last parts of his life by F. G. Lee (London, 1887).

POLE, WILLIAM (1814-1900). An English engineer, musician, and writer on whist. He was born at Birmingham, studied engineering there, became professor of engineering at Elphinston College, Bombay (1844), and in 1850 was employed in calculations for the Menai Bridge. After acting as assistant to James Meadows Rendel and to Sir John Fowler, he entered business independently in 1858, and in 1871 was made consulting engineer of the Japanese Government. He was a prominent musician, being musical examiner in London University from 1878 to 1891, and as an authority on whist ranks with Henry Jones. Pole's works are: *On the Strength and Defects of Beams* (1850); *Iron as a Material of Construction* (1872); *Life of Siemens* (1888); *The Theory of the Modern Scientific Game of Whist* (1865, and often); *The Philosophy of Whist* (1883 and often); *The Evolution of Whist* (1895); *The Philosophy of Music* (1877; 4th ed., 1895), and *Mozart's Requiem* (1879).

POLE, WILLIAM, JR. (1852—). An English playwright, born in London. Turning his attention to the stage in 1876, he became manager of Royal Victoria Hall, London (1881-83), and stage manager of F. R. Benson's company (1883-84). In 1895 he founded the Elizabethan Stage Society, a natural outcome of his endeavors to revive interest in the Elizabethan stage and drama. Under his management have been produced *Hamlet*, without scenery (Saint George's Hall, 1881); Webster's *Duchess of Malfi* (Independent Theatre, 1892); *Measure for Measure* (Royalty Theatre, 1893); Marlowe's *Dr. Faustus*; *Arden of Feversham*; Ford's *Broken Heart*; Ben Jonson's *Sad Shepherd* and *Alchemist*; Milton's *Samson Agonistes*; Fitzgerald's translation of Calderon's *Life's a Dream*; Kālidāsa's *Sakuntalā*; Coleridge's translation of Schiller's *Wallenstein*; and other old plays. In 1884 he dramatized Howell's *A Forgone Conclusion* for the Olympic Theatre; and in 1886, Barling-Gould's *Mehalah* for the Gaiety Theatre.

POLE AND POLAR. The secant drawn through the points of contact of two intersecting tangents to a conic is called the *polar* of the point of intersection with respect to the conic, and the point is called the *pole* of the secant. Any secant of a conic through a given point *O* is cut harmonically by the curve and the polar of *O*. Two points are said to be conjugate with respect to a conic when each lies on the polar of the other. Two straight lines are said to be conjugate with respect to a conic when each passes through the pole of the other. Thus conjugate diameters are conjugate lines through the centre. When the pole is inside the conic, the tangents are imaginary, and the polar line fails to cut the conic in real points. In this case the locus of the harmonic conjugate of the pole serves as a more suggestive definition

of the polar. If the pole is on the conic, the polar becomes a tangent at the pole. The polar of the focus is the directrix in the ellipse, hyperbola, and parabola (q.v.). A few of the relations which give remarkable power to the theory of polars in the domain of geometry are: (1) The polars of collinear points with respect to a conic are a pencil of lines passing through the pole of the line, and conversely. (2) If the vertices of a triangle are the poles of the sides of another triangle, the vertices of the latter are the poles of the sides of the former. Such triangles are said to be conjugate to each other with respect to the conic. (3) If the sides of a triangle are the polars of its own vertices, the triangle is called a self-conjugate triangle. (4) The poles and polars of the lines and points of rectilinear plane figures with respect to a co-planar conic form a rectilinear figure called the polar reciprocal of the given figure with respect to the auxiliary conic. The method of *reciprocal polars* obtains from any given theorem concerning the positions of points and lines another theorem in which straight lines take the place of points, and points of straight lines. (See DUALITY.) Thus a line joining two points in one figure corresponds to a point determined by two intersecting lines in the reciprocal figure. Since the pole of any line through the centre of the auxiliary conic is at infinity, the points at infinity on the reciprocal curve correspond to the tangents to the original curve from the centre of the auxiliary conic. Hence the reciprocal of a conic is an hyperbola, parabola, or ellipse, according as the tangents to it through the centre of the auxiliary conic are real, coincident, or imaginary. Pascal's and Brianchon's theorems are reciprocals. (See CONCURRENCE and COLLINEARITY.) Conjugate lines or conjugate points project into conjugate lines or points (see PROJECTION), hence the relations of pole and polar are unaltered by projection.

The relations between pole and polar were known to the ancients, but Desargues (1639) was the first to develop the theory. To Servois (1810) is due the name *pole* (in this sense) and to Gergonne (1812) the name *polar*. Steiner (1848) also treated the subject exhaustively. Hesse (1837, 1842) introduced the notion of polar triangles, polar tetrahedra, and systems of conjugate points as the geometric expressions of analytic relations.

The terms 'pole' and 'polar' have other meanings in mathematics than those already mentioned. The centre from which radii vectors are drawn in a system of polar coordinates (see COÖRDINATES) is called the pole. The extremities of the diameter of a sphere, perpendicular to one of its circles, are called poles of the circle. If the sides of a spherical triangle are arcs of circles, whose poles are the vertices of another triangle, the latter is called the polar triangle of the first. It is shown in geometry that if one triangle is the polar of another, the second is a polar of the first. For the bibliography of the subject of polars of various orders, consult Joachimsthal in the *Nouvelles Annales de Mathématiques* (1850); *Intermédiaire des Mathématiciens* (1896). For the theory of the subject, consult Reye, *Geometrie der Lage* (Leipzig, 2d ed., 1882-86; English ed., New York, 1898); Salmon, *Higher Plane Curves* (Dublin, 1852).

POLEBURN. A disease of tobacco (q.v.).

POLECAT (probably from Fr. *poule*, hen + Eng. *cat*; hardly from *Pole* + *cat*, or from OF. *pulent*, stinking + Eng. *cat*), or **FITCHET**. The largest of European martens (*Putorius fœtidus*), the length of the head and body being about eighteen inches, the length of the tail more than five inches, and the form stouter than that of the weasel. Its color is a deep blackish brown; the head, tail, and feet almost black, the under parts yellowish, the ears edged with white, and a whitish space around the muzzle. The hair is of two kinds—a short, woolly fur, which is pale yellow, or somewhat tawny; and long shining, darker hairs. (See Plate of FUR-BEARING ANIMALS.) There is a pouch or follicle under the tail, which exudes a yellowish, creamish substance with a fetid odor; and this odor is particularly strong when the animal is irritated or alarmed. Hence its name *foumart* (foul marten), which, with various provincial modifications, is prevalent in most parts of Great Britain.

The polecat was much more common in Great Britain in former times than now, and is almost extirpated from some districts, through the constant war waged against it. It eats everything that the game-keeper wishes to preserve and is extremely destructive in the poultry-yard. The ferret, however, is only a semi-domesticated race of this species, its natural energies controlled for the pursuit of vermin. The skin is used as a fur under the name of *fitch*, and is similar but inferior to that of the marten. The long hairs, pulled out by the furrier, are utilized for making artists' brushes.

The 'polecat' of North America is the skunk, and that of South Africa is a badger (qq.v.).

POLE FLOUNDER. An elongated species of flounder (q.v.), called in Great Britain 'eraig fluke,' which is found in rather deep water on both coasts of the Atlantic as far south as France and Cape Cod. It is occasionally taken in great numbers in beam-trawls off the coast of New England, and is highly valued as delicate food, perhaps equal to the sole. Its Linnæan name is *Glyptocephalus cynoglossus*. A nearly related species on the Pacific coast is small, thin, and unappetizing.

POLEMON (Lat., from Gk. *Πολέμων*). A Greek geographer of the second century B.C., surnamed the Periegete. He was born in the district of Troas, but afterwards removed to Athens, where he obtained the citizenship about B.C. 200. After traveling through Greece, he wrote several geographical works, which were almost the first to contain special references to inscriptions, dedications, famous paintings, and public monuments of all kinds. His works are frequently quoted by later writers, including Athenæus and Pausanias. The few extant fragments have been collected by Müller, in his *Fragmenta Historicorum Græcorum* (Paris, 1841), and by Preller (Leipzig, 1838).

POLEMONIA'CEÆ (Neo-Lat. nom. pl., from Gk. *πολεμώνιον*, *polemōnion*, a plant, probably valerian, or perhaps named in honor of the Athenian philosopher Polemon, or of a king of Pontus of the same name; popularly derived from *πόλεμος*, *polemos*, war, being alleged to have been the cause of war between two kings). **THE POLEMONIUM FAMILY.** A natural order of 8 genera and about 200 species, mostly herbs, natives of temperate countries and

particularly abundant in Western North America, a few occurring in Europe, Asia and South America. Some of the species are favorite garden flowers, as *Polemonium æruleum*, *Cobæa scandens*, and species of *Phlox*, *Gilia*, etc. *Polemonium æruleum*, Jacob's ladder or Greek valerian, is abundant in the Western mountains of the United States and far north. It has a stem from one to two feet high, pinnate leaves, and a panicle of blue (or white) flowers. The chief genera are *Phlox*, *Gilia*, *Cobæa*, *Polemonium*, and *Collomia*.

POLESIAN. A brachycephalic people between White and Little Russia, bounded on the north by Grodno and Minsk, on the south by Volhynia, and on the west by Poland. They are isolated in the marshes of Pinsk and along the swamps of the Pripet River and have a cephalic index of 85. The Polesians are supposed to have an infusion of Polish blood, which accounts for their broad heads. Consult Rittich, *Die Hauptstämme der Russen*, quoted by Ripley, *The Races of Europe* (New York, 1899).

POLE STAR, or **POLARIS.** The nearest conspicuous star to the north pole of the heavens. The second-magnitude star which at the present time goes under the name of Pole star is the star *a* in the constellation of Ursa Minor. By examining attentively the movements of the stars throughout a clear night, we observe that they describe circles which are largest for stars near the celestial equator, and become smaller and smaller as we approach a certain point (the north pole), close to which is the star above mentioned. The Pole star is, however, a little less than $1\frac{1}{2}^\circ$ from the pole, and has a small but sensible motion around it. (See **POLE**.) Owing to the motion of the pole of the heavens around the pole of the ecliptic (see **PRECESSION**), this star will in course of time (about 2100) approach to within 28' from the north pole, and will then recede from it. At the time of Hipparchus (B.C. 156) it was 12° , and in 1785 2° from the north pole. Its place can easily be found in the heavens, for a line drawn between the stars *a* and *β* (called the two pointers, from this peculiarity) of the constellation Ursa Major or the Great Bear, and produced northward for about $4\frac{1}{2}$ times its own length will almost touch the Pole star. Two thousand years ago the star *β* of Ursa Minor was the Pole star; and about 2300 years before the Christian Era the star *a* in the constellation of the Dragon was not more than 10' from the north pole; while about 12,000 years from now the bright star Vega in Lyra will be within 5° of it.

The south pole of the heavens is not similarly marked by the neighborhood of a bright star, though there is a small telescopic star very close to it.

POLE VAULTING. See **FIELD SPORTS**, and **Plate of ATHLETICS**.

POLICE (from Lat. *politia*, from Gk. *πολιτεία*, *politeia*, state, government, citizenship, from *πολίτης*, *politēs*, citizen, from *πόλις*, *polis*, city). In its broader significance, the whole internal administration of a State less the judicial power. In a more restricted sense the term police denotes that sphere of governmental activity which has to do with the maintenance of the public peace, order, and security, and the protection of the public health and morals. (See **POLICE POWER**.) In this article the use of the term is still further

restricted to that part of the State administration which is concerned primarily with the preservation of the peace and the prevention and detection of crime in urban communities. The first instance of the separation of the police magistracy from the judicial magistracy seems to have occurred in France in the fourteenth century. About the same time a military police was organized which eventually became the basis of the present French *gendarmerie*. In Paris a systematic police force soon came to be organized and before the close of the eighteenth century consisted of between seven and eight hundred men. In England the police administration was in the hands of the justices of the peace, who had under their control a small number of parish constables. Several attempts in the course of the eighteenth century were made to improve the system of London police, but it was not until 1828 that the passage of the celebrated Peel Act established a constabulary force for the city under commissioners appointed by the Crown. This has been described as the first modern police force in the world. The act provided for a thoroughly organized and disciplined corps of trained men, a regular day and night patrol, and a force of reserves to be stationed at police headquarters. Although bitterly attacked at the time, the Peel system in its main features was adopted in other cities in England. In New York City, in 1841, the police force consisted of two constables in each of the 17 wards, 100 marshals, 300 night watchmen, and 100 wardens, bell-ringers, inspectors, and so on. At the same time Boston had 22 day policemen and 200 night watchmen; Philadelphia had 24 day patrolmen and 120 night watchmen. During the first half of the century the control of the police was everywhere in the hands of the local authorities, but beginning with the year 1857 State boards of police commissioners were created for the management of the police in several of the larger cities. In 1900 the police of Baltimore, Saint Louis, Boston, and Cincinnati were still under the management of State Boards, but nearly everywhere else the old method of local control had been reestablished.

In 1854 the police system of Paris was reorganized on the lines of the English system, and other Continental cities have followed. In the metropolitan district of London this force numbers 15,000 men; in Paris, 8000; in New York, 7000; in Berlin, 4500; in Vienna, 3500; in Chicago, 3000; and in Philadelphia, 2400. The number of policemen to every 10,000 of population is 20 in New York, 24 in London, 25 in Berlin, and 30 in Paris. The total annual expenditures for police purposes amount to more than eight million dollars in London, more than eleven million in New York, more than eight million in Paris, more than three million in Berlin, and about four million in Chicago.

The system of organization of the police force varies widely with different cities. The supreme authority is usually either a single superintendent or a board. In Continental Europe the single-headed authority is most common, the *maire* or the *burgomaster* being commonly vested with the immediate control of police affairs. In the United States the same system prevails in most of the smaller cities and in many of the larger ones. In Great Britain the statutes usually require that such boards shall be bi-partisan, chiefly on account of the control which the police exercise

over the machinery of elections. The Superintendent, Commissioner, or Chief, whatever title he may bear, is the executive head of the police administration, and in general is responsible for the character of the police service. For the purposes of police administration a city is usually divided into a number of police districts or precincts. Each precinct has a detachment of police at the head of which is a captain, who is responsible for the execution of the orders of the chief, and who in turn may issue instructions to those under his command. In the larger cities officers intermediate between captains and superintendents, called inspectors, are frequently provided, and these have control of a certain number of precincts. Next below the captains in the organization are the lieutenants, or, more frequently, the sergeants. Below the sergeants are the 'roundsmen,' who are charged with the duty of seeing that the patrolmen perform their duties. The lowest officer of the police force is the patrolman, whose general duty it is to patrol a given district of territory. In addition to the patrolmen on active duty a number of reserves are usually kept at each station for use in case of emergency. Frequently, as in the public parks and in parts of the city where the posts are unusually long, mounted police are provided, and in the principal ports, as in the case of New York City, there are special harbor police. A frequent and important branch of the police service is the detective bureau, consisting of a force of men employed for their shrewdness and ability to detect crime as well as their knowledge of noted criminals. Unlike the regular patrolmen, they do not wear uniforms. Occasionally, as in the city of New York, there are also special detachments of sanitary police and bicycle squads.

From the standpoint of the relation of the police to the central Government considerable variety in principle is to be seen. Thus in Ireland, Egypt, India, and Australia the police is subject to the strict control of the central Government. In Ireland the police force is the Irish constabulary, organized in 1836, consisting of military forces under the immediate control of the central Government at Dublin. In Russia the system is thoroughly centralized. Elsewhere in Continental Europe the police administration is either directly or indirectly under central control. It is a general practice in Europe for the central Government to defray a part of the cost of administering the police. In Berlin the amount granted by the central Government is four-fifths of the cost; in London and Paris, one-third. The borough and county police of England receive a Parliamentary grant, amounting to one-half of the cost of maintenance, provided a given standard of efficiency is maintained. In American cities the entire cost of its police is defrayed by the municipal Government.

In most of the European countries a State police is maintained and is under the immediate control of the central Government. It is generally modeled after the French *gendarmerie*, which is a part of the Regular Army. In Russia the secret police is largely concerned with the suppression of political agitation. Although locally selected, police officers in the United States are regarded by the courts as State agents and not agents of the municipalities, and the municipalities cannot be held liable for the tortious acts of its police officers.

BIBLIOGRAPHY. Fairlie, *Municipal Administration* (New York, 1901); Castello, *The New York Police*; Sprogle, *The Philadelphia Police*; Savage, *The Boston Watch and Police*; Brayer, *Police administrative et judiciaire* (1894).

POLICE, MILITARY. See **MILITARY POLICE.**

POLICE MAGISTRATE. See **MAGISTRATE.**

POLICE MATRONS. Women who are placed in charge of women and children in police stations, jails, and other places where they are detained. Elizabeth Fry (q.v.) first called attention to the deplorable condition of women in prisons and insisted upon the principle that none but women should be employed in the superintendence of women. The Society for the Improvement of Prison Discipline demanded police matrons in 1823, and the National Prison Congress cited their appointment as a requirement of prison reform in 1886. The impropriety of allowing men to search women and to care for their physical wants has only recently been recognized in the United States. The reform has been instituted entirely by women—usually Woman's Christian Temperance Union workers. In Portland and Indianapolis associations of women provided for police matrons at their own expense before the position was established by law. Portland (Maine) first established the position of police matron in 1876. Chicago, Baltimore, Cincinnati, and Philadelphia employed them at a later date. Among the States where they are required by law for the larger cities are Colorado, Pennsylvania, Massachusetts, Connecticut, Rhode Island, Nebraska, Ohio, Iowa, Indiana, Michigan, Arkansas, Illinois, and California. The movement has made marked advance since 1890. Consult *Reports of National Conferences of Charities and Corrections*; *Lend a Hand*, ii., 471; iii., 61; iv., 126; ix., 180.

POLICE POWER. The inherent power of a government to take such action and to pass such laws as may be deemed necessary for its own protection, and to secure the safety, comfort, and general welfare of its citizens. It is very difficult to define the precise limits of the police power of a government, and probably there are no absolute limits, except that it shall only be exercised for the purposes above mentioned, and such restrictions as may be imposed by a written or unwritten constitution. Chief Justice Shaw of Massachusetts expressed this difficulty as follows: "It is much easier to perceive and realize the existence and sources of this power than to mark its boundaries or prescribe limits to its exercise." The same jurist defined it as "the power vested in the Legislature by the Constitution to make, ordain, and establish all manner of wholesome and reasonable laws, statutes, and ordinances, either with penalties or without, not repugnant to the Constitution, as they shall judge to be for the good and welfare of the commonwealth and of the subjects of the same." While governments have always assumed to exercise the powers above mentioned, the law and theory of the police power as a justification and authority for otherwise arbitrary and despotic acts have been a growth of the nineteenth century. In some respects the police power is more arbitrary than that of eminent domain. By virtue of the latter a government may take private property only upon making proper compensation therefor, whereas if property is confiscated or

destroyed for the public good under the police power no reimbursement need be made to the owner.

The Constitution of the United States enumerates the powers of the Federal Government, which also possesses incidental power to do all acts necessary to exercise the authority thus vested in it, and this may be said to be its police power. An example of this are the United States quarantine regulations, which, in so far as they are inconsistent with the State laws on the subject, supersede the latter. However, the great bulk of the police power vested in the States is independent of the United States Government, and cannot be interfered with by Congress. One notable instance where the Federal law has superseded State regulations under their police power was where the United States courts sustained the right of dealers to import liquors and sell them in a State where the laws prohibited traffic in liquor. The United States Supreme Court held that this interfered with interstate commerce, but expressly stated that the liquor was only protected as long as it was contained in the 'original package' (q.v.) in which it was imported, thus recognizing the right of the State to regulate the liquor traffic *within* its own boundaries under its police power. Among the numerous laws and regulations of the various States which have been held to be legitimate exercises of the police power are: Acts requiring railways to fence in their tracks; requiring sign-boards at crossings; regulating the speed of trains; regulating the charges of persons in quasi-public occupations, as warehousemen, cab drivers, ferry owners, etc.; regulating the storage of explosives, the sale of poisons, and of liquor; prohibiting the adulteration of foods; regulating the employment of women and children; requiring the quarantine of infectious diseases, and destruction of infected houses and property; and the licensing of physicians, druggists, engineers, etc. Laws prohibiting labor and enforcing quiet on Sunday have been held not to encroach on the religious liberty of individuals, but to be a valid exercise of the police power for the general welfare of the community. The subject of police powers is discussed in: Cooley, *Constitutional Limitations*; Thayer, *Constitutional Limitations*; Tiedeman, *Limitation of the Police Power in the United States*; Prentice, *Police Power*. See also **CONSTITUTIONAL LAW** and the authorities there referred to.

POLICY (Fr. *police*, It. *polizza*, from ML. *politicum*, *polctum*, *poleticum*, *polyptycum*, register, from Gk. *πολύπτυχον*, neu. sg. of *πολύπτυχος*, *polyptychos*, having many folds or leaves, from *πολις*, *polys*, much, many + *πίξ*, *ptyx*, fold, leaf, from *πίσσειν*, *ptyssein*, to fold). A method of gambling, resembling the ordinary lottery in that slips, on which are printed numbers and usually some name or device for identification, are given out to the players, and corresponding numbers on slips are intermingled in some receptacle and drawn out by a blindfolded person. The players usually make bets upon the order in which numbers in a certain sequence will appear. Although the odds given the players are very alluring, the chances of winning are actually very much against them. Usually very small bets will be received, and for this reason it is quite popular among the poorer classes, especially in great

cities. Gambling in this form is prohibited in nearly all of the United States, either under the specific name of policy, or under the more general term of lottery. The United States postal laws prohibit the mailing of advertisements or tickets of policy shops, and for this reason most establishments of this sort operate in a limited locality and with some attempts at secrecy. See **GAMBLING; LOTTERY.**

The written contract by which a person undertakes to insure another against the happening of any event, or to pay him a certain sum upon a certain contingency, is called a policy. The policy is frequently designated by some qualifying word, as 'tontine,' 'endowment,' or the like, according to the nature of the insurance undertaken. See **INSURANCE.**

POLIDORO (CALDARA) DA CARAVAGGIO, pól'le-dó'ró dá ká'rá-vá'jò (c.1495-1543). An Italian painter and decorator of the Higher Renaissance. His real name was Caldara. He was born at Caravaggio, near Milan, and coming to Rome as a youth, he obtained employment as a mason upon the Vatican constructions in progress, under the direction of Raphael. He was instructed in painting by Maturino, a Florentine, with whom he afterwards formed a partnership. The two together executed a great number of decorations in *sgraffito* (q.v.), the subjects of which were generally of a historical or mythological character and were remarkable for the acuracy of the archaeological detail, and the effectiveness of their plastic handling. These decorations, both in the Loggie of the Vatican and upon the façades of Roman palaces, have mostly perished, but they are well known from engravings. The sack of Rome in 1527 and the death of Maturino drove Polidoro to Naples, where he developed a powerful realistic style, which exercised great influence upon the character of the Neapolitan school. The picture most typical of this last phase of his art is "Christ Bearing the Cross" (1534), in the Museum of Naples. Dissatisfied with Naples, he afterwards went to Sicily, and, settling in Messina, he acquired position and wealth, but was assassinated there in 1543. Consult Bertolotti, *Artisti lombardi a Roma* (Milan, 1881).

POLIESSIE. A marshy region in the west of Russia, comprising the larger part of the Government of Minsk, the northern part of Volhynia, the eastern part of Grodno, as well as portions of the governments of Mohilev and Kiev. It is thickly wooded and noted for its unhealthy climate. The *plica polonica* is very common. A considerable area has been drained by the Government since 1873 and the reclaimed regions yield good crops of hay.

POLIGNAC, pól'le'nyák'. An ancient French family, several of whose members played a prominent part at court after the time of Louis XIV. MELCHIOR DE POLIGNAC (1661-1742) was born at Puy-en-Velay, in the Department of Haute-Loire. He was destined by his parents for an ecclesiastical career, and received an excellent education. In 1693 he was sent to Poland as ambassador, and intrigued so successfully in favor of the Prince de Conti that the latter was actually elected John Sobieski's successor in 1697. Augustus the Strong, however, proved the successful aspirant to the throne, and both Conti and Polignac had to leave Poland, in consequence

of which the latter retired to his abbey at Bonport. In 1702 he was recalled to Versailles, and rose higher than ever in the royal favor. In 1712 he was appointed French plenipotentiary at the Congress of Utrecht, and after his return obtained the abbeys of Corbie and Anchin. During the Regency Polignac took part in the conspiracy of Cellamare, and was banished to his abbey of Anchin. In 1725 he was sent to Rome, charged with the conduct of French affairs, and signalized his mission by healing the quarrel that was dividing the Gallican Church on the subject of the famous bull *Unigenitus*. (See **JANSENISM.**) In 1725 he was raised to the Archbishopric of Auch, and on his return to France spent the remainder of his days in retirement. Polignac succeeded Bossuet at the Académie Française in 1704, and was also a member of the Académie des Sciences and of the Académie des Belles-Lettres. For his life see the *Memoirs* of the time, notably those of Saint Simon and D'Argenson.

The other members of the Polignac family who deserve mention are connected with the last phases of the Bourbon monarchy in France. In the reign of Louis XVI., Yolande Martine Gabrielle de Polastron, Duchess de Polignac (1749-93), and her husband, Jules, Duke de Polignac (died 1817), were among the most intimate and favored advisers of Marie Antoinette. They obtained vast sums of the public money from their connection with the Court, and were largely if not mainly responsible for the extravagance which marked the eve of the Revolution. The Polignacs—knowing the deep hatred felt toward them by the French people—were the first of the *noblesse* to emigrate (July 16, 1789). From the Empress Catharine II. of Russia, the Duke received an estate in the Ukraine, and did not return to France at the Restoration. He left three sons, of whom only one deserves notice—JULES AUGUSTE ARMAND MARIE, Prince de Polignac, born at Versailles, May 14, 1780. In 1804 he entered with his brother into a conspiracy against Napoleon, and both were imprisoned, but they escaped when the Allies entered France, in 1814. After his return to Paris Polignac became intimate with the Count of Artois, afterwards Charles X., showed an ardent attachment to the Roman Catholic Church, and, in consequence, received from the Pope, in 1820, the title of a Roman prince. He was appointed ambassador at the English Court in 1823; and finally, in 1829, became head of the last Bourbon Ministry, in which capacity he promulgated the fatal ordinances of July, 1830, that called France to arms, and drove Charles X. from the throne. (See **JULY REVOLUTION.**) He then attempted to flee from the country, but was captured at Granville, tried, and condemned to imprisonment for life in the Castle of Ham, but was afterwards set at liberty by the amnesty of November 29, 1836. He took up his residence in England. He died at Saint-Germain, March 2, 1847.

POLILLO, pól'le'yó. A group of islands in the Philippine Islands, lying about 30 miles east of the Province of Infanta, Luzon, and connected for administrative purposes with the Province of Tayabas. The area of the group is 405 square miles, and its estimated population is 1500. The area of the chief island (Polillo) is 294 square miles; its chief town bears the same name and has a population of about 1400.

POLIORCETES, pól'i-ór-sé'téz. A surname of the Macedonian King Demetrius I. (q.v.).

POLISH CATHOLIC CHURCH IN THE UNITED STATES. See INDEPENDENT CATHOLIC CHURCH IN THE UNITED STATES (POLISH).

POLISH FOWL. A variety of poultry traceable as far back as the sixteenth century, under many names. These fowls are raised in the United States, mainly on account of their handsome plumage, the most striking feature of which is a great globular crest, or top-knot, which envelops the entire head. See Colored Plate of FOWLS, accompanying article POULTRY.

POLISH LANGUAGE. A language belonging to the western group of Slavic languages (q.v.) and occupying the second place in importance in that family. It is spoken by about 15,000,000 persons in those parts of Russia, Austro-Hungary, and Prussia which constituted the former Kingdom of Poland, and by more than 1,000,000 persons in America. Of the many Polish dialects, the following are the most important: *Great Polish* in Posen and portions of the governments of Kalisz and Plock; *Little Polish*—the most euphonious—in Galicia (Cracow and Lemberg being the centres); *Masurian*, or *Masorian*—in East Prussia and in the north-eastern part of the Polish Kingdom (Warsaw, the centre); *Lithuanian Polish*, used by Mickiewicz and other writers; *Prussian* and *Silesian Polish*—full of Germanisms. The earliest literary monuments in Polish do not go further back than the twelfth century. In its historical development the Polish language underwent many outside influences. The introduction of Christianity (c.965) brought Latin to the front at the expense of the native tongue, while the numerous German settlers introduced German words for articles of every-day life. The Reformation brought the language of the country into Church use. For about two centuries the macaronic literature (a mixture of Latin and Polish) prevailed. The pseudo-classical period brought the mania for everything French and with it the adoption of numerous Gallicisms. It was reserved for the Romanticists to purify the Polish language, and their traditions are still kept up by many purists in a struggle against the inroads of Russian technical terms and of Germanisms.

Although the combinations of sibilants in Polish look formidable on paper, they are soft in pronunciation, *sz = sh*, *cz = ch*, *rz = zh*, or *sh* after consonants. Besides the phonologic characteristics mentioned in the article SLAVIC LANGUAGES the following features of the Polish language may be mentioned: (1) Seven cases in nouns—nominative, genitive, dative, accusative, vocative, instrumental (ablative), and locative (prepositional). (2) Loss of the dual (in nouns and verbs), of which traces are still to be found, however, in various dialects. (3) All futures are compound; the simple preterites have all been lost, and periphrastic forms now take their place. (4) Invariable accentuation on the penult, which is a later substitution for the original Slavic free accent. In power and variety of expression, the Polish language fairly rivals Russian.

BIBLIOGRAPHY. Dictionaries: In Polish: Linde, *Dictionary of the Polish Language* (6 vols., 2d ed., Lemberg, 1854-60); *Dictionary of the Polish*

Language (ed. by seven Polish scholars, 2 vols., Vilna, 1856-61), fuller than the preceding but not so scientific. In other languages: Chodzko, *Complete English-Polish and Polish-English Dictionary*; Boech-Arkossy, *Vollständiges polnisch-deutsches und deutsch-polnisches Wörterbuch* (6th ed., Leipzig, 1893); id., *Polnisch-deutsches und deutsch-polnisches Wörterbuch* (8th ed., Leipzig, 1899).

Grammars: In Polish: Malecki, *Grammar of the Polish Language* (Lemberg, 1863), excellent; id., *Grammar of the Polish Language, Briefer Course* (ib., 6th ed. 1882); id., *Comparative Historical Grammar of the Polish Language* (ib., 1879); Malinowski, *Comparative Critical Grammar of the Polish Language* (Posen, 1870; and supplement, 1873); Kalina, *Grammatical Forms of the Polish Language to the End of the Eighteenth Century* (Lemberg, 1883), most valuable. In other languages: Morfill, *A Simplified Grammar of the Polish Language* (London, 1884); Smith, *Polnische Grammatik* (2d ed., Berlin, 1863); Vymazal, *Grammatik der polnischen Sprache zunächst zum Selbstunterricht* (Brünn, 1884); Poplinski, *Grammatik der polnischen Sprache* (7th ed., Thorn, 1881); id., *Elementarbuch der polnischen Sprache* (14th ed., Leipzig, 1893).

POLISH LITERATURE. The 'popular' literature of the Poles falls into two main divisions: (1) lyric and (2) epic. The first, although expressing the sadness of the race, oftener treats of themes of boundless merriment and joy of life. The second group consists of tales, animal epics, apologues, religious legends, and finally historical tales, few in number. The moods are definite and calm, strong realism intermingled with humor being the rule. These are embodied in the numerous adages, proverbs, and sayings—the whole philosophy of the nation. The best collections of material on this popular literature are: *Adalberg's Book of Polish Proverbs* (Warsaw, 1894); and the monumental work of Oskar Kolberg, *The People, Its Customs, Manners, Language, Traditions, Proverbs, Usages, etc.* (Warsaw, 1865-98), of which 23 volumes have so far appeared.

WRITTEN LITERATURE. EARLIEST TIMES. With Christianity (c.965) came also the rejection of everything national as reminiscent of heathenism. The indigenous letters were replaced by the Latin alphabet and all studies in the schools had for their sole object the mastery of the Latin language. In the thirteenth century education was extended, and more than 120 different schools are known to have existed in the period of 1215-1364. But the Polish scholars, writing in Latin, are in no way representative of the Polish nation.

The literary remains of this period to the end of the fifteenth century fall into three groups: (a) *Scientific.* Annals and Chronicles of Martin Gallus (1110-35)—quite fantastic in subject-matter, but unaffected in style and humorous; Wikenty Kadlubek (1160-1223), in most artificial and labored mediæval Latin; the journeys of the Franciscan Carpini (Giovanni di Piano) and Benedict Polacus to the Tatar Khan Hayuk in the thirteenth century. The *Historia Poloniae* of Jan Dlugosz (1415-80), Bishop of Lemberg, in 12 volumes, is a remarkable result of more than two decades of independent research, and is animated by strong patriotism and written in

artistic style. (b) *Didactic*. Sermons, though delivered in Polish, were written in Latin, to give them a wider circulation abroad. They contain much anecdotic material, important for the history of literature, as well as accounts of current superstitions and ethical instruction valuable for the history of Polish morals. (c) *Poetic*. These are very few; most of the extant manuscripts contain mediæval translations of the classics. Of the Polish poems preserved in Gallus, Wikenty, and Długosz, many are poetic in spirit and feeling, though crude in form. Of these the earliest and most remarkable specimen is the famous battle hymn to the Virgin (*Bogurodzica*), ascribed by tradition to Saint Wojciech of the tenth century. Other specimens are: the *Psalter of Queen Margaret*, in a manuscript of the fourteenth century, also known as the *Florian Psalter*; a prayer-book of the year 1375; a Polish translation of the fiftieth Psalm; the Gnesen sermons; the Bible written for Queen Sophia. Some Polish statutes and religious hymns belong to the fifteenth century.

During this period humanistic ideas gained ground. The number of schools increased rapidly to satisfy the great demand for study among the laity. The contest between scholastics and humanists, raging in other parts of Europe, was carried on also in Poland. Andrzej Halka's *Eulogy of Wiclif* proves that literature was becoming a means of religious propaganda.

In the sixteenth century the Polish language was gradually superseding Latin. The first book in Polish was printed in 1521 (*The Discourse of King Solomon*), and this is commonly taken as the beginning of the new 'golden' period of Polish literature. A Protestant translation of the Bible appeared at Brześć (Brest-Litovsk) in 1553. The great names of this period are: Mikolaj Rej of Naglowice (1505-69), who gives in his poems vivid pictures of contemporary manners, typical studies in character and graphic descriptions of scenery. Jan Kochanowski (q.v.) (1530-84) is best known by his *Psalms*. His *Laments* (on the death of his daughter Ursula) are characterized by depth and sincerity of feeling, and perfection of form. His *Jests* are rollicking with fun or bitter with satire. His dramatic effort (*Departure of the Greek Envoy*) was the pioneer in Polish drama. The names most closely allied with his are those of Szarzyński, Grochowski, Peter Kochanowski, Szymonowicz, and Sebastian Klonowicz (1545-1602), a keen satirist, but not a poet, and Stanislas Orzechowski (1573-66), who perfected the Polish language in his publicist writings.

The only poet of merit that the seventeenth century produced was Maciej Kazimierz Sarbiewski (1595-1640), a writer of Latin poems. The exhaustion of the poetic vein brought about the so-called 'macaronic period' of Polish literature. The only valuable achievements were the increasing number of translations of European poets. A theatre was established by Ladislas IV., where English, French, and Italian actors appeared. There had been native mysteries, such as Rej's *Joseph*. All of them were very poor, the best being those of Andrzej Morsztyn, but even he was more an imitator of French and Italian models than a creative poet; his translations of Corneille's *Cid* and Tasso's pastoral drama *Amin-ta*, however, were excellent. Wacław Potocki's

The War of Khotin, discovered in manuscript in 1850, is a powerful realistic poem, more striking when contrasted with the general barrenness of the period. The first half of the eighteenth century served to emphasize the dangers arising from internal disorders. Martin Matuszewski (1714-65) gave vivid pictures of the moral depravity of the times. Warning voices were heard against the licentiousness of the nobility (Karwicki) and the *liberum veto* (Konarski).

PERIOD OF FRENCH PSEUDO-CLASSICISM (1750-1822). The weak King Stanislas Poniatowski was a man of high culture and strong æsthetic leanings. A philosophical reaction succeeded Catholicism, and French ideas triumphed. The consciousness of social evils prompted the writers to expose them in satire and fable, while virtuosity of form was the chief object in this anxiety to imitate the French models. Trembecki (1723-1812), Wegerski, and Krasiecki (1735-1801) armed themselves against the reigning inertia, 'barbarous' prejudices, and foolish imitation of foreign manners. Naruszewicz fell below these three in poetic gifts, but, being an historian, surpassed them in the breadth of his views; his satire was more bitter, he felt more keenly the demoralization of society. Though Pseudo-Classicalists, these writers did a great service by connecting literature with life, and their works were very popular. Comedy flourished, and the first political comedy in Polish, *The Envoy's Return*, by Niemcewicz, enjoyed great success. The greatest name in Pseudo-Classical drama is that of Alexander Fredro (1793-1876), who wrote much later, but really belonged to this period. His plays are among the gems of the Polish stage, owing to the beauty and purity of the language, the genuine wit, the live types, and the unflagging interest of the action. Along with this satirical current the sentimentalist movement found strong representatives in Krasiecki, Karpiński, and Książnin, the first being especially popular. The final partition of Poland (1795) brought a wave of patriotism. Hence the success of Niemcewicz's *Historical Ballads* (1816). Dramas cropped up in answer to the same demand for and interest in everything historical.

ROMANTICISM (1822-62). Romanticism, which placed feeling above reason, answered the condition of Poland. *The Ode to Youth* of Mickiewicz struck a responsive chord in the hearts of his countrymen. From such feelings proceeded the love for the miraculous (destined to develop into mysticism a little later) and national folklore abounding in it. The educational reforms of Czacki and Czartoryski brought more learning; the poets sought recognition from their people as a whole, and not from patrons. The lyceum at Krzemieniec, with its inspired historian Leleweł poetically reproducing the ancient times, turned out a score of students who became the disseminators of Romanticism in their poetical and critical works, all of which aimed at creating a national poetry. Among the various factors in this literary movement the so-called Ukrainian (Little Russian) school was the most prominent. Among its representatives Malczewski (1793-1826) was the bard of the nobility; Zaleski (1802-86) glorified free Cossackdom; Goszczyński (1803-76) sang with epic simplicity the customs and beliefs of the Haidamaks. Zaleski's poems appearing in 1822 passed unnoticed. A few months later another collection of poems ap-

peared, and from those the period of Romanticism was dated. These were by Adam Mickiewicz (q.v.) (1798-1855), the greatest name in Polish literature. They exposed the author to attack from the adherents of Pseudo-Classicism, but soon these were either turned into romantics or were silenced. Before long the opposition to the romantic movement resulted in the exile of Mickiewicz and others, and almost all the poets then emigrated. Closely allied with Mickiewicz were poets of nearly equal power, as Krasinski (q.v.), who began with universal ideals (in his *Undine Comedy*) and then narrowed down to pure nationalism (in *Trydion, Dawn, and Psalm of the Future*). Unlike him, Slowacki had a definite purpose. Being a pronounced democrat, he endeavored to trace in a series of poetic works the democratic tendencies in the culture and political development of Poland. Around these three great poets gathered a number of lesser lights like Zan, Garczynski, Witwicki, Gorecki, Odyniec, and others. But soon the leaders became mystics. Slowacki's poems became so misty and involved that they were no longer understood. However, the clouds of mysticism passed away, and a more speculative and calm attitude toward reality set in among the workers. Wikenty Pol represented the past in an ideal light, Sigismund Kaczkowski and Rzewuski ably seconding him in his efforts. Ludwik Kondratowicz (1823-62, pseudonym Wladislaw Syrokomla), in his stories in verse, was the inspired singer of the aspirations of peasants and the small bourgeoisie. Lenartowicz (1822-93) took his themes from popular legends, preserving their simplicity in a delicate poetic form. After the apathy immediately following the revolution of 1830-31 wore away, there grew up a group of 'enthusiasts,' who wanted another revolution. Among the poets, who, with the exception of Pol and Kondratowicz, were all for revolution, Ujejski in his *Biblical Melodies* and *Jeremiah's Lament* described Poland under the name of Judea, and his *Choral* became the national anthem. This period of storm and stress evolved two distinct currents of political and philosophical thought in Polish literature: one turbulent (poetry) tending toward revolution, the other calm (novel and romance) toward gradual evolution. The novel, which was originally purely sentimental, received its high state of perfection at the hands of Kraszewski (q.v.) (1812-87).

MODERN PERIOD (1862-1900). Kraszewski reflected in his writings all the various currents of thought, ever seeking the 'golden mean.' Josef Korzeniowski was a deeper psychologist, and preached more progressive ideas, especially combating the prejudices of the nobility. Among those who idealized reality, Chodzko, Czajkowski, and the poetess Jadwiga Luszczevska may be mentioned. Zygmunt Milkowski (pseudonym Jeż) was an energetic champion of democratic ideas, even in his historical novels, and Zachariasiewicz with Plug (pseudonym of Pietkiewicz) followed closely in his steps. This period was in the beginning very similar to that subsequent to 1831, only the hope for restoration was weakened still more. The characteristic feature was the growth of the periodical press, which soon took the lead in the spiritual life of Poland. Books were printed in cheap editions in great quantities to supply the demand

for them among the masses. Positivism, economic questions, the material and spiritual welfare of the country were now of paramount importance. The chief organs for spreading these views were the *Weekly Review* and *Truth*, of the monthlies, the *Athenaeum*, representing the progressive elements, *The Warsaw Library* being the mouthpiece of the conservatives. About the middle of the seventies the strife between the two camps lost a good deal of its bitterness. In the three parts of the former Poland all efforts are directed toward the moral and intellectual uplifting of the masses, with the Warsaw weekly, *The Voice*, as champion of the people's rights. All these economic, political, and philosophical tendencies have found expression in literature, lyric poetry being least influenced by the various currents of thought. At the head of lyric poets stands Adam Astryk (1838-97), a master of form. Marya Konopnicka pleads the cause of the 'downtrodden and oppressed' in her lyrics, and she is famous for her short stories. The two writers mentioned have also distinguished themselves in the department of drama. Wiktor Gomulicki is the 'poet of nature and feeling,' possessing an unusually tender and expressive style. The comedy of the present day deals chiefly with social questions, in a light, satirical way. It is lively and witty, the situations are natural, and the action is interesting and rapid. The most prominent writer of comedies is Fredro the younger. Historical dramas, written by Szajski and others, are not very numerous, and are not so well liked by the public as dramas of manners and social questions. Among the writers of modern dramas Aleksander Swetochowski, Wacław Karczewski, and Wladislaw Rabski hold an important place. The chief characteristics of the modern novel are a highly perfected technique and great variety in the subjects, the characters depicted, and the tendencies of the authors. For these reasons the modern Polish novel is more fully representative of the epoch than is drama or poetry. Its brightest names are Sienkiewicz, Boleslaw Prus, and Eliza Orzeszkowa. Of the latest writers Klemens Junosza has drawn in a plastic and humorous style the life of peasants, Jews, and the small nobility; Ignacy Maciejowski also depicts peasant life; Balucki lashes the shortcomings of the contemporary Polish nobility; Dygasinski deals with life in the country. Several rather unsuccessful attempts have been made to introduce novels in the style of the French naturalistic school, while other writers try to keep up the traditions of Kraszewski. The periodical *Life*, founded in Cracow in 1897 by Ludwik Szczepanski, is the organ of this so-called Young Poland, Stanislaw Przybyszewski being the literary leader.

BIBLIOGRAPHY. In Polish: Wiszniewski, *History of Polish Literature* (10 vols., Cracow, 1840-57); Maciejowski, *Polish Literature* (3 vols., Warsaw, 1851-53) (both reach only to the middle of the seventeenth century); Zdankowicz-Sowiński, *Outline of the History of Polish Literature* (Vilna, 1874-78); Kondratowicz, *History of Literature in Poland* (Vilna, 1851-54); Bartoszewicz, *History of Polish Literature* (Cracow, 1877); Dubiecki, *History of Polish Literature* (Warsaw, 1889); Biegeleisen, *Illustrated History of Polish Literature*, vol. i. (Vienna, 1898). In German: Lipnicki, *Geschichte der polnischen National-Litteratur*

(Mayence, 1873), a short survey; Nitschmann, *Geschichte der polnischen Litteratur* (2d ed., Leipzig, 1888). The best work is in Russian in the second volume of Pypin and Spasovitch, *History of Slavic Literatures* (2d ed., Saint Petersburg, 1879-80) under the title, *History of Polish Literature*. It exists in a German translation by Pech, *Geschichte der slavischen Litteraturen* (Leipzig, 1880-84).

POLISH MUSIC. See SLAVONIC MUSIC.

POLISH SUCCESSION, WAR OF THE. See SUCCESSION WARS.

POLISHING MATERIALS. See ABRASIVES.

POLITIAN, or POLITIANUS. A celebrated Italian humanist. See POLIZIANO.

POLITICAL AND SOCIAL SCIENCE, AMERICAN ACADEMY OF. A learned society organized in Philadelphia, December 14, 1889, and incorporated February 14, 1891. Its membership has grown rapidly and is now more than two thousand, distributed through the United States and more than 30 foreign countries. Its general advisory committee is composed of representatives of the faculties of the leading American and of several foreign universities; the president and secretary are connected with the University of Pennsylvania, where the annual meeting is held in April. Its object is the promotion of political and social science, by accumulating a library, by offering prizes for specified contributions to science, by publishing papers and reports, and by establishing lecture courses. Its publications are *The Annals of the American Academy*, a bi-monthly magazine on current political problems, which began July, 1890, with several supplements every year containing translations of foreign works, and a special series of pamphlets, containing the principal papers submitted to the Academy, of which several hundred numbers have been issued.

POLITICAL ECONOMY. The term economics, derived from the Greek words *oikos* (household) and *νόμος* (law or regulation), was used by Xenophon and in the spurious treatise attributed to Aristotle, to signify the art of prudent and systematic household management, with particular reference to family income and expenditures, and to the labor and satisfaction of the wants of the members of the household. *Political economics*, or *political economy*, as the words imply, originally signified the art of directing the industry, the consumption, the incomes and expenditures of the State and its subjects with frugality and care; and in this sense was first used in the *Traité de l'Economie Politique*, published by Monchrétien de Vatteville in 1615. The use of the word in this significance soon became general. It was not until the nineteenth century that political economy came to be commonly conceived as a neutral science, divorced from the art of statesmanship. Economics then became the science of wealth, the study of those things which possess exchange value. This view became dominant about 1825, the abstract and theoretical treatment then in favor being divided into three or four topics: the production, consumption, and distribution of wealth (J. B. Say), or the production, distribution, and exchange of wealth (J. S. Mill), most subsequent writers including exchange and a minority following Mill in excluding consumption. Some

writers (e.g. Senior, J. S. Mill) proposed to limit the term political economy to this comparatively narrow science of wealth; while others proposed to substitute for the term the titles *Chrematistics* (Sismondi), *Catallactics* (Whately), meaning the science of exchanges. A sharp reaction set in about 1850 against the attempt to increase the precision of the science by narrowing its scope. The Historical School (see below) maintained that the subject of the study was not wealth, but man's relation to wealth; that it was part of a general social science, and could not profitably be divorced from ethics and politics. The first contention, well expressed in Roscher's aphorism that political economy begins and ends in man, has met with practically universal acceptance. The other contentions of the Historical School are still in dispute, but they have served effectually to prevent any uniform acceptance of the term political economy. *Economics*, wrested from its old meaning of household management, is used or defended by Jevons, Marshall, Macleod, Ely, and other leading economists, but it is the brevity and not the clearness of the word which preserves it, since as now used it is affected with all the ambiguity of the longer title.

CONTENT OR SCOPE. The investigation of the social relations and activities connected with wealth may be divided into four stages. In the first stage we describe, classify, define, and enumerate economic phenomena. In the second we analyze and interpret these phenomena for the purpose of revealing cause and effect, of discovering uniformities and sequences or economic laws. In investigating economic uniformities we are practically forced to certain conclusions about economic progress, and the theory of economic progress determines largely our interpretation of approximate aims and ideals: the determination of these ideals constitutes the third stage. In the fourth stage we discuss means to attain these aims and ideals. We may easily distinguish the stages in which one of these processes far outweighs in importance all the rest. Corresponding to the first stage we have Economic History, Economic Methodology, and Economic Statistics; corresponding to the second stage is Economic Theory; to the third stage, the Ethics of Political Economy; and to the fourth stage Applied Political Economy, often but infelicitously called the Art of Political Economy. It should be added that Economic Theory, also called Economics, Social Economics, Theory of Political Economy, etc., is usually subdivided further into the inductive theory and the deductive theory, and the latter is frequently called hypothetical, abstract, speculative, Pure Economics or the Pure Theory. Briefly stated, the debate over the proper scope of political economy hinges about the question whether the term political economy shall be applied to all or only to a part of these divisions. Some writers (e.g. H. von Scheel, Laveleye, and most German writers) would use the term political economy to cover all of them. The leading English economists of the present time would use the term so as to include all except ethics and applied political economy; while the fast disappearing group of which Senior is the best example attempted to confine the science of political economy to abstract or hypothetical theory. This question

will be considered below, where the discussion of scope is continued in connection with that of method. In anticipation of that discussion, and following the usage of Adam Smith and the popular interpretation of the term, we may define political economy as the ordered knowledge of the social phenomena arising out of man's activity in the acquisition and use of wealth.

By wealth we mean things possessing value. We mean goods and services which usually and regularly cost labor, and which are exchangeable for labor. We mean useful things of a material nature, and personal services which satisfy human wants, which exist in quantities below the amounts desired, so that each unit of them possesses distinct importance for us.

HISTORY OF ECONOMIC THOUGHT. GREECE. Greek economic thought is characterized by an exaggerated confidence in the power of the State to mold human nature, control industry, and direct the growth of society. In political thought this resulted in a striking subordination of the individual to the State; in the study of society it led to the subordination of economics to politics and ethics. Slavery was generally indorsed—indeed it was probably regarded as indispensable by the majority. The Greek philosophers fully understood the advantages of the division of labor, and Aristotle is generally credited with having entertained correct views upon money and advanced ideas concerning value. The Greek philosophers generally condemned interest-taking and entertained the traditional prejudices against trade and commerce. This brief summary may be accepted as representing the opinions predominating among those Greek writers whose works have come down to us. To be sure, there are certain qualifications to be made to this view of Greek thought, but on the whole it is probably true that the Greeks had little or no conception of the sacred regard for the individual which characterizes the theory of modern individualism.

THE ROMANS took their philosophy from the Greeks, and though they made important studies of particular economic problems, laborious studies have utterly failed to reveal the existence of anything approaching a dominant system of economic thought. Interest-taking, avarice, and trade were generally condemned by the philosophers. Slavery was occasionally condemned—by Varro and Columella as an expensive and demoralizing industrial system, by Seneca on the general principles of the Stoic philosophy. In the Roman jurists we find evidence of systematic thought upon the nature of money, wealth, and capital; the encouragement of population, the regulation of private property and sumptuary control of various kinds, etc. But the general line of historical development is from Aristotle to the Christian Fathers, and more particularly to the mediæval Canonists.

CHRISTIANITY. The immediate effect of Christianity was to strengthen in general the prevalent Aristotelian system of economic philosophy, its condemnation of usury and the pursuit of wealth in trade, its assertion of the superiority of agriculture, and its support of the social system of status. Christianity thus strengthened the subjection of economics to ethics, but it weakened the subjection of economics to politics. Within the Church there was taught the equality of men before God, and the essential dignity of

labor. The clergy were permitted to earn their own livelihood by manual labor, and the laity were exhorted to free their slaves as soon as they became Christians.

THE MIDDLE AGES (A.D. 400-1500). Inasmuch as the teachings and doctrines of the early mediæval writers are well summed up in the *Corpus Juris Canonici* (see CANON LAW), it will be convenient to discuss them under the general heading of the Canonists—the schoolmen and theologians who after the compilation of ecclesiastical laws by Gratian in the twelfth century analyzed and expounded, among other things, the relation to economic affairs of the Scriptures, the writings of the Christian Fathers, decisions of Church councils, and Papal decrees. The doctrines of the canonists were largely derived from the Scriptural injunctions against the excessive pursuit of wealth and the payment or acceptance of interest on loans. The early Fathers in their condemnation of avarice and their exaltation of fraternal love, sometimes used expressions which taken by themselves imply an utter condemnation of private property and an advocacy of communism among the faithful, but this was only an ideal, and private property was early recognized as a necessity resulting from the fall of man. The effect of this ideal, however, appears in the accepted doctrine that the maintenance of the poor was not a matter of philanthropy, but an obligation. The Scriptural attitude toward wealth led to an emphatic statement of the moral superiority of agriculture and handiwork over trade and commerce as a means of earning a livelihood, and the early writers seemed almost unanimous in the belief that what the seller made by trade the buyer necessarily lost. With the increasing temporal power of the Church and the great development of commerce which marked the eleventh century, came the necessity of harmonizing the doctrines of the Church with the obvious requirements of commerce, and many concessions were made by the later canonists. Thomas Aquinas (c.1226-74), the most authoritative of the later mediæval canonists, concedes that it is lawful to trade for a simple livelihood, or in order to supply a country with necessary articles which it does not produce within its own borders, or when the profits of the trade are devoted to some honorable purpose such as the assistance of the poor, but that, save in exceptional circumstances, a seller is bound to reveal a fault in an article, and that it is not permissible to sell an article for more than its worth. The fundamental axiom, in accordance with which all these conclusions are reached, is that every commodity has a fixed and objective value, which can be readily ascertained, and which determines its just price. To ask more for an article than its just price was extortion, and to pay less was equally unjustifiable. The distinctively ethical viewpoint of the canonists is shown in the prohibition of usury (q.v.). This was based upon the Scriptural injunctions against usury, and upon the Aristotelian argument that, money being barren it would be extortion to charge for its use. Another favorite argument was that interest was pay for time, but time is barren, and hence to demand interest was to demand something for nothing. It is needless to add that, as the growing commerce of the Middle Ages made the need of borrowing capital more and more imperative,

the canonical theory was stretched so as to accommodate many ingenious forms of contract for what was practically, though not nominally, usury. In the latter half of the fifteenth century the Franciscans themselves instituted the *monts de piété* (q.v.), or charitable banks for loaning money to the poor, and a small interest rate was imposed in order to defray the expenses of management. By the middle of the sixteenth century the Church had practically abandoned its effort forcibly to suppress avarice and the pursuit of wealth.

THE MERCANTILISTS (1500-1750). Mediæval economic theory had been dominated by ethical considerations; the economic thought of the early modern period was dominated by political necessities. Both the feudal system and the temporal power of the Papacy had been undermined by the growth of the great modern monarchies. The problems and needs of the national States absorbed the best thought of the age. The most pressing problem of the new national governments was how to secure greater revenue. Philosophers and publicists, who would not have stooped to the elucidation of the laws of private wealth, bent their best energies to the solution of problems arising out of the establishment and maintenance of particular States. The problem of the economic thought of the period was, however, a larger one than the mere raising of the public revenue. It was requisite that this revenue should be secured in that form—ready money—which is most easily transformed into armies, navies, and the other material embodiments of national power; and the problem included, in addition, the necessity of finding or creating some more productive source of taxation than the backward agriculture of the period. With the problem of the Mercantilists plainly before us, it is easy to understand the characteristic features of the mercantile system which are described under that title. "Mercantilism," says Schmoller, "in its innermost kernel is nothing but State-making—not State-making in a narrow sense, but State-making in the modern sense, which creates out of the political community an economic community." The restrictive regulations, discriminating laws, and State interference which Adam Smith and his immediate successors described as the essential features of mercantilism, we now know to have been in a sense incidental. State interference was distinctly a minor consideration, minor in the sense that it was not the problem at issue. Moreover, the mercantile system resulted not in a loss, but in a net gain of industrial freedom. Contemporaneously with the imposition of those external restrictions which mark the mercantile economy went a rapid and extensive abolition of internal restrictions which had been far more numerous, brutal, and destructive than the new external regulations which succeeded them. The economic and political unit had merely increased its size. While mercantilism is the most important phenomenon of economic thought in the sixteenth and seventeenth centuries, it constituted only a part of a widespread and eager investigation of concrete economic facts. It was these studies which gave the political economy of Adam Smith its rich content of concrete phenomena. Money, banking, the rise of prices, population, poor relief, etc., were all extensively discussed in brochures and monographs. The maintenance

of the poor was a constant subject of pamphlet and tract, and in the communistic *Utopia* of Sir Thomas More we have striking evidence that the problem of poverty was occupying the attention of the best thinkers of the time. The study of statistics became widespread and actuarial science and the investigation of social statistics were carried really to an advanced point. Neither is it correct to refer, as many have done, to the writers of this period as empiricists. Economic study had been divorced from ethics and theology, it is true, but at the hands of Bodin, Grotius, Pufendorf, Hobbes, and Locke, economics was developed as an essential part of a general political philosophy. In the *De Jure Belli et Pacis* of Grotius (1625), particularly, the whole mercantile system is in reality brought to judgment before the greater doctrine of international equity, and we have a new application of the old doctrines of natural law and natural liberty, doctrines which were destined to play a greater rôle in modern economic science than the whole mercantile system.

THE PHYSIOCRATS. Mercantilism had been marked by a narrow favoritism of commerce and manufactures; a reaction in favor of agriculture was inevitable. The mercantilist doctrine had been characterized also by an enthusiastic, though not less narrow, nationalism; it was natural, then, that the reaction in favor of agriculture should ally itself with the broad principles of natural law and liberty expounded in the works of Grotius, Pufendorf, and Locke. This reaction in favor of agriculture and industrial liberty found expression in the doctrines of the so-called Physiocrats (q.v.). The rise of the school be dated from Quesnay's first economic monograph, which appeared in 1756. As is implied in their name, the fundamental doctrine of the Physiocrats is the subjection of economic and political phenomena to 'natural law,' which as interpreted by them gave rise to the familiar political doctrine of radical individualism, and a certain materialistic conception of wealth which explains in a way all their peculiar economic theories. As Adam Smith noted, the Physiocrats treated not only of political economy, "but of every other branch of the system of civil government," and their political and economic theories were indissolubly fused in their general doctrine of a beneficent natural law of industrial freedom, according to which the largest production and justest distribution of wealth would be best secured by permitting each individual to 'pursue his own interest in his own way,' so long as he did not infringe on the like liberty of others. This theory, perpetuated and popularized by Adam Smith, has exercised probably more influence upon subsequent thought than any other economic doctrine ever formulated.

While the Physiocrats fully exposed the error of confusing wealth with the precious metals, they themselves fell into the error of confusing wealth with material objects. Identifying the production of wealth with the production of raw materials, they concluded that manufactures and commerce, which merely change the position or form of raw materials, are barren and unproductive, though useful and desirable when strictly subordinated to agriculture; that the value added to raw materials in the processes of trade and industry is equivalent merely to the cost or expenses of production, while agriculture

yields a net surplus—*produit net*—over and above the expenses of production. To Quesnay, however, the large agricultural employer, not the agricultural laborer, was the real producer of wealth; and the physiocratic theory is especially strong and advanced in its analysis of capital. Agriculture being thus the sole ultimate source of national revenue, simplicity, economy, and justice demanded that the revenue of the State should be raised by a single direct tax—the *impôt unique*—levied upon rent. (See SINGLE TAX.) The Physiocrats must accordingly be credited with the first statement of the epoch-making theory of surplus value, the theory that the product of industry contains a certain fund of value, due to the coöperation of natural factors, which is in excess of the minimum remuneration required to elicit the toil and sacrifice of industry, and which constitutes on this account an exceptionally satisfactory source of taxation.

Adam Smith, whose *Wealth of Nations* appeared in 1776, is easily the foremost figure in the history of economic thought. Next to his influence in hastening free trade and in popularizing and dignifying the systematic study of wealth, Smith's most important service, perhaps, was in divorcing political economy from ethics, and in part from politics. This appears plainly from the outline of his lectures, which were divided into four parts: I. Natural Theology; II. Ethics—incorporated in his *Theory of Moral Sentiments*; III. Justice or Jurisprudence; IV. Political Economy. He has been charged with the mistake of treating man as merely a wealth-seeking animal in whom the altruistic motives are wholly absent; but this criticism neglects the fact that in his *Theory of Moral Sentiments* the motives of duty and sympathy are accorded full recognition, and the desire for wealth is treated as only one of the worthier objects of ambition. Even in the *Wealth of Nations* he opposes piece-work as calculated to incite the laborer to over-exertion, and voices the necessity for rest, diversion, and even 'dissipation.' His whole attitude in the *Wealth of Nations* is essentially this: Assuming that the object of the study is to increase the national wealth as much as possible, this object will be most effectually secured by perfect industrial liberty. He left the prior question of the desire for wealth to the *Theory of Moral Sentiments*. On the other hand, he did not succeed so well in separating politics from economics. He could not get without the bounds of political philosophy, because his ultimate purpose was to prove the supreme efficacy of the doctrine of *laissez-faire*. Yet before he could lay down maxims for the increase of wealth, it was necessary to inquire how wealth was actually produced and distributed, and in doing this disinterested work of science he ceases to be the advocate. It was this passionless analysis of production, value, and distribution which had the greatest effect upon the economists who followed him and led to the attempt to formulate a non-partisan science of political economy, which should pass no ethical or political judgments. It must never be forgotten that Adam Smith was not wholly consistent in the development of his theories. At times he seems to hold that education should be left wholly to private initiative, but again he classes it among the neces-

sary functions of government. In places he seems to hold a brief for 'perfect industrial liberty,' yet he does not hesitate to recommend the State regulation of banking, and his characterization of the Navigation Act as "perhaps the wisest of all the commercial regulations of England"—purely on political grounds—is famous. This inconsistency, which was in reality owing to breadth of thought, shows itself in his method of investigation. Whether it was inductive or deductive has been the subject of wide and animated discussion. Whatever the truth in this matter, the fact remains that at the hands of the economists who immediately succeeded him the science itself became increasingly theoretical, increasingly deductive and abstract. The most potent single quality of Smith's work which contributed to these results was its so-called 'universalism.' His work dealt with the wealth of nations, not that of a particular nation, or a particular epoch, and his confidence in the existence of a natural law of universal applicability left an indelible impression upon subsequent thinkers. Granted the existence of such a law, the conditions of time, place, race, and nationality must be matters of secondary importance. The superiority of the deductive method naturally follows.

THE CLASSICAL SCHOOL. The economic thought of the early part of the nineteenth century was dominated by a group of writers including Bentham, Malthus, J. B. Say, Ricardo, McCulloch, James Mill, and others, who have been variously designated as the Classical, Orthodox, Ricardian, or English School. The leaders of this school differed upon points of economic doctrine, but the general system of thought developed by them is strikingly harmonious: deductive in method, pessimistic in tone, utilitarian and materialistic in its assumptions, and cosmopolitan in the sense that its ultimate scientific ideal was the discovery of universal economic laws applicable to all nations at all times.

Jeremy Bentham (1748-1832) gave the classical economy its ethical framework through his formulation and tireless propagation of the utilitarian philosophy. Utilitarianism in its early form was largely an application to ethics of the individualistic doctrine of self-interest which Smith and the Physiocrats had applied so skillfully in the field of political philosophy. "To obtain the greatest portion of happiness for himself is the object of every rational being," says Bentham.—All that was materialistic, pessimistic, and mechanical in the classical system of political economy seems to have been magnified and intensified by the famous *Essay on the Principle of Population* by Malthus (q.v.), who in his fondness for the historical method of research was in marked contradistinction to the men about him. But his favorite method had little or no effect upon the classical political economy, while his famous doctrine that population tends to increase faster than food became the very backbone of the classical economy and modified almost every department of human thought. It may, indeed, be said that while Adam Smith investigated the causes of the wealth of nations, Malthus gave an exposition of the causes of poverty, and the contrast is not unfair. The one was essentially an optimist, the other, if not himself pessimistic, certainly gave a more pronounced impetus to pessimistic tendencies than

any other economist in the history of the science. From the scientific standpoint, the most important use made of the Malthusian proposition was in the Ricardian theory of distribution.

David Ricardo (1772-1823) held that as a country grew and population increased society would be forced to resort to poorer and poorer soils to obtain its supply of food, the *law of diminishing returns* would set in, and as the margin of cultivation was forced down an increasing share of the product of industry would go to the landlord in the shape of *economic rent*—the difference between the natural productivity of the better land and the worst land in cultivation. Excluding rent, the division of the remainder of the product between the laborer and the capitalist was determined by a corollary of the Malthusian principle—the ‘iron law of wages.’ In the long run, Ricardo held, wages would tend to equal the cost or price of the food, necessities, and conveniences required for the support of the laborer and his family in their accustomed style of living. Profits, naturally, consisted of the product minus rent and wages; they were ‘the leavings of wages.’ Ricardo’s theory of ‘progress,’ then, is clear. With the passage of time and the settlement of the country, rent would absorb a larger share of the produce, increasing both absolutely and relatively; wages would absorb a larger share, increasing relatively, but remaining constant in amount (with a tendency, however, to decrease as rents rose higher and higher); while profits would necessarily decrease both absolutely and relatively. This theory of distribution was developed as an integral part of his famous *cost of production theory of value*, i.e. that commodities will tend to exchange in quantities proportional to the respective expenses of producing them. In stating this theory Ricardo at times spoke as if all the expenses of production could be resolved into the toil and sacrifice of labor—commodities, he was fond of saying, tend to exchange for each other according to the respective amounts of labor embodied or realized in each. He thus supplied the socialists with their celebrated labor theory of value, according to which labor is the sole cause of value, and in consequence is entitled to the whole produce of industry. To a great extent Ricardo molded the economic thought of the day, and has greatly influenced the later economists. The socialists took from it, illogically perhaps, the iron law of wages and the labor theory of value. Henry George took from it, but logically in this case, the doctrine that progress itself means poverty so long as private property in land is permitted. Finally, Ricardo’s theory shifted the centre of economic interest from the land-owning classes to the capitalist class.

ENGLISH POLITICAL ECONOMY SINCE RICARDO. The narrow scope, the deductive method, and the theoretical nature of the classical economy were all intensified and formally indorsed by N. W. Senior (1790-1864), the most influential English economist between Ricardo and the younger Mill. Within the limits of classical economics Senior did notable work; he cleared up many of the latent obscurities in the Ricardian theory of distribution, propounded the abstinence theory of interest, and formulated the famous *doctrine of the wages fund*. (latent in the work of Smith, Ricardo, and others) that the

average rate of wages is the quotient secured by dividing the number of workmen into the fund of capital set aside by the capitalists for the employment of labor. With the exception of the Malthusian principle, this doctrine probably contributed more than anything else to make political economy the ‘dismal science.’ Senior is remarkable also for his exposition of the extent to which the monopoly element enters into ordinary economic life. Under perfect competition, he declares, prices of commodities would accurately measure “the aggregate amount of the labor and abstinence necessary to continue their production.” But he points out repeatedly that differential advantage of any kind in production gives rise to a monopolistic rent, which includes all income obtained without a proportionate sacrifice of labor or abstinence. In his abstinence theory Senior deprived the socialists of much of the comfort offered them in the classical economy, but in his analysis of monopoly he clearly defines the element in distribution which supplies them with a real grievance.

John Stuart Mill (1806-73) typifies the transition in England from the classical to the modern system of economic thought. He began his career as a Ricardian of the Ricardians, but in the later years of his life he came under the influence of Auguste Comte and the socialistic thought of his time, and in 1848 his principal economic treatise appeared under the title *Principles of Political Economy with Some of Their Applications to Social Philosophy*—a queer compromise between the Ricardian economics, which he had learned in his youth, and the warm desire to find some means to improve the condition of the masses, which had come to him from the observations of his maturer years. The compromise was not fortunate from the standpoint of logic. Most economists since Mill, and Mill himself in his later years, recognized that the book was inconsistent; but it was superbly written, alive with the desire to improve the condition of the masses, and exercised an enormous influence upon the subsequent development of English economic thought. The modifications of the old doctrine which Mill introduced exercised probably a greater influence than the old theories which he incorporated in his *Principles*. He preserved the old doctrines of rent and profits, and advocated *laissez-faire* as a general principle of political expediency, but made so many exceptions that at times they seem more important than the rule. Mill also indorsed the doctrine of the wage fund; but in his later years he abandoned his belief in this theory, and advocated “views of the taxation and regulation of inheritance and bequest which would break down large fortunes and bring about a wider diffusion of property.”

The development of English economic thought since 1850 has been profoundly affected by the reaction against the classical system described below, and only a few words can be devoted to the subject here. The logical successors of Ricardo and Senior were Cairnes, Bagehot, and Fawcett (to whom might be added Professor Marshall of Cambridge). It is impossible to characterize at length the work of these men, but all have been ardent defenders of the orthodox school, though they have recognized and ably expounded its limitations as a theoretical science. They stand as the modern defenders (Fawcett an

extreme partisan) of the deductive type of economic theory. In Thorold Rogers, Cliff Leslie, Arnold Toynbee, and Professors Ashley and Cunningham we have a group of historical economists, all of whom have made important contributions from the historical standpoint and who have indorsed more or less completely the general views of the Historical School (see below). Jevons stands at the head of what might be called a psychological school of political economy, of whom perhaps the most distinguished living British exponents are Professor Edgeworth of Oxford and Professor Smart of Glasgow. Both Jevons and Edgeworth, however, have made important contributions in every branch of the science, particularly that of statistics; and the attempt to classify such men as Bagehot, Jevons, Marshall, Edgeworth, and Nicholson reminds us forcibly that the period of schools has fortunately passed. The representative English economists, like those of every other country, make the most of all schools and methods: deductive, historical, psychological, statistical, and mathematical.

MODERN REACTIONS AGAINST THE CLASSICAL SYSTEM. SOCIALISM. It is a striking tribute to the classical system of political economy and to the intellect, power, and personal excellence of its leaders, that the development of economic thought since 1850 can best be understood and described as a series of reactions against the dominant doctrines of that school. The earliest and most passionate protest against the classical economy came from the socialists. (See **SOCIALISM.**) The antagonism between socialism and the classical economy is fundamental and irreconcilable. The foundation of the latter was *laissez-faire* and its theories were built around the system of private capitalistic enterprise; while socialism is in essence a protest against *laissez-faire* and the private ownership of capital. The rise of modern socialistic doctrine may conveniently be dated from William Godwin's *Inquiry Concerning Political Justice* (1793), although Godwin himself was inclined toward anarchism; but the chief bond uniting the early socialists was their common hatred of the orthodox political economy. In recent times, largely under the influence of Karl Marx (q.v.), socialism has acquired a positive theory which is adopted with substantial unanimity by the great mass of people who may correctly be called socialists. Logically enough, this 'scientific socialism' has its roots in the Ricardian theory of value and distribution. Mutilating his theory of value and interpreting it ethically, they claim that, as labor is the sole cause of value, the laborer is entitled to the whole produce of industry. They accept a part of his gloomy law of wages, magnify the class antagonism inherent in his theory of distribution, and glory in the pessimism which unconsciously pervaded his analysis. On the basis of a broader historical survey than Ricardo permitted himself to make, they confidently assert that the régime of capitalism is but a temporary stage in industrial evolution, and that it must inevitably give way to a régime of collective production. Marx's theory of value has met little but criticism from the economists, but his doctrine that the underlying causes of all social phenomena, such as religion, literature, and art, are economic in character, called by him the materialistic conception of history, has profoundly influenced the

science, particularly in Germany. The chief office of the socialists has been to arouse sympathy for the classes of society whose condition is such as to make socialism attractive to them.

THE SOCIOLOGISTS. To the sociologists may be ascribed the most fundamental and inclusive protest against the methods of the Classical School. The Ricardians aimed at an abstract science of rigid precision, universal in application, raised above the limitations of particular epochs and national boundaries. They were thus led to neglect history, custom, law, and ethics; they spoke as if the existing stage of economic development was permanent, and their method of treatment was predominantly deductive. The most effective protest against these exaggerations was made by the Historical School, which will be noted hereafter; but a more fundamental protest, and one prior in point of time, was made by Auguste Comte (1798-1857), the father of modern sociology. He exercised great influence in shaping the methods of political economy and marking out its particular place among the social sciences. The influence of sociology upon modern economic thought will be discussed more fully in the article **SOCIOLOGY.**

THE HISTORICAL SCHOOL. The most influential reaction against the classical economy was that inaugurated by what is known as the Historical School of Germany, and is usually dated from the work of Lorenz von Stein, *Der Sozialismus und Communismus des heutigen Frankreichs*, written in 1842, or, more correctly, from Wilhelm Roscher's *Grundriss zu Vorlesungen über die Staatswirtschaft nach geschichtlicher Methode*, published in 1843. Two contemporaries of Roscher, Bruno Hildebrand and Karl Knies, must be associated with Roscher and Stein in the introduction of this method, which has transformed economic science in Germany and profoundly affected it the world over. The characteristics of the Classical School which these writers most earnestly attacked were what have been called its cosmopolitanism and its perpetuism—the belief in economic laws valid for all nations and all times. The positive doctrines of these writers, briefly summarized, maintain the propositions that economics is a social or political science which can be profitably pursued only in connection with the other sciences of social or political life, particularly administration, law, and history; and that not only are economic phenomena conditioned by general social and political institutions, but that these institutions are products of an ordered historical development, so that the economic science of any particular nation can only be studied and formulated in connection with the historical development of that nation. Thus instead of a universal political economy we have an historical national economy. The work of the Historical School must be regarded as the most important movement of economic thought in the latter half of the nineteenth century, but only a few words can be devoted to its rise and development. From the standpoint of method it was simply an application to economic investigation of a method that had been developed and popularized by Grimm, Savigny, Eichhorn, and other German investigators in philology, history, and jurisprudence, a generation before the rise of the Historical School of political economy. What may be called the nationalistic spirit of the school

was the result of irresistible political forces of the day, first expressed in the economic publications of Friedrich List (1789-1846). Germany was in the process of developing into a great empire, and, as has been pointed out in connection with the mercantile system, such a period in the life of a nation is almost invariably attended with protective legislation designed to make the new State industrially, as well as politically, independent and homogeneous. The new German economies simply voiced these economic and political tendencies, to which attention had been called by List. The work of the German economists who succeeded Roscher, Knies, and Hildebrand has been marked by a predominant use of the inductive method and a close adherence to actual economic phenomena; by special study of the effect of legal institutions, custom, law, and ethics upon economic phenomena; by an intermediate attitude between extreme protectionism and extreme free-trade views; and by a discriminating sympathy with the claims of socialism. Quite generally they look to the State rather than to individual initiative to solve the problem of poverty, and they have thus become known as *Kathedersocialisten* (socialists of the professorial chair), or State Socialists, as contrasted with the Social Democrats, whose radical programme they refuse to indorse.

The American reaction precedes in point of time the National Oekonomie of Germany, and, like the latter, had its source in the political problems attendant upon the rise of a new State. The first systematic protest came from an early group of publicists, among whom may be mentioned Alexander Hamilton, Daniel Raymond, Matthew Carey, Hezekiah Niles, and Friedrich List. Daniel Raymond is the author of the first treatise on political economy in which a distinctively American system was advanced. His first work, *Thoughts on Political Economy*, appeared in 1820, and undoubtedly attracted a good deal of attention in certain circles. The fundamental idea of Raymond's system is his conception of wealth. Wealth, he held, is not an aggregation of exchange values, such as Adam Smith had conceived it, but the capacity or opportunity to acquire the necessities and conveniences of life by labor. The English political economy, he held, was a study of exchange values, of private economy as opposed to national economy, and the laws of wealth laid down by Adam Smith were untrue of a nation conceived as a unity. Extending his doctrine of wealth, he maintained that the interests of one class do not always coincide with the interests of the nation as a whole, and that national wealth in its true sense will be most rapidly increased by developing all the national powers to their widest possible extent. He is, thus, a warm advocate of protection as opposed to the doctrine of *laissez-faire*.

We come to a second period of development in American economic thought with Henry C. Carey (1793-1879), by far the most influential of the earlier American economists. Carey's work is especially noteworthy, not only for his earnest defense of protection, but for his economic optimism and his continued attacks upon the Ricardian school. Drawing his lessons from American experience, he flatly denied the Malthusian principle and the law of diminishing returns. Carey's position upon these points was

undoubtedly well taken for the America of his time, and although it is questionable whether he was justified in defending the exact converse of these propositions, he did unquestionably show that the fundamental premises of the classical economy were not universally applicable. Carey defended a broad social conception of wealth similar to that held by Raymond, defining it as the measure of power which man has acquired over nature, while "the value of an object expresses the resistance of nature which labor has to overcome to produce the object." Carey thus was led to propose the theory that the value of an object depends rather upon the cost of reproduction than the cost of production. Perhaps the central doctrine of his system is that of association. The increase of wealth, the increasing mastery of man over nature, the development of a nation's powers, Carey held to be dependent upon the increasing association resulting from a compact population following diversified pursuits with a close interrelationship between agriculture and manufactures. It was this optimistic belief in the possibilities of increased association that led him to advocate protection and to survey an increasing population with the greatest complacency. Since Carey's time, other American economists, like Henry George and Francis A. Walker, have exerted a world-wide influence upon economic thought. The younger generation of American economists have been largely trained in the German universities, and have in the main accepted the positive doctrines of the German Historical School. Without depreciating the work of the great English economists it may be said that American investigation is marked by the attempt to test and supplement deductive reasoning by an appeal to statistics, law, and history. In a typical American university the specialist in economic theory works harmoniously with associates whose special domain lies in economic history, statistics, finance, or the practical problems of the day. All methods are acknowledged to be useful, and all are employed. The period of criticism has given way to a period of construction; but American economic thought is still profoundly affected by the optimism and what may be called the anti-cosmopolitanism of the early American reaction.

THE AUSTRIAN SCHOOL represents a reaction within the limits of the classical economy itself. The name Austrian School is used simply because the marginal utility theory of value, which constitutes the essence of this reaction, has been most thoroughly developed and most widely applied by a group of Austrian economists, including Professors Menger, Wieser, Sax, and Boehm von Bawerk; though the theory itself was propounded almost simultaneously in 1871 by Professor Jevons in England and Menger in Austria, and is now used by a large majority of economists everywhere. The adherents of this school hold, in brief, that the utility (i.e. power of satisfying want) possessed by a commodity decreases per unit as the amount consumed increases, and that value itself is, or expresses, the utility of the last or marginal increment of the commodity supplied for consumption. It cannot be doubted that they have transformed economic theory; the old unit of real value—the pain and sacrifice of labor—has given way to a unit of utility; and the cost-of-production theory of exchange has been replaced by a wider concep-

tion which holds that value determines the expenses of production rather than the expenses of production value, that capital receives its value from the finished product, and not *vice versa*, etc. The whole tendency of this theory (see VALUE) has been to shift the centre of gravity in economics from the capitalist to the consumer and to block the movement to confine political economy to a study of exchange value. It has undoubtedly clarified our general conceptions of wealth and exchange much in the same way that the theory of evolution has clarified our general conception of progress.

SCOPE AND METHOD. RELATION OF POLITICAL ECONOMY TO SOCIOLOGY. The most inclusive and fundamental question of scope is the relation of political economy to the general science of human association. Two extreme views of this relation have been maintained: (1) that because of the intimate and inseparable connection between all forms of social activity, the study of economic phenomena cannot be divorced from the general study of sociology (e.g. Comte, H. von Scheel, Ingram); (2) that political economy is an absolutely independent science, dealing with the phenomena of wealth alone (e.g. Senior, Mill, Cairnes). At the present time there is a strong consensus of opinion that both these views are ill advised. While it is now admitted with practical unanimity that political economy is a social science, the bewildering complexity of social phenomena, together with the slow progress of sociology conceived as the general science of human association, has deeply strengthened the conviction, borne out in other departments of scientific investigation, that specialization and the isolation of phenomena are indispensable.

THE RELATION OF POLITICAL ECONOMY TO ETHICS, LAW, AND POLITICS. In discussing this question attention may be confined largely to the relationship between ethics and political economy, since the decisive arguments apply to all three relationships. Substantial unanimity exists upon the following points; (a) that ethics and economics are, for purposes of investigation at least, two distinct sciences; their fields are not coextensive; (b) in applied political economy we must take account of ethical requirements; no economist would maintain that in actual life men are "freed from the ordinary obligations of justice and humanity;" (c) in so far as ethical forces affect economic activity, economic science must take account of these forces. The point at issue is the question whether the scientist, as scientist, is permitted or compelled to set up ideals and pass ethical judgments. The following reasons may be given for the conclusion that it is practically impossible for the scientist to abstain from passing ethical judgments: In the first place, every rational adult understands and accepts certain axiomatic ethical canons which in their practical application are universally accepted (e.g. that the satisfaction of hunger is a good thing). In the investigation of actual economic phenomena, such as the housing and food of the laboring classes, conditions are constantly met with that violate these ethical canons. It would be the sheerest pederasty under these conditions to refrain from passing ethical judgments. Secondly, an essential part of economic science is that subdivision which treats of economic progress. In economic life what ought to be done is intimately dependent upon what

can be done; in other words, the law of economic growth is a powerful, if not the most powerful, factor in determining economic aims and ideals. If the fully equipped economist is forced to study economic growth and to explain economic movements and tendencies, it follows that he is forced to express opinions upon approximate economic ideals, and after having furnished the decisive arguments for ethical judgments, he must either apply his results or have some less qualified person apply them for him. Additional reasons appear when we examine such subjects as taxation or those public prices which the law declares must be just and reasonable. In the consideration of railroad rates, for instance, the economist is not only compelled to pass judgment upon what is just and reasonable, but he discovers upon investigation that economic considerations supply the most important factors in determining this judgment. There is, then, a broad zone of territory between ethics and economics which the moralist has not worked—and which for the science of ethics is probably unimportant—but which the economist must clear up before he can go on with his work. The assertion that the science of political economy may and should refrain from passing ethical judgments rests upon two misapprehensions: (1) the failure to grasp the fact that society is like an organism in that it is subject to a law of ordered change, which to a certain extent is under the control of the organism itself; (2) an illogical conclusion from the recognized truth that certain subdivisions of economic investigation (e.g. fixation of prices in wholesale markets) may be exploited quite thoroughly without determining economic ideals, and without introducing ethical considerations. From this it is logical to conclude that certain minor subdivisions of political economy may be investigated "without passing ethical judgments," but illogical to conclude that the whole science may be so investigated and formulated. The above conclusions are strengthened when we consider the relation of economics to law or politics. In describing the progress of the past or the conditions of the present we are forced to pass judgment upon the economic success or failure of many laws and policies (e.g. tariff laws) which are still in force or under active consideration, and which will be indorsed or repudiated solely or largely upon economic grounds. Because of this fact the economist cannot refrain from judgment upon laws and political policies. Nor without being ridiculous can he refrain on occasion from laying down precepts. Gresham's law, for instance, is at once a law and a precept when a proposition to maintain a more valuable and a less valuable money side by side in circulation is under consideration. In conclusion it may be said that while political economy does not undertake the complete study of law, ethics, politics, etc., it must consider systematically the parts of those sciences which materially affect economic phenomena. It is neither possible nor desirable that the line of demarcation should be rigidly drawn, particularly in the applied science or art of political economy, which may be defined as the application of economic laws to the solution of those practical problems in which economic considerations are of predominant importance.

RELATION TO OTHER SCIENCES. Political economy is probably more dependent upon history than

upon any other science, and indeed an extreme wing of the Historical School, of which Schmoller is the most prominent example, holds that until a larger store of historical results is accumulated it is of little use to attempt broad theoretical generalizations; thus confining economics for the present to the philosophy of economic history. This position seems untenable because of the evident logical deficiencies of the historical method when used alone, and because new problems are constantly arising upon which history throws little light. (See *Deductive Method*, below.) While the great majority of economists refuse to admit that political economy is merely history, the importance and necessity of economic history are now universally conceded. Dr. Keynes classifies the functions of economic history in connection with economic theory as follows: "First, to illustrate and test conclusions not themselves resting on historical evidence; secondly, to teach the limits of the actual applicability of economic doctrines; thirdly, to afford a basis for the direct attainment of economic truths of a theoretical nature."

The connection with psychology is particularly intimate. As a study beginning with human effort and ending with the satisfaction of human wants, economics really has its beginning and end in psychology. The theory of value, particularly, takes its fundamental axioms from psychology (e.g. that the satisfaction afforded by commodities decreases per unit as the amount consumed increases). The difference between economics and psychology is, however, clear: the one deals with man in society, the other with man as an individual.

THE DEDUCTIVE METHOD. What is known in economics as the deductive method consists usually of three stages, the first and last of which are inductive. In the preliminary stage, either from common observation or more complex induction, the *postulates* of the deductive science are secured. In the English economic theory prevalent from Ricardo to Cairnes these postulates were excessively simplified. Ricardo, like Adam Smith, was fond of drawing his premises from an imaginary state of primitive industry. Senior reduced the postulates of political economy to four general propositions: "(1) That every man desires to obtain additional wealth with as little sacrifice as possible. (2) That the population of the world is limited only by moral or physical evil, or by fear of a deficiency of those articles of wealth which the habits of the individuals of each class of its inhabitants lead them to require. (3) That the powers of labor, and of the other instruments which produce wealth, may be indefinitely increased by using their products as a means of future production. (4) That, agricultural skill remaining the same, additional labor employed on the land within a given district produces in general a less proportionate return." It is impossible to give a list of the postulates which have been assumed by different writers, but it is evident that they must vary widely in different branches of the science, and that almost every deductive writer has unconsciously assumed many postulates not specifically stated. In the ordinary deductive treatment of value and distribution there are usually postulated the propositions that men not only desire, but know how in

general to obtain the maximum satisfaction with the minimum effort; that certain industries are subject to the law of increasing rather than diminishing returns; that the satisfaction afforded by a commodity decreases (per unit) as the amount consumed increases; that existing law, public opinion, and ethical standards, in general remain constant. It is the intermediate stage which is most appropriately called deductive. Here the familiar processes of the deductive logic are employed. It is evident, however, that the results obtained from the artificially simplified premises of ordinary deductive theory are of doubtful value. If the postulates be absolutely true and the deduction faultless, the conclusions express abstract tendencies which will be modified in real life by the action of secondary forces not taken into account in the premises. This, however, is the character of the pure theory of all sciences. If, on the other hand, the premises practically cover the predominant forces in any domain of economics, they may yield results capable of explaining actual economic conditions, and capable of affording the basis of prevision. In actual usage, however, these postulates have been sometimes untrue, often ambiguous, and always more numerous than was explicitly stated, so that Cliff Leslie and other writers of the Historical School have characterized the conclusions of English theory as utterly inapplicable in any sense either to the explanation of existing conditions or the solution of practical problems. This extreme antipathy to deductive theory is, however, plainly illogical. Whatever the necessity of studying the past, no one denies that the present and the future furnish the ultimate and principal problems of the science. And many of these problems are new; to solve them we must isolate the factors at work, calculate separately their effects, and try to estimate the net results. This process must be largely deductive, and it is strange that those who insist most strenuously that the science is a practical one should attack a method necessary in the solution of practical problems. The historical method alone is helpless in the face of such a problem as the proposition to introduce compulsory arbitration.

Of the third stage in the deductive process, that of verification by observation, little need be said. In practice it is exceedingly difficult, as was shown when Mill attempted to "apply" the Ricardian theories, but it is essentially a species of induction subject to all the limitations of the inductive method in general.

THE INDUCTIVE METHOD. The ultimate aim of the inductive method is by systematic analysis and comparison of concrete economic phenomena "to observe the effects of a cause coming singly into action while all other forces remain unaltered." The attempt to do this gives rise to two inductive processes: the method of difference and the method of agreement. In the method of difference we compare circumstances exactly similar with the exception of one factor, in order to discover the effect of that factor. Thus, in 1893, Messrs. Mather and Platt, of the Salford Iron Works, attempted to discover the effect of the eight-hour day on their profits and the general welfare of their workmen. Strictly speaking, their experiment required that, with the exception of the hours of labor, every causal

condition in 1893 should be identical with those in preceding years, as their object was to discover the exact effect of the reduction in hours upon profits and conditions of employment. The chief instrument of the method of difference is thus the experiment, to which may be added in economics the observation of extraordinary instances in which the conditions of an experiment are closely approximated by some fortuitous or extraordinary event. Thus the Black Death in England furnishes a striking exemplification of the effect upon wages of a sudden diminution in the supply of labor. In theory the method of difference requires that the collateral or surrounding circumstances shall be absolutely alike. This condition is seldom fulfilled even approximately, and hundreds of instances might be cited in which the method has been abused. To refer to the experiment at the Salford Iron Works, which on the whole constitutes an ideal economic experiment, it is evident that grave doubt is thrown on the results of this experiment by the fact that the workmen themselves were interested in the success of the experiment, and probably worked with extraordinary care and diligence to make it a success. Finally, it is to be noted that the method of difference, while entirely satisfactory where the conditions are perfect, is always narrow and restricted. It shows with certainty that a given cause in a certain set of circumstances can produce a certain result, but tells us nothing of what will happen in another set of circumstances.

To generalize, to establish uniformities, use is made of the method of agreement. Here we compare circumstances wholly different, with the exception of two phenomena between which we expect to establish a causal connection. The causal connection is indicated by the repeated conjunction of the two phenomena. If we examine the movement of exports and the movement of the marriage rate, and find that a rise in the exports per capita is always accompanied by a rise in the marriage rate, we are safe in accepting this connection as an economic uniformity or law, provided that we have examined a very large number of instances in which the collateral circumstances have been infinitely diverse and varied. Theoretically this method requires that we should exhaust every possible combination of circumstances before concluding that a rise in the exports per capita will always cause an increase of marriages.

With respect to the general utility of the inductive method, it is plain that, though little can be done without it, it seldom, if ever, suffices to convince. Take the case of the exports and the marriage rates cited above. Hundreds of instances might be adduced from English statistics in which a rise in the per capita exports has been followed by a rise in the marriage rate. Yet no one believes that a mere increase in exports would cause an increase in marriage. Both are evidently the results of a single cause—active business, etc. Brisk trade, high wages, constant employment, etc., stimulate marriage and show themselves usually in an increased volume of exports, yet if commercial prosperity at any time increased without stimulating exports, we have every reason to believe that the marriage rate would rise irrespective of exports. And in less developed countries where trade and commerce are relatively unimportant no con-

nection is observed between exports and marriage. The great difficulty of induction in economics is due to the complexity of economic phenomena: we are seldom able either to bring about a satisfactory experiment or to secure a sufficiently diverse number of instances of agreement. Current literature is full of sweeping generalizations based upon far less agreement than that observed between marriages and exports. The twenty-five years preceding the repeal of the corn laws in England were, on the whole, far less prosperous than the twenty-five years which succeeded the repeal; *ergo*, concluded many writers, free trade would be advantageous to every country of the world. On the other hand, the method of agreement has been equally abused. Because the creation of the great modern European monarchies was in most instances accompanied by protective tariffs, colonization schemes, and a certain harshness and brutality toward strangers, therefore, concluded the extremists of the German Historical School, it is not only expedient, but ethically right, that the German Empire in the last half of the nineteenth century should start in with protective tariffs, colonization schemes, and the policy of the mailed fist. To-day it is universally conceded that both methods must and should be used wherever possible.

OTHER METHODS. In actual practice a large number of complicated combinations of the deductive and inductive methods are used in economics. Induction in its quantitative aspect gives rise to the statistical method. No school of political economy has ever disputed the importance and value of statistics, and in the last few years it has made more rapid progress perhaps than any other branch of the science. This is due to the increased public expenditures in statistical investigations, and the impetus given to the improvement of the study by such associations as the International Statistical Institute, the Royal Statistical Society, the American Statistical Association. So great has been the development of statistical technique at the hands of such men as Quetelet, Bertillon, Engels, Von Mayr, Edgeworth (to whom should be added from other sciences, Galton, Venn, Karl Pearson, etc.), that the technique of quantitative induction constitutes in reality a new branch of science. (See STATISTICS.) Deduction in its quantitative aspect gives rise to the mathematical method of political economy, which at the present time is employed to a greater or less extent in all branches of economic theory, particularly in the investigation of prices, incidence of taxation, etc. Opinions differ upon the usefulness of mathematics except in statistics. Mathematical diagrams for purposes of illustration, at least, have undoubtedly made a permanent place for themselves in the science, but the utility of algebraic mathematics, except for him who computes them, is doubtful.

See MERCANTILISM; PHYSIOCRATS; INTEREST; RENT; LABOR; FINANCE; SOCIOLOGY; PROTECTION; FREE TRADE; LAISSEZ-FAIRE; SOCIALISM; TRADE UNIONS; UTILITY VALUE; USURY.

BIBLIOGRAPHY. The most important works of the earlier English economists are: Smith, *Wealth of Nations* (London, 1776; many later editions); Say, *Traité d'économie politique* (Paris, 1803); Ricardo, *Principles of Political Economy and Taxation* (London, 1817); Malthus, *Political Economy* (ib., 1820); Mill,

Principles of Political Economy with Some of Their Applications to Social Philosophy (ib., 1848); Senior, *An Outline of the Science of Political Economy* (ib., 1850). Prominent modern general treatises are: Marshall, *Principles of Political Economy* (4th ed., ib., 1898); Nicholson, *Principles of Political Economy* (New York, 1893-1901); Ely, *Outlines of Economics* (New York, 1893); Wagner, *Lehr- und Handbuch der politischen Oekonomie* (Leipzig, 1883-1901). The new theories are best represented by Wieser, *Natural Value* (London, 1893); Boehm-Bawerk, *Positive Theory of Capital*, Eng. trans. (ib., 1892); Clark, *The Distribution of Wealth* (New York, 1899). The most important socialistic contribution to economics is Marx, *Capital* (London, 1887). Consult, also: Ingram, *A History of Political Economy* (New York, 1888); Ashley, *An Introduction to English Economic History and Theory* (London, 1888-93); Palgrave, *Dictionary of Political Economy* (ib., 1894-99).

POLITICAL OFFENSES. Acts which are considered as injurious to the safety of the State, or which involve a violation of the allegiance due from a subject or citizen to the supreme authority of a nation. Such offenses are to be distinguished from those which merely disturb the public peace, as murder, theft, and the like, and which do not strike at the Government itself.

Political offenses are now usually exempted from extradition treaties. However, England and the United States, to avoid international complications, have passed laws tending to prevent expeditions against foreign governments being fitted out within their territorial limits. The tendency in modern times is to deal leniently with political offenders. For example, although treason is nominally punishable with death in most countries, the sentence is now usually commuted to life imprisonment, as in the case of Col. Arthur Lynch, who was convicted of treason in England after the Boer War. See CITIZEN; EXTRADITION; GOVERNMENT; TREASON.

POLITICAL PARTIES. Voluntary associations or organizations of citizens for the attainment of desired ends or policies through united political action. They are found in all democratic States and all countries governed upon a constitutional basis, and are a necessary accompaniment of popular government. The Germanic nations, and especially those of the English branch, have always shown the greatest aptitude for political organization. The theory and general practice of parties among the Latin and other peoples which have followed the English race in the adoption of popular representative government is the same. Race characteristics and lack of training for self-governing institutions have, however, modified the party system in actual practice among these peoples. There is especially to be noted a tendency to split into personal factions until real issues and principles are lost sight of. The political groups in France and Spain illustrate this tendency.

Aside from local and temporary issues, there are certain natural lines of cleavage in political society which always have an influence in the composition of parties. The division between conservative and radical, with all the inter-

mediate shadings of belief, is as old as society, and underlies nearly all parties that are not mere personal factions. In the political philosophy of the world the nice balance between the conservative spirit that clings to that which is sanctioned by established usage, and the radical, progressive, or liberal spirit, which seeks modification of the old in the interest of progress, is most desirable. This end is somewhat imperfectly attained by the opposition of parties representing in some form the two ideals. This is the broadest and most universal idea that divides parties. In England, where the highly developed parliamentary government makes strong party organizations indispensable, they form almost a part of the government machinery itself, and have their chosen and officially recognized leaders by whom the party policy is voiced and directed. In other countries, although their influence upon the government is as important, their connection with it has less of an official character. Below is given a summarized account of party relations in the various European countries and Canada. Political parties in the United States are described under their historical names, as DEMOCRATIC PARTY; REPUBLICAN PARTY; WHIGS; etc.

AUSTRIA-HUNGARY. The strong national feeling on the part of different peoples embraced in the dual monarchy and the peculiar constitution of the Empire have aligned parties chiefly upon race lines. In Cisleithania are the Germans, constituting roughly one-third of the population; the Bohemians or Czechs, not quite one-fourth; the Poles, about one-sixth; several smaller Slavic groups; the Rumans; and the Italians. These are mutually jealous and antagonistic, and this fact determines the policy of the Imperial Ministry, which is, in general, to create its own party support by combining different race groups against the others. After the revolutionary movement of 1848 a period of absolutist reaction set in, which suppressed all political life for ten years. In 1861, after the failure of an attempt to reorganize the Empire on a federalistic basis, the Government proceeded to establish a constitutional system upon a basis of consolidation. In this reconstruction the aspirations of the Magyars were all but completely ignored. During the period between 1860 and 1867 the so-called Federalist Party stood for Conservatism in its strictest sense, and party government as distinguished from the Imperial policy can hardly be spoken of. After a suspension of the Constitution, the compromise of 1867 (see AUSTRIA-HUNGARY and AUSGLEICH) was arranged, establishing the present dual system. Under it party contests in Cisleithania have become more pronounced. The Germans are primarily divided into the Liberal and Conservative parties, the latter of which comprises Feudalists, bureaucratic, and, above all, Catholic elements. But the Germans present by no means a united front, even as against the pretensions of other nationalities. The Socialists represent, as in Germany, in great measure the aspirations of the liberal elements, while Christian Socialism has become but another name for the rampant party of anti-Semitism. Of late the anti-German attitude of the Catholic clergy has given impetus to the so-called "Los-von-Rom" movement, which has driven thousands of liberal Germans in Lower

Austria, Bohemia, Moravia, Silesia, and Styria into the fold of Protestantism and Old Catholicism. The nationalist groups or parties are the Czechs, Poles, Ruthenians, Slovenes, Italians, Croats, and Rumanians. Of these the most important are the Czechs. This group has its aristocratic and democratic wings, the Old and Young Czechs, who have united in recent years in a demand for the recognition of the Czech nationality through a union of Bohemia, Moravia, and Silesia as a kingdom, united with Austria only by treaty, as Hungary is, and not organically. The Austrian Slavs, with the exception of the Poles, are very friendly to Russia, while the liberal Germans naturally lean toward Germany. These are united with the Magyars of Hungary in common fear of Slavic domination. The political status of Cisleithania under these conditions is most unsettled. Its Reichsrat is notoriously disorderly, and thorough party organization is impossible. Self-interest and the popularity of the Emperor Francis Joseph II. are the two elements that keep the heterogeneous body together. For Hungary (Transleithania), see HUNGARY below.

BALKAN STATES. In the Balkan States—Bulgaria, Rumania, and Servia—pro-Russian and anti-Russian sentiment has had a principal share in the alignment of parties, especially in Bulgaria. In Bulgaria, before the union with Eastern Rumelia (1885), there were Radicals, who demanded union, and Conservatives, who were satisfied with the existing condition. After the union, in the face of Russia's bitter opposition thereto, the Radicals became anti-Russian. The Bulgarian Nationalists seek to unite all Macedonia under Bulgaria, and therein Bulgaria's interests clash with those of Greece. Rumania, of all this group of States, is the most settled in its political life. The parties are Conservatives and Liberals, the government of the parliamentary form, and the two parties have alternated in the Ministry. In Servia the parties are Liberals, who are pro-Russians; Radicals, who are pro-Austrians; and Progressists, who also lean to the side of Austria.

BELGIUM. The chief parties are two—Clericals or Catholics, and Liberals or anti-Catholics—and there are in addition the groups of Protestants and Socialists. The Protestants have slight influence in Parliament, and both these groups act with the Liberals against the Clericals. Until 1847 there was a struggle against the Crown to establish party government through a responsible Ministry. Since that year the Ministry has been taken from the majority in the Chamber of Deputies. The parties have alternated in control, but since 1884 the Catholics have held the Government and have gathered to themselves the conservative elements of society repelled by the growing political importance of the Socialists. In 1893 an active agitation resulted in the adoption of practically universal suffrage. Since that time the Liberal Party has virtually fallen under the control of the Socialists. The elections of 1902 resulted in a decided Catholic victory.

CANADA. Political parties worthy of the name made their first effective appearance after the War of 1812, in "a struggle for responsible government against the rule of an autocratic Governor and his Camarilla." Aroused by the political

monopoly and social arrogance of a group of royal officials known as the "Family Compact" (see CANADA, section on HISTORY), opposition took the shape of a Reform Party, under the leadership of Mackenzie, Ralph, Bidwell, and Baldwin, advocating an elective legislative council, reform in the administration of Crown lands, independence of the judiciary, popular control of revenue and the civil service list, and abolition of clerical reserves. The "Family Compact," rapidly enlarging into a Conservative or Tory party, under the leadership of Robinson and Strachan, was forced into a contest which resulted in a Reform victory in 1839. Under the new régime a responsible and liberal government was partially introduced, the Upper House being made elective, the Anglican Church disestablished, the clerical reserves secularized, and the University of Toronto thrown open to Nonconformists. Parties soon formed anew upon the question of "representation by population"—an attempt to remedy the unequal representations of Upper and Lower Canada as established in the Union of 1840. The Grits represented the aggressive elements, under the leadership of George Brown, and the Tories the opposition, led by Cartier and Macdonald. This new contest of parties, embittered by racial and religious differences, produced in 1864 a complete deadlock in Dominion politics and legislation. The situation was temporarily relieved by the formation of a coalition, a compromise Ministry under Macdonald and Brown, and the adoption of the much-agitated confederation of the provinces (1867). Confederation, however, soon produced new lines of party distinction rather curiously interwoven. Conservatism allied itself with Nationalism, and advocated the strengthening of the confederation. Liberalism affiliated itself with Provincialism, and decried undue interference in local affairs. In 1873-74 the Radical Reform Party succeeded in gaining control of political affairs; but in 1878, owing to its advocacy of free trade and the Conservative adoption of a 'national' or protective policy, it was again reduced to the opposition. From 1893 to 1896 the Liberals gained rapidly in popular favor. In 1896, under the leadership of Wilfrid Laurier, and by the union of their tariff policy with a radical opposition to federal interference in the noted school controversy of Manitoba, they succeeded in overthrowing the supremacy of the Conservatives. Under the new order the Manitoba school question has been settled, slightly to Liberal disadvantage; reciprocity has given way to a preferential tariff favoring England; a popular plebiscite in favor of prohibition has been disregarded, notwithstanding a prohibition plank in the Liberal platform of 1893; and labor difficulties promising in 1899 the formation of a labor party have been at least temporarily settled. The Liberals have succeeded in holding their own against the skillful opposition efforts of Sir Charles Tupper and the other Conservative leaders, carrying the elections of 1900 by decisive majorities and retaining their complete domination of the Dominion House. Much friction is introduced into Canadian politics by the race question, religious differences, and the fear or hope of American annexation. At present efforts are being made to form party lines upon the question of British imperialism, with disturbing factors in the recent

railroad and industrial combinations affecting both the United States and Canada.

DENMARK. Parties in Denmark took on a new formation after the cession of Schleswig-Holstein and Lauenburg, in 1864. Under the Constitution of 1866 the Diet was composed of two chambers, the *Folkething*, the popular representative branch, and the *Landsting*, consisting of twelve members, appointed by the King, and forty-four elected by voters possessing incomes of two thousand crowns. The Liberal-Nationalist Party, which had opposed the cession of the duchies, became a conservative landholding and official class party, controlling the *Landsting*, while the masses, represented in the *Folkething*, stood in opposition and themselves divided into the Moderate Left and the Democratic Left. An endless dispute arose over the budget between the Houses, the Democratic Left, controlling the *Folkething*, refusing to admit the veto of the *Landsting*. The Democrats lost their majority in 1891, but the conflict between the chambers is repeated when important issues arise, although of late the King and the Conservatives have practically managed the government.

FRANCE. The French Revolution, by the impulse that it gave to the growth of democracy, introduced political parties in Continental Europe. (For the revolutionary parties in France, see the articles FEUILLANTS; GIRONDISTS; JACOBINS.) With the Restoration there appeared the two monarchist parties—the Constitutional Monarchists and the Ultra Royalists. (See CHAMBRE INTROUVABLE.) There were also the Doctrinaires, Republicans, and Bonapartists. With the accession of the House of Orleans in the person of Louis Philippe, French parties underwent a readjustment. The existing monarchy was opposed by Legitimists, who sought the return of the elder Bourbon line; Bonapartists, who would have restored the Napoleonic régime; and Republicans. The Orleanist monarchy was overthrown, apparently by the Republicans (see FEBRUARY REVOLUTION), but the Bonapartists became dominant after the coup d'état of December 2, 1851. (See NAPOLEON III.) From 1852 to 1860 the Emperor exercised almost autocratic power, and politics were dormant so far as popular parties and parliamentary life were concerned. Later he lost the support of the Catholic clergy by his Italian policy, and was compelled to turn more to the Liberals. He thus reopened the active political life of France. Republicans, Orleanists, and Legitimists at once formed an Opposition. Parliamentary action was renewed. A Liberal Imperialist party supported the Emperor, but opposed his Ministers. Upon this party Napoleon depended to maintain the Empire against the Royalist and Republican coalition in 1869-70. The French defeat in 1870-71 (see FRANCO-GERMAN WAR) overthrew the Empire and presented the Republicans their opportunity. When the Third Republic rose upon the ruins of the Second Empire, the Republicans, although a minority party, found themselves in control of affairs through the lack of harmony among their opponents. Each of the three monarchical parties—Legitimists, Orleanists, and Bonapartists—recognizing its own inability to control the situation, was willing to have the Republicans temporarily in power, hoping that the next turn of the political wheel would bring in its own particular type of monarchy. In the first National

Assembly the Royalists and Bonapartists made up the reactionary Right and, united, were in a majority, while the Republicans themselves were made up of numerous and often discordant groups. There were the Extreme Left, which had few members, but a large following outside the Assembly; the Left, by far the largest group; and the conservative Left Centre, which gradually gained supporters among the moderate or constitutional monarchists of the Right Centre. Thiers (q.v.), the first President, was a constitutional monarchist who regarded the Republic as a political necessity. The Ministry was a conservative one made up from the Left Centre. The acceptance of this moderate leadership was an encouraging sign, but all unity disappeared as soon as the German occupation ended. The radical strength in the Chamber increased, and in response to its demands the Ministry was modified. The united Right was able to pass a vote censuring the change in the Ministry, and Thiers resigned, whereupon Marshal MacMahon (q.v.) was elected President as the candidate of the Right (1873). He at first appointed a coalition Cabinet from the three monarchical parties. The Right was united only in opposition to the Republicans, and the groups of the Left likewise united solely for the purpose of opposing the Government. MacMahon's term of office was made seven years (the so-called septennate). For a year and a half the different aims of the factions on both sides of the Assembly prevented action on the Constitutional Laws. In June, 1875, fearing the growth of the Imperialist strength, some of the constitutional monarchists united with the Left to secure the passage of the laws.

The Assembly created by the new Constitution consisted of a Senate and a Chamber of Deputies. The Constitutional Laws recognized the sovereignty of the people, represented in the Chamber of Deputies, and established the right of public meeting; the liberty of the press, and universal suffrage. The Republicans, with a large majority in the Chamber, forced the fighting. They were divided into the Left Centre, Republican Union (the largest group, led by Gambetta), and the Radical Left. The Monarchists, adopting a conservative attitude, were grouped as Right Centre, Right, and Popular Appeal. MacMahon in 1876 made up a Ministry from the Left Centre, at first under Dufaure (q.v.), later under Jules Simon (q.v.). In 1877, after a year of struggle against radical measures, acting under the advice of his conservative friends, MacMahon dismissed the Simon Ministry, adjourned the Chamber, and then, with the consent of the Senate, dissolved it. The Conservatives then sought to intrench themselves in the Government through the power given to the President and Senate by the Constitutional Laws, but the President had by his course opened a bitter struggle which destroyed any possibility of harmony. The Republicans won the elections, refused to recognize a Conservative Ministry, and finally forced the President to form a Ministry from the Left Centre. In 1878 the Republicans obtained a majority in the Senate, and MacMahon, unwilling longer to maintain the conflict, resigned in 1879, and was succeeded by Grévy. Their supremacy once established, the Republicans renewed their factional struggles. The Left Centre lost its influence. Gambetta's Republican Union was opposed by a growing

Radical wing, which reproached Gambetta with opportunism. A series of Ministries tending toward radicalism followed. A period of personal politics was entered upon, with Ministries combined for expediency rather than as exponents of political principles, fourteen different Ministries holding office between 1878 and 1888. The two principal wings of the Republicans came to be known as Opportunists and Radicals. The Legitimists united with the Orleanists in 1883, and two years later an increased number of monarchists were returned to the Chamber. An attempt was made in the face of this growing Conservative strength to unite the Opportunists and Radicals (policy of Republican concentration). The pretenders to the throne were banished in 1886 at the instance of the Concentration Ministry. In 1887 the Rouvier Ministry adopted the so-called policy of conciliation, which aimed at a coalition of Conservatives and Opportunists against the Radicals. In the same year General Boulanger (q.v.) came into prominence and sought to profit by the prevailing political confusion. His shibboleth, 'revision of the Constitutional Laws,' won support from all of the dissatisfied factions. His party was known as the Revisionist or National Party. The support of Boulanger by the Catholic Conservatives alienated his Radical followers, who joined the Opportunists to defeat him. In 1889 the complete overthrow of this political adventurer was accomplished. This victory was important evidence of the growing strength of the Republic.

A marked change in parties now began. The Republicans who had united to defeat Boulanger continued to act together as Moderates or Government Republicans. The monarchist parties were all weakened and discredited by their participation in the Boulanger episode. Radicalism came to be more and more represented by the Socialists. This body, hitherto of slight importance, had its origin in the break-up of the Republicans during the struggle against the July Monarchy, those who continued to uphold Republican principles seeking a purely political revolution, while a party of workingmen and theorists sought to make the Republic a means of radical social reform. In the succeeding years the ideas of the Socialists frequently found expression in the demands of the Radicals. In 1890 there were four Socialist groups, with views more or less extreme, and increasing political activity. A change that greatly strengthened the Moderates was the gradual cessation of clerical opposition to the Republic. Many Catholics who had formerly acted with the reactionary parties now came to the support of the Government under the name of *Ralliés*, or the Constitutional Right. A protective tariff with maximum and minimum rates was enacted in 1892; otherwise there was very little positive legislation during this realignment of parties, and the Freycinet Ministry (1890-92) enjoyed a hitherto almost unprecedented term of office. In 1892 there was a startling exposure of the use of enormous corruption funds in promoting the Panama Canal scheme. Over one hundred Senators, Deputies, and officials were implicated, including many political leaders, but even in the face of this the Moderates gained largely in the elections of 1893. The policy of concentration was discarded, and the Moderates took full responsibility, with Casimir-Périer (q.v.) at the head of the Min-

istry. The murder of President Carnot in 1894 was followed by the election of Casimir-Périer as his successor and drastic measures against anarchists. The new President and his Government were violently assailed by the Socialists and Radicals for their policy, the Dupuy Ministry went down in 1895 before the Opposition attacks, and then Casimir-Périer resigned the Presidency. Felix Faure (q.v.) was elected President by a union of the Moderates and the Right, but the Socialists, who had supported Brisson, had shown a significant increase of strength. The first Moderate Cabinet (Ribot) gave way in a few months to one much more Radical (Bourgeois), but the latter, after a struggle with the Senate, was succeeded in 1896 by another Moderate Ministry (Meline). The Dreyfus case (see DREYFUS) complicated French politics for three years, and even endangered the Republic. The Meline Ministry, which depended on the support of the Right, came to an end in 1898. A Radical Ministry under Brisson wrestled unsuccessfully for a few months with the Dreyfus case. A new coalition Cabinet was then organized by Dupuy. On the death of President Faure, in February, 1899, Emile Loubet (q.v.) was elected to the Presidency, and in June a new Ministry was made up by M. Waldeck-Rousseau. A Radical Socialist, M. Millerand, was included in this Cabinet. The Government took positive measures to put down the revived Nationalist agitation, imprisoning several of the old Boulangists, who had resumed their activity. An amnesty bill in 1900 purged all who were connected with the Dreyfus case. While the Government thus tried to still the strife which had injured France, it did not hesitate to bring on a conflict with the Catholic Church. This was done by the introduction of the so-called Associations Bill, regulating the privileges and rights of property of certain associations. This measure, while general in its terms, was ostensibly intended to bring within control of the common law the Jesuits and monastic communities, which had no authorization from the State, held large amounts of property, conducted numerous schools, and were directed to a great extent from outside of France. Notwithstanding Papal warnings and severe criticism at home, the measure was carried by a good majority in March, 1902, and in April the long-lived Waldeck-Rousseau Administration went to the people on its record. The result was the election of 382 Ministerialists and but 196 of all the opposition factions. After this vindication of his policy, the Premier retired and was succeeded by M. Combes, who continued his predecessor's policy and unsparingly enforced the Associations Law. When the first excitement had passed, it became evident that the Government had a powerful legislative and popular backing. A supplementary measure in March, 1903, practically refused the conduct of schools to the religious Orders, on the ground that their tendency was un-republican. This action pointed to a growing separation of Church and State in France, and the development of parties indicated the consolidation of the Republic and a more radical political condition.

GERMANY. The national parties in the German Empire have their source and their local counterparts in the separate German States. Bismarck carried his earlier measures by means of the support of a patriotic nationalist party, the

National Liberals, whose chief idea was the creation of German unity, and who were willing to support the Chancellor, although they did not wholly approve of him. He was also supported, with more enthusiasm, by the Free Conservatives (*Reichspartei*). He was opposed by the Old Conservatives, who clung to the old particularistic régime, and by the Progressists (*Fortschrittspartei*), who rejected all compromises and were the radical wing of the Nationalist Party that preceded the formation of the Empire. The *Kulturkampf* (q.v.) encouraged the growth of another strong opposition party, Ultramontane Catholic, known as the Centre. This had its strength in the Catholic States of South Germany and in the western part of Prussia. This party since 1893 has been the strongest single group in the Empire. It elected 100 members of the *Reichstag* in 1903. Bismarck, before his retirement, in view of the falling away of his old National Liberal support, had turned to the plan of a coalition between the Conservatives and his old enemies of the Centre to obtain support for the Government. The Social Democrats follow the Centre in point of numbers (82), then come the Conservatives (53), National Liberals, Radicals (*Freisinnige*), the Free Conservatives, the Anti-Semites, and a few lesser factions. The Polish elements form a strongly hostile Nationalist group. The predominance of Prussia in the Empire gives Prussian politics an overshadowing influence, and the Agrarians, who are primarily a Prussian landholders' party, opposed to the present commercial policy of the Government, and desirous of extreme protection against the importation of foodstuffs, control the Conservative members entirely, the Centrists to a great extent, and have a strong hold among the Poles and Anti-Semites. The Government is thus forced, on some of its favorite projects, to look to the Liberal groups for its support. The Agrarians were strong enough to defeat the Emperor's Rhine-Elbe canal project in the Prussian Landtag in 1899, arousing thereby very bitter feeling. This strong Agrarian agitation is a most important complication in the already complex party situation in Germany. In the Parliamentary elections of June, 1903, the Socialists polled a vote hitherto unequalled in strength.

GREAT BRITAIN. The four chief political parties in Great Britain at the present time are the Conservatives, the Liberals, the Irish Parliamentary or Home Rule Party, and the Liberal-Unionists. The Conservatives and the Liberals are the lineal descendants of the old Tories and Whigs, and although their political ideas are far more advanced than those of their predecessors, they maintain relatively the same attitude toward the questions of the day. The professed policy of the Conservatives is the maintenance of the Empire, the preservation of the Constitution in its present form, the union of Church and State, and the general conservation of vested interests. The Liberal Party comprises the great majority of the Dissenters in England, and of all the voters in Scotland and Wales, but it is nearly always in the minority in England itself. Its policy is one of abstention from foreign complications, economy in expenditure, and reform in the Constitution. The Radicals, who form a wing of the party, desire disestablishment of the State

Church, manhood suffrage, free education, and the abolition of the House of Lords. The Liberal Party was divided on the question of the South African War in 1899-1902. The whole party opposed it in the beginning, and agreed in criticising the conduct of the war by the Government. But while the majority favored granting a liberal measure of home rule to the Boers, a Radical minority advocated the independence of the republics. The Home Rule or Irish Parliamentary Party was founded mainly through the efforts of Charles Stuart Parnell (q.v.), and is composed entirely of Irish members. It subordinates all other issues to that of Home Rule (q.v.) for Ireland, although it advocates immediate reform of the Irish land system and of Irish taxation, and is in favor of the establishment of an Irish Catholic university. It has acted with the Liberals since 1886, and violently opposed the Boer War. The Liberal-Unionists separated from the Liberals in 1886 on account of Gladstone's advocacy of home rule. Since that time they have acted with the Conservatives, their leader, Mr. Joseph Chamberlain, becoming the most pronounced advocate of an aggressive foreign policy and of the unconditional subjugation of the South African republics. In the general elections for Parliament held in October, 1900, 334 Conservatives, 186 Liberals, 82 Home-Rulers, and 68 Liberal-Unionists were returned. For the development of English political parties, consult: Cook, *History of Party from Charles II. to the Reform Bill* (London, 1836-37); Kebbel, *History of Toryism, 1783-1881* (London, 1886); Kent, *English Radicals* (New York, 1899).

GREECE. There has never been in Greece a division of the voting population into great parties on great political issues, but in modern Greece, as in ancient Greece, the grouping has been rather that of factional followers of some strong political leader. In the frequent change of its ministries Greece bears a striking resemblance to France and Italy, and, as in those countries, the change has very seldom meant a revolution in policy. For the greater part of the decade 1880-90 the so-called parties grouped themselves around two leaders, Tricoupi and Delyanni, from whom were derived the names Tricoupiists and Delyannists. In the general election of 1890 part of the Delyannists—then the opposition party—broke away from their former political associates, and under the leadership of M. Ralli formed a new party organization known as the Neo-Hellenic or Young Greek Party. M. Tricoupi died in 1896, and the leadership of his faction fell to M. Theotokis. His followers, called both Tricoupiists and Theotokists, represent the more conservative tendency in Greek politics. In 1901 a new political group formed about M. Zaimis, who became Premier in that year. The parliamentary strength of the three factions in 1902 was given as: Delyannists, 82; Theotokists, 75; and Zaimists, 46.

HUNGARY. Hungary presents the interesting example of a country with a parliamentary form of government in which a single political party has retained uninterrupted control for upward of thirty-five years. This party is the Liberal Party—the party of Francis Deák and Koloman Tisza, whose able leadership has been a strong factor in its continued success. During the rule of the party of Deák, which began with the suc-

cessful passage of the *Ausgleich* of 1867 and lasted until 1875, the opposition consisted of a party of radical Magyars who refused to accept the compromise, but who were in all other respects Liberals, and of a small group of Rumanians and Slavs whose opposition was racial. After Deák's withdrawal from public life in 1875 this radical Magyar party, under Tisza, who became Premier, united with Deák's followers to form the Liberal Party of to-day, which has since continued in control. The Premiership of Tisza himself lasted from 1875 to 1890. During this period the principal opposition came from a small but earnest body of radicals known as Kossuthists, followers of the younger Kossuth, who contended that the only bond of union between Austria and Hungary should be the personal one of the sovereign. This faction has been represented by as many as 90 Deputies in the Parliament. The principal reason for the absence of two great political parties in Hungary, however, exists in the presence of the subordinate races—chiefly the Croats and Slavonians. It is their presence which tends to force the Magyars to act in concert, and although in parliamentary affairs they take practically no part, they constitute the real political opposition.

ITALY. There is no well-defined party organization in Italy. For fifteen years after the death of Cavour in 1861 the Government was directed by a Ministry from the Constitutional Right or Conservative side of the Chamber, but after 1876 the Liberal Left came into power, and the Right almost disappeared. The Left has been largely dominated by radical elements. Its accession to power marked the domination of the southern Italians in politics and the era of personal groups or factions without other guiding principle than that of political or financial self-interest. Republican and Socialist groups have also played a part in Italian politics. A peculiarly Italian party is that of the Irredentists, who seek to unite with Italy the Italian portions of Austria, Switzerland, and France, or unredeemed Italy (*Italia irredenta*). A serious embarrassment in Italy since the union has been the abstention of good Catholics, under direction of the Vatican, from participation in politics.

JAPAN. Political parties in Japan, in the modern sense, can be said to date practically from the promulgation of the Constitution in 1889, although the political groups from which they were formed have a somewhat earlier beginning. In their origin they are developments of the four old clans (Satsuma, Choshu, Tosa, and Hizen), and their division was fixed by clan jealousy and not by political issues. The Satsuma and Choshu clans were more closely allied to the Emperor and more aristocratic in their tendencies than the other two. Their members formed a group which is particularly strong in the Upper Chamber of the Diet, and has played but little part as a party organization in the general elections. Their influence has been felt largely through their great leader, Marquis Ito (q.v.). They have been called Constitutional Imperialists. From the Tosa clan was formed the Liberal (Fuyu-to) Party, and from the Hizen clan the Progressive (Shimpo-to) Party. By the Constitution the Ministers are dependent on the sovereign by whom they are appointed, but in reality the tendency, often interrupted since 1890,

has been to make them more and more dependent on the Parliament. The result has been a curious succession of partisan and non-partisan Ministries. But the organization in 1902 by Marquis Ito of the *Seiyu-Kai*, or Constitutional Political Association, which practically amounted to an amalgamation of the old Liberals, and the more progressive of the aristocratic Constitutional Imperialists seemed to indicate a formation of parties on new lines, and to be a practical recognition by the representatives of the old nobility of the necessity for party government.

NETHERLANDS. The history of political parties in the Netherlands has been an uneventful one, due largely to the fact that during the greater part of the last half-century the Liberals have been in almost undisputed control of affairs. There have been, however, infrequent overturnings of their régime, brought about generally by a temporary coalition of the opposing group. The most recent revolution of this sort took place in 1901. The Catholic Party has for many years formed the most compact and well-organized group of the opposition, but its refusal to participate in coalitions had rendered its opposition of little effect. The last few years, however, have been marked by a remarkable growth in the power of the Orthodox Protestant Party or Anti-Revolutionists, who for some time were satisfied to take only a passive part in political affairs. This party, which fears Liberalism more than Catholicism, under the leadership of Dr. Abraham Kuyper (q.v.), finally effected a coalition with the Catholics, and in the elections of 1901 achieved a striking victory over the Liberals, who were weakened by dissensions and by a reputed alliance with the Socialists. A Clerical Anti-Liberal Ministry was formed in which the Catholics were given three portfolios. Other parties represented in Parliament, but with little real power, are the Historic Christians, Radicals, and Socialists.

PORTUGAL. Between 1834 and 1852, the old Absolutist party having become extinct, the Liberals, who had successfully opposed the Absolutists, divided into two parties, the Chartists, who supported the strongly monarchist charter of 1826, and the Septembrists, who rallied around the popular Constitution of 1822. A coalition of Septembrists and Chartists, known as Regenerators, took control of the government in 1852, but this coalition soon broke up and the Historic Left was formed from its remnants and merged in 1877 with a new Reformist party, as Progressists. The Regenerators now form the Right, or conservative section; the Progressists the Constitutional Left. There is also a small but active and growing Republican Party, formed in 1881.

SPAIN. Spanish parties have been in a state of confusion ever since the beginning of the struggle for constitutional government. During the first third of the nineteenth century the struggle between absolute monarchy and constitutionalism brought into existence different parties maintaining all gradations of political opinion from absolutism to radicalism. After 1833 the dynastic parties of Carlists and Cristinos arose. (See CARLOS, DON; SPAIN.) There were also two Liberal parties—Moderates and Progressists. These parties disintegrated about 1850-51 and new temporary combinations were formed. The revolution of 1868, which overthrew Isabella II., was

followed by a struggle between Republicans and Monarchists which, after the resignation of King Amadeus in 1873, resulted in the short-lived republic under Castelar. In 1874 the monarchy was restored, and in 1876 the new Constitution gave opportunity for a new alignment. Under this there were two constitutional monarchist parties—the Conservatives, made up chiefly of the clergy and aristocracy, and the Liberals (Constitutionalists or Dynastic Left). In addition to these two true political parties were the Carlists, who were irreconcilable absolutists, the Republicans, and the Possibilists (a name having much the same meaning as Opportunists in France). The Republicans have an increasing strength in Spain. For many years Cánovas del Castillo and Sagasta, the respective leaders of the Conservative and Liberal parties, had been alternately in power. Just before the war with the United States Sagasta (q.v.) and the Liberals again took the helm. The peace negotiations brought the Conservatives once more into power, but the administration was a troubled one. Spain has, in fact, since 1898 entered upon a course of readjustment to new conditions which has its effect upon the parties.

SWEDEN AND NORWAY. The Scandinavian dual monarchy really comprises two distinct nations with one King and a common administration for war and diplomacy. Each has therefore its distinct national politics. The parties in Sweden are the aristocratic Conservative Party, forming the Parliamentary Right, and having its strength in the cities; and the rural Democratic Party, the Parliamentary Left, known as the Rustics. In recent years an urban Democratic Party of decidedly radical tendencies has arisen. The Socialists, organized as a party in 1889, joined the Democrats and a demand was made for universal suffrage. Norway is the most democratic country of Europe socially and, except Switzerland, in its political constitution. For many years the Democratic majority in the Storting was in conflict with the King and his Ministers, chiefly over the budget. In 1872 an attempt was made to secure a responsible Ministry from the Parliamentary majority. In 1884 the King yielded and at first attempted to form a Conservative Ministry, but was obliged to call upon the Left. In 1886 the Left split into the Old Left and the New (Liberal) Left. The conflict that ensued brought out three parties—Conservative, Ministerial, and Radical, the second being due to the attempt of the Prime Minister, Sverdrup, to hold his position in spite of party defeat. A Conservative Ministry was formed in 1889. At the same time a nationalist agitation began and grew to large proportions. The Conservatives were defeated in 1891 on a bill to regulate the relations between Sweden and Norway. The Radical became a nationalist party. This agitation in Norway, threatening the union, developed a counter-movement in Sweden, so that practically a Norwegian and a Swedish party have arisen in the combined monarchy.

SWITZERLAND. There is no party government in Switzerland and no party machinery, such as is necessary in countries where there is party government. Minority representation is responsible for this. There are parties, however. The political history of the present confederation begins in 1847, when the Radicals triumphed over the Cath-

olic Sonderbund. Moderates, Radicals, and Catholics were thereafter the parties that appealed to the suffrages of the people. The two former divided at first on the attitude of Switzerland toward the revolutionary movement elsewhere; then on railroad development, and other questions. In the struggle over constitutional revision from 1864 to 1874 revision was opposed by the Ultramontane Catholics, and by the French and Italians, who feared the domination of the German cantons. After the revision there were new adjustments of party relations. The Vatican decrees of 1870 were opposed by a body of Swiss Catholics, who rejected the dogma of Papal infallibility. They were known as Old Catholics and their recognition by the Swiss Government as the true Catholic body precipitated a contest with the Vatican and the Ultramontane Swiss Catholics. The Ultramontanes or Clericals, the legislative Right, became a strong and aggressive political body. On the other side the Radicals form the Extreme Left, believing in the absolute severance of both Protestant and Catholic churches from politics. The Radicals differ in their attitude on questions outside of Church matters, the French being opposed to the national centralization which is sought by the Germans. The Centre, or Liberal Conservative party, is far from homogeneous and united. It is made up mainly of the conservative moneyed classes. A Catholic People's Party was formed in 1894. Socialist party movements, although many have been set on foot by foreigners who have found asylum in Switzerland, have not flourished on Swiss soil, but the Grütliverein, a society founded in 1838 on a democratic basis, has been gradually adopting socialist ideas.

Consult: Seignobos, *A Political History of Europe Since 1814*, trans. by S. M. Macvane (New York, 1900), a very useful compendium of European political history; Lowell, *Governments and Parties in Continental Europe* (2 vols., Boston, 1897), an invaluable and thoroughly scientific examination of the political systems of Austria-Hungary, France, Germany, Italy, and Switzerland; Rohmer, *Doctrine of Parties* (1844); Woolsey, *Political Science* (2 vols., New York, 1886). See the sections on the government and history of the different countries, to which the history of parties closely relates itself.

POLITICAL SCIENCE. That branch of the social sciences which deals with the organization and life of the State. It comprises the consideration of the general problem of the origin and nature of the State; investigations into constitutional forms, political forces, and modes of public administration; and the attempt to establish sound rules and maxims of political action. The characteristic feature of political and legal, as distinguished from purely social, facts lies in the presence, in connection with the former, of a definitely organized personal authority endowed with determinate functions and enforcing its decrees by a fixed sanction.

In the original Greek sense 'politics' refers to the entire art of realizing the ethical ideal in the State by the establishment and maintenance of orderly government; but in modern times this term is often used in a much more restricted sense. The characteristic political fact, according to the modern usage of language, is the struggle for personal authority in an organized community, as well as the struggle for the maintenance

of the power of the whole State. The definite organization of power for the purposes of orderly government, the marshaling of popular support and of popular opinion, the creation of centres of control, and the defense of the entire structure of the State against attacks from without and from within—these constitute the characteristic problems of politics in the narrower sense. Whenever we deal with the dynamic facts of State life we therefore have primarily 'political' considerations. This is the case in such subjects as diplomacy and international politics, party politics, and all the creative activities of the government. In this sense it is a political action to appeal to voters and to organize them into parties, to advance the candidacy of certain persons for office, to create a willingness for effecting changes in the law, or to obtain treaty advantages from foreign powers.

But State life may also be viewed as static—established in certain permanent forms and administered according to fixed rules. Here the conditions of political struggle for power and advantage are almost entirely eliminated and the State is looked upon as a commonwealth administered for the benefit of all citizens. The studies of public law (international, constitutional, and administrative), jurisprudence, and the technical methods of administration belong under this heading. They deal with State life as settled, as administered only by expert authorities and not immediately affected by the popular struggle for political power. By analogy this group of studies may be said to deal with the anatomy of the State, while the dynamic studies deal with its physiology.

Though the fundamental fact of political struggle will always remain the chief characteristic of politics, it must also be noted that the sphere of static institutions is constantly expanding as the State develops in civilization. In the earlier ages the struggle for power swallowed up all available energies, and all considerations were subordinated to the political success of competing groups. Administration was viewed merely as the opportunity of the ruling group to fortify its position and to enjoy the fruits of power and influence. Even the 'benevolent despotism' of the eighteenth century held that the chief reason why the prosperity of the lower classes should be protected was to maintain their value to the Government as taxpayers. In an absolute monarchy the intrigues among contending factions seeking royal favor usually absorb the entire attention of the political classes, leaving but little to be devoted to the administration of the commonwealth. Now although a system in which political struggle would be entirely eliminated is perhaps inconceivable, the ideal of a commonwealth demands that the ordinary administration of the State be placed as much as possible outside of the sphere of personal struggles for political power. For this reason the civil service should be rendered independent of political changes and an expert administration placed in charge of the current affairs of the commonwealth. Among the practical problems of politics at the present time there is none more important than the question as to how far the political representatives of the citizens—the parliamentary body—can profitably control, and interfere with, expert administration. While the sphere of parliamentary interference and control over the adminis-

trative departments may seem to be contracting, this is not to be taken as a sign of the absolute failure of parliamentary government, but as an indication that the development is toward a more perfect adjustment between the popular or political and the expert agencies in government.

Above the two aspects of political dynamics and statics, and embracing them both, there stands political theory or political philosophy, which deals with the general problem of the nature of the State. Viewing the State as a universal form of human association, it attempts to analyze the principles upon which its authority rests and according to which its functions are performed. Closely allied to it is the subject of political ethics, which tests the ideals of State forms and of political action. Among the Greeks these various aspects of political thought were not dissociated; politics were considered as the means of giving practical form and existence to the true ethical ideals. The Hellenic sense of concrete vision, however, guarded against a confusion of existing institutions with the ideal schemes of philosophical discussion. This distinction was not kept clear in the Middle Ages, and in self-defense the modern school of political science, following Machiavelli, has striven clearly to distinguish the actual from the ideal.

THE PURPOSES OF POLITICAL SCIENCE. The primary purpose of political science is the understanding of the general laws of State life. This, however, does not involve the tracing back of political institutions to primal impulses in animal life and to dominant influences exerted by inanimate nature, a work which sociology and social psychology are attempting to do. Political science takes interest, motives, and purposes as it finds them, investigates their relations to each other, traces their mutual influence, and studies the political actions and institutions created by them. Thus in a modern State it will investigate the grouping of interests in parties, observe the leading personalities who embody the purposes of large groups of men, and study the methods through which these purposes are expressed in legislation and realized through administrative action. The necessity of a scientific basis for all political study would not seem to be in need of emphasizing. Without it the doors are thrown wide open to artificial construction, vague generalization, and the gradual sterilizing of originally fruitful concepts through mechanical repetition. Political science must constantly draw new life from the facts of history and of contemporary action.

The second purpose of political science is the understanding of the forces, forms, and practices of contemporary political life. Although the aid of history is essential toward a thorough understanding of contemporary institutions, a minute analysis of their actual workings is equally indispensable in political science. This need not be purely empirical, but by the comparison of modes of action in various States a basis for scientific induction and generalization will be furnished. This purpose will therefore best be achieved by the combination of two methods—the detailed analytical study of institutional forms and administrative technique in any one nation and the comparison of the results thus obtained with institutions and practices in other States.

A third object of political science consists in

the formation of political purposes and in providing a basis for political action. Far from involving merely *a priori* reasoning about human nature and about the actions proper to it, this pursuit is concerned with the establishment of practical conclusions upon the basis of wide and accurate information. Practical life, however, differs from history and sociology, where the investigator in his study of the connection of facts is led on along a seemingly endless chain of causation. Here resolutions have to be formed and action taken before the basis of induction is complete. In this aspect politics is an applied science—both normative and teleological—which determines the best mode of political action upon the basis of the most complete scientific information procurable.

RELATION OF POLITICAL SCIENCE TO OTHER FIELDS OF KNOWLEDGE. The relation of politics to the general science of society has already been indicated; its field is more restricted and the character of its methods teleological rather than causative. (See SOCIOLOGY.) The difference between the purposes and methods of sociology and of politics might be further indicated by considering how either would treat the career of a statesman like Lincoln. The science of politics would study the principles and purposes embodied in his character in a concrete manner; sociology, on the other hand, would attempt to trace these composite factors back to their ultimate causes, and, passing beyond the energies manifesting themselves in the political struggle, would probe into their psychological and physical origins. The relation of politics to *psychology* also is that of a teleological to a causative science. All political institutions may be looked upon as psychological facts having their existence only in the mind, although they may be of the greatest tenacity and are in turn productive of concrete facts such as public buildings and improvements. But psychology, like sociology, is a causative science, going back of the purpose or concept with which politics starts, and trying to investigate its psychic and physiological origins. The science of *economics* deals with a different set of social phenomena, which, however, have the closest bearing upon politics. Not only is political influence largely determined by economic power, but the constant interference of political agencies with economic interests and processes makes it necessary for political science to give special attention to economics. The field of *history*, like that of sociology, embraces political action together with the other manifestations of social life. But history differs specifically from politics in that its purpose lies in tracing individual chains of causation, whereas politics, by the use of the comparative method, establishes broader generalizations. The science of *statistics* furnishes a basis of induction for all the social sciences. Both in the study of the composition of political forces and of the results of political action regarded as experiments, the aid of statistics is indispensable. The knowledge of the material body and of the physical basis of State life is furnished by the sciences of *ethnology* and *geography*, the results of both of which form the most essential data of political science. Among the other natural sciences *physiology* and *biology* are of special importance to political science. Although the similarity of the life processes in the State and in the physical organism have been

exaggerated in the organic theory of the State, the analogy of historic to organic development, as opposed to purely mechanical construction, will always remain valuable. The absolute identification of biological, social, and political laws of development is, however, being abandoned and is giving way to a tendency to view political phenomena under the aspect of psychological facts to be explained rather by the laws of association and imitation than by the principle of organic structure and growth.

THE METHODS OF POLITICAL SCIENCE. The scientific method of politics acquires its materials by the historic study of individual institutions, by the analysis of contemporary political life, by statistical investigation, and by the comparative study of institutions. On the basis of the facts thus secured it arrives by the process of induction at the general laws and principles of political action. The most distinctive features of this method are a sharp juristic analysis of institutions and the discovery of true analogies in different systems. By the application of this method the materials furnished by a number of auxiliary sciences are subjected to analysis and become the elements for a recomposition which results in a clear and definite grouping of social purposes in the form of political action. As the facts with which politics deals are much more definite than those of the general social sciences, and as political institutions and laws constitute, as it were, a precipitation of social forces, endowed with great permanence and solidarity, the study of political development will always remain the backbone of historical work. Although we need not accept Freeman's dictum that history is past politics, it may be said that historical forces are most clearly understood, although perhaps not completely fathomed, when seen from the point of view of the growth and succession of political institutions and laws.

The principal methods auxiliary to political science are the historical, the statistical, the experimental, the analytical, and the deductive method. Political studies have always drawn their material chiefly from the recorded history of mankind, and are therefore assisted by the technique of the historical method—the critical scrutiny of documentary evidence and the mastery of the laws of cause and effect. But although politics, as indeed every other social science, has thus to make use of historical material, its problems differ distinctly from those of history. It is the function of history to explain a succession of events and actions through the discovery of a causal relation. The function of politics, on the other hand, is to explain a given institution through an investigation of its origins as well as through comparison with similar institutions elsewhere. To history all the transformations of a given institution are equally interesting; to politics, only those which explain its present character. Thus in the study of the English parliamentary system of the present, political science need not give consideration to the original causes for instituting the British Parliament, as other causes have been substituted upon which the parliamentary régime is at present based. Therefore, in general, in a succession of substituted causes, political science would not go back of the causes directly operative in the institution to be explained, while to history the whole series of substitutions is important.

The statistical method furnishes much valuable and trustworthy material to political science; and for the knowledge of the physical body of the State population statistics and detailed accounts of the economic products are indispensable. Similarly the effect of certain modes of legislation and of political action can best be tested by a study of their numerical results; such as, for instance, the operation of the liquor laws and of laws to foster agriculture, irrigation, etc. But also the more specifically political activities may be approached by the statistical method, as when we study the attendance upon elections, the votes upon constitutional amendments, and the various groupings of political power. We must not, however, overlook the limitations of the quantitative method. An attempt to reduce political action entirely to quantitative form, and thus to trace it back to the working of physical causes, would result in failure, because the complex force of sentiment, sympathy, tradition, and of other psychological factors cannot be quantitatively measured nor reduced with exactness to quantitative causes in the physical world.

Scientific experimentation is not possible in politics, because we cannot use a society purely as a subject of demonstration. Moreover, we are not given the opportunity of studying the influence of any one cause by carefully excluding the operation of all others, as we may do in physical experiments. While, however, the scientific experiment pure and simple is by the nature of things excluded, practical experiments are constantly being made in politics, i.e. courses of action are tried without a knowledge of the exact results to be produced by them, but in the hope that certain improvements will be effected; as, for instance, in changes of the criminal law, or in the methods of nominating and electing public officials. Such action, although not undertaken purely as an experiment, is experimental in the sense that the nature of its consequences can be definitely ascertained only through experience, and that the action is undertaken with a knowledge of the possibility of varying results. Therefore, while politics as a science cannot set aside certain social factors for experimental purposes, as an art it is constantly making experiments in practice which in turn furnish the most valuable kind of material to scientific political study.

The importance of the analytical method has already been indicated above. As in the investigation of political and legal institutions the juristic bias is naturally very strong, there is constant danger in political science of resting satisfied with mere analysis of structural forms. A scientific method, while it must make use of the trenchant instrument of analysis, must also extend its range so as to embrace the real motive forces that lie back of institutional forms. The natural law theory has always favored a purely juristic interpretation of institutions, and the scientific study of politics has been much retarded by the one-sided use of analytical methods which lead to disputes about fine-drawn but unimportant distinctions, while apparent definiteness of the results obtained often causes men to overlook the powerful forces operating in political life.

The deductive method is thus explained by Professor Sidgwick in his *Elements of Politics*: "We assume certain general characteristics of social

man, and we consider what laws and institutions are likely to conduce most to the welfare of an aggregate of such beings." While this method is perfectly legitimate and has been fruitfully employed by most of the great political writers, it would be a mistake to suppose that it is the sole or even the principal reliance of scientific politics. In fact, if employed alone and unassisted by the study of concrete facts, it opens the door to hasty generalization and to the profitless expounding of threadbare theories. In itself it is sterile. It simply analyzes, develops, and applies certain facts assumed to be axiomatic. It takes on the subjective coloring of the writer's mind and it does not in itself furnish a stable basis for the scientific pursuit of political investigation. Politics is made a science through the use of inductive processes. The careful study of political experience and of the ever-varying forces of political life provides the rich harvest of observation upon which general principles and maxims may be founded with a certain amount of warranted assurance; and though it may not as yet provide a large number of exact generalizations and rules for practice, it still is recognized as leading to a fuller mastery than does deductive reasoning, by giving the mind an insight into the wealth of incident and the dramatic action of politics. The deductive method is of value in the matter of applying knowledge to political action, when after a careful study of political forces and institutions their general nature and operation is understood. Such knowledge may then well be applied by a deductive process to concrete political action.

THE BRANCHES OF POLITICAL SCIENCE. In accordance with the general division of political science which has been indicated above, we may group the various branches of the subject as follows:

Political Dynamics—

1. Diplomacy and International Politics.
2. Party Politics.
3. Comparative Legislation.
4. Governmental and Administrative Policies.

Political Statics—

1. Constitutional Law.
2. International Law.
3. Administrative Law and Technique.
4. Comparative Study of Institutions.
5. Jurisprudence.

General and Normative Politics—

1. Political Theory.
2. Political Ethics.

It would, of course, be impossible to deal with the living forces of public life without paying regard to the settled institutions, or, on the other hand, to investigate the latter without giving attention to the motive forces by which they are supported; and, no matter what subject in politics may be under consideration, generalizations belonging to political theory or ethics can never be excluded. While these various subjects are thus intimately interrelated, each of them nevertheless forms the centre for a group of specific considerations and preserves in the main its own point of view. But their mutual relations ought never to be overlooked. A study of the public law of any State without attention being given to political forces and their modes of action fails to convey a just conception of political life. In a State like the American Union, founded upon the theory of government by law deduced from a written

constitution, static and juristic facts are often placed unduly in the foreground. The discussions in the American Congress are usually given a juristic turn, so that, for instance, the consideration of measures dealing with economic subjects like the trusts will be based primarily on constitutional arguments. The greatness of such statesmen as Lincoln consists in their knowledge of the true motive powers and in their readiness when necessary to modify juristic principles so as to adapt them to the living forces of politics—"to throw the Constitution overboard in order to save the Constitution." International law and diplomacy similarly bear a close relationship to each other. Not only is the former largely a result of the efforts of the most enlightened diplomats, but its enforcement is always conditioned by the actual grouping of the various factors in international politics. The study of comparative legislation furnishes materials to general jurisprudence, and this in turn enables the legislator to secure greater harmony and a more effective structure in his legal enactments. Practical politics, while primarily founded upon the grouping of interests, cannot afford to overlook the principles of political theory which pervade the thought of the people and give direction to their action and to their enthusiasms. Political theory, on the other hand, should strive to be an expression of the cardinal facts of actual political life, and consequently the theory of democracy can no longer rest upon the original concept of an ideal state of nature. The intimate connection between practical politics and political ethics would not seem to need emphasizing, were it not for the fact that certain writers like Machiavelli have dissociated political considerations from ethical principles, and also that in the practical politics of the lower type but very little application of ethical motives can be perceived. Even the details of administrative technique have a close connection with dynamic politics, for often a method of action which seems thoroughly convenient, and indeed almost necessary from the administrative point of view, may be subject to grave objections when the political life of the State is considered.

THE LITERATURE OF POLITICAL SCIENCE. It has been intimated with some truth that politics has not as yet fully made good its claim to rank as a science, because political literature lacks that succession of effort which constitutes the progressive element in the natural sciences. In the latter an investigator will take up the work where his predecessor has left off. In politics there has been no such development by successive, long continued effort; any writer considers himself well qualified to contribute a valuable discussion on a subject with which all men of common sense are supposed to be competent to deal. In fact, some of the most famous writers on politics, such as, for instance, Locke and Rousseau, had no political or legal training whatever. In many cases great philosophers have aimed to give completeness to their general system of thought by constructing a part on political science, which is, however, in such cases usually composed merely of deductions from general theoretical principles.

The constitutional studies of Aristotle and the principles developed in his *Politics* form a sound basis for the science of the State; but, unfortunately, he had no successors to carry on the work in his spirit for almost two thousand years.

During the Middle Ages Aristotle exercised a profound influence upon scholastic philosophy, which followed his doctrines very closely. Machiavelli took up the thread, and on the basis of a keen study of political facts, both in the records of Roman history and in the life of his own times, constructed his principles of practical politics. His work is founded upon actual observation, but, like Adam Smith, he deals exclusively with certain definite human activities and characteristics to the exclusion of all others, and constructs for us the Political Man—animated solely by the will to gain political power. Jean Bodin lived in the thick of the religious struggles in France, and his work is a direct result of the need he felt for a definite basis of authority in the shifting circumstances of his time. His theory of sovereignty may be called the portal of modern political science, because it first clearly focuses all political action in the sovereign and places the source of political power within the State itself; but the theory is primarily juristic and has given rise subsequently, to many theoretical constructions which do not accurately express the forces of political life. Three of the great philosophers of the seventeenth century, Hobbes, Spinoza, and Locke, developed political theory as a part of their philosophical system; but, though starting from similar premises, they arrive at entirely different conclusions. The thought of their age was primarily mathematical, and their method is purely deductive, developing a system of political structure from a few principles assumed as axiomatic, in the manner of a theorem in geometry. The impulse which was given at this time to the mathematical sciences, and through them to the physical, led to an effort on the part of Montesquieu to explain the connection between political institutions and physical environment. Scientific in the sense of basing his results upon induction from facts, Montesquieu lacks the critical spirit of the Historical School and is often captivated by mere fanciful analogies. Burke has a scientific conception of politics in the sense of seeing in institutions a natural development and of basing his political principles upon a careful study of political experience; but he idealizes the past and looks upon the present rather with the eyes of the statesman who is defending certain forms of political life than in the spirit of the scientific investigator. Rousseau, Kant, and the entire Classical Liberal School, are all given to a *priori* reasoning; taking as their starting point the rational individual, they endeavor to construct a system of government in which his independence may be preserved. The fact that Rousseau's theory has by varying interpretations been made the basis of Liberalism, of democracy, and even of State socialism indicates the ease with which the deductive method may be used to produce any result desired.

In the nineteenth century a truly scientific method began to be applied to the study of political facts. Savigny, Maine, Ihering, Pollock, Maitland, and Judge Holmes have applied the historic method to institutional and legal facts. The careful observation and analysis of contemporary institutions has led to fruitful results in the works of De Toqueville, Bagehot, Bluntschli, Woodrow Wilson, A. L. Lowell, and Ostrogorski. Writers like Jellinek and Burgess, while juristic in their method, give careful attention to

existing State forms. Cornwall Lewis combines the scientific method of observation with a highly philosophical spirit. There has lately arisen a school of political scientists who apply to their writings the term sociological. They hold that the true study of politics should rest, not upon the legal analysis of institutions, but upon an investigation of the forces of society which are striving to express themselves through political action. They emphasize particularly the existence of groups within the State which represent common interests and are animated by common motives, and they conceive of State life as made up of the struggle and competition between these social groups. The principal representatives of this theory are the Austrians Gumplowicz and Ratzehofer.

The inductive method, based upon observation and the study of recorded facts, is, however, not the only one employed by prominent writers on politics during the nineteenth century. Hegel's purely philosophical construction of the State finds an echo in the writings of T. H. Green and of Bosanquet. The deductive method is used by Sidgwick, Lieber, Mill, and the Liberal School in general. The juristic method of analyzing existing institutions is still almost universally in the ascendant in books dealing with jurisprudence and constitutional law. The works of American constitutional jurists are primarily analytical, and although they devote considerable attention to the history of the formation of the Constitution, this is done in order more fully to explain that instrument, which is then analyzed and examined in all its bearings upon modern government. English jurists like Holland, Anson, and Dicey, following Austin, also still employ this method with preference, although the historic study of law has made great progress in England.

BIBLIOGRAPHY. Seeley, *Introduction to Political Science* (London, 1896); Bluntschli, *The Theory of the State* (Oxford, 1892); Bryce, *Studies in History and Jurisprudence* (London, 1902); Wilson, *An Old Master, Essay II.* (New York, 1893); Lewis, *Methods of Observation and Reasoning in Politics* (London, 1852); Willoughby, *The Nature of the State* (New York, 1896); Bosanquet, *The Philosophical Theory of the State* (London, 1899); McKechnie, *The State and the Individual* (Glasgow, 1896); Pollock, *History of the Science of Politics* (London, 1893); id., *Essays in Jurisprudence and Ethics, Essays I., II., and VIII.* (ib., 1882); Goodnow, *Politics and Administration* (New York, 1900); Sidgwick, *Elements of Politics* (London, 1896); Funck-Brentano, *La politique* (Paris, 1892); Ratzehofer, *Wesen und Zweck der Politik* (Leipzig, 1893); Jellinek, *Das Recht des modernen Staates* (Berlin, 1900); Gumplowicz, *Allgemeines Staatsrecht* (Innsbruck, 1897); Janet, *Histoire de la science politique, dans ses rapports avec la morale*, Introduction (Paris, 1887). See also GOVERNMENT; CIVIL ADMINISTRATION; PUBLIC LAW; DIPLOMACY; SOCIOLOGY; STATE; CONSTITUTIONAL LAW; INTERNATIONAL LAW.

POLITICS, THE. A work by Aristotle discussing the relation of man to the State and the different forms of government, and presenting an ideal State incorporating the best points of various systems. The family is regarded as the foundation of the State, all citizens of which are to have a share in the government and to own

land. The work shows, for its period, much knowledge of history and political judgment.

POLITIQUES, pò'lit'èk' (Fr., political). The name of a party which arose in France in the reign of Charles IX., composed of moderate Catholics and Protestants, and aiming at the termination of the civil strife by a compromise between the two factions on the basis of religious toleration and the preservation of the rights of the State as against the privileges of sectaries. It numbered among its adherents such men as Jean Bodin and De Thou, and was influential in establishing Henry IV. on the throne. See FRANCE.

POLITY (Gk. πολιτεία, *politeia*, polity, citizenship). A term used to describe the system on which a State or a Church is organized as a structural unity. In civil usage, the principal forms of polity are monarchy, the rule of one man; aristocracy, the rule of the best; democracy, the rule of the people as a whole; oligarchy, the rule of a few. In ecclesiastical organization, the principal forms are the Papal, in which supreme government is placed in the hands of the Pope alone; the episcopal, in which it is shared by the whole body of bishops; the presbyterian, where it is held by an assembly of presbyters; and the congregational, in which each congregation is independent of any central government.

POLITZER, ADAM (1835—). An Austrian aurist. He was born at Alberti, Hungary, studied in Vienna, Würzburg, Paris, and London, and in 1871 became professor at the University of Vienna. He had achieved great success in 1863 with the publication of his method of treating deafness consequent on catarrh of the inner ear, and he gathered at Vienna a wonderful collection for the anatomical and pathological study of the ear. The more important works of Politzer are: *Beluchtungsbilder des Trommelfells* (1865); *Lehrbuch der Ohrenheilkunde* (1878-82; 4th ed. 1901); *Die anatomische und histologische Zergliederung des menschlichen Gehörorgans* (1889); and an *Atlas der Beluchtungsbilder des Trommelfells* (1895).

POLIKENES, pò-lik's'é-néz. The King of Bohemia in Shakespeare's *Winter's Tale*. His old friend Leontes, King of Sicily, becomes jealous of him and attempts to poison him.

POLIZIANO, pò-lèt-sè-à'nò, ANGELO (Latinized form, *Politianus* (1454-1494)). An Italian scholar and poet. He was the son of a doctor of civil law, and was born at Montepulciano, in Tuscany, July 14, 1454. The family name was Ambrogini, but Poliziano took his name from his native town—in Latin, *Mons Politianus*. He studied Latin at Florence under Cristoforo Landino, Greek under Andronicus of Thessalonica, the Platonic philosophy under Marsilio Ficino, and the Aristotelian under Argyropoulos. When scarcely fifteen years of age he published a poem of 1400 lines in honor of Giulio de' Medici, who had carried off the palm at a tournament. Lorenzo de' Medici took notice of the brilliant lad, and to afford him the means of continuing his studies appointed him tutor to his two sons, and subsequently gave him a residence in his charming villa near Fiesole, where Poliziano, who was passionately fond of country life, resumed his studies with fresh ardor. In 1484 he accompanied the Florentine ambassadors to Rome, and

was received in a flattering manner by the Pope, at whose request he translated into Latin the Greek historian Herodianus, for which he received 200 gold crowns. He also made Latin versions of the *Enchiridion* of Epictetus, the *Charmides* of Plato, and other works, with such elegance that Erasmus pronounced him a master in translation. After having filled for some years a chair of Latin literature in Florence, he commenced the teaching of Greek. His popularity was so great that pupils came to study under him from all the great cities of Italy, and even from distant parts of Europe; the principal were Francesco Pucei, Fortiguerra, Maffei da Volterra, Grocyn, Thomas Linaere, and Michelangelo. In 1489 appeared his *Miscellanea*, a collection of critical and other observations on the ancient authors. Toward the close of his life he entered into orders, and was made canon of the Cathedral of Florence. He died September 24, 1494. Among the brilliant scholars of the Italian Renaissance, Poliziano occupies a foremost place in virtue of his vigor and originality. While he admired the chaste and noble literature of antiquity, there was nothing servile in his imitations; he reproduced without difficulty the strength of Tacitus, the elegance of Livy, and the conciseness of Sallust; his Latin poems, especially his elegies, display the beauty and ardor of his imagination. Among his vernacular pieces may be mentioned his *Canti carnascialeschi* (Carnival Ballads), remarkable for their felicity of style, sweetness of pathos, and abundance of imagery. Another proof of his varied poetical power was his *Orfeo*, one of the earliest dramatic compositions produced in Italy. Consult: Serassi, *Vita di Angelo Poliziano* (Milan, 1808); Bonafons, *De A. Politiani Vita et Operibus* (Paris, 1845); Gresswell, *Life of Politian* (London, 1805); Roscoe, *Life of Lorenzo de' Medici* (10th ed., ib., 1851); and the two works of Symonds, *The Renaissance in Italy* (ib., 1875-86), and *Sketches and Studies in Italy* (ib., 1879).

POLK, pŏk, JAMES KNOX (1795-1849). The eleventh President of the United States, born in Mecklenburg County, N. C., November 2, 1795. His ancestors, who bore the name of Pollock, emigrated from the north of Ireland early in the eighteenth century. Polk graduated at the University of North Carolina in 1818; then studied law with Felix Grundy (q.v.) of Tennessee, and was admitted to the bar in 1820. Three years later he was elected a member of the Legislature of Tennessee, and soon afterwards (1825) was sent to Congress by the Democratic Party, serving as Speaker in the Twenty-fourth and Twenty-fifth Congresses. In Congress he won distinction by his industrious habits and readiness in debate. During the administration of President Jackson he was one of his chief supporters, and gave the same loyal support to Jackson's successor, Martin Van Buren. As Speaker it devolved upon him to preside over the deliberations of the Representatives at a time when party feelings were bitter, and his rulings were frequently appealed from, although usually sustained by the House. After fourteen years in Congress he was, in 1839, elected Governor of Tennessee, and was nominated for the office again in 1841 and 1843, but was each time defeated by the Whig candidate. Nevertheless, his standing among his party associates was not impaired, and when the vigorous opposition to Van Buren made impossible the latter's

nomination for the Presidency in 1844, especially under the rule which required a majority of two-thirds of all the delegates to the national convention to nominate, Polk was introduced as a compromise candidate and was unanimously nominated on the ninth ballot. The Whig candidate, Henry Clay, had compromised himself in some sections by his attitude in regard to the annexation of Texas, while the Democratic platform was moderately acceptable to both North and South through its advocacy of the 're-occupation of Oregon and the reannexation of Texas.' Polk received 170 electoral votes, as against 105 for Clay. George M. Dallas was elected Vice-President. During his term the Oregon boundary dispute was settled with England, the United States accepting the parallel of 49° as the northern limit, though the party cry which helped to elect Polk was a claim for the entire territory to latitude 54° 40' N. A dispute regarding the boundary of Texas caused, in 1846, a war with Mexico, which resulted in the acquisition, through the Treaty of Guadalupe Hidalgo (q.v.), of California and New Mexico. The chief event of President Polk's internal administration was the enactment of the tariff law of 1846, which was based on the principles of tariff for revenue only, and the establishment of the independent treasury system. The President set himself against the internal improvement mania by vetoing a river and harbor bill, which appropriated a large sum for improvement purposes. As regards the slavery question, the debate over the Wilmot Proviso (q.v.) and over the bill to organize the Territory of Oregon were the most notable events. In private life President Polk was unostentatious, frank, and courteous. His habits were extremely simple, and his character was blameless. He died at Nashville, Tenn., June 15, 1849. His biography, including especially a review of his administration, was written by J. S. Jenkins (Auburn, 1850). A number of his manuscripts and other papers have recently been acquired by the Chicago Historical Society, and his MS. diary may be found in the Lenox Library, New York City. See UNITED STATES.

POLK, LEONIDAS (1806-64). An American soldier and first Protestant Episcopal Bishop of Louisiana. He was born at Raleigh, N. C., educated at the University of North Carolina and at West Point Military Academy. While at West Point he came under the influence of Dr. Melville, afterwards Bishop of Ohio, and was converted. After graduation he resigned from the service, and prepared for the ministry at the theological seminary at Alexandria, Va., being ordained at Richmond in 1830. After a year of church work he traveled in Europe to benefit his health. Upon his return he removed to Tennessee, and in 1838 the General Convention appointed him Missionary Bishop of the Southwest—a field embracing Arkansas, Indian Territory, Mississippi, Louisiana, and Alabama. He retained this post until elected Bishop of Louisiana in 1841. He formulated a scheme for higher education in the South which finally resulted in the establishment of Sewanee University, a charter for which was granted by the State of Tennessee in 1858. At the outbreak of the Civil War his sympathies were wholly with the Southern cause. His travels in pursuance of episcopal duties made him thoroughly familiar with the Lower Mississippi

States, and he urged upon the President of the Confederacy the necessity of their defense. In response he was urged to take a commission, and with the approval of his clerical friends he became a major-general in June, 1861, and accepted the command of Department No. 2, which involved the duty of defense of both sides of the Mississippi from the Red River to Cairo, with headquarters at Memphis. He commanded the Southern forces in the battle of Belmont, participated in the engagements of Shiloh and in the operations which led up to the evacuation of Corinth, took part in Bragg's invasion of Kentucky as commander of the Army of the Mississippi, and fought in the battle of Perryville. In October, 1862, he was made lieutenant-general, and fought at Murfreesboro and Chickamauga. In the last named engagement, it was charged by General Bragg, Polk's delay in making attack lost the victory. As a consequence he was temporarily suspended from his command; but the charges were dismissed by President Davis, who offered to reinstate the deposed general. Declining this offer, Polk assumed the charge of paroled prisoners at Enterprise, Miss., and when Gen. Joseph E. Johnston was assigned to the command of the Army of Tennessee, followed that general in charge of the Department of Alabama, Mississippi, and East Louisiana. He was killed by a cannon-shot while reconnoitring the field of Marietta from Pine Mountain. Consult his *Life* by his son, William M. Polk, M.D. (New York, 1893).

POLKA (from Bohem. *pulka*, half; so called from the half-step characteristic of the dance). A round dance supposed to have originated in Bohemia about 1830. The music is in $\frac{3}{4}$ time, and has the rhythmical peculiarity of being accented on the third quaver of the measure:



It was introduced as a fashionable dance into Western Europe about 1841, and soon became extremely popular; in France in particular it created a perfect furor. Its movement is lively, though not as rapid as that of the galop.

POLLACK (from Gael. *pollag*, whiting, Ir. *pullog*, pollack). A kind of codfish (*Pollachius virens*), common on both coasts of the North Atlantic, and more commonly known in the United States as 'coalfish.' It is dark greenish brown above, sides and below somewhat silvery. It attains a weight of about 30 pounds, and is of value as a food fish. Its habits differ from those of the cod or haddock, for it is to a great extent a surface-swimming fish, and congregates in large schools, which swim about in search of young fishes as food; but they also feed at the bottom like cod. They seem to spawn while swimming about, and their eggs float and hatch in five or six days. Their flesh is highly esteemed, especially about the Gulf of Newfoundland; and their liver yields an excellent oil in large quantities.

The Alaskan pollack (*Nieragra chalcogramma*) is a very similar fish, abundant in the North Pacific, and especially in Bering Sea, where it furnishes the larger part of the food of the fur seal, and is of great value to the natives of both coasts. It is uniformly dark olive, and reaches a length of three feet. Another more sooty species, the 'wall-eyed pollack' (*Nieragra Fu-*

cnasis), is numerous in Puget Sound and on the California coast.

Consult Goode, *Fishery Industries*, sec. 1. (Washington, 1884). See Plate of CODFISH.

POLLAIUOLO, pól'lá-yoo-ó'lo, ANTONIO (1429-98), and PIERO (1443-96). Italian artists of the Florentine Naturalistic School (early Renaissance). Antonio, the elder, goldsmith and painter, was born in Florence in 1429. Antonio became celebrated as a niellist and metal-worker. The paneled decoration for the altar of San Giovanni and the altar candelabra exhibit fidelity to nature and mastery of design. Deep study of antique sculpture, added to a thorough knowledge of anatomy, obtained from dissection, rendered him one of the first draughtsmen of Florence, and caused his final adoption of painting as a profession. His early use of the oil medium was probably due to the influence of Castagno or Baldovinctti, but whether received from these masters direct or from his brother Piero, who was a student of the latter artist, is an unsettled question. In this vehicle are executed the "Hercules and the Hydra" and the "Hercules and Antæus," both in the Uffizi.

Piero became his brother's associate, and it is difficult to distinguish their work. As many pictures were the combined work of both, it may be concluded that in such cases Antonio furnished the design, while Piero executed it in color. Their masterpiece is the large "Martyrdom of Saint Sebastian" (1475) in the National Gallery, London. It exhibits the severe and plastic treatment of Antonio—an accuracy and sureness in drawing that is not found in the works assigned to Piero's hand, such as the "Coronation of the Virgin" (1483), at San Gimignano, signed by Piero, in which the drawing is noticeably defective. The general handling of the color in Piero's work would point to him as being responsible for that portion of the "Saint Sebastian." The "Saint Christopher and the Infant Christ," in the Metropolitan Museum, New York, is probably a work executed wholly by the elder brother. Of their Madonnas there are good examples in the National Gallery, London, and in the Berlin Museum. In 1480 Antonio was called to Rome by Pope Innocent VIII., where he was employed upon monumental work until his death in 1498. Piero died in Florence in 1496.

POLLAIUOLO, SIMONE DEL (1457-1508). A distinguished Italian architect, sometimes called Il Cronaca. He was born in Florence and spent a number of years in Rome devoted to the study of the monuments of antiquity. He was a keen observer, and from his habit, after his return to Florence, of describing with great minuteness the sights of the Eternal City, the nickname 'Il Cronaca' (The Chronicler) was bestowed upon him by his fellow artists. In 1495 he was appointed chief architect of the Duomo, and after the death of Benedetto da Majano he became the architect of the Palazzo Strozzi, to the facade of which he added the splendid cornice, his inimitable masterpiece. He also built the Palazzo Guadagni, a handsome structure in the early Renaissance style, and the Church of San Francesco or San Salvatore al Monte, an edifice imposing in its very simplicity and chaste proportions, which was greatly admired and praised by Michelangelo. Among the few other works that

may be ascribed to him with certainty are the vestibule of the Sacristy of San Spirito, the court of the Palazzo Strozzi, and the great hall in the Palazzo Vecchio. Consult: Anderson, *The Architecture of the Renaissance in Italy* (London, 1896); and Geymüller-Stegmann, *Die Architektur der Renaissance in Toscana* (Florence, 1885-96).

POLLANARRU'A. An ancient city of Ceylon now in ruins, in the Province of Tamankadme, about 60 miles northeast of Candy. It was the capital of the island in 769-1319. Its golden age was in the reign of Prakrama Bahoo I., who fortified it, built a royal palace, a monastery and residence for the priesthood, a superb dagoba, and many other public buildings. When the Malabars took it, about 1204, they demolished and reduced it to its present condition. The most remarkable building is the Jaitawanarama temple. Opposite the entrance is an image of Gautama Buddha 50 feet high. The Satmaha Prasada is a handsome pyramidal building. The palace of Prakrama Bahoo I. is on the borders of the Toopawewa, an artificial lake.

POLLARD, EDWARD ALBERT (1828-72). An American journalist, born in Nelson County, Va. He graduated at the University of Virginia in 1849, and studied law. He went to California and engaged in journalism until 1855, and traveled extensively. At the beginning of the Civil War he was preparing for the Episcopal ministry. From 1861 until its suppression by the military authorities in 1865, he was an editorial writer on the *Richmond Examiner*, and was a merciless critic of President Davis. Near the close of the war, while attempting to run the blockade on his way to England, he was captured and imprisoned for eight months in Fort Warren in Boston. After his release on parole he was again confined in Fortress Monroe by special order of Secretary of War Stanton, but was summarily released by General Butler. His books include: *Black Diamonds Gathered in Darky Homes of the South* (1859), an attempt to show the bright side of slavery; *Letters of a Southern Spy in Washington and Elsewhere* (1861); *Southern History of the War* (1862-66); *The Lost Cause* (1866), a shorter history of the war; *Lee and His Lieutenants* (1867); and *Life of Jefferson Davis with Secret History of the Southern Confederacy* (1869). His books show considerable literary ability, but his violent prejudices prevented any sort of fairness to the objects of his dislike.

POLLARDING (from *pollard*, from *poll*, head). The process very commonly practiced in Europe of cutting off the crown of a tree to make it throw out numerous water-sprouts from the top of the remaining trunk. Trees so treated, called pollards, are not beautiful, but are useful in districts where fuel is scarce, since the branches are cut every third or fourth year. The practice is not common in the United States. Trees of rapid growth, such as willows, poplars, alders, elms, and limes, are most frequently pollarded. While the operation apparently injures the tree, it should be noted that many of the oldest trees in Europe and the largest in diameter have been continuously pollarded.

POLLEN (Lat., fine flour, fine dust). A name applied to the microspores of seed-plants, and

popularly regarded as the 'fertilizing dust' produced by flowers. See **SPORE**.

POLLEN'TIA. An ancient place in North Italy, on the Tanarus, represented by the modern little town of Pollenzo, 33 miles south of Turin, near Bra. The ruins of an aqueduct, an amphitheatre, a theatre, and a temple mark the site of the ancient city, where Alaric and Stilicho fought in A. D. 402 or 403. The ruins of a mediæval royal castle are also to be seen here.

POLL-EVIL. A painful swelling on the head or the neck of horses, which if not attended to may become a troublesome and serious ulcer. It may be caused by striking the head against a beam, straining against the halter, or by an excessive tight rein when driving. If the swelling continues to increase, so that it becomes evident that pus is forming, then the formation of pus must be hastened as rapidly as possible by hot applications, and as soon as this is brought about—which may be known by the tumor being soft to the touch—it must be lanced. All the pus must be discharged, and the means employed—as, e.g., a seton—must be such that any future formation of pus shall run out immediately, thus preventing any corrosion of the bone beneath the tumor. This is all the treatment required, except fomentations of tepid water to insure cleanliness, if the disease be taken in its early stages.

POLLICE VERSO, pŏl'li-sē vēr'sŏ (Lat., with thumb reversed). The sign by which the spectators at the Roman gladiatorial combats expressed their wish that the vanquished gladiator should be put to death. In this case the thumbs were turned up, but it is not clear that turning down the thumbs signified that mercy was to be extended, this being shown according to Martial by the waving of handkerchiefs. The famous painting, "Pollice Verso," by Gérôme, shows the victor standing over his prostrate rival and looking up to the benches for the verdict of the spectators, who are represented with thumbs turned down.

POLLINATION. Transference of the pollen (q.v.) from the stamen of a flower to the stigma of the same flower (self or close pollination) or to that of another flower (cross-pollination). Several terms associated with these processes may be here defined: *Autogamy*, self-pollination of flowers; *alogamy*, cross-pollination; *gitonogamy*, cross-pollination between two flowers upon one plant; *xenogamy*, between flowers of different plants. Flowers containing both stamens and pistils are called *monoclinous*, or *hermaphroditic*: if stamens are in one flower and pistils in another, but both kinds are upon the same plant, the plants are said to be *diclinous* and *monœcious* (Fig. 1); if upon different plants, *diœcious* (Fig. 2). *Anthesis* is the period during which pollination is possible; flowers which remain closed during this period exhibit *cleistogamy* (q.v.), those which open all or part of the time exhibit *chasmogamy*. Flowers whose stamens or pistils or both are of unequal lengths are said to show *heteromorphism*; if two lengths occur, *dimorphism* (Fig. 3); if three are present, *trimorphism*. In *homogamous* flowers the stigmas mature when the pollen grains are shed; in *dichogamous*, these two periods differ. If the stigmas mature first, the flower exhibits *protogyny* or *pro-*

terogyny; if the pollen grains are shed first, protandry or proterandry (Fig. 4).

In general, cross-pollination seems to be somewhat advantageous to plants because it is supposed to prevent close inbreeding, which in both plants and animals seems to result in degeneracy. The reason for this is not known.

There are various devices by which cross-pollination is obtained. The most perfect device is the so-called dioecious habit illustrated by the willows (Fig. 2). In the so-called monoecious habit (Fig. 1), cross-pollination is less certain,

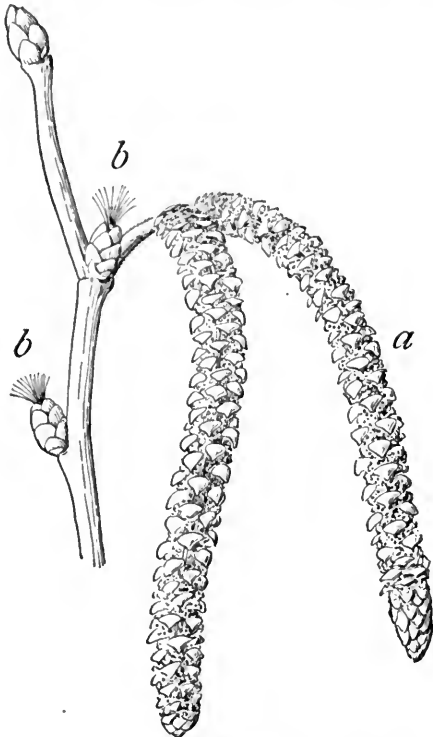

FIG. 1. MONOECISM.

The hazel (*Corylus*), showing pistillate flower clusters (*b*) and staminate catkins (*a*) on the same twig. Self-pollination is possible here, as is never the case in a dioecious plant like the willow (Fig. 2).

though it is often facilitated by the pistillate flowers being uppermost on the tree. In the case of insect pollinated flowers cross-pollination is sometimes secured by proterandry (Fig. 4), or protogyny. In many cases the stigma when mature is higher than the stamens and hence self-pollination is difficult. Perhaps the most effective device to insure cross-pollination is the impotence of the pollen upon the stigma of the same flower and even of other flowers on the same plant. It must be remembered that in some plants self-pollination is not only possible, but even common. It is invariably the case in cleistogamous flowers. (See CLEISTOGAMY.) In the subterranean flower of the violet self-pollination is necessary, and the rich development of seeds shows that it is effective.

Pollination is effected in various ways in plants, among which the most important are the following: (1) Insect pollination. In a vast number, perhaps even the majority of plants, pollen is

transferred by insects. The structure of the insect-pollinated flowers is commonly more or less complicated and differs somewhat widely



FIG. 2. DIOECISM.

Catkins of the crack willow (*Salix fragilis*), the lower staminate, the upper pistillate. These catkins are borne on separate plants, thus insuring cross-pollination.

from that of flowers pollinated in other ways (Fig. 5). For example, the corollas are commonly prominent and highly colored, and it is be-

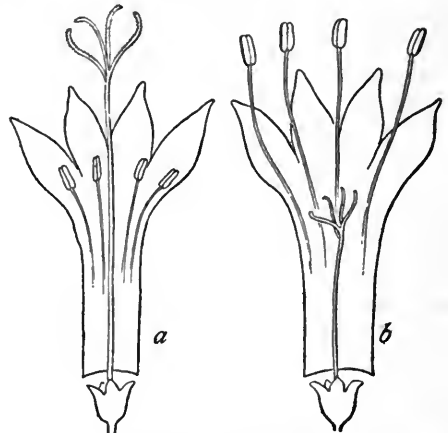

FIG. 3. DIMORPHISM.

Flowers of the *Houstonia*, illustrating *a* means for facilitating cross-pollination. In *a* the styles are long and the stamen filaments short; while in *b* the reverse is true. Pollen obtained from anthers on long stamens is likely to be brushed off upon the stigmas of the long styles; while pollen from the short stamens will be brushed off upon the stigmatic surface of the short styles.

lieved that insects are more likely to visit flowers if their corollas are colored. Some experiments, however, would seem to show that color may not serve conspicuously as an attraction. Many

flowers are attractive to insects because of their fragrance, which is a device to secure cross-pollination. The pollen of insect-pollinated flowers is often comparatively sticky and heavy. A large number of structures are found in these flowers which seem to favor certain insects and oppose others. Among the more striking of these devices



FIG. 4. PROTANDRY.

Flowers of a freeweed, showing a young condition (a), in which the stamens, but not the stigmas, are mature, and an older condition (b), in which the pollen has gone, while the stigmas are mature. Cross-pollination is thus effected.

is a long corolla tube which favors insects with a long proboscis. In general, insect-pollinated flowers are rich in nectar, which is often the lure for the visit of insects. Other flowers are visited for their pollen, of which many insects are fond. (2) Bird pollination. A comparatively small and in North America unimportant number of flowers are pollinated by birds, especially hum-

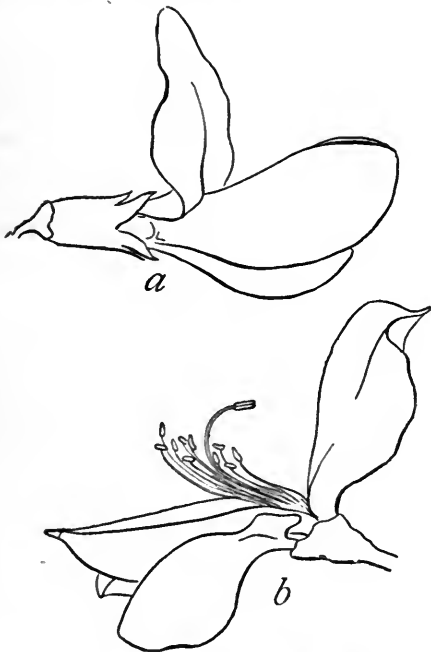

FIG. 5. INSECT POLLINATION.

The flower of a legume, showing the normal condition (a) and the condition which appears when an insect alights on the flower (b). It is obvious that insect pollination can be readily effected here.

ming-birds. (3) Wind pollination is common with a large number of plants, especially trees, grasses, and sedges, in which the flowers differ from insect-pollinated flowers in the relative absence of showiness, nectar, and odor, etc. These flowers are also comparatively small. The pollen is usually light, easily carried by the wind, and is also produced in immense quantities. Pine pollen is particularly interesting in that

it is winged (Fig. 6, a). It is so abundant that it sometimes forms the so-called sulphur showers. (4) Water-pollinated flowers. A small number

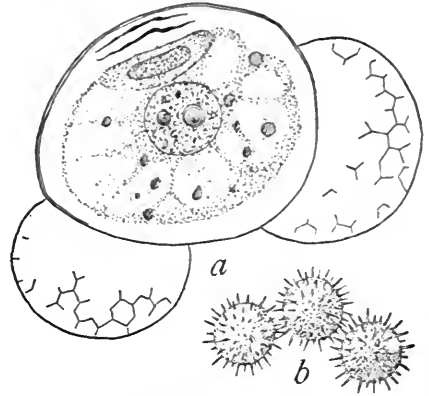

FIG. 6. POLLEN GRAINS.

(a), From the pine, showing bladder-like wings which facilitate dispersal, and (b), from the hibiscus showing spines which facilitate attachment to the stigma.

of aquatic plants are pollinated by means of water currents. In some cases, as in *Vallisneria*, a somewhat complex mechanism is present.

POLLIO, GAIUS ASINIUS. A Roman orator, politician, soldier, and author of considerable merit. He was born in Rome B.C. 76, but belonged to a family of Marrusian descent. When civil war broke out between Caesar and Pompeius, Pollio sided with the former, was present at the crossing of the Rubicon, and took part in the battle of Pharsalia B.C. 48. At the time of Caesar's assassination Pollio was governor of Further Spain, and carrying on the war against Sextus Pompeius. In the subsequent struggles he sided with the triumvirate against the oligarchic senate; and on the triumph of the former, was appointed administrator of Gallia Transpadana, in which capacity he saved the property of the poet Vergil at Mantua from confiscation. After Antonius and Octavianus had quarreled, it was Pollio who effected their temporary reconciliation at Brundisium B.C. 40; next year he conducted a successful campaign against the Parthini, a people of Illyria, and in consequence obtained a triumph. After this event, however, he withdrew altogether from political life. He lived far into the reign of the Emperor Augustus, dying at his Tusculan villa A.D. 4, in the 80th year of his age. Besides having a reputation for oratory, Pollio was celebrated as an historian, poet, and critic. His literary and political criticism of his contemporaries, in particular, appears to have been valuable. He also claims remembrance as a distinguished patron of Catullus, Horace, Vergil, and other men of letters, and as the founder of the first public library at Rome. Of the writings of Pollio, we possess only three letters to Cicero (published among Cicero's correspondence *Ad Familiares*, v. 31-33), and a few fragments of his *History of the Civil Wars* collected by Peter. *Historicorum Romanorum Fragmenta* (Leipzig, 1883). Wölflin would attribute to Pollio the *Bellum Africanum* (published with Caesar's works by Dinter, Leipzig, 1890), but this theory is not generally accepted. Consult: Landgraf.

Untersuchungen zu Cäsar und seinen Fortsetzern (Erlangen, 1888); Wöllflin and Miadoriski, *Pollionis de Bello Africo Commentarius* (Leipzig, 1889); Schmalz, *Ueber den Sprachgebrauch des Asinius Pollio* (Munich, 1890); Kornemann, *Die historische Schriftstellerei des Asinius Pollio* (Leipzig, 1896).

PÖLLNITZ, pölnits, KARL LUDWIG, Baron (1692-1775). A German memoirist of note. He was remarkable for his talents, but his extravagant and vagabond habits often reduced him to the greatest poverty. After wandering all over Europe, taking service in the Church in Austria, and in the army in Spain, he finally attracted the favorable notice of Frederick the Great, who appointed him his reader, and made him director of the theatre at Berlin. After twice having changed from Catholicism to Calvinism, he shortly before his death proclaimed himself a member of the Church of Rome. Among his works, marked by keen observation and wit, are *Lettres et mémoires* (1734) and *Etat abrégé de la cour de Saxe*, etc. (1734). He was probably also the author of *Histoire secrète de la duchesse d'Hanovre*, etc. (1732), and *La Saxe galante* (1734).

POLLOCK. See POLLACK.

POLLOCK, SIR CHARLES EDWARD (1823-97). An English jurist and law writer, educated at Saint Paul's School (1833-41). He was called to the bar in 1847, became Queen's counsel in 1866, and was knighted and raised to the Exchequer bench in 1873. Pollock collaborated with J. J. Lowndes, Sir Peter Maxwell, and F. P. Maude in the production of legal works, and wrote himself *The Practice of the County Courts* (1851), which he continued to supplement up to the edition of 1880, and *A Treatise on the Power of the Courts of Common Law to Compel the Production of Documents for Inspection* (1851).

POLLOCK, SIR FREDERICK (1845—). An English jurist and author. He was born in London, December 10, 1845, and was educated at Eton, and at Trinity College, Cambridge, of which he was made fellow (1868). Admitted to the bar at Lincoln's Inn (1871), he was appointed examiner in law at Cambridge (1879-81), professor of jurisprudence at University College, London (1882-83), Corpus professor of jurisprudence at Oxford (1883), professor of common law in the Inns of Court (1884-90), and member of the Royal Labor Commission (1891-94). His works pertaining to his profession comprise mainly *Principles of Contract* (1876; 7th ed. 1902); *Digest of the Law of Partnership* (1877; 7th ed. 1900); *The Land Laws* (1882, 3d ed. 1895); *The Law of Torts* (1887; 6th ed. 1901); *History of English Law* (1895; 2d ed. 1899), with Frederick William Maitland (q.v.); *A First Book of Jurisprudence* (1896). Better known to the general reader is *Spinoza, His Life and Philosophy* (1880; 2d ed. 1899). Further versatility is shown by *Introduction to the Science of Politics* (1890; 4th ed. 1902), and many brilliant political articles contributed to the *Pall Mall Gazette* and the *Saturday Review*. Sir Frederick Pollock also conceived the happy idea of writing verse-parodies of typical law cases. *Leading Cases Done into English* (1877), popular from the first, was reissued with additions in 1892; and in 1899, with Ella Fuller Maitland, he published *The*

Etchingham Letters, a clever novel in epistolary form.

POLLOCK, SIR GEORGE (1786-1872). A British soldier. He studied at the Royal Military Academy at Woolwich until 1803, and then entered the East India Company's service as a lieutenant of artillery. He arrived in India toward the end of the Mahratta wars, at once went to the front, and participated in the sieges of Deeg (November 12-December 25, 1804) and Blurtpore (January 4-April 2, 1805). During the First Burmese War he took an important part in the military operations, and at its close was invalided home. In 1838 he was promoted to be major-general, and in 1842 was assigned to command the British forces in the war against the Afghans. He forced the Khyber Pass and captured Kabul. For these services he received a pension of £1000 from the East India Company and many honors from the Indian and British governments. In 1870 he was commissioned field-marshal in the British Army, a year later was made constable of the Tower of London, and in 1872 was created Baronet of the Khyber Pass. Consult: Low, *Life of Field-Marshal Sir George Pollock* (London, 1873); and Kaye, *History of the War in Afghanistan in 1838 to 1842*.

POLLOCK, WALTER HERRIES (1850—). An English author. He was born in London in 1850 and was educated at Eton and at Trinity College, Cambridge, where he graduated with classical honors in 1871. Though called to the bar at Lincoln's Inn (1874), he early began to give most of his time to journalism and literature. From 1884 to 1894 he was editor of the *Saturday Review*. His work includes translations from the French, as well as much graceful and humorous verse: *Lectures on French Poets* (1879); *The Poet and the Muse*, a metrical translation from Alfred de Musset's *Nuits* (1880); *Songs and Rhymes, English and French* (1882); *The Picture's Secret*, a novel (1883); *The Paradox of Acting*, translated from Diderot (1883); *Verses of Two Tongues* (1884); *Old and New*, verse (1890); *A Nine Men's Morrice* (1889) and *King Zub* (1892), two volumes of fantastic tales; *Mémoires inédits du Marquis de——* (French, 1894); *The Charm, and Other Drawing-Room Plays*, in conjunction with Sir Walter Besant (1896); and *Jane Austen, Her Contemporaries and Herself* (1899).

POLLOK, ROBERT (c.1798-1827). A Scotch poet, son of a poor farmer. He was born at North Moorhouse, Renfrewshire, October 19, 1798; educated for the ministry at the University of Glasgow (M.A. 1822) and at the United Secession Hall (1822-27); licensed to preach (1827); but owing to poor health, caused in part by over study, he was never permanently in charge of a congregation. He was advised to visit Italy, but he got no farther than London, whence he went to Shirley Common, near Southampton, where he died, September 18, 1827. Pollok is remembered for *The Course of Time*, a poem, begun in 1825 and finished and published in 1827. Though suggested by Byron's *Darkness*, it is an essay in the manner of Milton. It is in blank verse, and its theme is the destiny of man. The poem was long popular in Scotland, England, and the United States. Pollok could not rise to his theme, and the execution as a whole is poor. The poem contains many eloquent passages not-

withstanding. Pollok also wrote a meditative poem called *Thoughts on Man*, and three tales of the Covenanters. Consult the *Life* by his brother, D. Pollok (Edinburgh, 1843).

POL/LOKSHAWS. A municipal borough and manufacturing town in Renfrewshire, Scotland, on the White Cart, three miles southwest of Glasgow, of which it is practically a suburban extension, connected by electric street railroads, etc. (Map: Scotland, D 4). Cotton-spinning, calico-printing, silk-weaving, bleaching, iron-founding, and fancy dyeing are extensively carried on. Population, in 1891, 10,223; in 1901, 11,169.

POLL-TAX. See CAPITATION, TAXATION.

POLLUTION OF WATERCOURSES (Lat. *pollutio*, from *polluere*, to defile, from *por-*, forth + *luere*, to wash). By the common law, owners of real property adjoining running streams are entitled to make a reasonable use of their waters, subject to the exercise of similar rights by owners above and below them on the stream. This right implies that they are entitled to the water in reasonable quantities and of a reasonable quality. As this doctrine of 'reasonable user' is applied, no absolute and definite rule can be framed as to what extent the waters of a stream can be polluted or contaminated by an adjoining owner. The courts will consider the circumstances of each particular case. As streams are natural means of drainage of land, it has been held that a city cannot be restrained from causing its sewage to flow into a stream, unless an unusual or unreasonable quantity is discharged therein. Mills and other industries along a stream naturally impair the quality of the water somewhat, but as a general rule the courts will "not interfere if they are adapted to the stream, and do not cause it to give off odors which are injurious to health." The discharge of dye materials, poisonous chemicals, unusual quantities of sawdust, and other waste into a stream, has been restrained in various jurisdictions.

The remedies of a riparian owner who is injured by pollution of a stream are to seek an injunction and damages in a court of equity, or sue for damages alone, in a court of law. See NUISANCE; RIPARIAN RIGHTS, etc. Consult: Angell, *The Law of Watercourses* (7th ed., Boston, 1877); Haworth, *River Pollution* (1897).

POLLUX. See CASTOR AND POLLUX.

POLLUX, JULIUS (Gk. Ἰούλιος Πολυδεύκης, *Ioulios Polydeukēs*). A Greek lexicographer who was born at Naucratis, in Egypt, and flourished in the reign of the Emperor Commodus (A.D. 180-192). After a preparatory training under his father, he studied under the Sophists, and became a learned grammatical critic. He opened a school of rhetoric at Athens, and became so famous that he was made preceptor of the Emperor Commodus. He prepared for the use of the Emperor an *Onomasticon*, a Greek vocabulary divided into 10 books, designed to facilitate the learning of the Greek language by the young prince. It contains a variety of synonymous words and phrases, is useful in the study of Greek literature and art, and is valuable also because in the first part it treats of the gods and their worship. Pollux was the author of several other works, of which Suidas has preserved the titles. The *Onomasticon* was published with Latin translation and commentary

by Dindorf (5 vols., Leipzig, 1825), and by Bekker (Berlin, 1846).

POLNISCH-OSTRAU, pól'nish ós'trou. A town in the Crownland of Silesia, Austria, on the Ostrawitza, opposite Mährisch-Ostrau, 60 miles west-southwest of Cracow. Its importance is due to the extensive coal deposits of the neighborhood, which form the southwestern part of the great Upper Silesia coal-belt. The town produces malt and liquors. Population, in 1890, 13,200; in 1900, 18,800; chiefly Czechs.

POLO (from Tibetan *pulu*, willow, the material of which the ball is made in Tibet). A game played on horseback, closely resembling hockey (q.v.). While the antiquity of polo in the East is undeniable, in England and America it is of comparatively recent origin. Persian odes, some of them thought to antedate the Christian Era, celebrate the glories of the game; and it is a matter of undoubted record that it has flourished at different courts of Central Asia from the tenth century. China and Japan also had a game closely resembling the Persian sport. The game seems to have been first adopted in India about 1764, by the English tea-planters in Cachar, from whom it spread to the English merchants of Calcutta. In 1869 some subaltern officers of the Tenth Hussars, stationed at Aldershot, introduced the game into England. The possibilities of the sport were immediately recognized, and at the present time the game is widely played in Great Britain and her colonies, and is almost as popular in the United States. The Hurlingham Club, London, became the acknowledged law-making authority, not only for Great Britain, but for her colonies. The executive, however, is the County Polo Association, which does not concern itself with rules, but regulates the principal contests, the County Cup Series, dividing England into four divisions, the winners only of which play in the finals at Hurlingham, where the Inter-Regimental Cups are also played for. The Champion Cup and the Hunt Cup Championship are played for over the course of the Ranelagh Club, another noted home of the game.

Polo was introduced into the United States in 1876 by James Gordon Bennett, and first practiced in Dikler's Riding Academy, New York City. The Westchester Polo Club was formed in New York City in the same year and a year later it went into summer quarters at Newport, R. I., which has been the American headquarters of the game ever since. The game went West as far as the Pacific coast, and a National Polo Association was organized, consisting of the principal Eastern clubs. Many other clubs exist, besides those affiliated with the association, especially in the Middle West and on the Pacific Slope.

The system of handicapping adopted by the American Polo Association is universally commended. In order to give younger players a chance, each individual is penalized with so many goals, from two upward, according to his skill. This penalty he takes with him wherever he plays. So that if the penalties on a team of four, each of whom is penalized, amount, say, to 16 goals, and they meet another team of four whose individual penalties aggregate only 10, the first team has to make 6 goals before it can begin to score. Of course this penal handicapping does not apply to championship and open games.

The rules of play adopted by the Westchester

Polo Club are those which practically govern all American play. They have been essentially the same all through the game; only minor alterations, like forbidding hooking mallets and raising the height of the ponies, first in 1879 from thirteen hands to fourteen one, and subsequently to fourteen two, having been made.

The game is played on a smoothly rolled green, when possible about 750 feet long and 500 wide. A white board ten inches high forms a boundary along the sides of the course, the ends being open, except that in the centre of each end there stand two goal posts 24 feet apart, made of very light material so as to break easily in case of collision. The ball is of basswood painted white, $3\frac{1}{8}$ inches in diameter, and weighs five ounces. The mallets or sticks are generally of Malacca cane, or other light wood, covered at the handle with rubber or leather, and from fifty to fifty-six inches long. The mallet head is generally cigar-shaped, two inches thick and eight or nine inches long, of strong wood, and fixed on the handle at any angle the player finds most effective to his wrist action. A loop of thin leather (to break easily) is slipped over the wrist, and the mallets weigh from 15 to 20 ounces. The ponies are not limited to any particular breed, but those that have been broken to the game give a great advantage to the players. They must be active, spirited, and sympathetic with the game. Each rider changes his pony with every period of play.

The game can be played by teams of two, three, or preferably four on each side. If two on each side play the periods are two of 15 minutes each, with two minutes' rest after each goal and five minutes between periods. Teams of three play four periods of 15 minutes; of four, four periods of 15 minutes each, with seven minutes' rest between them, and two minutes' rest after each goal.

Each team chooses an umpire, and they appoint a referee, who watches the game from a pony's back. The teams toss for position on the field. The eight players face each other in fours on the centre of the field. The captain usually takes the place of 'back' to defend his goal and direct his team. In front of him is the 'half-back,' while the two forwards (Nos. 1 and 2) are close up to the opposing team. Play begins as the referee throws the ball, or, in case it is decided to open the game with a charge, the teams are ordered back to within thirty feet of their respective goals, the ball is then dropped in the centre of the field, and at the sound of the time-keeper's gong all rush for a strike and the game is on. A player may not with his hands or stick touch an opponent or his horse or stick, nor must he put his stick over his opponent's horse. In 'riding off,' that is, eroding an opponent away from the ball, a player must not push or strike with his arm or elbow. When the ball goes out of bounds over the side line, it is thrown back at the point it crossed, the teams lining up as in the beginning of the game. When a ball crosses the end line, without passing between the goal posts, the side defending that goal has the privilege of a knock-out from the point at which the ball crossed the line. When a player knocks the ball behind the line, at the end at which his goal is situated, it is a safety knock-out, and scores $\frac{1}{4}$ of one goal against his side. If the ball is caromed out or kicked out by a pony it does not thus score. A player in

possession of the ball (he who hit it last) has the right of way, and must not be crossed except at a safe distance.

Polo is a rough, exciting game. The breaking of sticks and the unseating of riders is a frequent occurrence, and occasionally a pony has a bad fall. Fresh relays of ponies must be on hand at every game, as the sport is an exhausting one. It brings out, however, the natural instinct of the horse, who frequently seems to enter fully into the spirit of the contest.

POLO, pō'lō, GASPAR GIL (c.1530?-?). A Spanish poet, born at Valencia. While he was town clerk at his birthplace his talents for office became known to Philip II., who appointed him, in 1572, coadjutor to the president of the upper financial chamber of the Kingdom of Valencia, and in 1580 sent him to superintend the royal patrimony at Barcelona, where he died. Besides his *Canto de Turia* in praise of his native city, he wrote a continuation of Montemayor's *Diana*, under the title *Primera parte de Diana enamorada, cinco libros, que prosiguen los siete de Jorge Montemayor*. This work appeared first at Valencia in 1564. Though inferior to the original romance in invention, the continuation so greatly surpasses it in clearness of thought and expression throughout the metrical portions that Cervantes exempts it from the condemnation of Don Quixote's other books as deserving as much respect "as though Apollo himself had written it." The best edition of the *Diana enamorada* is that of Cerda, which is accompanied by a commentary on the *Canto de Turia* (Madrid, 1778; new ed. 1802; see also the edition in the *Biblioteca clásica española*, Barcelona, 1886). Polo's *Diana* was translated into English, along with the first part by Montemayor and the second by Alonzo Perez, by Bartholomew Young at London in 1583-92.

POLO, MARCO (c.1250-1324). The most celebrated traveler of the Middle Ages. He belonged to a noble Venetian family. His father, Niccolò Polo, and his uncle, Maffeo Polo, went about 1249 to the Crimea and from there journeyed to Cathay or China. Here they were received by the famous Kublai Khan (q.v.), returning home in 1269. When they set out again for the East in 1271 Marco Polo, who had been born during his father's absence, went with them. The three travelers crossed Western Asia and "Tartary," and reached China and the Great Khan in 1275. They were received with great honors, and young Marco received various high offices; at one time he administered a whole province for three years. The three Europeans finally became restless in this distant land, and, though the Khan was unwilling to allow them to depart, they at last obtained permission to accompany an embassy to Persia. From there they journeyed to Venice, reaching their native city in 1295. Marco Polo some time after his return commanded a fleet in a war against Genoa. He was taken prisoner in 1296, and was not released until 1298. During this time he dictated in French an account of his journey to Rustigliolo di Pisa, who entitled the work *The Book of Marco Polo*. It was translated almost immediately from the French text of Rustigliolo into many other languages. For centuries it comprised all the knowledge Europe possessed of the extreme East, and though Marco Polo was at one

time accused of exaggeration in many particulars, subsequent travels have proved the accuracy of his observations. Little is known of Polo's history after he left the Genoese prison, beyond the fact that a wife and three daughters survived him. Consult: San-Filippo, *Studi biografici e bibliografici*, vol. i. (Rome, 1882), which contains a list of the various editions; the best one is that of Yule, *The Book of Sir Marco Polo* (2d ed., London, 1875).

POLOCK, pól'ótsk. An ancient city of Russia. See POLOTSK.

POLO DE MEDINA, pól'ó dá má-dē'ná, SALVADOR JACINTO (c.1607-c.1660). A Spanish poet, born in Murcia. He took orders when about thirty years old, and became secretary to the Bishop of Lugo. He wrote much satirical verse in his youth in the manner of Cervantes and Quevedo. His *Academias del jardin*; *Buen humor de las musas Apolo y Dafne*, mostly poems; and *Pan y Siringa*, a romance, were all printed in 1630. His *Hospital de incurables, viaje de este mundo al otro* (1636), an imitation of Quevedo's *Sueños*, is in prose. He also wrote the elegant treatise *Gobierno moral a Lelio* (1657), which had considerable influence on the literature of his century. His *Obras en prosa y verso* were first published in 1664. His verse is printed in Rivadeneyra's *Biblioteca de autores españoles*, vol. xliii. (Madrid, 1875).

POLONAISE (Fr., Polish), or **POLACCA**. A Polish national dance of slow movement, in $\frac{3}{4}$ time. It always begins and terminates with a full bar, and a peculiar effect is produced by the position of its cadence, the dominant seventh in the second crotchet of the bar preceding the triad on the third crotchet:



The characteristic rhythmic figure of the accompaniment is . At the present

day the polonaise is more a promenade than a dance, taking the place of the older *entrée*. Grove claims that this dance was not originally a popular dance, but originated at the coronation of Henry of Anjou at Cracow (1574). This statement seems to be confirmed by the fact that the oldest polonaises were not dance-songs, but purely instrumental pieces. Moreover, the entire character of the polonaise seems to indicate that it might well have had its origin in the need of some suitable music to accompany the movements of a solemn procession. Chopin gave to the polonaise a new significance as an instrumental form. The characteristic features of the polacca are sometimes adopted in a rondo, or other lively and brilliant composition, which is then said to be written *alla polacca*.

POLONIUM (Neo-Lat., from Lat. *Polonia*, Pol. *Polska*, Poland). A metallic element discovered in 1898 by Madame Skłodowski Curie. While studying the radio-activity of various minerals, Madame Curie found that specimens of uraninite or pitchblende from certain localities showed more active radiation than metallic uranium, the principal metallic ingredient of uraninite. She thus became convinced that those minerals must contain some radio-active substance hitherto unknown, and further examina-

tion led her to the discovery of a new radio-active metal, resembling bismuth, for which she proposed the name *polonium*. At first the elementary nature of polonium was questioned, and it was said to be a mixture of bismuth and some unknown substance; but the more recent researches of Markwald, of Berlin, have demonstrated it to be an element. The properties of polonium are said to be similar to those of bismuth, although the metal resembles nickel in color. The subnitrate of polonium has been prepared, and is a whitish powder. The special peculiarity of polonium is its wonderful radio-activity, which is said to be about three hundred times greater than that of uranium. Markwald has shown that polonium intercepts a strong current of electricity passing through the air from a generator to the receiver, the air ceasing to be a conductor for the flashes; and that in the dark pieces of barium, platinum, and zinc sulphide, if placed near polonium, glow with a bright greenish light. See RADIO-ACTIVITY.

POLONIUS. The chamberlain to the King of Denmark, and father of Ophelia and Laertes, in Shakespeare's *Hamlet*. Hidden behind the arras to overhear Hamlet and the Queen, he is killed by the former, who thinks it is the King.

POLOTSK, pól'ótsk, or **POLOCK**. An ancient city of the Government of Vitebsk, Russia, situated on the Dūna, 63 miles northwest of Vitebsk (Map: Russia, C 3). Its two ancient castles are now in ruins and a new church stands on the site of the Church of Saint Sophia originally founded in the twelfth century. There is a seminary for teachers. The chief manufactures are leather, pottery, tobacco, soap, and candles. Population, in 1897, 20,750, about 50 per cent. Jewish. Polotsk was the capital of a mediæval principality, which was absorbed by Lithuania. In the sixteenth century it was a prosperous and splendid city, but it was subsequently ruined by war and plague. It was taken by Russia in the first partition of Poland in 1772. It was the scene of severe conflicts between the Russians and the French during the Napoleonic invasion of Russia in 1812.

POLTAVA, pól-tá'vá, or **PULTOWA**, pul-tá-vá. A government of Little Russia, bounded by the Government of Tchernigov on the north, Kharkov on the east, Ekaterinoslav and Kher-son on the south, and Kiev on the west (Map: Russia, D 5). Area, about 19,090 square miles. The surface is undulating, slightly elevated in the north, and with a general incline toward the valley of the Dnieper in the southwest. It belongs to the basin of the Dnieper, by which river it is skirted on the southwest. The climate is moderate and steady, the annual temperature at Poltava, the capital, averaging about 46°. Poltava belongs to the black-soil region of European Russia and is one of the chief grain-producing districts of the Empire. Agriculture is the principal occupation and is carried on on very primitive lines, modern machinery and fertilizers being confined principally to large estates. The leading products are rye, oats, and wheat. They are raised in quantities far above the domestic demand. The sunflower and flaxseed are cultivated for the production of oil, and tobacco-raising is important. The vegetables of Poltava, especially the melons, are famous all over Russia. Stock-raising, especially the breeding of

horned cattle, is of great importance, since oxen are used chiefly as draught animals and for agricultural purposes.

The government has few manufacturing industries, and they are connected with agriculture or gardening. The principal manufactures are flour, oil, tobacco, sugar, spirits, etc. Population, in 1897, 2,794,727, over 95 per cent. Little Russians, Jews, Poles, and Germans. Capital, Poltava. The Russians began to settle in the region in the tenth century, but their settlements were destroyed during the Mongol invasion and the territory was taken possession of by Lithuania in the fourteenth century. Later it passed to Poland. By the Andrussovo Treaty (1667) it fell to Russia. The present government was formed in 1802.

POLTAVA, or **PULTOWA**. The capital of the government of the same name, Little Russia, on the Vorskla River, about 70 miles southwest of Kharkov (Map: Russia, D 5). Outside of the town is situated a monastery dating from 1650. Near it is the monument commemorating the victory of the Russians over the Swedes, and known as the Swedish Tomb. The educational institutions of the town comprise two gymnasia, a real-school, a cadet corps, an institute for daughters of noblemen, a seminary for priests, and a number of Jewish schools. Industrially the town is only of slight importance, and its fairs have practically lost their former significance. Population, in 1897, 53,060, including a considerable number of Jews. Poltava is famous as the scene of the signal victory of the Russians under Peter the Great over the Swedes under Charles XII., on July 8, 1709.

POLYÆNUS (Lat., from Gk. Πολύαινος, *Polyainos*) (c.85-c.170). A Greek rhetorician of the second century. He was born in Macedonia, lived in Rome, and about 163 wrote in Greek a work entitled *Stratagemata*. Of its eight books, two are lost. The sources also are mostly gone, so that the work contains much historical information for which there is no other authority. It was edited by Casaubon (1589) and by Wölfflin (1887).

POLYANDRY (from Gk. πολυανδρία, *polyandria*, populousness, from *πολύανδρος*, *polyandros*, having many men, from *πολύς*, *polys*, much, many + *άνήρ*, *anēr*, man). That form of marriage and the family in which a woman has more than one husband at a time. There are two well-marked types of polyandry, in one of which, called Nair polyandry, the husbands are usually not related to one another, and the Tibetan, or fraternal polyandry, in which the husbands are brothers. Either of these forms may shade into a relationship which would have to be described as a combination of polyandry and polygyny, each husband having more than one wife, as each wife has more than one husband. A family scheme similar to this existed in the Hawaiian Islands when they first became known to Europeans, and was there known as the Punaluan family, and this name has been adopted into ethnology. In one or another form polyandry has been widely distributed. It has only lately disappeared from Ceylon, New Zealand, New Caledonia, and elsewhere in the Pacific islands. It is still found in the Aleutian Islands, among the Koryaks north of the Okhotsk, and among the Zaporogian Cossacks. In Africa it is found

among the Hottentots, among the Damaras, and among mountain tribes of the Bantu race, and traces of it remain among the Hovas of Madagascar. Cæsar notes its existence in his day among the Piets and the Irish, and many evidences of its former occasional existence in other Aryan stocks and throughout the Semitic and the Hamitic races have been brought together by McLennan, Spencer, and W. Robertson Smith.

The studies of McLennan led him to the conclusion that polyandry, originating in poverty and female infanticide, was the first form of marriage, in a true sense of the word. (See MARRIAGE.) Westermarek and Crawley among influential writers have disputed McLennan's theories, but the investigations of Spencer and Gillen among the native tribes of Central Australia have tended to confirm them in some important particulars. Apparently the earliest relations of men and women in primitive hordes were such that in a nominal sense all women were wives of all men, but that, so far from actual promiscuity being the practice, a temporary mating was usual. That this arrangement was not in fact exclusive of polyandry, as Westermarek has regarded it, is shown by Australian customs, where a wife who consorts with the elder of two or more brothers so long as he is present in camp consorts with a younger brother during the absence of the elder. It is impossible to say with certainty whether the Nair polyandry of Southern India or the Tibetan polyandry is the older. Probably the Punaluan relationship preceded the polyandry in which one woman is shared by two or more men without any corresponding polygyny, and, if so, fraternal polyandry is older than that in which husbands are unrelated. The Jewish custom of the Levirate, or obligation to marry a brother's widow, has been regarded as a survival of polyandry, but, as Spencer has shown (*Principles of Sociology*), it admits of another explanation. For bibliography, see MARRIAGE.

POLYANTHUS (Neo-Lat., from Gk. πολυανθος, having many flowers, from *πολύς*, *polys*, much, many + *άνθος*, *anthos*, flower). A hardy perennial plant—often called garden polyanthus—much prized and cultivated in gardens. It has been developed from *Primula variabilis*, which itself is a hybrid between the common primrose (*Primula vulgaris*) and the English cowslip (*Primula officinalis*). The numerous flowers are borne above the foliage in an umbel supported on a common leafless flower stem, or scape. It exhibits a great variety of delicate and beautiful colors. The varieties are innumerable. If a particular color is to be preserved the plants are propagated by divisions. A rich soil, shade, and moisture are most suitable.

POLYBIUS (Lat., from Gk. Πολύβιος) (c.205-c.120 B.C.). The chief Greek historian of the Hellenistic period. He was born at Megalopolis, in Arcadia, and was the son of Lycortas, a general of the Achæan League and an intimate friend of Philipæmen. His birth and great talent early secured him important political positions in his native city. In B.C. 181 he was chosen as member of the embassy which was to visit Alexandria, but which was afterwards given up; and in 169 he held the office of hipparch in the Achæan League. After the conquest of Macedonia in 168, he was one of the thousand noble and influential Achæans who were taken to Rome as hostages.

There he remained seventeen years. Through some good fortune he soon gained the friendship of Æmilius Paulus and his sons, with whom he resided during a large portion of his exile. The young Scipio Æmilianus became strongly attached to him and took him as companion on his journeys in Northern Italy and also in his military expeditions against the Celtiberians in Spain. In 150, together with his fellow-exiles, he was allowed to return to his home, but during the Third Punic War he rejoined Scipio, accompanied him on his African campaign, and was present at the destruction of Carthage in 146. The outbreak of war between the Achæans and Romans called him again to Greece, where he was of the greatest service through his influence with the Romans in procuring favorable terms for the vanquished. So grateful were his countrymen for his services, in their behalf that Megalopolis, Mantinea, and many other towns erected statues in his honor. It is said that he met his death by a fall from a horse.

Polybius's chief work is his *Histories* in 40 books, of which the first five have come down to us complete; we also have considerable portions of the first 18 books, preserved in a codex of Urbino and also the important excerpts of Constantinus Porphyrogenitus. The subject of this history was the gradual extension of the Roman Empire from B.C. 266. Polybius devoted the first two books of his work to an introductory sketch of Rome and Carthage from 266 to 221. From this point it is a general history of the times, including the important events in Greece, Asia, and Libya, as well as in the West. The history to 168 B.C. occupied books 3-30, while the last ten books brought the history down to the year 146. Polybius seems to have begun his work as early as 150, and the composition of it apparently extended over some 25 years.

Polybius is the first great example of a writer of history on the pragmatic method. He endeavored not simply to present facts, but also to ascertain the causes of these facts, and to draw from them lessons valuable for the future. On the other hand, his tone is too didactic in general, and the continuity of his narrative is too often interrupted by digressions. His style is clear, but without grace or charm; he incurred the censure of later Greek critics for carelessness in the choice of words and in the structure of sentences. His work, however, marked an epoch in the history of Greek literary style, for with it begins the period of the so-called 'common' dialect, a slightly modified Attic. The best annotated edition is by Schweighäuser in 8 vols. (Leipzig, 1789-95); critical editions by Bekker (Berlin, 1844), Dindorf (last edition, Leipzig, 1882-89), and also by Hultsch (2d ed., ib., 1888; English translation by Shuckburgh, London, 1889). Consult: Scala, *Die Studien des Polybius* (Leipzig, 1890); Cuntz, *Polybius und sein Werk* (ib., 1902).

POLYBOTES (Lat., from Gk. Πολυβώτης). A giant pursued by Poseidon after the struggle with the gods, and buried under a portion of the island of Cos, which Poseidon tore away and hurled upon him.

POLYBUS (Lat., from Gk. Πόλυβος). A king of Corinth and foster-father of Ædipus (q.v.).

POLYCARP (Lat. *Polycarpus*, from Gk. Πολύκαρπος, *Polykarpos*) (c.69-155). Bishop of

Smyrna and one of the most celebrated early Christian martyrs. Such meagre information as we have about his life is drawn chiefly from Irenæus, Eusebius, and the anonymous *Martyrdom of Polycarp*. As a youth he came in contact with the Apostle John, and thus he constitutes an important link between him and Irenæus (q.v.). When Ignatius passed through Asia Minor on his way to death in Rome early in the second century, he visited Polycarp, then already Bishop of Smyrna, and to him he afterwards addressed a letter. (See *IGNATIUS OF ANTIOCH.*) So far as we know, most of Polycarp's life was passed in the peaceful administration of his see. One of his last acts was to visit Anicetus, Bishop of Rome, to confer with him respecting the time of celebrating Easter (q.v.). Soon after his return to Smyrna Polycarp was arrested by the officers of the Roman Government, tried on the charge of being a Christian, and condemned to death by burning. He suffered martyrdom on February 23, 155 (not 166, as was formerly supposed), at the advanced age of eighty-six years, and perhaps older. Such was the sanctity of his life and such his heroism in martyrdom, that his memory and his relics were always held in the deepest veneration. Polycarp is said to have written several letters, only one of which, however, that to the Philippians, has come down to us. Its authenticity has been doubted, but on insufficient grounds. The Epistle is extant partly in the original Greek, and as a whole in a loose Latin translation. The *Martyrdom of Polycarp* is an early document, giving a probably authentic account of his trial and death. Both these works are included among the Apostolic Fathers, and may be read, in English translation, in Harmer's one-volume edition of Lightfoot's *Apostolic Fathers* (London, 1898). Consult: Lightfoot, *The Apostolic Fathers*, part ii., *Ignatius and Polycarp* (2d ed., London, 1889); Cruttwell, *Literary History of Early Christianity* (London, 1893); Funk, *Patres Apostolici* (Tübingen, 1901); Harnack, *Chronologie der altchristlichen Litteratur* (Leipzig, 1897).

POLYCHROME BIBLE (from Gk. πολύχρωμος, *polychromos*, many-colored, from πολυς, *polys*, much, many + χρώμα, *chrōma*, color). An edition of the books of the Old Testament printed in different colors, to show the various literary sources represented; according to the view of modern scholars. The series has been issued in both Hebrew and English under the general editorship of Prof. Paul Haupt of Johns Hopkins University, with the help of some of the foremost scholars of Europe and America.

POLYCHRONICON (Neo-Lat., from Gk. πολύς, *polys*, much, many + χρονικός, *chronikos*, relating to time, from χρόνος, *chronos*, time). A history of the world from the creation down to the year 1342 by Ranulf Higden, a Benedictine monk, who died about 1363. It was very popular as late as the fifteenth and sixteenth centuries.

POLYCLITUS (Lat., from Gk. Πολύκλειτος, *Polykleitos*). A Greek sculptor in bronze. He is called by Plato and other ancient writers an Argive, and was certainly the representative of that school in Greek art. The only authority for his birth at Sicyon is Pliny, who seems to have drawn on a history by a Sicyonian, who claimed for his native city the honor of the greatest Argive artist. The only certain date in his life

is that of the great chryselephantine statue of Hera at Argos, which was erected in the new temple built in place of the sanctuary burned in *n.c.* 433. The new temple was built at once, and the statue can scarcely be much later than *n.c.* 420. It is possible that the statue of Zeus Meilichios at Argos was a later work, and the Amazon of Ephesus, which seems to belong with similar statues by Phidias, Cresilas, and Phradmon, is probably a work of about *n.c.* 440. The general character of his Doryphorus (or Spear-bearer) also indicates a date not long after the middle of the fifth century. This evidence agrees well with the ancient statements that Polyclitus was a younger contemporary of Phidias. That he was a pupil of Ageladas, the founder of the Argive school, is very doubtful on chronological grounds. In technical skill, delicacy of finish, and beauty of line he ranked with the greatest artists of his time, but ancient critics missed in his works the sublimity which marked the statues of Phidias. He followed in the lines already characteristic of the Peloponnesian school. His figures are marked by a powerful muscular frame, rather thick-set in proportion to the height, while the face is rather square than oval, with broad brow, straight nose, and small chin, with the lines sharply defined, presenting a somewhat striking contrast to the fine oval which is characteristic of the Attic school. A careful student of proportions, Polyclitus embodied his theories not only in writing (if this is the meaning of the canon attributed to him), but in his statues, and especially in the Doryphorus, of which the best marble copy is in Naples, while the head is represented in a bronze bust from Pompeii. Of the same character, but softer in its lines, is the Diadumenos, or youth binding a fillet round his brow, which is preserved in several marble replicas, of which the best was found in a private house on the island of Delos. His Amazon is almost certainly reproduced in the marble of Berlin, and his strongly marked characteristics in form and pose render it possible to attribute to him or his school the originals of a number of other works. A younger Polyclitus, possibly a nephew of the great sculptor, flourished in the next century, and enjoyed a high reputation not only as a sculptor, but likewise as an architect. He built the theatre in the sanctuary of Aesclepius at Epidaurus, greatly and justly famed for the beauty of its proportions, and the Tholos, or circular building, of which the use is uncertain, at the same place.

Consult the histories of Greek sculpture cited under GREEK ART; Furtwängler, *Masterpieces of Greek Sculpture*, translated by E. Sellers (London and New York, 1895); Mähler, *Polyklet und seine Schule* (Leipzig, 1902).

POLYCRATES (Lat., from Gk. Πολυκράτης, *Polykrates*). A tyrant of Samos, born in the first part of the sixth century. Nothing is known of him until about *n.c.* 535, when with the assistance of his brothers, Pantagnotus and Syloson, and a small band of conspirators, he seized the government of the island. After a short time Polyocrates made himself sole despot, conquered several islands of the archipelago, and even some towns on the Asiatic mainland, waged war successfully against the inhabitants of Miletus, and defeated their allies, the Lesbians, in a great sea-fight. His fleet, which was probably the most powerful in all Greece, amounted to

one hundred armed ships, and he had a force of 1000 mercenary bowmen. He was in intimate alliance with Amasis, King of Egypt, but this was ultimately broken off—according to Herodotus, by Amasis, who became alarmed at the uninterrupted good fortune of Polyocrates. He is reported to have written a letter to Polyocrates, earnestly advising him to throw away the possession that he deemed most valuable, and thereby avert the displeasure of the envious gods. Polyocrates, in compliance with this advice, cast a signet-ring of marvelously beautiful workmanship into the sea; but a fisherman presented the tyrant with an unusually big fish that he had caught, and in its belly was found this same ring. It was quite clear to Amasis now that Polyocrates was a doomed man, and he immediately broke off their alliance. Grote suggests that Polyocrates, with characteristic perfidy, abandoned the Egyptian for a Persian alliance when he found the latter likely to be of more value to him in his ambitious designs. When Cambyzes invaded Egypt (*n.c.* 525) Polyocrates sent him a contingent of 40 ships, in which he placed all the Samians disaffected toward his tyranny, telling the Persian King not to let them come back. They escaped in some way or other the fate which Polyocrates had designed for them, returned to Samos, and made war against the tyrant, but without success. Hereupon, they went to Sparta and succeeded in securing the help of both the Spartans and Corinthians. A triple force of Samians, Spartans, and Corinthians embarked for Samos, and attacked the capital. After vainly besieging it for forty days they sailed away, and Polyocrates now became more powerful than ever. But a certain Oroetes, Persian satrap of Sardis, had, for unknown reasons, conceived a deadly hatred against Polyocrates, and having, by appealing to his cupidity, enticed the latter to visit him, he seized and crucified him, about *b.c.* 522. Polyocrates was a patron of literature and the fine arts, and had many poets and artists about his Court, among the former being Anacreon.

POLYD'AMAS (Lat., from Gk. Πολυδάμας). (1) One of the Trojan heroes, son of Panthous, and friend of Hector. (2) A Thessalian victor in the Paneraticum in the Olympic games of *b.c.* 408, noted for his size and enormous strength, which caused him to be invited to the Court of Darius Ochus.

POLYDEC'TES (Lat., from Gk. Πολυδέκτης, *Polydektēs*). The son of the King of the island of Seriphus, turned into a stone by Perseus with the head of Medusa for attempting to force Danaë to marry him.

POLYDEU'CES. See CASTOR AND POLLUX.

POLYDIPSIA (Neo-Lat., from Gk. πολυδίψιος, *polydipsios*, very thirsty, from *πόλις*, *polys*, much, many + *δίψα*, *dipsa*, thirst). Excessive thirst is a symptom of most diseases attended by a high temperature, but particularly of diabetes mellitus and insipidus, which are characterized by a constant desire for drink. On this account the insipid form has been called polydipsia, although the term is no longer used in this sense. In diseases attended with profuse watery discharges from the bowels, as cholera Asiatica, excessive thirst is a prominent symptom, and an unusual desire for fluids is common in chronic gastritis and cancer of the stomach. See DIABETES.

POLYCLITUS AND PRAXITELES



1. HEAD OF THE DORYPHORUS. Copy in Bronze, Naples Museum.
2. AMAZON OF POLYCLITUS, Copy in Marble, Berlin Museum.
3. UPPER PORTION OF THE HERMES OF PRAXITELES, Original, Marble, Olympia Museum.
4. UPPER PORTION OF THE FAUN OF PRAXITELES, from the Capitoline Museum, Rome.

POLYDORE. (1) The name assumed by Guiderius in Shakespeare's *Cymbeline*. (2) The brother-in-law of Monimia in Otway's tragedy *The Orphan*, who personated her husband on her wedding night, and killed himself on discovering her secret marriage.

POLYEUCTE, pó'lé-ékt'. (1) A tragedy in five acts by Corneille, published with a dedication to Anne of Austria in 1642. Polyucte is the husband of Pauline, daughter of the Roman proconsul Felix, who is commissioned to persecute the Christians, and is forced to put his son-in-law to death, in spite of his daughter's pleadings. Pauline, after her husband's martyrdom, is converted to his faith, and in turn influences Felix to embrace Christianity. The character of Pauline is one of Corneille's finest creations. (2) An opera in five acts by Gounod (1878) with libretto by Barbier and Carré.

POLYG'ALA (Lat., from Gk. πολύγαλον, *polygalon*, milkwort, from πολίς, *polys*, much, many + γάλα, *gala*, milk). A large genus of annual and

perennial herbs and small shrubs of the natural order Polygalaceæ, natives chiefly of warm and temperate climates. *Polygala vulgaris*, common milkwort, is a small perennial plant, with an ascending stem, linear-lanceolate leaves, and terminal racemes of small but beautiful blue, pink, or white flowers, having a finely crested keel. It grows in dry hilly pastures. Many species are natives of North America. *Polygala Senega* is a North American species with erect, simple, tufted stems, about one foot high, and terminal racemes of small white flowers. The root, which is woody, branched, contorted, and about half an inch in diameter, is the senega-root, seneka-root, or snake-root of the United States, famous as an imaginary cure for snake-bites. *Polygala crotalaroides* is similarly employed in the Himalayas. In the United States the roots of *Polygala alba*, *Polygala Boykinii*, and others which are



SENECA SNAKEROOT (*Polygala Senega*).

considered inferior as drugs to *Polygala Senega* are often collected and mixed with that species. The bark of the roots of *Monnina polystacha* and *Monnina salicifolia* is used in Peru as a substitute for soap.

POLYGAMY (from Gk. πολυγαμία, *polygamia*, plural marriage, from πολύγαμος, *polygamos*, much married, from πολίς, *polys*, much, many + γάμος, *gamos*, marriage). That form of marriage and the family in which a man has two or more wives. Strictly speaking, polygamy, meaning plural marriage, includes polyandry (more than one husband) as well as polygyny (more than one wife). Polygyny is found in all climes and among all races: Fuegians, Australians, Negritos, the Malayo-Polynesians, American Indians, and peoples of Africa. It flourishes in China and in Turkey, and in former ages it prevailed among the peoples of Western Asia. It seems not to have been practiced to any extent by Greeks or Romans, and its occurrence among Celts and Germans was occasional. Tacitus says of the Germans of his day that "almost alone among barbarians" they "are content with one wife;" but he notes a few exceptions of noble birth. Polygamy has never been the only family form in any tribe or nation. Usually it has been only the relatively well-to-do and the powerful that have maintained polygamous families, while the majority of men and women have commonly lived in monogamous relations, the very poor resorting at times to polyandry. Under some conditions polygamy has been favored on economic grounds. Where a simple agricultural industry is carried on by women, as in parts of Africa and of North America, the possession of many wives may mean not mere luxurious expenditure, but increase of productive power. Ancestor worship was favorable to polygamy because failure of the first wife to bear sons was equivalent to bringing the supreme purpose of the family to naught. The line of the family priesthood was broken. In other ways also the religious sanction has been appealed to. The Mormons, for example, have regarded the multiplication of offspring as the supreme duty. See MARRIAGE.

POLYGLOT (ML. *polyglottus*, from Gk. πολύγλωττος, *polyglōttos*, πολύγλωσσος, *polyglōssos*, speaking many tongues, from πολίς, *polys*, much, many + γλῶττα, *glōtta*, γλῶσσα, *glōssa*, tongue, language). A book containing the same subject matter in more than one language, generally arranged for convenience in parallel columns. Of such books editions of the Bible are most common, and are generally meant by the term polyglot. Various versions of the Hebrew Old Testament (such as the *Hexapla* of Origen, q.v.) and the Greek New Testament were united for convenience at various times. Using the term strictly, there are four great polyglots: (1) The *Complutensian Polyglot*, in six folio volumes, begun in 1502, printed from 1513 to 1517 at Alcalá de Henarez (the Roman Complutum, whence the name Complutensian), Spain, and published under Papal permission in 1520. Famous Spanish scholars edited the work, which was under the general oversight of Cardinal Ximenes. This polyglot contains the Old Testament in Hebrew, the Targum of Onkelos on the Pentateuch, the Septuagint, the Vulgate, and the Greek New Testament. Six hundred copies were printed. (2) The *Antwerp Polyglot*, *Biblia Regia*, issued from the famous Plantin printing house in Antwerp. This was prepared under Spanish auspices also, Philip II. bearing the cost and sending the scholar Arias Montanus to Antwerp to edit it. It is in eight folio volumes, appeared from 1569 to 1572, and contains the Hebrew and Greek of

the Old Testament, the Targum of Onkelos, and other Aramaic paraphrases, the Vulgate, and the Greek and a Syriac version of the New Testament. It is of no special value for purposes of historical criticism, and is rare now owing to the early loss of a great many copies by accident. (3) The *Paris Polyglot*, in ten great folio volumes, issued between 1628 and 1645 in Paris by Antoine Vitré at the expense of Guy Michel le Jay. Its critical value is very slight. It presents the Samaritan Pentateuch, another Syriac, and an Arabic version of the Old Testament, in addition to the material contained in the Antwerp volumes. (4) The *London or Walton's Polyglot*, published in six folio volumes, from 1654 to 1657, under the editorship of Brian Walton. The first copies were dedicated to Oliver Cromwell, who had been personally interested in their publication and had allowed the paper on which they were printed to be imported without duty. The second set was dedicated to King Charles II. and the former patron, Cromwell, is branded as 'the great Dragon.' It contains the entire Bible, or some portion of it, in Hebrew, Samaritan, Aramaic, Syriac, Arabic, Ethiopic, Persian, Greek (with a literal Latin translation of each), and Latin. This is the most valuable polyglot ever issued. The greatest scholars worked upon it, and Walton's *Prolegomena* is a very able work which has been republished (Canterbury, 1828). A dictionary of all the languages represented except the Greek and Latin, called *Lexicon Heptaglotton*, was published by Edmund Cartell in 1669. Of minor polyglots mention may be made of *Bagster's* (London, 1831), which contains the entire Bible in Hebrew, Greek, English, Latin, French, Italian, Spanish, and German, with a Syriac version of the New Testament in addition. Consult Tregelles, *An Account of the Printed Text of the Greek New Testament* (London, 1854).

POLYGNŌTUS (Lat., from Gk. Πολύγνωνος). A distinguished Greek painter of the second quarter of the fifth century B.C. He was the son of Aglaophon, and a native of the island of Thasos, where his family were artists. He seems to have come to Athens shortly after the Persian wars, and found abundant scope for his talents in the decoration of the great buildings which mark this period. Along with the Ionian Micon, and Pananos, brother of Phidias, he is said to have decorated the Theseum, Stoa Pæcile (or painted portico), and Anakeion, or temple of the Dioscuri, with paintings from legend and recent history, though the division of the paintings among the artists was not certain. The first building contained the battles of the Athenians with the

Theseus with the Amazons, the battle of Marathon, and the victory of the Athenians and Argives over the Spartans at (Enoe, of which the second was by some attributed to Polygnotus. In the Anakeion he painted the Dioscuri carrying off the daughters of Leucippus. In the temple of Athena Areia at Plataea was a painting by him representing the slaughter of the suitors by Odysseus, and some frescoes in the Propylæa at Athens were attributed to him. Most celebrated and best known from the descriptions by Pausanias are the great paintings in the Lesehe (or porch) at Delphi, representing the departure of the Greeks from Troy and the descent of Odysseus to the lower world. As is clear from these subjects, Polygnotus devoted himself to extensive compositions containing many figures whose grouping and characterization required careful study. At the same time his means were simple. Black, white, red, yellow, blue, and green were his colors, light and shade were unknown, and the strength of the artist lay in his beauty of outline and coloring, and above all in his delineation of character. His subjects led him to arrange his figures on various levels, and for this reason he chose when possible sloping ground, which could be easily indicated by waving lines and the partial concealment of some figures. His influence was very marked not only on painting, as is clear from a group of Attic vases, but also on sculpture, and it is probable that the reliefs at Tryso (Gyöl-bashi) reflect his art, or that of the Ionian school, of which he was the greatest exponent.

Consult Brunn, *Geschichte der griechischen Künstler* (Stuttgart, 1853-59). The earlier works on the paintings of Polygnotus, though of some value, are in general superseded by later investigations, especially those of Robert, Schöne, Schreiber, and Weizsäcker: Robert, *Die Nekyia des Polygnot* (Halle, 1892); *Die Iliupersis des Polygnot* (ib., 1893); *Die Marathonschlacht in der Poikile und Weiteres über Polygnot* (ib., 1895); Schöne, "Zur Polygnots delphischen Bildern," in *Jahrbuch des archäologischen Instituts* (Berlin, 1893); Schreiber, *Die Wandbilder des Polygnot in Delphi* (Leipzig, 1897); Weizsäcker, *Polygnot's Gemälde in der Lesche der Knidier in Delphi* (Stuttgart, 1895). For reconstructions, see Robert, and *Wiener Vorlegeblätter* (Vienna, 1888).

POLYGON (Lat. *polygonum*, from Gk. πολύγωνον, *polygōnon*, polygon, neu. sg. of πολύγωνος, *polygōnos*, having many angles, from πολύς, *polys*, much, many + γωνία, *gōnia*, angle). If the two end-points of a broken line coincide, the figure ob-

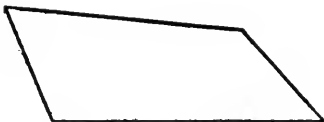

CONVEX.



CONCAVE.

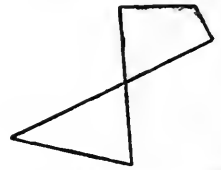

CROSS

Amazons, and of the Lapithæ with the Centaurs, and the descent of Theseus to Amphitrite in the depths of the sea. In the Stoa were represented the capture of Troy and the council of the Greeks to judge Ajax for his outrage on Cassandra, which was certainly by Polygnotus, also the bat-

tained is called a *polygon*, and the broken line its *perimeter*. The vertices of the angles made by the various segments of the perimeter are called the *vertices* of the polygon, and the segments themselves the *sides* of the polygon. The perimeter of a polygon divides the plane into two

parts, one finite (the part inclosed), the other infinite. The finite part is called the surface of the polygon, or for brevity simply the polygon. A polygon is said to be *convex* when no side produced cuts the surface of the polygon, *concave* when a side produced cuts the surface of the polygon, and *cross* when the perimeter crosses it-

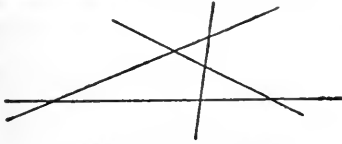

A GENERAL QUADRILATERAL.

equals $(n - 2)$ straight angles. The sum of the exterior angles equals a perigon, or 360° . In concave polygons certain exterior angles lie inside of the polygon and are taken as negative according to the principle of continuity. The number of diagonals of a simple convex polygon is $\frac{n(n-3)}{2}$, n being the number of sides. If a

polygon of an even number of sides be circumscribed about a circle, the sums of its even and odd sides are equal; and if a polygon of an even number of sides be inscribed in a circle, the sums of its even and odd angles are equal. The inscription and circumscription of regular polygons depend upon the partition of the perigon. Thus to inscribe an equilateral triangle in a circle depends upon trisecting the circumference, hence the perigon at the centre. It was known as early as Euclid's time that the perigon could be divided into $2^n, 3 \cdot 2^n, 5 \cdot 2^n, 15 \cdot 2^n$ equal angles, and no other partitions were deemed possible by the use of the straight edge and compasses. But in 1796 Gauss found, and published the fact in 1801, that a perigon could also be divided into $17 \cdot 2^n$ equal angles; furthermore, that it could be divided into $2^m + 1$ equal angles if $2^m + 1$ represents a prime number; and, in general, that it could be divided into a number of equal angles represented by the product of different prime numbers of the form $2^m + 1$. Hence it follows that a perigon can be divided into a number of equal angles represented by the product of 2^n and one or more different prime numbers of the form $2^m + 1$. It is shown in the theory of numbers that if $2^m + 1$ is prime, m must equal 2^p ; hence the general form for the prime numbers mentioned is $2^{2^p} + 1$. Elementary geometry is thus limited to the inscription and circumscription of the regular polygons mentioned. Consult Klein's *Famous Problems of Elementary Geometry* (American edition, Boston, 1897).

self. The word polygon, in elementary geometry, is understood to refer to a polygon that is not cross unless the contrary is stated. If all of the sides of a polygon are indefinitely produced, the figure is called a *general* polygon. If a polygon is both equiangular and equilateral it is said to be *regular*. A polygon is called a tri-

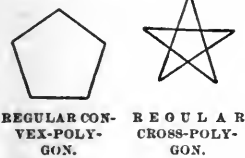

angle, quadrilateral, pentagon, hexagon, heptagon, octagon, nonagon, decagon. . .dodecagon. . . pentadecagon. . . n -gon, according as it has 3, 4, 5, 6, 7, 8, 9, 10, . . .15, . . . n sides.

According to the principle of continuity (q.v.) polygons may be regarded as positive or as negative. E.g. consider the triangle ABC, which is, in general, regarded as positive. If C moves down

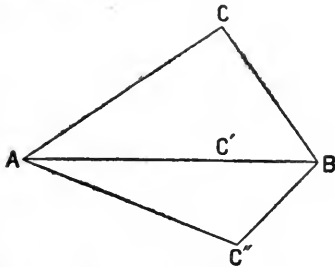

POL'YGONA'CEÆ (Neo-Lat. nom. pl., from Lat. *polygonum*, from Gk. *πολύγωνον*, knot-grass, polygony, neu. sg. of *πολύγωνος*, *polygonos*, prolific, from *πολύς*, *polys*, much, many + *γόνος*, *gonos*, seed). THE BUCKWHEAT FAMILY. A natural order of about 30 genera and 750 species of widely distributed dicotyledonous herbs, a few shrubs and trees, particularly abundant in the temperate regions of the Northern Hemisphere. The principal genera are *Chorizanthe*, *Eriogonum*, *Rumex*, *Rheum*, *Polygonum*, *Fagopyrum*, and *Coccoloba*. The genus *Polygonum*, which is typical of the order, consists of about 150 species, mostly weeds. Knot-grass (*Polygonum aviculare*) is one of the most extensively distributed

to rest on AB, then $\triangle ABC'$ becomes zero; and as C passes through AB $\triangle ABC$ passes through zero and is considered as having changed its sign and become negative; that is, $\triangle AC'B$ is negative. In the case of polygons in general, the law of signs will readily be understood from the annexed figures. In Figs. 1, 2, 3, both the upper and lower parts of the polygon are considered



FIG. 1.



FIG. 2.

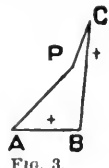

FIG. 3.

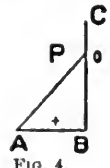

FIG. 4.



FIG. 5.

as positive; in Fig. 4, P has reached BC and the upper part of the polygon has become zero; in Fig. 5, P has passed through BC and the upper part of the figure has passed through zero and become negative.

The sum of the interior angles of a polygon

plants of the world; it is an annual of low growth, but very variable, with much branched trailing stems, small lanceolate leaves, and very small flowers, two or three together, in the axils of the leaves. Thunberg says that in Japan a blue dye is prepared from the plant. *Polygonum*

amphibium, one of the species of the section or suborder *Persicaria*, is abundant about margins of ponds and ditches throughout the Northern Hemisphere. It has two forms of leaves; those upon the erect stems being broad and smooth, those which float in the water narrow and rough, differences which might be held to indicate distinct species, yet both may be found growing from one root. The stems have been used on the Continent of Europe as a substitute for sarsaparilla. Several species are occasionally used for dyeing, as the spotted persicaria (*Polygonum Persicaria*), a very common weed on manure heaps and in waste places in Europe and also naturalized in the United States. The only species really important on this account is that called dyers' buckwheat (*Polygonum tinctorium*), a Chinese biennial, with ovate leaves and slender spikes of reddish flowers. It has been successfully cultivated in France and Flanders. It yields a blue dye scarcely inferior to indigo. *Coccoloba*, another genus of this order, has a wide distribution throughout the tropics, *Coccoloba uvifera* and other species producing edible fruits.

POLYGONAL NUMBERS. See NUMBER.

POLYHEDRON (from Gk. Πολύεδρος, *polyedros*, having many bases, from πολῖς, *polys*, much, many + ἔδρα, *hedra*, base). A solid whose bounding surface consists entirely of planes. The polygons which bound it are called its *faces*; the sides of those polygons, its *edges*; and the points where the edges meet, its *vertices*. If a polyhedron is such that no straight line can be drawn to cut its surface more than twice, it is said to be *convex*; otherwise it is said to be *concave*. Unless the contrary is stated the word polyhedron means convex polyhedron. If the faces of a polyhedron are congruent and regular polygons, and the polyhedral angles are all congruent, the polyhedron is said to be *regular*. A polyhedron which has for bases any two polygons in parallel

having 8 faces, 6 vertices, and 12 edges, the equation becomes $12 + 2 = 8 + 6$. For every polyhedron there is another which, with the same number of edges, has as many faces as the first has vertices, and as many vertices as the first has faces. There cannot be more than five regular convex polyhedra. These solids are represented by the accompanying figures, and are sometimes known as the Platonic bodies, from the attention they received among the Platonists.

For these five polyhedra, if *s* be the number of sides in each face, *n* the number of plane angles at each vertex, then, following the other notation above given, $sf = n \cdot v = 2e$. Also the sum of all the plane angles in each figure is $2\pi(v - 2)$. These formulas may easily be verified from the following table of elements:

NAME OF SOLID	s	n	f	v	e
Tetrahedron.....	3	3	4	4	6
Hexahedron.....	4	3	6	8	12
Octahedron.....	3	4	8	6	12
Dodecahedron....	5	3	12	20	30
Icosahedron.....	3	5	20	12	30

The five regular polyhedra can be constructed from cardboard by marking out the following, cutting through the heavy lines and half through the dotted ones, bringing the edges together.

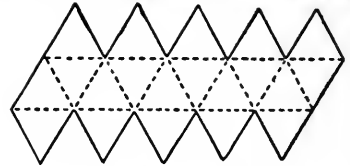

ICOSAHEDRON.

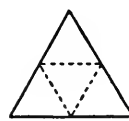

TETRAHEDRON.

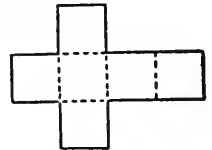

HEXAHEDRON.

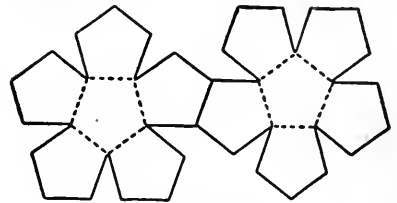

DODECAHEDRON.

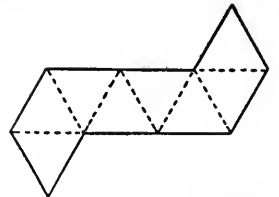

OCTAHEDRON.

Consult: Rouché et Camberousse, *Traité de Géométrie* (Paris, 7th ed., 1900); Eberhard, *Zur Morphologie der Polyeder* (Leipzig, 1891); Kirkman, "On the Theory of the Polyhedra," in the *Philosophical Transactions of the Royal Society* (London, 1862, vol. 152); Zeising, "Die regulären Polyeder," in the *Deutsche Vierteljahrsschrift* (Stuttgart, 1869, pt. 4).

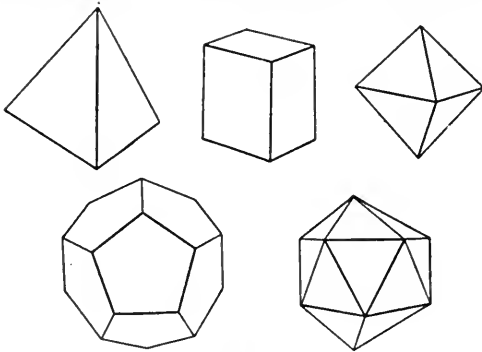

POLYHEDRA.

planes, and for lateral faces triangles or trapezoids which have one side in common with one base and the opposite vertex or side in common with the other base, is called a *prismatoid*. (See MENSURATION.) In accordance with the definition, also all prisms and pyramids (q.v.) are included among the prismatoids. Among the general relations of polyhedra, the following are the most remarkable: If a convex polyhedron has *e* edges, *v* vertices, and *f* faces, then $e + 2 = f + v$. (A theorem known to Descartes, but bearing Euler's name.) E.g., in a regular octahedron, a solid

POLYHYMNIA, or **POLYMNIA** (Lat., from Gk. Πολύμνια or Πολύμνια). One of the nine Muses (q.v.). When in late times the functions of the Muses were specialized, she became the Muse of the pantomime, and was represented without special attribute, but closely wrapped in her mantle, and sometimes with her hand upon her mouth.

POLYMASTODON (Neo-Lat., from Gk. πολύς, *polys*, much, many + μαστός, *mastos*, breast, + ὀδούς, *odous*, tooth). A fossil multi-tuberculate animal of the size of a beaver, of which fragmentary remains have been found in the basal Eocene or Puerco beds of New Mexico. The jaws and dentition have some resemblances to those of rodents.

POLYMORPHISM (from Gk. πολύς, *polys*, much, many + μορφή, *morphē*, form). The differentiation either of one animal into two or more incomplete undetached individuals (pseudoindividuals) or zooids, as in the Siphonophores or Physalia; or that of the animal into two separate sexes, or of the latter into castes, as in the termites and ants. Instead of the functions of the whole animal or plant being equally distributed to the individual organs, some of the organs or parts of the animal are set apart for this or that function. In the hydra the individual is monomorphic, not divided into male and female individuals, but in Hydractinia, a fixed, vegetative form, there arise sexual or reproductive zooids, some female and others male, and also hydra-like or nutritive zooids or incomplete individuals. In the Portuguese man-of-war (q.v.) we have a still better example of incomplete polymorphism. Thus, as Hertwig states, division of labor leads to greater centralization, "the more polymorphic an animal colony becomes, the more unified it is, the more it gives the impression of being a single animal instead of an aggregation of single animals."

In the hydroids alternation of generations (q.v.) has arisen from a division of labor or polymorphism of individuals originally of equivalent value, in which some individuals (the sexual ones) have separated and acquired a peculiar structure. Moreover, while alternation of generations has arisen from polymorphism, it can again produce it. Hertwig illustrates this by the case of certain medusæ, which, instead of separating, remain permanently attached to the colony. They then degenerate into 'sporesacs,' in which a mouth, tentacles, and a velum are wanting.

A second kind of polymorphism is that seen in the males and the females of most animals. This is sexual dimorphism, which may pass into sexual polymorphism. This is complete polymorphism. Reproduction by budding involves the differentiation of the animal form into three kinds of individuals—i.e. males, females, and 'neuters,' as among insects. Among the celenterates and worms the forms reproducing by parthenogenesis (q.v.) are usually larval or immature, as if they were prematurely hurried into existence, and their reproductive organs had been elaborated in advance of other systems or organs, for the sudden production, so to speak, of large numbers of individuals like themselves.

Among insects dimorphism is intimately connected with organic reproduction. Thus the summer wingless asexual aphid and the perfect winged autumnal aphid may be called 'dimor-

phic' forms. The perfect female may assume two forms, so much so as to be mistaken for two distinct species.

DIMORPHISM IN BIRDS. Besides ordinary sexual dimorphism, depending on sex, and comprised under the head of secondary sexual characters (see SEX; SEXUAL SELECTION), a few special cases are known, due probably to climate or local causes. Thus, in some species of skua, a particular bird may frequently be found mated with a uni-colored form, either male or female. In the guillemots at nearly every breeding station about one in twenty may be marked with a white circle around the eye, and a white line extending backward from it, these ringed or bridled guillemots being of either sex and apparently paired with birds of normal plumage, no intermediate forms being known. (See DICHROMATISM IN BIRDS.) A striking example of dimorphism in respect to the beak is furnished by the huia (q.v.).

DIMORPHISM AND POLYMORPHISM IN INSECTS. Although sexual dimorphism is very prevalent in insects, there are many instances of dimorphism, resulting from local causes, as temperature. (See TEMPERATURE VARIETIES, especially as relating to seasonal dimorphism, wet and dry forms.) Certain species of grasshoppers are dimorphic. In the honey-ant (*Myrmecocystus Mexicanus*), besides the usual workers, there occur individuals with enormous spherical abdomens filled with honey. Here the cause is evidently connected with the food. See, for other examples, EVOLUTION, paragraph *Polymorphism*.

The chief initial or determining causes of dimorphism and polymorphism, besides sexual selection (q.v.), are changes in temperature, of light, and of other physical agents.

POLYMORPHOUS (in geology). See ISOMORPHISM.

POLYNE'SIA (Neo-Lat., from Gk. πολύς, *polys*, much, many + νῆσος, *nēsos*, island). A name once applied to all the islands in the Pacific Ocean, lying between Asia and America. By modern geographers the name is used to designate a division of Oceania comprising all the islands not included under Micronesia or Melanesia. The most important of them are the Tonga, Samoan, Ellice, Cook, Society, Hawaiian, and Marquesas Islands, and Low Archipelago. The Fiji Islands are included by some in Polynesia and by others in Melanesia, all of which are described in separate articles. For a description of the inhabitants of these islands, consult: Stevenson, *In the South Seas* (New York, 1896); Beeke, *Wild Life in Southern Seas* (London, 1897); Mager, *Le monde polynésien* (Paris, 1902). See POLYNESIANS.

POLYNESIANS. A term used diversely by various writers. By some it is employed as a synonym of Malayo-Polynesian (q.v.) and made to include all the so-called brown race of the regions known as Malaysia, Micronesia, Melanesia, and Polynesia, also known as the Malayan race. F. Müller (1879) made the Poly-Melanesians one of the branches of his Malay race, while Brinton (1890) divides his Malay stock into a Western (Malayan) and an Eastern (Polynesian) group. Deniker makes the Polynesians properly so called one of the great ethnic groups of the Indo-Pacific area. Keane (1896) holds that the Eastern Polynesians are a branch of

the Caucasian division, who possibly in the Neolithic period migrated from the Asiatic mainland. In the best usage the term Polynesian may be considered to denote the section of the brown race inhabiting the innumerable islands of Micronesia, Polynesia proper, and parts of Melanesia, and in a special and particular sense the natives of the islands of the eastern Pacific, Hawaii, Elllice, Samoa, Tonga, Hervey, Society, Low, Marquesas, and minor groups, together with those of New Zealand.

Physically the Polynesians are a prepossessing race, being tall, symmetrically built, and handsome in form and feature—indeed, Dr. McGee tells us that “the Samoan excelled the Greek in bodily vigor and statuesque beauty.” The Maori of New Zealand is a good example of this race. The so-called Micronesians differ but little in physical type from the Polynesians of the eastern Pacific. The color of the Polynesians varies from dark brown to almost white, while their features are often reported as having a European cast, a fact which has been made the most of by the advocates of the Caucasian theory. The hair is dark, smooth, and straight, with here and there a tendency to curliness or crispiness, indicative perhaps of a strain of Papuan blood. Their naïveté, sensitiveness, hospitality, courage in battle (compare the Maoris), sensuality (e.g. Tahitians), skill in boat-building and navigation (Tongans and Samoans, in particular), love of outdoor games, swimming (Maoris, Hawaiians), eloquence in song and story, and other prominent qualities have been emphasized by different writers and travelers. The words *tattoo* and *taboo*, which have come into English from Polynesian languages, commemorate a custom and an institution widespread among them.

The chief industries of the Polynesians at the time of the coming of the Europeans were fishing, agriculture, and the exploitation of vegetable substances and fibres for clothing and ornament, art in wood, shell, etc., and the activities connected with boat-building and navigation. In certain parts of the Polynesian domain cooking was almost a fine art. Cannibalism was not infrequent. The great feasts of the Polynesians were an important factor in their social activities. Among characteristic expressions of Polynesian art and industry may be mentioned cocoa-fibre sennit (for wrapping axe-handles), the bamboo-knife, the ornamental and symbolic axes of the Hervey Islands, etc., the double canoe and the outrigger, the mat sail, *tapa* or bark cloth, feather-work, the stone figures (often of gigantic size), platforms, and edifices of Easter Island, Tonga, the Carolines, etc.—probably more numerous and occurring in more diverse regions of Polynesia than is generally believed—which have unnecessarily been looked upon by some writers as evidences of a great pre-Polynesian civilization, or attributed to Hindu or South American culture-bearers. The bamboo or stick maps of the Marshall Islanders and the stone ground maps of other places deserve to be noted, and so, too, the ‘temples’ and fortifications of a number of tribes, particularly the Maori *pahi*. Rock-sculptures exist in many places, and the celebrated ‘picture-writing’ of Easter Island (q.v.) has received much attention from ethnologists.

The dance and secret societies, profane and religious, have attained great vogue and development in Polynesia, where professional musicians,

singers, poets, and literary association have abounded. The lascivious side of the Polynesian character is represented by the *hula-hula* dance of Hawaii and the *areoi* societies of Tahiti. The ‘fire-walk’ ceremony still survives, especially in Tahiti. The marriage systems of the Polynesians varied at different times and places, from monogamy to polygamy, with all the grades between. A peculiar practice of the Hawaiians gave rise to L. H. Morgan’s recognition of the ‘Punaluan family’ as one of the stages in human social progress. (See POLYANDRY.) Much of the present sexual immorality of the Polynesians is due to contact with the whites.

In the matter of government and social organization, Polynesian peoples present all grades from democracy of an almost pure type to what might well be termed absolute and limited monarchies. Over a considerable portion of Polynesia the division into nobles and common people occurred as in mediæval Europe. In spite of the fearful ravages of vices and diseases introduced by the Europeans, the decreases due to the monopoly by the white man of the best land, etc., and other related causes, which in many cases of the island groups have practically depopulated some and decimated others, an increase of population is reported from certain sections both of English and French Polynesia.

All over the Polynesian area languages show the common origin from one parent stock, practically identical with the parent stock of the Malayan tongues, and proving a Malayo-Polynesian unity. The dialectic variations in Polynesian languages are to a large extent phonetic. The mythology, folk-lore, and primitive poetry of the various Polynesian peoples is rich and imaginative, cosmogonic tales and ancestor-myths, primitive epics and hero-stories being particularly abundant. Love-songs and political orations were extensively cultivated, while the *harepo*, or professional poet, was found in many of the larger groups. In its poetical and literary expression the Polynesian mind shows a combination of naïveté and metaphysics which is very curious.

Facts of language, mythology, art, general culture, and distribution of food-plants point to the peopling of the Polynesian area from the east to the west, with the Samoan group as the chief centre of dispersion. Their distribution over the vast extent of the Pacific was made possible by the seaworthiness and size of their vessels and their skill as navigators. They are comparatively recent intruders into an area that is itself geologically recent. Brinton (1890) places the separation of the Polynesian branch from the Malay at “about the beginning of our era.” According to Horatio Hale, the Marquesas Islands were peopled somewhat less than 2000 years ago, the Hawaiian group in the seventh century A.D., Rarotonga and the Gambier Islands in the thirteenth, and New Zealand in the fifteenth century, while the colonization of some of the other islands was actively going on in the time of Cook—indeed, some of the islands of the Low Archipelago seem not to have been inhabited even in the middle of the eighteenth century. The initial point of departure of the Polynesians from the Malay area is said to have been the island of Buru. The culture of the Polynesians is more or less intimately connected with the food-products of the Pacific islands—the pig, the hen,

several edible roots, the breadfruit, the coconut, etc.

Consult: Grey, *Polynesian Mythology* (London, 1855); Turner, *Nineteen Years in Polynesia* (ib., 1861); De Quatrefages, *Les Polynésiens et leurs migrations* (Paris, 1866); Meinicke, *Die Inseln des stillen Oceans* (Leipzig, 1875); Gill, *Historical Sketches of Savage Life in Polynesia* (London, 1880); id., *Myths and Songs from the South Pacific* (ib., 1876); Lesson, *Les Polynésiens, leur origine, leurs migrations, leur langage* (Paris, 1880-84); Fornander, *An Account of the Polynesian Race* (London, 1878-90); Edge-Partington, *An Album of the Weapons, Tools, Ornaments, Articles of Dress, etc., of the Natives of the Pacific Islands* (Manchester, 1890-98); Brandstetter, *Malaio-Polynesische Forschungen* (Lucerne, 1895-96); Macdonald, *Oceania, Linguistic and Anthropological* (Melbourne, 1889); Reeves, *Brown Men and Women* (London, 1898); Graf von Pfeil, *Studien und Beobachtungen aus der Südsee* (Leipzig, 1899); Ratzel, *History of Mankind* (English trans., London, 1898); and the publications of the Polynesian Society of Wellington, N. Z.

POLYNESIAN SUBREGION. A subregion of the Australian region in zoögeography, embracing all of the islands of the Pacific Ocean from Guam on the west to the Marquesas on the east. It is characterized mainly by the absence of indigenous mammals, the great scarcity of reptiles, and the comparative uniformity of its birds. The central and most characteristic fauna seems to be in the New Hebrides. The Hawaiian Islands, although included in the subregion, have so many distinctive peculiarities that some naturalists regard them as a separate subregion.

POLYNICES, pŏl'i-ní'séz (Lat., from Gk. Πολυεικής, *Polynēikēs*). A son of Edipus and brother of Eteocles. See ETEOCLES AND POLYNICES.

POLYNOMIAL (from Gk. πολύς, *polys*, much, many + Lat. *nomen*, name, thing). A general name for algebraic expressions of more than one term. See ALGEBRA; FUNCTION.

POLYOLBION. A long descriptive poem by Michael Drayton in thirty parts or songs, published in 1613 and 1622. It is a kind of poetical gazetteer, a description of the rivers, mountains, and forests of England, with histories, traditions, curious facts, and genealogies, generally so accurate that it was used as an authority by later writers.

POLYP (Fr. *polype*, from Lat. *polypus*, from Gk. πολύπους, *polypous*, polyp, polypus in the nose, many-footed, from πολύς, *polys*, much, many + πούς, *pous*, foot). A name once given to any of those minute, attached, usually colonial animals having tentacles around the mouth, now recognized either as a special form of coelenterates (usually some hydroid), or as Polyzoa. The name was given by Réaumur on account of their external resemblance to the many-armed cuttlefishes, which were so denominated by Aristotle; and our knowledge of these organisms, as members of the animal kingdom, hardly dates back much more than a century. Most of them live in colonies, sometimes of great extent, supported on a common stock, to which the term 'polypidom' (polyp-home) is sometimes given, and which may be horny, gelatinous, or calcareous.

The polyps are either imbedded in cavities in the substance of the calcareous polypidom or inclosed in minute cups or tubes in the horny polypidoms, from which the body can be protruded, and into which it can be retracted at pleasure. The solitary species often attain a considerable size (as, for instance, many of the sea-anemones), but the social polyps are always minute, although the combined power of some of the species in modifying the earth's crust is neither slight nor limited in extent, as is shown by the dimensions and geographical importance of coral. See CORAL; CORAL ISLANDS AND CORAL REEFS.

POLYPETALY (from Gk. πολύς, *polys*, many + πέταλον, *petalon*, leaf). A condition in flowers in which the petals are distinct from one another. See FLOWER.

POLYPHEMUS (Lat., from Gk. Πολυφῆμος). In the *Odyssey*, the son of Poseidon, and the nymph Thoösa, the most celebrated of the fabulous Cyclopes (q.v.), who inhabited the coast of Thrinakia. He was of immense size and had only one eye. On his return from Troy Odysseus landed in this region, visited the cave of the Cyclopes in his absence, and awaited his return. The monster penned the Greeks in his cave and ate two at once. Next morning he devoured two more, but that night, after his evening meal, Odysseus presented him with some strong wine, and, when he had fallen into a drunken sleep, bored out his eye with a blazing ship's mast. They then escaped beneath the bellies of the sheep which he had penned within the cave. It was in answer to the prayer of Polyphemus that Poseidon visited Odysseus with so many troubles by sea. The later Alexandrian poetry took up the story of Polyphemus as the giant shepherd, and depicted his love for the coy nymph Galatea, and the same subject was a favorite with artists of the Roman period.

POLYPHEMUS MOTH. One of the large American silk moths (*Telea Polyphemus*), expanding five or six inches. It is yellowish or brownish, with a window-like spot in each wing, divided by a vein, and encircled by yellow and black rings; a dusky band margined with pink lies near the outer margin of both pairs of wings. The caterpillar is light green, with an oblique yellow line on each side of each segment, except the first and last; it feeds on tree foliage. The cocoon is dense, oval, and usually inclosed in a leaf. Sometimes it is suspended from a twig, but ordinarily falls to the ground in the autumn.

POLYPH'ONY (from Gk. πολυφωνία, *polyphōnia*, variety of sounds, from πολύφωνος, *polyphōnos*, having many sounds, from πολύς, *polys*, much, many + φωνή, *phōnē*, sound, voice). In musical composition, the combination in harmonious progressions of two or more parts, each of which has an independent melody of its own. Polyphony is opposed to homophony (q.v.), which consists of a principal part with a leading idea and accessory parts furnishing the harmony. The construction of polyphonic phrases is called counterpoint (q.v.). About the ninth century we find the beginnings of modern polyphony in *organum* (q.v.) or *diaphony*, which was the progression of parts in parallel fifths or fourths. In these first attempts at polyphony there are many dissonances which seem to us intolerable; but in the course of time composers learned the secret of obviating the harsh effects by using

the intervals in proper succession, and the next step was the combining of two voices into a real harmonic structure. Instead of the melody being only in one voice, as in the following example from Guido d'Arezzo (q.v.),

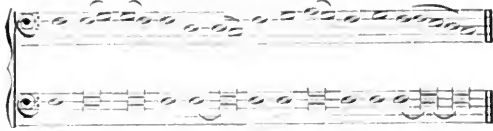

while the second voice intoned an organ-point (q.v.), we have a distinct melody in each voice, as in the following example from the fourteenth century:

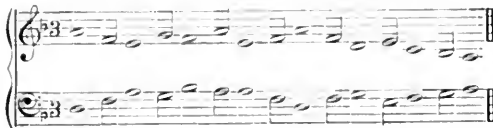

When polyphony still further developed and three and four voices were employed, the additional voices were also given separate melodies as far as possible. Still polyphony as we now understand it had not really begun, for, though the voices were combined in an harmonic whole, they did not all assist in the development of a single idea. Composition had musical but not structural unity. With the rise of the great Flemish School (see MUSIC, SCHOOLS OF COMPOSITION) and the appearance of Dufay, Okeghem, Josquin Depres, Willaert, and their contemporaries, polyphony proper came into existence. Practically every form of composition was based on a canon (q.v.) or a fugue (q.v.), and the technical dexterity, the mathematical complexity of these early compositions has never been excelled. The reaction was inevitable. With the death of Palestrina (q.v.) in 1594, the decline began. The triumph of monody (q.v.) was swift and widespread, and though it in its turn was supplanted by more complex harmonic forms (see HARMONY), the era of the polyphonic school has never returned. Consult: *Oxford History of Music*, "The Polyphonic Period," vol. i. (London, 1901); Hope, *Medieval Music* (London, 1899); Humphreys, *The Evolution of Church Music* (London, 1896).

POLYPODIUM (Lat., from Gk. *πολυπόδιον*, sort of fern, from *πολύπους*, *polyπους*, many-footed; so called from the branching rootstock). One of the largest and most widely distributed genera of ferns, containing at least 350 species, in which the sporangia are borne on the back of the frond. The sori are round, distinct, destitute of indusium, and are for the most part arranged in one or two rows on each side of the midrib. In some species the sori are irregularly scattered over the fronds. The species grow on rocks, dry banks, or old logs, and in the tropics many are epiphytic in habit. The venation varies in the different species, and this character was made the basis of systems of classification in which several genera were recognized, *Polypodium vulgare* (polypody), whose fronds grow from two to twelve inches or more in length, is one of the most common and widespread species of America and Europe. There are a number of varieties of this species in Europe, some of

which are extensively grown as ornamentals. The rootstocks of a number of species were formerly employed in medicine, but are now believed to be nearly inert. See Colored Plate of FERNS.

POLYPORUS. A fungus which attacks old trees and timber. See AMADOU; DRY ROT.

POLYPTERUS (Neo-Lat., from Gk. *πολύπτερος*, many-winged, from Gk. *πολύς*, *polys*, much, many + *πτερόν*, *pteron*, feather, wing). A genus of ganoid fishes of African rivers. See BICHIR; REEDFISH.

POLYPUS (Lat., from Gk. *πολύπους*, *polyπους*, polyopus in the nose, poly, many-footed). In surgery, a term employed to signify any sort of pedunculated tumor attached to a surface to which it was supposed to adhere like a many-footed animal, as its name indicates. The most common seat of polypi is the mucous membrane; hence we have polypi of nose, bladder, rectum, and uterus. The only satisfactory mode of treatment consists in their removal, which is effected in various ways, as by the forceps, the éraseur, or the ligature.

POLYTECHNIC INSTITUTE (from Gk. *πολύτεχνος*, *polytechnos*, skilled in many arts, from *πολύς*, *polys*, much, many + *τέχνη*, *technē*, art). A school of science and liberal arts in Brooklyn, N. Y., established in 1854. It granted its first degrees in arts and sciences in 1871 by special authority of the Regents of the State University, and in 1890 was reorganized and received a broad college charter. It now confers the degrees of bachelor of arts and of science, master of arts and of science, and civil, electrical, and mechanical engineer. During the early years of its history the Polytechnic was known as a successful preparatory school, and it still maintains a preparatory department, as a separate institution, which in 1903 had 525 students, while the institute had an attendance of 110, with 50 instructors in all departments. The library contained 12,000 volumes.

POLYTECHNIC SCHOOLS. See TECHNICAL EDUCATION.

POLYTECHNIQUE (*École Polytechnique*). One of the most famous military preparatory institutions of Europe. It was established by the National Convention as the *Ecole Centrale des Travaux Publics* in 1794, and in 1795 its name was changed to *Ecole Polytechnique*. Although originally intended as a preparatory school for all branches of the public service, it was particularly devoted to the training of civil and military engineers. Under the famous mathematicians Lagrange and Monge, the institution developed rapidly, especially in mathematics and physical sciences, a view being had to their application to technical training. In 1804 Napoleon reorganized it on military lines, and under his régime it became a training school for artilleryists and engineers. The *Ecole Polytechnique* is under the supervision of the Minister of War, and is devoted mainly to the preparation of students for the several branches of military and civil engineering. Students must hold the bachelor's degree in order to become eligible for the competitive entrance examination. The course of study covers two years, at the end of which period the names of those who successfully pass the final examination are placed on a list

in the order of merit, and candidates are allowed to choose what branch of the service they wish to take up. Soldiers who have been in the service at least six months may be admitted, without fulfilling all the ordinary entrance requirements. The branches of the service which rely upon the Polytechnique for candidates are: the corps of land and naval artillery, military and naval engineers, the marine, the corps of hydrographic, road, bridge, and mining engineers, and the telegraph and gunpowder superintendencies.

POLYTHEISM (from Gk. *πολύθεος*, *polýtheos*, relating to many gods, from *πολύς*, *polys*, much, many + *θεός*, *theos*, god). The belief in many gods, as opposed to monotheism, or atheism, belief in one god or in no god. The most primitive peoples scarcely recognize any god, but only demoniac forces, and behind polytheism lies the worship of one superior clan-god. But this latter does not exclude a belief in the existence of other gods of other clans, who on occasion may be worshiped, and the bare recognition of more than one god is not irreconcilable with a synchronous worship of only one clan-god or of rites which propitiate only demons. Most of the forms of polytheism known are far from primitive, and represent both internal development and an amalgamation of beliefs. Different clan-gods, in consequence of political fusion or simply through borrowing, may become united into one pantheon. Thus modern Hindu polytheism arises from a union of Aryan and Dravidian deities; Greek polytheism combined Hellenic and Semitic gods; the Teutonic pantheon included different clan-gods with characteristics borrowed from the Finns and others. Polytheism has been derived, in some cases, but not all, from totemism (q.v.).

In this article only the general aspects of polytheism are to be considered. (1) There is only one unbroken series between inchoate and perfected polytheism. Spirits become gods; gods decline into mere spirits. Polydemonism and polytheism constantly interchange. (2) There is scarcely any natural phenomenon that has not been deified, but the order of deification varies in time. In some cases, sky and earth gods are early divinities; in others, they are ignored altogether, or come late into the pantheon. (3) Nature-gods form only a part of the pantheon, which embraces also deified man-gods and ghosts, gods of poetic fancy, of logic, etc. (4) Social development conditions the pantheon, but there is no absolute rule of progression from matriarchal to patriarchal divinities. (5) The concrete comes before the abstract. Tiber and Ganges are divinities before Water is a god. (6) Nature and mind are often correlated in the figures of the pantheon. Water and wisdom, for example, are united in three distinct polytheistic systems, in the Wisdom-spring of Germany, in Ea, the Babylonian god, and in Varuna, the Hindu god of water and wisdom. (7) In some cases local parts of earth are revered before there are any great gods to which worship is paid. (8) This does not exclude the vague recognition of a creator-god to whom worship is not paid. (9) The great phenomenal gods, sun, wind, storm, sky, always expand rapidly when nationalized, taking on attributes not theirs originally. (10) This leads to such gods becoming more and more anthropomorphic and anthropopathic. (11) The ethical element in gods is a reflection of the sociological conditions of the

worshiper. (12) This ethical element in early pantheons is usually accredited only to certain gods, usually the far-seeing and purificatory gods. (13) Besides racial differences in the conception of gods, we must recognize also a perpetual intellectual difference in every race. The same god is thus conceived in different ways by members of the same race. (14) The higher conception is the result of the intelligence of a few minds. It may dominate them, while the older crude conception still obtains among the vulgar. Which conception shall prevail depends on the ascendancy gained by the more intellectual members of the race. (15) There is a tendency in all polytheisms to make social distinctions, to group the gods in classes. Groups of three, nine, ten, twelve gods are common. (16) This grouping tends to make natural triads, as those of sky, air, earth, or sun, lightning, fire, which in turn, as the gods become more human, tend to become converted into family groups, father mother, and son taking the place of an earlier triad.

Early stages of polytheism, where gods and demons interchange in the same personalities, are found in the religion of Babylonia and Assyria, in the Aino and the Polynesian religions, and in the cult of some of the African and American savages. The perfected Babylonian cult shows polytheism in an advanced stage, as do the religions of Greece, Rome, Germany, and India. In India, Egypt, and Greece are found the most marked examples of the tendency to arrange the gods in social groups. Consult: Tiele, *Kompendium der Religionsgeschichte* (3d ed., Breslau, 1903); Saussaye, *Lehrbuch der Religionsgeschichte* (2d ed., Freiburg, 1897); Jastrow, *The Study of Religion*, with full bibliography (ib., 1901); and for special systems of polytheism, see the separate articles, GREEK RELIGION; ROMAN RELIGION; etc.

POLYXENA (Lat., from Gk. *Πολυξένη*). The daughter of Priam and Hecuba. She was betrothed to Achilles, who was killed by Paris while celebrating his wedding with her in the temple of Apollo. At the demand of his shade Polyxena was sacrificed in expiation on his funeral pyre. Her death forms the subject of the first part of Euripides's *Hecuba*.

POLYZO'A (Neo-Lat. nom. pl., from Gk. *πολύς*, *polys*, much, many + *ζῷον*, *zōon*, animal), or MOSS ANIMALS. Minute marine animals usually forming moss-like or coral-like calcareous or chitinous masses called 'corms,' each cell containing a worm-like creature with the digestive tract flexed, the anus situated near the mouth. The body is usually drawn in and out of the cell by the action of retractor and adductor muscles. The mouth is surrounded by a crown of long tentacles. No heart or vascular system exists, and the nervous system consists of a single or double ganglion situated between the mouth and vent, with nerves proceeding from it. The Polyzoa are hermaphroditic, multiplying by budding or eggs. The embryo passes through a morula, gastrula, and trocho-sphere stage, the corm being formed by the budding of numerous cells from a primitive one. The group was formerly called 'Bryozoa.'

Fossil Polyzoa are common in nearly all geological formations from the Ordovician upward. Because of the difficulties attendant upon their

identification, very few of them have served as horizon-markers or index-fossils. The one prominent exception to this rule is the genus *Archimedes*, with its screw-shaped axis, which is so abundant in some parts of the Carboniferous rocks. In North America the Trenton, Cincinnati, and Hamilton groups are especially prolific sources of supply. The European Mesozoic and Tertiary deposits abound in them, one author, D'Orbigny, having described about 850 species

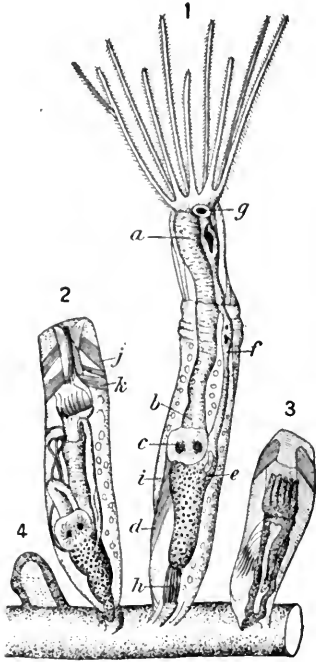

A TYPICAL POLYZOAN.

1. Animal of *Bowerbankia densa* fully expanded: *a*, pharynx; *b*, cardia; *c*, gizzard; *d*, stomach; *e*, pylorus; *f*, intestine; *g*, anus; *h*, muscles. 2. The same animal when completely retracted; *j*, *k*, opercular retractor muscles. 3. An immature animal. 4. A bud in its earliest state.

from the Upper Cretaceous beds alone, while the rocks of these ages in North America are comparatively lacking in them. The North American Paleozoic has afforded about 1325 species, distributed under 170 genera. See Von Zittel and Eastman, *Textbook of Palaeontology*, vol. i. (New York and London, 1900); and Nickles and Bassler, "Synopsis of American Fossil Bryozoa, Including Bibliography and Synonymy," *Bulletin of the United States Geological Survey*, No. 173 (Washington, 1900).

POMACE FLY (ML. *pomacium*, eider, from Lat. *pomum*, apple, pome). One of the small yellowish flies of the genus *Drosophila*, very common about the refuse of cider mills and fermenting vats of grape pomace; also in houses about overripe or decaying fruit, in which they lay their eggs. The larvae also breed occasionally in decaying animal matter and in excrementitious matter, and these flies are hence undoubtedly instrumental in the spread of disease by frequenting the dining-rooms of unscreened houses.

POMARE. The name of four sovereigns of the Society Islands, of whom Pomare IV., Queen of

Tahiti (1813-77), is best known. During her reign France, using the native chiefs as instruments, seized upon the islands in 1842, established a protectorate, and in 1880 annexed them. A revolution in 1852 forced Queen Pomare to abdicate in favor of her children. See TAHITI; SOCIETY ISLANDS.

POMBAL, PÔN'BA'L, SEBASTIÃO JOSÉ DE CARVALHO E MELLO, Marquis of (1699-1782). A Portuguese diplomat and statesman, known to his countrymen as 'The Great Marquis.' He was born May 13, 1699, at the Castle of Soure, near Coimbra. After studying law at Coimbra and serving a short time in the army, Pombal was given an appointment in the service of the Portuguese Government. In 1739 he was appointed Envoy Extraordinary to the Court of London through the influence of his uncle, Paulo Carvalho, and held the position six years, after which he was sent to Vienna in a similar capacity. He there married Countess Daun, and on returning to Lisbon, in 1750, he became popular with the Austrian party in the Portuguese Court and was appointed Minister of Foreign Affairs by King Joseph. His activity was not confined to the external concerns of the realm. His first acts were to limit the power of the Inquisition and also to reattach to the crown a great number of domains that had been unjustly alienated. Then followed the reorganization of the army, the introduction of fresh colonists in the Portuguese settlements, and the establishment of an East India company and a Brazilian company. He introduced into Brazil the cultivation of coffee, sugar, cotton, rice, indigo, and cacao, and freed the Indians from slavery. When the great earthquake of 1755 laid Lisbon waste Pombal displayed surpassing courage and energy in bringing about the rebuilding of a greater and more beautiful capital. The King raised him to the rank of Count D'Oeyras, and in the following year appointed him Prime Minister. He crushed an alleged conspiracy instigated, so he asserted, by the great nobles and the Jesuits, the latter of whom he expelled from Court, and in 1757 confined to their colleges. An attempt upon the life of the King, to which the Jesuits were accused of being a party, but which some historians assert was a plot of Pombal himself to serve his own political ends, placed his enemies completely in his power. The leaders were severely punished by command of the Minister. Pombal made up his mind that the presence of the Jesuits in Portugal was incompatible with the security of the Government and the welfare of the nation, and by a royal decree of September 3, 1759, they were banished from the kingdom as rebels and enemies to the King. Pombal had them seized and carried on board ships, and transported to the States of the Church. The Pope, Clement XIII., vehemently protested, whereupon Pombal caused the Papal Nuncio to be shown across the frontier. He also expelled the Jesuits from the famous missions in Paraguay, which resulted in their complete destruction. All this time Pombal was laboring energetically to improve agriculture in Portugal and the system of primary education. In 1770 he was created Marquis of Pombal, and from this period to the death of the King in 1777 he was at the very height of his power. The accession of Joseph's daughter, Maria I., brought about his downfall.

He was deprived of his office; the numerous alleged conspirators whom he kept in prison were released; many of his measures were abrogated, and Maria ordered him to retire to his castle of Pombal. He died there May 8, 1782. Consult: Moore, *Life of Pombal* (London, 1819); Smith, *Memoirs of Pombal* (ib., 1843); Oppermann, *Pombal und die Jesuiten* (Hanover, 1845); Carey, *Prisons du marquis de Pombal* (Paris, 1865); Carnota, *Marquis Pombal* (London, 1871); Weld, *The Suppression of the Society of Jesus in the Portuguese Dominions* (ib., 1877).

POME (OF. *pome*, *pomme*, Fr. *pomme*, apple, from Lat. *pomum*, fruit). A fruit in which the flesh is developed from the cup-like outgrowth upon which the sepals, petals, and stamens have stood in the flower. Apples, pears, and quinces are illustrations. See FRUIT.

POMEGRANATE (OF. *pome granate*, from ML. *pomum granatum*, apple with seeds, from Lat. *pomum*, apple, *pome*, and *granatus*, having seeds, from *granum*, seed, grain), *Punica Granatum*. A thorny shrub or small tree of the natural order Myrtaceæ, native of Southwest Asia, naturalized in Southern Europe, and widely cultivated during historic time. The cultivated varieties, which are scarcely thorny, have coral red wax-like

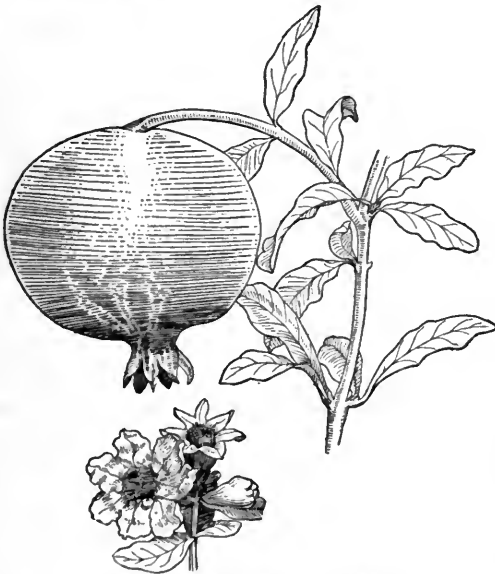

POMEGRANATE FRUIT AND FLOWER.

terminal flowers, leathery skinned fruits as large as oranges, yellow with a rosy cheek. Each of the many seeds is enveloped in a sweet or sub-acid separate pulp inclosed by a thin membrane. This pulp is often used for the preparation of cooling drinks. A kind of pomegranate without seeds is cultivated and much prized in India and Persia. There are ornamental varieties with double flowers. The finest morocco leather is said to tanned with the rind of the fruit. In the United States the cultivation of the pomegranate is confined to the southern part of Florida and the warmer parts of California, as the tree is tender, being injured by a temperature of 8° to 10° below freezing. In some portions of the South the plant is used for hedges. It is propa-

gated by cuttings of both green and ripe wood, by layers, and by grafting.

POM'ELO (*Citrus Decumana*). The generally accepted name of the grapefruit (q.v.), or forbidden fruit, a round-fruited, lemon-colored subtropical tree of the natural order Rutaceæ. The sub-acid pulp is highly esteemed as a dessert, for which purpose large and increasing quantities are shipped to Northern and Eastern American markets from California and the West Indies. See Colored Plate of CITRUS FRUITS.

POM'ERA'NIA (Ger. **POMMERN**, póm'mèrn). A province of Prussia, bounded by the Baltic Sea on the north, West Prussia on the east, Brandenburg on the south, and Mecklenburg-Schwerin and Mecklenburg-Strelitz on the west (Map: Prussia, F 2). Its area is 11,628 square miles. The surface is mostly flat, with isolated hills in the eastern part and a general inclination toward the Baltic. The coast is low and is very deeply indented, forming numerous inlets, among which the Stettiner Haff is the most prominent. The only river of importance is the Oder. It forms many ponds along its course, and falls into the Stettiner Haff. There are numerous lakes both along the coasts and in the interior. The climate, especially in the east, is somewhat raw on account of the proximity of the sea. Pomerania is chiefly an agricultural country, although its soil with a few exceptions is rather inferior and in some parts unfit for farming. The best agricultural land is found in the districts of Stralsund and Köslin and along the Oder. Rye, wheat, barley, potatoes, tobacco, and several kinds of beets are raised in vast quantities. Some of these products are exported. Cattle-raising is also a very important occupation. Smoked fish is one of the famous products of Pomerania. The manufacturing industries are of less importance. They are centred chiefly in the cities and are confined for the most part to shipbuilding and the manufacture of machinery. There are also some glassworks, sugar refineries, tobacco factories, woolen mills, breweries, and distilleries. Owing to its numerous harbors, Pomerania has a well-developed sea trade, of which Stettin, the capital, is the centre. The province is divided into the three districts of Stettin, Köslin, and Stralsund, and sends 26 Deputies to the Lower and 25 to the Upper House of the Prussian Landtag. In 1900 the population was 1,634,659, almost all Protestants. The Poles and other Slavs number about 1100.

HISTORY. The Vandals, who occupied the country at the beginning of historic times, were succeeded in the fifth and sixth centuries by the Slavic Wends, who before the end of the twelfth century had been converted to Christianity. Under the Wends the country was divided into several principalities. Two of the princes assumed the ducal title in 1170. In 1181 they were recognized as dukes of the Empire by Frederick Barbarossa, and at the same time the Margrave of Brandenburg received the feudal suzerainty over Pomerania. In 1308 the district between the Persante and the Vistula, known as Pomerellen, was ceded to the Teutonic Order, but territorial gains were made on the west. Subsequently the Elector of Brandenburg received the right of succession to the Pomeranian lands upon the extinction of the ruling house in the male

line. In 1541 the duchies of Stettin and Wolgast were erected, to which were frequently given the names of Hither Pomerania and Farther Pomerania respectively. The line of Slavic dukes died out in 1637, but in the Treaty of Westphalia, in 1648, Brandenburg had to content herself with the greater part of Farther Pomerania. Hither Pomerania and some districts of Farther Pomerania going to Sweden. The Prussian possessions in Pomerania were rounded out by the Treaty of Stockholm in 1720, when Sweden relinquished part of Hither Pomerania, and in 1815 Prussia acquired the rest of Swedish Pomerania.

POMERANIAN DOG. See SHEEP-DOG.

POMEROY, pöm'e-roi. A city and the county-seat of Meigs County, Ohio, 133 miles southeast of Columbus; on the Ohio River and on the Hocking Valley Railroad. It is in a region possessing valuable deposits of salt and bituminous coal, and has no little commercial and industrial importance. It is particularly noted for the production of calcium and bromine. There are also extensive salt works, steel hoop works, foundries and machine shops, furniture and church organ factories, flour and lumber mills, etc. The government is administered by a mayor, elected biennially, and a unicameral council. Pomeroiy was settled in 1816, and was first incorporated in 1840. Population, in 1890, 4726; in 1900, 4639.

POMEROY, JOHN NORTON (1828-85). An American lawyer and author, born in New York. He graduated at Hamilton College in 1847, and was admitted to the State bar in 1851. He then practiced law in Rochester until 1864, and from 1864 to 1868 was professor of law and political science and dean of the law faculty of the University of New York. From 1869 until 1878 he again practiced law in Rochester, and from 1878 until 1885 was professor of municipal law in the University of California. He published editions, with notes, of Sedgwick's *Statutory and Constitutional Law* (1874), and of Archibold's *Criminal Law* (1876), and wrote several works, including: *Introduction to Municipal Law* (1865); *Introduction to the Constitutional Laws of the United States* (1868, 9th ed., 1886); and *Treatises on the Law of Riparian Rights* (1887).

POMEROY, SETH (1706-77). An American soldier, born in Northampton, Mass. He early became a blacksmith and accumulated property, but was chiefly interested in military affairs. He was major of the Fourth Massachusetts Regiment in the successful attack upon Louisburg in 1745, and the next year was engaged against the Indians on the frontier. In the French and Indian War he was lieutenant-colonel in the expedition against Crown Point. When Col. Ephraim Williams was killed at Lake George, September 8, 1755, Pomeroiy took command of the regiment and captured the French commander, Baron Dieskau. Promoted to be colonel in 1757, he marched to the relief of Fort William Henry, and in 1760 he commanded the frontier forts. He was elected to the First Provincial Congress in 1774, was one of the three men put in charge of the military forces of the colony by that body, and was also colonel of the First Hampshire Regiment. In 1775 he was again a mem-

ber of the Provincial Congress, drilled the militia, and is said to have planned the capture of Fort Ticonderoga. In the battle of Bunker Hill Pomeroiy fought at first as a private, but during a part of the day commanded a battalion. On June 22d he was nominated to be one of the first eight brigadiers named by Congress, but, on account of his advanced age, did not accept. In the latter part of 1776, at Washington's personal solicitation, he joined General McDougal at Peekskill, but died of pleurisy, February 17, 1777, before any active service. His journal, published in Trumbull's *History of Northampton* (2 vols., Northampton, 1902), contains much interesting matter concerning the colonial wars.

POMFRET (probably corrupted from Port. *pombo*, *pampo*, *pomfret*). The name in Bermuda of a fish (*Brama Rafi*) allied to the moonfish and harvest-fish, but representing a singular

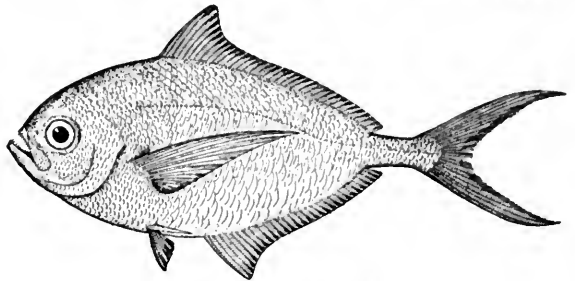

THE POMFRET (*Brama Rafi*).

family whose three or four species are of almost cosmopolitan distribution. West Indian local names are 'eastagnole' and 'rondanin.' They are large, dun-colored pelagic fishes, which roam widely, descend to great depths, and are good to eat. The young differ decidedly from the adults. Consult Jordan and Evermann, *Fishes of North and Middle America* (Washington, 1898).

POMFRET, JOHN (1667-1702). An English poet, son of Thomas Pomfret, vicar of Luton, in Berkshire. He was educated at Queen's College, Cambridge, and, taking orders in the Church of England, became rector of Maulden, in Bedfordshire (1695), and of Millbrook, in the same county (1702). He published *Poems on Several Occasions* (1699), containing an elegy on the death of Queen Mary, and *The Choice* (1700), which was admired by Dr. Johnson. Besides these he wrote *A Prospect of Death, an Ode* (1700); *Reason, a Poem* (1700); and *Miscellany Poems* (1702). Pomfret's couplets were praised for their correctness. For poems and memoir, consult Johnson's *English Poets*, vol. xxi. (London, 1779).

PO'MO (probably, earth people, indigenes). A group of small tribes constituting a distinct linguistic stock known as the Kulanapan, formerly dwelling in northwestern California. When first described by Gibbs in 1853 they were very numerous, with villages along every stream, but they are now nearly extinct. They were described in 1876 by Powers, in his *Tribes of California*, as a peaceful, good-tempered, and easy-going people, rather below the intellectual standard of their more warlike neighbors. They built conical dwellings of poles and bark for their winter res-

idence, with brush shelters in the summer. Everything eatable, even to an Indian, was included in their commissary. They had a system of dual chieftainship, with rather elaborate marriage ceremonies, and usually burned their dead. A secret society of the Pomo had branches in nearly every village; its members, in horrible disguise, at frequent intervals made the rounds of the dwellings to terrorize the women by their uncouth appearance and antics, the belief being that for the time being the performers were the incarnations of the tribal demons. Like most of the northern California tribes, they had a thanksgiving dance after an abundant acorn crop. Their fame rests chiefly upon the baskets woven by their women. Almost all of their household utensils were of basketwork, and the art survives in almost its old-time perfection among the remnant still living near Ukiah.

POMERIUM, or **POMERIUM** (Lat., space behind the wall, from *post*, after, behind + *murus*, *mærus*, wall). A space about the walls of ancient Rome, marked off by cippi and kept vacant as sacred ground. Its limits were first extended by Sulla, and later by several of the emperors, when the bounds of the Empire were increased.

POMOLOGY (from Lat. *pomum*, apple, pome + Gk. *-λογία*, *-logia*, account, from *λέγειν*, *legein*, to say). The study or cultivation of fruits, particularly those belonging to the apple family. This restricted meaning is not now adhered to, and the term is often used synonymously with fruit culture, and made to include all fruits. See **FRUITS, CULTIVATED**; **HORTICULTURE**.

POMONA (Lat.; connected with *pomum*, apple, pome). An ancient Latin or Italian goddess of the fruit, especially of gardens. Her early prominence is shown by the existence of a *flamen Pomonalis*, at the foot of the list of *flamines* (see **FLAMENS**), and the presence of a sacred grove, the Pomonal, near the road to Ostia. It is, however, still doubtful whether these indications speak for a Pomona or a Pomonus, as a god of that name is found among the Umbrians, or possibly for a pair of divinities, such as is not uncommon in the early Roman religion. In the later Roman poets, especially Ovid, Pomona appears in various legends. Thus she is the wife of the mythical king and prophet, Picus, who was changed by the jealous Circe to a woodpecker. More famous is Ovid's tale of the fair but cold nymph Pomona, who, absorbed in the care of her trees, disdained all other love, till Vertumnus, the 'transformer' who ripens the fruits, after vainly wooing her in many forms, finally approached her as an old woman, who won her favor and told her many stories of the fate of those who had despised love. Even then she remained indifferent to the suit of Vertumnus till the god assumed the form of a youth of perfect beauty, when she yielded and from that time the lovers were inseparable.

POMONA, or **MAINLAND**. The largest of the Orkney Islands (q.v.).

POMONA. A city in Los Angeles County, Cal., 33 miles east of Los Angeles, on the Southern Pacific, the Atchison, Topeka and Santa Fe, and the San Pedro, Los Angeles and Salt Lake railroads (Map: California, D 4). Situated in the San Gabriel Valley, it is a beautiful town,

attractive as a place of residence and as a health resort, and also noted as the centre of extensive fruit-growing interests, especially the culture of oranges. At Claremont, in the vicinity, is Pomona College (Congregational), opened in 1888. Ganesha Park commands a magnificent view of the country, and also of the sea, some fifty miles distant. There is a public library. Pomona was settled in 1875 and incorporated in 1887. Its government is vested in a board of five trustees, who, with most of the administrative officers, are elected by the people. Population, in 1890, 3634; in 1900, 5526.

POMPADOUR, *pôn'pá'dōor'*. JEANNE ANTOINETTE POISSON, Marquise de (1721-64). A mistress of Louis XV. of France. She was born in Paris, December 29, 1721, of obscure parents, bearing the name of Poisson. Lenormant de Tournehem, a rich farmer-general, was supposed to be her father, however, and he saw that she was well educated and well provided for. She excelled in music, elocution, and drawing; but what charmed the brilliant society that frequented the salons of the rich financier was the perfect grace and beauty of her figure, and the exquisite art with which she was dressed. A crowd of suitors sought her in marriage, but in 1741 she became the wife of De Tournehem's nephew, Lenormant d'Étioles. In 1745 Mme. d'Étioles, who had attracted the favorable notice of the King, was installed in the palace of Versailles; soon after she was ennobled by the title of Marquise de Pompadour, and long ruled the King, first as mistress and afterwards as an indispensable purveyor of diversions. The King believed her extremely clever, and after he had lost his first passion for her as his mistress was glad to avail himself of her services as his chief political adviser. In fact, for nearly twenty years her influence was predominant in all important affairs of State. The choice of ministers, of ambassadors, of generals, depended on 'la Pompadour' and her favorite minions. The Austrian Prime Minister, Kaunitz, even induced Maria Theresa to sacrifice her pride to the exigencies of her position, and the Empress-Queen wrote the royal mistress a letter in which she addressed her as *ma cousine*. Largely through the influence of the Marquise of Pompadour was that diplomatic revolution effected which in the Seven Years' War ranged France on the side of her hereditary enemy, Austria. (See **KAUNITZ**.) She made and unmade ministers, and Choiseul-Amboise (q.v.) owed his influence to her support. She was a bitter enemy of the Jesuits and responsible to a great degree for their expulsion from France. She was also noted for her patronage of artists and literary men. She was in receipt of an income of 1,500,000 francs a year, and had apartments at Paris, Versailles, and Fontainebleau. She died at Versailles, April 15, 1764. Consult: Goucourt, *Madame de Pompadour* (Paris, 1887); Pavlovski, *La marquise de Pompadour* (ib., 1888); Dietrick, *Les maîtresses de Louis XV.* (Vienna, 1881); Sainte-Beuve, *Causeries du lundi* (vol. xi.); Fleury, *Louis XV. intime* (Paris, 1899); and De Caraman, *La famille de la marquise de Pompadour* (ib., 1900); also her *Correspondance*, edited by Malassi (Paris, 1878).

POM'PANO (Sp. *pampano*, young vine-tendrill), or **PALOMETA**. A fish of southern waters

representing a section of the great 'horse-mackerel' family Carangide, and of admirable quality. The 'common' pompano (*Trachynotus Carolinus*) dwells along the South Atlantic and Gulf shores of the United States and southward, and is occasionally seen on the Pacific Coast. It has the characteristic ovate form of the group (see Plate of HORSE MACKERELS AND ALLIES), is bluish and silvery in colors, and is about 18 inches long. This pompano is found all the year round at the Florida Keys and south of that, but northward enters the bays in large schools in the spring. These disperse to the feeding and spawning grounds in shallow inlets, and gather again in the autumn for migration. This fish is caught in seines and otherwise both in spring and fall, but is fattest and best in the latter season.

Several other species exist, some of which are valuable. The largest, the 'great pompano' or 'permit' (*Trachynotus Goodci*) of the West Indian region, reaches a length of three feet; it is closely allied to a well-known African one. Another noticeable species is the 'round pompano' (*Trachynotus falcatus*), which may be identical with an East Indian form; it has a more circular outline than the others, and ranges northward to Vineyard Sound. It is not so good as the common pompano; and several other of the numerous species are almost worthless as food, though some, like the 'banner' or 'gaff-topsail' pompano of the Carolina and Gulf coasts (*Trachynotus glaucus*), are exceedingly handsome in form and colors. The so-called pompano (*Rhombus similinus*) so highly prized in southern California, is a somewhat different fish, being one of the true harvest-fishes (q.v.).

POMPEII, pōm-pā'yé. An ancient city of Campania, built at the mouth of the river Sarnus (Sarno), looking out on the Bay of Naples. It stood only a few miles from Mount Vesuvius, between Herculaneum and Stabiae. It was founded as early as the sixth century B.C. by Oscans, who were later conquered by Samnites. The city fell under the power of Rome during the Samnite wars, B. C. 342-290, but retained autonomy in a measure. Under Sulla (B.C. 80), it became a Roman colony, and later a favorite resort for wealthy Romans, many of whom, including Cicero and the Emperor Claudius, had villas in the suburbs. It was also a place of considerable trade, and was the port town of Nola and other inland cities which studded the fertile valley of the Sarnus. Its population must have been about 20,000. The city was much damaged by an earthquake which occurred on February 5, A.D. 63. In 79 occurred that terrific eruption of Vesuvius which, in one day, overwhelmed in irremediable ruin the towns of Pompeii, Herculaneum, and Stabiae. In course of time a small village rose at or near the spot; but the memory of Pompeii faded gradually, and for centuries its very site was unknown. The difficulty of discovering its true position was increased in consequence of the changes produced by this fearful convulsion, which had hurled back the Sarnus from its ancient course, and raised the sea-beach to a considerable height, so that the rediscovered city, to which merchantmen resorted of old, is now a mile from the coast, and a considerable distance from the stream that in ancient times ran near its walls. For more than fifteen hundred years

Pompeii lay undisturbed beneath heaps of ashes and cinders. In 1594-1600 an aqueduct for Torre Annunziata was tunneled under the ruins, but no substantial notice taken of them. It was not till 1748 that any excavations were made. These operations, begun by the Neapolitan Government, have been continued till the present time (and recently with increased energy), and have been exceedingly productive of objects which interest the antiquarian and the classical scholar. The remains found are in a remarkably good state of preservation, owing to the fact that the city was destroyed not by lava, but by showers of ashes and cinders (lapilli), forming a light covering, which found their way into every nook, and, as it were, hermetically sealed up the town. Only about 2000 of the inhabitants perished. Around the bodies of some of these the ashes (mixed with rain) settled into a compactness that preserved the character of the mold after the bodies themselves had turned to dust. Into some of these molds liquid plaster has been poured by the excavators, and thus the form of the bodies preserved. Not only did most of the inhabitants succeed in escaping during the eruption, and in carrying with them their movable valuables, but they returned after the eruption had ceased, tunneled down into and around the houses and public buildings (the upper stories rose above the fallen ashes), and carried off almost everything of value, even to the extent of stripping movable slabs from the buildings. This explains why so few objects of great value have been discovered.

What has been found affords us a remarkably realistic and complete picture of life in a small provincial city of Italy in the first century after Christ. Most of the movable objects discovered, and a large number of the best executed wall-paintings (for example see Colored Plate accompanying article DECORATIVE ART) and floor mosaics, have been removed to the Royal Museum of Naples. Lately, however, one house of a family of wealth (the 'house of the Vettii') has been left, with all its equipments, as found. About one half of the city has already been excavated, and the circuit of the walls (about two miles) determined. Many years must elapse before the entire city can be laid bare. The most interesting discoveries recently have been those of the (unfinished) temple of Venus Pompeiana, and of the remains of a number of fugitives carrying much jewelry and other valuables, whose attempted flight in the direction of Stabiae was blocked by the ruin of the bridge over the Sarnus, or by the lack of boats. They took refuge in a wayside inn, and there perished. The entire countryside around Pompeii abounded in residences of the wealthy, and rich returns doubtless await the excavators there. A beginning has been made near Boscoreale, and the finding of a very valuable table-service of silver at the bottom of a well in a villa is an indication of what may be expected elsewhere. The owner had thrown it there for safety when he fled, and was unable to rescue it later.

BIBLIOGRAPHY. The best book on Pompeii is Mau, *Pompeii: Its Life and Art*, trans. by Kelsey (New York, 2d ed., 1902). Other recent works of merit are: Overbeck-Mau, *Pompeii, in seinen Gebäuden, Alterthümern und Kunstwerken* (Leipzig, 1882); Gusman, *Pompéi*, trans. by Simonds and Jourdain (London, 1900); Weichardt,



POMPEII

"HOUSE OF THE FAUN," WITH MOUNT VESUVIUS IN THE DISTANCE

Pompei vor der Zerstörung: Reconstructionen der Tempel und ihrer Umgebung (Leipzig, 1897). Consult also Duhn and Jacobi, *Der griechische Tempel in Pompeji* (Heidelberg, 1890). For the discoveries near Boscoreale, see Heron de Villefosse, *Le trésor de Boscoreale*, in *Monuments Piot*, vol. v. (Paris, 1899); Barnabei, *La villa Pompeiana di P. Fannio Sinistore scoperta presso Boscoreale* (Rome, 1801). The older works are in general not very trustworthy; among the most important for their illustrations are Mazois, *Les ruines de Pompéi* (Paris, 1824-38); Roux and Barre, *Herculaneum et Pompéi* (8 vols., ib., 1841); Nicolini, *Le case ed i monumenti di Pompei* (Naples, 1854-96); *Real Museo Borbonico* (16 vols., ib., 1824-57). On the paintings, consult: Zahn, *Die schönsten Ornamente und merkwürdigsten Gemälde aus Pompei* (Berlin, 1828-59); Rochette, *Choix de peintures de Pompéi* (Paris, 1844-53); D'Amélio, *Pompei: dipinti murali* (Naples, 1898 et seq.); and especially Helbig, *Untersuchungen über die campanische Wandmalerei* (Leipzig, 1873); id., *Wandgemälde der vom Vesuv verschütteten Städte Campaniens* (ib., 1868); Mau, *Geschichte der decorativen Wandmalerei in Pompei* (Berlin, 1882); Sogliano, "La casa dei Vetii in Pompeii," in *Monumenti antichi*, vol. viii. (Milan, 1898). Important discussions are contained in Nissen, *Pompejanische Studien* (Leipzig, 1877), and Mau, *Pompejanische Beiträge* (Berlin, 1879). A full bibliography is given in Furchheim, *Bibliografia de Pompei, Ercolano e Stabia* (2d ed., Naples, 1891).

POMPEIUS, GNEUS MAGNUS, commonly known as POMPEY, or POMPEY THE GREAT (B.C. 106-48). A famous Roman general and statesman. He was a son of Gneus Pompeius Strabo. At the early age of seventeen he began to learn the military art under his father by service in the field against the Italians in the Social War. Though so young, he gave proof of extraordinary valor and of remarkable energy of character. On the death of his father in B.C. 87, when he was only nineteen years of age, he was left without a protector, and during the temporary triumph of the Marian party he was for some time in considerable danger. When Sulla, to whose side he was attached, returned from Greece to Italy to oppose Marius, Pompey hastened into Picenum, where he had considerable estates and influence, and there raised an army of three legions, with which he successfully opposed the forces of the Marian party, compelling them to quit the district, and effecting a junction with Sulla. During the rest of the war he conducted himself with great prudence and valor, and with such remarkable success, that on the restoration of peace in Italy, the conduct of the war against the remains of the Marian faction in Africa and Sicily was intrusted to him. He speedily performed this commission, and on his return to Rome was honored with the name of Magnus (i.e. 'the Great'), and with a triumph, which, for one who had not yet held any public office, and was merely an *equus*, was an unprecedented distinction. His next exploits were the reduction of the followers of Lepidus, whom he drove out of Italy, and the extinction of the Marian party in Spain, led on by the brave Sertorius. This latter work was one of no small difficulty. Pompey suffered some severe defeats at the hands of

Sertorius, and it was only after Sertorius had been assassinated that he was able to put an end to the war. In returning to Italy, he fell in with and defeated the remnants of the army of Spartacus, and thus claimed the credit of concluding the Servile War.

He was now the idol of the people, and, though legally ineligible to the consulship, was elected to that important office for the year 70, the senate relieving him of his disabilities rather than provoke him to extremities. Hitherto Pompey had belonged to the aristocratic party; but, as he had of late years been looked upon with suspicion by some of the leading men, he publicly espoused the people's cause. He carried a law restoring the tribunician power to the people, and aided largely in introducing the bill of Aurelius Cotta (*lex Aurelia*), that the *judices* should for the future be taken from the *senate*, the *equites*, and the *tribuni aerarii*, instead of from the senate alone. In B.C. 67-66 Pompey performed a noble service for the Republic in clearing the Mediterranean of the Cilician pirates who infested it in immense numbers; and during the next three years, 65-63, he conquered Mithridas, King of Pontus, and Tigranes, King of Armenia, annexed Syria to the Roman dominions, took Jerusalem, and made Judea tributary to Rome. On his return to Italy he disbanded his army, and entered Rome in triumph for the third time in 61. After his return he was anxious that his acts in Asia should be ratified by the senate and certain lands apportioned among his veteran soldiers. But the senate declined to accede to his wish, and he therefore formed a close intimacy and mutual alliance with Caesar. Crassus, who possessed enormous wealth, and who exercised a wide influence at Rome, was induced to forego his grudge to Pompey, and thus these three men formed among themselves that coalition which is commonly called 'the first triumvirate,' and which for a time frustrated all the efforts of the aristocratic party. This small oligarchy carried all before them.

Cæsar's daughter, Julia, was given in marriage to Pompey, and private relationship was thus made to bind tighter the tie of political interest. And now, for some years following, Cæsar was reaping laurels in Gaul, and rising higher in popular esteem as a warrior and statesman, while Pompey was idly wasting his time and his energies at Rome. But Pompey could not bear a rival. Jealousies sprang up; Julia died in 54. Pompey returned to his former friends, the aristocracy, whose great desire was to check Cæsar's views and to strip him of his command. Cæsar was ordered to lay down his office and return to Rome, which he consented to do, provided Pompey, who had an army near Rome, would do the same. The senate insisted on an unconditional resignation, and ordered him to disband his army by a certain day, otherwise he would be declared a public enemy. To this resolution two of the tribunes in vain objected; they therefore left the city and cast themselves on Cæsar for protection. It was on this memorable occasion that he crossed the Rubicon, and thus defied the senate and its armies, which were under Pompey's command. The events of the civil war which followed have been recorded in the life of Cæsar. It remains only to mention that after being finally defeated at Pharsalia in 48 Pompey escaped to Egypt, where, according to the order of the King's min-

isters, he was treacherously murdered by a former centurion of his own, as he was landing from the boat. His head was cut off, and afterwards presented to Cæsar on his arrival in Egypt. But Cæsar was too magnanimous to delight in such a sight, and ordered that the murderer be put to death. Pompey's body lay on the beach for some time, but was at length buried by a freedman, Philippus, who had accompanied his master to the shore.

POMPEY THE YOUNGER (SEXTUS POMPEIUS) (B.C. 75-35). The second son of Pompey the Great, celebrated in Roman history for his resistance to Antonius and Octavianus. Hearing of the death of his father, he fled to Spain, finally escaping to the borders of the Lacetani, and rallying in the mountain fastnesses a gang of banditti. He applied to the Roman senate for the restitution of his father's property, which had been confiscated. He received a large sum of money from the public treasury and the title of commander of the seas. Marching southward, he crushed all opposition, took possession of Bætica, and assumed the state and authority of a sovereign. When he learned, B.C. 43, that a second triumvirate was formed, and that he was among the proscribed, he resorted to piracy, his mariners boarded merchantmen, and Corsica, Sardinia, and Sicily fell into his power. Rome was reduced to the point of starvation by his interception of the corn ships; the people compelled Antonius and Octavianus to negotiate a peace. A treaty was concluded advantageous to Sextus. Sicily, Sardinia, Corsica, and Achaia were given him, and he was promised the consulship the following year. But hostilities were soon resumed, and in 36 a Roman squadron under Agrippa destroyed his fleet off Naulochus. Pompey fled, but after a few months was overtaken by M. Titius, carried to Miletus, and put to death.

POMPEY'S PILLAR. The name of a celebrated column standing on a slight elevation in the southwest portion of ancient Alexandria, a short distance outside the Arabian walls. It is a monolith of red granite, of the Corinthian order, raised upon a pedestal. Its total height is 98 feet 9 inches; shaft, 73 feet; circumference, 29 feet 8 inches. The present name is a mere invention of travelers. The inscription on the base shows that it was erected by Publius, eparch of Egypt, in honor of the Emperor Diocletian, in the year A.D. 302. It stood in the centre of the court of the Serapeum, or great sanctuary of Serapis, and survived its transformations into a church and a fortification.

POMPEY'S THEATRE. A theatre erected in Rome by Pompey, opened in B.C. 55, but not completed till 52. It was the first theatre built of stone, and, in deference to the popular prejudice against such construction for a place of amusement, the stone seats and steps were made to form the approach to a temple of Venus Vietrix, built on top of the cavea. The interior was of marble and seated 40,000 spectators. According to Pliny, it was the scene of extravagant slaughters at its opening and during the time of Augustus. It was destroyed by fire on several occasions, and was restored, continuing in use to the sixth century. Considerable remains exist, particularly under the Palazzo Pio.

POM-POM. An automatic gun (see MACHINE GUNS) extensively used in the Boer-British

War of 1900, first by the Boers and afterwards by the British. Its peculiar noise when being fired rapidly caused the British troops to speak of it as a pom-pom. It is very accurate and effective, and proved to be one of the most formidable weapons of the entire war.

POMPO'NIUS, LUCIUS. A Latin writer of Bologna (Bononia), who lived about B.C. 90. He was among the first to transform the hitherto improvised popular plays called *Atellanae* into a regular branch of comic literature, by the introduction of written composition in the metrical forms and according to the technical rules of the Greeks. About seventy titles and plays by him are mentioned. The extant fragments which are printed in Ribbeck's *Comicorum Romanorum Fragmenta* (1873) show that the author usually chose his subject from low life, and frequently indulged in coarse and even obscene language to gratify the popular taste of the times.

POMPONIUS LÆTUS, JULIUS (or POMPONIO LETO) (1428-98). An Italian humanist and leader in the revival of learning. He was a natural son of one of the Sanseverini, a pupil of Lorenzo Valla, and an earnest student of Latin literature. He is most famed for his effort to pattern after the manners and morals of the ancients, taking Cato for his model and living in the country like the ideal farmer of Varro. His lectures on Latin authors were marked by the scholarly sense of his teacher, and his classes became centres of Roman, not to say Pagan, life and thought, so that he was persecuted by Paul II., imprisoned for a time, but released, although forbidden to renew the meetings of his academy. The principal source for his life is the work of his pupil, Sabellicus, *Vita Pomponii Latii* (Strassburg, 1510).

POMPO'NIUS MEL'A. See MELA.

PON'CA. A tribe of Siouan stock (q.v.), formerly claiming the territory upon the waters of Niobrara River, about the Nebraska-Dakota boundary. They speak a dialect of the same language spoken by the Omaha, Osage, Quapaw, and Kaw, all of whom, according to their own tradition, were originally one people and resided upon the lower Ohio. The Ponca were living about the mouth of the Niobrara when visited by Lewis and Clark in 1804, and remained there, in spite of the inroads of the Sioux, until 1877, when, in consequence of their territory being included in a cession by the Sioux, the main body of the tribe was forcibly removed to what is now Oklahoma. During the march and after arrival they died off at such a rapid rate that the tribe was threatened with extinction, when the matter was brought to public attention, with the result that in 1880 a commission reported in favor of returning them to the north. Accordingly a portion of them returned and are now attached to the Santee agency, northeastern Nebraska. The majority, however, still remain in Oklahoma upon a reservation held jointly with the Pawnee, Oto, and Tonkawa. They were reported to number 800 in 1842, 734 in 1875, and 782 in 1901, of whom 553 were in Oklahoma, and the rest in Nebraska.

PONCE, pón'sà. The capital of the Department of Ponce, Porto Rico, and the second largest city of the island (Map: Porto Rico, B 4). It is situated on a plain bordered by

hills three miles from the south coast, and is well built, with clean macadamized streets, and houses chiefly of stuccoed brick or stone. The principal squares are the Plaza Principal and the Plaza de las Delicias, separated by the Church of Our Lady of Guadalupe, and both containing gardens. Among other buildings are a Protestant church built of iron, several asylums and hospitals, one of which is new and modern, and two theatres, the Teatro de la Perla being the best on the island. The city had, in 1900, forty-two public and seven private schools. The streets and some of the houses are now lighted by electricity, and the city has a good water supply brought by an aqueduct more than three miles long, and piped into the houses. Two main highroads connect Ponce with San Juan and Arecibo on the north coast, and a railroad runs west to Yanco, about 20 miles. An electric street railroad has recently replaced the horse-tramway leading to the harbor of Playa de Ponce, a spacious bay accessible to vessels drawing 25 feet, and provided with wharves. Here are the custom house and the chief commercial houses. This is the principal commercial port of the island, and, in 1900, 589 vessels of 500,652 tons entered. The chief exports are coffee, sugar, molasses, rum, and tobacco. Population, in 1899, 27,952; of the municipal district, 55,477.

PONCE DE LEON, pón'thá dá lá-ón', FRAY LUIS. See LEON, FRAY LUIS DE.

PONCE DE LEON, JUAN (c.1460-1521). A Spanish Governor of Porto Rico and discoverer of Florida. He was born at San Servas, in the Kingdom of Leon. After serving as page to a tutor of the royal family, Juan Ponce in 1493 went to America on the second voyage of Columbus. In 1508 he went to Porto Rico and in 1510 was empowered to conquer the island, of which he became Governor. He rapidly acquired a considerable fortune there, so that when Diego Columbus appointed a successor to him, Ponce was able to fit out three ships with which he started, March 3, 1513, to investigate some stories of a marvelous island named Bimini which the Indians said contained a spring which had wonderful curative properties. There is little in the original narratives to substantiate the legend that this was a 'Fountain of Perpetual Youth' that Ponce was in search of. On March 27th land was sighted. He landed, not far from the mouth of Saint Johns River, and on April 8th, on Easter Sunday (Spanish *Pascua Florida*), took possession of the country. A month later, May 8th, having explored the coast carefully and having had two unsuccessful encounters with the natives, he doubled the point of the peninsula and started up the western coast. Proceeding to the neighborhood of Pensacola Bay, he then returned to the Florida Keys, and crossed to Cuba. From there he sailed to the Bahamas, where he was on July 25th, and after two months more of cruising about the Bahamas reached home September 21, 1513. Ponce immediately took ship for Spain, where he secured permission to conquer and colonize the island, as he supposed it to be, of Florida. Returning in 1515, he was delayed by the necessity of conquering the Caribs from Guadeloupe who were overrunning Porto Rico, and who inflicted several severe defeats upon the Spaniards. It was not until 1521 that he was again ready

to start for Florida. With two ships, carrying two hundred men, he proceeded to a harbor, probably Charlotte Harbor or thereabouts, where he landed and prepared to build a settlement. The natives, however, attacked the white men so fiercely that they were soon compelled to reëmbark. A storm separated the vessels, one of which made its way to Vera Cruz, where it arrived just in season to assist Cortés at a critical period in his conquest. Ponce, who had been dangerously wounded in the knee by the Indians, started back to Porto Rico in the other vessel, but he died before arriving there. Consult HARRISSE, *Discovery of North America* (London, 1892).

PONCELET, pón's'lá', JEAN VICTOR (1788-1867). A French engineer and mathematician, born in Metz. From 1807 to 1810 he attended the Ecole Polytechnique, where he studied under Monge. In 1812 he entered the army as lieutenant of engineers, and was made prisoner on the retreat of the French from Moscow. He was taken to Saratov, on the Volga, where, away from all scientific assistance, he laid the foundations of projective geometry. On his return to Metz (1814) he continued his investigations. He found, however, no recognition in the Paris Academy, and therefore published his contributions in *Crelle's Journal*. In 1829 he collected these essays in the *Traité des propriétés projectives des figures* (1822; 2d ed., 2 vols., 1865-66). He then turned his attention to applied mechanics and published several works on the subject. In 1835 he became professor of applied mechanics at Paris, and in 1848 he was raised to the rank of general. In 1851 he went to London as president of a commission to the International Exhibition, and later published a report upon his mission, *Machines et outils appropriés aux arts textiles* (3 vols., 1854-62), in the *Collection des travaux de la commission française*, which is of great importance in the history of technical science. He published in more complete form the work which he began at Saratov in the *Applications d'analyse et de géométrie* (1862-64). Poncelet is the real founder of modern geometry, and had a very strong influence on German geometry, although he found little recognition in France. Some of his other works are: *Sur les roues hydrauliques verticales* (1826); *Théorie des effets mécaniques de la turbine Fourneyron* (1838); *Expériences hydrauliques*, jointly with Lebros (1832); *Introduction à la mécanique industrielle, physique ou expérimentale* (1829; 3d ed. 1870; German trans. 1841-45); *Cours de mécanique appliquée aux machines* (1845; 3d ed. 1874-76; German trans. 1845-49). Consult: Didion, *Notice sur la vie et les ouvrages du général Poncelet* (Paris, 1869); Bertrand, "Eloge historique de Poncelet," in the *Mémoires de l'Académie des Sciences* (ib., 1879).

PONCHIELLI, pón'ké-él'le', AMILCARE (1834-86). An Italian composer, born at Paderno Fasolaro, near Cremona. He was one of the most important Italian composers of the nineteenth century, and although little known to the world at large, was regarded by his countrymen as second only to Verdi. He was educated at the Conservatory of Milan, and made his début as a composer with *I promessi sposi* (1856). Other operas were *La sarajarda* (1861); *Roderica*

(1864); *La stella del monte* (1867); *Le due gemelle* (1873); *I Lituani* (1874); *La Gioconda* (1876); *Il figliuol prodigo* (1880); *Marion Delorme* (1885). He wrote the famous *Garibaldi Hymn* of 1882, perhaps his most enduring composition. Popular as he was in Italy, *Gioconda* was the only work of his that found favor abroad. He wrote many ballets and orchestral suites, and during the time he was *maestro* of the Piacenza Cathedral (1881-86) wrote considerable sacred music.

POND, FREDERICK EUGENE (1856—). An American author and editor, born in Packwaukee, Wis. He frequently wrote under the pseudonym Will Wildwood. From the beginning of his journalistic career he devoted his attention to sporting matters, the protection of game, and the like. For five years he was field editor of the *New York Turf, Field and Farm* (1881-86), and continued to be corresponding editor of the same after it had absorbed his year-old *Wildwood's Magazine* (1888-89). Besides editing several sporting works and contributing to encyclopedias, he wrote a *Handbook for Young Sportsmen* (1876); *Memoirs of Eminent Sportsmen* (1878); and *The Gun Trial and Field Trial Records of America* (1883).

POND, JAMES BURTON (1838-1903). An American lecture manager, born in Cuba, Allegany County, N. Y., and brought up in Lake County, Ill., and Fond du Lac County, Wis. He was a journeyman printer in 1856, and for a time lived with John Brown in Kansas, and was typesetter to the *Herald of Freedom*. In 1859 he joined the first settlers of Denver, Col. Then for two years he edited the *Markesan Journal*, a Wisconsin weekly, and in 1861 volunteered in the Third Wisconsin Cavalry, with which he did border duty in Kansas and Missouri. Captain Pond was one of the seventeen survivors out of one hundred and eighteen treacherously surprised and shot by Quantrell at Baxter Springs in 1863, and at the close of the war received the rank of major. From 1865 to 1873 he was in business in the West, and then settled in Boston, where he bought the Redpath Lyceum Bureau. In 1879 he removed to New York City, where he established the American Lecture Bureau. Major Pond managed the tours of many great lecturers, especially Henry Ward Beecher, as well as Emerson, Sumner, Phillips, Gough, Talmage, Nast, Mrs. Livermore, George Kennan, Mark Twain, and, among Englishmen, Canon Kingsley, H. M. Stanley, Matthew Arnold, Ian Maclaren, Anthony Hope, and Conan Doyle. He wrote *A Summer in England with Henry Ward Beecher* (1886) and *Eccentricities of Genius* (1900).

POND, JOHN (1767-1836). An English astronomer, born in London. At sixteen he entered Trinity College, Cambridge, but was compelled to leave on account of ill health, and spent several years abroad. At his return he settled at Westbury, near Bristol, and erected there an altazimuth instrument 2½ feet in diameter. His observations by this, submitted to the Royal Society in a paper "On the Declinations of Some of the Principal Fixed Stars" (1806), showed that the Greenwich quadrant had changed its form and that a reëquipment of the Royal Observatory was necessary. In 1811 he was appointed Astronomer Royal. In this capacity

he effected a reform of the national observatory and procured for it modern instruments. By the six-foot mural circle mounted in 1812, he catalogued the north polar distances of 84 stars. He introduced the use of the mercury horizon as a substitute for the plumb-line and spirit level, and the method of observing the same object alternately by direct and reflected vision. Pond was also the inventor of the method of observing in groups and the multiplication method. He also showed the unreality of the parallaxes of certain stars observed by Brinkley. He was awarded the Lalande prize in 1817 and the Copley medal in 1823. He was a member of the Board of Longitude, and superintended the issuing of the *Nautical Almanac*, 1832-33. In 1833 he completed a standard catalogue of 1113 stars. His scientific contributions appeared in the *Transactions* of the Royal Astronomical Society and the Royal Society. He also translated Laplace, *Système du monde* (1809).

PONDICHERRY, pōn'di-shēr'rē, or **PONDICHERRI** (Fr. **PONDICHERY**, pōn'dē'shā'rē). The capital of the French possessions in India. It has a territory of 115 square miles, which is surrounded by the British district of South Arcot, in the Province of Madras. The city is situated on the Coromandel Coast, in 11° 56' north latitude and 79° 50' east longitude, 88 miles south of Madras, with which it has railway communication (Map: India, D 6). The territory of Pondicherry is divided into four districts, and comprises a large number of villages. The population of the town of Pondicherry in 1901 was 47,972; the population of the territory is about 180,000. The town stands on a sandy plain, and is divided by a canal into a European and a native town. Around a handsome square are grouped the Governor-General's residence, the Catholic Cathedral, the Hôtel de Ville, and the Bazaar. The Governor of Pondicherry is Governor-General of the French possessions in India. The town has a European college and an Indian school. The open roadstead is defended by a citadel, and possesses a lighthouse. There is an iron pier over 450 feet long, and near its entrance are interesting monuments, including a statue of Duplex (q.v.). An active import and export trade is carried on, the principal exports being cotton manufactures, rice, nuts, and hides. The spinning and weaving of cotton is the chief industry.

HISTORY. The first settlement of the French in India was at Surat in 1668. The chief of the French East India Company at that time was Carou. Subsequently he took Trincomali from the Dutch, but they were not long in repossessing themselves of it; Carou then turned to the Coromandel Coast. In 1672 he took from the Dutch São Thomé, a Portuguese town (now a suburb of Madras); but two years later the Dutch retook this place also. It was then that François Martin collected about sixty Frenchmen and settled them in Pondicherry, which, in 1674, he had purchased, with the surrounding territory, from a lieutenant of Sivaji, the great Mahratta conqueror. The Dutch took the town in 1693; but by the Treaty of Ryswick it was restored to the French in 1697. Chandernagar, on the Hugli, was ceded to the French in 1688 by Aurungzebe. In 1727 they obtained the cession of Mahé, on the Malabar coast; in 1739

they purchased Karikal from the King of Tanjore; and in 1752 Yanaon was ceded to them. Dupleix (q.v.) was Governor of Pondicherry when war broke out between France and England in India. In 1746 La Bourdonnais took Madras. In 1748 Admiral Boscawen besieged Pondicherry, but two months later was compelled to raise the siege. In the same year occurred the Peace of Aix-la-Chapelle; but it did not put an end to hostilities in India till some time later. In 1757 war recommenced. In 1758 Lally became Governor-General of the French possessions in India and attacked the English settlement of Fort Saint David, which surrendered, and was totally destroyed. In 1761 Eyre Coote took Pondicherry. By the Peace of Paris (1763), Pondicherry was restored to the French with reduced territory, as well as Mahé, Karikal, and Chandernagar. Pondicherry was again taken by the English under Sir Hector Monro in 1783, and restored in 1783. In 1793 the English repossessed themselves of it, but the Treaty of Amiens in 1802 again restored it, though only till the following year. From this time it was held by the English till, by the treaties of 1814 and 1815, it was for the last time restored to France. Consult Quennefer, *Souvenirs de Pondichéry* (Lyons, 1882).

PONDICHERRY VULTURE. A small black-eared vulture (*Otogyys calvus*) of India, Burma, and Siam, which is especially characterized by the nakedness of the inside of the thighs. It is nowhere numerous, and is called by the Hindoos 'king vulture,' on account of its domineering manners. It nests in trees, adding year after year to the old structure until an enormous mass results. See Plate of VULTURES.

POND LILY. See WATER LILY.

POND'DOLAND. A mountainous and fertile district of Cape Colony, situated on the south-eastern coast, and covering an area of over 4000 square miles (Map: Cape Colony, N 7). It was acquired by Great Britain in 1884, being the last remaining portion of independent Kaffraria, and was annexed to Cape Colony in 1894. Population, about 200,000.

POND-SNAIL. A snail of the pulmonate family *Limnæidae*, which inhabit the fresh waters of temperate regions. All are vegetable-eaters and seek their food beneath the water. They lay their eggs in clusters surrounded by a clear gelatin-like substance, and attached to plants and other objects beneath the water. The typical pond-snails are those of the genus *Limnæa*, which have thin, horny shells forming a slender spiral with a large aperture, not protected by an operculum. When the ponds are frozen or dry up, they bury themselves in the mud, and become dormant until released. The largest species (*Limnæa stagnalis*) is scattered abundantly over most of the Northern Hemisphere, and may become two inches in length. Many other species are known in North America, most of them less than an inch long. A smaller, less drawn-out shell, differing from *Limnæa* primarily in the fact that it is sinistral, while the shells of *Limnæa* follow the ordinary method of turning from left to right, is that of the genus *Physa*. It is more southerly in its distribution than *Limnæa*, but several species are found throughout the United States, one of which (*Physa heterostropha*) is exceeding-

ly abundant. (See *Physa*.) Another prominent genus, with a large number of familiar species, is *Planorbis*, so called because its shell is coiled in a flat spiral like a roll of tape; none exceed three-fourths of an inch in diameter. Among other genera may be mentioned *Ancylus* and

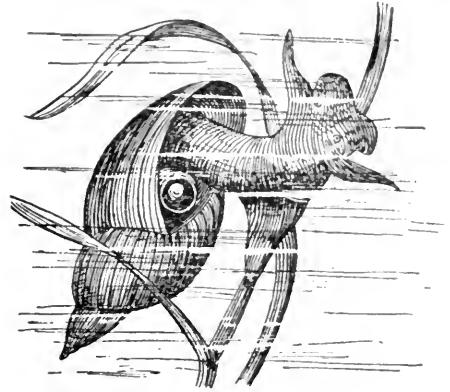

A POND-SNAIL (*Limnæa*).

Gundlachia, which are shaped nearly like limpets, and have similar habits, although they inhabit fresh water alone, and are not larger than grains of rice. All the pond-snails are infested with parasites, and certain of them regularly form the hosts of the liver-flukes of the genus *Distoma* during one stage of their development. Pond-snails are not only interesting objects in an aquarium, but of much utility in keeping the glass free from coniferoid growths, which they constantly feed upon. Consult: Cooke, "Shells," vol. iii. of *Cambridge Natural History* (London, 1898); Binney, *Land and Fresh-Water Shells of North America*, Part ii. (Smithsonian Institution, Washington, 1865). See PULMONATA; SNAIL.

PONEVYEZH, póná-vyézh'. A town in the Government of Kovno, Russia, situated 76 miles north-northeast of Kovno (Map: Russia, B 3). It has a realshule, and extensive manufactures of yeast, flour, tobacco, and spirits. Its trade in flax and flaxseed is also important. Population, 13,044, mostly Jews.

PONIATOWSKI, pónyâ-tów'skâ. The name of a Polish family of Italian origin, descended from the family of the Torelli. A member of this family settled in Poland, and assumed the name of Poniatowski from his wife's estate of Poniatow. The most notable members of the family were: PRINCE STANISLAS PONIATOWSKI (1677-1762), who joined Charles XII. of Sweden in supporting Stanislas Leszczynski. He fought at Poltava (1709), and as the representative of Charles XII. at Constantinople induced the Porte to declare war against Russia. He subsequently held high places at the Court of Augustus III. of Poland. His son Stanislas ascended the throne of Poland. (See STANISLAS II.) Another son, Andreas, became the father of the most distinguished member of the family, JOSEPH ANTONY, PRINCE PONIATOWSKI, the celebrated Polish commander in the army of Napoleon. The latter was born at Warsaw, May 7, 1762, and at the age of sixteen entered the Austrian army, serving in-chief of the Army of the South. In 1792 he returned to Poland, and was named commander-

in-chief of the army of the south. In 1792 he defeated superior Russian forces, but Poniatowski's uncle, King Stanislas, by joining the confederation of Targowitza, put an end to the contest in 1793. The Prince then resigned his command and went into voluntary exile, but returned in the following year to aid Kosciuszko, now dictator, in his fruitless opposition to the third partition of Poland. On the proposal of Napoleon to reconstitute the Kingdom of Poland, Poniatowski joined the French (1800) at the head of a Polish force and did good service against the Russians. After the erection of the Duchy of Warsaw (1807) Poniatowski was appointed Minister of War, and in 1809, when the war between France and Austria was resumed, he drove the Austrians out of Polish territory and overran a considerable part of Galicia. In 1812 he joined the French army destined to invade Russia, with a Polish force of 100,000 men. The greater part of his army was broken up into detachments, which were incorporated with the various French legions, and Poniatowski was left with not more than 30,000 men under his direct command. At the head of this division he distinguished himself in the campaign, but was so severely injured at Smolensk during the retreat that he was obliged to return to Warsaw in December, 1812. He rejoined the French army in the autumn of 1813 and fought with such remarkable valor during the first day of the battle of Leipzig (see LEIPZIG, BATTLES OF) as to gain the title of Marshal of France. When the French abandoned Leipzig, on October 19th, Poniatowski was left with the remnant of his Polish division to protect the retreat. The only bridge across the Elster being wrecked through a mistaken order, he attempted to swim his horse across the river, and had reached the farther bank when he fell back exhausted into the flood. His body was recovered six days after, and was embalmed and carried to Warsaw, whence it was afterward removed to Cracow, and placed beside the ashes of Sobieski and Kosciuszko.—PRINCE JOSEPH PONIATOWSKI, a second cousin of the preceding, musical composer, author of *Don Desiderio* and other operas, and several masses, was born in Rome, February 21, 1816, and died in London, July 4, 1873.

PONSARD, pôn'sär', FRANÇOIS (1814-67). A French dramatist, leader of the 'School of Good Sense' in a reaction from the dramatic vagaries of Romanticism. He was born June 1, 1814, at Vienne. He studied law, but soon gave it up for letters, at first as a follower of Hugo, in which capacity he translated Byron's *Manfred* (1837). His reaction from Romanticism was heralded by *Lucrèce* (1843), which, aided by the genius of Rachel, achieved in 1853 great popularity. He followed this by *Agnès de Méranie* (1846), *Charlotte Corday* (1850), *Horace et Lydie* (1851), *Ulysse* (1852), *L'honneur et l'argent*, his best comedy (1853), *La bourse* (1856), *Le lion amoureux* (1866), and *Galilée* (1867), but from 1853 onward his reformed Classicism was superseded by the modern social drama inaugurated by Dumas the Younger and his own former pupil, Augier. The Academy elected him a member in 1855. He died in Paris, July 13, 1867. *L'honneur et l'argent* still holds the stage. His characterization in general is shallow and his situations are sentimental and

romanesque, but his verse is sonorous and his style clear. Ponsard's works were collected in 3 vols. (1876).

PONS A'SINO'RUM (Lat., asses' bridge). The name popularly given to the fifth proposition of the first book of Euclid, from its supposed difficulty to beginners.

PONT (KYLPOINT, or KYNPOINT), ROBERT (1524-1606). A Scottish reformer, born at (or near) Cubross, Perthshire. He studied at Saint Leonard's College in Saint Andrews University, was one of the committee appointed to revise the *Book of Discipline* (1561), and, in 1562, became minister at Dunkeld. He became provost of Trinity College (near Edinburgh) in 1571, and in 1572, by exception, a lord of session. In 1584 he protested against the acts of Parliament respecting the Kirk's jurisdiction, was thereupon deprived of his seat as lord of session, and fled to England. He was prominently active in the coöperation of the Kirk with the Crown in the suppression of Roman Catholicism, and was a member of various commissions appointed to confer with James VI. His published writings include: *Parvulus Catechismus* (1573); *A New Treatise on the Right Reckoning of Years and Ages* (1599); *De Unione Britanniae* (1604); and a translation (1566) of the Helvetic Confession. His rendering of Pindar's *Olympic Odes* was not printed.

PONT, TIMOTHY (c.1560-c.1630). A Scottish topographer, educated at Saint Andrews (1579-84). He was minister of Dunnet, Caithness, from 1601 until 1609, when he took up forfeited lands in Ulster. The result of his extensive travels through every district of his native land and the isles adjacent was the earliest Scottish atlas, which he did not live to complete. His clear and faithful maps were first published in vol. v. of Bleau's *Atlas* (1668), and the originals are to be seen in the Advocates' Library, Edinburgh. In 1850 appeared *The Topographical Account of the District of Cunningham, Ayrshire, compiled about the Year 1600 by Mr. Timothy Pont*.

PONTA DELGADA, pôn'tá dël-gá'dá. The principal city of the Azores, situated on the south coast of the island of Saint Michael's (*São Miguel*) (Map: Spain, B 5). It has a roadstead protected by a breakwater 2800 feet long, and an extensive commerce and shipping. The chief exports are oranges, lemons, and other fruits, most of which are shipped to England. Population, in 1890, 16,767; in 1900, 17,675.

PONT-A-MOUSSON, pôn'tá moo'sôn'. A town in the Department of Meurthe-et-Moselle, France, 17 miles northwest of Nancy by rail (Map: France, N 3). The Moselle flows through the town, which is situated in a fruitful valley. The principal buildings are the fine Gothic Church of Saint Martin, the sixteenth-century Late Gothic Church of Saint Laurent, the hôtel de ville, and a handsomely ornamented Renaissance house, the last two on the triangular and arched Place Duroc. The town is dominated on the east by a hill 1010 feet high, crowned by a ruined castle and the village of Mousson. There are manufactures of pottery, woollens, plush, velvet, and beet sugar, and extensive iron foundries. Population, in 1901, 12,847.

PONTARLIER, pōn'tár'lyá'. The capital of an arrondissement in the Department of Doubs, France, situated near the Swiss boundary, 26 miles southeast of Besançon (Map: France, N 5). It is fortified and occupies a very important strategic position at the entrance to the Défilé de la Cluse, one of the principal passes over the Jura. In 1871 the town was captured by the Prussians, and the French Army of the East was forced to retreat into Swiss territory. Population, in 1901, 7963.

PONTASSIEVE, pōn'tás-syá'vá. A town in the Province of Florence, Italy, situated at the junction of the Sieve with the Arno, nine miles by rail east of Florence (Map: Italy, F 4). It is a walled town with well-kept streets, a fine square, and an old castle. The inhabitants are engaged chiefly in agricultural pursuits. Annual fairs are held, and there are manufactures of railway supplies, agricultural implements, and glass. Population (commune), in 1881, 11,368; in 1901, 13,405.

PONTCHARTRAIN, pōn'chár-trán', LAKE. A large salt-water lake in the southeastern part of Louisiana (Map: Louisiana, E 3). It is 40 miles long and 25 miles wide, and communicates eastward with Lake Borgne and Mississippi Sound by the Rigolets Pass, through which the tide-water flows, while on the west it is connected by a bayou with the smaller Lake Maurepas. On its southern shore, which comes within five miles of the Mississippi River, are the northern suburbs of New Orleans, and two canals navigable for small vessels reach to the heart of the city, where they terminate in basins. The southern shores are low and in parts marshy, with cypress swamps on the west. The north shore is elevated and healthful, being adjacent to the pine barrens, and affords good sites for summer residences and resorts. The lake is on the whole shallow, the maximum depth being 20 feet, but it is used to a considerable extent in the coasting trade with New Orleans.

PONTE, pōn'tá, JACOPO DA. See BASSANO II.

PONTECORVO, pōn'tá-kór'vó. A city in the Province of Caserta, Italy, situated on the Garigliano, 53 miles northwest of Naples (Map: Italy, II 6). It has a cathedral with mediæval manuscripts, fine churches, a gymnasium, and an old castle. There are manufactures of rope, hats, and macaroni. Pontecorvo formerly belonged to the Papal States. In 1810 Napoleon I. gave the title of Prince of Pontecorvo to Marshal Bernadotte. Population (commune), in 1881, 10,191; in 1901, 12,237.

PONTEDERA, pōn'tá-dá'rá. A town in the Province of Pisa, Italy, situated at the junction of the Era with the Arno, 13 miles southeast of Pisa, with which it is connected by steam tramway (Map: Italy, E 4). The town has bridges over both rivers, a thirteenth-century church, and a gymnasium. The weaving of woolen and cotton cloth and the manufacture of oil and chicory are the chief industries. Population (commune), in 1881, 11,701; in 1901, 13,044.

PONTEFRACT, pōm'frēt. A market town and municipal borough in Yorkshire, England, 21 miles south-southwest of York (Map: England, E 3). There are a grammar, a national, and other schools, several almshouses, a large

workhouse, and a splendid market hall. The town owns its water, cemetery, markets, and recreation grounds. Its trade is chiefly in agricultural and garden produce, cattle, and malt; licorice is largely cultivated for the 'Pontefract lozenges,' known since 1562. The Castle of Pontefract was built shortly after the Conquest. It was the scene of the imprisonment and death of Richard II., and here also Rivers, Grey, and Vaughan were put to death, at the instigation of Richard III. It was besieged four times during the Civil War, and was dismantled in 1649. There are but meagre remains of the structure. Population, in 1891, 9700; in 1901, 13,400.

PONTEVEDRA, pōn'tá-vá'drá. The capital of the province of the same name in Galicia, Spain. It is situated in a beautiful and fertile valley at the head of a bay on the northwestern coast of the Peninsula (Map: Spain, A 1). A stream flowing through the town is crossed by a Roman bridge (*pontus vetus*) of 12 arches. The town is well built, with spacious streets and beautiful alamedas or promenades lined with trees. There are a number of convents and monasteries, a Gothic church, and many modern buildings, the finest of which is the provincial Government palace built in 1889. Sardine fisheries and manufacturing are leading industries. Population, in 1887, 19,996; in 1900, 22,806.

PONTEVEDRA. A town of Negros, Philippines, in the Province of Western Negros, situated on the western coast of the island, 22 miles south of Bacólod. Population, 12,000.

PONTIAC (c.1720-69). A famous chief of the Ottawa Indians and leader of the confederate tribes of the Ohio Valley and Lake region against the English in 1763-65. He was born in what is now northwestern Ohio, his mother being an Ojibwa. He distinguished himself in the French service at an early age, and is said to have led the warriors of his own tribe against Braddock in 1755. When Major Rogers was sent out in 1760 to take possession of the Western posts on behalf of the English Government, he was halted by Pontiac near the present Cleveland with the significant warning, "I stand in the path," but finally with Pontiac's consent proceeded on his way to Detroit. Pontiac professed loyalty to the English King, apparently in good faith, but in a short time organized a confederacy which embraced practically all the tribes from the head of Lake Superior almost to the Gulf coast. His declared object was to drive out the English and recover the country for the Indians, who were still to hold themselves friendly to the French. According to the arrangement, the warriors of each tribe, on a concerted day, early in May, 1763, were to attack the garrison in their immediate neighborhood. Pontiac himself was to lead the assault at Detroit. Throughout the great wilderness extending from the Pennsylvania frontier to Lake Superior there were then fourteen English (formerly French) posts, of which the most important were those at Fort Pitt, Detroit, and Mackinaw. The attacks were made as planned, and the Indians captured all but four of the fourteen posts, Niagara, Pitt, Ligonier, and Detroit. Mackinaw was taken by a stratagem and the entire garrison was massacred. A plot for the capture of Detroit seems to have been betrayed to the commanding officer, Major Gladwin, by an Indian girl, and

completely failed, whereupon Pontiac at once laid siege to the post. The siege continued five months, varied by desultory attacks and sorties and attempts to relieve the fort with men and supplies. The most notable event of the siege was the action at Bloody Bridge, July 31, 1763, in which a sortie of troops was repulsed by Pontiac. Forts Pitt and Ligonier, to which the Indians had laid siege, were relieved by Colonel Bouquet, who defeated the Indians at Bushy Run, near the former post. Reinforcements finally succeeded in entering Detroit; Pontiac's men began to desert him, and the news of the signing of a treaty of peace between France and England removed all hopes of French aid. Pontiac, thoroughly discouraged, thereupon raised the siege of Detroit. In 1764 Bouquet led a second expedition into Ohio, which compelled the tribes to submission, and on August 17, 1765, Pontiac himself entered into a formal treaty of peace at Detroit, which he confirmed at Oswego with Sir William Johnson the following year. He was murdered at Cahokia, Ill., in 1769, by an Illinois Indian, who seems to have been bribed by an English trader. In revenge the northern tribes made concerted war upon the Illinois tribes, and within a few years virtually exterminated them.

The genius of Pontiac is shown by his capacity to mold the warriors of so many diverse tribes and languages into a working unit capable of striking a simultaneous and effective blow across five hundred miles of wilderness, and afterwards by his maintaining a close siege of a fortified garrison for five months. Consult Parkman, *Conspiracy of Pontiac* (Boston, 1851).

PONTIAC. A city and the county-seat of Livingston County, Ill., 92 miles southwest of Chicago; on the Vermilion River, and at the junction of the Wabash, the Chicago and Alton, and the Illinois Central railroads (Map: Illinois, D 3). It is the seat of the State Reformatory for juvenile offenders, with some 1400 inmates, and has fine public library and city hall buildings and a park (Riverside). The commercial interests of the city are important, the surrounding region being a productive farming and stock-raising country, and possessing extensive deposits of bituminous coal. The principal industrial plants include shoe factories with a large output and manufactories of candy, boxes, and hooks and eyes. The government is vested in a mayor, elected every two years, and a unicameral council. Founded in 1829 by settlers from Ohio and Indiana, Pontiac was first incorporated in 1856, and in 1872 received a city charter. Population, in 1890, 2784; in 1900, 4266.

PONTIAC. A city and the county-seat of Oakland County, Mich., 26 miles northwest of Detroit, on the Clinton River and on the Grand Trunk, the Detroit, Grand Haven and Milwaukee, and other railroads (Map: Michigan, K 6). It is situated in a picturesque lake region, noted for its hunting and fishing. It is the seat of the Eastern Michigan Asylum for the Insane, with grounds occupying over 500 acres, and has a public high school library and a ladies' library, the latter possessing a fine new building. Pontiac carries on a large trade in wool, fruit, and farm produce, and is developing as an industrial centre, the manufactures including buggies and wagons, farm machines, gas and gasoline en-

gines, foundry products, bicycles, pumps, flour, lumber products, knit goods, etc. The water-works are owned and operated by the municipality. Named in honor of the famous Indian chief, Pontiac was settled in 1818, and was chartered as a city in 1861 (having been incorporated as a village in 1837). Population, in 1890, 6200; in 1900, 9769.

PONTIANAK, pŏn'té-á-nák'. The chief town of the Dutch possession of West Borneo, situated on the western coast of the island, right under the equator (Map: East Indies, C 4). It is one of the principal ports of Borneo and the seat of a Dutch resident. Its population is estimated at 9000.

PONTIANUS, pŏn'shí-á'nūs, SAINT. Pope, 230-235. He took part in the controversy between Origen (q.v.) and Demetrius, favoring the latter. The greater part of his pontificate fell under the reign of Alexander Severus, who was well disposed toward the Christians, but a new persecution broke out on the accession of Maximin, and Pontianus was banished to Sardinia, where he died from harsh treatment.

PONTICELLO, pŏn'té-ché'lŏ (It., little bridge). In music, the bridge of a bow instrument. *Sul ponticello* is the direction given to violinists to play with the bow near the bridge, which produces a hard, sharp tone. The opposite of *sul ponticello* is *flautando*, which calls for a clear, sweet flute-like tone produced by drawing the bow across the string at some distance from the bridge.

PONTIFEX (Lat., probably from *pons*, bridge + *facere*, to make). The title borne by the members of one of the four great priestly colleges among the Romans. The other three were the *collegia augurum* (see AUGURIES), XV. *virorum sacris faciundis*, and VII. *virorum epulonum*. The last two were of younger origin, as the former (at first of two, then ten, and after Sulla of fifteen members) was instituted to have charge of the Sibylline books and the oversight of the foreign cults, classed as *Græcus ritus*, while the latter (of three, seven, and ten members) relieved the pontifices of their duties in connection with the sacrificial banquets of the Roman and plebeian games. The *collegium pontificum* in its widest and technical meaning included several elements. Besides the *rex sacrorum*, who had succeeded to the priestly duties of the King, the flamines (see FLAMENS), and the six vestal virgins, there were the pontifices, properly so called, whose number increased from three to six, nine, fifteen and sixteen. At their head was the *pontifex maximus*. This college was the guardian of all the ceremonial attending the worship of the ancient Roman gods (*patrius ritus*). It had charge of the calendar; its members alone possessed the prayers and rites needed for the proper performance of religious ceremonies; they were consulted as to the necessary rites which the appearance of prodigies might require from the State or individuals, and by their replies established a large body of law affecting religious observances and duties, based upon the mass of precedent with which they were familiar. From their number the *pontifex maximus* was elected, after B.C. 212 and perhaps earlier, by an assembly of seventeen tribes chosen by lot. He was, as it were, the legal embodiment

of the collective body of pontifices, and possessed over the other members of the great college an authority which preserves plain traces of original absolutism. The pontifices filled vacancies by their own vote, but the rex and flamines were appointed, even against their will, by the pontifex maximus, though in later times his choice was limited by a list of nominations. The vestals also were originally chosen by him, though later the lot decided from twenty names of his choosing. He had the power to fine his colleagues, and even to remove the rex and flamines. To the vestals he stood in the position of a father, and could use corporal punishment, though the death penalty for unchastity could only be inflicted by the college. In the time of the Empire this office regularly belonged to the prince, and a *promagister* was named to preside over the college. The pontifices are among the oldest Roman officials, evidently belonging to the regal period, as a council of the monarch. Their importance is shown by the fact that with the augurs they are the only priests regularly provided for the colonies. Originally all the pontifices were patricians, but in B.C. 300 the Lex Ogulnia provided that five of the nine pontifices and of the nine augurs should be plebeians. Later, when the numbers were increased, the majority seem to have been drawn from patrician families. Even with the growth of Christianity the pontifices and vestals continued to exist, though the Emperor Gratian resigned the title of pontifex maximus, and it was not till the end of the fourth century that the edicts of Theodosius put an end to the forms of the old Roman religion. Consult: Mommsen, *Römisches Staatsrecht* (Leipzig, 1887-88); Marquardt, *Römische Staatsverwaltung* (2d ed., ib., 1884); Bouché-Leclercq, *Les pontifes de l'ancienne Rome* (Paris, 1871); Bardt, *Die Priester der vier grossen Collegien* (Berlin, 1871); Habel, *De Pontificum Romanorum inde ab Augusto usque ad Aurelianium Condición Publica* (Breslau, 1888); Wissowa, *Religion und Kultus der Römer* (Munich, 1902).

PONTIFICAL (ML. *pontificale*, book of offices, from Lat. *pontificalis*, relating to a pontiff, from *pontifex*, high priest). The name in Roman Catholic usage of the book containing the several services, whether in the administration of sacraments, or the performance of public worship, in which the bishop exclusively, or at least a priest delegated by the bishop, officiates. There were many such collections for the various national churches; but that which is now in universal use throughout the Western Church is the *Pontificale Romanum*, edited by the Papal master of ceremonies Burchard and published at Rome in 1485. It was revised by Clement VIII. and its use extended to the whole Latin Church in 1596. The current edition is that published at Regensburg in 1888 by authority of Leo XIII. Another of the service books of bishops is called the *Ceremoniale Episcoporum*, but it is chiefly confined to a description of the peculiar ceremonial with which bishops are required to celebrate solemnly those offices, as of the mass, vespers, and the funeral office, which are common to them with priests.

PONTIFICAL STATES. See PAPAL STATES.

PONTIGNY, pôn'té'nyé'. A village in the Department of Yonne, France, 32 miles southwest of Troyes (Map: France, K 3). Popula-

tion, in 1901, 778. It is noted for its extensive Cistercian abbey, founded by Count Thibaud of Champagne in 1150, and frequently the asylum of the Archbishops of Canterbury when at variance with the English kings. Thomas à Becket found refuge there in 1164, Stephen Langton in 1208, and Edmund Rich in 1239. The abbey and church were much damaged by the incendiarianism of the Huguenots in 1568. It has been restored, is now a national monument and a pilgrimage resort, especially of British Roman Catholics. The church is one of the most perfect survivals of unadorned early Gothic. Its length is 360 feet; width of nave, 73 feet; length of transepts, 150 feet; interior height, 70 feet. Some of its distinctive features are a small open narthex and the narrow lancet-shaped windows.

PONTINE MARSHES (Lat. *Pomptinæ Paludes*). A low-lying district, forming the southern part of the Campagna di Roma (q.v.), and extending in a southeasterly direction from Cisterna to the sea at Terracina. Its greatest length is about thirty-one miles, and its breadth from five to eight miles. It does not reach the seacoast on the west, being separated from it by a broad sandy tract covered with forest; but even this barrier partakes to some extent of the character of the marshes themselves, being quite as flat, and largely intermixed with swamp and lagoon. The Pontine Marshes have undoubtedly been formed by the stagnation of the streams that take their rise in the Volscian hills, and by the accumulation of sand along the shore from Astura to the Circeian promontory, but this formation undoubtedly belongs to prehistoric ages. The first attempt to drain the Pontine Marshes in ancient times was made in B.C. 160 by the consul Cornelius Cethegus; but his efforts were only partially successful. Julius Cæsar projected the drainage of this pestilential district, but his murder prevented the complete realization of his project. Augustus also appears to have done something; but in the time of Juvenal it was a mere haunt of robbers. Theodoric the Goth likewise tried to reclaim it; but the desolations of succeeding reigns soon reduced it to a hopeless condition, and it remained an uninhabitable region. The first in modern times to resume the labors of the ancients was Pope Boniface VIII., who drained the district about Sezze and Sermoneta by means of a large canal. Several subsequent efforts were made, but nothing was really accomplished till the time of Pope Pius VI., who, in 1778, commenced to drain the marshes, and completed the drainage in ten years. The reclamation of the land, however, has been found possible only in part. Though much is under cultivation and in pasturage, a great portion is hopelessly irreclaimable, and the whole region is so unhealthy that during the summer months the inhabitants are obliged to remove to the neighboring mountains. Consult: Prony, *Description hydrographique et historique des Marais Pontins* (Paris, 1823); De la Blanchère, *La malaria de Rome et le drainage antique* (ib., 1884); Berti, *Le Paludi Pontine* (Rome, 1884); Donat, *Le Paludi Pontine ed il loro prosciugamento* (ib., 1887).

PONTMARTIN, pôn'mär'tän', ARMAND FERRAND, Count de (1811-90). A French author, born at Avignon, and educated in Paris. He en-

tered journalism in 1830, and later became a critic and satirist. His best works were *Causeries littéraires* (1845-56); *Causeries du Samedi* (1857-81); *Semaines littéraires* (1861-63); and *Souvenirs d'un vieux critique* (1881-89). In these, in his *Mémoires* (1885-86), and in his many novels he showed himself a master of a brilliant style.

PONTOIS, pôn'twü', JEAN FELIX HONORÉ (1837—). A French lawyer and author, born at Thouars. At the age of thirty-one he was made a judge of the tribunal at Ancey and was transferred to the tribunal of Algiers in 1874, finally becoming president of the tribunal of Tunis in 1883. In 1886 he became president of the division of the Court of Appeals at Nîmes, holding that office for three years. On his resignation he engaged in political work against the Boulangists, and published books and articles bearing on political topics. He was honored by membership in the Legion of Honor. One of his best known works is *Réforme du code d'instruction criminelle et au code pénal* (Paris, 1871). He has published a number of other legal works, and also some dramatical works.

PONTOISE, pôn'twüz'. The capital of an arrondissement in the Department of Seine-et-Oise, France, 17 miles northwest of Paris by rail, at the confluence of the Oise and the Vienne (Map: France, H 2). The town rises from the Oise in an amphitheatrical form on a hill crowned by the twelfth-century Gothic Church of Saint Maclou. The Church of Notre Dame, the Hôtel de Ville, museum, and hospital are also notable buildings. There are remains of mediæval fortifications. Pontoise has a considerable commerce in grain, and manufactures mill machinery, chemicals, and hosiery. It was the Roman *Briva Isaræ*, a village antedating the Roman Conquest, and was destroyed by the Northmen in the ninth century. It became the capital of the Vexin Français, and was the frequent residence of the Capetian kings. Population, in 1901, 8180.

PONTOON'. See BRIDGES AND DOCKS, MILITARY.

PONTOPPIDAN, pôn-tóp'é-dán, ERIK LUDVIGSEN (1698-1764). A Danish prelate. He was born at Aarhus, Jutland, and studied theology as well as geography and history at the University of Copenhagen. He was made chaplain to the King in 1735; professor of theology at Copenhagen in 1738; bishop of Bergen, Norway, in 1748; chancellor of the University of Copenhagen in 1755. He was a learned man and the leader of the Pietists in Denmark. Among his numerous publications were: *A History of the Church in Denmark* (1741-47); *A Natural History of Norway* (1752-53; Eng. trans., London, 1755); and *An Account of the Geography, Natural History, and Antiquities of Denmark* (7 vols., 1763-81). His explanation of Luther's catechism was used as a text-book for many years in the schools of Denmark and Norway.

PONTOPPIDAN, HENRIK (1857—). A Danish novelist, born in Fredericia and educated at the University of Copenhagen. His first book, *Stakkede Vinger* (1881), immediately gained for him a prominent position among the younger Danish writers and marked him as a broad and accurate observer of social and political conditions among the Danish peasantry. His earlier

writing betrays imitation of the Norwegian novelist Kielland, but in *Fra Hytterne* (1887), *Pøkkelivsskildringer* (1888-90), and the trilogy *Muld* (1891), *Det forjættede Land* (1892), and *Dommens Dag* (1895), his originality and narrative power are strongly apparent. His other writings include *Sundingen Menighel* (1883) and *Landsbybilleder* (1884).

PONTOR'MO, JACOPO DA (properly JACOPO CARUCCI) (1494-1557). An Italian painter of the Florentine school, called Pontormo from the place of his birth. He was the pupil of Leonardo da Vinci, Albertinelli, Piero di Cosmo, and finally of Andrea del Sarto. The "Visitation," in the Church of the Annunciation, Florence, one of his best works, is in the style of the last-named master. But he was also influenced at different times by Dürer and Michelangelo. There is a "Holy Family" in the Louvre by him, and a "Joseph and His Brethren," a better work, in the National Gallery, London. Pontormo's excellent portraits include those of Andrea del Sarto, in the Berlin Museum; the portrait of a boy in the National Gallery, London; and that of a gem-cutter in the Louvre, Paris. The portrait of a cardinal in the Borghese collection, Rome, attributed to Raphael, is also said to be by him.

PONTREMOLI, pôn-trém'ò-lè. A town in the Province of Massa e Carrara, Italy, situated on the southern slope of the Apennines, on the Magra, 37 miles southwest of Parma (Map: Italy, D 3). It has a cathedral and an episcopal library. There are manufactures of silk, oil, and lime, and a trade in wine, fruit, and cattle. There are also marble quarries and mineral springs. Pontremoli was a republic in the twelfth century. Population (commune), in 1881, 12,601; in 1901, 14,194.

PONTRESINA, pôn'trà-zè'ná. A celebrated mountain resort in the Canton of Grisons, Switzerland, situated at an altitude of over 5800 feet on the road to the Bernina Pass. Population, in 1900, 483, chiefly Protestants.

PONTUS (Lat., from Gk. Πόντος). The ancient name of a district in the extreme northeast of Asia Minor, bordering on the Pontus Euxinus (whence its name), and extending from the river Halys (now Kizil Irmak) in the west to the frontiers of Colchis and Armenia, a short distance beyond the modern Batum, in the east. Its southern limits were the ranges of Anti-Taurus and Paryadres, so that it corresponded pretty nearly to the modern provinces of Trebizond and Sivas. On the east and south Pontus is mountainous, but along the coast there are large and fertile plains which in ancient times produced, and indeed still produce, abundance of grain, fruits, and timber. Game, according to Strabo, who was a native of Amasia, was also plentiful. Apiculture was common, and honey and wax were among the chief articles of commerce. Iron was the principal mineral. Besides the Halys at the west, the chief rivers were the Iris and its tributary, the Lycus, and at the east the Acampsis. Small, but famous from its association with the Amazons, was the Thermodon.

Pontus was not an ethnological, but purely a geographical, division. The name does not occur before the fourth century B.C., and is not common

till after the time of Alexander the Great. Properly, the region was called Cappadocia ad Pontum. The early inhabitants seem to have been barbarous but warlike tribes, over whom the monarchs of Assyria, Lydia, and even Persia had but little more than a nominal control, though the region formed one of the satrapies under Darius. The advantages of the fertile coast and the prospects of trade early attracted Greek merchants, and the Argonautic epic reflects the voyages of the early Æolian and Ionian traders. As early as the seventh century B.C. the Milesians had founded Sinope, and that city and Miletus planted a number of settlements along the Pontic coast, of which the most famous was Trapezus (Trebizond); others were Amisus (Samsun), Cotyora, and Cerasus (near the later Pharnacia). In the interior were native cities which later attained prominence, such as Amasia, the old capital and burial place of the earlier kings; Comana Pontica, the chief seat of the worship of the Asiatic goddess Ma; and Cabira or Neocæsarea, the modern Niksar. Some of the earlier satraps or local princes seem to have assumed a royal title in the fourth century B.C., or at any rate were regarded as the founders of the dynasty, but the foundation of the Kingdom of Pontus was really laid by Mithridates III. Ctiste (or founder), who in B.C. 362 fled to this region from Antigonus. At first little more than a robber chief, he so skillfully used the disturbances of this time that in B.C. 280 he could assume the title of king. He seems to have died about B.C. 266, master of Paphlagonia and Northern Cappadocia, though Sinope was still independent. He was succeeded by his son, Ariobarzanes III., who was followed by Mithridates IV., and Pharnaces I., who took Sinope and removed the inhabitants of Cotyora and Cerasus to his new city of Pharnacia. He was, however, forced by the Romans to give up most of his Paphlagonian conquests. To him succeeded Mithridates V., and about B.C. 121 the great Mithridates VI. Eupator (see MITHRIDATES), one of the most dangerous opponents of Roman rule in the East, ascended the throne. After his overthrow, B.C. 63, by Pompey, his kingdom was divided. The portion west of the Halys was joined to the Province of Bithynia. Next to this district the valley of the Iris and the region inland were given to King Deiotarus, and from that time were known as Pontus Galaticus. The eastern region was given to other princes, and later the central portion was given by Antonius to a certain Polemon, whence it was called Pontus Polemoniacus. It was ceded to Rome during the reign of Nero, and at first joined to Galatia. Later both divisions of Pontus were joined to Cappadocia, and in the redistricting of the Empire by Constantine it formed two provinces. The narrow eastern strip along the Black Sea was called Pontus Polemoniacus, while the western district, extending to the highlands of Cappadocia, was named Hellenopontus. Consult: E. Meyer, *Das Königreich Pontus* (Leipzig, 1879); T. Reinach, *Trois royaumes de l'Asie Mineure* (Paris, 1888); and *Mithridate Eupator, roi de Pont* (Paris, 1890).

PONTUS EUXINUS. The ancient name of the Black Sea (q.v.).

PONTYPRIDD, *Welsh pron.* pŏn'tŏ-prĭth' (*Welsh, Bridge of Beauty*), also called NEW-

BRIDGE. A town in Glamorganshire, Wales, on the Taff, 11 miles southeast of Merthyr Tydfil (Map: Wales, C 5). The municipality owns gas works and abattoirs, maintains libraries and recreation grounds, and is instituting numerous improvements and public industries. Its growth and importance are due to its various manufactures, collieries, iron mines, and supplemental industries. Pontypridd is named from the famous bridge built by a self-taught architect over the Taff in 1755. Population, in 1891, 15,400; in 1901, 19,460.

PONY (probably from Fr. *poulenet*, diminutive of *poulain*, from ML. *pullanus*, foal, colt, from Lat. *pullus*, young animal, chicken; connected with Gk. πῶλος, *pōlos*, foal, and ultimately with Eng. *foal*). A small horse. The name pony is commonly applied to the many small active breeds of horse (q.v.) which are to be found throughout the world, more especially in the warmer parts and in mountainous or sterile regions. In general they are exceptionally hardy and possess a strength great in proportion to their size. Possibly the smallest race of ponies is the Shetland, although the Iceland pony differs but little from it and is sufficiently hardy to flourish in the winter of Iceland. The Galloway, Welsh, Dartmoor, Exmoor, and Canadian breeds are types of ponies considerably larger than that of Shetland. Sardinia and Corsica also possess small races of pony, which have existed unchanged from ancient times.

PONY EXPRESS. The name given to a mail service established between Saint Joseph, Mo., and San Francisco, Cal., in 1860. At this time there were three transcontinental mail lines, but the greater part of the mail between the east and the far west was sent by way of Panama, in about twenty-two days. The demand for a more rapid mail service between the east and the west led to the establishment in the spring of 1860 of the famous "Pony Express," the mail being carried rapidly overland on horseback under the direction of the Central Overland California and Pike's Peak Express Company. The first pony express left, on April 3, 1860, Saint Joseph and San Francisco, between which places the schedule allowed 8 days. Stations averaging at first 25 miles apart were established, and each rider was expected to cover 75 miles per day. Eventually there were 190 stations, 200 station-keepers, 200 assistant station-keepers, 80 riders (who were paid from \$100 to \$125 per month), and between 400 and 500 horses. The quickest trip was that made for the delivery of President Lincoln's inaugural address, the distance between Saint Joseph, Mo., and Sacramento, Cal., 950 miles, being covered in 7 days and 17 hours. At first the company charged \$5 for each half ounce, but later the charge was reduced to \$2.50. The regular pony express service was discontinued upon the completion of the line of the Pacific Telegraph Company, in October, 1861. The service was often interrupted by Indian hostilities, and was extremely hazardous for riders and station-keepers alike. Consult an article in *The Century Magazine*, vol. 34 (New York, 1898).

PONZ, pŏnth. ANTONIO (1725-92). A Spanish archaeologist, painter, and art critic. He was born at Bexis, and was sent to Valencia and to Gandia to study letters and philosophy, but became an art-pupil of Richart in the former

city, and studied in Madrid and (1751-60) in Rome. Upon his return to Spain he was ordered to paint portraits of Spanish authors for the Escorial. His other paintings are mostly copies of Callari and Reni. About 1770 he was sent on his great tour of Spain to collect paintings and statuary from the convents which the Jesuits had just been forced to leave. His chief work is the description of this mission, *Viage de España* (1771-94; completed by his nephew), which, besides art criticism, gives a complete account of social conditions of the times. Ponz wrote, on his travels in France and England, a *Viage fuera de España* (1785). His criticism of architecture is particularly valuable.

PONZA (pôn'tsá) **ISLANDS**. A group of small islands, of volcanic origin, belonging to Italy, situated west of Naples, in the Mediterranean Sea, in about longitude 13° E. (Map: Italy, G 7). There are in fact two groups. The western and larger belongs to the Province of Caserta, the eastern to the Province of Naples. They are used as penal settlements. To the former collection belongs Ponza, the largest island, with 4560 inhabitants in 1901. The latter group consists of two islands, with a population of 1859 in 1901. The islands served the Roman Emperors as a place of banishment.

POOD (Russ. *puđū*, from Lat. *pondus*, weight). A Russian weight equal to 40 Russian pounds or 36.112 pounds avoirdupois.

POODLE (Ger. *Pudel*, from Ger. *puđeln*, to splash in water; connected with LGer. *puđeln*, *puđeln*, to waddle, Eng. *puddle*, pudgy person). A breed of long-haired domestic dogs now kept chiefly as pets. The poodle has long been known and appreciated; his quaintly clipped and shaven body is found depicted on Roman sculptures. From Italy he was introduced into Spain and France, and thence into England. He is not only naturally a good retriever or water-dog, but has the nose and sudden stop of both the pointer and setter; indeed, so keen is his nose that even the inferior kinds, or patched dogs, are employed by the poor natives of Hampshire and Wiltshire in England to hunt for and point out truffles—a faintly smelling fungus formerly much affected as a relish. His remarkable general intelligence is indicated by his predominance in every band of trick and performing dogs in the world. Three varieties are recognized—the red, the white, and the black; and two classes of covering—'corded' and 'curly.' Their weight is divided, for competitive purposes, into three grades: Large size, over 40 pounds; medium, 20 to 40 pounds; small, 20 pounds or under; and the last grade are sometimes called 'barbets.' The general appearance is that of a strong, active, stylish, playful, and intelligent dog, well built, and covered with thick, close curls of a silky texture, or with strong, hanging, rope-like cords, sometimes measuring 25 inches long, as in the case of the recent champion 'Nero.' The poodle has a long, capacious skull, the parts over the eyes well arched; good level teeth; a strong neck; muscular, straight fore legs and hind legs with hocks well let down; strong, well-proportioned and well-padded feet; and a tail carried well up. The ears are long, well set, and lie close to the cheek; and the eyes black and vivacious. The little white-coated, short-haired, curly poodle, with whose covering the least liberties

have been taken, is the widest known of the three varieties, although not the most popular on the show bench. These are essentially family pets, and their quizzical, whiskered faces are in evidence in every country from California round the world eastward to China, where this breed is still used in his ancient hunting capacity as 'a water-dog.' See Plate of Dogs.

Poodles are usually clipped over the larger part of the body, leaving the cords or curls here and there after a pattern dictated by the caprice of the master. A favorite style has always been to leave the head and foreshoulders unshorn, and this style may have had a reasonable origin in the improvement of the dog for sport by freeing his body from the long coat. That the fashion of clipping has been long continued is evident from this dog's appearance in the pictures of a long range of artists from Van Eyck, Albert Dürer, and Hogarth down.

POOH-BAH. A comic opera character created by W. S. Gilbert in *The Mikado*, who has become proverbial for the many offices he fills.

POOL, THE. The upper portion of the harbor of London; the part of the Thames just below London Bridge, which forms the limit of navigation for sea-going vessels.

POOL, MARIA LOUISE (1845-98). An American writer, born in Rockland, Mass. She removed to Brooklyn, N. Y., in 1870, where she wrote first for a Philadelphia paper and afterwards for the *Evening Post* and the *Tribune* of New York. Later she resided in Wrentham, Mass. It was not until 1887 that she became independently known through her *A Vacation in a Buggy*. Her literary work, which consists of sketches, chiefly of New England life, and much of which appeared in the periodicals, was issued in book form as follows: *Tenting at Stony Beach* (1888); *Dolly* (1891); *Roveny in Boston* (1892); *Mrs. Keats Bradford* (1892); *Katharine North* (1893); *The Two Salomes* (1893); *Out of Step* (1894); *Against Human Nature* (1895); *Mrs. Gerald* (1896); *In the First Person* (1898); *Boss and Other Dogs* (1898); *A Golden Sorrow* (1898); and *The Malvon Farm* (1899).

POOLE. The chief seaport of Dorsetshire, England, on the east coast of the county, five miles west of Bournemouth (Map: England, E 6). Its harbor is tidal and has a quayage of 2000 feet. Poole is an ancient town and a municipal county. The town owns much corporate property, has built an esplanade and shore drive, carried out harbor improvements, and established a free library. It has manufactures of sailcloth, tiles, ropes, etc., and a considerable coasting trade, and exports Purbeck clay and grain. The town is named after the pool or bay on which it stands, and which at high tide covers an area seven miles long by four and one-half broad. Population, in 1891, 15,400; in 1901, 19,500.

POOLE, JOHN (c.1786-1872). An English writer, the author of several popular farces. He also wrote novels, essays, and character sketches, some of which were republished in the United States. He is best known for his plays, *Paul Pry* (1825), *Deaf as a Post* (1823), and *Twixt the Cup and the Lip* (1826), and for his satire, *Little Pedlington and the Pedlingtonians* (1839). His other publications include: *Phineas*

Quiddy, or Sheer Industry (3 vols.); *Sketches and Recollections* (2 vols.); and *Village School Improved, or Parish Education*. The unflinching flash of his wit and the originality of his ideas secured for his works a popularity which some of them still retain. In his old age he received, chiefly through the influence of Charles Dickens, a pension of £100 from the civil list.

POOLE, or POLE, MATTHEW (1624-79). An English biblical scholar, born in York and educated at Emmanuel College, Cambridge. After taking the degree of B.A. in 1649 he became rector of Saint Michael-le-Querne, London. A staunch Presbyterian, he resigned his living on the passage of the Uniformity Act (1662). Having a small but independent income, he was now able to devote himself to his great undertaking, *Synopsis Criticorum Aliorumque Sacra Scriptura Interpretum* (5 vols., 1669-76). This Latin work, which busied him for ten years, is a summary of the critical labors of Rabbinic and Roman Catholic commentators, but contains little from Calvin and nothing from Luther. Poole also began a synopsis in English, called *Annotations Upon the Holy Bible*. Two volumes, reaching Isaiah lviii., appeared in 1683-85. The work was continued by others (last edition, 3 vols., 1840). Frightened by the Popish plot—for Titus Oates, on account of Poole's tract on the Nullity of the Romish Faith, had represented him as marked for assassination (1678)—Poole left England and passed his last years at Amsterdam.

POOLE, REGINALD LANE (1857-). An English historian, born in London, and educated at Balliol and Wadham colleges, Oxford, and at the University of Leipzig. In 1880 he became assistant in the department of manuscripts in the British Museum. Upon the establishment of the *English Historical Review* in 1885, he was appointed an assistant editor, and afterwards acted as joint editor with Gardiner, and then as sole editor. He was appointed lecturer in modern history at Jesus College in 1886, and was long lecturer on diplomacies in the Oxford University. Poole contributed largely to the *Encyclopædia Britannica* and to the *Dictionary of National Biography*, especially on subjects in mediæval history and on music; wrote *The Huguenots of the Dispersion* (1880); *Sebastian Bach* (1882); *Illustrations of the History of Mediæval Thought* (1884); and *Wycliffe and Movements for Reform* (1889); and edited the catalogues of coins in the British Museum; Wielif's *De Civili Dominio* (1885) and *De Dominio Divino* (1890); an *Historical Atlas of Modern Europe* (1897-1902); and, with M. Bateson, *Bale's Index Britannicæ Scriptorum* (1902).

POOLE, REGINALD STUART (1832-95). An English Egyptologist, born in London. He was educated in Cairo by his uncle, Edward William Lane; became assistant in the department of antiquities in the British Museum in 1852; was soon transferred to the department of coins and medals, of which he became keeper in 1870; assisted Amelia B. Edwards in establishing the Egypt Exploration Fund; lectured to the Royal Academy students in 1883-85; and in 1889 became professor of archæology in London University College. He wrote much concerning Greek and Oriental coins during his connection with the British Museum; contributed to Smith's *Bible Dictionary* and to the *Encyclopædia Britan-*

nica; and wrote the descriptive parts of Firth's *Views in Egypt*.

POOLE, STANLEY LANE. See LANE-POOLE.

POOLE, WILLIAM FREDERICK (1821-94). An American librarian. He was born in Salem, Mass., and graduated at Yale in 1849. While at college he was librarian of the Brothers in Unity Society Library, and in his junior year compiled the first edition of his *Index to Periodicals*. He was librarian of the Boston Mercantile Library, 1852-56; then became librarian of the Athenæum, where he remained thirteen years, becoming well known as one of the leading librarians of the country. He was in charge of the Cincinnati Public Library in 1869-73; of the Chicago Public Library in 1873-87; and of the Newberry Library, Chicago, from 1887 till his death. Dr. Poole was most widely known for his admirable *Index to Periodical Literature*, of which he published enlarged editions in 1853 and in 1882. The later edition and several supplements have been compiled by the coöperation of many American librarians, and other volumes have been edited by W. J. Fletcher, librarian of Amherst College. Dr. Poole was much interested in the study of American history, and in 1887 was elected president of the American Historical Association. His writings include: *The Battle of the Dictionaries* (1856); *Websterian Orthography* (1857); *Cotton Mather and Salem Witchcraft* (1869); and *Anti-Slavery Before 1800* (1887). He organized the Bronson Library, at Waterbury, Conn. (1869); the Athenæum Library at Saint Johnsbury, Vt.; and the library of the United States Naval Academy.

POOLING (from *pool*, from Fr. *pouls*, pool, stakes, hen, from ML. *pulla*, hen, from Lat. *pulus*, young animal, chicken). A division of business or of the proceeds of business among otherwise competing carriers or other parties, intended to minimize the effects of competition by maintaining rates. Pools may be divided into four classes; a *division of traffic* may be either (1) a division of the field, where the business of a particular territory is assigned to each competitor, or (2) a tonnage pool, where a certain percentage of the competitive business is assigned to each. A *division of revenue* may be either a (3) gross or (4) net money pool, according to whether it is based upon gross or net receipts. A net money pool almost necessarily involves a system of joint accounting, and is therefore a close form of combination.

Railway pooling became a matter of importance in England about 1850, but its origin is obscure. The first railway pools in the United States were probably among the New England railways, but it was in the West that pooling first became a matter of public importance. Both freight and passenger traffic between Chicago and Omaha were pooled in 1870, and the arrangement remained in force, with but one short interruption, for 17 years, the pool being merged in 1884 in the Western Freight Association. The principal roads carrying anthracite coal to the Atlantic seaboard, which also owned about 75 per cent. of the anthracite coal fields, had an effective pooling arrangement from 1872 until 1876. In 1873 the roads from Atlanta to the coast formed a pool out of which afterwards grew the strong Southern Railway and Steamship Association. The lines from Chi-

ago and Milwaukee for Saint Paul arranged a money pool for both freight and passenger traffic in 1874. During the next few years numerous pools were organized, until they covered nearly every part of the country.

Railway freight pooling was forbidden and made a misdemeanor by the Interstate Commerce Act passed in 1887, but the wisdom of this prohibition was and has continued to be a much mooted question. (See INTERSTATE COMMERCE ACT.) Most students of the subject, both practical and theoretical, favor the legalization of pooling under governmental supervision. Pooling prevents discrimination and is conducive to stability of rates, which is generally considered more important than absolute lower rates. It is argued that when the division of competitive traffic is as certain as that of non-competitive traffic both will be treated without discrimination, for there will be no reason for favoring competitive points; through traffic will then be made to bear its just share of the cost of transportation.

Upon the passage of the Interstate Commerce Act existing pooling contracts were annulled, but the attempt to prevent pooling has not been altogether successful. Traffic associations have endeavored to continue the division of traffic without resorting to the usual pooling machinery. There is abundant evidence of a physical division of cotton freight from Memphis and other interior points to the seaboard; indeed, this pool has been sustained by the Supreme Court of Tennessee. It does not fix rates, but all the roads concerned accept the lowest rate to Liverpool prevailing on any given day. There is said to be a somewhat similar division of the fruit traffic from southern California. The so-called Buffalo grain pool, which was investigated by the Interstate Commerce Commission in 1900, was intended to divide the grain traffic from Buffalo to New York and to maintain a rate of 4 cents a bushel.

At common law, the American courts have usually held pooling agreements to be contracts in restraint of trade, and against public policy. Pools have therefore been extra-legal agreements not enforceable by the courts, but dependent upon the good faith of the parties, and hence lacking in permanence. In England the courts look upon pooling with much less disfavor than in the United States; while on the Continent pooling is regarded with such favor that the Government railways of Prussia, Austria, and other countries maintain pooling arrangements with competing water routes.

Pooling is not confined to transportation lines. The Western Elevating Association is an organization of grain elevators at Buffalo which establishes uniform rates for elevating and storing grain, collects the earnings, and after deducting expenses, distributes the remainder to the participating elevators in certain specified proportions, based upon their working capacity and the business they control. Manufacturing concerns sometimes form pools for the purpose of keeping up prices by limiting production.

The term pool, or pooling, is applied also to various other forms of combination for concerted action. In a Wall Street or stock pool stockholders of a company assign their stock to a firm of bankers or brokers to be sold within a given

time, usually at not less than a stated price, otherwise the stock is to be returned to the holders, the profits, if any, being shared by all alike. Receivers of farm produce in the Cincinnati market have formed 'pools' for economy in handling the goods, fewer salesmen being required by this method.

Consult: Cooley, *Popular and Legal Views of Traffic Pooling* (Chicago, 1884); Hadley, *Railroad Transportation* (New York, 1885); Seligman, "Railway Tariffs and the Interstate Commerce Law," *Political Science Quarterly* (1887); Hadley, "Prohibition of Railway Pools," *Quarterly Journal of Economics* (January, 1890); Newcomb, *Railway Economics* (Philadelphia, 1898); *Report of the Industrial Commission*, especially vol. xix.

POOL-SELLING. A method of distributing chances in a common 'pool' or combination of stakes on some uncertain event, as a horse race. For example, in a pool on a horse race, each bettor pays in a certain amount, naming the horse he desires to 'back' and receiving a ticket as a receipt, and on the determination of the race the winner is paid the total amount wagered by all the bettors on the race, less a commission, usually 10 per cent., which is retained by the manager or person selling the pools. The term is also sometimes inaccurately applied to the method of betting with bookmakers in places at a distance from the racetrack. Pool-selling and the keeping of pool-rooms are prohibited in most States.

POONA, पो०ना. The capital of a district in Bombay, British India, on the river Mutha, near its confluence with the Mula on an almost treeless plateau, about 74 miles southeast of Bombay (119 miles by rail) (Map: India, B 5). Poona is about 1700 feet above the sea level; its climate is healthful and pleasant, and it is very much resorted to, particularly in the rainy season. The city, the former capital of the Mahrattas, is divided into seven quarters, named after the days of the week, and contains the ruins of a palatial structure, formerly the residence of the peshwa. It is the headquarters of the Bombay army and the seat of the Bombay Government from July to November. The cantonment for the infantry and horse artillery is two miles east of the city. The cantonment for the cavalry is at the village of Kirkee, about two miles to the northeast. The Deccan College, founded in 1821, has a staff of European professors with native assistants, and is a high class institution for the study of English, Marathi, and Sanskrit. There are numerous other educational institutions, including the Government College of Science, the Maharashtra College, and the Fergusson College. One of the most interesting objects in the neighborhood of Poona is a large *bund*, or embankment, solidly built of hewn stone over the Mutha-Mula River for the purpose of providing a supply of water for the cantonment, and especially the bazaar or native town connected with it. It was built by Sir Jamsetjee Jeejeebhoy, distinguished for his charities. Poona was formerly a great mart for jewelry and precious stones, but this trade has quite ceased. The native manufactures have also been supplanted by the introduction of European piece-goods, and the principal commerce is in connection with grain and other agricultural produce. In recent years

Poona suffered severely from the plague, and from 161,390 in 1891, its population decreased to 111,385 in 1901. Poona is first mentioned in the sixteenth century. It became the Mahrattan capital in 1750; it was captured and destroyed by Nizam Ali in 1763, and later in the same year the combined forces of the peshwa and Sindhia were completely defeated here.

POONA-WOOD (Kanarese *ponne*). The timber of the poon trees (*Calophyllum Inophyllum* and *Calophyllum angustifolium*) of India, commonly used for planks and spars in ship-building. See CALOPHYLLUM.

POOP (OF. *poupe*, *poupe*, Fr. *poupe*, from Lat. *puppis*, stern of a ship). A light deck, raised above the main or upper deck, and extending a short distance forward from the stern. It is all that remains of the old stern castle which towered above the upper deck in ships of the seventeenth and several preceding centuries.

POOR, ENOCH (1736-80). An American soldier, born at Andover, Mass. He became a ship-builder at Exeter, N. H., but in 1775, after the battle of Lexington, raised a regiment, of which he was commissioned colonel. In 1777 he was promoted to be brigadier-general in the Continental Army, and had a conspicuous part in the battles of Saratoga, his brigade bearing the brunt of the action on September 19th. He also distinguished himself at Monmouth (June 28, 1778), and the next year, during Gen. John Sullivan's Indian campaign, led his troops in a difficult flank movement which resulted in the decisive victory at Newtown, the present Elmira (August 29, 1779). In 1780 he was transferred to one of Lafayette's two brigades of light infantry at that general's request, but soon afterwards died while stationed at Hackensack, N. J.

POOR, THE (OF. *poure*, *povere*, *povre*, Fr. *pauvre*, from Lat. *pauper*, poor). The term used to designate those for whom it is a struggle to procure the necessities of life. In law it has reference to those who are wholly or in part dependent on public support. See PAUPERISM; MEXICANCY; VAGRANCY.

POORE, BENJAMIN PERLEY (1820-87). An American journalist, born near Newburyport, Mass. His father sent him to a military school to prepare for admission to West Point, but he ran away and apprenticed himself to a printer. At the expiration of his service his father bought for him the *Southern Whig*, an Athens, Ga., newspaper. After only two years as editor, however, he accepted an appointment as attaché to the United States legation in Brussels. During the following seven years he visited the principal countries of Europe, Egypt, and Palestine, and acted as foreign correspondent of the *Boston Atlas*. During the last four years he acted also as an historical agent for Massachusetts in France, copying from the French archives many papers of historical value and illustrating them with maps and sketches. After his return to America in 1848 he edited the *Boston Bee* and *Sunday Sentinel*, and in 1854 became the Washington correspondent of several newspapers. For a short time during the Civil War he served as major of the Eighth Massachusetts Volunteers, but soon returned to his journalistic work, at which he continued until 1884. During these years he was for a long period clerk of the Senate Committee

on Printing Records, and in this capacity compiled and edited several publications dealing with the Government, including *The Political Register and Congressional Directory* (1887); *The Conspiracy Trial for the Murder of the President* (1865); and a *Descriptive Catalogue of the Government Publications of the United States, 1774-1881* (1885). In addition he published, among other works: *Perley's Reminiscences of Sixty Years in the National Metropolis* (2 vols., 1886); *Rise and Fall of Louis Philippe* (1848); *Life of General Taylor* (1848); and *The Life and Public Services of Ambrose E. Burnside* (1882).

POORE, GEORGE VIVIAN (1843-). An English physician. He was born at Andover, was educated at the New Cross Royal Naval School, and at University College, London, and served as surgeon on the *Great Eastern* when the Atlantic cable was laid (1866). His ability early attracted attention. In 1870 he was named attendant to Prince Leopold, Duke of Albany, and in 1872 he received the Dannebrog for his services to the Duchess of Cumberland. Physician of University College Hospital (1876), he was appointed professor of medicine and clinical medicine in University College. Poore translated selections from Duchenne (1883), and wrote on sanitation and medical law, *London, Ancient and Modern, from the Sanitary Point of View* (1889), *Essays on Rural Hygiene* (1893), and *A Treatise on Medical Jurisprudence* (2d ed. 1902).

POORE, HENRY RANKIN (1859-). An American figure and animal painter, born in Newark, N. J. He was a pupil of the National Academy of Design in New York City, and of the Pennsylvania Academy of Fine Arts, under Peter Moran, and afterwards studied in Paris with Lumenais and Bouguereau. He became one of the few American painters to devote himself to animal subjects, especially dogs. His composition is vigorous, his color pleasing, and his treatment sympathetic. Among his works are "Close of a City Day" (1888), "The Ploughing of the Ephrata Brethren" (1894), "Hounds in Winter" (1898), and "Clearing Land" (1903). His publications include *Pictorial Composition and the Critical Judgment of Pictures* (1903), a valuable book for students and professionals, the fruit of several years' teaching. He received the second Hallgarten Prize in 1888, in which year he was elected an associate of the National Academy of Design; the \$2000 annual prize of the American Art Association in 1889; and a bronze medal at the Pan-American exhibition.

POOR LAWS. The laws regulating the public relief of the poor. Charities may be provided in two ways: by private initiative, as in the case of the Friendly Societies in England, or directly by the State. This latter relief is of many kinds, including the almshouse for those permanently indigent or disabled, the workhouse in case of confirmed mendicancy, and temporary outdoor aid for the casual poor. There seems to be a growing inclination on the part of the nations to make poor relief a public obligation, either by directly assuming the responsibility or by more closely regulating private efforts. There has also been a steady movement, during the last seventy five years, toward limiting the amount and scope of relief to the poor. The English legislation of 1834 and subsequent years, which practically abolished outdoor relief and threw the support

of bastard children upon the mother, strongly marks this tendency. For an extended discussion of the history of the poor laws in various countries, see PAUPERISM.

POOR RATE. The name of the tax raised in England for the maintenance of the public poor relief. The first tax levied for this purpose was in 1573. The assessment and collection were in charge of the Overseers of the Poor (q.v.). The earlier levies seem to have been on the basis of the number of acres owned, but later degrees of value were recognized. The Overseers were made subject to the courts and their assessment had to be countersigned by two justices. Great inequalities arose in the different parishes, and no fixed basis of assessment was reached until 1836, when the Parochial Assessment Act (6 and 7 William IV.) established the principle that the "net rent is the standard of ratable value." This act was permissive only, but in 1845 the justices were empowered to appoint an assessment committee, for the purpose of determining the county rate. Owing to the varying contributions of the different parishes, the law of 1861 (24 and 25 Vict., c. 55) made the share of each parish to accord with its ratable value, and in 1862 the Union Assessment Committee Act was passed. This required the Guardians to appoint a committee, to which the Overseers of each parish submit their lists of property. These lists are made public, and property-owners are given a chance to appear and to appeal. The list given out by this committee becomes the basis for levying the rate. In 1867 a special act was passed to meet conditions in London. In 1896 the amount raised by the poor rates was £21,236,297, but of this £11,892,190 was turned over to other departments. See PAUPERISM; POOR LAWS. Consult Nicholls, *History of the English Poor Law* (London, 1854), third volume by Mackay (London, 1898).

POOR RICHARD'S ALMANAC. A popular almanac published by Benjamin Franklin in 1732, and continued for twenty-five years. As "Richard Saunders" Franklin supplied in his almanacs, of which 10,000 were sold yearly, a fund of proverbs, homely wisdom and common sense of the greatest practical value to the people of this country.

POOR ROBIN. The assumed name of the author of an almanac, first issued in 1662 and continued until 1776. It was ascribed wrongly to Robert Herriek, and is supposed to be the work of William Winstanley. Throughout the seventeenth century a number of publications were issued under the name of "Poor Robin," the most popular of which was *Poor Robin's Jest*s (1667).

POOR'S ROLL. In the law of Scotland, the list of litigants unable to pay the fees of court, and therefore allowed to sue *in forma pauperis*. This privilege is granted only after special application and satisfying the court of the poverty. The warrant is granted only upon advice of counsel that the proposed action is probably a good cause, and when granted remains in force for two years, and during that time the pauper is exempt from all fees of court, and has the gratuitous services of counsel and agents. See FORMA PAUPERIS, IN.

POOR-WILL. A small nightjar (*Phalænotilus Nutalli*) abundant on the Western plains

of the United States, named from its two-syllabled characteristic note. The plumage is peculiarly soft, and bronzy, or silver-gray. The poor-will lays white, unspotted eggs. Compare WHIR-POORWILL.

POPAYÁN, pō'pá-yān'. Capital of the Department of Cauca, Colombia. It is situated near the banks of the river Cauca, 225 miles southwest of Bogotá, in a wide and beautiful plain 6000 feet above the sea, and dominated by the volcano of Puracé (Map: Colombia, B 3). It has a cathedral and a college, and some manufactures of woollen goods. Population, about 10,000. Popayán was founded in 1536 by Belalcázar. In the eighteenth century it was an important commercial and gold-mining centre, and a mint was established there in 1749. It suffered much in the civil wars, and is now in decay.

POPE. See PAPACY.

POPE, ALEXANDER (1688-1744). An English poet, born in London, May 21, 1688. His father, a linen draper, withdrew from business about 1700, and settled at Binfield, in Windsor Forest; in 1716 he moved to Chiswick on the Thames, near London. The poet's mother was Edith Turner, who belonged to a Yorkshire family. The elder Pope was a Roman Catholic, and to this faith the poet also nominally adhered, thus debarring himself from a university career. He learned to read from an old aunt and received some education in two Catholic schools as well as from private tutors (Roman Catholic priests), but for the most part he taught himself. He read widely in English poetry and studied French, Italian, Latin, and Greek. Thus left to himself, he never became an accurate scholar. Soon after the death of his father (1717) he leased (1719) a house and five acres of land at Twickenham, on the banks of the Thames, whither he withdrew with his mother, to whom he was tenderly attached, and there he dwelt till his death. In the famous villa Pope was visited by the most celebrated wits, statesmen, and beauties of the day. He died May 30, 1744. In his tenth year Pope was stricken by an illness which distorted his frame and robbed him of his plumpness and his color. His physical infirmity, susceptible temperament, and incessant study rendered his life "one long disease." He was, Lord Chesterfield said, "the most irritable of all the *genus irritabile vatum*, offended with trifles, and never forgetting or forgiving them." Of his many quarrels, that with Addison was least justifiable. Yet when no disturbing jealousy, vanity, or rivalry intervened, Pope was generous and affectionate, as witness the long friendship with Arbuthnot, Gay, and Swift, and his devotion to his mother.

Pope was the most precocious of English poets. At the age of twelve he wrote the *Ode to Solitude* and a translation of the first book of the *Thebais* of Statius (not published till 1712); and at fourteen or thereabouts, an epic called *Alexander*, which he burned about 1717. By 1706 he had composed his *Pastorals*, which were first published in Tonson's *Miscellanies* in 1709. The smooth and melodious verses at once made Pope known. The experiment in the pastoral was followed by the *Essay on Criticism* (1711), which expounded the canons of taste; the *Messiah* (1712); *Windsor Forest* (1713), a descriptive poem, less artificial than the *Pastorals*; and the *Rape of the Lock* (first draft 1712; completed in 1714),

the most graceful, airy, and fanciful of Pope's poems. In 1714 appeared *The Wife of Bath*, imitated from Chaucer, from whom he also got *The Temple of Fame*. In 1717 Pope published a collection of his works, where first appeared the *Epistle of Eloisa to Abelard* and the *Elegy on an Unfortunate Lady*, his most noteworthy lyrics. Pope was already engaged on the work that was to give him solid fame. His translation of the *Iliad* was published in six volumes (1715-20). Out of the profits of the work he purchased and adorned his villa. The translation, though wanting in Homeric simplicity, naturalness, and primitiveness, is nevertheless a splendid piece of writing, judged apart from its original. The *Iliad* was followed by the *Odyssey* (1725-26), which was, however, mostly the work of William Broome and Elijah Fenton. Though a financial success, the *Odyssey* added nothing to Pope's fame. Pope now made his famous attack on Grub Street. The *Dunciad* was finished by 1727; but before publishing it Pope stirred up his enemies with the *Bathos*, or the *Art of Sinking in Poetry*, in the *Miscellanies* (March, 1728), written in conjunction with Swift and Arbuthnot. The *Dunciad*, in three books, first appeared on May 28, 1728, and was enlarged the next year. Pope took as his supreme dunce Lewis Theobald (q.v.), who had criticised an edition of Shakespeare that Pope had brought out in 1725. Around Theobald gyrated the other dunces. In 1742 Pope added a fourth book, dethroned Theobald and put Colley Cibber (q.v.) in his place. This long lampoon, though mean in spirit, is brilliant in style. Pope closed his poetical career with the *Moral Essays* (1731-38) and a group of satires called *Imitations from Horace* (1733-38). The former group contains the famous *Essay on Man*, a philosophical poem, in which is expounded the deism of Bolingbroke, taken back in the sequel, the *Universal Prayer*. To the latter group belongs the delightful *Epistle to Dr. Arbuthnot*.

Pope has been variously estimated. To his generation he seemed the greatest of English poets. This position was questioned by Joseph Warton, who, in his *Essay on the Genius and Writings of Pope* (vol. i., 1751), placed Pope below Spenser. And the later romantics, who laid the stress on the matter of poetry rather than on its technique, had doubts as to whether Pope was a poet at all. On his rank, a memorable controversy was started by W. L. Bowles in 1806. If, in the language of Wordsworth, "poetry is the breath and finer spirit of all knowledge," uttered in impassioned language, there is little poetry in Pope. He was hardly successful in *Eloisa* and the *Unfortunate Lady*, his two experiments in pathos. They are only the rhetoric of emotion. Likewise the *Rape of the Lock* is a poem of the fancy rather than of the imagination. Without deep feeling or great imagination, Pope yet possessed rare excellences. In execution he could be faultless. He evoked the melodies of the heroic couplet, and molded it to the expression of keen wit and epigram. His proverbial philosophy, so often quoted—as "A little learning is a dang'rous thing"—is likely to be false or only half true, for Pope himself was no thinker; but in the realm of satire, as represented by the *Imitations of Horace*, he is still supreme among the English poets.

Collective editions of Pope's *Works* have been edited by W. Warburton (1751), Joseph Warton

(1797), W. L. Bowles (1806), W. Roscoe (1824), and by W. Elwin and W. J. Courthope (10 vols., London, 1871-89). The last edition, by far the best, has superseded all others. Consult also the *Concordance to Pope's Works*, by Abbott (London, 1875); *Life*, by R. Carruthers (Bohn's Library, ib., 1857), and by L. Stephen (English Men of Letters, ib., 1880); and *The Age of Pope*, by Dennis (ib., 1894). For poems alone, consult the convenient Globe edition (London and New York, 1869), and the edition in three volumes, with memoir by Dennis (London, 1891).

POPE, FRANKLIN LEONARD (1840-95). An American electrician, born at Great Barrington, Mass. In the employ of the Russo-American Telegraph Company (1864), Pope made surveys in the country between British Columbia and Alaska. When this project fell through, he went to New York, formed a partnership with Edison, with whom he invented the stock-ticker, and, in 1872, invented the rail circuit for automatic control of block signals. An able patent solicitor, he was for some time attorney to the Western Union Telegraph Company. He was killed in his own house in Great Barrington, Mass., by an electric shock received from a powerful transformer. Pope edited the *Electrical Engineer* (1884 sqq.) and wrote *Modern Practice of the Electric Telegraph* (1871; revised, 1891) and *Life and Work of Joseph Henry* (1879).

POPE, JOHN (1822-92). An American soldier. He was born at Louisville, Ky., and was the son of Nathaniel Pope, who for many years was United States Judge for the District of Illinois. He graduated at West Point in 1842. After graduation he served as brevet second lieutenant in the topographical engineers, and in 1846 joined General Taylor in Mexico. He was brevetted first lieutenant for gallantry at the siege of Monterey and captain for services at the battle of Buena Vista. After the close of the war he conducted an expedition which explored the region of the Red River of the North; was on engineering service in New Mexico in 1851-53; and from 1853 to 1859 had charge of the work of surveying a route for the Pacific railroad. Upon the beginning of the secession movement Pope came out on the side of the North, and in the winter of 1860-61 delivered a number of Union speeches. For criticising the policy of President Buchanan in one of these speeches, he was summoned to appear before a court-martial, but the trial never took place. In May, 1861, he was appointed a brigadier-general and was given command of the District of Northern Missouri. In the following December he defeated General Sterling Price at Blackwater and captured about 1500 prisoners and a large quantity of supplies. He next co-operated with the flotilla of gunboats under Foote in the operations against Island No. 10, which place surrendered in April, 1862, with about 7000 men and 158 cannon. He then took part in the operations against Corinth, after which he was promoted to be major-general of volunteers and brigadier-general in the Regular Army, and was given command of the Army of Virginia, comprising the corps of Generals Fremont, Banks, and McDowell.

He entered upon the new campaign with a somewhat bombastic proclamation, but after some engagements between portions of his army and the forces of General Jackson, and after he had

been reinforced by a large part of the Army of the Potomac, he was badly defeated by Lee and Jackson at the second battle of Bull Run (q.v.). August 29 and 30, 1862, and was forced to retire to the defenses of Washington. He attributed his defeat to the inactivity of the army under McClellan and to the failure of certain officers, particularly of General Fitz-John Porter, to carry out his orders. A court-martial found Porter guilty and dismissed him from the service, but years afterwards the decision was reversed. Pope himself asked to be relieved from command; the request was granted, and he was sent to carry on the war against the Sioux Indians. There has been much dispute as to Pope's responsibility for the disastrous outcome of his campaign against Jackson and Lee, but the weight of opinion has on the whole been unfavorable to him. In January, 1865, after the close of the Indian war, Pope was placed in command of the military Division of the Missouri, which was later enlarged into the Department of the Missouri. In 1867-68 he commanded the Third Military District organized under the Reconstruction Act; in 1868-70, the Department of the Lakes; from 1870 to 1884, the Department of the Missouri; in 1882 was made major-general in the Regular Army; and from 1884 until his retirement in 1886 commanded the Department of the Pacific. He published a report of his explorations for a railroad in vol. ii. of *Reports of Explorations for a Railroad* (1855), and *The Virginia Campaign* (1863). For an excellent account of his campaign against Lee and Jackson, consult Ropes, *The Army Under Pope* (New York, 1881).

POPE, Sir THOMAS (c.1507-59). An English administrator, founder of Trinity College, Oxford. He was born near Banbury, studied at Eton, and entered the employ of Lord Chancellor Audley, who aided much Pope's advancement. Clerk of briefs to the Star Chamber in 1532, he was knighted in 1537 and by 1544 had become a member of the Privy Council. Thanks to his relations with this body, he received many grants of monastic property, and under Mary and Elizabeth regained the favor he lost under Edward VI. In 1555, being one of the richest commoners of England, he founded at Oxford the College of "the Holy and Undivided Trinity."

POPE, WILLIAM BURT (1822-1903). A Methodist theologian, the first to write from the standpoint of modern theological science. He was born at Grand Pré, Nova Scotia; was educated at Richmond College, London; was pastor in England, 1841-67; and in the latter year became professor of theology at Didsbury College, Manchester. He is the author of *Discourses on the Kingdom and Reign of Christ* (1869); *Fernley Lectures on The Person of Christ* (1875; 3d ed. 1899); *Christian Theology* (2d ed., 3 vols., 1877-80); *The Prayers of St. Paul* (1876); *Sermons and Addresses* (1878); and *A Higher Catechism of Theology* (1883).

POPE OF GENEVA, THE. A popular name given to Calvin.

POPERINGHE, pōp'rāng'. A town in the Province of West Flanders, Belgium, six and a half miles from Ypres by rail and four miles from the French frontier (Map: Belgium, A 4). The town is walled and its thirteenth-century parish church is interesting. Its manufactures, which

date from mediæval days, include lace, linens, and woolen cloths. Hops are grown in the district. Population, in 1890, 11,112; in 1900, 11,552.

POPERY LAWS. A term employed to designate certain legislation in England directed against the temporal and ecclesiastical power of the Pope. The first of these statutes seems to have been enacted in the reign of Edward I. In the reign of Richard II, the famous Statute of *Præmunire* (q.v.) was enacted. A number of these old laws still exist on the statute books. Freedom of religion is one of our institutions, and no similar laws exist in the United States. Consult Blackstone, *Commentaries*.

POPEYE. A fish of the North Pacific (*Macrurus cinereus*), one of the grenadiers (q.v.), and so excessively numerous in the depths of Bering Sea that it outnumbers all other fishes there, and furnishes an abundance of food for the marine animals of that region.

POPHAM, pōp'am, GEORGE (1550-1608). An English colonist, born in Somersetshire. As an associate of Sir Ferdinando Gorges in a colonization scheme for a part of Maine, he sailed from Plymouth, England, in 1607, with two ships and 100 men, and landing at the mouth of the Kennebec River, there made the first English settlement in New England, building a storehouse and a fortification which was called Fort Saint George. Popham was elected President of the new colony, but died the following year, and the colonists, becoming disheartened by the severity of the climate, returned in the spring to England.

POPHAM, Sir JOHN (c.1531-1607). An English jurist. He was born at Wellington, Somersetshire, studied at Balliol College, Oxford, and in the Middle Temple, and may have been a member of Parliament in Mary's days. He was certainly recorder of Parliament in 1571, and from 1572 to 1583, and in 1580 was elected Speaker. A year afterwards he became Attorney-General. In 1592, after conducting many State trials as Crown prosecutor, especially those of the Babbington conspiracies, Popham was made Chief Justice and was knighted. A severe judge, he presided at the trial of those implicated in Essex's insurrection, of Sir Walter Raleigh, and of Guy Fawkes. He wrote *Reports and Cases* (1656), a work of small value. He became interested in American colonization, and with Ferdinando Gorges obtained from James I. patents for two companies known respectively as the London Company and the Plymouth Company, the patentees being authorized to make settlements in America and maintain a general government for twenty-one years. Popham sent out an exploring expedition under Martin Pring, and in the following year the short-lived Popham colony, under his brother, George Popham, was established at the mouth of the Kennebec River in what is now the State of Maine.

POPINJAY (OF. *popejaye*, *papegai*, *papegau*, *papegaut*, Fr. *papegai*, *papegaut*, parrot, from ML. *papegallus*, from MGk. *παπαγάλος*, *papagallos*, *παπαγός*, *papagas*, parrot). A name of the green woodpecker (*Picus viridis*), a bird common in most of the wooded districts of England and Scotland. (See WOODPECKER.) The name was originally applied to parrots, but is

no longer in use in that sense. In the Middle Ages and even later the name *popinjay* in England and *papegai* in France was given to a target made to look like a parrot. The effigy was set on a pole and shot at by archers. The most skillful marksman often received a silver popinjay as a prize. Consult Jusserand, *Jeux et sports d'exercice dans l'ancienne France* (Paris, 1901), and Strutt, *Sports and Pastimes* (London, 1801 ff.).

POPISH PLOT. See OATES, TITUS.

POPLAR (OF. *poplier*, *peuplier*, Fr. *peuplier*, from *peuple*, poplar, from Lat. *populus*, poplar), *Populus*. A genus of trees, forming with willows the natural order Salicaceæ. The species number about 20, chiefly natives of the temperate and cold regions of the Northern Hemisphere, half of them occurring in the United States. They are large trees of rapid growth, with soft wood, and usually have broad, heart-shaped, ovate triangular or lozenge-shaped, deciduous leaves, on rather long stalks. Many of them are beautiful. The catkins appear long before the leaves,

breaks and shade in the prairie regions of the West they are also popular. The wood is extensively employed in making wood pulp, paper, etc. Besides the species known by the name aspen (q.v.) or tremulous poplar, the following seem the most worthy of notice: The white poplar or abele (*Populus alba*), a native of Southern Europe, is a tree of 80 feet or upward, with a fine spreading head, and roundish, heart-shaped, lobed, and toothed leaves, which are smooth, shining, and dark green above, downy and silvery white beneath. It has been introduced into the United States and has spread from New Brunswick to Pennsylvania. The wood is used by cabinet-makers, turners, and toy-makers. It is little liable to swell or shrink, which adapts it to these purposes. The gray poplar, which is a form of *Populus alba*, is very similar to the white poplar, a large spreading tree with leaves similar to those of the white poplar, but not so dark green above nor so white beneath. It is of less rapid growth than the white poplar and its wood, which is believed to be harder and better, makes good flooring, and is preferable to pine

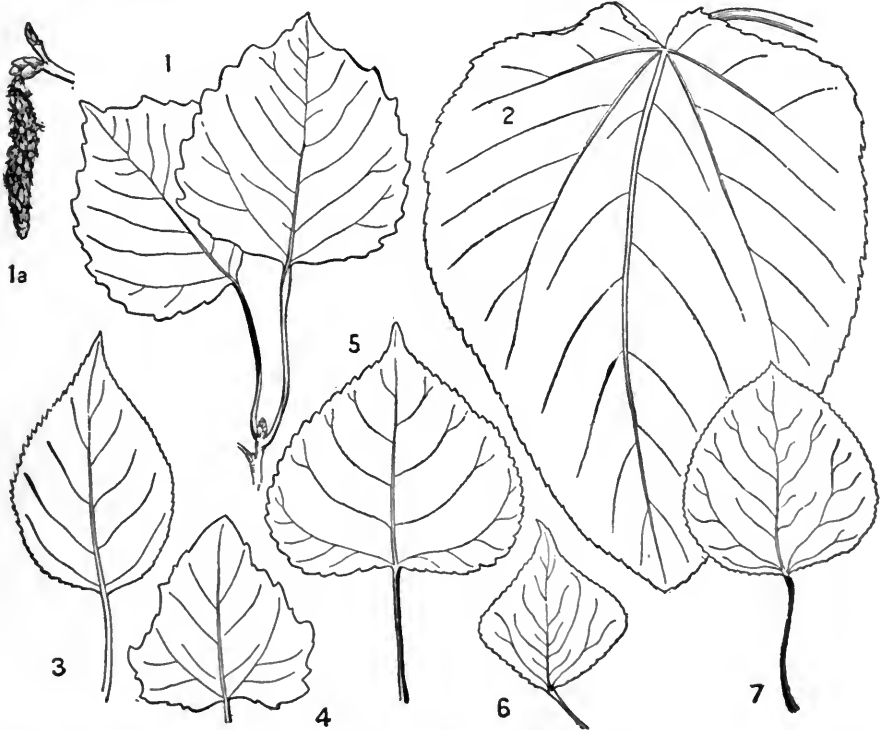

POPLAR LEAVES.

1, large-toothed aspen (*Populus grandidentata*); 1a, ament of above; 2, swamp poplar (*Populus heterophylla*); 3, balsam poplar (*Populus balsamifera*); 4, silver-leaf poplar (*Populus alba*); 5, cottonwood (*Populus deltoides*); 6, Lombardy poplar (*Populus nigra*, var. *Italica*); 7, American aspen (*Populus tremuloides*).

and proceed from distinct lateral buds. Few of the poplars are of much value for their timber, which is generally white, soft, and light; but from their rapid growth they are useful as yielding firewood where the scarcity of other fuel renders necessary the planting of trees for this purpose. They are often planted as ornamental trees, since they produce an immediate effect of embellishment in a bare situation more readily than almost any other kind of tree. For wind-

for the neighborhood of fireplaces, being less apt to take fire. It is also used for coarse doors, carts, barrows, etc., and, not being liable to warp, is esteemed by wood-carvers. The tree generally begins to rot in the heart when forty or fifty years old. Like most of the other poplars, it fills the ground with suckers. The black poplar (*Populus nigra*), a native of most parts of Europe, is a tree of 50 to 100 feet high, with an ample spreading head, viscous leaf-buds, and deltoid or

unequally quadrangular, perfectly smooth leaves. It has become introduced and well established in the valleys of the Hudson and Delaware rivers and elsewhere. The wood is used for the same purposes as that of the white and gray poplars. The cotton from the seeds has been used in France and Germany for making cloth hats and paper, but these uses of it were not found profitable. The Lombardy poplar (*Populus nigra*, var. *Italica*, sometimes called *Populus fastigiata* and *Populus dilatata*) is a variety of the black poplar, with erect instead of spreading branches, which appears to have been introduced into Europe from the East, is very common in the Punjab and in Persia, and now also in Lombardy and other parts of Italy. It attains a height of 100 or even 150 feet, and is remarkable for its erect form, contracted head, and very rapid growth. It is sometimes planted as an ornamental tree. Owing to extensive planting during the latter part of the eighteenth century and the early years of the nineteenth, the tree is a very common one in Europe and America. The balsam poplar or tacamahac (*Populus balsamifera*), a common ornamental tree, is a native of both North America and Siberia, has viscid leaf-buds and whitish, ovate-oblong leaves, which in spring are of a delicate yellow tint, and have an agreeable fragrance. The erect fastigiata manner of growth approaches that of the Lombardy poplar. The cottonwood (*Populus deltoides* or *monilifera*), frequently planted for ornament, is the largest of the poplars, specimens 150 feet high and 7 feet in diameter being not uncommon in moist soil along rivers and lakes. It abounds from Quebec to the Northwest Territory, and south to Florida and New Mexico. In Europe it is also known as the black Italian poplar and Canadian poplar. In the Western States the tree is planted for fuel and for its timber, which is considered valuable. *Populus heterophylla*, the swamp poplar, is common from New York to Georgia and west to Arkansas and Texas. It is a tree 80 feet high and has very large cordate leaves. There are a number of other American species, which differ mostly in size of tree and shape of the leaves.

Fossil poplar leaves are known in the Cretaceous rocks of Greenland, and are common in most plant-bearing beds of the Tertiary, differing little from the modern species.

POPLAR BLUFF. A city and the county-seat of Butler County, Mo., 73 miles west by south of Cairo, Illinois; on the Black River, and on the Saint Louis, Iron Mountain and Southern Railroad (Map: Missouri, F 5). It is situated in a district interested chiefly in lumbering and cattle-raising, and carries on a considerable trade in its principal manufactures—lumber and foundry products and brick. The water-works are owned by the municipality. Population, in 1890, 2187; in 1900, 4321.

POPLAR INSECTS. Of several borers which damage the trunks and twigs of both native and Lombardy poplars, *Saperda calceolata* is most prominent. The beetles are found and lay their eggs commonly in August and September. The same species also effects cottonwood in the Western States. The poplar girdler (*Saperda concolor*) frequently girdles the upper branches of large trees, the beetles issuing about the end of May.

One of the largest of the longicorn beetles of the United States (*Prionus laticollis*) lives in the larval state in the trunks and roots of the Lombardy poplar, but also occurs in apple, grapevine, and pine. The poplar goat-moth (*Cossus ceterensis*) lays its eggs commonly upon the bark of the aspen (*Populus tremuloides*) and also upon the bark of balm of Gilead (*Populus balsamifera*). Another common borer in this tree is the Lombardy poplar borer (*Agriilus granulatus*), and still another is the poplar ægeria (*Ægeria tricincta*). A number of caterpillars attack the leaves, including the common tussock-moth caterpillar, the poplar spanworm (larva of *Biston ursaria*),

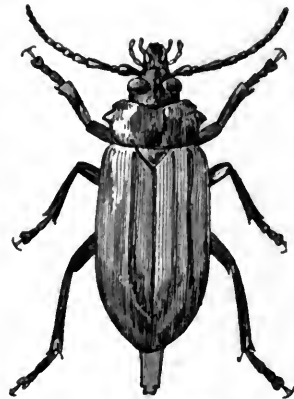

BROAD-NECKED PRIONUS (*Prionus laticollis*).

the larva of the Antiope butterfly, and the larva of the common butterfly *Limenitis disippus*, as well as the larva of the Io moth and several other moths. The insect fauna of the poplar in the United States comprises more than 100 species, including several geometrid and noctuid larvæ, a number of leaf-miners and leaf-folders, and several species of plant-lice. Consult Packard, *Insects Injurious to Forest Trees* (Department of Agriculture, Washington, 1890).

POPLIN (Fr. *popeline*, *papeline*, from It. *papalina*, poplin, from *papa*, pope; so-called because first made at Avignon, the Papal residence from 1309 to 1376). In the fifteenth century a fabric was woven in Avignon called *papeline*, which was made of silk, and was much esteemed. An attempt to imitate it was made in England, and in 1775 the manufacture was introduced to Ireland by French Protestant refugees, and from that time Irish poplins have been famous. What the exact nature of the original *papelines* was is not certainly known; but the best modern poplins consist of a warp of silk and a filling of worsted, which gives substance, combined with great softness and elasticity, to the material. The filling or weft is made heavier than the warp. This gives the material a corded surface resembling rep. In *double poplin* both the warp and woof are very heavy, making the corded appearance more prominent.

POPOCATEPETL, pò-pò'ká-tá-pèt'l (Aztec, smoking mountain). A volcano situated about 40 miles southeast of the City of Mexico (Map: Mexico, K 8). It rises in the form of a cone to a height of 17,520 feet above sea-level, and is composed chiefly of porphyritic obsidian. Forests girdle its lower parts, and vegetation ceases only near the snow line. About the period of the Spanish conquest it was very active, but no considerable eruption has been recorded since 1548, though minor eruptions occurred as late as 1802, and the crater still emits fumes. Its crater, which has a diameter of about 2700 feet,

POPLARS

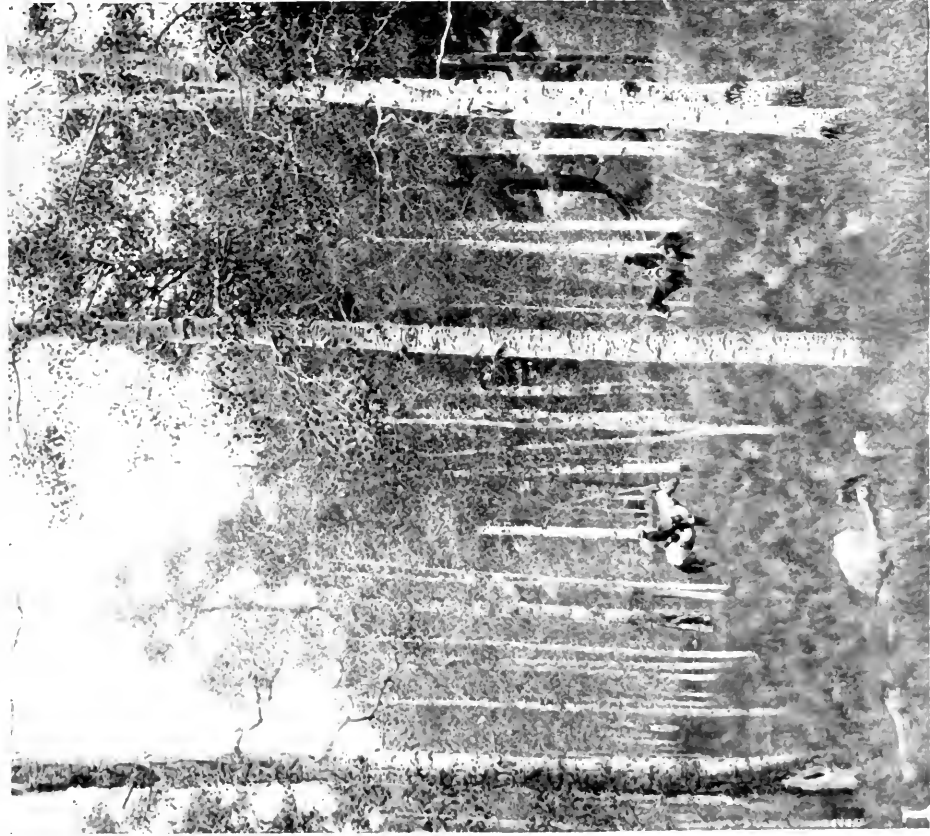

1 ASPEN FOREST, ARIZONA (*Populus tremuloides*).



2. LOMBARDY POPLAR (*Populus nigra*, var. *italica*).



contains vast quantities of native sulphur in a very pure state. It is exploited from time to time by mining engineers, the system being unique. Indians are employed who ascend the mountain daily, fill sacks with sulphur in the crater, and then descend by sliding down the precipitous snow side of the volcano. The mountain was first ascended by Diego Ordez in 1522, and since that time the ascent has been accomplished a number of times.

POPOL VUH, pò-pòl' voo' (Quiché, national book). The sacred book of the Quiché (q.v.) of Guatemala. It consists of fragments, more or less complete, of the national traditions and legends, written down in the Quiché dialect, at some unknown early date after the conquest, by a native who was evidently familiar with the ancient records. It is in two parts, the first containing the ancient mythology, the second the early history of the tribe, supplemented by a history of the neighboring and cognate Cakchiquel (q.v.). There is evidence that at least a part of it was originally in rhythmic form. A Spanish translation by Father Ximenez was published in Vienna in 1857, and the original text, with French translation, was issued at Paris by the Abbé Brasseur de Bourbourg in 1861.

POPPEA SABI'NA (?A.D. 66). A wife of the Emperor Nero. She was the daughter of Ollius, a client of Sejanus, but took the name of her mother's father, who was consul in the year 9. She married Rufus Crispinus, praetorian prefect, and after becoming the mistress of Otho (q.v.) was divorced from Crispinus. She then married Otho and soon aroused the desires of Nero, who sent her husband to Lusitania, made her his mistress, put his mother (Agrippina) to death at her instigation, then divorced and killed Octavia for her sake. Poppæa bore him a daughter in 63. The child died at four months. Poppæa was killed by a kick from her husband when she was again pregnant. She was entirely unscrupulous, luxurious and proud, if we are to trust the highly colored narrative of Tacitus. Besides her beauty, her only good point seems to be that she urged on Nero clemency to the Jews, wherefore she won high praise from Josephus.

POPPER, DAVID (1843—). An Austrian violoncellist. Born in Prague, he studied in the Conservatory there, became soloist and conductor in the Vienna Royal Opera, married the pianist Sophie Menter in 1872, and with her toured Europe. In 1876 he was divorced from his wife and settled at Budapest. His playing, which is brilliant and remarkably sympathetic, has placed him in the front rank of modern violoncellists, while his compositions for the cello are in universal use.

PÖPPIG, Pĕ'pik, EDUARD FRIEDRICH (1798-1868). A German traveler and naturalist. He was born at Plauen, and after studying at Leipzig set out for Cuba in 1822. He spent two years there, then for some time traveled in the United States, especially in central Pennsylvania, and in 1826 went through Southern and Central Chili. After two years in the forests of the Province of Maynas, where he lived with the Indians, he returned to Germany (1832), with valuable collections of botanical and zoological material, be-

came professor of zoölogy at Leipzig (1833), and did much for the foundation of the zoölogical museum in that city. He wrote *Reise in Chile, Peru und auf dem Amazonenstrom* (1835), and *Illustrierte Naturgeschichte des Tierreichs* (1851). Consult the biography by Ratzel in the *Mitteilungen* of the Leipzig Geographical Society.

POPPY (AS. *pōpig, papig*, from Lat. *papaver*, poppy), *Papaver*. A genus of the natural order Papaveraceæ, annual and perennial bristly-haired herbs, natives mostly of warm countries. The leaves are alternate and entire or lobed and cut. The poppy has been in cultivation from early times. It was grown by the Swiss lake-dwellers, and a species native to the shores of the Mediterranean was utilized by the Greeks and Romans. By far the most important species is the opium, white, or oil poppy (*Papaver somniferum*), important alike for its yield of opium (q.v.) and for the bland, fixed oil of the seeds, used like olive oil. The seed contains no opium nor any narcotic principle, and was well known to the ancients as a pleasant article of food, but the manufacture of oil was at one time prohibited in France from the mistaken notion that the oil must be narcotic. The seeds yield about 40 per cent. of the oil, and the oil-cake is useful for manure or for feeding cattle. The oil is sometimes used by painters and by soap-boilers, but is not good for burning. In the cultivation of the poppy for oil the seed is often sown in autumn, where the severity of the winter frosts is not to be feared; in more northern parts it is sown in spring, and sometimes the seed is scattered on the snow. Being very small, it needs little or no harrowing. Early sowing is favorable to the size of the plant and the yield. The plants are often cultivated in drills. An open but rich soil is best, and a sheltered situation is necessary, as in exposed situations much of the seed is scattered by the wind. In the United States the poppy is chiefly known as a garden flower.

Under cultivation the flowers of the poppy readily become double, and a large number of ornamental varieties have been derived from various species. As ornamental plants they are popular on account of their large showy flowers, their hardiness and ease of culture. The Oriental poppy (*Papaver orientale*), a native of Armenia, is one of the most important decorative species. Its flowers, which are deep crimson, are larger than those of any other species. The Iceland poppy (*Papaver nudicaule*), a native of Siberia

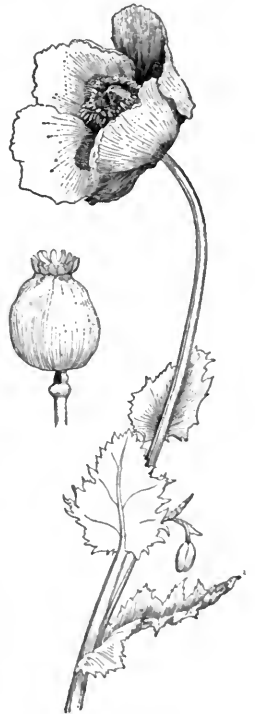

OPIMUM POPPY.

and the northern parts of America, has orange or yellow flowers and is a widely distributed alpine species. The Oriental and the Iceland poppy are the best perennial species cultivated for ornament. The corn poppy or common red poppy (*Papaver Rhoeas*) is an annual occurring as a weed in European grain fields, especially on calcareous soils. Its bright red flowers make it very conspicuous. A large number of ornamental varieties have been developed from this species. The ornamental poppies grow well in any garden soil, but they produce the best results on sandy loams. The seed is sown in spring in shallow drills where the plants are to bloom, and are later thinned to about one foot apart. For illustration of California poppy, see Plates of CALIFORNIA FLORA and POPPY AND PEPPER TREE.

POPPY FAMILY. An order of plants. See PAPAVERACEÆ.

POPPY-SEED OIL (*Oleum papaveris*). An oil obtained from the seeds of the opium poppy (see POPPY) by pressure. It is used for salads and other purposes, much the same as olive oil, to adulterate which it is often used. The seeds yield about 40 per cent. of oil.

POPULAR SOVEREIGNTY, or SQUATTER SOVEREIGNTY. Terms in American history used interchangeably by many writers and having reference to the right of the inhabitants of a Territory to regulate their internal affairs in their own way without the intervention of Congress. Strictly speaking, the term popular sovereignty was applicable only in the case of an organized Territory, while squatter sovereignty applied only to an unorganized territory inhabited by 'squatters.' The theory of popular sovereignty grew out of the discussions over the question as to whether slavery should be permitted in the territory acquired from Mexico. The first assertion of the doctrine by a man of prominence appeared in the noted Nicholson letter of General Cass, December 24, 1847, in which he expressed the opinion that the people of the Territories should be left "to regulate their internal concerns in their own way." The new doctrine was accepted by the South and was quite generally regarded with favor as being in harmony with the American traditions of local self-government, and furthermore as relieving both Congress and the States from the responsibility of settling a vexatious question. The compromise measures of 1850, in providing for the organization of New Mexico and Utah as Territories without any reference to slavery, would seem to have been the first recognition of the principle, although, on account of the evasive language used, it is difficult to say whether popular sovereignty was a feature of the bill or not. In the later discussions the Southern Democrats claimed that it was not, while Stephen A. Douglas, the great champion of the new theory, asserted that it was. In 1854 the Kansas-Nebraska Bill (q.v.) expressly adopted the principle as the basis for the government of those Territories. Shortly afterwards the South came to repudiate the doctrine of popular sovereignty as dangerous to slavery, and put forward the claim that neither Congress nor the Territorial authorities could legislate against slavery in the Territories, but that it was their constitutional duty to protect the right of property in slaves as recognized by slave States. There is an *obiter dic-*

tum in the famous Dred Scott case (q.v.) which upholds the Southern contention as far as the national Government is concerned. The controversy regarding the question of popular sovereignty, as involved in the Lecompton Constitution (q.v.) for Kansas, brought about a division between the Douglas Democrats of the North and the more radical Southerners, which eventually developed into the split of 1860. With the Civil War and the abolition of slavery the question lost its significance.

POPULATION (ML. *populatio*, from *populare*, to populate, from Lat. *populus*, people; connected with *plenus*, full, and ultimately with Eng. *full*). The number of living human beings. This article will present the leading facts regarding the number of human beings and the number in various classes; reserving for the article VITAL STATISTICS the main facts regarding the increase in the number of human beings. The distinction between population and vital statistics corresponds closely to the distinction between the main sources of information, namely, the census reports and registration reports. In census reports the element of time is either disregarded or reduced to a minimum and an attempt is made to photograph certain aspects of the population as they were on the census day. Registration reports are records of certain defined events within a population group, such as births and deaths, marriages and divorces, immigration and emigration, legal punishments for crimes, the record being made at or soon after the event recorded. Inferences regarding the increase of a population in time may be derived from comparing a series of censuses; but the census cannot give the detailed information about increase or decrease derivable from registration reports.

The population is ascertained by many methods of different degrees of accuracy. Houses are counted and multiplied by the estimated number of persons to a house. The population of school age or the number of names in a city directory is counted and the result multiplied by a number representing the ratio that the class is believed to bear to the total population. But in most cases such methods result in great uncertainty and error, and have gradually been superseded in civilized countries by the slow, expensive, but far more accurate method of a complete count or census. At the present time two-thirds of the population of the earth has been thus counted. The extension of representative institutions has necessarily extended the census as an accurate means of counting population, for under a representative system political power is distributed in some measure according to numbers. It is not surprising, therefore, that the United States, as a great modern country with representative institutions, was the first to count its population by a census.

The population of the earth's surface at the beginning of the twentieth century was probably about 1,500,000,000. About nine-tenths of this population is included within the jurisdiction of eleven of the principal States of the world. The distribution in round numbers is as follows, the figures embracing all colonial possessions and dependencies of every kind (some merely nominal):

POPPY AND PEPPER-TREE



CALIFORNIA POPPY (*Eschscholzia Californica*).

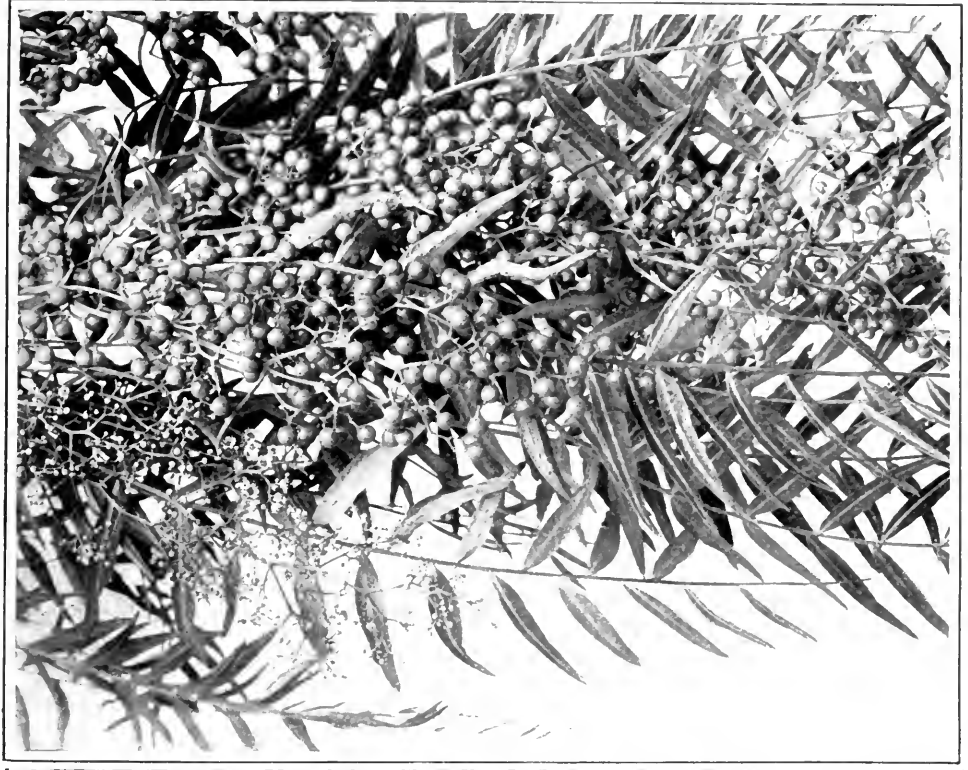

BRANCH OF PEPPER-TREE (*Schinus Molle*).



COUNTRY	Population in millions
Chinese Empire.....	400
British Empire.....	400
Russian Empire.....	135
France.....	85
United States (including the Philippine Islands and Porto Rico).....	84
German Empire.....	70
Austria-Hungary.....	45
Japan.....	44
Netherlands.....	43
Ottoman Empire (with Egypt, Bulgaria, Bosnia, etc.)	40
Italy.....	32

INCREASE. At no time since recorded history began has the increase of population been so rapid as during the nineteenth century, especially the second half of it, when the outflow of people from Western Europe to America, Australia, and South Africa added great numbers to the population of those continents without a corresponding decrease in the countries from which they set forth. (See **EMIGRATION.**) Between 1800 and 1850 the population living within the present area of the German Empire in Europe increased about 43 per cent., and between 1850 and 1900, notwithstanding the great currents of emigration, it increased about 61 per cent. The population on the present territory of Italy increased in the first half of the century about 43 per cent. and in the last half about 35 per cent. The population of Great Britain and Ireland increased in the first half of the century about 70 per cent., and in the last half about 50 per cent. The United States of America increased in population during the first half of the century 340 per cent. and during the second half 228 per cent. But in a case where the initial population is small, percentages are less significant than figures of actual increase. The United States added to its population between 1800 and 1850 nearly 18,000,000 people, and between 1850 and 1900, disregarding the accessions of territory since 1890, it added nearly 52,500,000. At the present time there is no great country except Argentina in which population is increasing at a higher rate than in the United States. Notwithstanding the comparative sparseness of settlement in Canada, Mexico, and Australia, the percentage of increase in those countries is less, and in Europe there is no country in which the rate of growth approaches that of the United States.

URBAN POPULATION. No feature in the rapid increase in the population of civilized countries during the nineteenth century has been more marked than the growth of cities, both in the older European countries and in the newer countries whither that European population has migrated. The results of the last censuses of foreign countries are not yet in every case available, and therefore the following figures speak for 1800 and 1890, or the nearest census years. The countries are arranged in the order of the proportion of urban population in 1890 in the following table.

The following figures illustrate the degree to which the growth of city population during the nineteenth century in nearly all parts of the civilized world outstripped that of population as a whole.

SEX. About half the probable population of the world has been enumerated with relation to sex. From the results it appears that about 50.3 per cent are male and 49.7 per cent. female.

COUNTRY	Per cent. of population living in cities having at least 10,000 inhabitants	
	1800	1890
England and Wales.....	21.3	61.7
Scotland.....	17.0	49.9
Australia.....	41.4
Belgium.....	13.5	34.8
Saxony.....	8.9	34.7
Netherlands.....	29.5	35.5
Uruguay.....	30.4
Prussia.....	7.3	30.0
Argentina.....	27.8
United States.....	3.8	27.6
France.....	9.5	25.9
Italy.....	20.6
Ireland.....	7.8	18.0
Hungary.....	5.4	17.6
Canada.....	17.1
Austria.....	4.4	15.8
Japan.....	13.1
Mexico.....	13.0
Russia.....	3.7	9.3
British India.....	7.3

In Europe alone among the great divisions of the earth's surface do the females outnumber the males, there being on that continent among the enumerated population about 49.4 per cent. males and 50.6 per cent. females. The numerical excess of females in Europe is much greater than the excess of males in the continents to which migration has mainly gone, such as America and Australia, and therefore it follows that in the countries representing Caucasian or white civilization females outnumber the males. But in most other parts of the world for which we have information the reverse is true. Thus in British India 50.9 per cent., in the tributary States 51.7 per cent., and in Japan 50.5 per cent. of the population are male. The excess of males in these countries more than offsets the excess of females in all Europe. It seems likely that in China, which contains the largest body of population, for which we have no information, as in India and Japan, the males outnumber the females. It is even suggested by the foregoing facts that the Occidental civilization of Europe and America, so far as the proportion of the sexes is not disturbed by migration, tends to establish a slight excess of females, while the Oriental civilization of India, China, and Japan tends to the reverse relation. In every case, however, where migration is not an important factor, the departure from numerical equality is slight and relatively insignificant.

AGE. It is usual for a census to report the number of persons of each year of age, or at least the number falling within certain wider age limits. In large population groups the true number of persons living at any year of age is larger than the true number of persons at the next higher year, this being due to the fact that each such group as it advances from infancy to old age is steadily depleted by death. If the group is receiving a large number of immigrants, this would tend to neutralize for certain age groups the wasting away through death, but immigration is seldom, if ever, sufficient in amount to balance the losses from mortality. The births in successive years also vary in number, and thus the initial size of these successive groups differs, but neither this cause alone nor this combined with immigration and other minor disturbing factors makes it likely that the true number of persons in a country at any one year of age is ever smaller than the true number at the next greater

year of age. The reported number very often is greater, this difference between the true and the asserted number being due to inaccuracy in the statements of age made in answer to the inquiries of the census enumerator. These inaccuracies vary with the degree of education and the economic position of the class reporting. Where they exist in large numbers they are indicated by a disproportionate number of individuals reported with ages at multiples of 5, and especially of 10. Internal evidence of the relative accuracy with which ages are reported, and perhaps indirectly of the relative accuracy with which other census questions are answered, may be found by measuring this concentration of reported ages on multiples of 5 and 10. The true number of persons in a community aged 30, 35, 40, 45, 50, 55, and 60 is probably about one-fifth of the total number whose age is reported as between 28 and 62, inclusive. The per cent. by which the reported number of these seven ages exceeds the estimated number affords a measure of the irregularity of the age distribution and so of the probable error in the returns. Measured by this test there were 1,670,000 persons in the United States in 1890 and 1,250,000 in 1900 between 28 and 62 years of age, whose ages were reported erroneously as a multiple of 5. The reported number in 1890 was 38 per cent. and in 1900 23 per cent. in excess of the estimated true number.

Perhaps the best single figure indicating the age composition of a population group is the median age, or an age such that half the members of the group are above and half are below it. For the white population of the United States this median age increased almost steadily during the nineteenth century from 16.0 in 1800 to 23.4 in 1900, the increase being due in part to the increased longevity of the adult population and in part to the steadily decreasing proportion of children. The median age of the population in the South (South Atlantic and South Central divisions) was 19.5 years in 1900, that of the population in the North (North Atlantic and North Central divisions) was 24.5, a difference of 5 years.

The proportion of the population falling within various age classes is of importance for itself and as indicating reasons for other statistical differences between population groups. Thus in Indian Territory 15.3, in South Carolina 15.2, and in Utah 15.1 per cent. of the population are under 5, these being the regions of the United States in which the proportion of children is greatest. At the other extreme there are the District of Columbia, with 8.3 per cent., California, with 8.5, and Nevada, with 8.9. The greatest proportion of elderly persons is found in the northern New England States, Vermont having 8.1, New Hampshire 7.9, and Maine 7.9 per cent. of the population over 65 years of age.

MARITAL CONDITION. The relation of the population to the social institution of marriage is measured by numbering the classes of the single, the married, the widowed, and the divorced. This relation depends largely upon the age composition of the population group. The great majority of those who live to adult years marry, and half of those who marry are widowed, a small additional number being divorced. The age at which marriage is entered differs greatly according to the character of the civilization. Thus in countries

dominated by Caucasian standards it is usual to assume that marriage does not take place below the age of 15. In India, on the contrary, in 1891 6 per cent. of the boys and 17 per cent. of the girls under 15 years of age were married. In uncivilized and semi-civilized countries marriage of adults is practically universal. Celibacy is regarded as unnatural and almost prohibited by social opinion. A Chinese authority writing for European readers says: "In Europe every one old enough to enter the army receives a military training; in China every one old enough to marry, marries." So in India of the women over 50 less than one per cent., and of the men about three per cent. are still single. In Europe and America among persons who have lived through the reproductive period of life the proportion of the single is from 10 to 20 per cent. for women, except in Hungary and the United States, and from 7 to 14 per cent. for men. In the United States the proportion of the population who are married has been ascertained for 1890 and 1900, with results that differ but little from the above. When the figures are analyzed by age it appears that among the young of both sexes there was a slight increase in the proportion of married persons, and at higher ages a slight decrease in the proportion of married, the two about offsetting each other. This change is contrary to the general trend in most countries and in one or two American States for which figures covering a longer period are available. It is probably the result of very prosperous conditions in the two or three years immediately preceding 1900, marriage figures constituting a sensitive measure of prosperity.

RELIGION. Civilized countries differ in regard to making inquiries into the religious affiliation of the population. In Italy, France, Great Britain, and the United States it is thought unwise to ask this question through the census. Accordingly, the population, or the enumerated population, of the earth cannot be distributed with accuracy according to religious confession. According to a careful attempt made to secure approximate results in this field, the figures in round numbers are as follows:

RELIGION	Estimated number of adherents in millions
Christianity.....	480
Confucianism.....	250
Hinduism.....	200
Mohammedanism.....	175
Buddhism.....	150
Taoism.....	40
Shintoisim.....	15
Judaism.....	10
Polytheism.....	- 120
Total.....	1,440

The adherents of Christianity are subdivided as follows:

RELIGION	Estimated number of adherents in millions
Catholicism.....	230
Protestantism.....	145
Greek Church.....	100
Minor divisions.....	5
Total.....	480

LANGUAGE. There are no trustworthy statistics for the population of the earth as a whole or even the civilized countries, indicating the number of persons using the main languages as their ordinary means of communication. There

PORCELAIN - I.



- 1 CHINESE VASE PAINTED IN COBALT
- 2 CHINESE SOUP-PLATE OF EGGSHELL-PORCELAIN 18TH CENTURY
- 3 LARGE CHINESE VASE ON PORCELAIN PIED-ESTAL DATE ABOUT 1600
- 4 CHINESE WINE-JAR OF THICK PORCELAIN
- 5 JAPANESE HIZEN-JAR 18TH CENTURY
- 6 MODERN JAPANESE CUP 19TH CENTURY
- 7 CHINESE ENAMELED PORCELAIN JAR MING-DYNASTY

is no doubt that the number of languages spoken on the earth has rapidly decreased and is rapidly decreasing. There is no doubt that the number of persons speaking the main Aryan languages is rapidly increasing, both by the natural increase of the Caucasian population and by the extended use of these languages, with the extension of the trade and commerce of these countries. But there is no satisfactory statistical measure of this increase.

ILLITERACY. It is common, although not universal, to inquire at a census whether the person is able to read and write. With the extension of education in most civilized countries the proportion of illiterates among the population is declining. At the present time this proportion, in Christian countries, is greatest in the Slavic peoples and among the negroes of the United States. An intermediate position is held by the Romance countries and Hungary, while the highest position is occupied by England, the United States, and the Germanic countries of Europe.

See **VITAL STATISTICS; IMMIGRATION; EMIGRATION.**

POPULIST PARTY, or PEOPLE'S PARTY. A political party in the United States, organized at Cincinnati in May, 1891, by a national convention composed chiefly of representatives of the agricultural and industrial classes. The party grew out of the movements previously inaugurated by the "Grangers" and the "Farmers' Alliance" (q.v.). Its platform of principles demanded the free and unlimited coinage of silver; the abolition of the national banking system; the issue of fiat money in sufficient quantity to transact the business of the country on a cash basis, and the loan of such currency to the people at not more than two per cent. per annum on non-perishable agricultural products; national ownership of all means of public communication and transportation; a graduated income tax; popular election of United States Senators; the adoption of the initiative and referendum in legislation; and the prohibition of alien ownership of land. On July 2, 1892, a National Convention of the Populist Party met at Omaha, Neb., for the purpose of nominating candidates for President and Vice-President of the United States. It adopted a platform embodying the above mentioned views and nominated James B. Weaver of Iowa for President and James G. Field of Virginia for Vice-President. The Populist ticket received 22 electoral votes and a popular vote of 1,055,424. In the next Presidential campaign, that of 1896, the Populist Party nominated for President W. J. Bryan, who had already received the nomination of the Democratic Party, and for Vice-President Thomas E. Watson of Georgia. Most of the Populist Party supported Bryan and the Democratic candidate for Vice-President, W. J. Sewall, but a considerable portion of the party stood for the independence of their movement, and voted for Bryan and Watson. On account of their refusal to depart from the path marked out by themselves, the latter were called the "Middle-of-the-Road" Populists. In order to have the full Populist vote counted for Bryan, an arrangement was made between the two parties in twenty-eight States, by which each was to have a proportionate representation on the electoral ticket. As a

result of this arrangement Bryan received 176 electoral votes, while Sewall received 149 and Watson 17. The Populist platform of 1896 differed but slightly from that of 1892. In the campaign of 1900 the Populist Party again nominated for President W. J. Bryan, who was also the Democratic nominee, but again refused to indorse the Democratic nominee for the Vice-Presidency (Adlai E. Stevenson of Illinois). After a spirited contest, Charles A. Towne of Minnesota received the nomination for Vice-President, but he subsequently withdrew, and the National Executive Committee of the Populist Party substituted Stevenson. In addition to its old principles the party in 1900 denounced the imperialistic policy of the Government, expressed sympathy for the Boers in their struggle with Great Britain, advocated municipal ownership of public utilities, and condemned the practice of the courts in issuing injunctions in labor disputes between employers and employees. Consult: Hopkins, *Political Parties in the United States* (New York, 1900); McKee, *National Conventions and Platforms* (Baltimore, 1900); and Reynolds, *National Platforms and Political History* (Chicago, 1898).

POP'ULONIA. An ancient town of Italy. See **PIOMBINO.**

PROBEAGLE (from Fr. *porc*, hog + Eng. *beagle*), or **MACKEREL SHARK.** Specifically, a ferocious shark (*Lamna cornubica*), bluish gray in color and reaching a length of ten feet, which is found in both the North Atlantic and North Pacific. The term is extended, however, to include

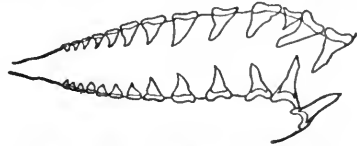

TEETH OF A PORBEAGLE (SIDE VIEW).

the whole of its family (Lamnidae), which contains several pelagic species, often of great size, power, and ferocity, with stout bodies, a wide mouth with separate, triangular, highly specialized teeth (the third in the upper jaw always small), large gill-openings, and great fleshy fins. In addition to the typical porbeagle (a British name), a well-known species (*Isurus oxyrinchus*) haunts the Mediterranean, where it is called 'cane de mare;' and a rarer one (*Isurus DeKayi*) occurs on the North American coast. The largest and most cosmopolitan of the family is the great white 'man-eater' shark (q.v.).

PORCELAIN (OF. *porcelaine*, *porcellaine*, Fr. *porcelaine*, from It. *porcellana*, porcelain, Venus-shell, so called because the highly polished surface suggested that of the Venus-shell, whose curved upper surface resembled a pig's back, from *porcella*, diminutive of *porco*, pig, from Lat. *porcus*, swine, hog, pig; connected with Lith. *parszas*, Ir. *orc*, OHG. *farh*, dialectic Ger. *Farch*, Ger. *Ferkel*, AS. *fearh*, Eng. *farrow*, pig). A peculiar kind of pottery made by the Chinese for many centuries, and in Europe since the discovery of its ingredients about the year 1710. There was indeed a little porcelain made in Florence at the close of the sixteenth century, but it is probable that this was made of materials brought

from China. Its decoration shows the artistic spirit of the time; but so very little of the ware was made that it never influenced the later development of the manufacture in Europe. The next attempt at making the ware in Europe was by experiments, each separate establishment producing a fine white ware made of some mixture of ingredients peculiar to the establishment in question and often kept secret. These wares resulted in the manufacture of what is known as soft porcelain, false porcelain, artificial porcelain, and by similar names. In these the copying of the Chinese ware was avowed and some of the announcements were to the effect that at length the true Oriental secret had been discovered. The ware was, however, more nearly a glass than a true ceramic ware.

The date of the first manufacture of porcelain in China is not fixed. The earliest piece that can be dated dates from the Sung dynasty between 960 and 1368; but all Chinese history and tradition point to a much earlier date even than 960 for the first making of a real porcelain.

Vitreous glazes of the surface and the partial vitrification of the whole mass as described below need not of necessity have characterized the very early wares which are now assumed to have been porcelaneous. The characteristic of Chinese porcelain which has always caused the greatest admiration and the most minute study in Europe, the decoration by means of under-glaze and over-glaze painting, seems not to have been introduced until a time late in the Ming dynasty. Before the fifteenth century decoration was carried out very largely in relief or in intaglio this relief varying from minute patterns raised by modeling upon the surface while soft to boldly projecting figures, masks, flowers, and the like, molded separately and applied, the adhesive paste causing them to keep their positions until fired. The patterns in intaglio are sometimes very elaborate, and use is made of the color of the glaze filling up these recessed lines and scrolls more deeply than it covers the body of the piece, so that these incised or impressed patterns show in a different color from the rest of the surface. These methods of decoration are not limited to the period in question, but have been kept constantly in use. During these earlier years (Sung dynasty and the first reigns of the Ming dynasty) decoration by 'solid color' as it is now called, was greatly respected; the forms of vases and platters were as graceful or as vigorous and significant as at any subsequent time, and vessels of these refined shapes were invested with color, especially a splendid green which has been hard to procure in later wares—the green which is the true and proper tint, afterwards described in France as *céladon*. Other colors existed, especially yellow, which has always been the Imperial color, though opinions differ as to the proper hue; but, as has been stated by the latest and most accurate European writers, the years before 1367 may be said without impropriety to constitute the *céladon* period. Of course these dates and attributions are still open to revision.

The reign of the Emperor Wang-Li, which is generally given as from 1573 to 1619 A. M., is accepted as the period of the earliest pieces painted in brilliant colors and existing in Europe in any considerable number. In these the painting is

of two kinds: in pure blue on the unbaked body before the glaze has been applied, and in enameled colors applied to the finished and fired piece upon the glaze and fixed by a second firing at a relatively low temperature. Such pieces are of extreme softness and delicacy; the blue shows through the glaze in an elaborate scheme of outline, much as the etched line in a *Liber Studiorum* (q.v.) print shows through the mezzotint which was applied afterwards. The more brilliant colors, usually green, yellow, and red, though black is also used in certain pieces, are applied upon and within these outlined spaces and the slight irregularities and imperfections, where the outline is at one moment partly obscured by the enamel color and again left more clearly separated from it, add greatly to the charm of the piece. The fault often found with the richly decorated Chinese porcelain, namely, that the patterns are hard and too strongly relieved from the nearly white ground, is hardly true of these pieces, which are among the most attractive known. This peculiar system has not been abandoned, but even during the eighteenth century it was followed with great success, and it is possible that some of the pieces so painted are of the nineteenth century. Pieces in pure blue and white are, however, the especial production of the Ming epoch. Nearly all the important blue-and-white pieces which bring enormous prices in Europe, and especially in England, where 'blue china' was the particular fad of the years between 1870 and 1890, are assumed to be of the Ming dynasty, although it is quite well understood by more careful students that but few of such early pieces exist in Europe, and that those few are generally so placed and so held that they can never come into the market. Such are not merely the pieces in national collections, but also some in private hands and identified during many years by their having been mounted in European silver or silver-gilt, with feet, covers, tips to spouts, and the like, the plate marks on the silver fixing the date of this work beyond any question.

Nine-tenths of the beautiful wares existing in Europe, brought thence to the United States, are of the Ching or Tsing dynasty, that is to say, the dynasty of the Tatar conquerors of China, beginning with 1644, and still holding the throne. The Tsing pieces are of all sorts: pure white with or without delicate incised patterns, or in grotesque forms of dragon and the like, or in carefully modeled and delicately formed statuettes; white painted with pure blue under the glaze; white covered externally with pure strong color, blood-red (*sang de bœuf*) or maroon, turquoise blue or deep blue, yellow, and other hues; pieces of which the pattern is 'reserved' in white on a ground filled in with dark blue or black, or, pieces of which the pattern is 'reserved' in white pieces adorned with very elaborate painting in many colors, the subject being often flowers, flowering plants, bushes, bamboo thickets, and the like, and as often including human figures treated with great dexterity and a very sufficient knowledge of drawing, but made decorative rather than realistic.

The history of real porcelain in Europe is very brief; for the Florentine ware above named has no connection with the development of the art. That development began in Saxony, at the Meissen factory near Dresden, under the direction of

PORCELAIN - II.

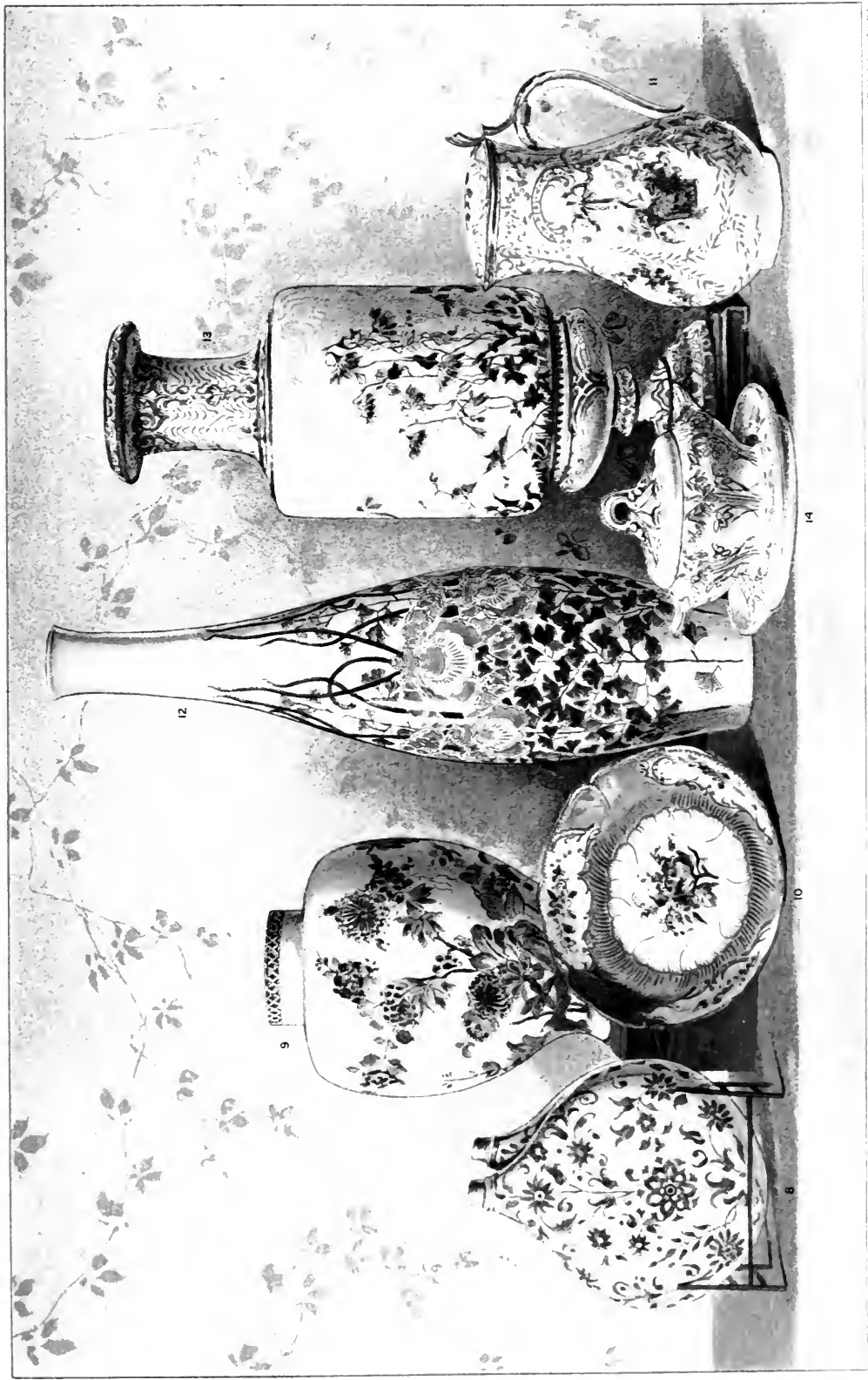

8 DOUBLE BOTTLE OF SOFT FLORENCE PORCELAIN ABOUT 1581
9 PIECE OF VIEUX Saxe-HARD PORCELAIN OF MFLISSEN
10 SEVRES' DISH - MADE BETWEEN 1753 AND 1756
11 SEVRES' VASE RECENT
12 SEVRES' VASE RECENT
13 SEVRES' VASE RECENT
14 SUGAR POT OF HARD PORCELAIN WITH DECORATION OF GRAND T. U. 1900

THE METROPOLITAN MUSEUM OF ART, NEW YORK

Johann Friedrich Böttger. In 1756 the Sèvres factory was established by royal decree as a continuation and development of the earlier factory at Vincennes, and in 1768, the actual porcelain clay having been discovered a few years earlier, the hard porcelain was manufactured at Sèvres. The establishment has maintained its graceful work without intermission, even during the Revolution, and the style of decoration has changed as the different directors have sought for new systems of design. The productions of the manufactories can always be purchased, except when made especially for national gifts to friendly powers or public benefactors, but the prices are high and no promise can be made as to the time of delivery. At present, since 1898, the old systems of design have been largely abandoned and a very elaborate development of independent thought in the decoration is in progress. Among the most remarkable of its movements are the unglazed pieces known commonly as biscuit figures, which are found modeled by the first sculptors of France. These are sometimes sixteen or twenty inches high, and groups or series of them are prepared for the adornment of the table at a stately banquet or for similar uses. There are two different hard porcelains made: one which approaches very nearly in quality and color, and in the degree of heat needed to fire it, to Chinese porcelain; the other a still harder ware fired at a very high temperature and of course limited in its coloration, as few pigments are available. In England, in the eighteenth century, the true porcelain was made in at least two towns, Plymouth and Bristol, and many other manufactories were started in the first half of the nineteenth century. It is since 1850, however, that English porcelain has become an important industrial product. There is no national establishment, and therefore the wares made are all for the market and artistic advance is not steady.

PROCESSES OF MANUFACTURE. Porcelain is made by firing together two natural materials which are known by Chinese names, kaolin and petuntze, although the deposits found in Europe are not commonly of exactly the same chemical nature as the Chinese. The latest careful writer on the subject, William Burton, says expressly that the kaolin has been produced by the gradual decomposition of the petuntze; and it is admitted that the two natural substances, the harder and more rock-like petuntze and the clay-like kaolin, are of the same general composition. The body is generally made of the kaolin just as any piece of pottery is modeled in common clay, and the fusible petuntze forms the glaze, but with this peculiarity in the process, that body and glaze are fired together. This is exceptional in the ceramic art, because in most varieties of pottery the glaze is applied separately and fired separately and at a much lower temperature. The temperature needed for the firing of true porcelain is about 1400° Centigrade, or more than 3000° Fahrenheit. The few pigments that will bear this great heat are applied on the body and under the glaze. Paintings in vivid colors are nearly always of the nature of enamel applied upon the glaze and showing plainly as in slight relief, or else as having a surface altogether different from that of the glaze, and usually much less brilliant.

BIBLIOGRAPHY. Treatises on porcelain are

usually to be found in the books devoted to ceramic ware in general. (See the bibliography of POTTERY.) A few have been devoted to this special ware, and the most celebrated of these is the work of Jacquemart and Le Blant, *Histoire artistique, industrielle et commerciale de la porcelaine* (Paris, 1862). This work has been in part superseded by more recent treatises, but is famed for the admirable illustrations from etched plates by Jules Jacquemart. Chinese porcelain has been treated in two French books, *La céramique chinoise*, by Grandidier (Paris, 1894), and *La porcelaine de Chine*, by O. Du Sartel (ib., 1881); these works are large quartos with many plates. The work devoted to the Walther collection in Baltimore, whose chief author is Doctor Steven W. Bushell, contains a more profound study of the subject than any other work, and its illustrations are admirable chromolithographs. The same distinguished expert has aided in the publication of *A History and Description of Chinese Porcelain*, by Cosmo Monkhouse (New York, n.d., about 1901). The publications connected with the Sèvres manufactory are important, especially *La manufacture nationale de Sèvres, exposition universelle de 1900*, having a carefully prepared text, and a number of excellent plates illustrating the most recent productions. *A History and Description of English Porcelain*, by William Burton (New York, n.d., preface dated 1902), is a really critical treatise, as is also the popular treatise by Lehnert, *Das Porzellan* (Bielefeld, 1902).

PORCELAIN TOWER. An octagonal structure in Nanking, China, erected in the early part of the fifteenth century. It had nine stories, faced with variegated porcelain, from which bells and lamps were hung. The tower was destroyed by the Taipings in 1853. Many miniature reproductions are in existence, among them those in the Green Vault in Dresden.

PORCELANITE, or PORCELAIN-JASPER. A metamorphic rock of the granite group which is formed by the baking of argillaceous beds. It has the fracture of flint, and is gray to red in color, somewhat resembling jasper, from which it differs, however, in being more fusible.

PORCH (OF., Fr. *porche*, from Lat. *porticus*, porch, gallery, from *porta*, gate). An open lobby, vestibule, or room, affording entrance to a building, and usually built as an accessory to the main mass and projecting from it. The porch of a church may be a gabled building, small and low in comparison with the church proper, with a single door of entrance and a single passage-like interior with permanent seats along the sides; or it may be a mere roof, vaulted or of wooden frame-work, resting upon a pair of columns, as often in the churches of Lombardy; or it may be as long as the whole church is wide, as in the narthex of Eastern churches, or the great vestibule of Saint Peter's at Rome. Such great porches as these will naturally be more or less closely united to the main structure, as they are high and as it is common to build a series of rooms or a gallery above them; they are, therefore, more properly vestibules than porches, though the latter term is more generally applied to them.

The projecting porches of Gothic churches add much to their variety of outline and often receive

the richest ornamentation. (See PORTAL.) Thus the cathedral porches of the thirteenth century, especially in France, are made to shelter great numbers of statues of life-size, and larger, and a still greater crowd of small figures under niches; and in addition to this, much floral sculpture. In England there still remain many wooden porches of the fourteenth and fifteenth centuries, and one or two exist on the Continent. Finally, it must be mentioned that the lower story of a tower is often made to serve as a porch, having, perhaps, three doorways in its three free sides, and in the fourth side a doorway into the church. The most elaborate porch of this character is connected with the Church of Saint-Benoit-sur-Loire (Loiret), France.

In domestic buildings, especially in lands where there is much hot sun, it is common to have verandas, and these are porches if the access to the doorways of entrance is by means of them.

The propylea of a Greek palace or temple inclosure is to be considered a porch, although the person entering does not reach the main building immediately. See PROPYLEA.

PORCIA GENS (Lat., Porcian family). A plebeian gens of Rome, appearing first in the third century B.C. Its most famous family bore the name of Cato.

PORCUPINE (OF. *porc espin*, It. *porco spino*, from ML. *porcus spinosus*, porcupine, spine-hog, from Lat. *porcus*, swine, hog, pig, and *spina*, spine, thorn). A large forest-dwelling rodent of the family Hystricidae, characterized prominently by an armature of horny spines ('porcupine quills') intermixed with coarse hairs. The family includes two well defined sub-families, the Old World porcupines, Hystricinae, which are terrestrial and fossorial, and the New World porcupines, Sphingurinae, which are boreal and not



LOWER TEETH OF A PORCUPINE.

Showing the method of growth of the great incisor, reaching back beyond the roots of the molars; the hinder end is cut away to expose the pulp and pulp cavity.

fossorial. Other differences also occur in the skeletons. Of the Hystricinae, the best known species is the common porcupine (*Hystrix cristata*) of the Mediterranean region. It is one of the largest of rodents, being from two to three feet in length, besides the tail, which is about six inches long. The occiput and neck are furnished with a crest of long, erectile bristles. The muzzle and limbs are covered with very short hair; the back and sides with spines, which on the middle of the back are almost of the thickness of a goose-quill, and more than a foot long. The spines are supported by a slender pedicle, terminate in a sharp point, and are ringed with black and white, which gives a general gray color to the animal. Their ordinary position is flat, with the points directed backward; but when the animal is excited they are erected, giving the beast the bristling appearance shown in the ac-

companying plate. It can roll itself up like a hedgehog, with spines pointing in every direction. The spines or quills at the tip of the tail are of very singular structure, being open thin-sided tubes, about two inches long, supported upon slender flexible pedicles, and they make a sound by rattling together when the tail is shaken. The animal is solitary and nocturnal, burrows in the ground, and in winter becomes torpid. It feeds on roots, bark, fruits, and other vegetable substances, sometimes committing depredations in gardens. The spines or quills of this, as well as of other porcupines, are used for various purposes, and have a certain commercial value. A larger species of porcupine (*Hystrix leucurus*), with the quills of the tail quite white, is found in India, and other species inhabit different parts of Asia and Africa. The Malayan and West African brush-tailed porcupines of the genus *Atherura* differ from the true porcupines in having the quills flattened like blades of grass, and those of the tail gathered into a tuft at the end of it.

Of the other sub-family, the Sphingurinae, the best known species is the North American porcupine (*Erethizon dorsatus*) of the forested parts of Canada and the Northeastern United States. It is about 2½ feet long, the tail adding about six inches more. The spines are only two or three inches long, yellowish-white, mingled with black hair, giving the animal a black and white color. The spines are largest along the sides of the broad, flat tail. The Canada porcupine is often seen on the ground, where it makes a home among the rocks, or in a hollow stump, but spends most of its time in trees, especially evergreens. It is harmless and inoffensive, but is able to resist attack well, not only by its armature of quills, but by powerful strokes of its tail, and feeds on bark, buds, leaves, fruit, etc. The flesh of the young ones is very good. A closely allied species, the yellow porcupine, is found in the West. The other species of this sub-family are small strictly arboreal species, with more or less prehensile tail, found in Mexico and South America. They are called 'tree porcupines' and belong to the genera *Sphingurus*, which has short spines, and *Chaetomys*, in which the body is clad with stout, wavy bristles. Consult general natural histories; especially, for the Canada porcupine, Stone and Cram, *American Animals* (New York, 1902); Merriam, *Mammals of the Adirondacks* (ib., 1893); Ingersoll, *Wild Neighbors* (ib., 1898).

PORCUPINE-FISH. One of a family, Diodontidae, of the order Plectognathi, allied to the globe-fishes, Tetraodontidae, from which they differ chiefly in the stronger armature of the skin, and in having no division in the bony plate of either jaw. They are short and broad in form, and are covered everywhere with spines, each rooted upon a bony base, and in some species with strong, hair-like bristles. Each jaw is covered with a bony plate, like a beak of a bird, and the nostrils form small tentacles. They are sluggish fishes, inhabiting warm seas of various parts of the world and living on the bottom among weeds and corals. When disturbed they swallow air, and float belly upward on the water, but their capacity of inflation is much less than that of the globe-fishes. They are generally regarded as poisonous, and therefore rarely used as food, but they are often utilized as curiosities. The best known species is *Diodon hystrix*, common every-

PORCUPINES AND HEDGEHOGS



1



2



3



4



5



6

1. NORTH AMERICAN PORCUPINE (*Erethizon dorsatus*).
2. BRAZILIAN TREE PORCUPINE (*Chaetomys subspinosus*).
3. EUROPEAN PORCUPINE (*Hystrix cristata*).

4. AFRICAN BRUSH-TAILED PORCUPINE (*Atherura Africana*).
5. EUROPEAN HEDGEHOG (*Erinaceus europaeus*).
6. TENDRAC OF MADAGASCAR (*Ericulus spinosus*).

where in the tropics, and often taken in Florida, where its Spanish name is 'erizo.' (See Plate of PLECTOGNATH FISHES.) It reaches a length of about three feet. Another smaller and darker species of these fish is *Diodon holacanthus*, also well known. An allied species, *Chylomyeterus Schoepfi*, only six to ten inches long, and very abundant in the bays and lagoons from Virginia to Florida, swells up when touched after the manner of the Northern puffers. It is greenish in color, with the abdomen paler, the back and sides marked by round black spots and parallel black stripes. Its common names are 'burr-fish,' 'rabbit-fish,' and 'swelled toad.' Several other species of the same genus exist in the tropics.

PORCUPINE WOOD. The wood of a palm. See COCOANUT.

POR/DAGE, JOHN (1607-81). An English mystic. He was born in London, and was a minister in the Church of England from 1644 to his death. During the Commonwealth his advocacy of the views of Jacob Boehme led to his suspension (1655), but he was reinstated at the Restoration. In 1663 he joined Jane Lead (q.v.), and with her established the short-lived Philadelphia Society, which was intended to unite the followers of Boehme and win the world for peace. A number of his works were published posthumously, and several were translated into German or Latin.

PORDENONE, pór'dá-nó'ná. A town in the Province of Udine, Italy, on the Noncello, 29 miles southwest of Udine (Map: Italy, G 2). Ruins of its old walls and of an ancient castle still remain. There are manufactures of cotton, linen, and silk fabrics, paper, and earthenware, and a trade in wine and grain. The site is supposed to be that of the *Portus Naonis* of the Romans. Population (commune), in 1901, 12,482.

PORDENONE, GIOVANNI ANTONIO DA (1483-1539). A Venetian painter of the High Renaissance. He is sometimes wrongly called Licinio. His family name was Sacchi, and he usually called himself Pordenone, after his native town in Friuli. He studied at Udine, and was engaged in painting in the churches of Friuli as early as 1504. Although he lived mostly in Pordenone, he received many commissions in other cities, and at Venice he learned to imitate Giorgione, the leading influence which governed his style after 1513. In 1520 he assisted in the decorations of the cathedral at Cremona, and in 1528 was employed by the Council at Venice to paint a large picture for the great hall—a commission at first assigned to Titian, who had long delayed the work. He settled definitely at Venice in 1535, having been previously knighted by the King of Hungary, and assumed the name of Regillo. At the invitation of the Duke, Pordenone, in 1538, went to Ferrara, where he died suddenly in January, 1539. His most important work are frescoes, although he executed many altar-pieces. Most of his paintings have suffered much from age and restoration, but the altar-piece in Sant' Elemosinario, Venice, still retains some of its richness and beautiful coloring. The chief work of his youth is the frescoes in the Church of San Salvatore in Castel Cotalto, and the finest are those in the Malchiotro Chapel of the cathedral at Treviso, dated 1520. His best oil paintings are the "Glory of Saint Lorenze Giustiniani," and a "Madonna," in the

Venice Academy. Although not ranking with the greatest Venetian masters, Pordenone was the only decorative painter of the school, and the most dramatic of its masters.

PORE. See SKIN.

POREL, pór'rél', MADAME. A French actress. See RÉJANE, MADAME.

PORFIRIO DIAZ, pór-fér'é-ó dé'ás, CIUDAD. A town of Mexico. See CIUDAD PORFIRIO DIAZ.

PORGY or **PORGE** (corrupted from American Indian *mischcuppaug*, or from Lat. *pagrus*, *pager*, from Gk. *πάγρος*, *pagros*, sea-bream). Any of several fishes of the family Sparidæ. They are carnivorous shore-fishes of the tropical seas, abundant in American and European waters, and excellent food fishes. The common American porgy (*Stenotomus chrysops*) is more commonly known as 'seup' (q.v.) along the Atlantic coast of the United States, and several allied species occur about Florida and the West Indies, and are marketed locally. The European 'red-porgy' (*Pagrus pagrus*), known in the Mediterranean as 'besugo' and 'pargo colorado,' attains a length of about two feet, and is common on the European coasts, and also in the Gulf of Mexico and southward, where it is highly valued. On the Pacific

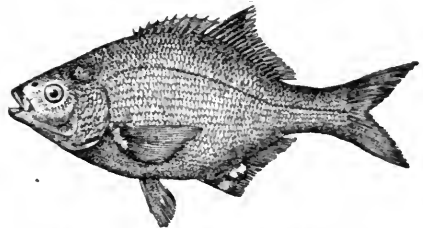

CALIFORNIAN PORGY (*Damalichthys argyrosomus*).

Coast the name is given to one of the Californian surf-fishes (q.v.), otherwise known as 'white perch' (*Damalichthys argyrosomus*). Consult Kingsley, *Standard Natural History*, vol. iii. (Boston, 1885).

PORIFERA (Neo-Lat. nom. pl., from Lat. *porus*. Gk. *πόρος*, pore, passage + Lat. *ferre*, to bear). The second or next to the lowest phylum of animals—the sponges; also its single constituent class. See SPONGE.

PORISM (from *πόρισμα*, *porisma*, corollary, from *πορίζειν*, *poriscin*, to bring about, deduce, from *πόρος*, *poros*, passage; connected with Lat. *peritus*, skilled, OChurch Slav. *periti*, to fly, Skt. *par*, to cross over, Goth., OHG., AS. *faran*, Ger. *fahren*, Eng. *farce*). A kind of geometric proposition common in Greek mathematics. The word seems to have been loosely employed, Proclus (q.v.) telling us that it is used in geometry to designate either a corollary or a proposition which partakes of the nature of both a theorem and a problem. The most ancient tradition divides propositions into *theorems*, *problems*, and *porisms*, according as it is required to demonstrate, to do, or to find. Thus, "To construct an equilateral triangle on a given line" is a problem; "To find the centre of a given circle" is a porism. The term porism was also used by Diofantus with reference to certain propositions in arithmetic. Consult: Chasles, *Les trois livres de porismes d'Euclide* (Paris, 1860); Chasles,

Aperçu historique (3d ed., Paris, 1889); Gow, *History of Greek Mathematics* (Cambridge, 1884).

PORK (OF., Fr. *porc*, from Lat. *porcus*, swine, hog, pig). The flesh of swine. This meat is widely used and extensively exported for food and is valued for its heat-giving qualities and for the ease with which it may be preserved by salting, drying, or smoking. The pork-packing industry has grown to enormous proportions in the United States. In 1900, the bacon exported was valued at \$39,000,000; the hams, \$20,000,000; lard, \$42,000,000; and the total hog products, over \$112,000,000. The flavor of pork is affected more or less by the feed given to the pig, as is also the character of the fat. Fat with a low melting point is characteristic of 'soft' pork, while a higher melting point is found in that of better quality. Acorns are believed to cause the peculiar and delicate flavor noticed in the flesh of pigs which are allowed to run where they have access to them. The over-fat carcass is now quite generally recognized as undesirable, and smaller pigs with fat and lean well distributed are more satisfactory. Pork contains on an average more fat than other meats, but does not differ from them markedly in other respects as regards composition. It is often said that pork is unwholesome, but this seems to be wholly a matter of opinion, as so far as scientific food experiments go there is nothing to show that good pork is less desirable for men in health than other meats. It is very likely that much of the prejudice against pork comes from the fact that it is one of the foods avoided by the Jews and Mohammedans on account of their respective religious beliefs. See PACKING INDUSTRY; MEAT; FOOD.

POROMUSHIR, pō'rō-mōō-shēr'. One of the Kurile group of islands. See KURILE ISLANDS.

POROSITY (from Lat. *porosus*, full of pores, from *porus*, pore, passage). A term expressing the experimental fact that no kind of matter completely fills the space it occupies; in other words, that all bodies are full of minute cavities or interstices, such as are illustrated on a large scale by a sponge.

PORPHYRIO, POMPONIUS. A Latin grammarian, presumably of the third century A.D. His commentary on Horace is the most valuable which has come down to us, though sometimes fanciful and frequently marred by interpolations of mediæval clerks. It is edited by Meyer (1874) and by Holder (1894).

PORPHYRION (Lat., from Gk. Πορφυριων). In Greek mythology, a giant destroyed in the combat with the gods because at the sight of Juno's beauty he forgot to defend himself.

PORPHYRITIC TEXTURE. See IGNEOUS ROCKS.

PORPHYRIUS (Lat., from Gk. Πορφύριος), (233-c.304 A.D.). One of the most important of the Neo-Platonists and the chief disciple of Plotinus. He was born at Batanea, in Syria, where he received his early education. His original name was Malchus, but this was changed, according to tradition, to Porphyrius ('wearer of the purple') by Longinus, whose disciple he was at Athens from 252 to 262. In the latter year he went to Rome and soon attached himself to Plotinus. After some years he moved to Sicily, but returned to Rome under Aurelian and con-

tinued his teaching into the reign of Diocletian. Porphyrius was not a deep thinker. He devoted himself to grammar and history as well as philosophy, but his great service was as an expositor and definer of Plotinus's obscure doctrines, which Eunapius declares he made clear to the common understanding. He was a very prolific writer. Suidas has preserved to us an incomplete list of his writings, some of which deal with speculative philosophy, but the larger number were devoted to the history of philosophy and its exposition. The most important of these are his *Life of Pythagoras*, his work *On Abstinence from Animal Food*, an *Introduction and Commentary to Aristotle's Categories*, and a work addressed to his wife, Marcella. Of his lost works the most important was one directed against the Christians, which was publicly burned at the order of Theodosius II. That he was originally a Christian, as is stated by Socrates, the Church historian, and by Saint Augustine, there is not the slightest proof. A complete edition of his works and fragments has never yet been published. The most important editions of single works are the following: *Porphyrii Opuscula Selecta*, by Nauck (2d ed., Leipzig, 1886); *The Life of Pythagoras*, together with Iamblichus's similar work, by Kiessling (Leipzig, 1816); his *Commentaries to Aristotle's Categories* is now published in the great Berlin edition of the *Commentaries to Aristotle*, vol. iv., ed. by Busse (Berlin, 1887); *Porphyrii de Philosophia ex Oraculis Haurienda Librorum Reliquia*, ed. Gustav Wolff (Berlin, 1856); *Quæstiones Homericæ*, ed. Schraeder (Leipzig, 1880-82). Translation of *Select Works*, by Taylor (London, 1823); *Sentences*, by Davidson (ib., 1869). Consult: Zeller, *Philosophie der Griechen* (3d ed., Leipzig, 1881); and for Porphyrius's relation to Christianity, Kleffner, *Porphyrius der Neuplatoniker und Christenfeind* (Paderborn, 1896).

PORPHYRY (OF., Fr. *porphyre*, from Gk. πορφύρος, *porphyros*, purple, from πορφύρα, *porphyra*, purple fish). A term formerly much employed to designate in a general way any rock of porphyritic texture (see IGNEOUS ROCKS), and in a special sense, such rocks when of siliceous composition and having the larger crystals (porphyritic crystals) chiefly of orthoclase feldspar or orthoclase feldspar and quartz. Thus quartz porphyry included the finer grained granites occurring as bosses or dikes.

PORPOISE (OF. *porpeis*, *porpois*, *pourpois*, dialectic Fr. *porpeis*, from Lat. *porcus*, swine, hog, pig + *piscis*, fish; cf., with reversed order of components, Port. *peixe porco*, Oit. *peixe porco*, porpoise). A small active cetacean, of the family Delphinidæ, having a form similar to the dolphins, but the muzzle short, uniformly convex, and without a beak; a dorsal fin; the teeth numerous, simple, and equal. The common porpoise (*Phocæna communis*) is plentiful in all northern seas and is only 6 to 8 feet in length. The body is spindle-shaped, the skin perfectly smooth and destitute of hair, and there are from 40 to 50 teeth in each jaw. The eye is rather small, with the pupil in the form of a V, and the opening of the ear is very minute. The crescent-shaped blow-hole is situated between the eyes. Large numbers are often seen together, sometimes gamboling, sometimes swimming in file, when their backs, appearing above the surface of the

water, are apt to suggest the idea of a great sea-serpent. They feed on fish, and pursue the herring, mackerel, etc., into bays and estuaries. The porpoise sometimes ascends rivers, apparently in pursuit of salmon, as far as the water is brackish, and is not infrequently caught on such occasions, for the sake of its skin, oil, and flesh. The skin is nearly an inch thick, but is planed down until it becomes translucent, and is made into excellent leather, which is used for shoe-

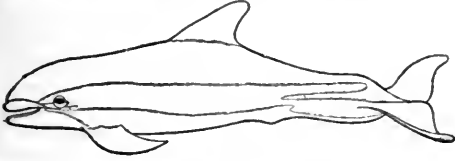

SKUNK, OR BAY PORPOISE.

strings and for other purposes. Under the skin is a layer of fat, about an inch in depth, which yields oil of the finest quality. The flesh was in former times highly esteemed, but it is now little eaten by civilized people. Several other species of *Phocæna* occur in the South Atlantic, Indian, and Pacific Oceans, while the name 'porpoise' is carelessly extended to almost any of the smaller dolphins. Consult: Beddard, *A Book of Whales* (London, 1900); Goode, *Fishery Industries*, see i. (Washington, 1884); True, *Bulletin of the United States National Museum*, No. 36 (ib., 1889).

POR/PORA, NICCOLÒ ANTONIO (1686-1766). A famous Italian composer, born at Naples. He studied music under Padre Gaetano, of Perugia, and possibly under Scarlatti. He produced his first opera, *Basilio, re di Oriente*, in 1709. *Berenice* followed in 1710. He began the work for which he subsequently became famous in 1712, when he founded the music-school in Naples, which numbered among its pupils Farinelli, Tosi, Senesino, and Caffarelli. He held many important appointments in Austria, Prussia, and Italy; and in 1728 became singing-master to the royal family at Dresden, in which city he also became concert-master of the opera. The following year he was invited to go to London, where a considerable opposition had been organized against Handel (q.v.). Although some of his best work was written and produced in London, he could not succeed against his rival, and returned in 1736 to Venice, where he was appointed director of the Conservatory. After a period of about nine years he went to Vienna in the train of the Venetian ambassador, and during the three years of his stay was held in high repute as a teacher. Haydn studying under him part of the time. He went to Dresden in 1748, where he became Court kapellmeister until 1751, when he returned to Naples.

PORRIGO. See FAVUS; RINGWORM.

PORSE'NA, or **PORSE'NNA**, LARS. In the early and uncertain history of Rome, a powerful King of Clusium (now Chiusi), in Etruria. According to the legend told by Livy, when Tarquin the Proud was expelled from Rome he sought the help of his Etruscan kinsmen in Veii and Tarquinii, against his revolted subjects; but their efforts not proving successful, he turned to Porsena, who willingly espoused his cause, and marched a great army against Rome. The Etrus-

can King seized the Janiculum, a fortified hill on the west side of the Tiber, and would have forced his way into the city across the "Bridge of Wooden Piles" (*pons sublicius*), had not a brave Roman, Horatius Cocles, kept the whole of Porsena's army at bay, while his comrades behind him hewed down the bridge; after which he plunged into the Tiber, and safely swam across its waves. Porsena, we are informed, now laid siege to Rome, and after a while the inhabitants began to suffer so severely from famine that they had recourse to a desperate expedient. Three hundred of the noblest Roman youths swore to risk their lives in an attempt to assassinate the Etruscan King. The first on whom the lot fell was C. Mucius, who stole into the camp of Porsena, but, not knowing the person of the King, killed his secretary instead. He was instantly seized, and put to the torture; but the unshrinking audacity with which he thrust his hand into the fire and let it burn moved the King so much that he pardoned him, whereupon Mucius (ever afterwards called *Scævola*, 'the left-handed') told him of the jeopardy in which he was placed.

Porsena resolved to make peace with Rome at once, and, his conditions being accepted by the sorely pressed citizens, he withdrew his forces. This version of the story is believed to have been invented to conceal the fact of a temporary Etruscan conquest, and the evidence in favor of this view is overwhelming. Tacitus expressly affirms that Porsena conquered the city; Dionysius informs us that the senate sent him an ivory sceptre, a golden crown, and a triumphal robe, which was the form that had been adopted by the Etruscan cities themselves of acknowledging the supremacy of the Roman King, Tarquinius Priscus; and Pliny mentions that Porsena forbade the citizens of Rome to use iron, except for agricultural purposes. What seems most reasonable to believe is that a great rising of the Etruscan against the Latin races took place, and that Rome was exposed to the first brunt of the war, and suffered a disastrous defeat, but that shortly after the Etruscans themselves were decisively beaten, and forced back into their own territories; for after the conquest of Rome Aruns, a son of Porsena, proceeded against Aricia, under the walls of which city (according to Livy) his army was routed by the combined forces of the Latin cities, with the help of Greek auxiliaries from Cumæ.

POR'SON, RICHARD (1759-1808). A brilliant Greek scholar, born December 25, 1759, at East Ruston, Norfolk, England, where his father, a worsted weaver, was parish clerk. The curate of the parish, Mr. Hewett, impressed by the boy's rare abilities, had him educated along with his own sons. Porson afterwards found a patron in Mr. Norris, the founder of the Norrisian professorship at Cambridge, who sent him to Eton in 1774, where he remained about four years, without, however, distinguishing himself remarkably. Another patron, Sir George Baker, sent him, in 1778, to Trinity College, Cambridge, of which he was elected a scholar in 1780. In 1781 he won the Craven scholarship and the first chancellor's medal. In 1782 he was chosen a fellow of Trinity. He now began to give indications of his subtlety and taste in the difficult verbal criticism of the Greek dramatists. For four years he contributed to *Maty's Review*—his first critique

being on Schutz's Æschylus, and his finest on Brunck's Aristophanes. He also opened a correspondence with Professor Ruhnken. In 1787 he contributed to the *Gentleman's Magazine* three sarcastic letters on Hawkins's *Life of Johnson*. For the same periodical he also wrote his far more famous and trenchant *Letters to Travis on the Three Witnesses* (1788-89). The question concerned the disputed text I. John v. 7, and was occasioned by a pretentious defense of the passage by Archdeacon Travis against the scornful attack of Gibbon. Porson naturally incurred great odium on account of the side he took in this controversy. One old lady who had him in her will for a legacy of £300 cut it down to £30 when she heard that he had written a book against Christianity. Porson's fellowship being vacated by his refusal to take orders, his friends now procured for him an annuity of £100. He was also appointed to the regius professorship of Greek in the University of Cambridge, an office worth £40 a year. The only thing he ever did in connection with his Greek professorship was to deliver a Latin prelection on Euripides, written, it is said, in two days. In 1795 he edited the plays of Æschylus for the Foulis Press at Glasgow; and between 1797 and 1801 four of Euripides, the *Hecuba*, the *Orestes*, the *Phænissæ*, and the *Medea*. He also collated the Harleian manuscript of the *Odyssey* for the 'Grenville' Homer. In 1806 he was appointed librarian of the London Institution with a salary of £200, but neglected his duties. By this time Porson had weakened in mind and body. Ever since the loss of his fellowship he had lived mostly in London, occupying rooms at Essex Court in the Temple. There he would confine himself to work for days; and for years he had been at times a hard drinker. He died of apoplexy, September 25, 1808, and was buried in the chapel of Trinity College, Cambridge.

Porson was famed for his wit and learning, and, unfortunately, for the negligence with which he treated persons to whom he owed courtesy. His burlesque of Hawkins has been compared with Thackeray at his best. He certainly was a master of irony. His contributions to the knowledge of Greek syntax and metres are solid and permanent. To the emendation of texts he brought rare keenness and a marvelous memory. Though more scientific methods now prevail, especially in textual collation, it is generally agreed that Porson opened the way to the new era. After his death, several works left in manuscript were published: *Ricardi Porsoni Adversaria* (1812), *Tracts and Miscellaneous Criticisms* (1815), *Pausanias* (1820), *Lexicon of Photius* (1822), *Notes on Suidas* (1834), and *Correspondence*, edited by Luard (Cambridge, 1867). Consult the *Life* by Watson (London, 1861); *Table Talk of Samuel Rogers* (ib. 1856); and Luard, *Cambridge Essays* (ib., 1857).

PORT (of uncertain etymology). (1) A naval term to denote the left side of a vessel to an observer looking forward. See HELM. (2) In architecture the term port is used as an equivalent of portal (q.v.).

PORTA, CARLO (1776-1821). An Italian poet, born in Milan. He was employed in the Bureau of Finance in Venice, and afterwards in Milan. Manzoni, Grossi, and others of the Romantic School in Milan were his intimate friends.

His poems are mostly in the Milanese dialect. They are remarkable for their satirical wit and vivacity, and are exact descriptions of local manners. The best known of them is *Le disgrazi di Giovanni Bongee*. His works were published by his friend Grossi in 1821.

PORTA, GIACOMO DELLA (1542-1604). An Italian architect, born at Milan. He was the pupil of Vignola and Michelangelo, and completed various works left unfinished by both his masters. The most important of these was the cupola of Saint Peter's in Rome, which he slightly altered from the original designs, and was working over in 1564. Other building work of his in Rome includes the completion of the Church of II Gesù, begun by Vignola; the Farnese Palace, begun by Michelangelo; the Greek Church, in the Via Babuino; the Church of the Madonna dei Monti; the facade of the Church of San Luigi de' Francesi; and the palaces Paluzzi, Chigi, Serlupi, and d'Este. He also built in Rome some fine fountains, in which his taste for the decorative in architecture showed itself. Of these, an especially noted one is the Fontana delle Tartarughe. Other works by Porta are the Chapel of Saint John the Baptist in the cathedral at Genoa, and the Villa Aldobrandini, near Frascati.

PORTA, GIAMBATTISTA DELLA (1543-1615). An Italian savant, born at Naples. He traveled widely in Spain, France, and Italy, and founded an association known as *I segreti*, for the purpose of carrying on scientific investigations. Accused of practicing magic, the society was dissolved by the Pope. Porta studied optics successfully and invented the camera obscura. He wrote widely on scientific topics with much learning and much blundering. His most important works are *De Humana Physiognomia* (1586), *Magis Naturalis* (1589), *Ars Reminiscendi* (1602), *De Aëris Transmutationibus* (1609).

PORT ADELAIDE, äd'e-läd. The port of the city of Adelaide (q.v.), South Australia.

PORTADOWN. A town of Ireland in County Armagh, situated on the Great Northern Railroad 5 miles south of Lough Neagh (Map: Ireland, E 2). It has manufactures of linen and cotton goods and trade in agricultural products. Population, in 1901, 10,046.

PORTAELS, pör-täls', JEAN FRANÇOIS (1818-95). A Belgian historical and portrait painter, born at Vilvorde, near Brussels. He studied in the Academy of Brussels, and in Paris under Paul Delaroche, and in 1842 he took the Prix de Rome. After extensive travels in the Orient, in 1847 he was appointed director of the Academy of Ghent. Later, after further travels, he became director of the Academy of Brussels. Among his best known works are "A Funeral in the Desert of Suez," and "A Caravan in Syria Overtaken by a Simoom." At an exhibition of paintings in Sydenham Palace in 1873, he received a special gold medal for the finest picture, "A Drought in Egypt." His works are rather good in composition, but are painted in the smooth manner of the school of Delaroche.

PORTAGE. A city and the county-seat of Columbia County, Wis., 90 miles west by north of Milwaukee; on the Government ship canal between the Fox and Wisconsin rivers, and on the Wisconsin Central and the Chicago, Milwaukee and Saint Paul railroads (Map: Wisconsin, D 5).

It has a public library, and among the prominent buildings are the high school and the city hall. Portage is the commercial centre of a productive farming section, and manufactures hosiery and knit goods, brick, flour, etc. The government is administered, under a charter of 1900, by a mayor elected biennially and a unicameral council. There are municipal water-works. Portage was settled in 1835 and was chartered as a city in 1854, having been first incorporated two years earlier. Near the city limits are the remains of old Fort Winnebago, which was built in 1828. Population, in 1890, 5143; in 1900, 5459.

PORTAL (OF. *portal*, Fr. *portail*, from ML. *portale*, entrance, vestibule, neu. sg. of *portalis*, relating to a gate, from Lat. *porta*, gate). A doorway or gateway; and, by extension, an architectural structure having for its chief object the inclosing and containing of such doorway, or several doorways. The French term, *portail*, of similar meaning, is often applied to the whole west front of a church, or to the northern or southern transept-front, or to the lower part of such a front in which the doorways are opened. This usage has influenced English writers to a certain extent, and the group of doorways at one front or flank of a building, with the architectural accessories, such as gables, canopies, columns, and the like, is often a portal. The *porte cochère* of a large French building, that is, the great doorway through which a carriage or wagon can be driven, is properly called a portal.

The portal and the porch (q.v.) are not to be separated absolutely. Thus where, as in the Palazzo Canossa at Verona, there is a triple archway of entrance, the three arches taken together may be considered a portal of three openings; or the square hall into which they lead, taken with the arches, may be considered a porch, in which case the arches in the outer wall form a part of it.

PORTALEGRE, pŏr'tá-lá'grá. The capital of the district of the same name in Portugal, situated near the Spanish frontier, 95 miles northeast of Lisbon. It is a fortified town, and has a handsome cathedral. It manufactures woolen goods, and cork is obtained in the vicinity. Population, in 1900, 11,893.

PORTALIS, pŏr'tá'lès', JEAN ETIENNE MARIE (1746-1807). A French jurist and statesman, born at Le Beausset, near Toulon. He studied law at the University of Aix and in 1765 was admitted to practice before the provincial Parliament. Charged with a commission to investigate the legal status of the Protestants in France, he published in 1771 *Consultation sur la validité des mariages des protestants en France*, in which he established the character of marriage as a civil contract, the general tone of the work being wholly favorable to religious toleration. From 1778 to 1782 he was provincial assessor of Provence, returning subsequently to the practice of law. Always moderate in his views, Portalis retired to his estate when the Revolution entered upon its stormy phase. He was compelled to flee to Lyons and thence to Paris, where in December, 1793, he was arrested. He was liberated on the fall of Robespierre and in 1795 was elected to the Council of Ancients, of which in June of the following year he became president. His clemency to the adherents of the old régime aroused the hostility of the Directors, and after the coup

d'état of the 18th Fructidor (September 4, 1797) he escaped deportation by seeking refuge abroad. Returning in 1800, he was made by Napoleon a member of the commission charged with the preparation of a civil code. He took a most important part in the labors of the commission, for which he was peculiarly fitted by his extensive knowledge of the civil law. After the conclusion of the Concordat (1801) Portalis was intrusted with the task of formulating a body of supplementary rules to serve as a basis for the administrative policy of the State with regard to the Catholic religion. Made Minister of Public Worship in 1804, he effected important changes in the organization of religious instruction. In 1806 he became a member of the Academy. He died in Paris August 25, 1807. Consult: Lavolée, *Portalis, sa vie et ses œuvres* (Paris, 1869); Sainte-Beuve, *Causeries du lundi*, vol. v. (Paris, 1852).

PORTAL VEIN. See LIVER; CIRCULATION.

PORTA MAGGIORE, pŏr'tá mád-jŏ'rá. The ancient Porta Prænestina at Rome, a gate with two arches, one of which is now closed, through which issued the Via Prænestina and the Via Labicana. It was the meeting-place of the water systems of the ancient city, and was originally designed to carry the Aqua Claudia and the Anio Vetus over the two roads. Its inscriptions record its construction and restorations. It was included as a gate in the walls of Aurelian. During the restoration of the walls by Arcadius and Honorius the level of its threshold was raised ten feet by the leveling of the accumulated rubbish.

PORTAMEN'TO (It., carriage). A musical term used to denote the sustaining of the voice in passing from one note to another. In legato the voice passes directly from one tone to the next, while in portamento it passes through all intermediate tones. But this passing is so rapid that no single tone is heard separately. The effect of portamento can best be attained upon a stringed instrument played with a bow. The finger quickly glides along the string from one note to the next.

PORTA NIGRA, pŏr'tá nŏ'grá (Lat., Black Gate). A famous gateway of Treves, dating probably from the fourth century A.D. It is constructed of sandstone, and is blackened with age, whence its name. The gate was closed by a porteullis and fortified by two towers, one of which was occupied early in the eleventh century by Simeon, a Greek hermit, and from this fact the gate is called also Simeonsthor. A number of Roman antiquities are preserved in the interior.

PORT ANTONIO. A seaport town on the northern coast of Jamaica (Map: Cuba, J 8). It is the second commercial town of the island and is the centre of the fruit trade. It is connected by rail with Kingston.

PORTA PRÆ'NESTINA. See PORTA MAGGIORE.

PORT ARTHUR (Chin. *Lü-shun K'ow*). A town and strongly fortified naval station near the Lao T'ieh Shan promontory of the peninsular portion of the Manchurian province of Shing-king or Fung-t'ien fu, leased by China to Russia with certain adjacent territory for a period of 25 years under an agreement dated March 27, 1898 (Map: China, F 4). The object of Russia was to secure

a naval station which she could defend for the use of her war vessels in Eastern waters, and the lease was granted with the distinct understanding that "it shall not prejudice China's sovereignty over the territory." It was further agreed that the port should be closed to all vessels except Chinese and Russian men-of-war. The town lies on the slope of the high hills which surround the oval inlet which forms the harbor, in lat. 38° 48' N. and long. 121° 20' E. The inlet on which it stands measures about two miles from east to west and one from north to south, and is well protected from storms by a spit of land which runs diagonally across its northern end. The harbor proper has been much enlarged by blasting and dredging; new docks, barracks, an arsenal, and warehouses have been built, and the place rendered impregnable. On the west side of the town is the terminus of the Russian railway to Harbin. See MANCHURIA.

Lü-shun K'ow was formerly only a small fishing village at the lower end of a long mountainous peninsula until it was selected by Li Hung Chang under the advice of German engineers for a strongly fortified naval station for the defense of the Pei-ho and Peking. In 1894, however, it was captured by the Japanese, and the Treaty of Shimonoseki provided for its cession to Japan with the whole southern coast of Manchuria from the Liao to the Yalu; but Russia, France, and Germany intervened and induced Japan to relinquish all this territory for the sum of 30,000,000 taels, and on November 30, 1895, its evacuation was begun. Consult "Some Facts About Port Arthur," in *United Service Magazine*, vol. cxlvi. (London, 1902). See DALNY; SHING-KING; and TA-LIEN WAN.

PORT-AU-PRINCE, pôrt'ô'prâns', or **PORT RÉPUBLICAIN**. The capital and principal seaport of Haiti, Western Indies, situated on the western coast of the island, opposite the island of Gonaïve (Map: West Indies, L 5). It lies in a marshy region and, although well laid out, is in a general state of decline and quite unsanitary. It is built largely of wood and is partly in ruins, as a result of the earthquakes of the eighteenth and nineteenth centuries. The principal buildings are the wooden palace, the Senate building, and the cathedral. The town contains also the mint, the custom house, a lyceum, and a college. The harbor is safe and fortified. The population of the city is estimated at 61,000. Consult Fortunat, *Nouvelle géographie de l'île de Haïti* (Port-au-Prince, 1888).

PORT CHESTER. A village in Westchester County, N. Y., 26 miles northeast of New York City; on Long Island Sound and on the New York, New Haven and Hartford Railroad (Map: New York, G 4). It enjoys considerable popularity as a summer resort and is also a residential suburb of New York. There are a free library, besides public school libraries, a public hospital, and three fine bank buildings; also a park (Monument). The village has large nut and bolt works, foundries, and manufactures of shirts, carriages, etc. The government is vested in a president and board of trustees, elected biennially. Port Chester was settled probably as early as 1742, and was known as Saw Pit until 1837, when the present name was adopted. It was incorporated as a village in 1868. Population, in 1890, 5274; in 1900, 7440.

PORT CLINTON. A village and the county seat of Ottawa County, O., 31 miles east by south of Toledo; on Lake Erie, at the mouth of the Portage River, and on the Lake Shore and Michigan Southern Railroad (Map: Ohio, E 2). It has a fine harbor, and is the commercial centre of a region engaged largely in fruit-growing. There are also large lime, plaster, and stone interests. The mining of gypsum, basket-making, and fishing are other important industries. Population, in 1890, 2049; in 1900, 2450.

PORTCULLIS (OF. *porte coleice*, *porte coulisse*, sliding gate, from *porte*, from Lat. *porta*, gate, and *coleice*, *coulisse*, fem. of *coleis*, *coulis*, sliding, from Lat. *colatus*, p. p. of *colare*, to flow, to strain, from *colum*, sieve). A frame of iron, or wood strengthened with iron, made in the form of grating, designed to slide in vertical grooves built in the jambs of the entrance gate of a fortified place, in order to defend the gate in case of assault. The vertical bars were pointed with iron below, and struck on the ground when the grating was dropped, so as to injure whoever or whatever they fell upon. (See CASTLE.) In heraldry (q.v.) the portcullis is represented with rings at its uppermost angles, from which chains depend on either side. It was a badge of the Beaufort family, and borne in virtue of their Beaufort descent by the Tudor sovereigns. Portcullis is the title of a pursuivant in the English college of arms, whose office was instituted by Henry VII.

PORT DE PAIX, pôr de pâ. A town and port of Haiti, on the Tortuga Channel, one hundred miles north of Port-au-Prince, and on the right bank of the Trois Rivières at its mouth (Map: Antilles, L 5). The agricultural interests of the section are largely devoted to coffee. The population is estimated at 10,000. Columbus visited the port in 1492 and named it Valparaiso. It was taken by French filibusters in 1665.

PORT DURN'FORD. A seaport in British East Africa at the mouth of the Sheri River (Map: Africa, J 5).

PORTE, **SUBLIME PORTE**, or **OTTOMAN PORTE**. The name given to the Turkish Government. The origin of this name is to be referred to the ancient Oriental custom of making the gates of cities and of kings' palaces places of assembly in connection with the affairs of government and of the administration of justice. In the Byzantine Empire this custom was adopted, and the term was transferred from the high gate of the Imperial palace to the Government whose authority was there exercised. The Turks found the term in common use among the Byzantines some time previous to their establishment at Constantinople, and adopted it on the organization of their empire. The use, among European nations, of the French term *sublime porte* ('lofty gate') is accounted for by the fact that French is the language of European diplomacy. See TURKEY.

PORTE CRAYON (Fr., pencil-holder). The pseudonym of the American author and illustrator David H. Strother (q.v.).

PORT ELIZ'ABETH. The largest and most important city of Cape Colony next to Cape Town. It is situated on Algoa Bay 400 miles east of Cape Town, on the barren peninsula of Cape Recife (Map: Cape Colony, K 9). It is a well-built city. There are fine, substantial pub-

lic buildings, and large commercial houses. There are also a college and other schools, and a botanical garden, the latter irrigated from the city's water supply, which is brought over an aqueduct 28 miles long. The location of Port Elizabeth midway between Cape Town and Durban, and at the nearest point on the coast from Kimberley, with which it is connected by a railroad, gives the town great commercial advantages. Its harbor, partly sheltered by the cape, is being further improved by great engineering works. The imports in 1898 were valued at \$30,355,560, and the exports, chief of which were gold, diamonds, wool, ostrich feathers, and hides, amounted to \$10,220,580. Population, in 1891, 23,266.

PORTEOUS RIOT. An uprising in Edinburgh on the night of September 7, 1736. John Porteus, captain of the city guard of Edinburgh, was hated by the populace, and when on April 14, 1736, he superintended the execution of an Edinburgh merchant, Andrew Wilson, who had robbed a custom-house, disturbances were feared, especially since the sympathy of the people was with smugglers and their allies. The mob remained quiet until Wilson was dead and then began to throw stones. Porteous, without any warning, ordered his soldiers to fire into the crowd and did likewise himself. Six or seven persons were killed and twenty wounded. Porteous was brought to trial, found guilty, and condemned to death. He, however, petitioned the Government and a reprieve was granted. This aroused the people and some men in disguise forced the jail on the night of September 7th, took out Porteous and hanged him. As a result a bill was passed by Parliament which disqualified the provost of Edinburgh from holding any Government office in the future, and fined the city £2000 for the benefit of the widow of Porteous. The participants in this riot were never discovered, but it was believed that people of high social and official standing were connected with it. The plot of Sir Walter Scott's *Heart of Midlothian* turns upon some of the supposed happenings of the Porteous riot.

PORTER. See BEER.

PORTER, ALEXANDER (1786-1844). An American jurist, who remodeled the jurisprudence of Louisiana. He was born near Armagh, Ireland, came to America in 1801, was admitted to the bar in Nashville, Tenn., in 1807, and, removing to Saint Martinsville, La., became a member of the Constitutional Convention in 1811. His greatest labor was as judge of the Supreme Court of the State (1821-33), when he helped in the establishment of a new legal code. He was a Whig Senator (1834-37), a friend of the United States Bank scheme and of Texan independence, an advocate of the division of surplus revenues among the States, and an opponent of the abolition of slavery in the District of Columbia. Re-elected to the Senate in 1843, he served until his death.

PORTER, BENJAMIN C. (1843—). An American portrait and figure painter. He was born in Melrose, Mass., August 27, 1843. From 1872 to 1881 he studied at different times in Europe, especially in Venice and Paris. Porter at first devoted himself to figure painting, but of late years has chiefly painted portraits. In 1880 he became National Academician, and took studios in New York City and Boston. His best works include:

"Henry V. and the Princess Kate" (1868); "Cupid with Butterflies" (1874); "Portrait of Lady with Dog" (1876); and "Portrait of Boy with Dog" (1884). Porter's pictures are always agreeable in color, and he has a good sense of composition. In 1900 he won a medal at the Paris exhibition.

PORTER, CHARLES T. (1826—). An American mechanical engineer. He was born at Auburn, N. Y., graduated at Hamilton College in 1845, practiced law for several years, and then became an engineer, forming a partnership with John F. Allen to control the Porter-Allen engine. This firm was the first to use with success high rotative speed in stationary engines. Porter was the inventor of a central counterpoise governor for steam engines (1859) and of an isochronous centrifugal governor for marine engines (1861), and the author of *Mechanics and Faith, Spiritual Truths in Nature* (1885).

PORTER, DAVID (1780-1843). A distinguished American naval officer. He was born in Boston, and was the son of a naval officer in the Revolution. In 1798, after some experience on merchant vessels, in the course of which he was twice impressed by the British, but each time escaped, he entered the navy as a midshipman. In the following year he served on board the *Constellation* in her fight with the French frigate *L'Insurgente*. Being made a lieutenant in the following year, he served in the war with Tripoli, and in 1803 was captured with the *Philadelphia*, and remained a prisoner until peace was made.

During the first year of the War of 1812, as commander of the frigate *Essex*, 32 guns, he captured several English merchant vessels, a transport, and the corvette *Alert*, 20 guns. In the following February he entered the Pacific, and for almost a year preyed with great success upon the English whale-shipping in that ocean. On this cruise he was accompanied by young David G. Farragut (q.v.), whom he had adopted in 1809. After inflicting much damage upon the enemy, the *Essex* was blockaded in the port of Valparaiso by two English vessels, the *Phoebe*, of 36 guns, and the *Cherub*, of 20 guns. Porter offered to fight either singly, but as this offer was refused, he made an attempt on the 28th of March to get to sea, with the result that in doubling a headland his vessel was struck by a squall, which carried away her foretopmast and drowned several of her crew. Porter then returned to the harbor and anchored his vessel less than three miles from the town and only half a mile from the shore. Here, disregarding the rules of neutrality, the British attacked her, and after a bloody and unequal conflict of two hours and a half forced her to surrender. Despite the loss of his vessel, however, Porter was upon his return home received with great honors.

His career after the close of the war was a varied one. In 1824, being now a commodore, he was sent in charge of an expedition against the West Indian pirates. In the performance of this duty he compelled the Spanish authorities at Fajardo, Porto Rico, to render an apology for an insult to his flag; for this action he was afterwards court-martialed, and on the ground that he had exceeded his authority he was suspended from the service for six months. Disgusted with this treatment, he resigned, and entered the Mexican navy as rear-admiral. He remained in this

service until 1829, and then, being dissatisfied with it, resigned. He was soon afterwards appointed consul-general to the Barbary Powers by President Jackson, and was later transferred as chargé d'affaires to Constantinople, where he died in 1843. Porter published a *Journal of a Cruise Made to the Pacific Ocean by the United States Frigate Essex* (1815; 1822), a defense of his conduct at Foxardo (1825), and *Constantinople and Its Environs* (1835). Consult David Dixon Porter, *Life of Commodore David Porter* (Albany, 1875).

PORTER, DAVID DIXON (1813-91). A distinguished American admiral. He was a son of Commodore David Porter, and was born in Chester, Pa., June 8, 1813. In 1824 he accompanied his father on his expedition against the West Indian pirates, and when his father became Admiral of the Mexican navy he entered the same service as a midshipman. While serving under his cousin, Captain David H. Porter, who was in command of a Mexican vessel cruising against Spanish commerce, young Porter took part in a desperate engagement with a much superior Spanish frigate. The vessel on which he was serving was captured, and he was for a short time confined in the guard-ship at Havana. Soon after his release he was commissioned a midshipman in the United States navy, and served until 1835 on the European station. In 1846 he was sent by the Secretary of War on a secret mission to Haiti, and then served with distinction in the Mexican War as a lieutenant and afterwards as commanding officer of the *Spitfire*. After the close of that struggle he obtained a furlough, and for some years commanded private passenger steamers.

The Civil War gave Porter the opportunity to distinguish himself. The beginning of that struggle found him a lieutenant on shore duty; in a little more than two years he was a rear-admiral in command of a squadron. His first service in the war was to assist as commander of the *Powhatan* in the relief of Fort Pickens. Shortly afterwards he was advanced to the rank of commander. A little later, largely through his recommendation, Farragut was given command of the Western Gulf Blockading Squadron which was to operate against New Orleans, and Porter was put in charge of the fleet of bomb-vessels under him. By Farragut's order, Porter in April, 1862, began a bombardment of Forts Jackson and Saint Philip, which guarded the way up the Mississippi, and after six days and nights, in the course of which he threw into them more than 16,000 shells, he reduced them to such a condition that Farragut's fleet was able to pass them and capture New Orleans. Four days later the forts themselves surrendered to Porter. During the next few months he served with great credit in the operations between New Orleans and Vicksburg. In September, 1862, he was put in charge of the Mississippi Squadron as acting rear-admiral. He improvised a navy-yard at Mound City, and soon increased his squadron of about a dozen effective vessels to more than 120 by converting ordinary river steamers into gunboats. With a part of this fleet he, in January, 1863, assisted the army in the capture of Arkansas Post, and next succeeded in running past the batteries of Vicksburg and reducing the Confederate forts at Grand Gulf. He then cooperated

with General Grant in the siege of Vicksburg, and upon the surrender of that place received the thanks of Congress and a commission as rear-admiral. In the spring of 1864 he assisted General Banks in the disastrous expedition up the Red River, and it was only by the greatest exertions that he succeeded in saving his vessels. (See BAILEY, JOSEPH.) In the same year he was put in command of the North Atlantic Blockading Squadron. While in this command his most important service was in cooperating in the capture of Fort Fisher, which was taken by assault on the 15th of January, 1865, after a long and destructive bombardment by his fleet. For this service he again received the thanks of Congress.

After peace came, he served from 1865 to 1869 as superintendent of the Naval Academy at Annapolis, and did much to increase the efficiency of that institution. In 1866 he was promoted to be vice-admiral, and in 1870, upon the death of Farragut, was advanced to the highest of all naval ranks, that of admiral. He died in Washington in 1891.

Admiral Porter wrote a life of his father, Commodore David Porter (1875); *Incidents and Anecdotes of the Civil War* (1885); *History of the Navy in the War of the Rebellion* (1887); two novels, *Allan Dale* and *Robert le Diable* (1885) and *Harry Marline* (1886); a posthumous novel-ette, *A Romance of Gettysburg*, which appeared in the *Criterion* for 1903; and articles for various publications.

Consult: Soley, *Admiral Porter* (New York, 1903), in the "Great Commanders Series;" Chesney's *Essays in Military Biography* (New York, 1874); and Johnson and Buel (eds.), *Battles and Leaders of the Civil War* (New York, 1887).

PORTER, FITZ JOHN (1822-1901). A distinguished American soldier. He was born at Portsmouth, N. H., graduated at West Point in 1845, and was assigned to the artillery, in which he became second lieutenant the following year. He served in the war with Mexico from the beginning; was wounded in the attack on the City of Mexico, September 13, 1847; and was brevetted captain and major for gallantry in the battle of Molino del Rey and the storming of Chapultepec, respectively. After the war he was sent to West Point, where he served as adjutant of the post, and as instructor of artillery and cavalry. In 1856 he was transferred to the Adjutant-General's department, and was assistant adjutant-general of the Utah expedition under Albert Sidney Johnston in 1857. On May 14, 1861, he received the appointment of colonel of the 15th Infantry; was made brigadier-general of volunteers in the same month, and served as chief of staff with General Banks and General Patterson until August, when he was put in command of a division in the Army of the Potomac. He had charge of the siege operations against Yorktown during the Peninsular campaign, acted as military governor of the place for a time after its evacuation, and was then given the command of the 5th Army Corps, which fought the battles of Mechanicsville and Gaines's Mill, and bore the brunt of the fight at Malvern Hill. He was appointed brevet brigadier-general in the Regular Army for gallantry at the battles of the Chickahominy, and on July 4, 1862, was commissioned major-general of volunteers. At the second battle of Bull Run his failure to move forward on the first-day of the en-

agement led to his trial by court-martial on the charge of disobeying the orders of General Pope. He was found guilty and was cashiered and disqualified from holding any position of trust or profit under the United States Government. The justice of the punishment was a subject of much controversy, and numerous attempts were made to secure a reversal of the verdict.

In June, 1878, a board of officers convened at West Point, by order of the President, to examine the evidence and to consider the findings of the court-martial, and to report to the Secretary of War what action, in their judgment, justice required should be taken by the President. This board, after a full examination of the case, including evidence before inaccessible, and other evidence before misunderstood, reported that, in the opinion of those forming it, justice required at the hands of the President of the United States "such action as may be necessary to annul and set aside the findings and sentence of the court-martial in the case of Major-General Fitz John Porter, and to restore him to the position of which that sentence deprived him—such restoration to take effect from the date of his dismissal from office." This report was signed by the entire board, including Major-General J. M. Schofield, Brigadier-General Alfred H. Terry, and Brevet Major-General George W. Getty. The report was laid before the House Committee on Military Affairs, and a majority of the committee, in January, 1881, reported a bill restoring him to his rank of major-general in the United States army, and requiring the Secretary of the Treasury to pay to him the sum of \$75,000. The bill for his relief failed to pass, but President Arthur in 1882 remitted the disqualifying clause in his sentence. In 1886 a bill for his restoration to the army with the rank of colonel, but without back pay, was passed and approved by the President, and soon afterwards General Porter was retired.

After his return from the army General Porter engaged in business in New York City, where he afterwards held several municipal offices, among them that of Police Commissioner and Commissioner of the Fire Department. Until his death he considered that he had been deeply wronged. The controversy regarding his treatment provoked a mass of partisan articles and of reviews of the evidence of the case, but no adequate biography has yet appeared. For perhaps the strongest statement of the case against Porter, consult Cox, *The Second Battle of Bull Run as Connected with the Fitz John Porter Case* (Cincinnati, 1882); for a brief statement of the case in his favor, consult an article by General U. S. Grant in vol. exxxv. of the *North American Review*.

PORTER, HORACE (1837—). An American soldier and diplomat, son of David Rittenhouse Porter and grandson of Andrew Porter. He was born at Huntingdon, Pa.; studied for a year at the Lawrence Scientific School, Harvard, then entered West Point, where he graduated in 1860, and a year later was commissioned first lieutenant and detailed for duty as ordnance officer of the Port Royal Expeditionary Corps. At the reduction of Fort Pulaski, Ga. (April 10-11, 1862), he was the chief of ordnance and artillery, and by his gallantry earned the brevet rank of captain. In the attack on Secessionville, S. C. (June 16, 1862), he was wounded, but was

able to act as chief of ordnance in the transfer of the Army of the Potomac from Harrison's Landing, Va., to Maryland, after the Peninsular campaign of 1862. He was then assigned to duty in the West and participated in the Tennessee campaign (June 24-November 1, 1863), during which he fought at the battle of Chickamauga and took part in the defense of Chattanooga. On April 4, 1864, he was promoted to be lieutenant-colonel and was assigned to the staff of General Grant, with whom he remained until July 25, 1866, taking part in all the battles of the Richmond campaign until the surrender at Appomattox Court House. On March 13, 1865, he received the brevet rank of brigadier-general in the Regular Army. After the war, when General Grant was for a few months in 1867 Secretary of War, Porter became his assistant, and when Grant was elected to the Presidency Porter became his private secretary. In 1873 he resigned from the army to become vice-president of the Pullman Car Company, and during the following years he filled executive positions on several railroads. In 1897 President McKinley appointed him Ambassador to France. General Porter became well known as an orator and as an author. His writings include *West Point Life* (1866); *Campaigning with Grant* (1897); and the articles on "Five Forks and the Pursuit of Lee" and "The Surrender at Appomattox Court House," in *Battles and Leaders of the Civil War* (1887).

PORTER, JAMES (1753-98). An Irish clergyman and author, the son of a poor farmer. He was born near Ballindrait, in the County of Donegal. Leaving his father's farm, he taught school, and later he studied for the Presbyterian ministry at Glasgow. In 1787 he was ordained minister at Greyabbey, in the County of Down. For the Belfast *Northern Star*, a newspaper founded by Samuel Neilson in the interests of the Society of United Irishmen, Porter wrote several patriotic songs (1794), republished as *Paddy's Resource*, and the famous seven letters by "A Presbyterian," reprinted as *Billy Bluff and Squire Firebrand* (1796). These brilliant satires eventually cost Porter his life. On the outbreak of the rebellion in 1798 he was without fair trial convicted of treason and hanged.

PORTER, JAMES (1808-88). A minister of the Methodist Episcopal Church. He was born at Middleborough, Mass., and joined the New England Conference in 1830. He was elected as one of the agents of the Methodist Book Concern in 1856, and reelected in 1860 and 1864; was secretary of the National Temperance Society in 1868-82; member of the Board of Overseers of Harvard University in 1852-55; trustee of Wesleyan University in 1855-71. He wrote a number of religious works.

PORTER, JANE (1776-1850). An English novelist, born in Durham. She was educated in Edinburgh and lived with her mother and sister till their death at Esher in Surrey, where she passed her last years. In her childhood she was often visited by young Walter Scott, who delighted her with fairy tales and stories of the border. Her first work, *Thaddeus of Warsaw* (1803), was extremely popular and secured her a complimentary letter from Kosciuszko and election into the Teutonic Order of Saint Joachim. In 1810 she published *Scottish*

Chiefs, dealing with the times of Bruce and Wallace. This book was translated into German and Russian, and won European fame. It is by far the best historical romance before Scott. She composed, with her sister Anna Maria, *Tales Round a Winter Hearth* (1826) and *The Field of Forty Footsteps* (1828). Her last novel, *Sir Edward Scavard's Diary* (1831), purporting to be founded on fact, created a great sensation.

PORTER, JOSIAS LESLIE PORTER (1823-89). An English Presbyterian minister and educator, born in Burt Parish, Donegal County, Ireland. Educated in Londonderry and the Universities of Glasgow and Edinburgh, he studied theology under Dr. Chalmers at New College, and was licensed to preach in 1844. He was pastor of a church in Newcastle-on-Tyne from 1846 until 1849, when the Irish Presbyterian Board of Missions sent him to Damascus. For the next ten years he was a missionary to the Jews in Syria and Palestine, was then called to the chair of biblical criticism in the Presbyterian College, Belfast, and became president of Queen's College in the same city in 1879. His publications include: *Five Years in Damascus* (2 vols., 1855); *Murray's Handbook for Travellers in Syria and Palestine* (1858); *The Giant Cities of Bashan* (1865); *Jerusalem, Bethlehem, and Bethany* (1887); and *Through Samaria* (1888).

PORTER, NOAH (1811-92). An American professor of philosophy and a president of Yale University, born in Farmington, Conn., where his father, Rev. Noah Porter, was for more than fifty years minister of the Congregational Church. After graduating at Yale in 1831, he was for a short time rector of the ancient Hopkins Grammar School and subsequently was a tutor in Yale College. He then entered the Congregational ministry, and was successively a pastor in New Milford, Conn. (1836), and in Springfield, Mass. (1843-46). The Clark professorship of metaphysics was then established at Yale, and the young minister became the first incumbent of the chair, which he held from 1846 until his death. In the winter of 1853-54 he studied under Trendelenburg and other professors in the University of Berlin. When Dr. Woolsey resigned the Yale presidency in 1871, Porter was chosen as his successor, and for fifteen years he discharged the difficult duties of that station, lecturing also as a professor, preaching in the college pulpit, and engaging in many literary and scholastic avocations. He resigned the presidential chair in 1886, being followed by Timothy Dwight. His principal publication is a well-known text-book on *The Human Intellect* (1868), which was supplemented by one entitled *The Elements of Moral Science* (1885). He is also widely known as the editor-in-chief of two quarto editions of *Webster's Dictionary* (1864-1900). His minor works included: *Books and Reading* (1870); *Science of Nature vs. Science of Man* (1881); *Science and Sentiment* (1882); and a commemoration of *Bishop Berkeley* (1885). Many of his best essays appeared in periodicals. After his death the tributes to his memory by some of his friends and colleagues were printed in a small volume. One of the sisters of President Porter, Miss SARAH PORTER (1813-1900), established and maintained in Farmington a school for girls, which acquired a national reputation and is still distinguished by the excellent

character of those who have enjoyed its training. A brother, Samuel Porter, spent his life as one of the professors in the Gallaudet College for Deaf Mutes in Washington, and wrote the guide to pronunciation for the edition of Webster's dictionary of 1890.

PORTER, PETER BUEL (1773-1844). An American political leader and soldier; born at Salisbury, Conn. He graduated at Yale in 1791, and after 1795 practiced law first at Canandaigua, N. Y., and then at Black Rock, now part of the city of Buffalo. He was elected to Congress as a Democrat in 1808, and there became a conspicuous advocate of internal improvements. He was reelected in 1810, and for a time was chairman of the Committee on Foreign Relations. At the outbreak of the War of 1812 he resigned his seat in Congress and led a body of New York and Pennsylvania volunteers to the Niagara frontier, where he joined the forces under Gen. Alexander Smyth. Porter soon became disgusted with his superior's management of the expedition, and charged him with being a coward. This led to a bloodless duel on Grand Island. Afterwards, when General Jacob Brown (q.v.) led the Americans into Canada, Porter commanded one of three brigades into which the army was divided, and participated in the battles of Chippewa and Lundy's Lane, and the siege of Fort Erie. In 1815 he again entered Congress, and served until the following year, when he was appointed one of the commissioners under the Treaty of Ghent to determine the northwestern boundary. In 1828 he became Secretary of War in John Quincy Adams's Cabinet, and served until the end of the administration a year later. His interest in internal improvements made him one of the most zealous projectors of the Erie Canal, and he was appointed a member of the first commission.

PORTER, SIR ROBERT KER (1775-1842). An English historical painter and traveler, born in Durham, and a brother of Jane Porter, the novelist. He was a pupil of the Royal Academy. His earlier works include some religious pictures, but he first attracted attention by his panoramic painting, "The Storming of Seringapatam" (1800). Other historical paintings by him are "The Battle of Lodi;" "The Defeat of the French at Devil's Bridge, Mont Saint Gothard, in 1804;" "Agincourt;" and the "Siege of Acre." In 1804 he was appointed battle painter to the Czar of Russia, and did some large decorative works for him in the Admiralty Hall, Saint Petersburg. He accompanied Sir John Moore to Spain in 1808, and wrote *Letters from Portugal and Spain* (1809). From 1826 until 1841 he was consul to Venezuela, and lived at Caracas. He wrote: *Traveling Sketches in Russia and Sweden During the Years 1805-08* (1809); *Travels in Georgia, Persia, Armenia, Ancient Babylon* (1821), his most valuable work; and *Narrative of the Campaign in Russia During 1812* (1813).

PORTER, ROBERT P. (1852—). An American journalist, born at Marham Hall, Norfolk, England. He emigrated to the United States and became one of the original staff of the Chicago *Inter Ocean*, devoting his attention chiefly to economic questions. He made reports for the Tenth Census on wealth, debt, taxation, and transportation in the United States, and in 1882 was appointed a member of the Tariff Commission. The *New York Tribune* and the Philadelphia

Press sent him to Europe to study industrial conditions, and in 1888 he joined Frank Hatton in founding the *New York Press*. From 1889 to 1893 he was superintendent of the Eleventh Census. Later he went to Japan to report on the industries and commerce of that country for the Manufacturers' Association of the United States, and in 1898-99 he acted as special commissioner of the United States to Cuba and Porto Rico. Besides his contributions to the periodical press, he published a number of books, including: *The West in 1880*; *Life of William McKinley* (1896); *Municipal Ownership at Home and Abroad* (1898); and *Industrial Cuba* (1899).

PORTER, THOMAS CONRAD (1822-1901). An American botanist. He was born at Alexander, Pa., was educated at Lafayette College and Princeton Theological Seminary, and preached for five years. In 1849 he was appointed to the chair of natural science in Marshall College, and after serving in the same capacity in Franklin and Marshall College, in 1866 became professor of botany in Lafayette College. Porter retired from active duties in 1897, but remained curator of the botanical collections and dean of the Pardee Scientific School. He wrote several essays on Finnish literature, in which he was deeply interested, and published: *Sketch of the Flora of Pennsylvania* (1872); *Sketch of the Botany of the United States* (1873); *The Flora of Colorado* (with Coulter, 1874); *The Carices of Pennsylvania* (1887); and *The Grasses of Pennsylvania* (1893).

PORTER, WILLIAM DAVID (1809-64). An American naval officer, son of Commodore David Porter and brother of Admiral David D. Porter, born at New Orleans, La. He entered the United States Navy as a midshipman in 1823, rose to the rank of lieutenant in 1833, was placed on the reserved list in 1855, but later was restored to active service with the rank of commander. He saw active service in the Mexican War, organized the United States lighthouse system, and at the outbreak of the Civil War was assigned to service on the Mississippi, where he commanded the iron-clad *Essex*. He took part in the capture of Forts Henry and Donelson; ran the gauntlet of the Confederate batteries from Cairo to New Orleans; fought two engagements with the Confederate ram *Arkansas*, destroying her in the second (August 6, 1862); and later in the same year shelled the batteries at Natchez, Vicksburg, and Port Hudson. He was promoted to the rank of commodore on July 16, 1862.

PORTE SAINT-DENIS, pôrt sã'n'de-né'. An arch on the Boulevard Saint-Denis in Paris, erected from designs by Blondel in 1672 to commemorate the victories of Louis XIV. in Holland and on the Lower Rhine, typified by a dead lion and a river-god of the Rhine at the base of the arch. It is 81 feet in height, 82 in width, and 16 in thickness, with a single archway 50 feet high. With the Porte Saint-Martin, the arch was the scene of revolutionary conflicts in 1830, 1848, and 1871.

PORTE SAINT-MARTIN, sã'n'mãr'tãn'. A triumphal arch at the end of the Boulevard Saint-Martin, Paris, built in 1674 in honor of Louis XIV. It is 57 feet in height and has three archways.

PORTFOLIO, THE. A periodical edited in Philadelphia from 1801 to 1812 by Joseph Den-

nie. Among the contributors were Charles Brockden Brown and John Quincy Adams, whose *Letters from Silesia* appeared in it.

PORT GLASGOW, glã's'kò. A seaport in Renfrewshire, Scotland, on the Clyde, two miles east of Greenock, and 17 miles west-northwest of Glasgow (Map: Scotland, D 4). It was founded in 1668 by the magistrates of Glasgow as a harbor for the ships that belonged to or traded with their city—the Clyde at Glasgow being inconveniently shallow. The deepening of the Clyde, enabling large vessels to ascend to Glasgow, seriously injured its commercial prosperity, but the trade has been for many years improving; the shipping employed is considerable. Port Glasgow is a well-built town. The principal buildings are the town-house and custom-house. It has extensive manufactures of sail-ropes, chain-cables, sugar refineries, foundries, ship-building yards, commodious quays, and an extensive wet dock. The municipal industries include the gas and water works, abattoirs, baths, and wash-houses. A free library and cemetery are maintained. In 1695 the town and a small adjacent district were made into an independent parish; in 1710 it was constituted the principal custom-house on the Clyde, and for a while took the lead of Greenock; in 1775 it was incorporated as a municipality, and by the reform bill of 1832 it was raised to the rank of a Parliamentary burgh. Population, in 1891, 14,624; in 1901, 16,840.

PORT HOPE. A town and port of entry in Durham County, Ontario, Canada; on Lake Ontario and the Grand Trunk Railroad; 63 miles east of Toronto (Map: Ontario, E 4). It is in a beautiful valley, on a hillside. It has water power, a fine harbor, and an active trade in lumber and grain. There are a large fleet of fishing vessels, and manufactories of woolen goods, buttons, leather, wooden ware, steam-engines, machinery, iron castings, etc. Population, in 1891, 5042; in 1901, 4188.

PORTHOS, pôr'tòs'. One of the three guardsmen in Dumas's Musketeer romances. He is gigantic in size, boastful, vain, and indiscreet, but lovable for the honest simplicity of his character.

PORT HUDSON. A small village in Louisiana, on the eastern bank of the Mississippi River, about 135 miles above New Orleans, located at the outward angle of an abrupt bend of the river. In 1862, during the Civil War, the Confederates constructed formidable batteries for a distance of three miles along the high bluffs around Port Hudson, and thus secured effectual control of the river at this point. In the spring of 1863 General Banks, with a large Federal force, proceeded against the position, and after trying ineffectually to turn it on the west, invested it on March 26th, Admiral Farragut having previously, on the night of March 14th-15th, run by the batteries with two vessels of his fleet, the *Hartford* and the *Albatross*, and thus secured the control of the river both above and below Port Hudson. This control, however, was bought at the cost of one vessel, the *Mississippi*, destroyed, and four vessels, which had been forced to turn back, disabled. On March 27th Banks made a determined but unsuccessful assault, and on the following day began a regular siege. On June 14th another unsuccessful assault was made, and then the siege continued until early

in July, when a third assault was planned. On July 7th, however, news of the surrender of Vicksburg to General Grant was received, and on the following day General Gardner, in command of the Confederates, agreed upon terms of surrender, a Federal force taking possession on the 9th. The Federal attacking force numbered altogether about 20,000, though its effective strength never exceeded about 13,000. Of these 707 were killed, 3336 were wounded, and 319 were reported missing. The Confederate garrison numbered about 7500, of whom about 700 were killed or wounded, 500 were reported missing, and 6340 were surrendered. Consult Johnson and Buel (eds.), *Battles and Leaders of the Civil War*, vol. iii. (New York, 1887).

PORT HURON. A city and the county seat of Saint Clair County, Mich., 60 miles northeast of Detroit; on Lake Huron, at the head of the Saint Clair River, and on the Pere Marquette, the Grand Trunk Western, and the Grand Trunk railroads (Map: Michigan, L 6). It also has steamboat connection with Detroit, Chicago, Duluth, and other lake and river ports. The city is built on both sides of the Black River, which here flows into the Saint Clair. A railroad tunnel under the Saint Clair River connects with Sarnia, Canada; it is more than a mile in length, or, including approaches, nearly two miles, and its construction, completed in 1891, cost about \$2,700,000. Port Huron has acquired considerable reputation as a summer resort, owing to its mineral water, but is of greater importance as a manufacturing, shipping, and commercial centre. There are a public library which is to occupy a new \$60,000 structure, the gift of Andrew Carnegie; the county bar library, with 10,000 volumes; a public hospital and home; and several public parks. The notable edifices include the Federal Government building, city hall, county court-house, and the Maccabee Temple, besides a number of business buildings.

Port Huron is a port of entry and controls a large commerce with Canada. Its total foreign trade in 1901 consisted of exports valued at \$9,126,000, and imports, \$2,957,000. It has extensive shipbuilding interests, there being several dry docks and ship yards. Among other industrial establishments are railroad shops of the Grand Trunk, foundries, boiler and engine works, farm machinery works, etc. The Port Huron Engine and Thresher Company at South Port Huron has a capitalization of \$1,000,000. Under a charter of 1899, the government is vested in a mayor, elected biennially, a unicameral council, and administrative boards. The school and cemetery boards are elected by the city council, which also confirms the mayor's nominations of members of the board of assessors and of the police commission. The board of estimates is chosen by popular election. The water-works are owned and operated by the municipality. Settled about 1790 and variously called La Rivière Jarvais, Desmond, and Saint Joseph, Port Huron was organized as a village under its present name in 1849, and was chartered as a city in 1857. Population, in 1890, 13,543; in 1900, 19,158.

PORTIA, pŏr'shĭ-ă. A rich heiress in Shakespeare's *Merchant of Venice*, whose marriage was to be determined by her suitors' choice of one of three caskets. Bassanio, whom she loved, made

the lucky choice, and when his friend Antonio, as his security, fell into the clutches of Shylock, Portia, disguised as Balthazar, a young doctor of law, argued the case successfully in court.

PORTICI, pŏr'tĕ-chĕ. A town in the Province of Naples, Italy, situated on the Bay of Naples, and on the slope of Vesuvius, five miles by rail southeast of Naples (Map: Italy, E 10). Its environs abound in fine villas. The castle built by Charles III, in 1738 contains a school of agriculture. The town has a gymnasium and a lyceum. The inhabitants are engaged in fisheries, and in the weaving of silk. Portici has been several times destroyed by lava, and rebuilt. Population (commune), in 1901, 14,538.

PORTICO (It. *portico*, from Lat. *porticus*, porch, gallery, from *porta*, gate). A covered space with a roof supported by columns open on one or more sides. It is usually attached to an important building, but sometimes detached, as a shady walk. A portico is called tetrastyle, hexastyle, octostyle, and decastyle, according as it has four, six, eight, or ten columns in front. The term is used of the space all around the cella of a Greek peripteral temple, or of that in the front and rear of a temple *in antes*. The similar terms *porch* (q.v.) and *vestibule* (q.v.) are used of less important structures of the same class.

PORTION (Lat. *portio*, share; connected with *pars*, part, *parare*, to prepare, Gk. *επορον*, *eporon*, I prepared). A share of a parent's property or estate, or that of a person standing *in loco parentis*, which is devised or bequeathed by will, or descends to a child, or which is given to him by the parent during the latter's lifetime, and intended to be a final provision for the child, in case of the parent's death. The word portion has no especial technical signification in the law today, except where property is given to children by way of advancement, as a marriage portion, by which the parent anticipates the probable amount the child would receive in case of the parent's death. See **ADVANCEMENT**; **DESCENT**; **INHERITANCE**; **WILL**.

PORT JACKSON SHARK. One of the small cestracion sharks of Australian and South Pacific seas, of which the principal species (*Cestracion Philippi*) is common about the southern shores of Australia, and takes its name from one of the harbors. The egg is very curious, consisting of a conoid leathery case, around which is wound spirally a broad flange, and two horny tendrils serve to attach it to some support. See **CESTRACION**; and Colored Plate of FISHES OF THE PHILIPPINES, accompanying article **PHILIPPINE ISLANDS**.



EGG-CASE OF A CESTRACION SHARK.

PORT JERVIS. A village in Orange County, N. Y., 88 miles northwest of New York City; on the Erie and the New York, Ontario and Western railroads (Map: New York, L 6). It is picturesquely situated at the confluence of the Delaware and Neversink rivers, and at the junction of the boundary lines of New York, New Jersey, and Pennsylvania. A popular summer resort,

the village is of equal importance as the railroad station for a considerable territory, much frequented in summer and widely celebrated for beautiful scenery, many waterfalls contributing to its picturesqueness. Port Jervis has a public library with about 12,000 volumes, Saint Mary's Orphan Asylum, a public hospital, and a soldiers' monument. Among the industrial plants are the Erie Railroad shops, foundries, silver-plating works, and manufactories of glass, shoes, saws, gloves, harness, etc. Population, in 1890, 9327; in 1900, 9385.

PORTLAND. A town (population, in 1900, 3856) in Middlesex County, Conn., on the Connecticut River, opposite Middletown (q.v.).

PORTLAND. A city and the county seat of Jay County, Ind., 49 miles south-southeast of Fort Wayne; on the Salamanie River, and at the junction of the Lake Erie and Western and the Grand Rapids and Indiana railroads (Map: Indiana, D 2). It has a public library, established in 1900, and public buildings of considerable merit. The city is in an agricultural region which possesses a supply of natural gas. There are various manufactures, including butter tubs and cases, spokes, handles, brick, flour, etc. The water-works and electric light plant are owned by the municipality. Population, in 1890, 3725; in 1900, 4798.

PORTLAND. The largest city and commercial metropolis of Maine, and the county seat of Cumberland County, 108 miles north by east of Boston; on Casco Bay, and on the Maine Central, the Boston and Maine, and the Grand Trunk railroads (Map: Maine, C 8). The town is the terminus of several lines of transatlantic steamships, besides coastwise lines. Portland possesses a site of great natural beauty on a peninsula extending into Casco Bay, which is dotted with numerous picturesquely wooded islands. Many of these islands are popular summer resorts. Portland itself is of considerable reputation as a resort, and the noted watering places of the vicinity are easily accessible from the city. The harbor is spacious, deep, and secure. Its defenses, which have been recently improved to a considerable extent, now include Fort Preble (q.v.), Fort Williams on Portland Head, Fort Levett on Cushing's Island, and Fort McKinley on Great Diamond Island. Forts Scammel and Gorges, formerly strongly equipped, now serve but to enhance the general beauty of the harbor. A marginal railway extends along the water front of the business portion of the city.

Portland has an area of more than 18 square miles. It is regularly laid out for the most part, and, from the fine shade trees that line its streets, it has acquired the name 'Forest City.' There are 113 acres in the public park system, which includes Deering Oaks, Lincoln Park, Fort Allen and Fort Sumner parks, Monument Square with a soldiers' monument, and the Eastern and Western Promenades. The observatory on Munjoy's Hill commands a superb view of the city and its waters, and of the mountains some distance inland. On the southern slope of the hill is the Eastern Cemetery, the burial place of a number of persons noted in history. Among the prominent structures in Portland are the city hall, custom house, post-office, United States Marine Hospital, Maine General Hospital, the public library (47,500 volumes), which is the home also of the

Maine Historical Society, founded in 1822, with a library of 13,500 volumes, the building of the Portland Society of Natural History, and the cathedrals of Saint Luke (Protestant Episcopal) and the Immaculate Conception (Roman Catholic). Several old colonial mansions, the Longfellow House, Wadsworth Mansion, and the Preble House are of historic interest. Portland has the Maine Medical School, connected with Bowdoin College; the Maine Eye and Ear Infirmary, and a number of other charitable institutions; and several libraries besides those mentioned above. A bronze statue of Longfellow is one of the features of the city.

From colonial times Portland has been noted for commercial interests, its trade, with the West Indies especially in earlier days, being one of its important sources of wealth. The city is still of greater importance for its commerce than for its industrial enterprises, exporting extensively grain, apples, and live stock. The foreign trade of the customs district of Portland and Falmouth in 1901 consisted of exports aggregating in value \$12,416,793, and imports, \$633,114. In recent years the exports have increased substantially, while the imports show a tendency to decline. According to the census of 1900, there were in Portland manufactures having an invested capital of \$6,991,000, the products being valued at \$11,440,000. The most important establishments include foundries and machine shops, railroad car and machine shops, manufactories of lumber and lumber products, boot and shoe factories, clothing factories, furniture factories, confectionery factories, flavoring extract works, fruit, vegetable, and fish canneries, carriage and wagon shops, flour and grist mills, marble works, etc.

Under a revised charter of 1900, the government is vested in a mayor, elected annually, a bicameral council, and administrative officials. The commissioner of public works, city marshal and deputies, and the board of health are appointed by the mayor, who also nominates, with the consent of the board of aldermen, members of the police force. The city treasurer, city clerk, auditor, messenger, and subordinate officers are elected by the city council. The school board is chosen by popular vote. It elects the superintendent of schools.

Population, in 1800, 3822; in 1850, 20,815; in 1870, 31,413; in 1890, 36,425; in 1900, 50,145.

Portland, the Indian Machigonne, was settled by two Englishmen, George Cleves and Richard Tucker, in 1632, and until 1658, when the name was changed to Falmouth, was known as Casco Neck. In 1676 it was completely destroyed by the Indians, and all its inhabitants were either killed or carried into captivity. In 1690, settlers again having come in some numbers, the place was once more destroyed and all its inhabitants massacred or captured. It was resettled in 1715, was bombarded and burned in 1775 by a British fleet, was incorporated as a town under its present name in 1786, and was chartered as a city in 1832. On July 4, 1866, a fire broke out and consumed 1500 buildings in the centre of the city, with a loss of about \$10,000,000. Longfellow, N. P. Willis, Commodore Preble, Neal Dow, and Thomas B. Reed were natives of Portland. Consult: Neal, *Portland* (Portland, 1874); Willis, *History of Portland* (2d ed., Portland, 1865); and a sketch in Powell's *Historic Towns of New England* (New York, 1898).

PORTLAND. The largest city in Oregon and the county seat of Multnomah County, and an important commercial and industrial centre. Situated on both sides of the Willamette River, 12 miles above its confluence with the Columbia River and about 120 miles from the Pacific, Portland is distant 52 miles north-northeast of the State capital, Salem, and 774 miles north by east of San Francisco (Map: Oregon, G 7). It is built on slopes rising gradually from the river banks into wooded hills, with tall mountains in the distance—a site of great natural beauty that is enhanced by the fine trees and lawns of the city. In the vicinity are numerous picturesque waterfalls; and Portland Heights, in the western part of the city, command a superb view of the distant mountains and the valleys of the Columbia and the Willamette.

The city has an area of 40 square miles and is well laid out. About two-thirds of its total street mileage is paved, a great proportion of this distance (122 miles) being laid with macadam and gravel. There are more than 205 acres in the public park system. Among the noteworthy structures in Portland are the city hall, occupying an entire block, the post-office, court-house, Portland library, high school, Chamber of Commerce, Hotel Portland, the Union Railroad Depot, Industrial Exposition building, the office of the *Oregonian*, the tallest edifice in the city, the Dekum, Worcester, Meier, and Frank buildings, and the Marquam Block. The law and medical departments of the State University are in Portland, and there are several well-known preparatory schools. The Portland Library, which has been recently opened to the public, contains 27,000 volumes. The city has a number of charitable institutions, of which Saint Vincent's and Good Samaritan hospitals are the best known. Other features of interest are two handsome fountains, and the four bridges across the Willamette River, two of which are fine steel structures.

Portland has exceptional advantages for a commercial centre. Situated at the head of ocean navigation, on the waterway formed by the Columbia and Willamette, it possesses a harbor commodious and accessible for the largest ships. Its port is the terminus of several ocean and coastwise steamship lines; and in the large Union Depot four great railroad systems terminate: the Great Northern, the Northern Pacific, the Union Pacific (the Oregon Railway and Navigation Company), and the Southern Pacific. The tributary region, rich in timber and in agricultural and mineral resources, is one of the most productive in the United States, though but partly developed. In 1901 the foreign commerce of the port was valued at nearly \$12,000,000, the exports, principally grain, flour, and lumber, constituting a very large proportion of this total. The trade is carried on chiefly with Great Britain and its possessions. Portland is highly important also as a distributing point, its wholesale and jobbing trade in 1902 amounting to about \$155,000,000. Its industrial interests, too, are extensive and varied, representing, according to the census of 1900, an invested capital of \$13,332,000, and having a production valued at \$23,451,000. The manufactures are favored by the power obtained from the Willamette Falls at Oregon City (q.v.), 12 miles distant. This power, electrically transmitted to Portland, is utilized also for lighting and for the operation of street

railways. The leading manufactures include lumber and timber products, flouring and grist-mill products, and the output of slaughtering and meat-packing plants. There are also bag factories, creameries, clothing factories, establishments for the roasting and grinding of coffee and spices, foundries and machine shops, including stove foundries, iron works, manufactories of fur goods, furniture factories, paint works, saddlery and harness factories, ship and boat building yards, soap and candle works, fruit drying and canning establishments, and breweries. A large dry dock is in course of construction (March, 1903).

The government is vested in a mayor, elected every two years, and a unicameral council, and in administrative officials, the majority of whom are appointed by the mayor, or nominated by him with the consent of the council. The school board, however, is chosen by popular vote. Portland spends annually in maintenance and operation about \$960,000; the principal items of expenditure being: for interest on debt, \$305,000; for schools, \$270,000; for the fire department, \$80,000; for the police department, \$55,000; for the care of streets, \$50,000; for municipal lighting, \$50,000. The water-works, which were built in 1857, are owned by the municipality, having been acquired by the city in 1886. The cost of their construction has been over \$4,000,000. The net debt of the city in 1902 was \$5,637,000; the assessed valuation of property, \$43,360,000.

Portland was founded in 1845 by F. W. Pettygrove and A. L. Lovejoy. It was named by the former in honor of Portland, Maine, and was chartered as a city in 1851. It suffered severely from fire in 1872 and 1873, the loss in the latter year having been about \$1,350,000. Portland has had an exceedingly rapid growth, as indicated by the following figures of population: 1850, 821; 1860, 2874; 1870, 8293; 1880, 17,577; 1890, 46,385; 1900, 90,426. The total in 1900 included 25,876 persons of foreign birth, and a colored population of 9812, 775 being of negro descent. Consult a chapter on Portland in Powell's *Historic Towns of the Western States* (New York, 1901).

PORTLAND, DUKE OF. An English title of nobility, borne by the Cavendish-Bentinck family since 1716, when it was conferred upon the heir of William Bentinck (1649-1709), first Earl of Portland, a Dutch general, the friend and adviser of William of Orange, whom he accompanied to England. The more distinguished members of the family have been Lord William Cavendish Bentinck, second son of the third Duke, and Lord William George Frederick Cavendish Bentinck, third son of the fourth Duke. See BENTINCK.

PORTLAND, ISLE OF. A rocky peninsula projecting into the English Channel from the shore of Dorsetshire, 17 miles west of Saint Alban's Head (Map: England, D 6). It is connected with the mainland by Chesil Bank, a ridge of loose shingle. It is famous for its stone, of which some of the finest buildings in London are built, among them Saint Paul's Cathedral. It contains a number of historic castles, such as Portland Castle, built by Henry VIII. in 1520; Pennsylvania Castle, erected by a grandson of William Penn; and Bow and Arrow Castle, supposed to have been built by William Rufus. The peninsula is strongly fortified, and there is an

immense convict prison with accommodations for 1500 prisoners, built in 1848. The Portland Breakwater (see BREAKWATER) affords a safe harbor of refuge. Population, in 1891, 9443; in 1901, 15,202.

PORTLAND CANAL. A long and narrow fiord indenting the west coast of North America opposite Queen Charlotte Islands (Map: Alaska, J 4). It extends northeastward for about 80 miles inland, is very deep, and inclosed by precipitous cliffs and by mountains from 3000 to 6000 feet high. It forms the extreme southern boundary of Alaska, which it separates from British Columbia.

PORTLAND CEMENT. See CEMENT.

PORTLAND VASE. A beautiful vase of transparent dark-blue glass, coated with opaque white glass, which has been cut away so as to resemble a cameo. The scenes on the vase have as yet found no satisfactory explanation. It was discovered in a large marble sarcophagus, of the third century of our era, which was found at Rome about the middle of the sixteenth century, and had contained the ashes of the dead. Its style, however, shows that it belongs to an earlier period, probably the first century B.C. It was at first deposited in the Barberini Palace in Rome, but was (1770) purchased by Sir William Hamilton, and finally by the Duchess of Portland. In 1810 the Duke of Portland lent it to the British Museum. In 1845 an insane visitor to the museum dashed it to pieces with a stone, but the fragments were so skillfully united that the damage is scarcely perceptible. It was copied by Wedgwood (q.v.) in his new style of pottery. Consult: J. Wedgwood, *The Portland Vase*, edited by Windus (London, 1845); Friedrichs-Wolters, *Die Gipsabgüsse antiker Bildwerke*, Nos. 2008, 2009 (Berlin, 1885).

PORT LOUIS, 𐌗𐌚'is or 𐌗𐌚'é. The capital and principal port of the British colony of Mauritius, situated on an inlet on the northwest coast (Map: Africa, K 7). It is well built, with straight, though narrow, streets. Its most notable buildings and institutions are the Roman Catholic and Protestant cathedrals, a library, a theatre, an observatory, and a botanical garden. Its harbor is capacious and defended by forts. By far the larger part of the trade of Mauritius passes through Port Louis, and a railway line connects the city with the southern and eastern parts of the island. The population is decreasing, and the Indian and Chinese elements are becoming prominent at the expense of the Europeans, though the latter still include more than half of the inhabitants. Population, in 1891, 62,046; in 1901, 52,740.

PORT MAHÓN, má-hón', or simply MAHÓN. The chief town of the island of Minorca, and one of the principal seaports of Spain, situated at the head of a bay on the east coast of the island (Map: Spain, H 3). It is a pleasant town with straight and regular streets, and many of its houses are built in the English style. The most notable buildings are the consistorial palace, the civil and military hospital, the fine Coliseum Theatre, and a church containing a magnificent organ. The town has a high school, a public library, and a museum. There are some manufactures of cotton textiles and leather goods, but

the chief importance of the town is derived from its fine harbor, which is one of the best in the Mediterranean. It has a large anchoring space, and is provided with a long quay accessible for the largest ships. Its situation makes it a convenient port of call between France and Algiers; it is also an important naval station, and its fortifications have recently been strengthened. Its trade amounts to over \$1,000,000 annually; its chief exports are live stock and agricultural products. Population, in 1887, 18,445; in 1900, 17,975. Mahón is supposed to have been founded by the Carthaginian general Mago, and its Roman name was *Portus Magonis*. It was in the possession of the English during the greater part of the eighteenth century.

PORT NATAL, ná-tál'. The seaport of Durban (q.v.) in South Africa.

PORTO ALEGRE, pôr'tó á-lá'gre. The capital of the State of Rio Grande do Sul, Brazil, situated at the mouth of the Jaenby River at the northern extremity of the Lagoa dos Patos (Map: Brazil, K 7). It is one of the cleanest and best built cities of Brazil, and has straight streets, and several large squares on one of which, the Praça de Dom Pedro, stand the Government building and the house of the Legislature. Other notable buildings are the cathedral, the theatre of Dom Pedro, and the custom-house. The city has a high school, a normal school, a theological seminary, and a school of engineering. It is the chief outlet for the products of the northern part of the State, and is connected with the interior by railroad. Its trade, however, is endangered by the rapid sanding up of the Rio Grande, the outlet of the lagoon, and extensive engineering works will be necessary to make the harbor of the city accessible to large vessels. The export trade, which is chiefly with Germany, the United States, and Great Britain, amounts to about \$3,000,000 annually, the chief articles exported being beef, salt pork, lard, hides, and flour. Near the city is a coal mine yielding over 16,000 tons annually. Population, in 1890, 52,421; in 1900 (estimated), 100,000.

PORTOBELLO. A popular watering-place on the Firth of Forth, three miles east of Edinburgh, Scotland (Map: Scotland, E 4). Its manufacturing establishments comprise potteries and earthenware, bottle, brick, and paper works, etc., but it is chiefly noted as a favorite summer resort for sea-bathing. It has a commodious town hall, a marine promenade, and a spacious amusement pavilion. Population, in 1891, 8181; in 1901, 9200.

PORTO EMPEDOCLE, pôr'tó òm-pá'dó-klá. A city on the southern coast of Sicily, six miles by rail southwest of Girgenti (q.v.), of which it is the seaport. It was formerly called Molo di Girgenti. The merchants of Girgenti have here great storehouses hewn in the rock for sulphur and for grain. The harbor is 26 feet deep, has a lighthouse, and is protected by a mole over a mile long. Population (commune), in 1901, 11,529.

PORTO FERRAJÓ, fôr-rä'yó. The chief town of the island of Elba (q.v.).

PORT OF SPAIN. The capital of the British West Indian island of Trinidad, situated on the western coast of the island (Map: West Indies, R 9). It is considered one of the finest towns in

the West Indies. There are a college and a fine botanical garden. Within the latter stands the magnificent residence of the Governor, and there are many other handsome buildings in the suburbs. The harbor can accommodate vessels of the heaviest draught. The port is the principal place of shipment for the products of the Orinoco region. Population, in 1891, 33,782; in 1901, 54,100.

PORTO MAGGIORE, pŏr'tŏ mäd-jŏ'rä. A town in the Province of Ferrara, Italy, situated on an island in the lagoons of the Commachio, about 15 miles by rail southeast of Ferrara (Map: Italy, F 3). The products are grain, beet root, and rope, and there is a trade in cattle and fish. Population (commune), in 1901, 20,162.

PORTO MAURIZIO, mou-rĕt'sĕ-ŏ. The capital of the Province of Porto Maurizio, Italy, situated on a promontory projecting into the Ligurian Sea, 58 miles by rail southwest of Genoa (Map: Italy, C 4). It is a winter resort, has a fine church, a library, a theatre, a technical institute, and a school of navigation. There is a shipping trade in olive oil, agricultural produce, and fish. Population (commune), in 1901, 7141.

PORTO NOVO, nŏv'ŏ. The capital of the French West African colony of Dahomey, situated a short distance from the Gulf of Guinea and connected by a lagoon with the seaport of Kotonu. It trades in palm oil and kernels. Porto Novo was the capital of the negro State of the same name, incorporated in 1893, with the colony of Dahomey. Population, estimated at 50,000.

PORTO NOVO. A seaport town of Madras, British India, situated on the Coromandel Coast, 15 miles south of Cuddalore (Map: India, D 6). Both the Portuguese and the Dutch had a factory here in the seventeenth century. Porto Novo is celebrated for its iron foundry, which supplied much of the material for the Madras railways, but is chiefly famous for the battle fought here on July 1, 1781, when Sir Eyre Coote, retreating after his defeat at Chidambaram, was again attacked by Hyder Ali with an overwhelming force, and by adroit strategy routed his assailants with great loss. Population of Porto Novo, called by the natives *Parangipetta*, about 14,100.

PORTO RICAN EXPEDITION, SOCIETY OF THE. A patriotic society projected at Caguas, Porto Rico, October 11, 1898, and organized at Columbus, Ohio, June 5, 1900. There are three classes of members: (1) Active members, who as officers or enlisted men in any branch of the United States service with the Porto Rican expedition were on the island before or on October 18, 1900, the date of the raising of the American flag over the Capitol at San Juan; (2) associate members, who are soldiers or sailors of good reputation belonging to organizations or vessels which composed the expedition, but who were detained in the United States by sickness or disability, or on detached service, as well as members of the Red Cross Society, volunteer nurses, etc., who served with the army in Porto Rico; and (3) honorary members. The membership, which is about 500, is distributed among departments, as follows: Ohio, Pennsylvania, New York, Massachusetts, Illinois, Kentucky, Wisconsin, and District of Columbia.

PORTO RICO, pŏr'tŏ rĕ'kŏ (Sp. *Puerto Rico*, Rich Port). An island of the West Indies, the most easterly of the Great Antilles, the smallest among them, but the first in density of population. It lies between latitudes 17° 50' and 18° 30' N. and longitudes 65° 30' and 67° 15' W., is nearly 1200 miles from the equator, 1000 miles from Havana and Key West, 1500 from New York, and 3000 from Cadiz, Spain. It is roughly rectangular in shape, nearly three times as long as it is broad, the greater axis extending almost directly east and west. Length, about 100 miles; area, 3676 square miles, or about three times that of Rhode Island. It contrasts sharply with the other Great Antilles in appearance, for its mountains are lower and on the whole it presents a hilly and picturesque rather than a mountainous aspect. A number of islands lie off the coast, but only three are of importance, Mona in the west and Vieques and Culebra in the east.

TOPOGRAPHY. The coast line is about 360 miles in length, with comparatively few important indentations. Around the whole periphery of the island are numerous fluvial valleys disposed at right angles to the coast. The coastal plains comprise about one-tenth of the area. There are a few headlands along the coasts, which, however, are usually low, especially on the southern side. They also lack the fringing keys such as border Cuba.

Passing across the island from east to west, a little south of the middle, is a broken irregular range of hills or low mountains which toward the eastern end trend to the northeast and culminate in the peak of El Yunque, 3609 feet high. Elsewhere the range is from 2000 to 3000 feet in altitude, with a few summits over 3000 feet and passes a little below 2000 feet. The range is known by various names in different parts of the island, Cordillera Central, Sierra de Cayey, and Sierra de Luquilla in the northeast. From this backbone of the island the land slopes north and south, its steep hilly surface deeply cut by streams. Toward the coast it becomes more nearly level until it spreads away to the sea edge in broad, level, alluvial, fertile plains.

HYDROGRAPHY. The central range of mountains forms the water parting of the island, most of the streams rising on its slopes and flowing northward or southward. Those flowing north have the longer courses and gentler slopes, and some of them are navigable for several miles by small boats and flat boats. The southern streams are not useful for navigation, and nearly all the Porto Rican rivers have troublesome bars at their mouths. The principal rivers are the Loiza or Rio Grande, Bayamon, Morovis, Plata, Cibueo, Manati, Arecibo, and Blanco, which flow to the north coast; the Culebrinas, Anaseo, Guanajibo, and Mayaguez, flowing to the west; the Portugés, Jacaguas, Coamo, and Guamani, to the south; and the Humacao, Naguabo, and Fajardo to the east. The rivers give great facilities for water and steam power and irrigation. One reason why Porto Rico is more healthful than the other Antilles is because the streams afford such excellent drainage that there is an almost total absence of stagnant water. There are eight small lakes on the north, east, and south slopes of the island.

CLIMATE. Though the island is in the tropics, it is also under the régime of the persistent

PORTO RICO.

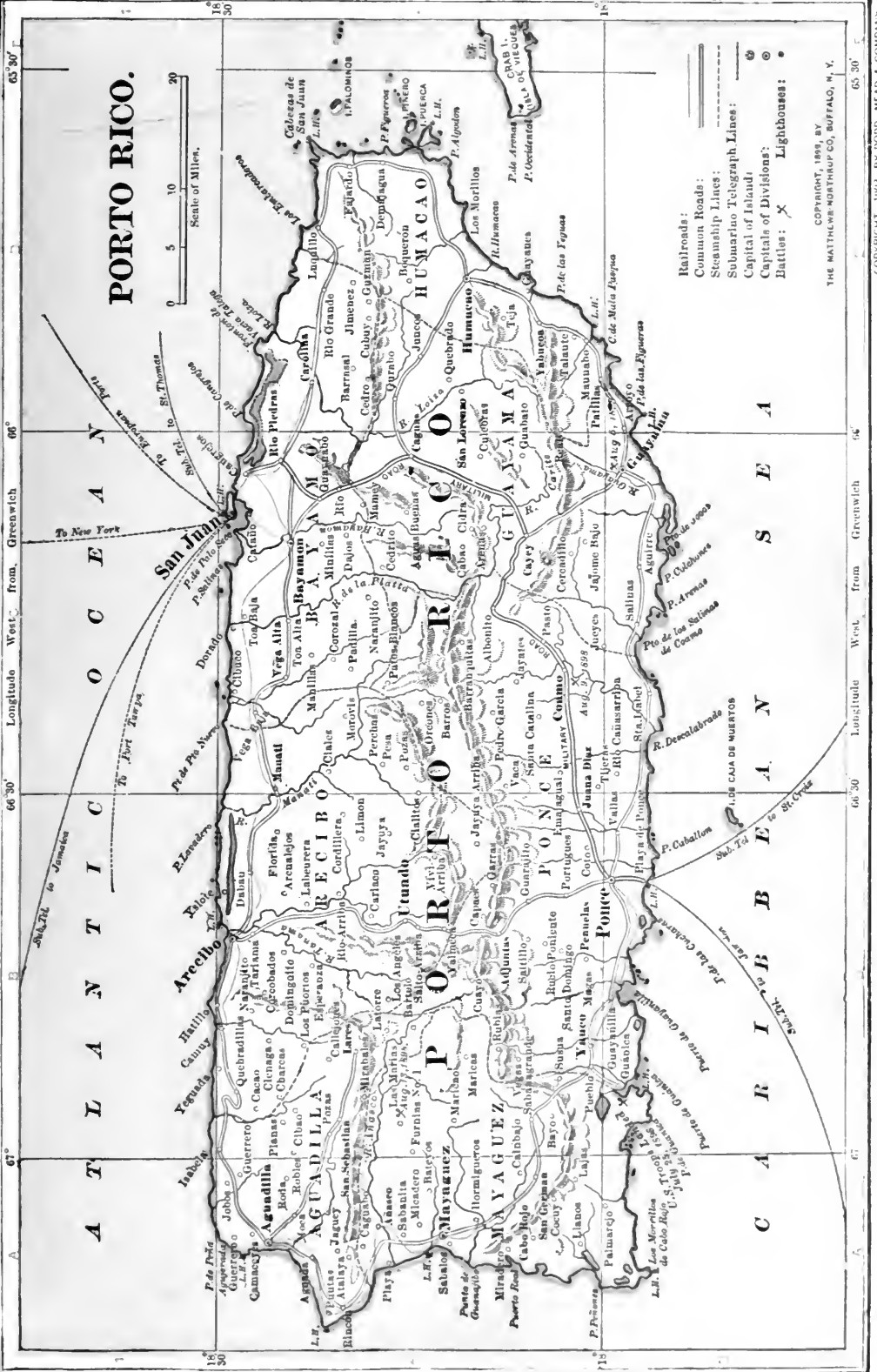

- Railroads:** ———
Common Roads: ———
Steamship Lines: - - - -
Submarine Telegraph Lines: - - - -
Capital of Island: ●
Capitals of Divisions: ○
Battles: ✕
Lighthouses: ●

COPYRIGHT, 1895, BY
 THE MATTHEW-NORTHROP CO., BUFFALO, N. Y.
 COPYRIGHT, 1904, BY DODD, MEAD & COMPANY.

northeast trade winds, which temper the heat. The topography causes local climatic differences and the natives even speak of the 'rigors of winter' in the upper altitudes. The annual range of temperature is from 100°, which is very rare, to 50°, which is sometimes reported among the mountains. The mean annual temperature at San Juan, on the north coast, ranges from 78° to 82°. The climate would seldom be oppressive if it were not for the constant high humidity. Rain falls almost daily, the annual precipitation at San Juan averaging 60 inches. Nearly two-thirds of the precipitation falls in the summer and autumn. The rain increases from San Juan eastward, is heaviest on the highlands, which arrest much of the precipitation, so that the south slope of the island is much drier, and in some regions irrigation is necessary for the cultivation of crops. Among the causes that interfere with agricultural prosperity are hurricanes. Between 1515 and 1899 eighteen very destructive hurricanes occurred. The especially disastrous hurricane which visited the island on Aug. 8, 1899, caused large loss of life and immense damage to crops, and 250,000 persons were compelled for some time to depend upon the Government for food.

Near the ocean the soil is quite sandy; it becomes loamy as it extends inland, and gradually changes from a sandy to a clay loam on ascending the lower foot hills. The soil of most of the coastal plains is rich alluvium, which gradually merges into the clay loam of the hills. The ferruginous clay of the mountains is a source of abundant supply of plant food.

FLORA. The island is famous for the number and size of its trees. The fine forests of the higher region resemble those of other islands of the West Indies, but are almost destitute of parasitic vegetation excepting orchids. The trees include several species of palms, a beautiful tilandsia whose wood, called *sabrino*, is used for timber, a hard wood called *ausubo*, which is much used for the frames of buildings, hard and soft Spanish cedar and ebony, the West Indian sandalwood, the laurel, willow, and many woods useful for construction. About thirty medicinal plants are utilized, twelve plants for condiments, twelve for dyes and tanning, and eight for resins, and many large trees produce edible fruits. The pastures are covered with nutritious grasses.

FAUNA. The native fauna is very limited, there being no large mammals excepting those which are domesticated. There are no noxious reptiles and few insect pests. Flamingos and other water birds abound along the coast; and in the mountains are many birds, including doves. Fish of valuable species are abundant both in the fresh water and along the coasts. The gigantic tortoise is closely allied to the famous large tortoise of the Galápagos Islands.

GEOLOGY AND MINERAL RESOURCES. The island has three geological elements: (1) A central system of deeply ribbed and corrugated mountains with V-shaped gorges and ridges; (2) lower hills along the north and south coasts; (3) coastal plains with alluvial soil extending from the foot of the central mountains across the line of foothills to the sea. The central mountains are formed of volcanic ejecta—tuffs and conglomerates—with occasional dikes and interbedded bluish limestone, which, however, is of rare occurrence. These mountain rocks, which are of

Cretaceous and possibly early Eocene age, are entirely decayed at the surface, breaking down into a red clay resembling that of the southern Appalachians. The foothills are all of later Tertiary and Pleistocene age, and are composed entirely of rocks of sea origin, consisting of the peculiar type of tropical white limestones of a chalky, marly, and shelly nature. The island abounds in clay suitable for ordinary brick and earthenware. Good building sand is found, but little of it is sufficiently pure for glass-making. The white limestones of the coastal plain supply excellent lime. The building stones are volcanic boulders and limestone. Houses made of boulders have a picturesque and rubbled appearance. Those constructed of limestone are always stuccoed, and the most elaborate buildings are made of limestone, including all of the public buildings and fortresses. Beautiful marble of great hardness is quarried near Juana Diaz, but as yet is used only for structural purposes, such as bridge piers. Sandstone is comparatively rare, but fine flagstone is abundant all over the island. Gypsum is used extensively for stucco, plaster, and fertilizer. A large area of the southern coast abounds in phosphates, but the industry has developed only on Mona Island, off the west end of Porto Rico, where it is estimated that there are nearly 500,000 tons of guano and phosphates in the caves already explored. Only about 50,000 tons of these fertilizers have as yet been extracted. Near Ponce and elsewhere numerous caves are filled with rich deposits of guano, which are now being worked. Lignite is found, but the fuel resources have not yet been investigated. Sufficient salt for the needs of the island may easily be obtained from many lagoons near the sea by natural evaporation of the brine. The principal deposits are the salines of Coama, Guanica, and Sierra de Piñones de Cabo Rojo. Invalids resort to a number of mineral springs, chiefly at Ponce and Coamo.

No mining of metals is yet carried on. Those most frequently found are gold, carbonate and sulphide of copper, and magnetic oxide of iron. Since the discovery of the island, gold has been washed in small quantities from many rivers, especially in the north and east. Experience has shown that the placer deposits are not rich or extensive. At one place north of Juncos there is a large deposit of magnetic iron ore.

AGRICULTURE. Sixty-three per cent. of the population is engaged in agriculture. Although the soil is very fertile, the methods of cultivation are crude and primitive. Modern agricultural implements, since the advent of the Americans, are slowly finding their way into the rural districts. The area of the island is 2,347,520 acres, of which only about 20 per cent. is cultivated, 51 per cent. being devoted to pasture, 7 per cent. waste land, and 22 per cent. covered with roads, streams, towns, and forests. Of the cultivated lands, 61,556 acres are in sugar cane, 122,358 acres in coffee, 4222 acres in tobacco, 93,508 in beans, rice, and maize, and 17,176 in fruits. The principal crops are sugar, coffee, and tobacco, whose mean annual production and value for the four years 1898-1901 were: Sugar, 67,582 tons, worth \$4,520,740; coffee, 14,580 tons, worth \$2,916,000; tobacco, 3342 tons, worth \$367,620. Cane-sugar farming requires large capital, and in Porto Rico, where it is at present the most valuable crop, most of the planting is on large estates, with central mills for grinding. Comparatively

few plantations are as yet provided with the best steam machinery for making sugar, and nearly one-half of the cane-grinding machines are worked by oxen. Sugar-growing is chiefly confined to the coastal plain, only a little above the level of the sea, where the lands are alluvial and very rich.

The best coffee is produced between 600 and 2400 feet above the sea. It is grown, therefore, chiefly among the mountains. It has an excellent reputation in over-sea markets. Porto Rican tobacco is also in excellent repute in the markets of Europe and America. The district of Cayey, for the quality of tobacco produced, is in Porto Rico what the Vuelta Abajo is in Cuba. All tropical fruits flourish, and the cultivation of fruits is now receiving great attention. Oranges, pineapples, coconuts, and bananas are increasing in supply. All kinds of vegetables are produced in abundance where care and industry are given to their cultivation. Cotton grows well, but in recent years practically none has been raised. The home market absorbs the entire crop of maize. Nearly all the rice is of the upland variety. More than 1,000,000 acres of pasture land are devoted to or are suitable for stock-feeding. Over 100,000 acres are in very fine grass, much of it of the malojilla variety, which is very productive and highly nutritious. There were in the island, in 1897, 67,751 horses, 4467 mules, 303,612 cattle, and 13,411 swine. Cattle are exported chiefly to the Windward Islands and are of excellent breed. The cows, oxen, and beef cattle compare favorably with those of any other part of America. They are descended from a large number of fine cattle taken to Porto Rico from the Cape Verde Islands about 1840. The horses are small, agile, hardy, work well in harness or under the saddle, and have remarkable endurance.

The small area of the island and its dense population naturally increase the value of land, which is held at high prices. The best sugar lands are valued at \$150 an acre; tobacco lands, from \$60 to \$75 an acre; fruit lands, from \$40 to \$50 an acre; pasture lands, from \$15 to \$20 an acre; and hill lands, suitable for coffee, from \$10 to \$15 an acre. Land along the sandy seashores, where only coconuts are grown, may be purchased for \$5 to \$10 an acre. About 100,000 acres of public land passed to the United States under the Treaty of Paris. Some of it is valuable for agriculture or timber, and other tracts near cities and towns are available for their growth.

MANUFACTURES. Manufacturing industries are chiefly confined to sugar, tobacco, rum, and straw hats. Sugar-making, the largest mills being controlled by American capital, is the leading industry. A small refinery near San Juan rectifies crude petroleum. There are a few tanneries and foundries, and at San Juan matches, ice, soap, and some leather goods are made. Straw-hat braiding has received a large impetus, as the United States is buying many of these products.

COMMERCE. Since the change in the control of the island, the United States has become the chief source of supplies and largest market for native products. The trade with over-sea lands, particularly with the United States, is steadily improving. The imports from the United States in the fiscal year ending July, 1902, were \$10,719,-

444; the imports from foreign lands were \$2,429,004; total imports, \$13,148,448. Flour and bread-stuffs from the United States were bought to the amount of \$1,090,079; rice, to the amount of \$1,803,065; cotton cloths, \$2,060,826; provisions, \$1,336,646; wood manufactures, \$560,081; fish, \$300,703; leather goods, \$234,331; vegetables, \$231,450; mineral oils, \$144,512; paper goods, \$110,222; chemicals and drugs, \$135,896; and malt liquors, \$118,450. The chief imports from foreign countries were codfish from Newfoundland and Canada, \$424,953; preserved meats, \$158,046; soap, \$133,962; besides olive oil, machinery, rice, vegetables, wine, and sawed lumber. The exports to the United States were \$8,297,420; and to foreign countries, \$4,592,505; total exports, \$12,889,925. The chief sales to the United States were: Sugar, \$5,890,087; cigars and cigarettes, \$1,570,938; molasses, \$322,636; straw hats, \$204,555; hides and skins, \$67,888; oranges, \$51,364; and coffee, \$29,188. The principal exports to foreign countries were: Coffee, \$3,168,664; cattle, \$418,268; molasses, \$256,461; and hides and skins, \$13,656. The larger part of the foreign trade is with Spain.

The United States Congress provided in the act creating civil government, approved April 12th, 1900, that when the Legislative Assembly should raise sufficient funds by local taxation to pay the expenses of the government, all tariffs on merchandise passing between the island and the United States should cease. The revenue act passed at the first session of the Legislative Assembly was so successful in operation that the revenues for the fiscal year ending July 1, 1901, surpassed the expenses of government; and on July 25th of that year President McKinley proclaimed free trade between the United States and Porto Rico.

TRANSPORTATION AND COMMUNICATION. In November, December, and January the north coast ports are difficult of access on account of north winds, and from June to November southerly winds endanger the anchorages on the southern coast. The principal ports are San Juan, on the north; Fajardo and Ensenada Honda, on the east; Playa, the port of Ponce, and Guanica, on the south; and Puerto Real de Cabo Rojo, on the west. The island of Vieques has several commodious harbors. A line of steamers plies regularly between New York and Porto Rico. There are also more or less regular communications with Spain, England, South America, and the other West Indies. In the fiscal year 1901-02, 222 American and 295 foreign vessels entered the harbors. Not many years ago the bull cart and pack animal were almost the sole means of inland transportation. These primitive appliances are being supplanted by railroads. The American Railroad Company, which purchased the existing railroad of the French company, is now operating 131 miles of narrow-gauge road along the north coast, and proposes to make it a part of a belt railroad around the island. In 1901 the road carried 149,597 passengers, 76,912 tons of freight, its gross receipts being \$197,000, and the operating expenses \$170,000. Other narrow-gauge railways extend from Cataño, near San Juan, six miles to Bayamon, and from Mayaguez to Añasco, 10.5 miles. There are electric trolley roads in San Juan and Ponce. The Government in four years has completed 87 miles of fine wagon roads at a cost of about \$8000 per

kilometer (.62 of a mile); about 177 miles of good roads were in use when the United States acquired the island. In July, 1902, there were 32 telegraph offices and 600 miles of wire. Two submarine cables connect the island with the outside world, one via Saint Thomas and the other through Kingston, Jamaica.

BANKING. There is only one bank, the Spanish Bank, situated at San Juan, with branches at the principal towns of the island. It has power to issue notes to the extent of three times the amount of its capital, but the present policy of the bank is to curtail the issue of banknotes.

FINANCE. The insular revenues are derived from the customs, internal revenue taxes, postal receipts, a few minor sources of income, and trust funds. The trust funds are derived from revenues collected in the United States on importations from Porto Rico and placed at the disposal of the President to be used for the government and benefit of Porto Rico, for the aid and relief of its people, and for public education, public works, and other public purposes. The total receipts for the year ending June 30, 1902, were \$4,472,192.63. There were derived from customs \$848,258.30; internal revenue, \$1,497,802.63; miscellaneous, \$52,525.22; trust funds, \$1,478,682.08; balance on hand at close of business June 30, 1901, \$563,650.54. The expenditures were: legislative, \$51,430.14; executive, \$1,655,779.23; judicial, \$200,104.66; other disbursements from insular revenues, \$292,128.37; disbursements from trust fund, \$914,281.37; total expenditures, \$3,113,723.77; balance on hand at close of business June 30, 1902, \$1,358,468.86. The municipalities are supported chiefly from taxes on real estate.

WEIGHTS, MEASURES, AND MONEY. Mexican money was current until the end of 1895, when a five-peseta piece was coined and put in circulation. The peseta has now been superseded by the American dollar. The metric system of weights and measures is in use.

POPULATION. The population by the census of 1899 was 953,243, or 264 to a square mile, a density of population about the same as that of New Jersey. The people live chiefly in the rural districts. There are no large cities, the only cities exceeding 25,000 inhabitants being San Juan (32,048) and Ponce (27,952). Mayaguez had a population of 15,187, and Arecibo 8008. There are 8731 more females than males in the island. The census divides the inhabitants into whites, numbering 589,426, or 61.8 per cent.; and colored, numbering 363,817. The classification 'colored' includes a very few Chinese and many persons of mixed white and negro blood, as well as the pure negroes. More than three-fifths of the population are pure white, and nearly two-fifths are partly or entirely negroes. About 84 per cent. of the total colored were returned as mixed blood. Of the whites of Porto Rican birth, 21 years of age and upward, 35,397 could read, and of the colored, 12,576. Under the educational qualification, therefore, the number entitled to vote would be 49,973. About 200,000 persons are employed as laborers in the fields. Though small in weight and stature, their bodies are all bone and sinew, and they have great powers of endurance. The average daily wage of the farm hand is about 35 cents, and the scale of wages can hardly be increased until there is a general rise in the price

of agricultural products. In 1897 the wealth of the island was estimated at \$150,000,000, but the municipal and private mortgage indebtedness was about one-third of the total wealth, and rates of interest are very high.

IMMIGRATION. The immigration laws and regulations of the United States apply to Porto Rico. Of the 1908 persons arriving at San Juan in 1902, 725 were cabin passengers, three-fourths of whom were Spaniards who left the island at the time of the American occupation and are now returning. Most of the immigrants are from the other West Indies, Spain, and South America, a large part being Porto Ricans who left at the time of the American occupation.

EDUCATION. On February 21, 1902, there were 876 schools, with 41,642 pupils and 934 teachers. The number of schools has increased over 80 per cent. since the American occupation. The Porto Ricans predominate among the teachers, 837 teachers being natives of the island. More than half the schools are ungraded rural schools. In the 345 graded schools much attention is given to the study of English. There are also a normal school for the training of teachers and a high school at San Juan. Two-thirds of the text books are in the Spanish language, although wherever practicable the pupils are required to use the English text.

RELIGION. The predominant religion is Roman Catholic, but all faiths have complete toleration. A Protestant church is maintained in Ponce, and a few others in smaller towns. The bishopric of Porto Rico, founded in 1504, was the first to be established in the New World.

GOVERNMENT. After the cession of Porto Rico to the United States the island was governed chiefly by the military authorities under the direction of the President of the United States until May 1, 1900, when the scheme of government prepared by Congress went into effect. Shortly after the transfer of the island to the United States, the President appointed a commission to investigate conditions in Porto Rico and draft a code of laws for the island. It recommended a separation of Church and State in the island, an improved system of taxation, a revised tariff schedule, the establishment of a public school system, and the encouragement of industrial enterprise by the grant of liberal charters. About the same time the civil government of the island was reorganized by order of General Davis. Bureaus of State, of internal revenue, and of agriculture were created and placed under the management of natives, subject to the supervision of the civil secretary to the Military Governor. An advisory board, known as the Board of Insular Policy, consisting of nine members, was created. At the same time the judicial system was reorganized and the island divided into five judicial districts under the jurisdiction of a Supreme Court at San Juan. By act of April 12, 1900, Congress provided a civil government for the island, but did not raise it to the status of a Territory, nor extend the Constitution and laws of the United States thereto. The inhabitants of the island were declared to be "citizens of Porto Rico and as such entitled to the protection of the United States." The form of government provided consists of a Governor appointed by the President by and with the advice and consent of the Senate, at an annual salary of \$8000; an executive council of eleven members, five of whom

must be natives of Porto Rico, appointed in the same manner as the Governor; and a legislature, consisting of the Council as an upper chamber and a House of Delegates popularly elected for a term of two years. There is a small property qualification and a low educational test for the exercise of the suffrage. The judges of the Supreme and District courts are appointed by the President. There are also a treasurer, a commissioner of education, and an attorney-general, appointed in the same manner. The island is represented in Washington by a resident commissioner, although he has no seat in Congress. In 1902 comprehensive codes of law and of legal procedure for the island were prepared by a commission representing native Porto Ricans and Americans. By these the Spanish law and procedure are partly supplemented and partly superseded by the American system of jurisprudence. Public order throughout the island is maintained by an insular police force of 670 men. The capital is San Juan.

HISTORY. The island of Porto Rico has from the beginning played a secondary part in the history of the West Indies. Overlooked by Columbus on his return from Hispaniola or Haiti in the spring of 1493, its southern shores were coasted by him on his second voyage in the winter of that year, when he gave it the name of San Juan Bautista. In 1508 Juan Ponce de Leon crossed the Mona channel from Hispaniola to investigate the reports of a rich and fruitful land in the island of San Juan. He was hospitably entertained by the native chief Agueyuada, whose power seems to have extended over most of the island. Two years later, having secured authority to conquer and govern the island, Ponce de Leon returned thither with a large military force. He followed the northern coast till he discovered the spacious bay on which he established his headquarters, founding a city which he named San Juan Bautista de Puerto Rico, whence comes the modern name for the whole island. Juan Ponce devoted himself for ten years, except during his first expedition to Florida, to the pacification of the island and the extirpation of the hostile Caribs from the islands toward the southeast. After his death in 1521, successive Spanish administrators continued to rule the island, which had a peaceful, uneventful history for nearly two hundred years. Under the repartimiento system, by which the Indians were forced to work on the Spanish plantations, the natives gradually decreased in numbers, and the consequent dearth of laborers resulted in the abandonment of many of the outlying estates. The Caribs in turn reentered the island and occupied largely the eastern portions, so that for many years the Spaniards appear to have been restricted to the districts immediately dependent upon San Juan, Ponce, and one or two other towns. The corsairs and West Indian pirates also visited the island, using various places on the coast for more or less temporary headquarters. In 1595 Drake, after trying to induce the inhabitants to ransom the town with money which they did not possess, sacked San Juan, and three years later it again suffered similarly from the Duke of Cumberland. Heinrich, a Dutch sea captain, undertook to do the same thing in 1615, but was beaten off, losing his life in the assault. About the middle of the eighteenth century negro slaves and colonists

from Spain began to be introduced in considerable numbers, and by 1780 the population had risen to nearly eighty thousand. In 1797 San Juan successfully withstood a three days' attack from the English under Lord Abercrombie. During the first quarter of the eighteenth century the island became a popular resort for large numbers of those who desired to escape from the turmoil and disaster incident to the revolutionary movements in South America. As a result, the population came to have a large preponderance of whites over the black and colored elements. Another consequence was the marked aversion of the populace to strife of any sort. An attempted rising against Spain in 1820 made headway for two or three years, but had no strong popular support. In 1867 another revolt was attempted by those who were engaged in the plots to free Cuba, but this was speedily suppressed. In 1869 Porto Rico was created a province of Spain, with representation in the Spanish Cortes by delegates elected by popular vote under the same suffrage as in Spain. The Governor-General was made the resident representative of the Crown, and in practice all administrative power was in his hands. In 1873 the Spanish Cortes passed an act for the abolition of slavery in Porto Rico. During the Spanish-American War the fortifications of San Juan were bombarded by a fleet under Admiral Sampson. On July 20, 1898, an expedition under General Miles landed on the island. Ponce surrendered on the 28th, and the American forces met with no effectual resistance until hostilities were terminated by the peace protocol of August 12th. On October 18th the United States flag was raised over San Juan. By the Treaty of Paris, signed December 10, 1898, Porto Rico was ceded to the United States. Following the establishment of a civil government in 1900, elections were held for the choice of a commissioner to Washington and members to the House of Delegates of the Porto Rican Legislature. With the beginning of representative government party lines were sharply drawn, the Republican and Democratic parties in the United States becoming the models for similar organization in the island.

BIBLIOGRAPHY. Hill, *Cuba and Porto Rico* (New York, 1898); Davis, *The Cuban and Porto Rican Campaigns* (London, 1899); Dinwiddie, *Porto Rico, Its Conditions and Possibilities* (New York, 1899); Morris, *Our Island Empire* (Philadelphia, 1899); Hamm, *Porto Rico and the West Indies* (New York, 1899); Carroll, *Report on the Island of Porto Rico* (Washington, 1899); Ober, *Puerto Rico and Its Resources* (New York, 1899); Robinson, *The Porto Rico of To-day* (New York, 1899); Fiske, *History of the Islands of the West Indian Archipelago* (New York, 1899); Griffin, *List of Books on Porto Rico* (Washington, 1901).

PORTO SANTO, sän'tò. One of the Madeira Islands (q.v.).

PORTO TORRES, tór'rás. A seaport in Sardinia. See SASSARI.

PORTOVIEJO, pòr'tò-vvā'hò. The capital town of the Province of Manabí, Ecuador, 98 miles north of Guayaquil (Map: Ecuador, A 4). It is an old town with narrow streets. Its chief manufacture is that of straw hats. Portoviejo was first founded in 1534, but was several times

taken and burned by pirates. Its population is reported to be about 10,000.

PORT PHIL'IP. The harbor of Melbourne (q.v.), Australia.

PORTRAITURE. In the fine arts the representation, by means of painting, sculpture, or engraving, of the appearance of an individual or a group of persons. As regards size portraits may be busts, half figure, three-quarter or full length; as regards the position of the countenance, they are full face, half profile, profile or *profil perdu*, if the face is further reversed. Portraiture is of very ancient origin. Sepulchral statues of the earliest Egyptian empire show that the art was even then highly developed. During the best period of Greek art, ideal portraits of individuals, of a certain likeness, but rather intended to represent character types, were frequently executed, both in statues and in busts, as may be seen from the most celebrated surviving examples, the Lateran "Sophocles" and the bust of Pericles in the British Museum. Realism does not enter portraiture till the age of Lysippus, who was especially celebrated for his portraits of Alexander the Great, copies of which survive in the well-known busts in the principal European museums. At the same time portraiture was first practiced in painting by Apelles, also celebrated for his likenesses of Alexander. The only surviving portrait paintings of Greek art are those recently discovered in the Fayyum, of Græco-Egyptian workmanship, and dating from the second century a.d.

The realistic tendencies of the Etruscan Art were favorable to portraiture, especially in bronze, the material in which the Etruscans excelled; a good example is the bust of Brutus in the Capitoline Museum at Rome. Their art had a strong influence upon the Roman, which was, however, even more influenced by Greece in the development of portraiture, which became the most characteristic form of Roman sculpture. As with the Greeks, the body was portrayed as a type, in the ideal fashion, the resemblance to the individual being confined to the face. Costumes and insignia were portrayed in the most elaborate fashion. Busts were especially popular, and it became quite the fashion to collect them. (See **BUSTS**.) Beginning with the empire portraiture flourished at Rome until about the beginning of the third century, and about the time of Justinian, in the sixth century, it sank into disuse. A very common form of portraiture under the empire was upon ivory diptychs, which Roman, civil, and ecclesiastical officials distributed among their friends. This practice was continued by the Byzantines, who also used mosaics for portraiture, as may be seen in the celebrated examples of Justinian and Theodora in San Vitale, Ravenna.

The chief use of portraiture during the middle age was for sepulchral figures, which were portrayed recumbent, seated, or kneeling. Attempts at portraiture are often apparent in the faces of the statues of the Gothic cathedrals in France, and in the thirteenth century it attained a splendid development in the statues of donors, erected in German cathedrals of the transitional period, as at Naumburg and Bamberg. These likenesses were of an ideal character, but a more realistic portraiture was practiced in the latter fourteenth century, especially by the Netherlandish school, with centre at Dijon. The chief master

was Claux Sluter, and the statues produced were the most realistic portraits imaginable. This sculpture had, in turn, a marked influence upon contemporary painting in the Netherlands. The work of Jan van Eyck and his school, of the fourteenth century was highly characteristic and naturalistic, and most detailed in finish.

In so naturalistic an age as the early Renaissance, portraiture flourished to a high degree. It was first practiced at Florence by the sculptors, Donatello having revived the art in the form in his busts, which unite excellent characterization with an admirable naturalism, tempered by the antique. The art was continued by Desiderio da Settignano and Mino da Fiesole, and with high success in bronzes by Verocchio. It was not practiced the first half of the fifteenth century by the painters of Florence, but during the latter half Botticelli, Ghirlandajo, Pollaiuolo, and others attained high success. It was, however, reserved for the fifteenth century to unite with realism and subjective conception an ideal rendering of the subject, which made the portrait typical in the highest sense. This success was attained by most of the chief masters of the Renaissance, such as Leonardo, Andrea del Sarto, Raphael, and Lorenzo Lotto; among the Venetians by Giorgione, Palma Vecchio, Titian, Tintoretto, and by Morone of Brescia. During the same period the Germans practiced portraiture of quite a different type, less refined in form and more careful in detail, but with strong characterization in the work of men like Dürer, and with a perfect, objective realism in that of Holbein, who was chiefly active as a portrait painter in England.

Since the sixteenth century portraiture has found its chief expression in painting. Even during the decline of the Italian and other schools, portraiture remained comparatively good, because in it the artist is compelled to adhere to nature. With the great development of painting in the seventeenth century portraiture assumed a new importance, especially in the schools which attained the highest development, namely those of the Netherlands and of Spain. In Holland Rembrandt, by the skillful manipulation of light and shade and by skillful coloring, achieved highly realistic and characteristic results. Frans Hals, whose activity was confined to portrait painting, portrayed his figures in full light, and with genial observation; while Van der Helst and many others did good work in portraiture. This school developed the group picture, and heightened the effect of the portrait by an appropriate background. The work of the Flemish school represents a modification of the purely realistic conception by Italian refinement of color. Rubens's portraits were of wonderful strength and characterization, while Van Dyke's were of a more refined and courtly character. In Spain portraiture attained the highest possible development in the works of Velasquez, who with the subtle intellectual observation and the highest technique portrayed the Spanish grandees from the standpoint of absolute realism. During the same period portraiture of good, though a more artificial character, was practiced by the Eclectic schools, in Italy, and by the courtly painters of France.

Although the eighteenth century was an age of decline in painting, portraiture found in France a characteristic, realistic expression in the works

of the sculptors, like Houdon, and in the work of the great portrait-engravers like Nanteuil and Edelinck. In England an art of a realistic character flourished in the portraits of Reynolds, Gainsborough, Lawrence, and in those of Raeburn in Scotland. Portraiture has always been greatly in demand in England in aristocratic and court circles, and the greatest painters there have usually been portraitists.

During the nineteenth century the demand for portraits by no means decreased, and nearly all of the great figure painters have also been portraitists. In France Classicists, Realists, and Impressionists, have all contributed their quota to the evolution of the portrait, and to mention the names of those who have done good portraiture would be to enumerate the great figure painters of France. In the opinion of modern critics the portraits of classicists like David, Gerard, and Ingres are their very best work; at the present day Bonnat, Carolus Duran, and Benjamin-Constant are most universally known. In Germany portraiture has been less productive, but Lenbach, whose coloristic work is based upon that of the old masters, has done some of the best portraiture of the century. During the last half of the nineteenth century England has produced a series of good portrait painters in Millais, Herkomer, G. F. Watts, and Orehardson. English sculpture (q.v.) has succeeded best in portraiture while in France the portrait work of men like Rodin and Falguière is the very highest of its kind. Portraiture in medallions, which even at the time of the Renaissance, was prominent in French art, has achieved a very high development in the nineteenth century in the work of David d'Angers, Roty, Chaplain, Vernon.

The earliest American portraitists of the colonial and revolutionary periods like Copley, Trumbull, and Sully, resemble contemporary English painters in their eclectic manner, except Gilbert Stewart, who occasionally did work of a high order. Men of the middle period (see PAINTING) were Harding, Healy, Huntington, and Page and Eastman Johnston. In recent years America has produced a number of portraitists of exceptional ability, trained, for the most part, in France. Whistler's refined likenesses may be compared to those of Velasquez; Sargeant, brilliant, modern, and realistic, will bear comparison with any living portraitist; and among many others doing excellent work may be mentioned Chase, Melchers, and Cecilia Beaux. Portrait statuary has achieved equally great results in the works of Saint Gordon, McMonnies, Bartlett, and others. See BUSTS for the development of this important branch of sculpture.

BIBLIOGRAPHY. For antique portraiture consult the articles referred to under ICONOGRAPHY. See also Von Seidlitz, *Allgemeine geschichtliche Porträtwerke* (Munich, 1895); and the works of Marquet de Vasselot (Paris, 1880), and Pinset and d'Auriaac (ib., 1884) entitled *Histoire du portrait en France*.

PORTREEV'. The seaport and chief town of Skye Island, Inverness, Scotland. See SKYE.

PORTREEVE (AS. *portgerēfa*, from *port*, port + *gerēfa*, reeve, probably from *ge-*, generalizing prefix + **rōf*, OHG. *ruora*, Icel. *rōf*, number, or from *rōf*, famous, Goth. *hrōps*, OIIG. *ruof*, Ger. *Ruf*, outcry, AS. *hrōpan*, to cry out). The principal magistrate in a maritime town. The

chief officer under the Saxons in London was called the Portreeve, and the early mayors of that city and elsewhere were so designated, but the word gradually came in time to mean a chief magistrate and sheriff of a port, whose duties were to represent the Crown, preserve order, and collect the revenues. The term is still used in certain parts of England to designate a port warden.

PORT REPUBLICAIN, pōr rá'pu'blé'kán'. The capital of Haiti. See PORT-AU-PRINCE.

PORT ROYAL. A British naval station on the West Indian island of Jamaica, situated on a sandy spit at the entrance to Kingston harbor (Map: Cuba J 9). It is the principal station of the British naval forces in the Caribbean, and contains an arsenal, barracks, and a military hospital. The old Port Royal, which before its destruction by earthquake in 1693 was one of the chief towns of the West Indies, stood near the site of the present town.

PORT ROYAL. A village in Beaufort County, S. C., the terminus of the Port Royal and Augusta Railroad. Population, in 1900, 601. In this vicinity, in 1664, Captain Ribault, at the head of a company of French Huguenots, built a fort, which, in the following year, was taken by a force of Spaniards under Menendez, who massacred all the garrison; and in 1686 Lord Cardross founded a town, which was almost immediately broken up by the Spaniards. At the outbreak of the Civil War the entrance to Port Royal Sound, some distance below the town, was fortified by the Confederates, Fort Beauregard being built north of the entrance and Fort Walker south of it. Against these fortifications a strong Federal squadron, consisting of two frigates, three sloops, and seven gunboats, all under Captain (later Rear-Admiral) Du Pont, was sent late in 1861, and on November 7th the forts were captured and the harbor secured. The Confederate forces at this point were commanded by Gen. Thomas F. Drayton. The Federal loss in killed and wounded was about 30, that of the Confederates about 50. Consult Johnson and Buel (eds.), *Battles and Leaders of the Civil War*, vol. i (New York, 1887).

PORT-ROYAL-DES-CHAMPS, pōr rwá'yál' dá-shän'. A convent of the Cistercian or Bernardine nuns, near Versailles, which obtained much celebrity during the seventeenth century as a centre of Jansenism. It was founded by the wife of Mathieu de Montmorency in 1204 and soon after its establishment obtained from the Pope the privilege of receiving lay persons who, without taking monastic vows, desired to live in religious retirement. This feature of the Port-Royal rule became later of great importance. The discipline of the convent was much relaxed in the fifteenth and sixteenth centuries, and the superior was appointed from worldly or political motives. In 1602 Angélique Arnauld, sister of the celebrated brothers Arnauld, was appointed, when a child, coadjutrix of the abbess, whom she succeeded at the age of eleven. As the new abbess advanced in years, she undertook a reformation of the community in all its details—demanding a strict observance of religious poverty, abstinence from meat, complete seclusion, and the most severe ascetic exercises. The community removed to Paris in 1626, and in 1633 obtained a new convent, which

was thenceforward called Port-Royal-de-Paris; and from this time the old establishment of Port-Royal-des-Champs was the home of a lay community in accordance with the original Papal privilege. This community became very celebrated, and numbered among its inmates some of the most distinguished scholars of the time, Arnauld d'Andilly, the three brothers le Maistre (Antoine, Louis Isaac de Sacy, and Simon de Sérécourt), Nicole, Lancelot, and several others. The name of Pascal was closely associated with Port-Royal. The rule of life of the Port-Royalists was austere and they devoted many hours to prayer, spiritual reading, instruction, and manual labor. They prepared for these schools the well-known text-books of the Port-Royal series, such as Greek and Latin grammars, works on general grammar, geometry, and logic.

In 1643, inspired by profound love for children, the Port-Royalists founded the Little Schools, first at Port-Royal and then in Paris, in which they received a small number of pupils. The study of the vernacular was strongly emphasized in these schools, the general aim being to develop the reason, judgment, and power of personal reflection rather than a mastery of Latin. For the first time in the history of French education, the study of French received careful consideration. In teaching pronunciation and spelling they almost approached the modern phonetic method. The schools had but a short existence and embraced but a limited sphere, but the principles laid down had a salutary influence on education in France throughout the succeeding centuries.

Greater importance for the time was given to the community by its pertinacious adherence to the Jansenist views (see JANSENISM), and by the number of polemical works which issued from Port-Royal. The nuns having refused to subscribe the formula condemning the five propositions of Jansenius, a royal order was issued in 1660 for the suppression of the school and the removal of the boarders, and the abbess and several other nuns were arrested and confined as prisoners in other monasteries. After the "peace of Clement IX.," they were permitted to return; but the two communities, Port-Royal-des-Champs and Port-Royal-de-Paris, were placed under separate government. This led to many disputes, and to a continued adherence at Port-Royal-des-Champs to the Jansenist spirit and opinions; and when the final steps for the repression of the Jansenists were taken in 1705 and the following years, a formal bull was issued by Pope Clement XI. for the suppression of the old convent and the transfer of its property to Port-Royal-de-Paris. In 1709 the nuns were finally dispersed and distributed among convents of different Orders throughout France. The property of the convent and church was transferred to the Paris house, and all the buildings of Port-Royal-des-Champs were leveled to the ground, by order of the King. See Sainte-Beuve, *Port-Royal* (5th ed., 7 vols., Paris, 1887); Racine, *Histoire abrégée de Port-Royal* (Paris, 1742; new ed., 1865); Beard, *Port-Royal* (2 vols., London, 1861); Cadet, *L'éducation à Port-Royal* (Paris, 1887); Ricard, *Les premiers Jansénistes et Port-Royal* (ib., 1883).

PORT SAID, *sâ-âil'*. A seaport of Egypt, situated at the Mediterranean end of the Suez Canal

(Map: Egypt, F 1). It has frame houses. Its harbor, with colossal piers of concrete, has ample docks and accommodations for vessels. There is a lofty lighthouse. Port Said has an export trade in cotton, and is an important coaling station. It is the seat of the Governor-General for the Suez Canal. The town dates from 1859, when work on the canal was begun. Population, 37,000, of whom about one-third are Europeans.

PORTSMOUTH, *pôrts'mûth*. A seaport and the chief naval arsenal of Great Britain, situated in Hampshire, on the southwest shore of Portsea Island, 74 miles southwest of London (Map: England, E 6). Portsmouth has the most complete fortifications in Britain. These comprise, on the landward side, the outer line of the Portsdown forts and the Hilsa lines; to seaward, the Spithead forts.

Southsea, which is situated outside the walls skirting Southsea Common, is rapidly increasing, and is a fashionable watering-place. Pleasing views may be had, from the ramparts and batteries, of the harbor, the roadstead of Spithead, and the Isle of Wight. The town itself is uninteresting; among the few notable buildings is the Church of Saint Thomas, the chancel and transepts of which date from the twelfth century. Besides the parish, the municipal and Parliamentary limits include Portsea, Landport, and Southsea. The town of Gosport (q.v.) is separated from Portsmouth by the harbor entrance. Portsmouth harbor, about 420 yards wide at its entrance, extends inland for about four miles and has a breadth of three miles along its northern shore. The outward entrance is defended by Monkton Fort and Southsea Castle. The harbor is situated close to the magnificent anchorage of Spithead, where 1000 ships of the line may ride without inconvenience, under shelter of the Isle of Wight, and opposite the French arsenal of Cherbourg. The dockyard has an area of 293 acres. Of this immense naval establishment, the most noteworthy features are the dry docks, spacious enough to admit the largest vessels.

The local trade of Portsmouth is supported mainly by the Government dockyard and other public establishments. Brewing is carried on, and there is considerable traffic in timber, coal, cattle, and agricultural produce. The importance of the port dates from the reign of King Henry VIII. Its defenses were strengthened by Elizabeth and by William III. The municipality holds various charters, the first granted by Richard I. Its principal asset is its docks. It owns an electric lighting plant, and tramways, and maintains public baths, cemeteries, libraries, and a technical school. Porchester Castle, a ruined Norman fortress to the north of the harbor, occupies the site of the Roman *Portus Magnus*. The town was burned by the French in 1372. In 1642 it was taken by the Parliamentarians. In 1782 the *Royal George* sank in the harbor with a loss of nearly 1000 lives. Portsmouth is the birthplace of Charles Dickens and George Meredith. Population, in 1891, 159,000; in 1901, 189,000. Consult Saunders, *Annals of Portsmouth* (London, 1880).

PORTSMOUTH. A city and one of the county-seats of Rockingham County, N. H., 58 miles north-northeast of Boston; on the Piscataqua River, about three miles from the Atlantic Ocean,

and on the Boston and Maine Railroad (Map: New Hampshire, L 9). It is a port of entry and the only seaport in the State, situated on a peninsula overlooking the harbor, which is deep and commodious, fortified, and dotted with islands that make the site of the city one of great picturesqueness. On one of the islands, formerly called Fernald's Island, is the United States navy-yard, the place of construction of such famous vessels as the *Ranger* and the *Kearsarge*. Many of the islands in this vicinity, particularly the Isles of Shoals, are noted summer resorts. Portsmouth itself is a well-known resort, attractive for its fine situation and for the historic interest of its colonial mansions, several of which are still standing. It is also closely connected with the popular watering places of the coast.

There are three parks: Goodwin, Langdon, and Haven. Among the edifices of note are the old residences of Governors Wentworth and Langdon, Saint John's Church, the Federal Government building, and the Portsmouth Athenaeum, with a museum and a library of 24,000 volumes. The city has also a public library, containing more than 16,000 volumes, and several charitable institutions. Portsmouth is of considerable importance as a manufacturing centre, its establishments including a large shoe factory, several breweries, a shoe-button factory, and manufactories of button-sewing machines, locks, boot and shoe heels, and marble and granite. The government, under a revised charter of 1895, is vested in a mayor, annually elected, a bicameral council, and in administrative officers, among whom the police commissioners are appointed by the State Governor. The water-works are owned and operated by the municipality. Population, in 1890, 9827; in 1900, 10,637.

Portsmouth was settled in 1623 by the Laconia Company, headed by Sir Ferdinando Gorges and Captain Mason, and for many years was known as Strawberry-Bank. Before New Hampshire was organized in 1679, Portsmouth lay within the limits of Massachusetts. It was incorporated as a town and named Portsmouth in 1653, and in 1849 it was chartered as a city. Until 1807 it was the capital of the State.

PORTSMOUTH. A city and the county-seat of Scioto County, O., 100 miles east-southeast of Cincinnati and equally distant to the south from Columbus; at the junction of the Ohio and Scioto rivers, and the terminus of the Ohio Canal, and on the Baltimore and Ohio Southwestern, the Norfolk and Western, and the Chesapeake and Ohio railroads (Map: Ohio, D 8). Several steamboat lines add to the transportation facilities. Situated on a plain in a productive agricultural section with considerable mineral wealth, the city is an important industrial and commercial centre. It has a public library and the Hamilton Peebles Reading Room, a City Hospital, and homes for old ladies and children. There are several attractive parks: Grandview, Millbrook, Tracy, York, and Athletic. The Scioto Valley is famous among archæologists for the many remains of the Mound Builders.

The manufacturing interests of Portsmouth are developing rapidly, its various industries, in the census year 1900, having invested capital to the amount of \$4,114,000 and products aggregating in value \$7,533,000. There are shoe fac-

ories, fire-brick, paving and building brick plants, stove and range works, car shops, planing mills, foundries and machine shops, furniture and veneering factories, hub and spoke works, stone saw mills, rolling mills, paper box factories, a brewery, and a distilling and rectifying plant. The government is administered by a mayor, elected every two years, and a unicameral council. Most of the subordinate officials are appointed by the mayor and confirmed by the council, or elected by that body. The following important officers, however, are chosen by popular vote: the board of public service, having in charge the business management of the city; city solicitor, city auditor, city treasurer, members of the school board, ward assessors, and justices of the peace. The water-works and electric light plant are owned by the municipality. Portsmouth was settled in 1803, and was incorporated in 1814. Population, in 1890, 12,394; in 1900, 17,870.

PORTSMOUTH. A city and the county-seat of Norfolk County, Va., on the Elizabeth River, opposite Norfolk, with which it is connected by ferry (Map: Virginia, H 5). The two cities, with Berkley constituting in reality a single municipality, possess a fine harbor and good transportation facilities. The Seaboard Air Line terminates in Portsmouth. The Atlantic Coast Line and the Southern Railway have depots here, and all other roads that enter Norfolk, except the Norfolk and Western, maintain connections with the city. The customs district of Norfolk and Portsmouth in 1901 ranked ninth among Atlantic coast ports in the value of its foreign commerce, aggregating over \$10,902,000. See NORFOLK.

Portsmouth, in contrast with Norfolk, is regularly laid out, and is the home of many business men of the greater city. Its chief features include the United States Navy Yard, situated in the southern part of the city, which has two large dry docks and a plant for the construction of steel vessels, and the United States Naval Hospital and park in the northern portion of the city. There are in Portsmouth extensive cotton mills and other manufactories, and railroad shops of the Seaboard Air Line. The government, under a revised charter of 1893, is vested in a mayor, elected every four years, and a bicameral council, and in administrative officers, among whom the members of the school and health boards are chosen by the city council. Settled in 1752, Portsmouth was chartered as a city in 1858. Trinity Episcopal Church here was first built in 1762. Before the Revolutionary War, the British operated a ship-yard on the site of the present navy-yard. Population, in 1890, 13,268; in 1900, 17,427.

PORT TAMPA CITY. A town in Hillsboro County, Fla., 9 miles south of Tampa, on Tampa Bay (Map: Florida, F 4). It is the southern terminus of the Atlantic Coast Line Railroad, which here connects with steamers for Havana, Key West, Mobile, and other points; and has excellent harbor facilities. The town is the centre of a fertile region, producing large quantities of oranges, pineapples, and vegetables, and is the shipping port of Tampa (q.v.). It also has some reputation as a health resort. Port Tampa City was settled in 1889 and was incorporated four years later. It was the place of embarkation of the Santiago expedition in the Spanish-American war. Population, in 1900, 1367.

PORT TOWNSEND. A city and the county-seat of Jefferson County, Wash., 35 miles north by west of Seattle, on Port Townsend Bay, at the entrance to Puget Sound. It has steamship connection with Alaska, San Francisco, and various ports of the Orient (Map: Washington, C 1). The Port Townsend Southern Railroad and a branch of the Northern Pacific, which are under course of construction, will add greatly to the commercial importance of the city. The harbor is one of the largest in the world, and is protected by three forts, equipped with the most modern guns. The city is favored with a fairly equable climate, owing to the influence of the Japan Current, and is surrounded by picturesque mountain scenery. It is well laid out, and has fine business blocks and public buildings, and attractive residences. Among the noteworthy edifices are the United States Custom House, county court-house, city hall, high school building, United States Marine Hospital, Saint John's Hospital, the sanatorium, and the buildings of the United States Quarantine Station. A public library is maintained by the city.

The neighboring region is engaged in lumbering, dairy farming, and fruit-growing, and also has considerable oil and mineral wealth. Port Townsend is a port of entry for the Puget Sound customs district, the trade of which in 1902 was valued at \$47,478,000, including exports to the amount of \$34,726,000. Lumber, grain, farm and dairy products, live stock, fish, and oil are the chief articles of commerce. The industrial establishments comprise steam boiler works, a machine shop, saw and planing mills, a ship-yard, salmon and sardine canneries, herring pickling and curing works, bottling works, etc. The Irondale furnaces on Port Townsend Bay are noted for their extensive production of pig iron, the iron used in the construction of the cruisers *Charleston* and *San Francisco* and the battleship *Oregon* having been made here. Under the charter of 1890, the government is administered by a mayor, chosen annually, and a unicameral council. Port Townsend was settled in 1851, and was incorporated in 1860. Population, in 1890, 4558; in 1900, 3443.

PORTUGAL. One of the smaller States of Europe, occupying most of the western part of the Iberian or Pyrenean Peninsula. Comprised between the parallels of 37° and 42° N. and the meridians of 6° 15' and 9° 30' W., it has a continental area of 34,528 square miles, a little larger than Maine. The Azores and Madeira Islands, classed as an integral part of the kingdom, have an area of 1510 square miles, making the total area of the kingdom 36,038 square miles. The colonial possessions are nearly 22 times as large as the kingdom. Portugal is bounded on the north and east by Spain and on the south and west by the Atlantic Ocean. It extends about 350 miles from north to south and an average width of about 100 miles from east to west. No country is better provided with natural boundaries. Rivers or mountain ramparts separate it from Spain. The Minho, Douro, Tagus (Tejo), and Guadiana, flowing in deep valleys, form boundaries in parts of their courses. Portugal may almost be said to have a climatic boundary. The limit of rains brought by the westerly winds from the Atlantic coincides very nearly with the political boundary. On the side of Portugal are a humid atmosphere, copious rains, and luxuri-

ant vegetation. On the side of Spain are cloudless skies, a thirsty soil, and treeless plains.

TOPOGRAPHY. The kingdom occupies the greater part of the Atlantic slope of the great peninsular tableland. The country has a coast line of nearly 465 miles. The harbors are relatively numerous, though those in the north are obstructed by sand bars. The most important are those of Lisbon, in the widened estuary of the Tagus; Oporto, on the Douro, near its mouth; and Setubal (the famous salt port), at the head of Setubal Bay. Lagos, founded by the Carthaginians, and Villa Nova, both on the south coast; Buarcos and Figueira, at the mouth of the Mondego; and the roadstead of Leixoes near Oporto, where an artificial harbor has been built, are smaller ports. It was partly due to the superior situation of the ports for intercourse with West Africa and South America that Portugal stood in the forefront of over-sea enterprises in the greatest era of geographic discovery.

A large part of the interior is filled with mountains. The country north of the Tagus is most mountainous and elevated. Of the three great mountain systems the fine Serra do Gerez of the north is the western extremity of the Pyrenean system, and the magnificent Serra da Estrella, between the Douro and Tagus, is the western prolongation of the great central range of Spain. They have many offshoots and foothills and the Estrella range traverses the great plain of the Province of Beira. The Tagus divides Portugal into two portions, which differ much in appearance, climate, and soil. North of the Tagus are imposing mountain chains, transverse hill ranges, beautiful and fertile valleys; but south of the river the mountains rarely assume the aspect of ranges and do not rise high above the surrounding plateau. Thus Southern Portugal is the least attractive part of the kingdom—a succession of plains, hills, thinly wooded lands, and sandy coastal tracts. It includes, however, the third conspicuous orographic system of the kingdom, the Serra de São Mamede, on the border between Portugal and Spain.

HYDROGRAPHY. The principal rivers have their origin in Spain, the only important river entirely possessed by the Portuguese being the Mondego, which waters a fertile valley, but is useless for commerce. The rivers Minho, Douro, Tagus, and Guadiana are generally navigable as far as the Spanish frontier and in the lower part of their courses even for large vessels. The Tagus is deep enough for seagoing ships for 90 miles, and the Douro as far as Oporto. While the rivers are very important in the communications of the country, they have not yet been effectively regulated for purposes of navigation. The Minho River forms part of the northern boundary between Spain and Portugal; its valley is very fertile, and its salmon and lamprey fisheries are important. The Douro irrigates the vine regions which produce the famous port wine exported from Oporto. The lower Tagus crosses plains of great fertility and widens at Lisbon to a great basin, one of the largest and finest harbors in the world.

CLIMATE. The climate is oceanic except in the eastern districts. High degrees of temperature are registered only in the south, and, owing to the neighborhood of the sea, the climate may generally be described as temperate. North of the Douro the mean annual temperature is 50° F.,

between the Tagus and Douro about 60°, and in the Guadiana Valley 65°. Lisbon has a mean temperature in January of 50° and in July of 69.8°. The precipitation at Lisbon is about 40 inches a year, and Coimbra, the most populous town between Oporto and Lisbon, is the rainiest place in Europe, the clouds parting with their moisture against the sides of the surrounding mountains, where as much as 192 inches of rain have fallen in a year. On the whole, the soils are not rich, for there are wide expanses of sandy and thin soils; some of the valleys and plains, however, are extremely fertile.

FLORA. The vegetation, which is that of Central and Southern Europe, is practically identical with the flora of Spain. The kind of vegetation is denoted by the prevalent forest trees—in the north the oak, in the middle the chestnut, and in the south the cork tree. The culture of the orange is extended the entire length of the coast. The olive is found everywhere, but the date palm is limited to a fringe along the south coast.

FAUNA. The wild animals are those of Spain. Sardines and the tunny are most conspicuous in the coast fisheries, which are highly productive.

GEOLOGY AND MINERAL RESOURCES. Almost all the geologic formations are represented. Granite is predominant among the northern mountains, gneiss throughout the Douro Valley, mica schists occur irregularly here and there, and basalt is conspicuous in the surroundings of Lisbon. The older fossiliferous formations are conspicuous in the north and centre and cover most of South Portugal. Mesozoic formations occur along the coast between Lisbon and Aveiro, and several mountain chains in the central regions are formed of Jurassic rocks. Portugal suffers occasionally from the seismic disturbances which afflict the peninsula. The great earthquake of 1531 did enormous damage, and that of 1755, in which only one-quarter of Lisbon escaped destruction, was probably the most violent ever witnessed in Europe. The most important mines are in the copper region of Alemtejo and among the iron ores of Moncorvo. Coal is worked at Cape Mondego and is also found in the environs of Leiria. The mining industry, however, is in a worse condition even than that of Spain. Many mines in this richly metalliferous country, which includes also lead, manganese ore, tin, zinc, and antimony among its resources, are idle, and those that are worked are for the most part in the hands of foreigners. Very large quantities of salt, chiefly sea salt (at Setubal, 300,000 tons annually), are produced and much is exported. The Portuguese sea salt is regarded as the best in Europe.

AGRICULTURE. The surface of the country, according to the uses made of it, may be thus divided: agriculture and gardening, 22.4 per cent. of the total area; the vine, 2.2; pasturage and hay, 26.7; woodland, 2.9; unproductive, 45.8. The result is that the food requirements of the scanty population are not met. Farming also is in a low state of development and methods and implements are very primitive. The Portuguese plow has been described as "a crooked branch with a ten-penny nail tied to the end of it." There are three principal regions of cereal culture: that of maize, chiefly north of the Tagus River, where the climate is more humid than in the south; that of wheat, on the wide dry warm plains south of the Tagus; and that of rye, on the

poorer dry soil and in the colder temperature of the eastern lands bordering Spain. Flax is extensively grown in the north and citrus fruits and olives are produced in the south. Vine-growing, the most noted branch of Portuguese husbandry, is of great importance, particularly on the Douro, where the costly port wine is produced. Though the industry is carried on in somewhat antiquated fashion, Portugal is one of the leading wine countries, judged by the quality of its wine. The largest vineyard in the world, at Póceirão (5930 acres), contains 6,000,000 vines, annually producing about 2,650,000 gallons of red and white wine.

Live-stock raising is an important branch of agriculture, the number of horses averaging 90,000; mules and asses, 200,000; cattle, 600,000; sheep and goats, 4,000,000; and swine, over 1,000,000. Cattle are raised in largest numbers in the valleys and on the plains of the north, while sheep and swine are found chiefly in the south. Silkworm culture is increasing, particularly in the north.

MANUFACTURES. The manufacturing industries have only inferior development, but they are progressing, especially in Oporto and Lisbon. The chief manufactures are textiles, particularly woolsens, and also cotton, linen, and silk goods. The cottons are made chiefly for export to the colonies. In the neighborhood of Oporto there are 15 cotton mills. The chief seats of these manufactures are Lisbon, Oporto and the neighboring Braga, and Covilhao. Other products are hats, leather, spirits from sugar cane, porcelain, tobacco, shoes, ironware, brandy, and soap. Ship-building has been increasing in importance within the last few years. The population engaged in industries outside of agriculture in 1900 was 447,620.

COMMERCE. The average annual foreign trade, in millions of dollars may be seen in the following table:

	1881-85	1891-95	1899	1901
Imports.....	40.2	44.3	54.7	58.3
Exports.....	25.5	38.1	31.1	29.0

Great Britain is most important in the foreign trade of the kingdom. In 1901 28 per cent. of the imports came from Great Britain, 15 per cent. from the Portuguese colonies, 13 per cent. from Germany, 10 per cent. from the United States, 9 per cent. from Spain, and 8 per cent. from France. Great Britain took 29 per cent. of the exports; Spain, 13 per cent.; the Portuguese colonies, 12 per cent.; and Brazil and Germany, 11 per cent. each. The imports largely exceed the exports, on account of the quantities of raw materials brought in from the colonies and foreign countries, and the foreign food substances, textiles, coal, and machinery, which are consumed by the people. The value of the leading imports, in million dollars, in 1901, was: coal, 5.4; cotton goods, 4.1; raw cotton, 4.3; codfish, from Norway and British North America, 4.2; sugar, 2.8; iron and machinery, 3.9; woolsens and yarn, 1.4; rice, 1.4; hides and goat skins, 1.5. The leading exports in million dollars were: wine, 10.1; cork, the second largest export, 3.5; copper ore, 1.4; olive oil, 1.2; sheep, 0.8.

Wine represents from one-third to one-half of the exports. About one-half are common wines,

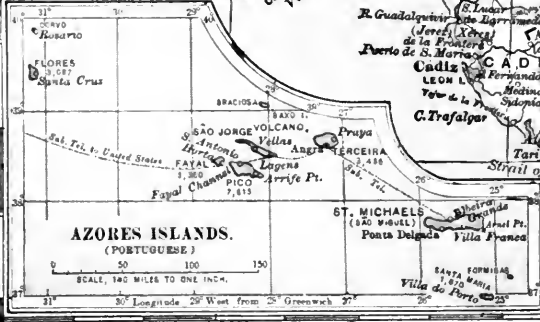

A Longitude 8 West from Greenwich 6 C 4

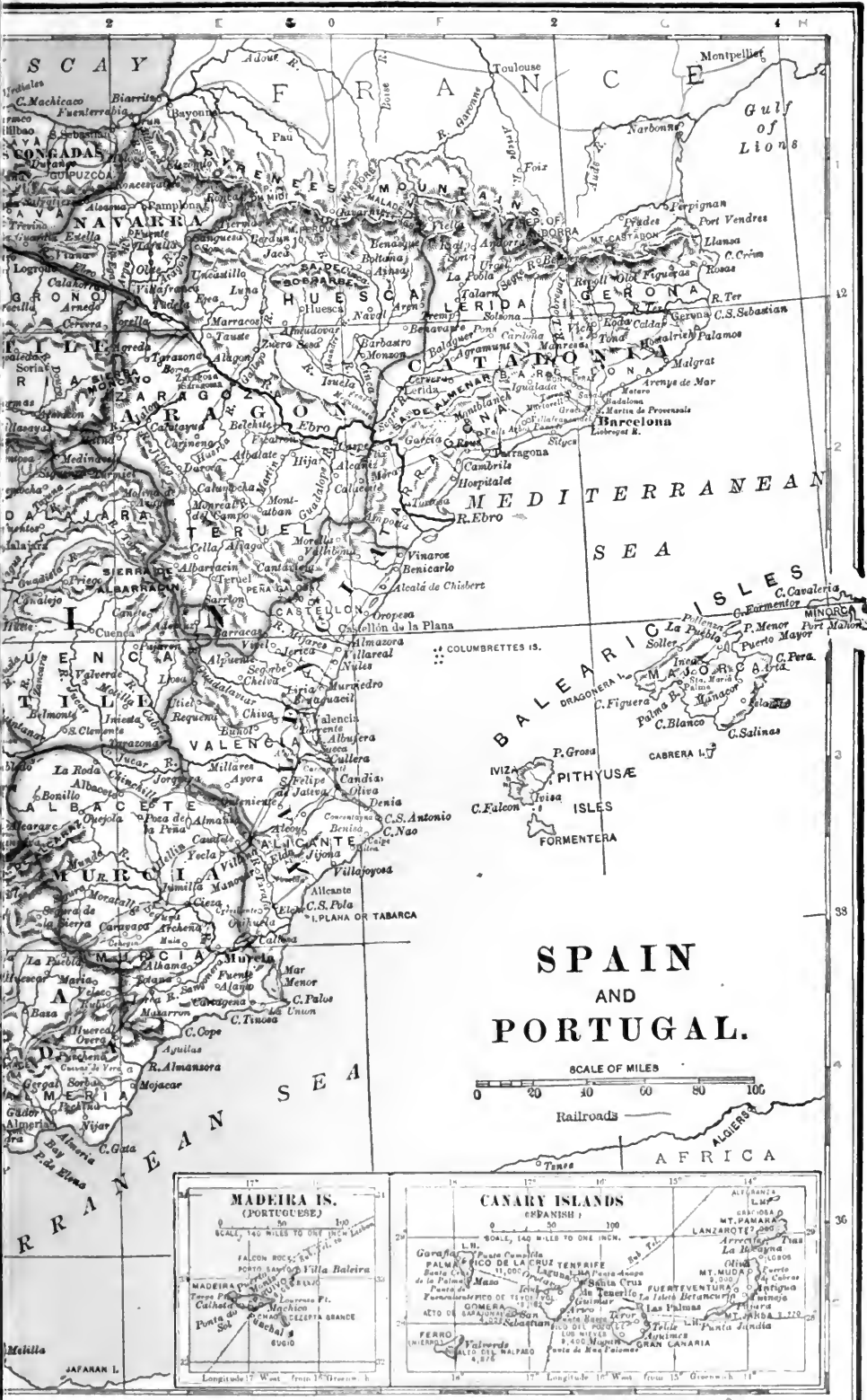

the remainder being divided nearly equally between liqueurs and port wine, with a considerable quantity of Madeira. Most of the wine is sent to Brazil, England, and the Portuguese colonies. Considerable quantities of eggs, onions, potatoes, and other vegetables are exported to England.

TRANSPORTATION AND COMMUNICATION. The domestic trade is much facilitated by the rivers. The wagon roads have been improved and extended in late years, and in 1901 1464 miles of railroads were in operation, of which 507 miles belonged to the State. The railroad lines are practically adequate to the needs. The coasting trade is very active. In 1901 4164 vessels, of 1,322,095 tons, engaged in this trade entered the ports, and 4072 vessels, of 1,249,011 tons, cleared. The foreign trade is chiefly maritime. The chief emporia for this trade are Lisbon and Oporto. The number of vessels in the foreign trade entering the ports in 1901 was 6493, with a tonnage of 10,414,793; cleared, 6516 vessels, tonnage 10,395,615. The larger proportion of the shipping is under the British flag. At the beginning of 1902 the commercial navy of Portugal including the colonies, contained only 44 steamers, of 29,443 tons, and 238 sailing vessels, of 56,588 tons. Regular shipping communication is maintained with many ports, as the steamers of most lines plying to South America, Western Africa, the Mediterranean, and Eastern Asia touch at Lisbon, and in many cases at Oporto also. Thus the Portuguese ports are way stations on many important routes.

BANKING. The banks, including savings banks, numbered 35 in 1895. At that time the cash in hand was 18,252,007 milreis (the milreis = \$1.08); bills, 26,028,403 milreis; loans on security, 24,818,841 milreis; deposits, 32,645,944 milreis; note circulation, 59,075,973 milreis. The principal bank is the Bank of Portugal, whose metallic stock at the close of 1902 was 10,719,031 milreis; note circulation, 69,475,741 milreis; and deposits, 2,922,267 milreis.

EDUCATION. Primary education is nominally compulsory, but the law is not enforced. Very few of the children of the lower classes attend school, and in 1890 nearly four-fifths of the population could not read. In that year there were 5339 primary schools, with 237,791 pupils, or only 471 in 10,000 of the population. In 1899 the number of primary schools had decreased to 4483. Secondary schools are maintained in the chief town of each district and in a few other towns. They had 4248 pupils in 1900. Many private secondary schools are maintained, and also schools for industrial, commercial, and technical training. The University of Coimbra, founded in 1290, had 1690 pupils in 1900.

RELIGION. The State religion is the Roman Catholic faith. All other forms of worship are tolerated; the Protestants are chiefly foreigners. The kingdom is divided into three ecclesiastical provinces, with their seats at Lisbon, Braga, and Evora. A Patriarch presides at Lisbon, and if he is not a cardinal when he enters office, he receives that dignity as soon as a place is vacant in the Holy College. Braga and Evora are under the jurisdiction of archbishops. In 1834 the 632 monasteries and 118 nunneries, with over 80,000 nuns and monks and an annual income of nearly \$5,000,000, were suppressed and their property confiscated for the benefit of the State.

FINANCE. The annual revenue for a number of

years has averaged about \$53,000,000 and the expenditures a little more than that sum. Nearly half of the revenue is derived from the high customs duties, the chief other sources being direct taxes, registration and stamps, and income from national property.

In 1902 the total foreign debt amounted to \$325,938,740 and the internal debt to \$520,153,730; total, \$846,092,470. Owing to the derangement of the finances, steps were taken in 1891 to reduce the interest on the debt. In 1892 the interest on the internal debt was reduced by 30 per cent. payable in currency, and in 1893 the interest on the external debt was reduced by 66 2/3 per cent. payable in gold.

WEIGHTS, MEASURES, AND MONEY. The gold standard is employed and the unit of coinage, the milreis, is worth \$1.08. Silver, nickel, and bronze coins are also in use. The metric system of weights and measures is the legal standard, but the old measures are still in use.

DEPENDENCIES. The dependencies of Portugal are given in the following table, with areas and population (for details, see the respective articles):

	Area, English sq. miles	Population
Possessions in Africa:		
Cape Verde Islands (1900).....	1,480	147,424
Portuguese Guinea.....	12,000	820,000
Prince's and Saint Thomas' Islands.....	360	42,103
Angola.....	484,800	4,119,000
Portuguese East Africa.....	310,000	3,120,000
Total, Africa.....	808,640	8,248,527
Possessions in Asia:		
In India: Goa.....	1,080	561,400
Daman.....	168	77,454
Indian Archipelago (Timor, etc.).....	7,458	300,000
China: Macao, etc.....	4	78,627
Total, Asia.....	8,710	1,017,481
Total, colonies.....	817,350	9,266,008

POPULATION. The number of inhabitants in 1900, including the Azores and Madeira, was 5,428,659, the density of population being 150.6 to the square mile. The urban population was 31 per cent. in 1890. In 1890 the foreign population numbered 39,000, of whom 27,000 were Spanish and 5000 Brazilian. In the ten years 1890 to 1900 the increase in population was 378,930, or at the yearly rate of 0.75 per cent. of the population in 1890. There are very few large towns, the most important, with their population in 1900, being: Lisbon, the capital, 357,000; Oporto, 172,421; Braga, 24,309; Setubal, 21,819; and Coimbra, 18,424. Portuguese emigration, which of late years has usually numbered over 20,000 annually, is chiefly to Brazil and the United States. In 1900 18,908 emigrants went to America and 1938 to Africa.

The list of the provinces and districts, with areas and populations for 1890 and 1900, is shown in the table on the following page.

ETHNOLOGY. The Portuguese are the longest-headed people in Europe (cranial index, 75-77). In stature they are below the average (1.61-1.67 m. or 5 feet 3 inches to 5 feet 5 3/4 inches in the south and an inch taller in the north). Blond hair is practically absent. Black hair is possessed by one-fifth of the population; in the re-

PROVINCES AND DISTRICTS	Area in sq. miles	Population	
		1890	1900
Entre Douro e Minho:			
Viana do Castelo.....	867	207,366	214,599
Braga.....	1,058	338,308	356,819
Porto.....	882	546,262	601,688
	2,807	1,091,936	1,173,106
Tras-os-Montes:			
Villa Real.....	1,718	237,302	243,584
Braganza.....	2,575	179,678	185,586
	4,293	416,980	429,170
Beira:			
Aveiro.....	1,124	287,437	302,181
Vizeu.....	1,920	391,015	402,799
Coimbra.....	1,500	316,624	333,505
Guarda.....	2,146	250,154	263,292
Castello Branco.....	2,558	205,211	216,629
	9,248	1,450,441	1,518,406
Estremadura:			
Leiria.....	1,343	217,278	240,167
Santarem.....	2,651	234,844	283,676
Lisbon.....	2,882	611,168	708,750
	6,876	1,083,290	1,232,593
Alemtejo:			
Portalegre.....	2,484	112,834	124,697
Evora.....	2,738	118,408	127,232
Beja.....	4,209	157,571	161,602
	9,431	388,813	413,531
Algarve (Faro.....)	1,873	228,635	254,851
Total, Continent	34,528	4,660,095	5,021,657
Islands:			
Azores.....	1,005	255,594	256,474
Madeira.....	315	134,040	150,528
Total, Islands....	1,320	389,634	407,002
Grand total.....	35,848	5,049,729	5,428,659

mainder the hair is very dark. Portugal was engaged in the slave trade for nearly four centuries. During that period many thousands of African and Brazilian negroes finally settled in the provinces of Algarve and Estremadura, and a large mulatto contingent in the population is the result. Stone Age relics are common in Portugal, and there have even been discovered seeming indications of human occupation in the Tertiary Age. Megalithic monuments are also common, occurring in the shape of dolmens, from which the tumulary envelope has been removed. In the smaller ones the crypt is made up of four large dressed stones, covered by a fifth; in the more elaborate the chamber is larger, round or irregular in outline, and approached through an avenue. In them along with the dead are found implements of chipped and polished stone, weapons and ornaments, turquoise beads, etc. The most interesting remains of the classical epoch are the so-called *citánias*, hill cities or forts. Two of them crowning the summits of low mountains in the northwest corner of Portugal have been carefully explored. A long wide street is lined on each side with ruins of stone houses. The walls are built of large, irregular blocks well adjusted, the interiors being revetted with smaller stones. The foundations are round and are built up in spiral. A thatched roof, doubtless, was sustained by a central pillar of wood, the stone support of which is to be seen in many ground plans. On

both sides of the door and along the wall are the remains of a penthouse sustained by six pillars, of which the stone bases yet remain. Pottery and glassware abound in them. Flagstones are covered with sculptures and the walls are decorated with circles, coils, and frets. The latest coin found in any of them was of Constantine I. (306-337). Inscriptions on some of the houses are in Roman letters.

GOVERNMENT. The present Constitution of Portugal consists of the Constitutional Charter, granted by King Pedro IV. April 29, 1826, the additional acts of July 5, 1852, of July 24, 1885, and of March 28 and September 25, 1895. The form of government is that of a representative constitutional monarchy, with the system of ministerial responsibility in legislation and administration. The legislative power is vested in a Cortes of two chambers: the House of Peers and the Chamber of Deputies. The House of Peers consists of the princes of the royal blood who have attained the age of twenty-five, the bishops and archbishops, who are peers of right, and about 90 peers appointed at will by the King, their dignity being hereditary, although a law of July 24, 1885, has provided for the gradual abolition of hereditary peerages. The Peers have an equal initiative with the Deputies and the Government, except as to measures relating to imposts and recruitment, and may constitute themselves into a high court of justice for the trial of members of the royal family and high officials. By the law of August 8, 1901, elections to the Chamber of Deputies are by all male citizens twenty-one years of age who can read and write or who pay taxes amounting to 500 reis. Deputies must be graduates of a secondary or professional school or in the enjoyment of an income of not less than 400 milreis per year. Disqualified for membership are peers, naturalized citizens, and certain employees of the Government. The Deputies are apportioned according to population, at present the ratio being one Deputy to every 36,000 inhabitants. The total number is 155, of which seven are returned by the colonies. They are chosen in single electoral districts, and sit for four years unless the Cortes is sooner dissolved. Their chamber has the usual powers and duties of a lower chamber in a parliamentary system. The executive power is vested in the Crown, which is hereditary, females succeeding when males are wanting. The Crown has the usual powers intrusted to a constitutional monarch, but its veto is only suspensive. The King is inviolable and irresponsible. He, therefore, acts officially through responsible ministers who have a seat in the Cortes and take part in its deliberations. The King is also assisted by a Council of State consisting of about 16 members appointed by himself for life. For the purpose of administering justice the country is divided into *comarcas* or districts, in each of which a court of first instance held by a single judge is provided. There are also in each district a number of justices of the peace, who have jurisdiction in minor civil and criminal cases. Above these are three courts of second instance located at Lisbon, Oporto, and Ponta Delgada, in the Azores, which have original jurisdiction in certain cases and hear appeals from the lower courts, while the ultimate judicial authority is the Supreme Court at Lisbon. It is divided into two chambers, has original jurisdiction in a variety of matters, and

is a final court of appeal for the whole kingdom. Trial by jury is allowed in criminal cases.

For the purpose of local government, Portugal, with the neighboring isles, is divided into 21 districts, corresponding somewhat to the French departments. The districts are again divided into *communes* (*concelhas*); and these are further subdivided into parishes, about 4000 in number. In each district there are a popularly elected assembly or *junta*, a permanent executive commission chosen from the membership of the *junta* and charged with the execution of its deliberations, an administrative tribunal for the settlement of administrative controversies, and a Governor appointed by the King and charged with the supervision of matters of central administration in the district. The commune is an administrative circumscription varying in population from 500 to 15,000 inhabitants. Its chief organs of government are an elected municipal council with a president, whose duty it is to execute the resolutions of the council, and an *administrador*, appointed by the King and charged with the supervision of central affairs in the commune. In each parish there is an elected assembly or *junta*, with a president who is charged with the execution of its resolutions, which for the most part relate to ecclesiastical affairs and poor relief.

HISTORY. What later became Portugal was inhabited in prehistoric times by a branch of the Celtiberian race, made up of the native Iberian stock of the peninsula and the immigrant Celts. Greek colonies were planted at the mouths of the three rivers, the Tagus, the Douro, and the Minho—the name of Lisbon being derived from the ancient Greek *Olisipo*. The Carthaginian influence was weaker in this part of the peninsula than in the eastern. The Roman conquest was begun in B.C. 189 and was gradually completed in the two generations following, though with much difficulty, Viriathus (q.v.), the leader of the Lusitania in their revolt (c.153-140 B.C.), proving a formidable adversary. The Roman province of Lusitania under the Empire contained most of the territory of modern Portugal south of the Douro. In the fifth century Roman control in the peninsula gave way to that of the Visigoths without especially affecting this remote corner. It was included in the area of Mohammedan conquest in the eighth century. In 997 the territory between the Douro and the Minho was taken from the Arab-Moors by Bermudez, King of Galicia, and in 1064 the reconquest was completed as far south as Coimbra by King Ferdinand the Great of Castile and Leon. The reconquered districts were organized as counties, feudal appanages of Galicia. From the northern county, the *Comitatus Portucalensis*, extending about the Roman *Portus Cale* (the modern Oporto), the new nation finally took its name. In the division of Ferdinand's realm Galicia with Oporto and Coimbra went to his third son, Garcia, but the eldest son, Alfonso VI. of Leon, forcibly united all the family possessions in 1073. The new Mohammedan attack under the Almoravides (q.v.) put Alfonso on the defensive. Among those who came to his assistance was Count Henry of Burgundy, who married Theresa, an illegitimate daughter of Alfonso, and received Coimbra and Oporto, with the title of Count of Portugal (1095). During the interneecine wars before and after the death of Alfonso in 1109 the Portuguese began to develop a national spirit and to

distinguish themselves from the hitherto dominant Galicians. This was especially true after the death of Count Henry in 1112, when his wife devoted herself to upbuilding an independent kingdom for their infant son. The latter, Alfonso I., assumed the government in 1128 and fought valiantly against the Moors, over whom he won a splendid victory at Ourique in 1139. This was followed by his assumption of the kingly title and long wars necessitated by the attempts of Castile to subdue his dominions. Alfonso took Lisbon from the Moors in 1147 and made it his capital. He died in 1185, after a long and brilliant reign. His son and successor, Sancho I. (1185-1211), gained from the gratitude of a prosperous country the title of 'the Founder.' Alfonso II. (1211-23) followed Sancho's wise policy, but came into conflict with the Papacy, which culminated in the King's excommunication and an interdict laid upon the kingdom. His son Sancho II. (1223-45) was also excommunicated, the country being put under an interdict, and was finally deposed by Pope Innocent IV. He died in 1248. His brother, Alfonso III. (1248-79), was on better terms with the clergy and also proved to be a capable ruler. The country had now reached its utmost European limits, and its course had been steadily progressive, except for the unfortunate years of struggle with the Church. The long reign of Denis or Diniz (1279-1325), the son of Alfonso III., was a period of progress and development hardly equalled at that time in Europe. Under him Portugal entered on that course of commercial enterprise which was the source of all the country's wealth and greatness. In 1290 he founded the University of Lisbon (transferred to Coimbra in 1308). His son Alfonso IV. (1325-57) was compelled to defend his kingdom against Castilian and Moslem. Alfonso's son Pedro (1357-67) was succeeded by his son Ferdinand (1367-83), the last male in the legitimate line.

On the death of Peter his illegitimate son, John I., took measures to secure the government and was recognized by the Cortes after some difficulty in 1385. This branch of the Burgundian house is sometimes known as the House of Aviz, the King having been grand master of the Order of Aviz. John's reign of nearly half a century was one of the most noteworthy in Portuguese history. He successfully defended his kingdom against Castilian attack and showed himself a statesman and general of uncommon ability. The fame of his reign rests, however, less upon the strong and intelligent administration of the King than upon the work done under the direction of his accomplished son, Prince Henry the Navigator (q.v.), in exploring the African coast with the object of discovering an eastward route to the Indies. In 1419 the Portuguese rediscovered Madeira, and at the close of John's reign they reached the Azores. A successful campaign by Portugal in Morocco, resulting in the capture of Ceuta in 1415, was followed by the acquisition of control over about half of Morocco, which was held until 1578. John I. was succeeded by his eldest son, Duarte, or Edward (1433-38), and he by his son Alfonso V. (1438-81). The work of Prince Henry's captains and their immediate successors led to the inauguration of a regular system of exploration and the acquisition soon after the middle of the fifteenth century of the Cape Verde Islands and the Guinea Coast. Alfonso V. interfered in the Cas-

tilian succession disputes (1474-76) and was severely defeated at Toro in the latter year. Alfonso was succeeded by his son John II. (1481-95), during whose reign Pope Alexander VI. issued his famous bull of demarcation (May 4, 1493), giving to Portugal all discoveries east of a meridian one hundred leagues west of the Azores and Cape Verde Islands, a decision which was modified by the Treaty of Tordesillas (June 7, 1494) between Portugal and Spain, by which the line of demarcation was moved to a distance 370 leagues west of the Cape Verde Islands. This arrangement presently gave Portugal the important territory of Brazil in the Western Hemisphere. John's successor was his cousin Emmanuel (1495-1521), the son of a younger brother of Alfonso V. His reign was notable for the voyage of Vasco da Gama around the Cape of Good Hope to India (1497-98), opening the period of Portuguese activity in the East, and for the discovery and first settlement of Brazil, which remained for over three centuries an appanage of the Portuguese crown. In 1510 Albuquerque (q.v.) captured Goa, which became the seat of Portuguese power in the East. Within a few years this great commander extended the Portuguese conquests to Malacca and the Sunda Islands. The Portuguese also established themselves at various points on the east coast of Africa and penetrated into Abyssinia and the Congo country. The reign of Emmanuel's son, John III. (1521-57), saw Portugal at the height of its prestige. It ranked as one of the most powerful European monarchies, while Lisbon was one of the most important commercial cities of the Continent.

While Portugal's rise had been rapid, its decline was more sudden still. The numerous wealthy and industrious Jews, whose able financial management had done much to establish Portuguese commerce, were expelled from the country, while social tyranny and oppression in the colonies as well as at home depressed the energy and crippled the resources of the nation. The death of King John in 1557 made his grandson Sebastian, then a child of three years, King. Drawn by his ambition for new conquests and by the restlessness of the Moors into an African campaign in 1578, the young King met a total defeat and death at Kasr el-Kebir (Alcazar Quivir). This was the beginning of the loss of the Moorish dominions of Portugal. Of the few places remaining in Portuguese control after this unfortunate campaign, Ceuta was garrisoned by Spain in 1580 and ceded to that country in 1668; Saffi was ceded to the Moors in 1641; Tangier to England in 1662; several other places to the Moors in 1689; and the last, Mazagan, in 1770. The death of Sebastian left but one representative of the old Burgundian line, Sebastian's aged grand-uncle, the Cardinal Henry, whose brief reign (1578-80) plunged the country still further into misfortunes. His death gave rise to bitter disputes over the succession between several connections of the Portuguese royal house. Of the claimants Philip II. of Spain, whose mother was a daughter of the late King Emmanuel, possessed the power and the opportunity to seize the coveted possession, which he promptly did, two battles sufficing for its conquest by the Duke of Alva. The annexation of Portugal to the Spanish monarchy subjected it to the deadly blight of Philip's state-ty and imposing tyranny; its resources were

weakened by the heavy expenses incident to the ruinous wars of Spain; and the Dutch seized most of the Portuguese possessions in the East Indies. In the reign of Philip IV. matters were brought to a crisis by the course of his minister Olivarez, and in 1640 a successful conspiracy of the higher nobility freed Portugal from connection with Spain. This was accomplished under the leadership of John, Duke of Braganza, the descendant of an illegitimate son of John I. The Duke ascended the throne, and the rule of the present reigning House of Braganza began in the person of John IV. (1640-56). War with Spain was terminated in 1668, when in the Treaty of Lisbon the independence of Portugal was formally recognized. The succeeding history of Portugal offers little that is of interest. From its high rank as a commercial power the country sank into a position of practical dependence upon England, with which Portugal became closely allied by the Methuen Treaty in 1703. John IV. was succeeded by two of his sons, Alfonso VI. (1656-67) and Pedro II. (1667-1706). To the latter's son, John V. (1706-50), succeeded his son, Joseph (1750-77). In this reign the genius and resolution of the Minister Pombal (q.v.) infused temporary vigor into the administration and checked for a time the downward tendency of the national credit. Pombal carried on a relentless war against the nobles and the clergy, and as a result of his efforts the Jesuits were expelled from the country in 1759. The year 1755 was notable for an earthquake which nearly destroyed Lisbon (q.v.). There was a speedy relapse into reaction upon the accession of Joseph's daughter Maria and her husband, Pedro III., who was also her uncle. The latter died in 1786 and three years later, owing to the mental condition of the Queen, the government was put in the care of a regency under the Crown Prince John. Prince John gave evidence of ability and patriotism. Being unable to maintain himself in Portugal against Napoleon, who by the Treaty of Fontainebleau had agreed with Spain upon the partition of Portugal, he left the country in November, 1807, with his family and transferred his Government to Brazil, while a French army under Junot occupied Lisbon. The campaigns of the English and Portuguese forces under Sir Arthur Wellesley freed Portugal of its French invaders (see PENINSULAR WAR), and in 1816, upon the death of his mother, Prince John succeeded to the crowns of Portugal and Brazil as John VI. He continued to reside, however, at the Brazilian capital until 1821.

Portugal had for several generations been under an absolute form of government, the controlling springs of which were the Court and the priesthood. The transfer of the seat of government to Brazil was a humiliation to the Portuguese, and aroused a spirit of discontent which made them especially susceptible to the revolutionary influences then alive in Europe. In 1820 the army took the lead in a revolution designed to bring in a constitutional government. King John returned to Portugal, leaving his son Dom Pedro as Regent in Brazil, with instructions to retain that country for the House of Braganza, even at the cost of separation from Portugal. The revolutionists at home insisted upon subordinating Brazil in the new arrangements and produced a revolt in the latter country. This movement Dom Pedro, loyal to the

interests of Brazil, headed, and in 1822 Brazil asserted its independence and the Prince Regent declared himself constitutional Emperor. Meanwhile in Portugal the Brazilian movement caused a reactionary revolt toward absolutism, headed by the King's younger son, Miguel (q.v.), who had been invested with the command of the army. The revolt was put down with British assistance in 1824. Upon the death of King John in 1826 his son, Pedro, Emperor of Brazil, who succeeded to the crown of Portugal, promulgated a constitution, providing for a bicameral legislature, with an hereditary House of Peers and an elective House of Deputies, its legislative powers being subject to the King's sanction. The fundamental liberties of citizens were guaranteed, and other religions than the Catholic were to be tolerated. Pedro then resigned his right to the crown in favor of his seven-year-old daughter, Maria da Gloria, who, when of age, was to marry her uncle, Miguel. The latter was made Regent in July, 1827, and in this Pedro, who was an unselfish patriot but not a politician, made his great mistake. The Regent at once took measures in defiance of the Constitution to restore the ancient forms of government. He proclaimed himself King in 1828, sought to reconcile the interests of the conflicting political parties, and at the same time place the monarchy on its old basis. In this he was supported by the Absolutists, recruited from the army and the clergy. In 1832 Dom Pedro, who in the preceding year had been forced to abdicate the throne of Brazil, proceeded to uphold the rights of his daughter by force of arms. He placed himself at the head of an expeditionary force, which had been collected by the opponents of Dom Miguel at the island of Terceira, Azores, and in July he was welcomed as a deliverer at Oporto, the Liberal stronghold. A stubborn struggle ensued. In July, 1833, the fleet of Dom Pedro, commanded by Sir Charles Napier, vanquished the Miguelist fleet off Cape Saint Vincent, and a few weeks later Lisbon capitulated to Dom Pedro, who proclaimed himself Regent for Dona Maria. Pedro was aided by the intervention of Spanish arms, backed by the influence of the short-lived Quadruple Alliance (England, France, Spain, Portugal). By the agreement of Evora, in 1834, Miguel pledged himself to a renunciation of all claims to the crown and to perpetual exile from the kingdom. Pedro died September 24, 1834, when Queen Maria was but fifteen years of age. Her reign was a troublous one. Neither rulers nor people knew how to carry on a parliamentary government. The fall of Miguel put an end to the Absolutist Party, and the political division that took the place of the old was that between Chartists and Liberals, the former upholding the existing Constitution, the latter seeking to restore the Constitution of 1822, which represented popular sovereignty. The later political history of the country has been that of a series of progressive movements originating in the principal cities and combated, usually with success, by the conservative element. A military revolt in September, 1836, forced the Queen to restore the Constitution of 1822, and gave their name to the Septembrists, who thereupon formed the Constitution of 1838, modeled upon that of 1822. Another military revolt restored the Chartists to power in 1842, and they governed the country under the leadership of Costa Cabral (q.v.) until in

1852 a new party known as the Regenerators, composed of Septembrists and Chartist seceders, came into power under Saldanha, and established direct suffrage. The Queen died November 15, 1853, leaving her husband, Prince Ferdinand of Coburg, as Regent during the minority of their son, Pedro V. The latter died November 11, 1861, having refused to flee from the cholera-stricken city of Lisbon. Ferdinand continued as Regent for the next heir, Luiz (1861-89). The autocratic methods of Saldanha split his party and finally resulted in 1877 in constituting the Progressist Party out of the more radical members of the old Liberal parties. A Republican Party came into existence in 1881 and has since been carrying on a more or less active propaganda, which was stimulated in 1889 by the success of the republican revolution in Brazil. The continued excess of expenditures over receipts and the consequent increase of the public debt has imposed a severe responsibility upon the Government and forms its most difficult problem. King Luiz died October 9, 1889, and was succeeded by his elder son, Carlos. See CHARLES I. See POLITICAL PARTIES, section on *Portugal*.

BIBLIOGRAPHY. Aldama-Ayala, *Compendio geográfico-estadístico de Portugal y sus posesiones ultramarinas* (Madrid, 1880); La Teillais, *Etude historique, économique et politique sur les colonies portugaises, leur passé, leur avenir* (Paris, 1872); Crawford, *Portugal, Old and New* (London, 1880); Andrade Corvo, *Estudos sobre as provincias ultramarinas* (Lisbon, 1883-87); Oliveira Martins, *Portugal contemporaneo* (Lisbon, 1883); Crawford, *Round the Calendar in Portugal* (London, 1890); Tavares de Medeiros, *Das Staatsrecht des Königreichs Portugal* (Freiburg, 1892); Salisbury, *Portugal and Its People* (London, 1893); Da Silva, *Diccionario bibliographico portuguez* (9 vols., Lisbon, 1858-70); Annes de bibliographica portugueza (Oporto, 1889).

For ethnology, consult: Ribiero, *Estudos pre-historicos en Portugal* (Lisbon, 1878-80); Herbert, *Portugal and Galicia* (London, 1848); Cartailhac, *Les ages préhistoriques de l'Espagne et du Portugal* (Paris, 1886).

For history, consult: F. d'Urban and J. F. Mielle, *Histoire générale de Portugal* (9 vols., Paris, 1829), based on a work with the same title by Laclède (2 vols., Paris, 1735); E. A. de Bettencourt, *Descobrimentos, guerras, e conquistas dos Portuguezes em terras do ultramar nos seculos XV. e XVI.* (Lisbon, 1881, 1882); M. T. Alves Nogueira, *Evoluções da civilização em Portugal* (Paris, 1893). Dunham, *History of Spain and Portugal* (5 vols., Philadelphia, 1832); Mac Murdo and Monteiro, *History of Portugal* (London, 1888); Morse Stephens, *Portugal, "Story of the Nations Series"* (London, 1890); Schär, *Geschichte von Portugal* (5 vols., Hamburg, 1836-54); Latino Coelho, *Historia politica e militar de Portugal* (Lisbon, 1874-96); Oliveira Martins, *Historia de Portugal* (4th ed., Lisbon, 1880); Zimmermann, *Die Kolonialpolitik Portugals und Spaniens* (Berlin, 1896); Pinheiro Chagas, *Historia de Portugal* (8 vols., Lisbon, 1877); Seignobos, *Histoire politique de l'Europe contemporaine* (London, 1900).

PORTUGAL. pór'tōō-gāl'. MARCOS ANTONIO (1762-1830). A Portuguese composer, born in Lisbon. He was educated at the Priests' Seminary in his native town and continued his musi-

cal education under the opera-singer Borselli, by whose influence he was appointed cembalist at the Madrid Opera in 1782. In 1787 he went to Italy, where, the following year, his first opera, *L'eroe emesc*, was produced. The slight success of his first work was compensated for by the popular favor accorded to *La bacchetta portentosa*, in 1788, at Genoa. In 1790 appeared *Il Molinaro* and *L'astuto*, both in Italy, and he was appointed Court conductor at Lisbon, but later returned to Italy. From 1799 to 1810, he conducted at the San Carlos Theatre in Lisbon, and produced a number of Italian and Portuguese operas. In 1810 he went to Rio de Janeiro, at which place he occupied the position of general musical director. In 1813, with his brother, Simão, he was appointed joint musical director of the Conservatory at Vera Cruz. In 1815 he visited Italy for the last time. He spent the remaining years of his life at Rio de Janeiro as an invalid. He composed about forty operas, five grand masses, five masses with the organ, and two Te Deums, in addition to numerous smaller works and church music. Though not among the great international composers, he holds the first place in Portuguese music.

PORTUGÁLETE, pör'tōō-gä'lä-tä. A Spanish seaport near Bilbao (q.v.).

PORTUGUESE-BRAZILIAN LITERATURE. The literature of Brazil has to some degree followed the literary tendencies of the motherland in Europe. As it was long the custom to send Brazilian youths of promise to Coimbra for their training, the intellectual relations between Portugal and Brazil were very close during the colonial period. Since the winning of Brazilian independence, however, Brazilian writers have shown no slight originality.

Four periods may be marked: (1) From the age of discovery and exploration down to the middle of the eighteenth century, a period during which the seeds of culture are sown by missionaries from Europe, especially by the Jesuits. At first Portuguese and Spanish models are followed servilely, but in the first half of the eighteenth century a slight tendency toward independence manifested itself, even though Portuguese influence still ruled supreme. (2) The second half of the eighteenth century, an age which is characterized by the endeavors of the poets of the school of Minas-Geraes, who show in certain instances a growing desire to escape from the too rigid influence of the Old World. (3) The period ranging from the beginning of the nineteenth century to about 1840, and bearing the impress of the political independence that began in 1822. (4) The epoch from 1840 on, during which the Romantic movement comes to shake the power of Pseudo-Classicism as well in America as in Europe, and the feeling of national consciousness exerts a constantly growing influence.

(1) From the settlement to the middle of the eighteenth century. The Jesuits sought as soon as possible to naturalize the literary forms popular in the old country, and composed and had performed dramas religious in their nature and based on the *Autos* of Gil Vicente and his successors. The first poet known by name is Bento Teixeira Pinto (born about 1550); he is more noteworthy for his prose *Relação do naufragio que fez . . . em o anno de 1565* than for his verse. More important than Pinto are the brothers Gregorio

and Eusebio de Mattos. Gregorio (1633-96), the better of the two, was an inveterate satirist; he closely imitated the Spanish Juvenal, Quevedo, adopting also the methods of the Spaniards Lope de Vega and Góngora. Spanish Gongorism prevailed likewise in the lyrics of Vieira Ravasco (1617-97) and Botelho de Oliveira (1636-1711); and Oliveira, like so many Portuguese of the period, wrote at least as much in Spanish as in Portuguese. Bahia, where the Viceroy dwelt, saw the greatest literary development in this first period. It was the centre of societies of men of letters, such as the *Academia Brazílica dos Esquecidos*, whose members produced much occasional verse of a panegyrical nature. The panegyrics of Brito de Lima (1671-1742) are typical compositions. We may mention the Franciscan Manoel de Santa Maria Itaparica (born 1704), whose poetical legend, *Eustachidos*, treats the well-known story of Saint Eustace, and the *Historia da America portugueza* of Sebastião da Rocha Pita (1660-1738). This is the first truly scientific and detailed account of the history of Brazil. The first distinguished dramatist of Brazilian birth now appeared in Antonio José da Silva (q.v.).

(2) Second half of the eighteenth century. The influence of Portuguese literature, itself now wholly subordinated to the precepts of French Pseudo-Classicism, continued to hold sway during this period, but the note of protest against what was fast beginning to be felt as foreign domination rang out ever more loudly both in politics and in letters. On the model of the European Academies and Arcadias, Rio de Janeiro had the *Arcadia Ultramarina* founded by the poet José Basilio da Gama (1740-95) and kindred spirits. The members of the coterie of Minas Geraes, many of them associated with the *Arcadia Ultramarina*, known as the *poetas mineiros*, headed the luckless movement for political independence which emanated from that region. To José Basilio, a master of style and harmony, is due the epic *Uruguay*, which describes the struggles of the Spanish and Portuguese troops against the Indians of Paraguay. Another worthy endeavor to compose an epic is seen in the *Caramuru* of José de Santa Rita Durão (1737-84), celebrating Diego Alvares, an early explorer of the coast of Bahia. The earliest of the lyric poets of the Minas Geraes group was Claudio Manoel da Costa (1729-90), who hanged himself in prison after the failure of the revolutionary plot in which he and his fellow poets had figured. His close friend Thomaz Antonio Gonzaga (1744-1809), the greatest member of the school and one of the most popular poets in the Portuguese speech, perished in exile. Gonzaga is best known by the pseudonym of Direen, which he assumed in his famous *Marília de Dirceu*. This collection of impassioned lyrics is addressed to his beloved (Marília). The erotic spirit also inspires the lyrics in the *Glaura* of Manoel Ignacio da Silva Alvarenga (1740-1814), who helped to found the *Arcadia Ultramarina*. Alvarenga earnestly endeavored to infuse a more national and popular spirit into the Brazilian lyric. Domingos Caldas Barboza (1740-1800), author of *cantigas, quintilhas*, sonnets, etc., and Francesco de Mello Franeo (1757-1823), who, with the aid of José Bonifácio, wrote the mock-heroic poem, *O reino da estupidez*, belong more properly to Portugal.

Tenreiro (1769-1811) imitated Horace in his odes.

(3) From about 1800 to about 1840. The fetters of Classicism were now shaken off by certain writers who advocated a wider use of Christian elements in poetic composition. Among them were Antonio Pereira de Sousa Caldas (1762-1814), known for his verse translation of the Psalms, etc.; Frei Francisco de São Carlos (1763-1829), author of the excellent epic, *A Assumpção da Santíssima Virgem*; and José Eloy Ottoni (1764-1851), who made metrical versions of the Book of Job, of Proverbs, and of the Psalms. Although their enduring fame is rather that of statesmen and scientists, José Bonifacio de Andrada e Silva (1763-1838; patriotic and political odes, etc.), Francisco Vilella Barbosa, Marquis of Paranáguá (1769-1846, love lyrics), and the Viscount da Pedra Branca (1783-1855) deserve to be mentioned here. Mythology and poetical metamorphosing mark the verse of Januario da Cunha Barboza (1780-1846; poem *O Nicteroy*), of Silverio da Paraopeba (*Fabula do Morro do Ramos*), and of Santos Titara (epic *Paraguassú*). Barboza edited the *Parnaso brasileiro*, the first important anthology of Brazilian verse. Noteworthy prose was written by the eloquent Franciscan preacher Francisco do Monte Alverne, whose family name was de Carvalho (1784-1858). The *Maximas, Pensamentos e Reflexões* of Pereira da Fonseca, Marquis of Maricá (1773-1848), and the *Diccionaria da lingua portugueza* (1789) and the *Epitome da grammatica portugueza* (1802) of Antonio de Moraes e Silva are important.

(4) Since 1840. With an enlightened monarch like Dom Pedro II. in power, letters and science grew stronger; the Emperor himself was a scientist of no mean ability, and he was a munificent patron of authors. The Romantic movement came to arouse the Brazilians to a still higher estimate of the part that the emancipated individual can play in the creation of a noble native literature. The triumph of the romantic ideas and the consciousness of national independence are signally marked in all the poetry of Domingos José Gonçalves de Magalhães, Viscount of Araguay (1811-1882). His beautiful lyrics, mostly elegiac in tone, may be judged by those contained in the collections entitled *Suspiros poeticos e Saudades, Os Mystérios, and Urania*; the poem *Napoleão em Waterloo* is deemed the best of all. Magalhães succeeds even better in his epic, for his *Confederação dos Tamayos*, celebrating in unrhymed hendecasyllable the struggles of certain Indian tribes against the Portuguese invaders, is imperishable. His dramas, such as the *Anton José* and the *Oligato*, are not so good. Of his scientific or philosophical prose there may be noted the *Factos do espirito humano*.

Manoel de Araujo Porto-Alegre (1806-79), skilled in painting and architecture, cultivated belles-lettres also, and, besides composing several comedies, he enriched Brazilian literature with the idyllic and descriptive *Brasilianas* and the epic *Colombo*. Inspired by the *Brasilianas*, Antonio Gonçalves Dias (1823-66) put forth three volumes of lyrics, viz. *Primeiros cantos, Segundos cantos e seatilhas de Fr. Antão*, and *Ultimos cantos*, as well as an epic, *Os Tymbiras*, and several tragedies (*Leonor de Mendonça, Boabdil, Beatrice Cenci*, etc.). With Araujo and Joaquim Manoel de Macedo (1820-82), he founded

the influential literary review *Guanabara*. Macedo, favorably known for his novels (*Moreninha*, etc.), tragedies (*O Cezo Colé*, etc.), and vaudevilles, wrote the excellent lyrical and descriptive poem *A Nebulosa*. Manoel Odonio Mendes (1799-1864) is esteemed for his verse translations of Homer and Vergil (*Iliada, Odysse, Eneida, Georgicas*); in his original poems pedantry obscures his merits. Romantic tenets have generally been followed by Joaquim Norberto de Souza Silva (born 1820), an indefatigable writer (lyrical *Modulaçoens poeticas*, epico-lyric *Balatas, Cantos epicos*, tales, and a prose *Bosquejo da historia da poesia brasileira* which prefaces his *Modulaçoens*); by Antonio Gonçalves Texeira e Souza (1812-61; *Canticos lyricos*, the idyllic and allegorical *Tres dias de um noivado*, and such novels as *O filho do pescador, A Providencia, Maria*, etc.); by Joaquim José Teixeira (apologues); by Pedro de Calasans; and by Silva Guimarães. The *Historia geral do Brasil* of Adolpho de Varnhagen shows talent.

Of more recent times we can hardly speak as yet with sufficient critical retrospect. As everywhere else, so in Brazil romantic doctrines have been swept away by a realistic movement. The change from an imperial to a republican form of government has also very naturally left its impress upon current literary production. Foremost among the writers of the last three decades of the nineteenth century stands Sylvio Romero, a lyric poet (*Cantos do fim do seculo, Ultimos harpejos*) and the author of critical works on ethnography, literary history, and philosophy. Out of many other forceful writers there need be cited here only the lyric poet Olavo Bilac and the novelists Verissimo, Alencar, and Taunay.

Consult: Blake, *Diccionario bibliographico brasileiro* (Rio de Janeiro, 1883); Romero, *Historia da litteratura brasileira* (ib., 1888); Pinheiro, *Curso de litteratura nacional* (ib., 1878); Wolf, *Le Brésil littéraire* (Berlin, 1863); Pereira da Silva, *Parnaso brasileiro* (Rio de Janeiro, 1832-48); id., *Plutarco brasileiro* (ib., 1847; republished as *Varões illustres do Brazil* in 1858); J. Manoel de Macedo, *Brazilian Biographical Annual* (Rio de Janeiro, 1876); Varnhagen, *Florilegio da poesia brasileira* (vols. i. and ii., Lisbon, 1850; vol. iii., Madrid, 1853); F. A. Pereira da Costa, *Diccionario biographico de Pernambucanos celebres* (Rio de Janeiro, 1882); and various studies by Romero, viz. *Estudos sobre a poesia popular do Brazil* (Rio de Janeiro, 1888), *Cantos populares acompanhados de introdução e notas comparativas* (Lisbon, 1883); *Cantos populares do Brazil* (Lisbon, 1885), *Uma esperieza, Os cantos e contos populares do Brazil* (Rio de Janeiro, 1887).

PORTUGUESE EAST AFRICA, or MOZAMBIQUE. A colonial possession of Portugal, on the eastern coast of Africa, bounded by German East Africa on the north, the Indian Ocean (mainly the Strait of Mozambique) on the east, Zululand on the south, and the Transvaal, Rhodesia, the Central Africa Protectorate, and Lake Nyassa on the west (Map: Africa, H 6). Area, 310,000 square miles. The coast is low and forms but few harbors. In the portion north of the Zambezi the country rises rapidly toward the west, where the Namuli Mountains form the principal mountain range of the colony and rise, in Namuli Peak,

to an altitude of nearly 9000 feet. In the southern part the ascent is more gradual. The chief elevations here are the Manica plateau, with Mount Doe rising to nearly 8,000 feet, the Gorangoza plateau, and the Lebombo Mountains. The principal rivers are the Rovuma, which forms part of the northern boundary of the colony, the Zambesi, the Shire, the Pungwe, the Sabi, and the Limpopo. There are, besides, many small streams along the coast. The climate of the region, except in the mountainous districts, is malarial and subject to wide fluctuations. The mean annual temperature at Quilimane, near the coast, is 85° F., ranging from 106° to 49°. The rainy season lasts from December to March.

The vegetation is tropical. The coast region yields coconuts, indigo, tobacco, coffee, and rubber. Wheat, corn, beans, sugar cane, and rice are also grown to some extent. The country possesses great mineral wealth, including gold, iron, and coal. The gold deposits are found principally in Manica, near the frontier of Rhodesia, and are exploited almost exclusively by British subjects. Iron is extracted to some extent by the Makwas. The exploitation of the mineral resources of the country as well as its entire economic development is greatly obstructed by the lack of transportation facilities and the unfavorable climatic conditions, which prevent an extensive European immigration. The Mozambique Company, organized largely with British capital, secured a royal charter for the administration of the Manica and Sofala regions for a period of 50 years beginning with 1891. The Nyassa Company controls the region between the Rovuma, Lake Nyassa, and the Lurio.

The commerce of the colony amounted in 1900 to \$18,861,189, of which two-thirds represented imports, chiefly for reexport. The imports are composed mainly of cotton goods, iron products, and beverages. The principal exports are rubber, wax, ivory, and minerals. Most of the trade passes through the ports of Lourenço Marques, Beira, and Mozambique. The colony has two railway lines, one connecting Beira with Rhodesia, 222 miles in the colony, and another leading from Lourenço Marques to the Transvaal Colony (57 miles in the colony). The colony is under the administration of a Governor-General and is divided into the districts of Lourenço Marques, Mozambique, Zambesia, Gaza, and Inhambane. The estimated revenue and expenditures for 1901-02 were \$3,064,548 and \$3,294,325 respectively. The population is estimated at over 3,000,000.

The principal tribes are the Makwas and the Ajas in the north, both belonging to the Bantu race; the Tavalas in the central part; and the Watwas, a Zulu tribe, and the Tongas, a tribe of mixed origin, in the south. The seat of administration is Lourenço Marques. The occupation of the eastern coast of Africa by the Portuguese dates from 1498, when Vasco da Gama landed at one of the mouths of the Zambezi. A number of settlements were founded along the coast during the first decade of the sixteenth century, and the military post of Tete, on the Zambesi, was founded in 1632. Slavery was abolished in 1878. The boundaries of the colony were fixed by agreements with Great Britain in 1891 and with Germany in 1886 and 1890. Consult: Andrade Corvo, *Estudos sobre as Províncias Ultramarinas* (4 vols., Lisbon, 1883-87); Oliveira Martins, *Portugal em*

Africa (Porto, 1891); Theal, *The Portuguese in South Africa* (London, 1896).

PORTUGUESE GUINEA, gín'ê. A colony of Portugal in Northwest Africa, bounded on the north by Senegal, on the east and south by French Guinea, on the west by the Atlantic (Map: Africa, B 3). The boundary with French Guinea was established by convention in 1886. Area, 14,265 square miles. Numerous islands which belong to the colony, including the Bissagos, line the coast. The shores are difficult of access. The land rises gradually from the flat coast region to the mountains of French Guinea, and is generally fertile. The Rio Grande is the largest river. In the lower part of its course it forms a wide inlet of the sea. The climate is excessively hot. The average annual temperature is 78.8° F. The rainy season is between May and November. The flora and fauna are tropical. The palm tree abounds. The forests contain a large variety of valuable woods. Rice and millet are the chief crops.

The French control the commerce. Bulama, the capital, on the island of the same name, has a safe harbor, and divides the commerce with two other ports, including Bissao. The annual foreign commerce is above \$1,100,000, the exports averaging about one-third of the imports. Ivory, wax, nuts, and India-rubber are exported. About 150 vessels, with some 60,000 tonnage, yearly visit the ports, excluding the coasting trade. The government is practically a Portuguese protectorate. There are a governor and a council. The estimated revenue for 1902-03 was \$140,400, the expenditure \$232,000. The military force is very light. The population is probably about 200,000, and consists of portions of many races, including the Fulbe. Portuguese Guinea was a bone of contention between Portugal and Great Britain between 1792 and 1870, in which latter year the United States Government as arbiter justified the claims of the former.

PORTUGUESE LANGUAGE. One of the Romance languages, or modern descendants of Latin, spoken in Portugal, Brazil, the Spanish Province of Galicia (with archaic and dialectal elements), the Cape Verde Islands, Portuguese Guinea, and other Portuguese colonies. As in the case of the sister languages, Spanish, French, Italian, etc., Portuguese is derived from the popular Latin of the Roman soldiery and colonists rather than from the classic speech of Rome. In its form it resembles the Spanish, its nearest neighbor, more than it does any one of the other Romance tongues. Its literature is much less important than that of the French, Spanish, or Italian, because it has been too largely imitative and too frequently subordinated to influences from France and Spain, and only exceptionally original in tone and content. Even the Portuguese vocabulary betrays considerable borrowing from France.

A description of the phonological conditions of the language is made somewhat difficult by the fact that the alphabetical notation is not strictly accurate from the phonetic point of view, since one and the same letter may denote different sounds. Moreover, even the most competent observers differ in their account of the various vowel and consonant elements of the speech. According to the best estimate, there seem to be

eleven vowel sounds, at least, viz. three values of *a*, one rather close, like the *a* of *father*, a second quite open, like the *a* of *malt*, and a third, slurred and indistinct in nature, but akin to the *a* of *around*; three *e* sounds, one close, another open, and a third (written *e* or *i*) indistinct in value and not unlike the French so-called mute *e* or the sound of *u* in *fur*; two *i*'s, one like the *i* of *bit* and the other like the *i* of *ravine*, this latter value being represented by the vocalic *y* and by *e*, as well as by *i*; two *o* sounds, an open and a close; and a *u* sound (denoted by *u* and *o*), approximate to the *u* of *flute*. These are all oral vowels. There occur also nasalized forms of five of them, viz. a nasalized *a* (written *ã*, *an*, or *am*), a nasalized close *e* (written *em* or *en*), a nasalized *i* (written *im* or *in*), a nasalized closed *o* (written *õ*, *om*, *on*), and a nasalized *u* (written *um* or *un*). Portuguese has a number of diphthongs. Several of these latter may also be nasalized; but the process of nasalization is not so complete in the case of either the vowels or the diphthongs as it is in French, for some trace of the nasalizing consonant (*m*, *n*) seems to persist (with a velar quality). The investigations of expert phoneticians like Vianna show the existence of no fewer than twenty-five consonantal sounds in the language. These are: *p*, *b*, a bilabial *b*, *f*, *v*, *w*, (denoted by *u* or *o* in hiatus); *m*, *t*, *d*, a spirant *d* (*d* pronounced like *th* in *the*), *l*, a palatalized *l* (written *lh* and pronounced approximately like the *li* of *filial*), a guttural *l*, *n*, a palatalized *n* (written *nh* and pronounced not unlike the *ni* of *onion*), a velar *n* (that is, the *ng* sound which ordinarily follows a preceding nasalized vowel); tongue-trilled *r* and *rr* (written *r*, *rr*, and *rh*) the latter a reinforced form of the former and both carefully pronounced; the sibilants *s* (having the value of the English *ss*, and written *s*, *ss*, *e* before *e* or *i*, *c* before other vowels and occasionally *x*), *z* (pronounced like the English *z* and written *s* or *z*), *ç* (the phonetic notation for the English *sh* sound, represented in Portuguese by *ch*, *x*, *s*, *z*), and *ç* (the phonetic notation for the sibilant sound heard in the English *azure* and represented in Portuguese by *j*, *g* before *e* or *i*, *s*, and *z*); *y* (that is *i* or *e* with a consonantal value easily acquired in hiatus); *k* (the English *k* sound, denoted in Portuguese by *c* before *a*, *o*, *u*, by *q* before *ua*, by *qu* before *e* or *i*, by *ch* in a few learned words, and by *k* in some foreign words); and finally *g* (that is the sound in the English *go*, denoted by *g* before *a*, *o*, or *u* and by *gu* before *e* or *i*). Of the consonants *d*, *t*, *n*, *l*, it should be remarked that their dental character is more pronounced than in English, as in the formation of them the tongue tends to touch the base of the upper teeth. The linking together in utterance of syntactically related words in a sentence accounts for the variations in value of certain consonants; it does so particularly in the case of the sibilants *s* and *z*. One of the most marked features of the Portuguese as compared with other Romance languages is the loss of intervocalic *l* and *n*; thus *quacs* represents the Latin *quales* and *peessoa* the Latin *persona*. The forms of the article *o*, *a*, "the," are due to the intervocalic position of the *l* in such syntactical combinations as *de-lo*, *de-la*, 'of the,' whence have resulted the forms *do* and *da*, and by a re-division of the compound *d'o* and *d'a*. In common with

Spanish, but probably to a greater degree, Portuguese shows an interchange of *l*, *r*, and *n*. A metathesis of vowels, consonants, and even whole syllables of the Latin etymon is not infrequent in the language. As a result of linking or sentence-phonetics, contiguous vowels of different words in a sentence are often pronounced in a single syllable; thus *toda a armada* becomes in rapid speech *todaymada*.

In its grammar Portuguese rather closely parallels Spanish. A great body of the substantives has the distinctive endings of *a* for feminines and *o* for masculines, corresponding to the Latin first and second declensions. There are traces of the survival of the Latin nominative case (*Deos*, *Domingos*, etc.), but the accusative is in general the norm of the Portuguese form. The sign of the plural is regularly *s*. As in Spanish, the regular verbs of the *-ere* conjugation have joined either the conjugation in *-ere* or that in *-ire*. An extremely interesting phenomenon is the appearance of a personal or inflected infinitive, which makes possible a very succinct construction, comparable to the Latin accusative and infinitive. *Partir*, for example, may be conjugated: *partir eu*, 'I to depart;' *partires tu*, 'thou to depart;' *partir elle*, 'he to depart;' *partirmos nós*, 'we to depart;' *partirdes vos*, 'you to depart;' *partirem elles*, 'they to depart;' and 'it is time for us to depart' may be rendered *tempo é de partirmos*. The earliest written specimens of Portuguese appear to be certain documents of 1192.

Consult: Cornu, "Die portugiesische Sprache," in Groeber's *Grundriss der romanischen Philologie*, vol. i. (Strassburg, 1888); Coelho, *A lingua portugueza* (Porto, 1881); id., *Theoria da conjugação em latim e portuguez* (Lisbon, 1870); Gonçalves Vianna, *Bases da ortografia portugueza* (ib., 1885); id., *Exposição da pronuncia normal portugueza* (ib., 1892); Monaci and F. d'Ovidio, *Manuelletti d'introduzione agli studj neolatini*, vol. iii., *Portoghese* (Imola, 1881); De Souza, *Grammaire portugaise* (Paris, 1871); Von Reinhardtstoettner, *Grammatik der portugiesischen Sprache* (Strassburg, 1878); Elwes, *A Grammar of the Portuguese Language* (2d ed., London, 1884); Ribeiro, *Grammatica portugueza* (3d ed., Rio de Janeiro, 1889); Pacheco da Silva and Lameira de Andrade, *Noções de grammatica portugueza* (ib., 1887); Leite de Vasconcellos, *Dialecto brasileiro* (Porto, 1883); *O dialecto mirandez* (ib., 1882); *Flores mirandezas* (ib., 1884); *Mappa dialectologica do continente portuguez, precedida de uma classificação summaria das linguas por A. R. Gonçalves Vianna* (Lisbon, 1897); De Fonseca, *Novo dicionario da lingua portugueza* (3d ed., Paris, 1831); de Santa Rosa de Viterbo, *Elucidario das palavras*, etc., *que em Portugal antigamente se usaram* (2d ed., Lisbon, 1865); Vieira, *Grande dicionario portuguez ou Thesouro da lingua portugueza*, etc. (Porto, 1871); Da Silva, *Diccionario da lingua portugueza, com grande numero de termos novos usados no Brasil e no Portuguez da India* (Lisbon, 1877-78); Caldas Aulete, *Diccionario contemporaneo da lingua portugueza* (ib., 1881); Coelho, *Diccionario manual etymologico da lingua portugueza* (ib., 1890); Roquette, *Dictionnaire portugais-francais* (Paris, 1855); De Lacerda, *A New Dictionary of the Portuguese and English Languages* (Lisbon, 1871); Michaelis, *A New*

Dictionary of the Portuguese and English Languages (Leipzig, 1893); id., *Neues Wörterbuch der portugiesischen und deutschen Sprache* (ib., 1887-89); Barbosa Rodrigues, *Vocabulário indígena comparado para mostrar a adulteração da língua, complemento do Poranduba amazonense* (Rio de Janeiro, 1892); Dozy and Englemann, *Glossaire des mots espagnols et portugais dérivés de l'arabe* (2d ed., Leyden, 1869).

PORTUGUESE LITERATURE. The literature of the most westerly of the Romance lands, Portugal, was one of the latest to arrive at a consciousness of national unity and independence, and therefore one of the latest to begin to achieve a literary history. Furthermore, as a result of the somewhat sluggish and unassertive temperament of the people as a whole, Portuguese literature has been less independent than that of the sister tongues, and has been only too ready to limit itself to imitation of what had arisen within the bounds of Northern France, Provence, Italy, and especially of the near neighbor Spain. To the lack of any long-continued originality in the domain of Portuguese letters there has also contributed to a large degree the excess of sentimentality and the consequent elegiac effusiveness that mark the national character and life. So it is that the lyric spirit, with decided tendencies toward the idyllic and the bucolic, has ever predominated in Portugal. It was so at the very outset, for whereas lyric verse followed in the wake of epic verse in Spain and in France, it appeared at the very beginning of literary activity in Portugal, and the epic appeared there only three centuries and a half later, and then as the result of a consciously artistic development. And the love lyric, from which we date the rise of Portuguese literature, was not of spontaneous growth or native to the soil; on the contrary, it was an exotic that had thriven in France before it was transplanted to the more westerly land.

According to the scheme adopted by Theophilo Braga and by C. M. de Vasconcellos, six main periods may be distinguished in the course of Portuguese literary history.

(1) In the first period (1200 to 1385) the impulse to literary production came from France. The first Portuguese dynasty was founded by Burgundian nobles, in whose train there entered into the land, with their French habits and predilections, soldiers and colonists who settled on the territory regained from the Arabs during the age of the reconquest. Moreover, the constant pilgrimages to the shrine of Saint James at Compostella, ecclesiastical relations of various kinds, and royal and noble intermarriages, made the relations between France and Portugal exceedingly close. The more important literary influence at this early stage was that which entered from Southern France. The troubadours early penetrated into the western territory and met with particular favor in Galicia, a district linguistically connected with Portugal. Their strains were soon taken and reëchoed by native poets, who imitated as well as they might the love lyric, the panegyric, the satire, the debate, and the other conventional poetical forms of Provence. The high-water mark of composition in Provençal measures and according to Provençal ideals was reached in the reign of the King Dom Diniz

(1279-1325), the greatest of all the native troubadours, whose poetical gifts were inherited by his natural sons, Alfonso Sauches and Pedro, Count of Barcellos. Of these poets and some two hundred others of this period there are preserved about 2000 poems, nearly 140 of which are from the pen of the monarch himself, and not a few of them are due to courtiers such as the Chancellor Estevam da Guarda and the Admiral Gomes Charinho. We find the great body of this verse in certain Cancioneiros or song books, one set of which contains the Galician lyrics of the Castilian monarch Alfonso the Wise; three of them—the Cancioneiro da Ajuda and the Cancioneiro do Vaticano, so named from the libraries in which they are deposited, and the Cancioneiro Colocci-Braucuti, bearing the name of its present and former owners—have the poems of native Portuguese authors. Although the prevailing tone in the Galician-Portuguese literature of this age is that of the artificial Provençal lyric, there is a noticeable tendency to take up and adapt popular forms of a kind that still live on in the oral tradition of Portugal and Northern and Western Spain.

Prose composition at this time consists chiefly of translations from Latin—lives of saints, visions of the other world, etc.—and of translations and imitations of material borrowed from Northern France and already well known in Spain, such as the Charlemagne and the Arthurian stories (cf. the *Cavalleiros da Mesa Redonda*, one of the few of them that have thus far been published) and those dealing with the quest of the Holy Grail. It has been asserted that original composition of chivalrous romances began in Portugal as early as the fourteenth century; for some think that the *Amadis de Gaula*, of which the earliest form preserved is a Spanish version, was written originally in Portuguese at this time and was taken thence by Spanish translators and elaborators. (See SPANISH LITERATURE.) Historical writing is represented by the appearance of chronicles dealing with religious matters or with military undertakings (*Chronica da conquista do Algarve*) and things of political import, and by the appearance also of genealogies like the *Nobiliário* ascribed to the Count of Barcellos.

(2) The second period continues from 1385 to 1521. The time is really one of transition and evidences by the increased interest taken in the works of classic antiquity the influence of the all-pervading Renaissance movement. The best spirits begin to turn away from Provençal ideals, and, in imitation of the course pursued by the chief Spanish writers, adopt not infrequently a more serious didactic tone, which is borne out by use of the Dantesque allegory.

The bulk of the poetry of the age was produced by the *poetas palacianos* of the courts of João II. (1481-95) and Emanuel the Great (1495-1521). Garcia de Resende, one of these poets, played a part similar to that performed by Baena at the Court of Castile, by collecting and publishing at Lisbon in 1516 the verse of the numerous *poetas palacianos*. Four of the authors represented in this *Cancioneiro Geral* of Garcia de Resende merit particular mention. They are Gil Vicente, who is more remarkable, however, for the development which he gave to the drama; Christovam Falcão, whose idyll *Crisfal*—the first composition of this favorite kind in Portuguese—records his own love experiences; Bernardim Ribeiro, the author

of eclogues and of the famous *Saudades*, a work which with its pastoral and sentimental tendencies furnished the foundation of all such later productions in the land; and Sá de Miranda (1495-1558), who, although he utilizes still the older poetical forms, infuses them with a new spirit and appreciates fully, as did to a considerable degree Falcão and Ribeiro, the value of the popular pastoral exemplified by the *serranilha* and similar compositions.

In prose the most important original works are didactic or historical in their nature and there is some translation of the Latin moralists and historians. By direction of King Duarte there was composed a treatise on statecraft, entitled *O leal conselheiro*, and the Infante Dom Pedro gave expression to the experiences of an active and observant life in his *Virtuosa beneficentia*. The founder of true history writing appears in the person of Fernam Lopes, who compiled the *Chronica de Dom Fernando*, the *Chronica de Dom Pedro*, and especially the *Chronica del Rey Dom Johann de boa memoria*. Further historical accounts were provided by Gomes Eannes de Azurara, who described the conquest in Africa, by Ruy de Pina, and by Joam Alvares (*Chronica do sancto Iffante Dom Fernando*).

(3 and 4) The two periods that come next and embrace the long stretch between 1521 and 1700 may conveniently be regarded as forming one continuous period, an age of glory in its first part and one of decadence and stylistic exaggeration in its second. The path that Portuguese literature was now to take was indicated by Sá de Miranda, who returned in 1526 from his sojourn in Italy, imbued with a love for Italian humanism. Before the visit to Italy Miranda had given new life and enduring consistency to the pastoral; now, along with the sonnet, the hendecasyllable, the octave, the *terza rima*, and other Italian lyric and narrative verse forms, he introduced elements of the highly refined Italian pastoral; and, furthermore, under the influence of Bibbiena and Aristot, he produced two prose dramas, the *Estrangeiros* and the *Vilhalpandos*, which necessarily, like their Italian originals, derive from the drama of Plautus and Terence. It cannot be said that the plays of Sá de Miranda had any widespread popularity; but they indicated the way for his disciple Jorge Ferreira de Vasconcellos, who chose a national subject, and in his *Ines de Castro* gave Portugal her first classic tragedy, just as in his play *O cioso* he gave modern Europe one of its earliest character comedies. The Italian lyric measures imported by Sá de Miranda were adopted by many disciples (the *Quinhentistas*), who modeled themselves on the singer of Madonna Laura. A thoroughly popular drama was that developed by Gil Vicente (c.1470-c.1540). He derived his inspiration from the Spanish playwright Juan del Encina, but he sought his subjects on all sides, and developed them with great originality of treatment and in a wholly national spirit. A third figure of this period rendered illustrious by Sá de Miranda and Gil Vicente is the most famous of all Portuguese poets, Luiz de Camões (c.1524-79). Like those two authors, he aspired to dramatic honors, and in three early comedies (*Filodemo*, *Rei Seleuco*, and *Enfatriões*) he showed himself to be an ingenious playwright. His fame, nevertheless, rests rather upon his lyric and epic achievements. The fiery passion and sentiments of the man and

lover find expression in his various lyrics. The personal note rings out also in his glorious epic *Os Lusíadas*, filled with the spirit of national consciousness and patriotic fervor excited by a realization of the large part that Portugal had played in geographical discovery and in the conquest of territory in the distant Indies.

In the second part (1580-1700) of this long period the number of writers is legion, but the great majority of them lacked originality and force. Many *Camonistas* or disciples of Camões essay the epic, e.g. Francisco de Andrade (*Primeiro cerco de Diu*, 1589), Sá de Menezes (*Malacca conquistada*), Pereira Brandão (*Elegiada*, 1588, commemorating the disastrous campaign of Dom Sebastian), Quevedo e Castello Branco (*Affonso Africano*, 1611), Pereira de Castro (*Ulysses*, 1636), but none rise above mediocrity. The sadness and gloom resultant upon subordination to Spanish rule were not favorable to the composition of eminent or stirring epics. The tightening of the political bonds to Spain superinduced an even larger degree of servility to Castilian literary fashions and Gongorism with its formal excesses, its bombast, its studied obscurity of style, and its strained conceits, invaded Portugal. Among the lyric poets of the time are Rodrigues de Castro, Lobo Soropita, Frei Bernardo de Brito, the nun Violante do Ceo (1601-93), and Manoel de Faria e Sousa; writers of pastoral poems and romances are Francisco Rodrigues Lobo (*Primavera*, *Pastor peregrino*, and *O desencanado*), Alvares do Oriente (*Lusitania transformada*), and Manoel da Veiga Tagarro. The taint of culteranism is deplorably clear in the verse contained in the collections entitled *A fenix renascida* and *Ecos que o clarim da fama da*. A natural note is struck in the unaffected lyrics of the historian Manoel de Mello. Spanish *siglo de oro* plays held full sway on the Portuguese stage; but Manoel Coelho Rebello did produce humorous interludes in the home speech.

Composition in prose toward the middle of the sixteenth century was largely concerned with pastoral and chivalrous romances and with tales. The renowned chivalrous romance, *Amadis de Gaula*, so persistently claimed for Portugal by certain historians of her literature, was an exceedingly popular book, and it led to the writing of continuations and imitations of it, as an example of which may be cited the *Palmerin d'Inglaterra* of Moraes (1544). The *Celestina* story of Castile is somewhat less drastically copied by Jorge Ferreira de Vasconcellos in three tales, and a more native tradition appears in the tales of Fernandes Trancoso. Unfortunately for Portugal, the best pastoral poem of the age, the *Diana* of the Portuguese Jorge de Montemor, was written in Spanish. The sonorous and rhetorical qualities of Portuguese prose were excellently shown forth by Rodrigues Lobo in his *Corte na aldeia e noites de inverno*. The historians direct their attention particularly to the adventures of Portuguese heroes and arms in the Indies. The romantic side of the expeditions of exploration and conquest is made prominent in the collection termed *Historia tragico-maritima*. Other ambitious efforts are those of Barros in his *Decadas* and Albuquerque the Younger in his story of his father's deeds (*Commentarios*): personal observation guided the records left us by Pinto, by Fernam Lopes de Castanheira, and by Correia. Several chronicles register the note-

worthy events of the lives of the monarchs of the period of conquest; and a number of works of a comprehensive nature seek to furnish a general history of the fatherland. Manoel de Mello wrote most of his historical treatises in Spanish; his *Epanaphoras de varia historia portugueza* (1660) is in Portuguese. Pulpit eloquence is most ably represented by the discourses and sermons of the Jesuit Antonio Vieira (1608-97); and Portuguese epistolary style is seen at its best in the *Cartas* of both Vieira and Manoel de Mello.

(5) During the period from 1700 to 1825 French Classicism ruled supreme in Portugal. Xavier de Meneses promulgated his verse translation of Boileau's *Art poétique* and sought to apply its precepts in his tedious epic, the *Henriqueida*. The Academia Real Portugueza was founded (1721) in the hope that it would control the literary destinies of the land; but it proved to be powerless, though the coterie of poets banded together in the Arcadia became really influential. The Arcadians were actuated somewhat by the wholesome principle of combining the plastic and correct forms of French Classicism with elements derived from domestic models of the sixteenth century; but in the main the native tradition was slighted. Correa Garção and Antonio Diniz da Cruz e Silva were Arcadians who preached Horace and Boileau to their compatriots; Antonio Diniz's *Hyssope*—modeled on Boileau's *Lutrin*—is the most noted mock-heroic in Portuguese. Dramatic production is almost wholly in accordance with French rules. To the second half of the century belong its two most eminent authors, Francisco Manoel do Nascimento (1734-1819; known in the Arcadia by the pseudonym of Filinto Elysio) and Manoel Maria Barbosa du Bocage (1765-1805). Nascimento was a gifted lyric poet, with a refined and pleasing diction, which stood him in good stead also in his prose translation of Osorio's Latin history of Emanuel the Great. The poetic talent of Bocage, who founded the Nova Arcadia (in which he was styled Elmano), was even more pronounced; no Portuguese poet has surpassed him in the use of the sonnet. Both Nascimento and Bocage had followers. To Bocage's unskillful imitators is due a new form of culteranism, for which the master has been unjustly blamed and to which the term *Elmanismo* has been improperly applied. A pretentious rival of Camões was José Agostinho de Macedo (1761-1831), who has now lost a good deal of the prestige that he once enjoyed by reason of his epic *O Oriente*.

(6) The nineteenth century. The Peninsular War and the fierce struggle against Napoleonic encroachments stirred patriotic feeling in Portugal to greater activity than had been witnessed for several centuries. As everywhere else in Europe, modern liberal thought made much headway in the land, and as everywhere else the young exponents of modern scientific ideas came into conflict with the unprogressive government of the country. João Baptista da Silva Leitão, Viscount d'Almeida-Garrett (1799-1854), returned from a period of expatriation spent in England and France, imbued with the Romantic principles which he found fully established in those lands, and with the strong desire to study the past of his own country and to revive its literary traditions. Even while still in exile he composed the noble poem *Camões* (Paris, 1825), replete with patriotic fervor, the satirical poem

Dona Branca, and the versified novel *Adozinda* (London, 1828), the last named based on Portuguese folk tales. Many-sided in his endeavors, Almeida-Garrett contributed efficaciously to the creation anew of a national drama, reviving in such plays as *Um auto de Gil Vicente*, *O alfageme de Santarém*, and *Philippa de Vilhena* the older tradition of the theatre of Gil Vicente. His lyric achievements were less splendid than might have been expected, but, on the other hand, his success in the historical novel, which he essayed under the influence of Scott, amply compensates for this slight deficiency. Scott was already well known in Portugal, having been translated and even imitated by Alexandre Herculano de Carvalho e Araujo (1810-77), who passed his exile in England. Events and pictures of the reign of João I. are presented to us in his *Henrico* and his *Mongé de Cister*, and some eight centuries are covered by his *Lendas e narrativas*. A residuum of Romantic feeling along with a more pronounced tendency toward the formal methods of the Arcadians may be perceived in the lyrics of Antonio Feliciano de Castilho (1800-75). His *Ciumes do Bardo* and his *Noite do Castello* have the Romantic tinge; his *Cartas de Echo a Narciso* and later volumes like the *Excavações poeticas* and the *Outono* show stress laid rather upon Arcadian elegance and finish of outward poetical form. In recent times the drama, the historical novel, and the lyric have been cultivated by many followers of the three leading authors mentioned, and at least a moderate degree of success has been attained by Augusto Rebello da Silva (historical romances, *A mocidade de Dom Joao V.*, etc.), Mendes Leal, Silva Gayo, and especially Camillo Castello Branco (1825-90), who has the credit of having created the modern Portuguese novel of manners. An unwholesome sentimentalism prevails in the lyrics of Soares de Passos; a romantic tone as well as some of the polish of Castilho's verse can be recognized in the poems of Thomaz Ribeiro.

Although the Romantic doctrines are still professed by a number of Portuguese writers, a not unnatural reaction against the exaggerations of ultraromanticism has set in since 1865 and has found expression in the aims and utterances of writers of the School of Coimbra, an appellation which does not sufficiently indicate the expansion of the new movement. Under the influence of Hegelianism and the positivist doctrines of Comte, this movement has sought to develop a strictly scientific spirit, and to apply it to the sober investigation of the mediæval past. An encouraging sign of the success of the reform thus undertaken is the appearance of the poet João de Deus (Nogueira Ramos), the author of the lyrics *Flores do campo* (1869), *Ramo de flores*, and *Despedidas de verão*. Equally encouraging is the energy with which scientific investigation and literary study have been undertaken by persons of the ability of Theophilo Braga, Gonçalves Vianna, J. Leite de Vasconcellos, and Coelho.

BIBLIOGRAPHY. Vasconcellos, "Geschichte der portugiesischen Litteratur," in Gröber's *Grundriss der romanischen Philologie*, vol. ii. (Strassburg, 1894); Braga, *Historia da litteratura portugueza* (in course of publication since 1870; most of the volumes were published at Oporto, a few at Lisbon); id., *Curso de historia da litteratura portugueza* (1886); Costa e Silva, *Ensaio bio-*

graphico-critico sobre os melhores poetas portuguezes (Lisbon, 1850-56); Andrade Ferreira and C. Castello Branco, *Curso de litteratura portugueza* (Lisbon, 1875-76); Almeida-Garrett, *Paranaso lusitano* (Paris, 1826); Bellermann, *Die alten Liederbücher der Portugiesen* (Berlin, 1840); F. Diez, *Ueber die erste portugiesische Kunst- und Hofpoesie* (Bonn, 1863); R. Pinto de Mattos, *Manual bibliographico portuguez* (Oporto, 1878); F. de S. Boaventura, *Collecção de inditos portuguezes dos seculos XIV. e XV.* (Coimbra, 1829); I. F. da Silva, *Diccionario bibliographico portuguez* (Lisbon, 1858-70), with supplement by Brito Aranha (Lisbon, 1883-90); J. H. da Cunha Rivara, *Catalogo dos manuseriptos da Bibliotheca Eborensis* (Evora, 1850-70); F. F. de la Fignière, *Bibliographia historica portugueza* (Lisbon, 1850); Pinheiro, *Curso de litteratura nacional* (Rio de Janeiro, 1862); M. Formont, *Le mouvement poétique contemporain en Portugal* (Lyons, 1893); Storek, *Aus Portugal und Brasilien* (Münster, 1892); J. Leite de Vasconcellos, *Cancioneiro portuguez* (Oporto, 1880).

PORTUGUESE MAN-OF-WAR. The popular name of certain remarkable siphonophores (q.v.) of the genus *Physalia*. The pneumatophore or float is an oblong, crested bladder, flattened on the lower side, from which are freely pendent the various individuals of the colony. The most notable of these are the long capturing filaments, which are extraordinarily fine and contractile, and are very richly supplied with the nettle-cells, so characteristic of cœlenterates

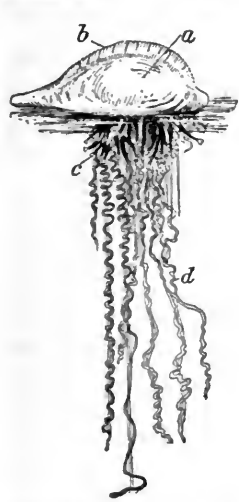

PORTUGUESE MAN-OF-WAR.
a, Swimming bell; b, crest of same; c, reproductive zooids; d, nutritive zooids (tentacles).

the most common Portuguese man-of-war in the western Atlantic is *Physalia peltagica*, which has the float six or eight inches long and two or three inches high. The float is a bright, iridescent blue, shading in some places into purple, with the lower part and edges red. The individuals of the colony are chiefly red, though various parts are blue. The float contains a gas, possibly air, which seems to be secreted by glandular epidermal epithelium at its bottom. The gas can be expelled through an air-pore, by which

the interior is always in communication with the outside. By contraction of its float, the animal can sink below the surface, to which it rises again during calm weather. Portuguese men-of-war are found chiefly in the warm seas, and in some places in the tropics large numbers are blown ashore when the wind has blown landward for an unusual length of time. They are also carried northward in the Gulf Stream, and during the latter part of the summer are often seen off the southern coast of New England.

PORTUGUESE POLITICAL PARTIES. See **POLITICAL PARTIES**, paragraph *Portugal*.

PORTUGUESE VERSION. See **BIBLE**.

PORTUGUESE WEST AFRICA. A Portuguese colony on the west coast of Africa. See **ANGOLA**.

PORTUNUS, or **PORTUM'NUS** (Lat., from *porta*, door, *portus*, port). The Roman divinity, originally of doors, then of harbors, and hence represented with a key. His festival, the Portunalia, was celebrated annually on August 17th at his temple on the Tiber.

PO'RUS (Lat., from Gk. Ἰᾶρος) (?-B.C. 317). An Indian king, the most powerful of all those conquered by Alexander the Great (q.v.). His kingdom lay in the north of India between the Hydaspes and Acesines (the modern Jhelam and Chenab), and he was a monarch of much importance and ancient lineage. When Alexander reached the Jhelam in his invasion of India in the spring of B.C. 326, he found Porus awaiting him with a strong army on the site of the modern town of Mong. After some delay the Macedonian force succeeded in crossing the river by stratagem followed by open approach, and a fierce battle ensued, in which Porus was wounded and made captive. When the conqueror retired from India in the following year, he left Porus as ruler over the lands west of the Jhelam, comprising seven nations, and in addition made him an ally of his former enemy and rival Taxiles, probably Ambhi, Raja of Takshasila. After the death of Alexander, Porus seems to have extended his power over Sindh by expelling Peithon, the Greek ruler. In 317 Porus was assassinated by Eudemus, who had been made satrap of the Punjab by Alexander to administer its affairs with Taxiles. The name Porus obviously represents the Sanskrit *Pāurava*, or member of the race of Puru, a legendary monarch of the so-called lunar dynasty, whose descendants are represented by the Sanskrit writings as dwelling in the north of India.

The same name was borne by at least two other kings, one a nephew and enemy of the great Porus. He was driven by Alexander from his country of Gandaris (Sanskrit *Gandhāra*), on the left bank of the Indus. There was also a Porus, King of Madura, who sent gifts and an embassy to the Emperor Augustus. Consult McCrindle, *Invasion of India by Alexander the Great* (2d ed., Westminster, 1896).

POR'Y, JOHN (c.1570-1635). An English colonist and geographer. He graduated at Gonville and Caius College, Cambridge, in 1592, studied history and geography for a time after 1597 under Hakluyt, and in 1600, at Hakluyt's suggestion, made a translation of the *Geographical Historic of Africa written in Arabicke and Italian by John Leo, a More*, which at that period was considered the only original authority con-

cerning North and Central Africa. From 1619 to 1621 he was secretary to Sir George Yeardley, Governor of Virginia. While in Virginia he made several excursions among the Indians, the accounts of which, in Smith's *Generall Historie*, are of historical interest. He returned to England in 1621, but in 1623 went back to Virginia as a commissioner from the Privy Council.

POSADOWSKY-WEHNER, pò'zà-dòv'skè-và'nër, ARTHUR ADOLF, Count von, Baron von Postelwitz (1845—). A German statesman, born at Grossglogau, Silesia. After studying law and political science at Heidelberg, Berlin, and Breslau, he turned his attention to agriculture in 1869 and entered the Government service, at Posen, in 1871. As a Deputy to the Prussian House of Representatives in 1882-85 he sided with the Free-Conservatives. Elected president of the province by the Estates of Posen, in 1889, he completely reorganized the administration of the province, and in 1893 was appointed State secretary of the Imperial treasury. Succeeding Bötticher as Minister of the Interior in 1897, he was entrusted with the representation of the Imperial Chancellor, and made Prussian Minister of State. The German tariff of 1902 was one of the prominent results of his administration. He is the author of a *Geschichte des schlesischen uradligen Geschlechts des Grafen Posadowsky-Wehner* (Breslau, 1891).

POSCHINGER, pòsh'ing-ër, HEINRICH, Ritter von (1845—). A German administrator and author. He was born at Munich, studied law there and in Berlin, was for some years employed in the Bavarian State service, and in 1876 entered the Imperial employ as assistant in the chancery office. Afterwards he removed to Berlin, entered the Department of the Interior, and became governmental privy councillor. He wrote: *Bankgeschichte des Königreichs Bayern* (1874-76); *Banken im deutschen Reiche, Oesterreich und Schweiz* (1877); *Bankwesen und Bankpolitik in Preussen* (1878-79); *Preussen im Bundestag* (2d ed. 1882-85); *Lasalles Leiden* 4th ed. 1889); *Bismarck als Volkswirtschaft* (1890); *Ansprachen des Fürsten Bismarck* (1894-99); and many other works on Bismarck, politics, and banking. Poschinger edited, besides many documents relating to Bismarck, *Denkwürdigkeiten des Ministerpräsident Otto Fürst von Manteuffel* (1901) and *Kinkels sechsmonatliche Haft im Zuchthause zu Naugard* (1901).

POSEIDON, pò-sí'don. See NEPTUNE.

POSEN, pò'zen. A province of Prussia, bounded by Pomerania and West Prussia on the north, Russian Poland on the east, Silesia on the south, and Brandenburg on the west (Map: Prussia, G 2). Its area is 11,184 square miles. The surface is mostly flat. There are extensive tracts of wooded marshland, now partially converted into agricultural land. Posen is watered principally by the Warta and the Netze, and to some extent by the Vistula. There are a large number of lakes and some important canals. Posen is chiefly an agricultural country. Over 60 per cent. of its area is under tillage and in gardens. In the distribution of land large holdings prevail, about 58 per cent. of the productive land being divided into estates of 250 acres and over. Rye, wheat, oats, barley, and potatoes are produced extensively and partly exported. Large quantities of

sugar beets are raised for local sugar mills. Cattle-raising is very important, and the census of 1897 shows a large increase in the live stock of the province.

The manufacturing industries are only slightly developed and employ (including all other industries outside of agriculture) only 20 per cent. of the total population. The principal manufactures are spirits (of which Posen is one of the chief producers in Germany), beet sugar, machinery, bricks, and wooden wares. The exports include grain, cattle, wood, and wool. The railway lines have a total length of over 1200 miles, almost exclusively controlled by the State. Posen is divided administratively into the two districts of Posen and Bromberg, with the town of Posen as the capital. In the Prussian Landtag the province is represented by 19 members in the upper and 29 delegates in the lower chamber. It returns to the German Reichstag 15 members. The population, in 1900, was 1,888,055, of whom about 70 per cent. were Roman Catholics. The Polish language and its dialects are spoken by the majority of the inhabitants. Posen formed a part of Poland till the first partition of that country in 1772, when Prussia acquired the districts north of the Netze. The other portion was taken by Prussia at the second partition in 1793. In 1807 it was annexed to the Duchy of Warsaw, but was restored to Prussia in 1815, receiving the title of a grand duchy. Posen has been the scene of bitter strife between the Polish and German elements, and the Prussian Government has resorted to arbitrary measures in its efforts to Germanize the region.

POSEN (Pol. *Poznan*). The capital of the province of the same name in the eastern part of Prussia, situated at the confluence of the Cybina with the Warta, 90 miles north of Breslau (Map: Prussia, G 2). It is a first-class fortress and has a strong garrison. Its appearance has been greatly improved by the building of new quarters and the construction of modern buildings. Of its numerous churches the most noteworthy are the eighteenth-century cathedral, well known for its golden chapel and for its fine monuments and the bronze statues of the first two Christian kings of Poland, the seventeenth-century parish church, and the fifteenth-century Marienkirche, the oldest church in Posen. The principal secular edifices are the old town hall, rebuilt after the fire of 1536 and adorned with a slender tower 214 feet high; the adjoining modern town hall in Renaissance; the royal palace containing the State archives; the Raczyński palace with the library of the same name; and the German theatre. Posen has a Roman Catholic and an Evangelical gymnasium, a seminary for teachers, and one for Catholic priests. The old fortifications are being demolished. The new ones comprise about 12 inner and 20 outer forts. The principal manufactured products are machinery of various kinds, spirits, flour, furniture, and cigars. There is also some trade in wood, grain, wool, and spirits. The population rose from 73,200 in 1890 to 117,014 in 1900, the increase being due principally to the annexation of adjacent rural communities. The inhabitants are principally Roman Catholics.

Posen is one of the oldest cities of Poland. It became the see of a bishop in the tenth century and was the residence of the early Polish mon-

archs. It was a member of the Hansa and attained great prosperity in the sixteenth century, but afterwards declined, its population at one time having dwindled to about 12,000. The western part of the city was founded by Germans in 1253 and had a separate administration until the annexation of Posen to Prussia in 1793.

POSEY, pō'zi, THOMAS (1750-1818). An American soldier. He was born in eastern Virginia, but removed to the western part of the colony in 1769, became quartermaster under Gen. Andrew Lewis, in Lord Dummore's War (q.v.), and took part in the battle of Point Pleasant on October 10, 1774. Early in 1775 he became a member of one of the Virginia committees of correspondence, and on July 8, 1776, helped defeat Lord Dummore at Gwynn's Island. He was appointed captain of a Virginia company March 20, 1776, joined the Continental army early in 1777, and was soon assigned to Morgan's corps of riflemen, with which he served in the campaign against Burgoyne, distinguishing himself in the battles of Saratoga. In October, 1778, as major, he commanded one of the regiments sent against the Indians in the Wyoming Valley; in 1779 he commanded a battalion under Wayne, and was conspicuous at the assault in Stony Point; and subsequently (1781-82) served under Wayne in Georgia and helped to repel an attack of Indians under Gueristersigo on June 23, 1782. In 1793 he became a brigadier-general and led a division of Wayne's army against the Indians, but resigned his commission in February, 1794. He then settled in Kentucky, and became successively State Senator, Lieutenant-Governor (1805), and major-general of militia (1809). He subsequently removed to Louisiana and was United States Senator from that State (December, 1812-February, 1813). From 1813 to 1816 he was Governor of Indiana Territory and from 1816 to 1818 was an Indian agent.

POSIDIP'PUS, or **POSEIDIPPUS** (Lat., from Gk. Ποσειδῖππος, *Poseidippus*). A Greek comic poet, the last exponent of the new comedy, dating from the first half of the third century B.C. He was born at Cassandria in Macedon, lived at Athens, and wrote 40 comedies, of which 18 titles have come down to us, and a few fragments, published in Koek, *Comicarum Atticorum Fragmenta*. His *Didymoi* ("The Twins") was the original of Plautus's *Menæchmi* and of Shakespeare's *Comedy of Errors*. It is probable that others of his plays were imitated by the Roman comedian. A remarkably fine statue of Posidippus is in the Vatican at Rome.

POSIDONIA (Lat., from Gk. Ποσειδωνία, *Posidōnia*). The ancient name of Paestum (q.v.).

POSIDONIUS (c.128-45 B.C.). A Stoic philosopher, born at Apamea, in Syria. He was a pupil at Athens of Panætius, whom he succeeded as the leader of the Stoics; and was a teacher of Cicero, who frequently speaks of him with praise. Pompey visited him B.C. 67, at Rhodes, where the greater part of his life was passed, and again B.C. 62, after the close of the Mithridatic War; and Posidonius wrote a history of the wars of Pompey. He went to Rome in B.C. 51. Besides his philosophical works, he wrote treatises on history, astronomy, and geography, of which we have only the titles and a few quotations preserved by Cicero, Strabo, and others. He wrote *Meteorologica*, and Cicero alludes to

his artificial sphere, which represented the motion of the heavens. The slight fragments from his works are published in Müller's *Fragmenta Historicorum Græcorum* (Paris, 1841-51).

POSILIPO, pō-zō'le-pō. A mountain ridge southwest of Naples, remarkable for the tunnel known as the Grotta di Posilipo, through which the road from Naples to Pozzuoli formerly passed. The grotto is in some places 70 feet high and 21 feet wide, and is 2244 feet long. Strabo assigns its construction to M. Coecilius Nerva, superintendent of aqueducts in the time of the Emperor Tiberius. Above the eastern archway of the grotto is the so-called 'tomb of Vergil.' At the base of the hill of Posilipo anciently stood the poet's villa, in which he composed the *Eclogues* and *Georgics*, if not also the *Æneid*. Since 1885 new tunnels have been built for the railroad and steam tramway to Naples. Near by is the village of Posilipo, with 4500 inhabitants. The surrounding country is rich in vineyards and olive groves.

POSITION (Lat. *positio*, from *ponere*, to place, from **po-*, down, Gk. ἀπό, *apo*, Skt. *apa*, off + *sinere*, to allow). In music, a term having reference to the arrangement of the different tones of a chord. A chord is said to be in *fundamental position* when its fundamental tone is in the bass. In its first inversion (the third in the bass) it is in its *second position*; in its second inversion (the fifth in the bass), in its *third position*. Thus *a*, *b*, *c*, and *d* are first, second, and third positions, respectively, of the C major chord. (See CHORD.) A chord is also said to be in *close position* (close harmony) when all its tones are placed so closely together that it is not possible to introduce another note belonging to that chord between those notes, as:



A chord is in *open position* (open or extended harmony) when its several tones are spread out so that one or more tones belonging to that chord can be introduced within the compass of the chord, as

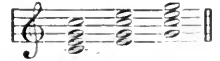

(See HARMONY.) On the violin the word *position* has reference to the several systems of fingering. There are seven positions generally recognized (although for the highest tones use is made of the eleventh and even thirteenth position). The *first position* is that, when the lowest tone of the lowest string (G) is played on the open string, using the first finger for *a*, the second and third for *b* and *c*, then passing to the open D string, using the three fingers for *e*, *f*, *g*; then to the open A string, etc. The *third position* begins with the first finger on *b* (G string), the second, third, and fourth on *c*, *d*, *e*, respectively; then passing to the D string with *f* produced by the first finger, etc. (See VIOLIN.)

POSITION-FINDER. See RANGE-FINDER.

POSITIVISM (from OF. Fr. *positif*, from Lat. *positivus*, settled by arbitrary appointment, from *ponere*, to place). A term invented by Auguste Comte (q.v.) to designate his system of philosophy, inasmuch as that system purported to exclude all metaphysical theorizing and to confine itself to 'positive' scientific knowledge of facts. It attempted to reduce the whole universe

to experiential terms, excluding supernatural and spiritual agencies, hidden forces and immaterial essences, and causation regarded as a mysterious tie binding phenomena together. Instead of causes it looked for laws, i.e. the uniformities of coexistence and sequence among phenomena. When a certain uniformity has been discovered, no reason can be assigned, it claimed, for that uniformity. The uniformity is a fact given us by our experience, and reasons for facts do not exist. Though Comte invented the term positivism, he was not the first positivist. Indeed, views more or less fundamentally like his can be discovered in Greek philosophy, especially among the sophists. In modern times Hume (q.v.) deserves to be called a positivist by reason of his view of causation, although with Hume the reign of natural law was a subjective rather than an objective fact. This subjectivism differentiates him from the prominent positivists of to-day. Kant's philosophy in recent times has also given rise to a school of thinkers in Germany who are one with Comte in throwing aside all considerations of metempirical character and in confining all scientific knowledge to phenomena and actually observed relations between phenomena. Prominent among these German thinkers are Laas (q.v.), Riehl (q.v.), T. Ziegler, and F. Jodl. Allied with these are such thinkers as Schuppe, Rehmke, and Averarius, all differing from each other, but insisting that the task of philosophy is to state the highest laws of experience, and all denying that there is anything behind experience. In England the tendency of positivism has lately been to appeal to the feelings by the establishment of a church with ritual, ceremonies, and the like, all in the worship of humanity. This tendency has its point of departure in Comte's religion of humanity. The leaders of this movement have been R. Congreve and Frederic Harrison. Of the last generation Lewes (q.v.) was the English protagonist of positivism, but he was interested more in its philosophical than its religious side. In France E. Littré and H. Taine have been the most noted positivists, while Renan was greatly influenced by Comte's doctrines. For bibliography, see the article COMTE, AUGUSTE. Consult, also: Bridges, *A General View of Positivism* (London, 1865); David (D. G. Croly), *A Positivist Primer* (New York, 1871); Balfour, *The Religion of Humanity* (Edinburgh, 1888); Fouillée, *Le mouvement positiviste et la conception du monde* (Paris, 1896); Huxley, "Scientific Aspects of Positivism," in his *Lay Sermons* (London, 1871); Laas, *Idealismus und Positivismus* (Berlin, 1879); Fiske, *Outlines of Cosmic Philosophy* (Boston, 1874); Gruber, *Der Positivismus vom Tode Auguste Comtes bis auf unsere Tage* (Berlin, 1891).

POSO. See CHICA.

POSSE (pōs'sè) **COMITATUS.** A legal term, meaning power of the country. As used in military law it refers to the employment of the army to aid in enforcing the laws. Such use is forbidden by statute except in cases where it is expressly authorized by the Constitution or by Congress (20 Stat. L. 152). The army regulations prescribe the manner in which troops shall be employed to aid the civil authorities as a posse comitatus or in execution of the laws of the United States.

POSSESSION, LAW OF (Lat. *possessio*, from *possidere*, to possess). Possession is primarily a matter of fact. It is the control by a person of a tangible thing. The degree and kind of control necessary to constitute possession vary with the nature of the thing possessed and the habits of the community. He who controls a thing as owners of things usually control them is possessor of the thing.

Possession is quite independent of any legal right to possess. A thief possesses the thing he has stolen; and the person who has surreptitiously or by force placed himself in control of a house possesses the house.

ADVANTAGES OF POSSESSION. To the possessor as such, without regard to his right to possess, every legal system, even in the highest stage of development, accords certain advantages. The possessor is protected against every one who has no better right than himself. He is protected against disturbance (trespass), and if wrongfully dispossessed he recovers possession simply on the ground of his prior possession and the wrongfulness of the dispossession. Even when his adversary has a superior right to possess, the possessor may be protected against forcible dispossession.

Further, possession is, as the English lawyers express it, a 'root of title.' At Roman law ownership cannot be acquired without acquisition of possession, although when acquired it survives the loss of possession. Finally, in every system of law possession ripens by prescription (q.v.) into full property right.

LEGAL POSSESSION. In determining to what persons, and under what circumstances, the legal advantages above indicated shall be accorded, every legal system develops a more or less artificial doctrine of possession. Persons having physical possession without the legal advantages of possession are not legal possessors; in civil-law terminology they are 'detentors.' On the other hand, persons not having physical possession, but enjoying the legal advantages accorded to possession, are termed 'possessors.' In some cases one person is treated as legal possessor as regards protection against disturbance and against dispossession, while another person is regarded as possessor for the purposes of prescription.

The law of possession is less clearly developed in the English law than in the Roman and modern civil law. This is due partly to the fact that the English law employs the same actions, viz. trespass, ejectment, and trover, for the protection of possession and for the enforcement of property right, while the Roman law has distinct possessory remedies. In their practical operation, however, the two systems attain substantially similar results.

In both systems (as indeed in every legal system) the person who has physical control of a thing and holds it for himself—the person who, as the Roman jurists express it, has both the *corpus* of possession and the *animus possidendi*—is a legal possessor. Those who hold for others are differently treated in different systems. In no legal system are they possessors as regards prescription; but as regards protection against disturbance and against dispossession distinctions are drawn. Servants and employees acting under the direction of a master or employer are generally regarded as mere detentors. Agents,

bailees, and lessees are not possessors at Roman law; but in the modern civil law and in English law they have possessory remedies, at least against strangers, and they are therefore usually called possessors. If, as is usually the case in modern law, possessory remedies are also given to those for whom they hold possession, the latter (principals, bailors, and lessors) are said to have 'constructive' or 'mediate' possession. Pledges and mortgagees who have physical possession are treated as legal possessors in every system of law.

The denial of possessory remedies to the person who holds for another does not exclude the right of defending physical possession against wrongful aggression. It signifies simply that if judicial proceedings are necessary, they must be taken by (or at least in the name of) the person for whom the property is held.

A very important rule of pleading which is contained in the Code Napoléon is that every physical possessor is presumed to possess for himself and with good title until the contrary is proved.

One of the chief differences between Roman and English law is found in the greater protection which the Roman law gives to the possessor of a movable against the person who has the right to possess. At Roman law, if the owner takes property forcibly from the possessor, he is obliged to restore it and pay damages; he cannot justify his employment of force by showing his right to possess. (It must be remembered, however, that at Roman law bailees and agents are not possessors.) At English law the owner of goods is permitted to use reasonable force for their recapture, even against a third person who has acquired them innocently with color of title. As regards realty the statutes against 'forcible entry' have placed the English law on nearly the same footing as the Roman.

DEFECTIVE POSSESSION. He who has acquired possession from another person by force or by stealth or by license is said, in the Roman and modern civil law, to have a possession which is 'vicious' (i.e. defective). As regards that person he is protected against forcible dispossession, but not against disturbance (trespass). As against all other persons, however, vicious possession enjoys (as at English law) the same protection as any other kind of possession.

HONEST POSSESSION. To the *bonæ fidei* possessor, i.e. to the person who not only possesses, but believes that he has a right to possess (a belief which regularly implies color of title), Roman and modern civil law give greater advantages than to the *malæ fidei* possessor. The honest possessor, when evicted by the owner, is not accountable for *fructus* or mesne profits no longer in his possession; or, as the civilians express it, he has the right of consumption and even the right of waste. Again, the honest possessor alone may acquire title by prescription. Finally, the honest possessor has an action for recovery of possession which runs against all the world, by which he prevails over every possessor who has not at least as much color of title as he has, and which, unlike the ordinary possessory remedies, is not limited to a brief term. These distinctions are generally drawn in modern civil law, but not in English law. In English law the honest possessor is accountable for mesne profits; he has no advantage as regards the perfecting of his title by lapse of time; and the actions of

ejectment and trover may be employed by the dishonest possessor as well as by the honest possessor. In these English actions, however, the relatively better title prevails, so that substantially the same result is reached as in the Roman law.

ACQUISITION AND LOSS OF POSSESSION. In order to acquire legal possession a much more complete control must be established when the thing seized was not previously in any one's possession (as in the capture of wild animals, birds, and fishes), or when the thing is taken without the consent of the prior possessor (disseisin), than is necessary in cases where possession is voluntarily transferred by a prior possessor. In case of delivery of possession it is only necessary that the new possessor gain the degree of control ordinarily held by an owner. Thus, while the theft of a key would not give the thief possession of anything but the key, the delivery of a key may suffice to transfer possession of a box or a room or a house. Such cases are sometimes described as 'symbolic' deliveries, but this term is inaccurate, since control actually passes.

At English law a further distinction (foreign to the Roman law) is drawn between the person who has a right to possess and the person who has no such right. He who has a right to possess becomes legal possessor, even without the consent of the prior possessor, as soon as a partial control is established. This is one of the meanings attached to the English maxim that 'possession follows title.' Another meaning is that, when it is uncertain who has the physical control, legal possession is with the person who has the better right to possess.

Legal possession is lost, at all legal systems, when physical control is lost. Control, however, as previously stated, does not mean complete control; and possession once established usually continues until the possibility of control is lost. Apart from the case of animals *feræ naturæ*, this usually occurs only when an adverse possession is established.

BIBLIOGRAPHY. Savigny, *Das Recht des Besitzes* (7th ed., Vienna, 1865); Bruns, *Das Recht des Besitzes* (Tübingen, 1848), and *Besitzklagen* (Weimar, 1874); Jhering, *Grund des Besitzschutzes* (Jena, 1869), and *Besitzwille* (ib., 1889); Pininski, *Sachbesitzerwerb* (Leipzig, 1888); Polloek and Wright, *Possession in the Common Law* (London, 1889).

POSSET (probably from Ir. *pusoid*, posset, Welsh *posel*, curdled milk, from *posiaw*, to gather). A dietetic preparation, made by curdling hot milk with wine, ale, vinegar, or other acidulous liquor. White wine or sherry is generally preferred, or old ale may be used. The posset is made by adding to boiling milk the liquor chosen: One and one-half wineglassfuls of sherry, or twice this quantity of ale to one pint of fresh milk, are the proper proportions. A teaspoonful of vinegar or of lemon juice may be used instead, and the mixture sweetened.

POSSEVINO, pòs'sà-vè'nò, ANTONIO (c.1534-1611). An Italian Jesuit and Papal diplomat, born at Mantua. He studied at Rome, was appointed secretary to Ereole Gonzaga, in 1559 entered the Jesuit Order, and was later rector of the Jesuit College at Avignon. In 1577 he was despatched to Sweden for the purpose of effecting the return of that country to the Roman

communion. Though King John III. gave assurance of obedience to the Pope, an ecclesiastical commission at Rome failed to accede to many of the King's propositions, and the monarch discontinued negotiations. In 1581 Possevino received credentials as Papal ambassador to Poland and Russia, the Pope having been appealed to by Ivan IV., the Terrible, to serve as arbiter. He aided in accomplishing peace (1582), but failed in his attempt to obtain the consolidation of the Greek and Roman Churches. He did, however, secure religious freedom for Roman Catholic merchants, and safe conduct for Papal nuncios and missionaries. Subsequently he was active as ambassador and missionary, and in 1587-91 lectured at the University of Padua. In addition to numerous controversial writings, he published *Moscovia, sive de Rebus Muscoviticis* (1586), containing a narrative of his own embassy; *Bibliotheca Selecta de Ratione Studiorum* (1593); and *Apparatus Sacr* (1603-06), an extensive and painstaking, though not uniformly critical presentation of the sources of general theology.

PÖSSNECK, pös'nöck. A town of Saxe-Meiningen, Germany, situated 54 miles southwest of Leipzig (Map: Germany, D 3). It has a Gothic church of the fourteenth century, and a Gothic town hall. The chief manufactures are woolen and leather goods, porcelain, and dyes. Population, in 1900, 12,266.

POST, ALFRED CHARLES (1806-86). An eminent American surgeon. Born in New York City, where he passed all of his life with the exception of two years, Dr. Post was graduated from Columbia College in 1822, and from the College of Physicians and Surgeons, New York City, in 1827; studied in Paris, Vienna, Berlin, and London, 1827-29; was demonstrator of anatomy in College of Physicians and Surgeons, New York City, 1831-35; professor in the Castleton Medical College, Vermont, of ophthalmic surgery, 1842-44, and of surgery 1844-51; professor of surgery in New York University, 1851-75, and emeritus professor of same, 1875-86; president of medical faculty of same, 1873-86; attending surgeon to New York Hospital, 1836-52; consulting surgeon to same 1852-86; consulting surgeon to Saint Luke's Hospital and attending surgeon to the Presbyterian Hospital, and president of the medical board of the Women's Hospital, in New York City. He was a Fellow of the Academy of Medicine, of which he was vice-president 1861-66, and president 1867-68. He was also vice-president of the American Medical Association. Dr. Post published several orations delivered before medical bodies, and also *Observations on the Cure of Stammering* (1841). He was also the inventor of several surgical instruments and appliances. His son, GEORGE E. (1838—), a physician and botanist, was born in New York City. He studied art, medicine, and theology, and became professor of surgery in the Protestant Syrian College at Beirut. There he became distinguished both as a physician and as a botanist. He wrote and translated many books, one of the most important being *Flora of Syria, Palestine, and Sinai*.

POST, WRIGHT (1766-1828). Born on Long Island, N. Y.; studied medicine for six years in New York and London, and commenced to practice medicine in New York in 1786. In 1792 he became professor of surgery, and afterwards of

anatomy and physiology, in Columbia college. He visited the celebrated schools of Europe, and returned in 1793 with a splendid anatomical cabinet. In 1813 he became professor of anatomy in the College of Physicians and Surgeons, and was its president 1821-26. He was for 30 years consulting physician of the New York Hospital, and a member of the prominent literary societies of the city.

POSTAGE STAMPS (from *post*, from Fr. *poste*, from ML. *postu*, station, fixed place on a road, from Lat. *postus*, *positus*, p.p. of *ponere*, to place). Printed labels issued by individuals, corporations, or governments, acting as carriers of letters or packages, to signify that the charges demanded by them for forwarding this mail matter have been prepaid. The postage due or unpaid letter stamp is not a postage stamp, but is merely a convenient means of indicating that a certain amount is due for a carrier's service which has been rendered. An individual or corporation may, in countries where the law allows it, establish a carrier service between different points and issue stamps for the prepayment of charges. This was the origin and use of United States local stamps, which the laws at one period allowed, but now forbid. The suspension of the United States mail service in the neighborhood of San Francisco in 1894, on account of a railway strike, produced a brief evasion of



the law in the establishment of a bicycle mail route between Fresno and San Francisco. The postage on mail by this route was prepaid by a twenty-five-cent stamp. Such a local arrange-



ment has but little authority and is accorded scant recognition. A higher grade is reached in the semi-official issues whose originators were, in such cases as those of the Baltimore carriers, authorized by the United States Government to charge one cent for the delivery of letters at the post-office. Postmasters' stamps have even more of authority.

The United States Government, being unwilling to undertake the risk and expense of a general issue of postage stamps, allowed, in 1845, the postmasters of certain towns and cities to issue stamps at their own expense and for their own convenience to test the feasibility of their use. The postmasters of Alexandria, Va.; Brattleboro, Vt.; Lockport, N. Y.; Millbury, Mass.; Baltimore, Md.; New Haven, Conn.; New York, N. Y.; Providence, R. I.; and Saint Louis, Mo., adopted



the plan with such success that the Government undertook, in 1847, a general issue to supersede all the individual postmasters' issues.

The highest authority pertains to government issues, and consequently universal recognition is accorded to them. A sharp distinction, however, is made between established governments and pseudo-governments. The attempts of the Cuban Revolutionary Committee to raise revenue from stamps manufactured and sold in New York, which never prepaid an ounce of Cuban mail, and of Aguinaldo in the Philippines to foist labels issued by his unrecognized government upon the collecting public, met with small success.

There are two kinds of stamps, the adhesive and those which are impressed upon the envelope or wrapper.

Adhesives are attached to packages before mailing. The only exception to this is found in the case of some United States newspaper stamps. The newspaper set of 1865 was attached to packages of newspapers, but the stamps of 1875 and following years were attached to the stubs of receipt books, the receipts being given to publishers of second-class mail matter sent through the mails at pound rates to show the amount that had been paid by them. The use of these stamps was finally judged superfluous and discontinued. Official stamps are used by government office-holders to indicate the amount of postage that would have been paid had their mail matter been sent at the usual rates. No money, however, having been paid for these, they are in the nature of official franks, but a nominal value is usually given them, the idea being to use them as a means of keeping the accounts between the different departments of government.



The history of postage stamps begins with the issues made by Great Britain in 1840, under the administration of Sir Rowland Hill. The successful use of stamps in the postal service of

Great Britain resulted in the adoption of stamps by Mauritius, an English colony, by Brazil, France, Switzerland, and the United States before 1850. The example was followed by many other countries, and since 1860 nearly all have adopted the postage stamp as the most convenient means of indicating the prepayment of postage on mail matter. The establishment of the Universal Postal Union, by means of which the rates of international postage, the colors of the stamps to be used, and the regulations for forwarding are determined, has given great impetus to the issuing of stamps throughout the world.

The earliest shape of the postage stamp is practically that which is in use to-day. The triangular, diamond-shaped, octagonal, and square have been tried as experiments by different countries, but in nearly all cases the return has been made to the rectangular form, and usually to about the same size as that of the original issue of Great Britain. Sizes have differed very greatly, the smallest, a stamp of Bolivar, a State of the Colombian Republic, being three-eighths by one-half inch, and the largest the United States newspaper stamp of 1865, $2\frac{1}{4} \times 3\frac{3}{4}$ inches.

The original designs of the stamps of many

countries are their finest; but there are notable cases in which the improvement both in design and workmanship has been remarkable. A prominent example of this is found in the various issues for Uruguay. The earliest types, those of 1856-66, are of the most inferior workmanship, and the stamps are produced by the cheapest processes known. Stamps of the next decade show some improvement, while those of the following years contain some of the finest work of the period, and also a number of specimens of poor work. The stamps since



1884, however, have been the finest possible examples that could be turned out under modern processes of engraving, and reveal from year to year the advances that have been made.

The methods of manufacture have changed very greatly since postage stamps were first issued. The earliest stamps, in several countries, were each engraved separately by hand, upon copper plates from which the impressions were taken. A notable example of this is the postmasters' stamps issued in Saint Louis. This small plate of six stamps was engraved in two vertical rows of three stamps each, the first row of the 5-cent and the second row of the 10-cent



denomination. The two upper 5-cent stamps were altered to 20-cent stamps and later these were changed back to their original 5-cent denomination. Separate engraving was also employed in the cases of the early stamps of Mauritius, New South Wales, and the Philippine Islands.



The first adhesive stamp issued, the one-penny black of Great Britain, was made by a more advanced process. The original steel die, having been hardened, was impressed a number of times upon a softened steel roller which in turn was hardened, and under pressure rolled upon a plate from which the stamps were printed. By this means of transfer, as many impressions could be made on a plate as desired, and the full sheets of these early issues contained 240 stamps.



This method of engraving and transfer, with some improvements, is employed at the present time and is utilized in the manufacture of the stamps of many countries. Another method in use has been the setting of separate electrotypes of a stamp side by side and then recasting them as a solid plate. Lithography has also been employed as a convenient and cheap method for producing stamps in quantity. Some countries have also made stamps by the use of ordinary type and rule, the design being repeated as many times as it was desired to have stamps in the sheet. Type-set stamps vary one from another.

This is caused by slight differences in the type or its spacing, and in the cutting of the rule used for borders.

The common method of printing envelope stamps is by embossing, there being in this case two dies, one fitting into the other; the paper being placed between these and the flat surface of one die inked, a stamp is produced in which the raised portions are white and the level portions are inked. This method has been employed

in the printing of a few adhesive stamps, notably those of Great Britain of the issue of 1841.

Provisional issues of stamps have been made from time to time in different countries. This has sometimes been done for the purpose of providing a new denomination for immediate use before it

was possible to obtain a new supply of the stamps from the printers. Such provisionals are usually made by over-printing some values of stamps of which there is a surplus with a new value. This is known as surcharging. Sometimes lithography is resorted to in countries where the regular issues are engraved. Surcharging is also resorted to in order to increase the supply of some denominations and to decrease that of others for which there is less use than had been expected when the stamps were printed.

There was no means employed when the earliest issues of stamps were made to provide for their easy separation. The stamps were intended to be cut apart, and in many cases were printed very close together. The use of a machine for punching small holes between the stamps, known as a perforating machine, was begun in 1854, although there are instances, even at the present time, in which no method of separation is employed. Another method of separating stamps is by the use of the rouletting wheel, which cuts through the paper between the stamps with a series of small cuts such as would be made by brass rule, with an edge made up of alternate dashes and spaces, in printing. This rule also is sometimes used for the same purpose, and when it is inked the stamps thus treated are spoken of as rouletted in colored lines. The cuts are, in certain cases, made in zigzag or saw-tooth form and are variously produced by rouletting wheels or by impressions with rule made for cutting.

Governments which have issued stamps sometimes reprint them after they have gone out of use. When these issues are good for postage they are called reissues. When, however, they are obsolete stamps, which cannot be used for prepaying mail matter, they are known as reprints. It sometimes happens that the plates of Government issues of stamps get into the hands of private individuals who reprint them for sale to collectors. These are known as private reprints and are of much less value than Government reprints because made without authority, and usually in large quantities.

The processes employed in printing in many countries have been such as to encourage counterfeiting. Comparatively little trouble has been experienced by governments which have employed steel engraving for the production of their

stamps. The expense and difficulty of successful imitation by the use of counterfeit steel plates has been such as to deter counterfeiters from attempting it. The lithographic process is usually employed by counterfeiters. The Government of Spain changed its issues every year for a considerable period in order to defeat the aim of counterfeiters. Greece also has suffered considerably from counterfeits made to defraud the Government.

The collecting of stamps, sometimes known as philately, has several advantages over the gathering of other objects which satisfy the collecting instinct. The chief of these is the small space which is occupied by a large and valuable collection. There is also a standard of value by means of which the worth of stamps may be estimated. This is found in the standard catalogues, which, being based upon a knowledge of the number of stamps in existence, and prices collectors are willing to pay for them, contain approximate valuations for most of them.

The separate engraving of stamps increases very much the interest in them. It has also led to a distinct kind of collecting known as plating. Collectors who are interested in doing this seek to restore the original plates of stamps by gathering together all the varieties that have been printed from them and placing them in their proper order in relation to one another.

Great countries are distinctly adverse to the use of the postal service in any other than its legitimate manner. There have been cases where British and French colonial authorities have arranged for special issues of stamps or have had overprints, known as surcharges, placed upon them for the purpose of securing an increased sale to collectors, but these attempts have been frowned upon and few of them are made at the present time.

All collectors of stamps collect the perforated as distinct from the imperforate issues. The rouletted varieties are quite generally collected, and those who are especially interested in the smaller varieties notice the differences in the gauge of the perforation. This is determined by the number of holes that may be counted in the space of two centimeters and a stamp is known as perforated 11, 13, 15, etc., according to the number of perforations included in that space.

Water-marks have been used by many countries as a means of guarding against the counterfeiting of their stamps. These are produced in the paper in the same way that the water-mark is made in ordinary writing paper. It sometimes appears in the centre of a sheet or pane of stamps,



and again the whole water-mark is found in the space covered by a single stamp. The most common and interesting varieties of water-mark are those found in the stamps of Great Britain and her colonies. It is sometimes quite difficult to discern the water-mark, but a stamp placed in benzine upon a black surface usually shows it clearly. Collectors who are especially interested in minor varieties of water-mark collect them when found inverted or sideways in the stamp, as well as in their proper position. The misplacing of a sheet in the press frequently causes a water-mark to appear at one side instead of at



the centre of a stamp, and in some cases it is entirely lacking for this reason, and, where the margin of a sheet contains lines or large letters, these are found in the stamps.

The colors of the paper on which stamps are printed appeal strongly to all collectors, also the quality of the paper itself. Laid paper is a variety showing parallel lines, similar to those of the water-mark, such as may be found in many varieties of writing paper. All paper that does not have laid lines is known as wove, some of it being of even texture and showing no marks whatever, while other varieties show that which is similar to the weaving of cloth which gives the name. Collectors who are specialists note the differences of hard and soft paper. Thin and thick paper varieties are also collected.

The value of stamps depends, not, as is commonly supposed, upon their age, but upon the number that have been issued and the number preserved. Great countries, like the United States and the principal nations of Europe, issue large numbers of every stamp that they put into circulation. The stamp which corresponds to the ordinary letter rate in any large country is al-

ways common. Very old issues of small countries whose postal service was limited attain high value. Confederate postmasters during the War of Secession issued stamps of a class similar to United States postmasters' stamps. Some of these in fine condition are rare, bringing



James M. Buchanan
5 Cents.

\$500 each and upward, according to their condition. The United States Baltimore stamp of the 10-cent denomination, which differs from the 5-cent only in the numeral, is one of the rarest known. The first issue of Mauritius brings a very high price, exceeding \$2000 for a fine specimen. All early issues of stamps are continually increasing in value, for the supply of them is limited and the demand grows constantly.

There are very valuable collections of stamps held in all the principal countries of the world. The British Museum owns one which was left to it by a late member of Parliament and which contains very fine specimens of the rarest stamps of all countries. The most complete collection in the world is owned in France. The actual value of these collections is difficult to estimate, as they contain stamps of which few specimens are known and varieties which are unique.

Consult: Calman and Collin, *Catalogue for Advanced Collectors* (New York, 1902); Luff, *The Postage Stamps of the United States* (ib., 1902); Wright and Creeke, *The Adhesive Stamps*

of the British Isles (London, 1899); Krätzsch, *Permanentes Handbuch der Postfreimarkenkunde* (Leipzig, 1895 et seq.).

POSTAL SAVINGS BANKS. The system of savings banks conducted by various governments through the Post-Office Department. This institution has become increasingly important since it was first introduced in England in 1861, and to-day all the principal nations of the world, except Germany and the United States, have adopted it. Its adoption in England was due to the inadequate facilities and incompetent management of the trustee banks. In 1860, out of a total of 638 of these banks, 350 were open only one day in the week, and then for only a few hours, while 20 towns and 14 counties, each containing over 10,000 inhabitants, were wholly without savings facilities. Similar conditions existed in the countries of Continental Europe. Thus in France Leon Say estimates that prior to 1875 34,000 communes were without any savings bank facilities whatever.

While differing in details in the various countries, the general features of the system are the same. Deposits may be made by any person at any post-office. Depositors are provided with pass-books in which the amount of the deposit is entered by the local office, and within a few days an official receipt is mailed to the depositor from the general office. In rural communities carriers are allowed to receive deposits. To encourage employees to extend the system, Holland, Finland, and Russia allow local officials commissions upon pass-books issued and deposits entered. Most countries provide for a minimum and maximum deposit. The minimum is usually about 20 cents, but a card is issued upon which stamps may be affixed until they amount to that sum, when the card is taken by the bank and the deposit is credited. This device has been found especially adapted for use in schools. In England and France the fund representing the aggregate deposits is invested in Government bonds. In other countries a wider latitude of investment is permitted, such as municipal and corporation bonds, real estate mortgages, and even personal security. The deposit is in all cases guaranteed by the Government. Interest on deposits is computed annually, the usual rate being 3 per cent. The maximum deposit is £200 in England and 1000 lire in Italy. If this sum be exceeded no interest is allowed on the excess. Withdrawals, like deposits, may be made from any post-office. A delay of a few days is usually necessary for withdrawal, though a system of withdrawal by telegraph has been provided.

Postal savings banks usually serve two other functions besides receiving deposits. These are: (1) the providing of annuities and the writing of life insurance; (2) serving their customers as agents in purchasing Government securities. Austria and Hungary have gone a step further and provided for accounts subject to check.

In England 18.43 per cent. of the total number of depositors are artisans; 8.14 per cent. tradesmen and assistants; 8.61 per cent. domestic servants; 50.41 per cent. married women, widows, spinsters, and children. In Austria more than half the depositors are under twenty years of age. Details of the various systems are shown in the following table:

	Year adopted	Date of statistics	Number of banks	Number of depositors	Total deposits	Maximum individual account	Maximum deposit any one year	Rate of interest
England	1861	1900	£122,365,193	200	50	2.5
Scotland					£5,126,299			
Ireland					£8,058,153			
Belgium	1865	1899	987	1,642,678	608,440,774 fr.	•	60,000 fr.	5
Italy	1876	1900	5,141	3,993,340	682,000,000 lire	•	1,000 lire	3.25
France	1881	1900	7,697	3,564,464	1,010,263,193 fr.	1,500 fr.	•	3
Netherlands		1900		829,131	84,697 g.	•	•	2.64
Austria	1883		5,987	1,527,265	180,010,618 fl.	1,000 fl.	•	3
Hungary	1886		4,205	389,083	32,674 cr.	•	•	3.6
Sweden	1884	1899	3,958	556,544	59,934,156 kr.	•	•	3.61
Finland	1886	1889	31,204	\$152,861	•	1,000 M.	3
Russia	1889	1900	3,172,858	\$320,000,000	1,000 rub.	•
Canada	1868		847	150,987	\$97,507,456	\$1,000	\$1,000	3
Japan		1898	1,565,498
India		1899	6,479	785,729	96,464,466 rup.
New Zealand	1865	1900	450

* Unlimited. The above table is compiled from statistics in the Statesman's Year Book (1902), and from figures given by Hamilton and Wanamaker.

Consult: Wanamaker, *Postal Savings Banks* (Washington, 1891); United States Post-Office Department, *Annual Report* (Washington, 1892); Hamilton, *Savings and Savings Institutions* (New York, 1902).

POSTEL, pô'stêl', GUILLAUME (1510-81). A French philologist and mystic, born in Dolerie, Normandy. He was poor and without patronage for many years, but by constant study he became versed in Hebrew, Greek, and Arabic. Francis I. sent him to Constantinople to buy Oriental manuscripts, and on his return to France (1539) appointed him to a chair in the Collège de France. But the idea of converting the world had taken possession of him and through the remainder of his life gave him little rest. His vagaries increased and he became disciple to an old Italian mystic, whom he calls 'Mother Jeanne' and whose spiritual dominion he prophesies. Professor in Vienna for a time, he then wandered through Italy, being repeatedly imprisoned by the Inquisition, and on his coming back to France was shut up in the Monastery of Saint-Martin-des-Champs. Postel brought to France many valuable manuscripts, and in 1555 published the first edition of the Syriac New Testament. His *De la république des Turcs* (1540; revised 1560) has some historical value. Consult Weill, *De Postelli Vita et Indole* (Paris, 1892).

POSTER. A sign, usually pictorial, intended to be affixed to a wall or board to convey some public announcement. The use of such signs is probably as old as civilization itself; but with the printing-press came in a class of signs more or less answering to the specific modern use of the word poster. In Paris in the seventeenth century, posters printed on colored paper of one tone, such as yellow for the Opera House, green for the Comédie Française, and red for the Comédie Italienne, were generally used. The custom is continued in Paris of the nineteenth century, where white paper is reserved for governmental posters, and even the great national educational establishments have to use another color, generally yellow. In Italy the play bills were more descriptive, and in the eighteenth century they were often ornamented with cuts, showing scenes and characters in the Opera. As early as 1836 in France Lalancé made a poster for the book *Comment meurent les femmes*, and Raffet, Grandville C. Nanteuil, Gavarni, Gigoux, Vernet, Daumier, Tony Johannot, Frère, and Edouard

Manet designed 'affiches' or posters, but not in colors. The modern poster was the invention of Jules Cheret. He commenced his long series of lithographs in color in 1866, and since then the art of poster designing has reached a high development. In France it has maintained a high standard, and the work of Cheret himself is notably clever and audacious. By the use of few colors in strong contrast, he produced the most fantastic pictorial effects. His subjects are ballet girls, clowns, or children, and his spontaneity, his engaging gaiety, and the aptness of his detail make him without an equal in his restricted domain. Less suggestive, less conquering in color, but more decorative if more subdued, is the work of Eugène Grasset (1850—). Another more original poster maker is the often harshly realistic Toulouse-Lautrec, a powerful draughtsman. The poster has kept pace with the impressionistic, the symbolistic, the realistic, and the romantic movements in literature and art. Willette, Forain, Guillaume, Auriol, Ibels, Steintlen, Mucha, Revière, Boutet de Monval, and Schwaebé, are only a few names among the many poster designers who have worked in one or more of these styles. Another interesting phase of the poster is seen in those designs which serve also for book-covers; the whole design, picture, lettering, and borders, given first as a poster three feet by two, and afterwards reduced to the size of an octavo page. These were first made by Cheret for Jules Lévy, the publisher, and the often artistic work done for the publishers of music. In England the first artistic poster was made by Fred Walker for the dramatization of Wilkie Collins's *Woman in White* (1871). Afterwards Herkomer, Van Beers, Walter Crane, Dudley Hardy, and Grieffenhagen, among others, won fame in this line. But the most original of English poster makers was Aubrey Beardsley, who influenced a crowd of imitators by his masterly exotic art. The 'Beggartaff Brothers,' Poryde, and Nicholson, with their grave artistic effects in black and brown, are the most interesting of the very modern designers. The growth of the poster in other European countries was rapid, especially during the years from 1895 to 1900. The Spanish posters, especially those announcing bull-fights and fairs, are models of brilliant coloring and vivid treatment. The first American posters advertised the circus and the stage, and one of the earliest of these poster makers was Matt Morgan, for some time head of a Cincinnati lithographing company. The makers of patent medicines then

LAURIER OBJETS D'ART



took it up, and from the lowest kind of pictorial art have lately done much effective work. In America bill posting has assumed enormous proportions, but actually pictorial work, especially in colors, is not as common as in Europe. (See ADVERTISING.) The most artistic American posters have been produced for the publishers in the form of enlarged magazine covers, as stated above, together with advertisements for books, and calendars, and in these as in nearly all American art the main influence is French. It was not until 1889 that the work of Louis Rhead became known, and along with him must be mentioned Penfield, Will Bradley, Carqueville, George Wharton Edwards, Parish, and Low. Although as a purely artistic production, a subject for collectors and students, the poster has had its day, yet as a medium of advertisement and of political appeal it may have a future. Consult: Maindron, *Les affiches illustrées* (Paris, 1895); id., *Les maîtres de l'affiche* (Paris, 1896); id., *Les affiches étrangères illustrées* (Paris, 1897); Hiatt, *Picture Posters* (London, 1895); Spielman and others, *The Modern Poster* (New York, 1895); Spousel, *Das Moderne Plakat* (Dresden, 1897); Bolton, *The Reign of the Poster* (Boston, 1895).

POST-GATE, JOHN PERCIVAL (1853—). An English classical philologist, born at Birmingham. He was educated at King Edward's School, Birmingham, and at Trinity College, Cambridge. He became fellow and classical lecturer in Trinity College and professor of comparative philology in University College, London, and editor of the *Classical Review*. His publications include editions of Catullus, Propertius, and Lucan. He became editor-in-chief of the *Corpus Poetarum Latinorum* in 1893.

POSTHUMOUS CHILD (Lat. *postumus*, *posthumus*, last, superlative of *posterus*, later; associated by popular etymology with *post*, behind, after + *humus*, ground). One born after the father's death, or delivered from the mother by the cesarian operation after her death. Such a child is regarded by the law, for the purposes of inheritance, and taking property by will, as if it had been born before the parent's death. Where a father makes a will without making provision for a posthumous child, the child is entitled to receive the same share of the estate that he would have taken if the father had died intestate, the will being revoked *pro tanto*, and the provisions for the other children or legatees being reduced proportionately to make up his share or portion. See SUCCESSION; WILL.

POSTHUMUS. The husband of Imogen, in Shakespeare's *Cymbeline*, banished by the King, who intended his daughter for his step-son Cloten. In Italy Posthumus made a wager with Iachimo on Imogen's fidelity, and, deceived by a trick, ordered Pisanio to murder her. Finally Iachimo confessed, and Posthumus was pardoned.

POSTLUDE (from Lat. *post*, behind, after + *ludus*, play, from *ludere*, to play). An instrumental selection played after the conclusion of Divine service, while the congregation is passing out of the church. The term *postlude* is also applied to the closing instrumental measures at the end of a vocal composition.

POST MORTEM (Lat., after death). A legal term employed to denote an examination of a

dead body to determine the cause of death. Usually, some dissection or mutilation of the body is necessary, but this rests in the discretion of the examining physician. A coroner is required to hold a *post-mortem* examination of the body of a person dying under suspicious circumstances. A person other than a public officer in the performance of his duty has no right to dissect or mutilate a dead body, without the consent of the nearest relative of the deceased, and is liable in damages if he does so without such consent. Consult Perley, *Mortuary Law*.

POST-MORTEM EXAMINATION. See AUTOPSY.

POST-NUPTIAL CONTRACT. In its broadest sense, any contract made between husband and wife. As to their privileges and restrictions in this respect, see CONTRACT; HUSBAND AND WIFE.

POST-OFFICE. A public institution for the reception and delivery of letters, newspapers, books, and such other matter as may by law of the State be intrusted to the mails for conveyance. The post-office is frequently also charged with other duties than the handling of mail. Thus in the United States it issues money orders designed to facilitate the transmission of money, and in European countries it conducts savings institutions and has a monopoly of the facilities for telegraphic communication. The postal service is at present in all civilized countries under the management and control of the Government. The name originated in the posts (from Lat. *positum*, placed, fixed) placed at intervals along the roads of the Roman Empire where couriers were kept in readiness to bear dispatches and intelligence. The first letter-post seems to have been established in the Hansa towns in the early part of the thirteenth century as a means of facilitating commercial intercourse. In England a system of posts for dispatching letters was early provided, Sir Brian Tuke being mentioned as the first Master of the Posts in the reign of Henry VIII. In the reign of Elizabeth a chief postmastership was established, Thomas Randolph being the first incumbent. With the accession of James I. to the throne of England and the consequent increased intercourse between England and Scotland a marked improvement in the postal system followed. In the reign of Charles I. a monopoly of letter-carrying was established, the rates of postage being fixed at from 2d. to 6d. for a single letter, according to distance, in England, 8d. to Scotland, and 9d. to Ireland. In 1680 a penny post was established for the conveyance of letters and parcels between different parts of London and its suburbs. In the reign of Anne the existing postal statutes were repealed and the post-office establishment placed on a new basis. A general post-office was instituted at London for the British dominions, with chief offices at Edinburgh, Dublin, New York, and other places in America, while the whole system was placed under the control of a postmaster-general with power to appoint deputies for the chief offices. Near the end of the eighteenth century coaches were substituted for riders on horseback. With the development of the railway system came the carriage of letters by train instead of by mail-coaches; and one novelty which arose out of this change was the adoption of traveling post-offices,

forming part of the mail-train, where letters are arranged during transit, and which sometimes receive and drop the letter-bags while the train is going at full speed.

In 1812 the rates of postage on letters were fixed at 4d. for 15 miles, with a regular increase up to 17d., which was the charge for any distance over 700 miles. In 1837 a plan of post-office reform was suggested by Mr. (afterwards Sir) Rowland Hill, the adoption of which not only immensely increased the utility of the post-office, but changed its whole administration. Its principal features were the adoption of a uniform and low rate of postage, a charge by weight, and prepayment. The new system came into full operation in 1840. A penny was adopted as the uniform rate for every inland letter not above half an ounce in weight. Facilities for prepayment were afforded by the introduction of postage stamps, and double postage was levied on letters not prepaid. Arrangements were made for the registration of letters; and the money-order office, by a reduction of the commission charged for orders, became available to an extent which it had never been before. The immediate result of these changes was an enormous increase in the amount of correspondence, arising in part from the cessation of the illicit traffic in letters, which had so largely prevailed before; but for some years there was a deficit in the post-office revenue. Since 1897 the rates have been as follows when prepaid: Not exceeding 4 ounces, 1d.; over 4 ounces and not exceeding 6 ounces, 1½d.; over 6 ounces and not exceeding 8 ounces, 2d., and so on at the rate of one halfpenny for every additional two ounces. A letter posted unpaid is charged double postage. Letters insufficiently stamped are charged double the deficiency on delivery. Redirected letters are charged additional postage at the prepaid rate; and this may either be prepaid or charged on delivery. Letters for officers, soldiers, or seamen on actual service abroad are redirected without charge. The same privilege extends—with several restrictions—to such letters redirected at home. By paying ½d. extra, letters may be posted in the boxes attached to mail trains, in which sorting is performed.

The home and foreign mail-packet service was, in the seventeenth and eighteenth centuries, in the hands of the post-office authorities, but was removed to the Board of Admiralty, under whose control it remained till 1860, when it was again restored to the post-office. Steam-vessels were first used for conveying the mail in 1821; and in 1833 mail contracts were introduced, the first being with the Mona Steam Company to run steamers from Liverpool to Douglas in the Isle of Man. Of the home mail-packet contracts, the most important are those with the City of Dublin Steam-Packet Company for conveying the Irish mails between Holyhead and Kingstown. The principal foreign contracts are for the Indian and Chinese mails, entered into with the Peninsular and Oriental Steam Navigation Company, the mails to North and South America, the West Indies, the Australian colonies, and the Cape.

In 1901 there were 22,189 post-offices in the United Kingdom besides 33,590 road and pillar letter-boxes. The total number of letters delivered during the year was 2,323,600,000, as against 1,097,000,000 in 1879. The total number of post cards, books, newspapers, and parcels

delivered through the mails amounted to 1,400,200,000. The number of money orders issued was 13,263,567, with an aggregate value of £39,374,665. The number of 'postal orders' issued amounted to 85,390,029, with an aggregate value of £29,881,726. The total receipts of the post-office exclusive of the income from the telegraphic service was £13,995,470, while the expenditures were £9,064,903, leaving a balance of £3,930,567.

The postal service of the United Kingdom is now under the immediate control of the Postmaster-General assisted by the chief secretary of the post-office in London, a financial secretary, and four other secretaries. There are also chief officers in Edinburgh and Dublin, with secretarial and other departmental staffs. The Postmaster-General is a member of the Privy Council, and sometimes a Cabinet Minister. He is the only officer connected with the department who leaves office on a change of Ministry. The secretary is his responsible adviser. The receiver and accountant-general keeps account of the money received by each department, receiving remittances from branch and provincial offices, and taking charge of the payment of all salaries, pensions, and items of current expenditure. The surveyors are the connecting link between the metropolitan and provincial officers, each postmaster, with some exceptions, being under the superintendence of the surveyor of his district. In 1900 the staff of officers employed in the post-office, including those engaged in telegraph work, was over 167,000.

POSTAL SAVINGS BANKS. See under that heading.

POST-OFFICE INSURANCE. The system of post-office insurance, first established by the English Government through the Government Annuities Act of 1864, like the system of postal savings banks, was primarily intended for the promotion of habits of thrift among the working people. For many years the Government had sold terminable annuities for one life, two lives, or a term of years, through the Commissioners for the Reduction of the National Debt. The act of 1864, which went into effect April 17, 1865, provided for the sale of such annuities of any amount between £4 and £50 through the Post-Office Department. It further authorized the Postmaster-General to insure the lives of persons between the ages of 16 and 60 inclusive for any amount between £20 and £100. But little advantage was taken of the provisions of the act, only 6524 contracts for life insurance having been entered into up to 1882. In that year the act now in force was passed. By its terms annuities, either immediate or deferred, are issued to persons not less than 5 years of age for any amount between £1 and £100. Insurance, either life or endowment, may be taken out by any person between the ages of 14 and 65 inclusive. The amount of the insurance may vary from £5 to £100. Insurance for £5 may be taken out on the lives of children from 8 to 13 years of age. Insurance for £25 or less may be issued without a medical examination, provided the insured presents other satisfactory evidence of good health. Such policies provide, however, that, if the insured dies within two years of the issuance of the policy, the beneficiary shall not receive the full amount of his policy. Premiums may be paid in a lump sum in advance, or in installments. In 1896 new premium rates were

established, somewhat lower than those before in force. The present rates are a little higher than those of the regular life insurance companies, but on the whole somewhat lower than those of industrial companies.

The connection between the insurance department and the savings banks is the most characteristic feature of the institution. Every policyholder must be a depositor in the postal savings bank. He must deposit the full amount of his first premium, opening an account if he has not one already. Later premiums the Postmaster-General transfers from the deposits of the insured so long as they hold out, without notice from the insured. The insured may make his deposits in the bank at any time, and in any amounts, subject only to the general regulations of the bank. In the same way payments to the insured, whether arising from annuities or from endowment insurance policies, are first credited to his account on the books of the bank. Furthermore, the deposits in the bank, and the withdrawals from it, may be made at any one of the 13,000 postal savings banks in the country.

In spite of the more liberal conditions established by the law of 1882, the amount of life insurance business transacted by the Government is very small. Since the new law went into effect the number of policies issued has averaged less than 800 a year. The failure of the scheme is probably to be attributed partly to the great popularity of the Friendly Societies, partly to the rigidity of the Government system and its limited number of policy forms, partly to the lack of active effort to push the business through paid canvassers or otherwise, and partly to the antipathy of the English working people to Governmental institutions of this character. The experiment has had one beneficial result, however, if, as seems to be the case, fear of the competition of the Government office has been partly responsible for the efforts the Friendly Societies have been making in recent years to establish their business on a sound financial basis.

TELEGRAPHS. An act of 1870 empowered the post-office to acquire the existing electric telegraphs; and the telegraphic communication of the country is now in the hands of the post-office. As a result of governmental control the rates charged have been greatly reduced and the number of messages sent greatly increased. Since 1885 the charges have been half a penny per word, with a minimum charge of sixpence for each telegram. Above 89 millions of telegraphic messages were sent in the year ending March 31, 1901, about ten times the number sent in 1870. The gross revenue was £3,459,353; working expenses, £3,812,569. By an act of 1898 the Post-Office Department was further authorized to assume control of the telephone service of the United Kingdom.

A fee of 2d.—in addition to the ordinary postage—prepaid in stamps, secures careful handling of any letter, newspaper, or book-packet, and renders its transmission more secure, by enabling it to be traced from its receipt to its delivery. Letters may be registered for a fee of twopenny to any place in the British colonies, and for various rates of charge to different foreign countries. Letters containing coin, if not registered, are treated as if they were, and charged on delivery with a registration fee of eightpence; the same fee is

charged on letters marked 'Registered' and posted in the usual way instead of being given to a post-office servant. For the fiscal year 1899-1900, 16,256,852 letters were registered in the United Kingdom. Recently a system of insurance against loss or damage to letters has been established. The registration fee of 2d. entitles the sender to compensation up to £5, a fee of 3d. £10, and so on up to £120. Still more recently a railway and express letter service has been established by which letters may be intrusted to the railroad companies for dispatch upon payment of an additional fee.

NEWSPAPER, BOOK, AND PARCELS POST. Newspapers and books may be sent through the mails at the rate of one halfpenny for every 2 ounces or fraction of 2 ounces. Newspapers to come under the definition must be published at intervals not exceeding seven days and appear in unstitched sheets. Under book post are included manuscripts, maps, prints, and circulars. In 1900 the number of newspapers carried aggregated 167,800,000, and the number of book packets, circulars, etc., was 732,400,000. The parcels post was established in 1883. In 1897 the rates were made 3d. for parcels not exceeding 1 pound, and 1d. for each succeeding pound up to 10 pounds. During the fiscal year ending March 31, 1900, 75,448,000 parcels were carried for £1,580,508.

FREE DELIVERY. Prior to the American Revolution no provision had been made for free delivery except in a few of the larger cities and towns. Since then the free delivery system has become universal throughout the Kingdom. Corresponding to the American special delivery is the express delivery service of the British post-office, by which letters are sent out by express messengers in advance of the postman. The total number of deliveries of this kind in 1899 was 720,381. Rural free delivery service has been extended to all parts of England and is almost completed in Scotland and Ireland.

MONEY ORDERS. As far back as 1792 a money-order office as a private venture had been established for the transmission of small sums of money to different parts of the Kingdom. By an act passed in 1838 this business was incorporated in the Post-Office Department, but the commission charged was so high that it was only employed to a very limited extent. Inland money orders may be obtained at any of the post-offices of the United Kingdom, on payment of the following commission: For orders not exceeding £3, 3d.; over £3 and not exceeding £10, 4d. Money orders may now be issued to the colonies, to most European countries, the United States, Egypt, etc., the commission being about three to four times the above rate. A money order in the United Kingdom becomes void if not presented for payment before the end of the twelfth calendar month after that in which it was issued. Orders drawn on France or Italy must be paid within three months. The lower rates for inland money orders entail a loss on each transaction. Provision was further made for the issue of ten classes of 'postal notes' for small fixed sums, under the Post-Office Bill of 1880.

THE UNIVERSAL POSTAL UNION. In October, 1874, a conference of representatives from all the States of Europe, the United States, and Egypt was held at Berne, and resulted in the establishment of an international postal union with a

central office at Berne, which meets every three years to consider questions affecting the postal relations of the States concerned. This was followed in June, 1878, by the Treaty of Paris, signed or subsequently adhered to by all the parties to the former treaty, with the addition of British India, the colonies of France, Spain, Holland, and Portugal, various British colonies, Persia, Japan, Liberia, Brazil, Peru, Mexico, in fact every country in the world except China, the new convention receiving the name of the 'Universal Postal Union.' Under this important treaty all the consenting nations were declared to be "a single postal territory for the reciprocal exchange of correspondence." Instead of the varying rates theretofore prevailing, equal rates, weights, and rules were established, and considerable reduction of postage followed its adoption. Except in the case of lengthy sea transit, a uniform rate of 25 centimes (5 cents) was adopted for a letter of 15 grams ($\frac{1}{2}$ ounce); of 10 centimes (2 cents) for post-cards; of 5 centimes (1 cent) for packets of print, etc., of 50 grams (2 ounces); and of 25 centimes (5 cents) for registration in Europe, and 50 centimes (10 cents) for registration beyond Europe. Prepayment of postage is required except on letters.

UNITED STATES. In the English colonies of America before 1639 such postal facilities as existed were supplied by private enterprise. Letters from abroad were delivered at the wharf to those who called for them or sent to a near-by coffee-house for distribution. In 1639 the General Court of Massachusetts took the first step toward the establishment of a Government postal system by enacting the following decree: "It is ordered, that notice be given that Richard Fairbanks, his house in Boston, is the place appointed for all letters which are brought from beyond the seas, or are to be sent thither, to be left with him; and he is to take care that they are to be delivered or sent according to directions; and he shall be allowed for every letter a penny, and he must answer all miscarriages through his own neglect in this kind, provided that no man shall be compelled to bring his letters thither except he please." In Virginia each planter was required to convey the dispatches, as they arrived, to the next plantation, and so on. In 1672 the Government of New York established a monthly mail to Boston. In 1683 and in 1693 post-offices were established in Pennsylvania and New Hampshire respectively. In 1692 the Legislature of Virginia passed an act reciting that one Thomas Neale had been empowered by letters patent from William and Mary to take charge of the postal business of the colonies. Neale's patent authorized him "to erect, settle, and establish offices in America for the receiving and dispatching away of letters and packettes" and to appoint the necessary persons to assist him. This patent created for the first time an American inter-colonial postal service. In general its charges for carrying a letter ranged from 4d. to 15d., according to distance. The post roads were generally in bad condition; the riders were frequently untrustworthy, and the postmasters are represented as being little better.

No man in America was so identified with the interests of the colonial post-office as Benjamin Franklin. In 1737 he was appointed postmaster of Philadelphia. In 1753 he received with Wil-

liam Hunter a royal commission as Deputy Postmaster-General for the colonies. Franklin immediately proceeded to systematize the department and personally made a tour of inspection, in which he visited every post-office in the country except that of Charleston, S. C. After four years of his administration the post-office yielded the salary of the postmasters, and a small revenue besides, and in 1774 a clear annual revenue of £3000 to Great Britain. In 1753 the delivery of letters by the penny post was begun, and also the practice of advertising letters remaining in the office in Philadelphia. In 1774 Franklin became obnoxious to the British Government, on account of his connection with the petition for the removal of Governor Hutchinson from Massachusetts, and on January 31st of that year he was dismissed from the Deputy Postmaster-Generalship. By this time the patriotic movement which concluded in the Revolution was in full tide, and so great was the feeling caused by Franklin's dismissal that private arrangements were made for carrying letters, and after 1774 the American post-office never again contributed a farthing to the British treasury. In fact, in 1775 the colonies combined to establish their own post-offices and to pay the necessary officials, the Continental Congress appointing a committee to devise a postal system, which went into effect July 26, 1775, when Benjamin Franklin was unanimously appointed Postmaster-General, with authority to establish a line of posts from Falmouth, Me., to Savannah, Ga., and as many cross posts as might seem to him necessary. During the period of the Revolution the postage was paid in currency; but this depreciated so much in value that it was ordered that only specie should be received. In 1792 rates of postage were fixed which remained unaltered for nearly half a century. They were: for 30 miles and under, 6 cents; over 30 miles and not exceeding 60 miles, 8 cents; over 60 and not exceeding 100 miles, 10 cents; and so on up to 450 miles and over, for which the charge was 25 cents. On account of these expensive rates, comparatively few letters were sent through the mails, it being found cheaper to send them by private express. In 1845 the rates were lowered and a scale based on weight as well as distance was adopted. The postage on letters not exceeding $\frac{1}{2}$ ounce in weight was fixed at 5 cents for any distance not exceeding 300 miles; over 300 miles it was 10 cents, with an increase of rate for every additional half ounce in weight. The rate on newspapers was nothing for distances under 30 miles; for over 30 miles and under 100, one cent was charged; over 100 miles, if beyond the borders of the State, the charge was $1\frac{1}{2}$ cents. In 1851 the rate on letters not exceeding $\frac{1}{2}$ ounce in weight was reduced to 3 cents for distances under 3000 miles and 6 cents for distances above 3000 miles. If not prepaid the rates were 5 and 12 cents respectively. Prior to 1851 no reduction was made for prepayment of postage. In 1855 a law was passed requiring prepayment, and this has continued to be the rule. In 1863 the element of distance as a factor in fixing the scale of rates was abolished and a uniform rate of 3 cents was established for letters not exceeding $\frac{1}{2}$ ounce in weight. In 1883 this rate was reduced to 2 cents.

STAMPS. In 1847 adhesive postage stamps were first introduced into the United States, but, on account of the high rate of postage and the pro-

vision allowing optional prepayment, they did not come into general use until 1855, when the rates were reduced and prepayment required. In 1852 stamped envelopes were introduced and in 1872 postal cards were authorized. In 1879 double or reply postal cards were authorized, and in 1898 private mailing cards were allowed to be sent through the mails at the rate of one cent postage, subject to certain restrictions prescribed by the Postmaster-General.

CLASSIFICATION OF MAIL MATTER. Domestic mail matter is arranged into four classes. The first class includes letters, postal cards, and all matter wholly or partly in writing, whether sealed or unsealed (except manuscript and corrected proof). The rate on all matter of this class is two cents an ounce or fraction thereof. On postal cards it is one cent each, the price for which they are sold. On 'drop letters' the rate is two cents an ounce at free delivery offices and one cent elsewhere. The rule is prepayment except where the amount of the postage exceeds two cents, in which case if the weight does not exceed four pounds the excess of two cents may be called for from the addressee. Second-class matter includes newspapers and other periodical publications issued as often as four times a year, which bear a date of issue and are numbered consecutively and issue from a known office of publication, and which are in the form of printed sheets without substantial binding. The rate of postage on second-class matter when sent by the publisher from the office of publication, or by a news agency to actual subscribers or to other news agents, is one cent a pound or fraction thereof. To actual subscribers within the county in which the paper is published postage is free except at free delivery offices. To all other persons than publishers and newsdealers the rate of postage on second-class matter is one cent for four ounces or fraction thereof to any place in the United States, Porto Rico, Guam, Philippine Islands, Canada, and Mexico. Third-class matter includes books, circulars, pamphlets, and other matter wholly in print (not included in second class), proof-sheets, corrected proof-sheets, and manuscript copy accompanying the same. By act of July 24, 1888, seeds, bulbs, roots, scions, and plants are also mailable at third-class rates. The rate of postage on third-class matter is one cent for each two ounces or fractional part thereof, to be fully prepaid by postage stamps affixed thereto. Fourth-class matter includes all not embraced in the first three classes which is not in its form or nature liable to destroy, deface, or otherwise damage the contents of the mail-bag or harm the person of any one engaged in the postal service and not above the weight prescribed by law. The rate of postage is one cent an ounce or fraction thereof, to be prepaid by ordinary stamps. No package of third or fourth class matter weighing more than four pounds will be received for conveyance by mail except single books. Destructive articles, obscene and scurrilous matter, lottery circulars and tickets are excluded from the mails, and the Postmaster-General is empowered by Congress to direct any postmaster to withhold mail addressed to any person or firm conducting a business which he is satisfied is a fraudulent one.

REGISTERED LETTERS. By an act of 1855 provision was made for a system of registration by

which extra precaution is taken in the transmission of valuable letters and parcels upon payment of a fee of eight cents in addition to the regular postage. The postal officials take special care of such letters, but the Government, until recently, refused to assume responsibility for such letters when lost. By an act of 1897, however, provision was made for indemnifying persons who lose registered letters and parcels of value, but the limit of indemnity is \$25 or the actual value of the article where that is less than \$25. In 1898, in more than 15,000,000 pieces of registered mail, there were but 504 cases of actual loss.

MONEY ORDERS. In 1864 the postal money order system was adopted, by which one is enabled to transmit money through the mails by making a deposit of the amount with the postmaster and receiving an order on the postmaster of the place to which the money is to be sent. No single money order for more than \$100 may be issued. The fees charged range from five to thirty cents, according to the amount sent. For international money orders the fees range from 10 cents to \$1.

FREE DELIVERY. The system of delivering mail by carriers at the houses and offices of persons to whom it is addressed was first introduced on a small scale in 1863. In 1865 free delivery was extended to all places having a population of 50,000, and such other places as in the opinion of the Postmaster-General might seem expedient. In 1873 the system was extended to all places of 20,000 inhabitants and over, and in 1887 to cities of 10,000 inhabitants or whose postal receipts amounted to \$10,000. Provision was also made in 1885 for special or immediate delivery of letters within certain limits upon the payment of a fee of 10 cents in the form of a special stamp. In 1896 an experiment of delivering mail to inhabitants of rural districts was tried. The results were so satisfactory that the system has been largely extended. In 1902 there were 11,650 established free delivery routes in the United States and preparations were being made to add many more.

PARCELS POST. In the United States there is no distinct parcels post as in England, parcels being conveyed through the regular mails as fourth-class matter. Arrangements, however, exist with Mexico, certain of the West Indies, and certain Central and South American countries providing for a parcels post between the countries concerned.

THE FRANKING PRIVILEGE. The privilege of sending and receiving mail free of postage was once enjoyed by the President of the United States, Vice-President, heads of departments, Senators and Representatives, and other officials of the Government during their official terms. An act of 1873 this privilege was conferred on all ex-Presidents and widows of ex-Presidents. By an act of 1873 this privilege was abolished, but by later acts it was conferred on all officers of the Government in the case of official correspondence. In 1895 the privilege was voted to members of Congress for their official correspondence.

GROWTH OF THE POSTAL SYSTEM. The growth of the postal business in its various branches has been almost phenomenal. The following table shows by decades the increase in the number of offices, receipts, and expenditures from 1792 to the present:

YEAR	Number of offices	Receipts	Expenditures
1792.....	195	\$67,443	\$54,530
1802.....	1,114	327,044	269,866
1812.....	2,610	649,208	540,165
1822.....	4,709	1,117,490	1,167,572
1832.....	9,205	2,258,570	2,266,171
1842.....	13,733	4,546,849	5,674,752
1852.....	20,901	6,925,971	7,108,459
1862.....	28,875	8,299,821	11,125,364
1872.....	31,863	21,915,426	26,658,192
1882.....	46,231	41,883,005	40,482,021
1892.....	67,119	70,930,475	76,980,846
1902.....	75,924	121,848,047	124,809,217

The largest items of expenditure were for transportation of the mails on railroads, compensation of postmasters, free delivery service, compensation of clerks, and transportation of the mails on the star routes. From 1880 to 1898 the population of the country increased 50 per cent., while the volume of postal business increased 150 per cent. In 1845 the total number of pieces of mail handled in the United States did not exceed 29,000,000. During the year 1902 the number of pieces of mail handled amounted to over 8,000,000,000 of ordinary mail, besides 22,831,400 pieces of registered matter. During the same year 41,785,438 domestic and international money orders were issued, having a face value of \$336,525,752. The total number of postage stamps, stamped envelopes, postal cards, etc., was 6,061,456,127, having a total value of over \$112,000,000. Consult: Lewins, *Her Majesty's Mails* (London 1864); Joyce, *History of the Post-Office* (London, 1893); *British Postal Guide and Post-Office Handbook*; Cushing, *Our Post-Office* (Boston, 1893); *American Postal Guide, Annual Reports of the Postmaster-General*. See POSTAGE STAMPS.

POST-OFFICE CLERKS OF THE UNITED STATES, UNITED NATIONAL ASSOCIATION OF. An association of post-office clerks in the classified service, whose principal object is to eliminate favoritism and political influence in the promotion of clerks by bringing the promotion as well as appointment of first and second class post-office clerks under the provisions of the Civil-Service Law. It seeks also to improve the working rules and discipline of post-offices in such matters as irregular hours of labor, imposition of fines for mistakes, etc. The association is not affiliated with any labor organization. Its principal work is carried on by a legislative committee, which is endowed by the Constitution with full power to act in all matters pertaining to legislation. The association was organized in New York November 14, 1899, and was incorporated under the laws of Maryland January 25, 1900. It is composed of 11 State associations and about 225 branches, with an aggregate membership, excluding duplicates, of nearly 10,000 persons. Its official organ is the *Postal Clerk*, published monthly at Chicago, Ill.

POST-TERTIARY PERIOD. The same as Pleistocene period (q.v.).

POSTULATE. See AXIOM.

POTASH. See POTASSIUM; SODA.

POTASH SALTS. See POTASSIUM.

POTASSIUM (Neo-Lat., from *potassa*, potash, from Eng. *potash*, from *pot* + *ash*). A metallic chemical element first isolated by Sir

Humphry Davy in 1807. The carbonates of potassium and of sodium, undistinguished from each other, were called *alkali* by the alchemist Geber, and they were known as *fixed alkali* in order to distinguish them from ammonium carbonate, known as the *volatile alkali*. Duhamel, in 1736, discovered that the alkali contained in common salt is different from that contained in the ashes of land plants, and thenceforth the first-named was called 'mineral alkali' and the second 'vegetable alkali.' In 1758 Marggraf showed that the salts of the common alkali gave a violet tinge to the flame of a spirit lamp, while those derived from common salt showed a yellow color. Klaproth next pointed out that the 'vegetable alkali' was contained also in several minerals, such as leucite, subsequent to which the special name of *potash* was applied to this alkali, and that of *natron* or *soda* to the mineral alkali. Both of these alkalies remained undecomposed up to the time of Davy's experiments. (See CHEMISTRY.) Davy decomposed potash by passing the electric current from a voltaic pile of 200 plates through a piece of potash placed in a platinum dish, the result being the formation of "small globules having a high metallic lustre, some of which burned with explosion and bright flame as soon as they were formed, and others remained and were merely tarnished and finally covered by a white film which formed on their surfaces," and these, he concluded, were the peculiar "inflammable principle, the basis of potash."

Potassium is not found native, but is widely distributed, in combination, especially as the chloride and sulphate, in sea water and other natural waters; also as a constituent of many silicates, as the feldspars and micas, forming from 1.7 to 3.1 per cent. of the granite composing the earth's solid crust. As *sylvite* (potassium chloride) and as *carrollite* (potassium and magnesium chloride) it occurs in the beds overlying the salt deposits of Stassfurt, Germany; and as nitre or the nitrate it is found as an efflorescence on the soil, usually with the sodium salt, in Chile, Peru, etc.; also as *alunite* (hydrous sulphate of potassium and aluminum), occurring in the older rocks, where its formation is attributed to the action of sulphurous gases. It is found as bitartrate in wines, and as sulphate, carbonate, and chloride in molasses from beets. As chloride and carbonate, or as an organic salt, it occurs in soils and in vegetable and animal substances; wood ashes and the ash of marine plants contain much potassium carbonate. The suint from the wool of sheep contains a large proportion, sometimes as much as one-third, of an organic potassium salt which is separated as carbonate, together with the wool fat.

The original electrolytic method used by Davy for the preparation of metallic potassium has already been referred to. It was soon superseded by methods which had for their purpose the reduction of the carbonate by means of carbon; thus an intimate mixture of potassium carbonate with charcoal, obtained by igniting crude acid potassium tartrate in an iron crucible, yielded a porous mass which was heated to a white heat in an iron bottle connected with a receiver, into which the potassium distilled over and was condensed. The process now generally used is practically the one invented by Castner, and consists

in reducing a potassium salt, such as the hydrate, by a mixture of carbon and a metallic carbide, or a mixture of very finely divided metal and carbon, which is heated in an iron crucible with an exit tube passing through the lid. The potassium distills over into the receiver and at the end of the operation is placed under petroleum so as to prevent oxidation.

Potassium (symbol, K; atomic weight, 39.11) has, when freshly cut, a bright silvery metallic lustre and a specific gravity of 0.875 at 13° C., being lighter than any other metal except lithium. It is brittle at 0° C., and possesses a crystalline fracture; at 15° C. it becomes soft like wax, and it melts at 62.5° C. (144.5° F.), forming a liquid that closely resembles mercury in appearance. With the exception of cesium and rubidium, it is the most electro-positive element known, and it acts as a powerful reducing agent. On exposure to the air it rapidly becomes converted into the hydrate, and finally into the carbonate. It decomposes water with sufficient energy to ignite the liberated hydrogen. When brought into contact with the halogens and with sulphur, selenium, tellurium, and phosphorus, it unites with them. It also alloys with most metals, usually by being heated with them, and with sodium it forms an alloy of a low melting-point. For commercial purposes its use, especially as a reducing agent, has been almost entirely superseded by sodium, owing to the cheapness of the latter. With oxygen potassium combines to form two oxides, a *monoxide* (K_2O) and a *peroxide* (K_2O_2). The former is formed when potassium hydrate is heated with metallic potassium; it is a gray, brittle mass that has strong basic properties. When dissolved in water this oxide forms potassium hydroxide (KOH), or caustic potash, which, however, is generally prepared commercially by decomposing a dilute solution of potassium carbonate with slaked lime. Potassium hydroxide is a hard, white, brittle, powerfully caustic substance, quickly destroying many animal and vegetable substances, and finds extensive use in the manufacture of soap. It is the *liquor potassæ* of the pharmacopœia, and is used as a caustic in surgical operations, and finds some application in analytical chemistry. Potassium peroxide is formed when metallic potassium is burned in the air. *Potassium arsenate*, called also 'Macquer's salt,' is prepared by fusing together equal parts of potassium nitrate and arsenious anhydride, then dissolving the resulting mass in water and evaporating. On cooling, the arsenate crystallizes out. It is used in calico printing for the purpose of fixing the mordant on the fibre of the material. *Potassium bromide* may be made by dissolving bromine in a solution of potassium hydroxide, evaporating the solution, and igniting the mixture, with the addition of a little charcoal, which reduces potassium bromate to bromide, and the mass is dissolved in water, filtered, and allowed to evaporate and crystallize. A more satisfactory method, however, consists in decomposing iron bromide with potassium carbonate, and allowing the resulting liquid to crystallize. Potassium bromide crystallizes in the form of white cubes that have a strong saline taste, and find extensive application in photography and medicine. *Potassium carbonate*, which was known to the ancients and is described by Aristotle as being prepared by the burning of rushes, was long obtained by burning plants in

dry pits and dissolving the ashes in water, then evaporating till the sulphates, chlorides, etc., separated out by crystallization, and then boiling the mother liquor to dryness in iron pots, which was probably the origin of the name 'potashes.' The process subsequently introduced was similar to that used by Le Blanc for the manufacture of soda ash, and consisted in fusing potassium sulphate with calcium carbonate and coal. Another source is from the suint of sheep's wool. The raw wool on washing yields a mixture which is evaporated to dryness, and the solid residue is calcined in retorts. The resulting mass is dissolved in water and allowed to cool, when the potassium carbonate is deposited as a mass of crystals. This salt, which is a white solid with an alkaline and caustic taste, is used largely in the manufacture of soft soap, glass, potassium chromate, and potassium ferrocyanide. *Potassium chloride*, known commercially as *muriate of potash*, is now largely obtained from the Stassfurt deposits, where it occurs native as sylvite, and in combination with magnesium chloride as carnallite. The last-named is the principal source. The mineral is dissolved in warm water, heated by steam to about 120° C. (248° F.), and then allowed to cool. Between 60° and 70° C. (140° to 158° F.) the magnesium sulphate, calcium sulphate, and sodium chloride separate, and on further cooling about 70 per cent. of the potassium chloride is obtained, the crystals of which are washed with a little cold water to remove any sodium or magnesium chloride, and a product is obtained containing about 95 per cent. of potassium chloride. Small quantities are also manufactured from the ashes of seaweed, which, previous to the working of the Stassfurt deposits, formed one of the principal sources of potassium salts. Potassium chloride is a white crystalline compound with a strong saline taste. It is used chiefly in the preparation of other potassium salts, such as the carbonate and the chlorate, and in an impure state it is employed as a fertilizer. *Potassium bichromate* is prepared by heating together finely ground chromic iron ore with potassium carbonate and lime. The resulting mass is extracted with hot water and the calcium chromate precipitated out by means of potassium sulphate, leaving in solution potassium chromate, which is then converted into the bichromate by treatment with sulphuric acid. The resulting solution is evaporated to crystallization, yielding splendid garnet-red crystals. Potassium bichromate finds extensive use in the preparation of chromium compounds, in the manufacture of various colors, as an oxidizing agent, and in certain photo-engraving processes, owing to the fact that when mixed with gelatin it becomes insoluble when exposed to the light. This particular property has also led to its employment in the manufacture of insoluble glue. *Potassium cyanide* may be prepared by melting potassium ferrocyanide with potassium carbonate in an iron crucible. It is a white crystalline compound, exceedingly poisonous. It finds some use in photography, and as a reducing agent in chemical operations, especially in metallurgy. (See HYDROCYANIC ACID.) *Potassium iodide* may be prepared by dissolving iodine in potassium hydroxide, in the same way as the bromide is made by the action of the hydroxide on bromine. It is also manufactured by decomposing ferrous iodide with potassium carbonate, evaporating, dissolv-

ing the resulting mass, and crystallizing. This salt crystallizes in white cubes that have a sharp taste, and is used chiefly in photography and in medicine. *Potassium nitrate*, which is found native as nitre, or saltpetre, is described under SALTPETRE. *Potassium silicate* is prepared by heating potassium carbonate with white sand in a reverberatory furnace, usually with a small amount of charcoal, by means of which a compound is obtained that is put on the market as a thick solution, and is used as a substitute for sodium silicate in the manufacture of soaps and in fresco painting. (See WATER-GLASS.) *Potassium sulphate* is found in large quantities at Stassfurt, principally as kainite, which is a potassium and magnesium sulphate with magnesium chloride. This mineral, when allowed to remain for some time exposed to the air, deliquesces, and as soon as the soluble magnesium chloride has run off the remaining salt is decomposed by boiling water, so that on cooling the sulphate crystallizes out. It is also obtained by the action of sulphuric acid on a potassium chloride. It is a crystalline salt with a bitter saline taste, and finds use in medicine as a purgative, while large quantities are used for the manufacture of potash-alum and potassium carbonate. It was formerly called *sal polychrest*. The acid sulphate, or bisulphate, the *sal enium* of the older chemists, may be formed by heating potassium sulphate with sulphuric acid, or by heating potassium nitrate with sulphuric acid. It is a white crystalline compound, occasionally used as a flux. Other potassium salts may be found described under the names of the acids contained in them. Consult: Pfeiffer, "Die Stassfurter Kali-Industrie," in vol. ii. of Bolley's *Handbuch der chemischen Technologie* (Brunswick, 1887); Lunge, *A Theoretical and Practical Treatise on the Manufacture of Sulphuric Acid and Alkali* (London, 1891); id., *The Alkali-Maker's Handbook* (ib., 1891). Consult also the dictionaries and industrial works recommended in the article CHEMISTRY.

POTASSIUM CYANIDE. See HYDROCYANIC ACID.

POTATO (from Sp. *patata*, white potato, *batata*, sweet potato, from Haytian *batata*, sweet potato). An important cultivated plant, raised in temperate climates for its esculent tubers. It is often called Irish potato because of its general cultivation and use in Ireland. It belongs to the order Solanaceæ, or nightshade family, which also includes tobacco, belladonna, tomato, egg-plant, and pepper. The potato (*Solanum tuberosum*) is a native of the mountainous districts of tropical and subtropical America, from Chile to Mexico, a form of it even occurring as far north as southern Colorado. It is difficult, however, to determine where it is really indigenous and where it has been introduced by man. Like maize, it was cultivated and its tubers used for food before the discovery of America. It seems to have been first brought to Europe from Peru by the Spaniards early in the sixteenth century, and to have spread from Spain into Holland, Burgundy, and Italy, but only to be cultivated in a few gardens as a curiosity. In nearly all European countries it was called *batata*, by which name sweet potato is designated by English writers down to the middle of the seventeenth century. The data concerning its intro-

duction into Europe are not very definite. It appears to have been brought to Ireland from Virginia by Hawkins, a slave trader, in 1565, and to England by Sir Francis Drake in 1585. Sir Walter Raleigh is said to have taken some tubers to England in 1586 and brought them to the attention of Queen Elizabeth. It was not until a long time after its introduction that the culture of the potato became general. Gerard in his *Herball*, published in 1597, described it under the name of *Batata Virginiana*, but so little were its merits appreciated that it was not even mentioned in *The Complete Gardener*, a work published in 1719. At first it was regarded chiefly as a food for swine and cattle, but later on it was thought that on account of its great yield it might be useful as food for poor people and for the prevention of famine due to failures of the grain crops. The Royal Society of London in 1663 adopted measures for the extension of its culture in accordance with this idea. Its cultivation first became most general in Ireland, but it was not until about the middle of the eighteenth century that it acquired any real importance on the Continent of Europe, and not until the end of that century did it become important as a field crop in Germany and France, which are to-day two of the greatest potato-producing countries of the world. In France the extension of potato culture was mainly due to the efforts of Parmentier, a prominent agriculturist and economist. Historical data concerning the development of the potato as a crop in North America are even more meagre. In 1771 only a white and a red variety were mentioned in the most important English work on gardening, while to-day at some of the experiment stations in Europe and America tests are made of 150 to 200 varieties at one time. Apart from the abnormal development of the tubers and the very much reduced production of seed, it is believed that there have not been great changes in the potato plant since its cultivation became general.

The potato is a perennial plant with smooth herbaceous stems from one to three feet high, pinnate leaves, and white or purple flowers about one inch wide, and producing a globular, purplish fruit or seed-ball of the size of a gooseberry. See PLATE OF VEGETABLES. The tubers are distinct from the roots, being underground stems of considerable size even when the plant is in its native state, and which under the influence of cultivation have become enlarged through the accumulation of starch for the use of the plants grown from the eyes, or buds. Owing to its wide distribution, from the cooler tropics to the cooler temperate zones, it is grown on a great variety of soils, but the soil best suited to the crop is a rich, sandy loam, well supplied with organic matter and well drained. It responds to liberal manuring, but since a direct application often injures the quality of the tubers, barnyard manure is preferably applied the previous year; otherwise complete commercial fertilizers, containing nitrogen, phosphoric acid, and potash, are applied.

The land should be plowed as deeply as possible without turning up the subsoil. The tubers are generally planted in drills wide enough apart to admit of cultivation with the horse hoe, or cultivator, and from 12 to 16 inches apart in the row. The pieces of the tuber used for planting, called sets, cuttings, or seed pieces, are covered about 4 inches deep. Planting is generally done

by hand, but where the crop is grown on a large scale potato planters are used. The crop is planted in the spring when danger of injury by frost has passed. After planting, the soil is harrowed frequently until the plants are all up, when the cultivator is used until the vines shade the ground. The results of experiments at different experiment stations in the United States indicate that the use of half the tuber as a seed piece is preferable to using smaller cuttings or the whole tuber. In the Southern United States two crops of potatoes are sometimes produced on the same land in one year.

POTATO DISEASES. Until comparatively recently the potato blight or rot was believed to be all caused by a single fungus. Two distinct forms are now held accountable, the leaf or early blight, and the late blight or rot. The early blight (*Alternaria solani*) appears upon the leaves as grayish brown spots, which, about the time the tubers are beginning to form, enlarge, and in ten days or two weeks involve half the leaf. In about a month all the foliage may have succumbed. The late blight or rot (*Phytophthora infestans*) appears in August or September, attacking leaves, stems, and tubers. The leaves are first to appear to be injured. They show brown or black areas, which soon become soft and foul-smelling. Moisture and a fairly warm, but not hot, temperature is most favorable to its rapid development, and a few dry, hot days will check its spread. The tubers also become blotched or discolored on the surface and streaked within with brown or black. Since they are likely to rot, the crop is practically worthless. Both of these diseases can be prevented by spraying with Bordeaux mixture, beginning when the plants are 4 to 6 inches high and continuing through the season at intervals of 10 days to 2 weeks. Brown rot, believed to be caused by *Bacillus solanacearum*, is sometimes troublesome in the Southern States. The foliage usually wilts, shrivels, and turns brown or black. Since leaf-eating insects are held accountable for the spread of this trouble, they are combated with insecticides. Rotation of crops is recommended as a means of prevention and care in the selection of seed tubers that they do not come from infested regions. Scab appears as rough, dark patches of varying depth upon the tubers and upon beet roots, rendering them unsightly and destroying the outer portions. Scabby potatoes and infested soil should be avoided. Many growers soak the 'seed' in a solution of 2½ ounces of corrosive sublimate in 15 gallons of water; or 8 fluid ounces of formalin, or formaldehyde, in 15 gallons of water, after which the tubers are spread to dry. These are considered preventive measures.

FOOD AND FEEDING VALUE. When a section of the potato is carefully examined, it will be seen to consist of three more or less well-defined portions, namely, the skin, cortical or fibro-vascular layer, and the flesh, which is made up of the outer and inner medullary layers. The cortical layer, immediately beneath the true skin, and sometimes designated the inner skin, is slightly colored, containing practically all the coloring matter normally present in the potato. As shown by recent analyses, the skin of the potato constitutes on an average 2.5 per cent. of the whole and the cortical layer 8.5 per cent. It is difficult to peel potatoes so that the skin only is removed.

The amount of refuse and edible portion lost by peeling is estimated at 20 per cent. Doubtless, in many cases the rejected portion is very much larger.

The edible portion is made up of 78.3 per cent. water, 2.2 per cent. protein (total nitrogenous matter), 0.1 per cent. fat, 18.4 per cent. carbohydrates (principally starch), and 1 per cent. ash or mineral matter. Of the carbohydrates, 0.4 per cent. is made up of crude fibre and materials which in some of their modifications constitute the cell walls of plants and give them a rigid structure. The fuel value is 385 calories per pound. The above figures, like others for composition of food materials, represent general averages, from which there are wide variations in individual specimens. Though the skin, cortical layer, and flesh differ somewhat in composition, they all resemble more or less closely that of the whole tuber. When potatoes are stored they shrink about 12 per cent. in 7 months.

Although the potato contains some protein, it is chiefly valuable as a carbohydrate food, and, like all such food, is useful for supplying the body with energy. The principal ways of cooking potatoes are baking, boiling, and frying, or some modifications of these processes. Just why cooking changes the flavor as it does has apparently never been made the subject of investigation. In potatoes, as in other foods, the cooked starch is more agreeable to the taste than the raw. Possibly also there are volatile bodies of more or less pronounced flavor which are removed or produced by the heat of cooking. The physical condition of the potato is much affected by heat. In the raw potato the separate starch grains are inclosed in cells with walls composed of crude fibre, a material resistant to digestive juices. If potatoes were eaten raw, the digestive juices would not reach the starch as easily, unless the cell walls happened to be ruptured mechanically, as in mastication. Heat, however, expands the water present, ruptures the cells, and breaks up the starch, expanding the granules, which when raw consist of tightly packed concentric layers. Over 90 per cent. of the total nutritive material of potatoes is digestible. According to statistics obtained in the large number of dietary studies made in this country, potatoes constitute about 13.7 per cent. of the total food consumed by the average American family, and furnish not far from 3.9 per cent. of the total protein and 10 per cent. of the total carbohydrates. The potato is a staple article of diet in almost every household. The universality and extent of its consumption would seem sufficient to prove it to be a wholesome and nutritious food. Scientific investigation shows that the practice, which has become so general, of serving potatoes with meat and other similar foods which contain liberal amounts of protein is based upon correct principles, one food supplying the deficiencies of the other.

Evaporated potatoes are on the market, being especially recommended for provisioning camps and expeditions. As compared with fresh, the evaporated potatoes have a high nutritive value in proportion to their bulk. Large quantities of potatoes are used for the manufacture of starch. Potatoes either raw or cooked are sometimes fed to pigs, milch cows, and other farm animals. When fed to pigs it has been found that 4½

bushels of cooked potatoes (fed with corn meal) is equivalent to one bushel of corn.

POTATO INSECTS. The principal enemy of the common field potato (*Solanum tuberosum*) of the United States is the famous 'potato bug,' or more exactly, the Colorado potato beetle (*Dorophora decemlineata*). This insect, originally confined to the Rocky Mountain region, where it fed upon the sand-bur (*Solanum rostratum*), readily attacked cultivated potatoes as soon as civilization advanced to its native region. In 1859 it had



COLORADO POTATO BUG AND ITS FEEDING LARVA.

spread eastward and reached a point 100 miles west of Omaha; in 1861 it invaded Iowa; in 1864 and 1865 it crossed the Mississippi, reaching Illinois both from northern Missouri and Iowa; in 1867 it had crossed Illinois into western Indiana, and in 1869 had spread across the State and had made its way into Ohio, appearing almost simultaneously in the northern and south-western portions; in July, 1870, it invaded the Province of Ontario; in 1872 it reached western New York, and spread into Pennsylvania, and in 1873 had reached eastern New York and the District of Columbia; in 1874 the Atlantic Seaboard was gained at several points in Connecticut, New Jersey, New York, Pennsylvania, Delaware, Maryland, and Virginia. Its southern spread was much more slow than in the North, and in 1871 it had not touched the extreme southern counties of Missouri. In fact, it was not until 1897 that it succeeded in establishing itself in portions of Mississippi and Georgia. Although accidentally introduced into Europe on several occasions, the species has not established itself outside of North America. The female beetles, which have overwintered beneath the surface of the ground or under any shelter, lay their eggs upon young potato plants as soon as they appear above ground, and will even work into the ground to feed upon the young leaves before these have fairly shown themselves. The dark-reddish larvæ hatch in less than a week, and reach full growth in from two to three weeks, after which they enter the earth to pupate, becoming beetles about a month after the time of hatching. There are three or four generations each year. This insect is readily controlled by the application of Paris green or some other arsenical poison, either as a spray or dusted dry upon the plants. The potato bug is also destroyed by the potato-bug enemy (*Lebia grandis*). See Colored Plate of INSECTS.

The potato crop is sometimes damaged by the so-called stalk-borer (*Gortyna nitela*), an owl moth which lays its eggs on the stalks not only of potato, but also of tomato and of certain ornamental plants. The larva bores into the stalk and causes the plant to wilt. The potato-stalk weevil (*Trichobaris trinotatus*) is very common in the Mississippi Valley. The bluish or ash-gray beetle deposits a single egg in a slit which she has made with her beak in the stalk of the potato. The larva bores into the heart of the stalk and proceeds downward toward the root, pupating within the stalk, issuing as an adult about the last of August. In both cases all wilting vines should be pulled and burned.

The tomato worm (*Sphinx 5-maculata*) also feeds occasionally upon potato, but is not an important enemy of this crop. Potatoes suffer, however, sometimes severely, from the attacks of blister beetles, and a leaf-beetle called the three-lined potato beetle (*Lema trilineata*) occasionally damages the leaves. The cucumber flea-beetle (*Haltica cucumeris*) also preys upon the leaves, as does one of the tortoise beetles.

Consult: Riley, *Potato Pests* (New York, 1876); Smith, *Manual of Economic Entomology* (Philadelphia, 1896).

POTATO ROT, SCAB, etc. See POTATO, paragraph *Potato Discases*.

POTATO STONE. See GEODES.

POT'AWAT'AMI (properly *Potawatmik*, fire-makers, in allusion to their traditional making of a separate council fire for themselves). A prominent Algonquian tribe formerly holding the lower end of Lake Michigan, extending southward to the Wabash River and westward into central Illinois. They were closely related to the Ojibwa and Ottawa (qq.v.). When first known the Potawatami were settled about the mouth of Green Bay, Wis., and were early brought under the influence of the Jesuit mission established at that point. They were then moving southward, and 30 years later had fixed themselves at Chicago and on the Saint Joseph River, on former Miami territory. After the conquest of the Illinois (q.v.) about 1765 they took possession of a great part of Illinois as well as of Lower Michigan. At the Greenville treaty of 1795 they notified the Miami that they intended to move down the Wabash, which they soon afterwards did, in spite of the protests of the Miami, who claimed the whole region. By the year 1800 they were in possession of the whole territory around Lake Michigan from Milwaukee River, Wis., to Grand River, Mich., with much of northern Indiana and Illinois.

They took part with the French in all the colonial wars and were also active in the rising under Pontiac. They sided with England in the Revolution and, with the other tribes, continued the struggle until the Treaty of Greenville in 1795. In the War of 1812 they again took up arms, under Tecumseh, on the English side, and later joined in the final treaty of peace in 1815. Under the systematic plan of removal soon after inaugurated by the Government they sold their lands by successive treaties, so that by 1841 practically the whole tribe had been transported beyond the Mississippi. A large part of those residing in Indiana refused to leave their homes until driven out by military force. Some escaped to Canada and are now settled on Walpole Island, in Lake Saint Clair. Those who went west were settled, partly in Iowa and partly in Kansas, but in 1846 both bodies were united on a reservation in southern Kansas. In 1868 a part of these, known as Citizen Potawatami, were again removed to Indian Territory. A considerable part of the tribe is still in Wisconsin and another small band known as Potawatami of Huron is in Lower Michigan, in addition to the small band on Walpole Island, Ontario. According to Morgan the Potawatami had 15 clans. The most reliable early estimates give them from 2500 to 3000 souls at their greatest strength. They now number about 2500 in all, viz. Citizen Potawatami, Oklahoma, 1690; Prairie band, Kansas, 570;

Potawatami of Huron, Michigan, 80; scattering in Oklahoma, Wisconsin, Indiana, etc., perhaps 200; Walpole Island and Aux Sables, Ontario, mixed Potawatami and Ojibwa, 200.

POT-BOUILLE, pó'bóu'éy'. One of Zola's Rougon-Macquart series of novels (1883), a satire on the corrupt commercial bourgeoisie of Paris.

POTCHEFSTROOM, pöch'éf-ström. A town in the southern part of the Transvaal Colony, South Africa, 105 miles southwest of Pretoria. (Map: Transvaal Colony, D 5). Population, about 5000.

POTEKHIN, pót-yèk'in, ALEXEI ANTIPOVITCH (1829—). A Russian dramatist and novelist. He was born at Kineshma, in Kostroma, studied at Jaroslav, and settled in Saint Petersburg. As a novelist he is a realist of much the same school as Pisemsky and especially able in his portrayal of dismal village life. His earlier works on the drama were slow in getting to the stage, as they were blocked by the censors for their attacks on present conditions. They include: *The Voice of the People Not the Voice of God* (1853); *Ill-Gotten Gains Do Not Prosper* (1854); *Tinsel* (1858); *The Severed Limb* (1865); and *A Vacant Place* (1870). His novels and tales of peasant life include: *The Poor Nobles* (1859); *For Money*, a story of factories; *The Sick Woman* (1876); *Under the Spell of Money* (1876); *Before the Community* (1877); *Young Inclinations* (1879); and *Village Vampires* (1880).

POTEMKIN, *Russ. pron.* pot-yám'kín, GREGOR ALEXANDROVITCH, Prince of Taurida (1736-91). A Russian politician, born in the Government of Smolensk. He was educated at Warsaw and became an ensign in the Imperial Horse Guards. He won the favor of the Empress Catharine II. (q.v.), and in 1762 he was made an officer of her household, succeeding in time Orloff as the recognized favorite of the Empress. When, in his turn, he was superseded as a lover, he retained his ascendancy in affairs of State, being made general-in-chief of the army, field-marshal, and governor of important provinces. As the principal representative of the Russian foreign policy, his influence was courted by the foreign rulers, and, in spite of a lack of the real gifts of statesmanship, he displayed a certain amount of skill in the conduct of affairs. He zealously furthered the process of southern expansion at the expense of the Turks, was instrumental in annexing the Crimea to Russia (1783), and for this service received the title of Prince of Taurida together with the governorship of the newly acquired territory. He devoted himself to the economic development of the southern provinces of Russia, founded the towns of Kherson, Kerteh, Nikolaev, and Sebastopol, and strengthened Russia's power in the Black Sea. It is told, as an illustration of the methods by which he preserved the Imperial favor, that in 1787, when Catharine visited his government, he caused a large number of villages to be constructed along her route, with hirelings to play the part of contented peasants and well-fed citizens, all of which pleased her Majesty and brought Potemkin increased honors. He died near Nikolaev, in Bessarabia, during the course of Catharine's second war against the Turks, October 16, 1791.

Consult: De Crenville, *Vie du Prince Potem-*

kin (Paris, 1808); Saint Jean (Potemkin's secretary), *Lebensbeschreibung des Gregor Alexandrovitch Potemkin des Tauriers*, edited by Rothermel (Karlsruhe, 1888); and lives in Russian by Levshin (2 vols., Saint Petersburg, 1808) and Brückner (1892).

POTENT. The name of a fur used in heraldry (q.v.).

POTENTIAL (OF. *potential*, *potentiel*, Fr. *potentiel*, from Lat. *potentia*, power, from *posse*, to be able). A mathematical term used to express that property of a field of force (see FORCE) which determines in which direction motion will take place if there are no restraints. In an electrical field of force the potential at a point is defined as the work required to carry a particle with a unit positive charge up to that point from an infinite distance away. If left to itself a positive charge will, therefore, always move from points of high to those of low potentials. In a magnetic field of force, the potential at a point is defined as the work required to bring up from an infinite distance to that point a unit north pole. If free to move, a north pole of a magnet will move from points of high to those of low potential.

In a gravitational field of force, the potential at a point is defined as the work required to bring up to that point from an infinite distance a unit mass of matter. Portions of matter, if free to move, do so from points of high to those of low potential.

In the application of thermodynamics to chemical phenomena a potential is such a function of the variable qualities that for all allowable changes it has the lowest possible value—it is a minimum.

POTENTIAL ENERGY. See MECHANICS.

POTENTILLA (Neo-Lat., from Lat. *potens*, powerful; so called on account of properties ascribed to it in mediæval medicine), CINQUEFOIL.

A genus of numerous species of mostly perennial herbs of the natural order Rosaceæ, widely distributed in the Northern Hemisphere. The genus differs from *Fragaria* (strawberry), which it otherwise resembles, in having dry instead of succulent receptacles of the fruit. The flowers are yellow, white, red, or purple, the leaves pinnate, digitate, or ternate. One species (*Potentilla fruticosa*) often planted in shrubberies is abundant in North America from Pennsylvania to Iowa and northward, and forms a profusion of yellow flowers. *Potentilla Anserina*, silverweed, a European species also common in America, has creeping stems, yellow flowers, beautifully silky and silvery leaves, and edible parsnip-flavored roots, which are much relished by swine and were formerly used as human food. There are a score or



SHRUBBY CINQUEFOIL.
(*Potentilla fruticosa*).

more species in the northern and central portions of the United States.

POTENZA, pò-tèn'sà. The capital of the Province of Potenza, Italy, situated on a hill near the Basento, 55 miles east of Salerno (Map: Italy, K 7). It is surrounded by a wall; it has a Doric cathedral, a gymnasium, a lyceum, a seminary, and an industrial school. The industries are the cultivation of the vine and the manufacture of bricks. Potenza has been largely rebuilt since the earthquake in 1857. Remains of several ancient cities, including *Potentia*, are in the vicinity. Population (commune), in 1881, 20,281; in 1901, 16,186.

POTGIETER, pòt'gè-tër, EVERHARDUS JOHANNES (1808-75). A Dutch critic and poet, born at Zwolle. He was engaged in business in Antwerp for a time, then settled in Amsterdam, where he became one of the circle of younger authors, and in 1837 founded *De Gids*, in which he made himself a name by clever criticism and excellent fiction and verse. These papers were collected partly by himself (1864-69; and in many editions) and partly by Zimmermann (1875 et seq.). Potgieter's further works are: *Het Noorden in omtrekken en tafereelen* (1836-40); *Liedekens van Bontekoe* (1840); a poem *Florence* (1868), typical of his worse style because of its obscurity; and a biography of Bakhuizen van den Brink (1870; 2d ed. 1890). Consult: Groenewegen, *E. J. Potgieter* (Haarlem, 1893); and Beets, *Persoonlijke herinneringen* (ib., 1892).

POTHIER, pò'tyá', ROBERT JOSEPH (1699-1772). A celebrated French law writer. He was born at Orleans; received a thorough education in a denominational school; studied law at the University of Orleans, attaining distinction in his classes; and after his admission to practice was made a judge of an inferior local court. He retained his studious habits, and in 1749 he was made a professor of law in the University of Orleans. He devoted himself to legal literature with great success. Perhaps his most important work was *Pandectæ Justinianæ in Novum Ordinem Digestæ* (Pandects of Justinian) (Paris, 1818-20). His works entitled *Maritime Contracts* (Boston, 1821), *Treatise on Obligations* (3d Amer. ed., Philadelphia, 1853) and *Contract of Sale* (Boston, 1839) were translated into English and published in the United States. Much of the Civil Code of France was compiled from his works.

POTI, pò'tyè. A seaport on the western coast of the Caucasus, Russia, situated in a marshy and unhealthy region at the mouth of the Rion and 60 miles west of Kutais (Map: Russia, F 6). Although it has only a small harbor, Poti is one of the chief seaports of the Caucasus and the terminus of one of the principal railway lines. Its chief exports are corn, manganese, palm wood, and grain. The imports are insignificant. Population, in 1897, 7700.

POTIDÆA (Lat., from Gk. Ποτιδαία, *Potidaia*). An important town of Macedonian Chalcidice. Originally a colony of Corinth, it became tributary to Athens. Its revolt from the latter city in B.C. 432 was one of the causes of the outbreak of the Peloponnesian War. In B.C. 429 the town was forced to surrender to the Athe-

nians. A century later it was rebuilt by Cassander and renamed Cassandria.

POTIER, pò'tyá', ALFRED (1840—). A French physicist and engineer, born at Paris. He studied at the Polytechnique and the Ecole des Mines, was appointed engineer in 1863, engineer-in-chief in 1881, in the latter year became professor of physics in the Polytechnique, and in 1891 was elected a member of the Academy of Sciences. His researches include interesting studies in geology and investigations, with Joubert, Allard, and others, to determine a means of measuring the energy dispensed by magneto and dynamo-electric machines and instruments. His published writings consist of papers contributed to the *Comptes Rendus* of the Academy of Sciences, the *Journal de physique*, the *Annales de physique et de chimie*, and other periodicals.

POTIPHAR PAPERS, THE. A series of satires by George W. Curtis on the vulgar, vain, shallow society of his day, contributed to *Putnam's Magazine* (1853).

POTLATCH (Nootka Indian *potlatsh*, *pahtlatsh*, gift). A custom of ceremonial gift distribution on a large scale, prevalent among the Kwakiutl, Chimshyan, and other tribes of the northwest coast. The custom is the greatest of all public ceremonies among these tribes, and the principal actor spends a lifetime of preparation in accumulating and storing up valuable property, all of which is finally to be given away in one magnificent display of generosity in the presence of the assembled tribesmen from the villages for miles around. Although to a stranger this wholesale giving appears a mere display of wasteful extravagance, it is in fact a wise investment at compound interest to be repaid in double value when need shall demand and in whatever form of help may be required. Boas says: "The principle underlying a potlatch is that each man who has received a present becomes to double the amount he has received the debtor of the giver."

The potlatch is in fact the recognized investment system of the northwest coast, the security being guaranteed by tribal honor. Potlatch ceremonies are celebrated on all important occasions, as the taking of a name or a wife, the initiation into a new dance, the installation of a chief, as well as at the will of the individual giver. When a great distribution is to be made, the announcement is first sent out by the chief to all the neighboring tribes, after which the date is fixed by council in the tribe of the giver. Messengers are then again sent out to invite the guests, who come in canoes, halting at some distance from the village to put on their best dress and paint. They then advance to the village in grand canoe procession, the bows of the canoes all abreast, each tribe singing its own song for the ceremony. As they draw near, the whole village goes down to the beach to welcome them, the chief's son or daughter, dressed in the mask of his clan, leading the way with a dance in their honor. A few blankets are given them, when they are escorted to the chief's house, where blankets are again distributed. They are then feasted, first by the chief, and then by all the others of the tribe who can afford it. After the feasting is done the grand distribution takes place, with songs and ceremonial accompaniment, each guest receiving blankets and other property

according to his rank. There is a farewell feast and the visitors return to their canoes and their homes.

POTOCKI, pò-tòts'ké. The name of a Polish family of high rank, possessing large estates in Galicia and the Ukraine. After the sixteenth century several members of the family held important places in State and Church. Among the most noteworthy may be mentioned: (1) **COUNT STANISLAS FELIX POTOCKI** (1745-1805), chief of the Polish artillery. In 1792 he joined Branicki and Rzewuski in issuing the manifesto of the confederation of Targovitz (q.v.). The next year he attempted, with the aid of Catharine II. of Russia, to carry out the objects of the confederation. The insurrection of 1794 forced him to leave Poland, and he fled to Russia. In his absence he was sentenced to death for treason, but the success of Suvaroff enabled him to return to Poland. He was appointed Russian field-marshal by Catharine in 1795.

(2) **COUNT IGNAZY POTOCKI** (1751-1809), grand marshal of Lithuania, a cousin of Stanislas Felix. He helped to form the Constitution of 1791; fled to Prussia upon the invasion of Poland by the Russians, but returned after the success of Kosciuszko, and became a member of the new Government. He was made prisoner by Suvaroff, and confined in Schlüsselburg. Released in 1796, he lived in Galicia till the approach of Napoleon's army in 1806, when he was again imprisoned for a short time.

(3) **COUNT STANISLAS KOSTKA POTOCKI** (1752-1821), brother of Ignazy, was prominent in drawing up the Constitution of 1791, and after the second partition of Poland was for a short time under arrest. After his release he became a devoted patron of science and literature. In 1807 he became head of the educational system in the Duchy of Warsaw; and after the Kingdom of Poland was reorganized (1815), became Minister of Public Instruction. He wrote a treatise on the *Art of the Ancients* and *On Eloquence and Style* (1815).

(4) **COUNT JAN POTOCKI** (1761-1816) was eminent as a student of Slavic antiquities and wrote several historical works, among them *Fragments historiques et géographiques sur la Scythie, la Sarmatie et les Slaves* (4 vols., Brunswick, 1795); *Histoire primitive des peuples de Russie* (Saint Petersburg, 1802). He also wrote memoirs upon Egyptian antiquities and *Voyage dans l'Empire de Maroc* (Warsaw, 1792). These works were printed in editions of but one hundred copies, and are therefore very rare. They have some value as collections of material.

(5) **COUNT ALFRED POTOCKI** (1817-89) rose to prominence as a member of the Galician Diet and the Austrian House of Peers. From 1867 to 1870 he was Austrian Minister of Agriculture, and from April, 1870, to February, 1871, head of the Cabinet.

POTOCKI, WACLAW (c.1622-97). The most prolific Polish poet. He served in the army, fighting in the war against the Cossacks (1653); in 1683 was appointed commissioner to map the boundary of Silesia; and lived his last years on his hereditary estate of Luzna. Potocki is known in our time for an epic, *Wojna Chocimska*, on the victory over the Turks at Chocim in 1621, a poem

which received no recognition from his contemporaries and was lost until 1850. It is an epic of much merit, with many satiric contrasts between the heroic simplicity of old times and the luxury of the new. Potocki's contemporary fame rested on *Poczet herbów* (1696), a heraldry in verse; some devotional poems (1690); *Jocialitates* (1747), consisting of witty epigrams; *Syloret* (1764), a tale; and a version of Barclay's *Argenis* (1697).

POTOMAC. One of the most important rivers of the Eastern United States, forming throughout its course the boundary between Maryland on the north and east, and West Virginia and Virginia on the south and west (Map: Maryland, K 8). It rises in two branches, the North Branch in the western Alleghanies on the boundary of Maryland, and the South Branch in the central Alleghanies in western Virginia, the junction of the headstream being 14 miles southeast of Cumberland, Md. Thence the main stream flows in a much winding southeast course till it empties into Chesapeake Bay, 75 miles from the Atlantic Ocean. Its total length is about 400 miles, and its chief tributaries, besides the South Branch, are the Shenandoah from the south and the Monocacy from the north. The scenery along its upper course is remarkably picturesque, especially where it breaks through the Blue Ridge at Harper's Ferry. There are several falls in its passage through the mountains and through the Piedmont Plain below, the Great Falls being about 10 miles above Washington. At that city, 125 miles from its mouth, the river becomes a tidal stream, navigable for large ships, and for the last 100 miles it is a magnificent estuary from two to seven miles wide. The Chesapeake and Ohio Canal follows its course from Georgetown to Cumberland. The whole region through which the river flows is full of historic landmarks. Opposite Washington is Arlington (q.v.), and a short distance below are Alexandria and Mount Vernon.

POTOMAC FORMATION. A name applied to a series of deposits which are chiefly of Lower Cretaceous age, but may be also partly Jurassic. The formation is found along the Atlantic border of the United States from Martha's Vineyard to Georgia, and also up the Mississippi Valley to Tennessee. It consists of a series of sands, gravels, and clays. The latter are worked at many points, notably in New Jersey, and certain members of the series supply iron ore and glass sand. Consult: White, "Correlation Papers, Cretaceous," *Bulletin United States Geological Survey* No. 82 (Washington, 1893). See CRETACEOUS SYSTEM.

POTOMETER (from Gk. ποτόν, *poton*, drink + μέτρον, *metron*, measure). An instrument for observing the rate at which plants evaporate water. The simple form used in physiological laboratories consists essentially of a graduated capillary glass tube (*c* in the figure), to which is connected a transpiring shoot. The tube is filled with water and the lower end dipped into water. As evaporation from the leaf surface proceeds water is drawn up the tube, whose narrow bore accelerates the rate of flow. This may be made evident by lifting the end of the tube for an instant and allowing air to enter. On replacing the tube water again enters, and as the short bubble travels along the tube its rate may be observed and

recorded. By exposing the leaves to varying conditions of light, heat, wind, and moisture in the air the effect of external conditions upon evapora-

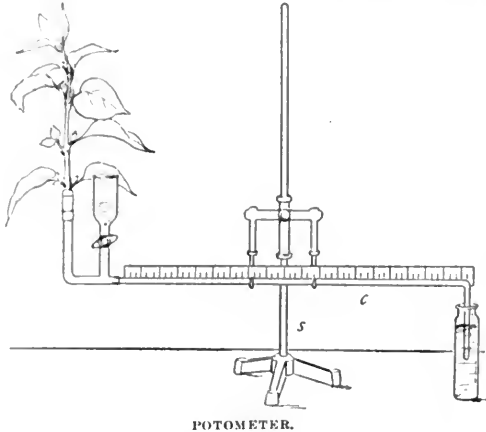

tion may be easily shown. Somewhat complex self-registering instruments have been made. See **TRANSPIRATION.**

POTOO, or **GRAND POTOO**. A name given by the Creoles in the West Indies to one of the large nightjars (*Nyctibius Jamaicensis*), especially common in Jamaica. It represents a small group confined to South America and the Antilles, remarkable for the tooth of the upper mandible.

POTOSÍ, pò'tò-sé'. A southwestern department of Bolivia, bounded by Chile on the west, Chile and Argentina on the south, the Bolivian departments of Tarija and Chuquisaca on the east, and Oruro and Cochabamba on the north (Map: Bolivia, D 8). Its area is estimated at 52,100 square miles. The surface is very mountainous, and at the northwestern end is situated an extensive saline marsh known as the *Grandes Salinas*. The region is drained chiefly by the head-streams of the Pileomayo. Agriculture is only of secondary importance; the chief industry is the exploitation of the silver mines, which are supposed to be the richest in Bolivia. Besides silver there are also found gold, tin, and copper. The population was officially estimated in 1900 at 365,500, the bulk of whom are Indians. Capital, Potosí (q.v.).

POTOSÍ. The capital of the Department of Potosí, in Southwestern Bolivia. It is situated on the Cerro de Potosí at an altitude of 13,325 feet, being probably the highest town in the world (Map: Bolivia, D 7). It lies several hundred feet above what has been considered the highest inhabitable altitude, and, owing to the rarity of the atmosphere, infant mortality is so great that the population can be kept up only by immigration. The city is now only a shadow of its former self. A large part of it lies in ruins, through which passes the now deserted Prado, lined with statues and other evidences of former grandeur. There are several fine and solid buildings, such as the great granite cathedral, and the mint, the latter built in 1562 at a cost of over a million dollars, but no longer used. Potosí owes its origin to the silver lodes which were discovered in the Cerro in 1546, and which for a long time remained the richest silver mines in the world. The total output for the next 300 years

up to 1850 is estimated at \$1,600,000,000, or an average of over \$5,000,000 per year. The city itself grew rapidly, and in the seventeenth and eighteenth centuries was the largest city in the New World, its population being then estimated as high as 170,000. The mines are now almost abandoned, only a few of the 2000 shafts being still worked. The present population is about 16,000. Consult Contzen, *Potosí* (Hamburg, 1893).

POTOTAN, pò-tò'tán. A town of Panay, Philippines, in the Province of Iloilo, situated on the Jalaur River, 16 miles north of Iloilo (Map: Philippine Islands, G 9). It is well laid out, has a large church, and a population of 14,500.

POT-POURRI, pò'pò'r-ré' (Fr., rotten pot). In music, a selection of favorite pieces strung together without much connection, so as to form a sort of medley. Such arrangements generally have very little artistic value.

POTSDAM, pòts'dám. The capital of a district of the same name, a royal residence and the seat of the administration of the Prussian Province of Brandenburg, situated on the Potsdamer Werder, an island in the Havel, 16 miles southwest of Berlin, with which it is connected by three railway lines (Map: Prussia, E 2). The town is celebrated for its beautiful situation amid the numerous lakes of the Havel, as well as for its picturesque environs embellished by luxurious gardens, royal palaces, fountains, statues, etc. The city proper consists of the old town and four suburbs. Of the suburbs the Teltower, on the south, is connected with the old town by a fine stone bridge crossing the intervening *Freundschaftsinsel*. Potsdam is laid out in regular, broad and shaded streets, which form a number of fine squares. The *Wilhelmsplatz* has a statue of Frederick William III., and the *Lustgarten*, opposite the palace, is adorned with a number of statues and busts, including a statue of Frederick William I. The principal churches are the Garrison Church, built in 1731-35, with a high tower, and containing the remains of Frederick the Great and his father in a vault under the chancel; the Church of Saint Nicholas (1830-37), built from designs by Schinkel, with a fine dome; and the *Friedenskirche*, in the style of an early Christian basilica, at the entrance to the Park of Sans Souci.

Of the many secular edifices of note may be mentioned the palace, originally erected in 1670, and rebuilt in 1750, and containing the apartments of Frederick the Great; the town hall (1754), with a gilded figure of Atlas on its gable; the military orphan asylum; the theatre; the barracks, etc. Potsdam has a number of fine gates, of which the Brandenburg Gate, in the west, built in 1770 in the style of a Roman triumphal arch, leads from the city to the Park of Sans Souci (q.v.). The park contains, besides the famous residence of Frederick the Great, the palace of Charlottenhof, with reliefs by Thorwaldsen, and the new palace, at the western end of the park, founded by Frederick the Great and used as a summer residence by Emperor William II.

Potsdam has only few industries. Its chief manufactures are sugar, beer, and optical instruments. The Geodetic Institute is located here. Of the noted places in the vicinity may be mentioned the Russian settlement of Alexandrovka,

north of the city, founded by Frederick William III., in 1826; the Neu-Garten, stretching along the Heilige See, with the Marble Palace on the lake; the Pfingstberg in the north, with a fine Belvedere; the Klein-Glienicke on the left bank of the Havel, with the palace of Prince Frederick Leopold, surrounded by a splendid park; the palace of Babelsberg, with its fine art collections and beautiful fountains; the Brauhausberg, commanding a fine view of the surrounding country; and the Telegraphenberg, with an astro-physical observatory. The population of the city was 59,814 in 1900, chiefly Protestants.

The importance of Potsdam dates from the second half of the seventeenth century, when the Great Elector Frederick William built there a palace and laid out the Lustgarten. It was, however, during the reign of Frederick the Great that Potsdam attained its full development and fame. Consult: *Geschichte der königlichen Residenzstadt Potsdam*, ed. by A. R. (Potsdam, 1883); Sello, *Potsdam und Sans Souci* (Breslau, 1888).

POTS'DAM. A village in Saint Lawrence County, N. Y., 25 miles east of Ogdensburg; on the Raquette River, and on the Rome, Watertown and Ogdensburg branch of the New York Central Railroad (Map: New York, F 1). It is the seat of a State normal school, with a library of 5000 volumes, and of the Thomas S. Clarkson Memorial School of Technology, founded in 1895. Potsdam sandstone (q.v.) is quarried extensively in the vicinity. Other industries are agriculture and lumbering. The principal manufactures include paper, flour, lumber products, farm implements, and machinery, the industrial interests of the village being favored by the excellent water power of the Raquette River. The water works are owned by the municipality. Potsdam was settled in 1803 and incorporated as a town in 1806. The village of Potsdam was incorporated in 1831. Population, in 1890, 3396; in 1900, 3843.

POTSDAM SANDSTONE. The uppermost division of the Cambrian system, so called from the type locality at Potsdam, New York. The rock is a red or yellow sandstone, sometimes altered to quartzite, and of great hardness. It is extensively employed as a building stone. The formation is developed on the borders of the Adirondack Mountains, and in Virginia, Michigan, and Wisconsin. See CAMBRIAN SYSTEM.

POTSTONE (translation of its Latin name, *lapis ollaris*). An impure variety of talc containing chlorite. It is generally greenish-gray to dark green in color, and occurs massive or in granular concretions. Being easily cut when newly mined, it was made into pots and other household utensils by the ancients, the method of making vessels from it being described by Pliny. It was formerly procured in abundance in the island of Siphanto and in Upper Egypt; also on the Lake of Como, Italy, and in Norway, Sweden, and Greenland.

POTT, AUGUST FRIEDRICH (1802-87). A distinguished German philologist, the founder of modern scientific etymology. He was born at Nettelrede, Hanover, November 14, 1802, and was educated in the lyceum at Hanover, studied theology, philology, and natural sciences at Göttingen (1821-25), then was assistant at the gymnasium in Celle until 1827, when he went

to Berlin to become a pupil of Bopp. In 1830 he became privat-docent there, and in 1833 was appointed professor of comparative philology at the University of Halle, which position he occupied until his death, July 5, 1887. The work which established his reputation was the *Etymologische Forschungen auf dem Gebiete der indogermanischen Sprachen* (1833-36), published afterwards in a revised and much enlarged edition under the title *Wurzelwörterbuch der indogermanischen Sprachen* (1859-76). The most important among his other writings include: *De Litvano-Borussiae in Slavicis Letticisque Linguis Principatu* (1837-41); *Die Zigeuner in Europa und Asien* (1844-45); *Die quinäre und vigesimal Zählmethode bei Völkern aller Welttheile* (1847); *Die Personennamen, insbesondere die Familiennamen und ihre Entstehungsarten* (2d ed. 1859); *Die Ungleichheit menschlicher Rassen, hauptsächlich vom sprachwissenschaftlichen Standpunkt* (1856); *Anti-Kaulen, oder mythische Vorstellungen vom Ursprung der Völker und Sprachen* (1863); *Allgemeine Sprachwissenschaft und Carl Abels ägyptische Sprachstudien* (1886). Besides many essays and critical reviews in various periodicals, he contributed important treatises to Ersch and Gruber's *Allgemeine Encyclopädie* and edited Wilhelm von Humboldt's *Ueber die Verschiedenheit des menschlichen Sprachbaues*, with an introductory essay, *Wilhelm von Humboldt und die Sprachwissenschaft* (Berlin, 1876; 2d ed. 1880). Consult: Von der Gabelentz, in *Allgemeine deutsche Biographie*, vol. xxvi. (Leipzig, 1888); and Horn, in *Bezenberger's Beiträge zur Kunde der indogermanischen Sprachen*, vol. xiii. (Göttingen, 1888).

POTT, PERCIVAL (1713-88). An English surgeon. He was born in London, served as assistant surgeon in Saint Bartholomew's Hospital, 1745-49, and as surgeon, 1749-87. He was distinguished for his investigation of angular curvature of the spine, the consequence of disease of the bones of the spinal column, on which account the affection is known as Pott's disease (q.v.). His principal works are: *A Treatise on Ruptures* (1756; 3d ed. 1775); *Fistula Lacrymalis* (1758; 5th ed. 1775); *Observations on Wounds and Contusions of the Head, etc.* (1760); *Practical Remarks on Hydrocele* (1762; 2d ed. 1767); *Remarks on Fistula in Ano* (1765; 4th ed. 1775); *Some Few General Remarks on Fractures and Dislocations* (1769; French ed., Paris, 1788; Ital. ed., Venezia, 1784); *Remarks on That Kind of Palsy of the Lower Limbs Found to Accompany a Curvature of the Spine* (1779).

POTTER, ALONZO (1800-65). A bishop of the Protestant Episcopal Church. He was born at Beekman (now La Grange), Dutchess County, New York, of Quaker parentage, July 6, 1800. In 1818 he graduated at Union College with the highest rank in his class. He served as tutor in his college and in 1821 was appointed professor of mathematics and natural philosophy. At the same time he studied theology, and was ordained in 1824. The same year he married a daughter of President Eliphalet Nott, of Union College. From 1826 to 1831 he was rector of Saint Paul's Church, Boston. In 1832 he returned to Union as professor of philosophy; in 1838 he was made vice-president, and was virtually president until 1845, when he was chosen Bishop of

Pennsylvania. As bishop he showed great administrative ability; many new churches were built in his diocese, and an Episcopal hospital, academy, and theological school were founded and endowed in Philadelphia. He was a friend of the negro and active in work for young men. In consequence of impaired health, he undertook a voyage to California, and died at San Francisco, three days after arriving there, July 14, 1865. During his connection with Union College Bishop Potter wrote several text books and other scientific works of a popular and practical character; he published a volume of *Discourses, Charges, Addresses, and Pastoral Letters* (1858), *Religious Philosophy* (1870), and edited *Lectures on the Evidences of Christianity* (1855). Consult the memoir by Bishop Howe (Philadelphia, 1870).

POTTER, BESSIE. See VONNOIL, ROBERT WILLIAM.

POTTER, CLARKSON NOTT (1825-82). An American politician, son of Bishop Alonzo Potter (q.v.). He was born at Schenectady, N. Y., graduated at Union College in 1842, then spent a year at the Rensselaer Polytechnic Institute, at Troy, and in 1843 removed to Wisconsin, where he became a surveyor. He soon abandoned this work, however, to study law, and in 1848 settled in New York, where he became one of the most prominent members of the bar. In 1869 he was elected to Congress on the Democratic ticket, and both in 1871 and in 1873 was reelected. From 1877 to 1881 he was again a member of Congress. On May 13, 1878, after the Electoral Commission had finished its work, he offered a resolution for the appointment of a select committee "to inquire into the alleged false and fraudulent canvass . . . in . . . Louisiana and Florida." This committee was appointed with him as its chairman, but failed to reach a unanimous decision.

POTTER, ELIPHALET NOTT (1836-1901). An American educator, son of Bishop Alonzo Potter (q.v.). He was born at Schenectady, N. Y., and graduated at Union College in 1861, and at the Berkeley Divinity School a year later. In 1862 he entered the Episcopal ministry and became rector of the Church of the Nativity in South Bethlehem, Pa., an office which he held until 1869. In 1866 he was chosen professor of ethics in Lehigh University, but in 1871 resigned to become president of Union College, and two years later, when the college became a university, he was elected its chancellor. In 1884 he resigned this position to become president of Hobart College, and in 1897 he accepted the presidency of the Cosmopolitan University, by which instruction was given through correspondence. He published *Parochial Sermons; Christian Evidences at the Close of the Nineteenth Century; and Washington a Model in His Library and Life* (1895).

POTTER, HENRY CODMAN (1835-). A bishop of the Protestant Episcopal Church. He was born at Schenectady, New York, May 25, 1835, a son of Bishop Alonzo Potter (q.v.). He was educated at the Episcopal Academy in Philadelphia and the Theological Seminary of Virginia. He was ordained deacon in 1857, priest in 1858, and was successively rector of Christ Church, Greensburg, Pennsylvania (1857), Saint John's Church, Troy, New York (1859), assistant at Trinity Church, Boston (1866), and rector of

Grace Church, New York (1868). In 1883 he was chosen Assistant Bishop of New York and on the death of his uncle, Bishop Horatio Potter (q.v.), in 1887, he became Bishop. He has taken an active part in efforts to promote cordial relations between employers and employed and his ability and public spirit have given him a wide influence which is not bounded by denominational lines. Besides numerous sermons and addresses he has published: *Sisterhoods and Deaconesses at Home and Abroad* (1871); *The Gates of the East: A Winter in Egypt and Syria* (1876); *The East of To-day and To-morrow* (1902); *The Citizen in Relation to the Industrial Situation* (the Dodge lectures before the Yale Law School, 1902).

POTTER, HORATIO (1802-87). A bishop of the Protestant Episcopal Church. He was born at Beekman (now La Grange), Dutchess County, N. Y., February 9, 1802, and was a brother of Alonzo Potter (q.v.). He graduated at Union College in 1826, and was ordained priest in 1828. The same year he was chosen professor of mathematics and natural philosophy in the college which is now known as Trinity at Hartford, Conn. He was rector of Saint Peter's Church, Albany, N. Y. (1833-54). In the latter year he was elected Provisional Bishop of the diocese of New York and in 1861 became Bishop. The diocese prospered greatly under his able administration. He was especially interested in city mission work, and was very successful in promoting the peace and quiet of the Church and abating controversy. Bishop Potter died in New York, January 2, 1887. He published nothing except pastoral letters, addresses, and occasional sermons.

POTTER, PAULUS (1625-54). The principal animal painter and etcher of the old Dutch school. He was born at Enkhuizen, where he was baptized on November 20, 1625. In 1631 his father, Pieter Simonz Potter, a mediocre painter, became a citizen of Amsterdam, and from him Paulus derived his artistic training. He may also have been influenced by his precursor, Aelbert Klomp; but he worked chiefly after nature, as is very evident from his studies, of which four volumes are preserved in the Berlin Museum—the only surviving example of such studies by a Dutch painter of the first rank. In 1646 he became a member of the Painters' Guild of Delft, and in 1649 he settled at The Hague, where he married the daughter of an influential architect. He was already a famous painter, rejoicing in the patronage of Maurice of Nassau, of Princess Amalie, wife of the Stadtholder, and others of the nobility. In 1653, at the solicitation of Burgomaster Tulp, he removed to Amsterdam, where he died January 17, 1654.

Notwithstanding his short life, he produced a large number of pictures—106 according to Westreheene. He rendered the character of animals with great power and truth; his drawing was correct, imparting an almost plastic effect, and his color was delicate. Although he painted with great care and attention to detail, he did not lose the ensemble. His backgrounds—the flat Dutch landscape, sometimes with a few trees—are true in color and perspective. His best known picture is the life-size "Bull" (Hague Museum), of which the chief figure is a wonderful piece of realistic animal characterization; but neither this nor his "Bear Hunt" (Amsterdam, Ryksmuseum)



PAUL POTTER
"THE BULL" FROM THE PAINTING IN THE GALLERY AT THE HAGUE

equals his smaller pieces. The Hermitage at Saint Petersburg possesses 11, including the famous "Cow," refused by the Stadtholder's wife, and the "Judgment of the Animals Over the Hunter;" others are in the museums of The Hague, Amsterdam, Paris, Berlin, Dresden, and especially in English private collections, where the largest number are to be found. Potter was also an etcher of note, simple and direct in his treatment. He left no school, and of his supposed pupils Aelbert Klomp was a precursor, and the two Camphuysens were independent contemporaries. Consult: Van Westreene, *Paulus Potter, sa vie et ses œuvres* (Hague, 1867); Grattel Duplessis, *Eaux-fortes de Paul Potter* (Paris, 1876).

POTTER, ROBERT B. (1829-87). An American soldier, born in Boston. He was a son of Bishop Alonzo Potter and a brother of Bishop Henry C. Potter. He graduated at Union College, and studied law, but in 1861 withdrew from practice in order to enter the Federal Army. He was commissioned lieutenant-colonel of the Fifty-first New York Volunteers, led three companies at Roanoke Island, was wounded at New Berne, fought in the second Bull Run campaign and at South Mountain, and distinguished himself by making a spirited charge at the head of his regiment at Antietam, where he was again wounded. He was made a brigadier-general in 1863, commanded a division in the Knoxville campaign, served with Grant in the Wilderness, and was a third time wounded in the assault made on Petersburg after the explosion of the mine. He was commissioned major-general of volunteers in 1865, and resigned in 1866.

POTTER-BEE. A mason bee of the genus *Osmia* and its allies, which constructs small globular cells of earth and attaches them to the stem of a plant in much the same manner as do the potter-wasps (q.v.) of the family Eumenidæ.

POTTER'S CLAY. A term commonly applied to any fine-grained, plastic clay which can be used in the manufacture of pottery. Clays employed for the making of pottery must have sufficient plasticity, and also burn to the proper body without warping or cracking in the firing process. In order to produce these results it is sometimes necessary to mix two or more kinds of clay together. Potter's clays are found in many localities, and also in many different geological formations; those found in the recent surface deposits are commonly too impure to permit their use for anything except the cheaper grades of ware. The higher grades of pottery are always molded from a mixture of at least three kinds of clay, and in this case the raw material is sometimes freed from gritty particles by a preliminary washing. After mixing it is sometimes stored in damp cellars for a year or more, with the idea that its plasticity will thereby be improved. The value of potter's clay ranges from a few cents per ton for common earthenware clays up to \$10 or \$12 per ton for china clays. In the United States the lower and medium grades of potter's clays are abundant, but the demand for the higher grades is greater than the supply, and therefore large quantities are annually imported from England. The following are analyses of some well-known American potter's clays:

ANALYSES OF POTTER'S CLAYS

	1	2	3	4
Silica.....	45.70	50.26	56.44	45.39
Alumina.....	40.61	19.23	26.50	39.19
Ferric oxide.....	1.39	2.00	.45
Lime.....	.4547	.51
Magnesia.....	.0963	.29
Alkalies.....	2.82	3.46	.83
Water.....	8.98	10.03	7.59	14.01
Moisture.....	.35	.83	2.48
Total.....	100.39	100.35	99.67	100.67

1. Washed kaolin, Webster, N. C.; used in porcelain manufacture. 2. Stoneware clay, Greentown, Ohio. 3. Yellowware clay, East Palestine, Ohio. 4. Florida "ball clay," used in whiteware manufacture.

The following varieties of potter's clay are commonly recognized:

KAOLIN OR CHINA CLAY. A white burning residual clay used in the manufacture of china.

BALL CLAY. A plastic white burning clay used as an ingredient of white earthenware and porcelain bodies, and added on account of its plasticity and bonding power.

EARTHENWARE CLAY. Any plastic clay suitable for common earthenware.

STONEWARE CLAY. A plastic potter's clay which burns to a dense impervious body. The clays employed for this purpose are commonly semi-refractory.

YELLOWWARE CLAY. A semi-refractory clay employed for making yellowware. It is not burned to a vitrified body.

RETORT CLAY. A dense burning fire clay much used in some districts for the manufacture of stoneware.

The production of potter's clay in the United States in 1901 was as follows: Kaolin, \$584,523; ball clay, \$68,907; stoneware clay, \$114,613. The imports in the same year were valued at \$969,777.

BIBLIOGRAPHY. Langenbeck, *The Chemistry of Pottery* (Easton, 1895); Ries, "The Clays of New York, their Properties and Uses," *Bulletin New York State Museum*, No. 35 (Albany, 1900); id., "The Clays of the United States East of the Mississippi," *Professional Papers, United States Geological Survey*, No. 11 (Washington, 1903). See CLAY; KAOLIN; PIPE CLAY; POTTERY.

POTTER'S FIELD. A place for the burial of such as have neither friends nor means to provide burial for them. The name comes from Matthew xxvii. 7. See ACELDAMA.

POTTER-WASP. Any wasp of the family Eumenidæ, the species of which form globular cells of clay or sand which are attached by a



▲ POTTER-WASP AND ITS NEST.

small pedestal to some twig. The shape is frequently very beautiful, and is precisely that of certain greatly admired Indian vessels and

baskets. These cells are filled with caterpillars, sawfly larvae, and the larvae of beetles, by the mother wasp, an egg being laid in each cell and the resulting grub feeding upon the stored insects.

POTTERY (from *pot*, AS. *pott*, *pot*, from Ir. *potá*, *puite*, Welsh *pot*, Bret. *pōd*, *pot*; connected with OIr. *ól*, drink, OPruss. *poūt*, Lat. *potare*, Æolic Gk. *πίνειν*, *pōnein*, Skt. *pā*, to drink). Pottery, in the common use of the term, is any kind of ceramic ware which is not especially designated by a name indicating its peculiar properties. (See BRICK; FAÏENCE; MAJOLICA; PORCELAIN; TERRA-COTTA.) A more proper use of the term would be a general one, covering all kinds of wares which are made of clay or clay-like substances and fixed by firing at a high temperature.

MANUFACTURE. The dough-like condition into which clay can be worked with water and the hardness it may be made to acquire by burning are qualities which have been turned to account by man from the earliest times, and it is upon these that the potter's art essentially depends. If a piece of clay be examined, it will be found that it consists of exceedingly minute particles, held together by aggregation when moist; but if dried it can be easily reduced to an impalpable powder by mere pressure; and if, instead of drying, we add an excess of water, it may be so mixed and held in suspension in the water that it appears almost to be dissolved. In time, however, it is deposited as a sediment, and when the excess of water is removed, it is a soft tenacious paste, which is so non-elastic that it will retain the smallest impression made in it without change. This minute division of its particles and the absence of elasticity are its most valuable qualities. Clay also contains water in chemical combination, and this, once expelled by the process of baking, cannot be replaced. Hence it is that while sun-dried bricks, or adobe, perish in a moist climate, burnt bricks are imperishable. Burnt clay, however finely ground and thoroughly mixed with water, never regains its plasticity. Clays are not of the same purity and quality; the commonest is that of brick fields, which is one of the most abundant substances in nature; but it is so mixed up with iron and other foreign ingredients that, except for bricks, tiles, and the coarsest kinds of pottery, it is not used by advanced peoples.

The purest kinds of potter's clay are called kaolin (q.v.). Pipe clay and potter's clay are more abundant than kaolin. They contain more silica and iron oxide, which gives them their yellow or brown appearance when fired. The general process of preparing clay for the potter's use is described under CLAY. In preparing the finer materials for porcelain, many other operations are required, all having the same object—the extremely minute division of the substances used.

Pottery is grouped into three general classes, according to its color and texture, which in turn depend upon the quality of the clay from which they are made. These are earthenware, stoneware, and porcelain. *Earthenware* includes the coarsest kinds of porous ware, such as flower pots. It is opaque, adheres to the tongue, and can be scratched with a knife. It demands a low temperature in firing, as great heat reduces it to a shapeless mass. If glazed, an opaque or colored glaze is used, or a layer of finer clay is

spread over the surface before the glaze is applied. When an opaque coating formed with tin is applied, the ware is called faience (q.v.) and Delf or Delft ware (q.v.), and when Italian in origin, *mezza-majolica*, and in its finest productions, *majolica* (q.v.). There are other fine forms, having the soft, porous texture of earthenware, but white and covered with a transparent glaze of which the most conspicuous example is Wedgwood's 'Queen's ware.' When the ware is baked much harder and is vitrified throughout, it is called stoneware.

For making vessels of circular form, the potter's wheel was used in all times until the introduction of castings, and is still used very largely. This implement is a revolving horizontal disk on which the lump of clay is 'thrown,' and this lump is shaped by revolution. The disk is revolved by a treadle which the workman operates with his foot, and which is turned through a few degrees of the circle or more rapidly through the whole circle, as conditions require. Into the lump of clay the potter thrusts his thumbs, and by drawing them upward and outward he rapidly reduces the whirling mass to the form of a vessel, the walls of which are drawn up between the fingers and thumbs. The inside is smoothed by pressing a wet sponge against the surface and the outside by a strip of leather, while the vessel is revolving. It is now released from the disk by means of a piece of wire which cuts the clay from the wood, and is then put on a board to dry; when dry, the form may be perfected by turning in a lathe, not unlike the implement used for wood-turning.

The use of 'jiggers' and 'jollies' has greatly increased the rapidity and regularity with which vessels may be shaped. A jigger is a machine carrying a revolving mold in which the clay is shaped by a former which is brought down and held firmly within the mold, the clay having been carefully spread by hand upon the inside surface of the mold. The jigger is used for deep dishes, vases, and the like. The jolly is a similar contrivance used in forming plates and other flat pieces. Jugs and bottles are commonly made in two parts and cemented together before the clay is dry. The clay is usually allowed to dry in the mold, and as the water is drawn off the clay shrinks so that it does not cling to the mold. Such additions as spouts and handles are molded separately and cemented with moist clay before the pieces dry.

Casting is employed in making very fine ware. The plaster-of-Paris mold is filled with liquid clay which is allowed to stand until a thin film is formed around the surface of the mold, after which the rest of the clay is poured out: this process is used for 'egg-shell' porcelain, but also, in rare cases, for fine, hard pottery. The making of these plaster-of-Paris molds is a matter of great delicacy. The model having been designed, a mold is made from it which is divided so that it may be easily removed from the clay. This is called the block mold. From this there is made a cast which is, of course, a replica in plaster of the original model, and from this the working molds are made. After the pieces of pottery have been formed, they are taken to the drying-stove, where they are exposed to a heat of about 85° Fahr. When considered dry, they are placed in great earthen-

ABORIGINAL POTTERY UNITED STATES



FROM A MOUND IN ARKANSAS



FROM A CLIFF DWELLING ARIZONA



ANCIENT PUEBLO TYPES



FROM A RUIN IN ARIZONA



MODERN ZUNI ARIZONA

ware vessels, called seggars, or saggars, which are so shaped that they can be piled one upon another to a great height. The seggars are often made large enough to hold each a number of pieces of the unbaked pottery, and as these would adhere if they touched one another, a number of curiously shaped pieces of baked clay are used, upon which they rest: these are called watches, cock-spurs, triangles, stilts, etc. Thus, each seggar forms a small oven by itself, and by this means the unequal heating of the pieces is prevented, and they are also protected from smoke. A pile of seggars is called a bung, and there may be forty-eight or fifty bungs in the charge of a kiln. When all this is arranged, the furnaces, of which there are several to each kiln, are lighted. The firing requires from twenty-four to fifty hours, after which the ware is allowed to cool very slowly. See KILN.

The articles are now in the state called biscuit, and still require glazing, and perhaps decorative painting and gilding. (For the process of glazing with salt, see STONEWARE; for the glazing of ordinary pottery, see FAÏENCE.) Many mixtures are used, the essential thing being that the glaze and the body shall be of the same general nature in order that they may contract evenly during the firing. The result of uneven shrinking is seen in the cracking of the surface, called 'crazing;' and the crackle of Oriental porcelain and pottery is deliberately produced in the same way. The different glazes are composed of litharge, flint, feldspar, Paris white, and white clay, applied in the form of 'slip.' The glazing materials are triturated with water, with the same care and by similar means to those employed in forming paste, and are reduced with water to the same milk-like liquidity. Each workman has a tub of the glaze before him; and as the articles of biscuit-ware, either with or without decorations, are brought to him, he dips them in the glaze, so as to insure a uniform coating over them; and, by nice management, he prevents any large drops or accumulations on one part more than another. The porous biscuit-ware rapidly absorbs the moisture, and dries up the thin film of glaze on the surface of the articles, which are again placed in seggars, and carried to the glaze-kiln, where they undergo another firing, which melts the glaze, and converts it into a perfectly transparent glass, all over the surface, and renders any pattern previously printed upon it very plain. The temperature in the glaze or enamel kiln is increased very gradually, and is kept up for about fourteen hours, after which it is allowed to cool slowly, and the articles are taken out completed. So far, this description has applied to the manufacture of pottery and porcelain on a large scale, for general purposes; but when it is applied to more costly and artistic works, very special arrangements are required.

Decoration by means of painting may be applied to pottery on the biscuit, or on the unfired enamel, or on the already fired enamel, or glaze, of whatever nature. The method is limited in its scope, but very permanent. The difficulty is to find colors that will stand the great heat required for firing the glaze. Practically the only color used for a hard glazed ware is cobalt blue; but for the softer glazes the oxides of many metals, as copper, iron, and nickel, may be used.

The above applies especially to porcelain. Painting on the unfired enamel is used in some

of the brilliant modern varieties of faïence. Painting upon the glaze, allowing of almost any combination of colors, is the more common practice in ceramic art generally. Painting under glaze requires great skill and experience, for the appearance of the pigments as they are laid by the painter is altogether different from the resulting effect after the firing. The decoration may be applied with a brush or by a transfer of printing. In the latter process the designs are engraved on copper plates; the colors are specially prepared with a printing oil, and the designs printed on a wet tissue paper, which in turn is laid upon the ware and transfers its pattern to the surface of the clay. After the paper has been washed off, the decoration may be touched up with a brush, if necessary.

When it is desired to avoid sharpness of outline in painted or transferred designs, the process called 'flowing' is sometimes used. Sups of more volatile liquid are placed in the seggars, and the vapor of this, partially combining with the metallic colors, softens their outlines. Sometimes the glaze itself is colored, and brilliant and very much admired effects are produced in this way.

In general the term earthenware is used for common pottery, and this carries with it the general idea of a coarser, a softer, and a less carefully made ware than those specified under different names.

PRIMITIVE WARE. In general, primitive pottery is made from surface soil, sometimes of most unpromising appearance, rather than from the finer and purer grades of clay. Naturally the ware produced from such material is coarse and thick-walled. Some of the crudest types of ware are molded in baskets—indeed, archaeologists find good reason for supposing that the earliest pottery was nothing more than an earthen lining for a basket in which corn or other grains were parched by shaking them with live coals until the material was more or less completely baked. Sometimes the frames of wicker or basketry were burnt off in the firing, in such manner as to leave permanent impressions of the framework. This type abounds in mounds and on other prehistoric sites in the Central and Southeastern United States. In the arid regions, not only in the United States and Mexico, but in South America and on other continents, the early ware was improved far beyond this primitive type, in form and finish as well as in material and manufacture. Some of the aboriginal American ware is graceful in form, elaborate in decoration, and perhaps finished with a more or less siliceous slip; though neither the true clays nor the potter's wheel were known to the pre-Columbian natives. Frequently the forms were fantastic, the utensils grading into elaborate symbolic moldings and votive effigies; while the decorations in color were also largely emblematic. (See MAX, SCIENCE OF, paragraph *Esthetology*.) In beauty of form and color effects, as well as in elaborateness and delicacy of the symbolic designs, aboriginal American pottery may be said to have culminated in the Pueblo region in the Southwestern United States and Northern Mexico; some of the pieces from this region (as shown in the accompanying plate) attest a fairly advanced stage in artistic development. The primitive methods of firing are extremely simple. Ordinarily either a single piece or a small lot is fired outdoors in a shallow

pit with the commonest fuel; sometimes smaller draw pieces are used, ostensibly in a ceremonial way (for to the primitive potter the entire process of manufacture is ceremonial rather than merely industrial), yet in such manner as to test the progress of the burning.

HISTORY. The rough red dishes and pots made by peoples of prehistoric time and by tribes of low civilization all over the world are usually of a substance similar to common flower pots even when they are prettily modeled as to form and painted with circles and lines. Similar wares, but much more delicately designed, have been found in great abundance on the eastern shores of the Mediterranean, in Greece, Crete, and Cyprus, as well as on the mainland of Asia. Every explorer in these regions is likely to discover such pieces by the thousand, the sizes of them varying from lamps and toys weighing an ounce or two up to huge vases intended evidently for the storage of grain, oil, wine, etc., which may sometimes contain a hundred gallons. The form is nearly always simple and appropriate and the curves are graceful and prettily combined. The decoration most commonly applied is in black, in bands drawn around the piece, evidently by the process of revolving it while the brush is held steady; but also by means of circles and other curves, parallel lines, checkers, and the like, and the repetition of the fylfot, swastika, and trisul characters. The red wares of the Kaffirs of South Africa or of the Indians on the Amazon do not differ essentially from the Levantine pieces above described, which we generally call Greek or Greco-Phœnician; but they are never as fine either in shape or applied decoration. The black pottery of the ancient Etrurians is also inferior in beauty to the pieces of the Eastern Mediterranean; and the very similar black vessels found in the tombs of ancient Peru are still more grotesque in form, having but seldom any refined beauty.

A step in the development of decorative pottery is taken when for circles and lines are substituted figures of some significance. This step was taken at an unknown early period in Egypt and at least as early as B.C. 2000 in the Asiatic islands bordering upon the Mediterranean. Greek pieces which may be thought to be of the seventh and eighth centuries B.C. are painted with deer, bulls, and beasts of prey, the rude drawings showing accurate observation. A still further advance is in the painting of the surface with black, while the pattern is left in the original red clay, this process involving a very careful working of the black pigment up to a previously drawn outline. In the ruined temples of Cyprus, statues of life size, and even of heroic or colossal size, made of a hard baked pottery, were found, much shattered, but of a certain Asiatic dignity of design. Rough and triling studies of the human figure or of beasts and birds are found in great abundance; and the probability is that this making of figures in representation of living creatures was only checked by the uneven shrinking in the furnace of the not skillfully prepared clay. The utmost refinement of manipulation is necessary in the making of statues and the like.

The most important later development of the pottery of the Mediterranean nations was in the Greek painted vases which attracted so much attention in the eighteenth century under the name of 'Etruscan' vases, this name being given chiefly

because of the finding of these pieces in Tuscany at an early date. It is quite possible to distinguish the real Etruscan-made pieces from those made by the Greeks of the mother country or by those settled in Sicily and South Italy. These Greek vases are generally classified nearly as the earlier and less artistic pieces have been described above, namely, those decorated with black figures on yellow and unglazed pottery, or with black figures on red, or with red figures on black, these two last named divisions being marked also by a certain lustre or glossiness of surface; then a much more elaborate development of these two processes, the vases being adorned by both these decorative processes and also by one or two other colors, such as a kind of purple or lilac, and, not uncommonly, gilding; and finally, vases whose bodies are covered with a white pigment or gesso-like mass upon which the painting has been done in red, black, and other colors, but which are very perishable as to their decoration, the white and the colors upon it flaking off very easily. It is generally accepted as the finest of all epochs, that in which the figures are in red on a lustrous black background made by painting everything except the actual figures and their accompaniments and attributes. These wares are found signed and their date can be ascertained with some accuracy, being fixed as of the fourth or third century B.C.

It is evident that such wares are not decorative in the sense in which a Chinese porcelain vase is decorative. The presence of two or three such in a room does not affect its general aspect very much. The colors are not glowing nor vivid and the piece does not seize the attention; but the beauty of these vases, drinking-cups, and phials is in their subtlety of form and in the suggestion given by their painted figures of extreme skill possessed by the draughtsman, as if he were of a race of artists doing such work as this on cheap clay bowls with only a small part of his strength. As, however, these paintings are the only ones that have come down to us from Grecian antiquity, they are important in an historical sense apart from their individual charm.

Under the Romans a nearly red ware was made, called Samian, from its resemblance to an earlier pottery made, or found, in the island of Samos. This Roman ware is of a fine smooth clay and its decorations are usually in relief: vine leaves and bunches of grapes, medallions, scrolls, ivy-leaf patterns of Greek form, and architectural ornaments like the egg-and-dart moldings. This ware is found all over the Empire and was evidently in very general use; but there is a doubt about the places of its manufacture; nor has the clay been found anywhere in modern times in great abundance. Dr. Birch says, however, that traces of potteries have been found in many parts of Gaul, that is to say, in modern France, and along the Rhine, and that the sites of such potteries are numerous in Auvergne, as also in Spain. It is possible, of course, that the beds of clay were nearly exhausted before the complete disappearance of Roman civilization.

In modern times, even if these are counted as beginning with the fall of classical civilization, there has been very little pottery of artistic interest which is not accurately to be classed under one of the terms referred to above. The most marked exception is that coarse ware adorned by slip (see SLIP), which is especially identified

with English traditions. These pieces are not often good in form and are manufactured very cheaply; the slip, either poured on from a spouted can or applied in some way equally inaccurate, is allowed to form irregular curving and curling lines on the surface, producing an effect extremely informal and even careless, but associated in our minds with an early and simple art which is always attractive as a form of archaism. Much the most artistic pottery of modern times is that mentioned above as coming from Japan; some of this, thought to be brought from the Province of Bangko, is thin and light and of many shades from a very light gray to a brown, but always without any glaze or lustre and without applied ornament other than small detached patches of enamel-color. Other wares are exceedingly like bronze in their color, their surface, their resonance; and the figures of fabulous animals, the incense-burners and the fire-pots (hibatchi) made of this ware are familiarly known as 'earthenware' bronze. In Europe there is a constantly renewed effort to produce attractive pieces for out-of-door use or for other rough service; garden vases are made of heavy brown ware with or without a slight application of plain color to the surface; garden seats and architectural ornaments for the few modern buildings which allow of that kind of decoration are also produced, sometimes under the name of 'terra-cotta,' but more often, especially when glazed, under the name of majolica, which is obviously a misnomer. It is but seldom that delicate forms appear in these pieces.

On the other hand, there are a number of enterprises on foot, in the United States, for the making of especially designed individual pieces. The greater number of these are devoted to the making of glazed, painted, and otherwise more elaborate wares; some even make a real porcelain; but there are a few which produce hard, unvarnished pottery of excellent form and attractive appearance. There are others in which a highly decorative effect is got by the partial glazing of the piece, and still more by the application of different colored glazes which are allowed to trickle down the sides of the vase as if producing a remarkable combination of soft or brilliant colors, the effect of which is comparable to that of a natural mineral. In the production of these effects much is left to chance; but also much is done by the practiced eye and hand and the trained observation which tells to a minute the safest length of time for the exposure to the heat of the kiln. The proportion of successful pieces is large and those which are the most effective in coloring command high prices.

In France the repeated exhibitions of the lovely pieces of the Japanese potters excite a still more marked interest and a more decided attempt at competing in artistic results with the Oriental workmen. At the Exhibition of 1900 there were at least 20 exhibits of unglazed hard pottery whose only applied ornament lay in certain lines or small surfaces of glaze allowed to run down the surface and then checked by the viscosity of the glaze or by the heat of the furnace in the manner of what are called splashed or flambé. These potteries are found to be so highly vitrified by the great heat of the kiln that they approach stoneware in their composition. This points to an insuperable difficulty in the classification of modern wares; it is impossible to draw the line

between one ware and another, because the exact composition of the paste differs so widely between one and another place of production and is so often kept secret.

BIBLIOGRAPHY. A very great number of books have been devoted to the general subject of ceramic art. But none of these can be said to treat merely of the rough wares that are not to be classified as faïence, majolica, porcelain, and the like. The bibliographies given under all the special terms, for which see the first paragraph of the above article, should be examined. In this place there will be named some general treatises and those works especially devoted to ancient potteries, Egyptian, Greek, and the like.

Of general treatises, Jacquemart, *Histoire de la céramique* (Paris, 1873), is an often cited treatise, and the illustrations, which are very numerous, are well drawn and the subjects well selected. The book by Friedrich Jaenicke, *Grundriss der Keramik* (Stuttgart, 1879), is a very thick octavo, crowded with illustrations and fully indexed, with a great number of reproductions of makers' marks. Marryatt, *Pottery and Porcelain* (3d ed., London, 1868), is a general treatise on modern ware, but does not cover all the ground. For ancient pottery, an admirable standard work is *History of Ancient Pottery, Egyptian, Assyrian, Greek, Etruscan, and Roman* (London, 1873), by Samuel Birch. Among the costly books especially devoted to the Greek painted vases are: Bendorf, *Griechische und sizilische Vasenbilder* (Berlin, preface dated 1868); Lau, *Die griechischen Vasen* (Leipzig, 1877); Dumont and Chaplain, *Les céramiques de la Grèce propre* (Paris, 1888 et seq.); and for slighter or more general treatises the hand-books of Collignon, *Histoire de la céramique grecque* (Paris, 1888); and of A. S. Murray, *Hand-book of Greek Archaeology* (London, 1892) for Greece. There are several books containing the bibliography of pottery in connection with the historical texts and there is a *List of the Works on Pottery and Porcelain in the South Kensington Art Library*, by Soden Smith. The *Bibliographie céramique* of Champfleury (Paris, 1881) is very complete for books published before its own date.

POTTIER, πότ'υά', EDMOND (1855—). A French archæologist, born at Saarbrücken, and educated at the Normal College, and (1877-80) at the French school in Athens. Then he assisted Veyries and Reinach in the excavations at Myrina in Asia Minor, and began to specialize in Greek terra-cottas. He taught at Rennes and at Toulouse, for two years (1884-86), had a course in archæology at the Beaux-Arts and in 1886 entered the employ of the Louvre Museum, where he became adjunct curator and assistant instructor of Oriental archæology and antique ceramics. He was elected to the Académie des Inscriptions et Belles-Lettres in 1899. Besides contributions to archæological journals and to the Daremberg and Saglio *Dictionnaire des antiquités*, Pottier wrote various catalogues of the ceramic collections in the Louvre, *La nécropole de Myrina* (1886, with Reinach), *Les statues de terre cuite dans l'antiquité* (1890), and *La peinture industrielle chez les Grecs* (1898).

POTTINGER, Sir HENRY (1789-1856). A British diplomat, administrator, and soldier, born at Mount Pottinger, County Down, Ireland. In 1804 he secured a cadetship in the East India

Company's military service, and five years later was commissioned by its Indian Government to explore the region between their frontier and Persia. The results of this expedition he published in 1816 under the title *Travels in Beloochistan and Sinde*. In 1841, during the Opium War between Great Britain and China, he was sent as ambassador to the latter country; and after the capture of Amoy and several other important towns, concluded a peace in 1842, which opened five of the principal Chinese ports to British merchants. For these services he was appointed the first British Governor of Hong Kong. On his return to England the next year he received the office of Privy Councilor and a pension of £1500. In 1846 he was appointed Governor of the Cape of Good Hope, but less than six months later he was transferred to the Governorship of Madras, which he held until 1854, when he returned to England.

POTTO (African name). A small brownish-gray West African lemur (*Proedicticus potto*) of the lorises group, remarkable for having a distinct though rudimentary tail and distinct index-fingers. Its body is six inches long, and it has the sluggish habits of its relatives. The name has been transported to South America by the negroes and there applied to the *kuikajou*, a small relative of the raccoons.

POTT'S DISEASE, or **SPINAL CARIES**. A tuberculous inflammation of the bodies of the spinal vertebrae, named after Dr. Percival Pott (q.v.), the surgeon who first accurately described the condition and its nature. In this affection as the tubercular tissue replaces the normal bone-tissue of the vertebrae, softening results together with marked deformity of the spine. This deformity is usually seen as an angular projection or hump in the upper part of the back. It is caused from compression or erosion of the softened bodies of the vertebrae, allowing them to be pressed more closely together, which in turn causes their sharp spinous processes to project posteriorly beyond the line of the spines above and below the affected area. The most common period of development of Pott's disease is in childhood and youth, while the body is undergoing rapid growth. The formation of pus is a not infrequent accompaniment of tuberculosis in the spinal region, as in other localities, and this pus often collects itself together into an abscess, spoken of very often as a *cold abscess* (see **ABSCCESS**), from the fact that the inflammatory reaction present is not severe. These abscesses sometimes point in the back adjacent to the vertebrae, and often occupy the posterior mediastinal space (see **CHEST** and **PLEURA**), where they are known as *mediastinal abscesses*. Occasionally the pus in spinal caries burrows downward beneath the muscles of the back and may appear in the lumbar region, constituting a *lumbar abscess*, or following the *psaos* muscle it may pass forward through the pelvis and appear near the attachment of that muscle in the groin; in this case it is known as a *psaos abscess*. When the disease is located in the cervical vertebrae and an abscess forms, it appears frequently in the pharynx. After recovery takes place in tuberculosis of the vertebrae, ankylosis is present in the joints, involved from adhesions between contiguous bony surfaces. In the treatment of

Pott's disease constitutional measures must receive the most thorough consideration. General hygienic measures must be combined with abundance of fresh air, nutritious food, tonics, massage, and as great amount of exercise as the conditions permit. The surgical treatment consists of immobilization of the spinal column by means of frames, the plaster of Paris jacket, the jury-mast, etc. Such measures attain their results by giving rest to the diseased parts, allaying irritation, preventing attrition and crushing of softened bones, and in limiting the amount of deformity after the disease process has become quiescent.

POTTS TOWN. A borough in Montgomery County, Pa., 40 miles northwest of Philadelphia; on the Schuylkill River, and on the Pennsylvania and the Philadelphia and Reading railroads (Map: Pennsylvania, F 3). It has the well-known Hill School, a public high school library, and a public hospital. The centre of a productive farming and dairying country with considerable mineral wealth, Pottstown is an important manufacturing borough, its iron and steel interests being very extensive. There are several large rolling mills, furnaces, nail works, steel mills, bridge works, agricultural implement works, boiler and machine shops, foundries, and manufacturing of bricks, cigars, etc. The various industries, according to the census of 1900, represented an aggregate invested capital of \$4,923,000, and had a production valued at \$8,111,000. Pottstown was laid out in 1752-53 and named Pottsgrove in honor of its founder, a name that was retained until the incorporation of the borough in 1815, when its present name was adopted. In 1888 the limits of the borough were considerably extended. Population, in 1890, 13,285; in 1900, 13,696.

POTTSVILLE. A borough and the county-seat of Schuylkill County, Pa., 35 miles north by west of Reading; on the Schuylkill River, and on the Philadelphia and Reading, the Pennsylvania, the New Jersey Central, and the Lehigh Valley railroads (Map: Pennsylvania, E 3). It is situated in a remarkably picturesque region, which is much frequented by tourists. The county court-house is the most prominent building in the borough, and there are also the county jail and a public hospital. Pottsville is surrounded by the productive anthracite fields of the Schuylkill coal basin, and is an important coal mining and shipping centre. Its mechanical industries, too, have been developed to a considerable extent, having, according to the census of 1900, invested capital to the amount of \$3,383,000, with products valued at \$5,355,000. The more important establishments include the large plant of the Eastern Steel Company; shops of the Pennsylvania and the Philadelphia and Reading railroads; manufactories of plush, velvet, and wood-working machinery; textile and silk mills; etc. The government is vested in a chief burgess, elected triennially, and a borough council which controls elections of a number of the important administrative officers. The treasurer, auditor, and school directors, however, are chosen by popular vote. Pottsville was settled about 1800, was laid out as a town by John Pott in 1816, and in 1828 was incorporated as a borough. It became the county-seat in 1851. Population, in 1890, 14,117; in 1900, 15,710.

POTTSVILLE CONGLOMERATE. The name given to a hard, siliceous conglomerate composed of quartz pebbles and sand and occurring at the base of the lower coal measures. In the central portion of the Pennsylvania anthracite region it has a thickness of 800 to 1700 feet, but is less than 300 to the northward and westward. In New York it is known as the Olean conglomerate. See CARBONIFEROUS SYSTEM; COAL.

POTVIN, pô'vân', CHARLES (1818-1902). A Belgian author, born in Mons. He studied at Liège, entered political journalism as an editor of *La Nation*, and founded *La Belgique Démocratique* (1849) and *Revue de Belgique* (1862). In these influential positions he was a power in Belgian politics and literature, a leader of democrats and free-thinkers. Potvin lectured on the history of literature in the Royal Industrial Museum for some time; was elected to the Belgian Academy in 1881; and in 1883 became curator of the Wiertz Museum in Brussels. He wrote such poems as: *Poésies et amours* (1838); *Le chansonnier belge* (1850); *La Belgique* (1859); on politics: *L'Eglise et la morale* (1858, under the pseudonym *Dom Jacobus*); *La nationalité belge* (1859); on history, *Albert et Isabelle* (1861); *Le Jubilé d'un faux miracle* (1874, under the pseudonym *Dom Liber*); and *De la civilisation en Belgique* (1885); in literary criticism: *Nos premiers siècles littéraires* (1870); *De la corruption littéraire en France* (1873); and *Histoire des lettres en Belgique* (1882); some biographies; and in Old French, *Baudouin de Condé* (1863); *Perceval le Gallois* (1866-72); and *Le Roman de Renard* (in modern French verse, 1860).

POUCHED MOUSE, or POUCHED RAT. Any small rodent with well-developed cheek pouches, especially in America a 'pouched' or 'pocket' gopher (q.v.), or one of the smaller mouse-like animals of the family Saccomyidae. In other parts of the world the term may refer to some true rat, or a hamster, or, in Australia, to a marsupial, especially one of the little mouse-like phalangers of the genus *Dromicia*.

POUDRETTE, pô'drèt' (Fr., small, fine powder). A name apparently first applied to a dry pulverulent manure prepared from the sediment from sewage-settling basins at Montfaucon, near Paris. The term is now applied to any dry mixture of night soil or sewage sludge with absorbent substances, such as charcoal, peat, gypsum, etc. It contains comparatively small amounts of the actual fertilizing constituents, unless, as is sometimes done, it is mixed with more concentrated fertilizing materials, such as dried blood, phosphates, potash salts, etc. Poudrette is prepared and used to a larger extent on the Continent of Europe than in England or the United States. The demand for it has declined since the general introduction of the more concentrated, convenient, and effective commercial fertilizers.

POUGHKEEPSIE, po-kîp'sî. A city and the county-seat of Dutchess County, N. Y., 74 miles north of New York City; on the east bank of the Hudson River, on the New York Central and Hudson River and other railroads, and connected by ferry with the West Shore Railroad, on the opposite side of the river (Map: New York, G 4). A noteworthy cantilever bridge, completed in 1889, spans the

Hudson at this point. (See BRIDGE.) Poughkeepsie is situated partly on a plateau at an elevation of about 200 feet above the river, and partly on the slope to the river. It is well known as the seat of Vassar College (q.v.), whose fine buildings and grounds are some distance east of the city. It has also a number of schools for secondary education, and the Eastman Business College. The Adriance Memorial Library contains more than 24,000 volumes. Besides the Hudson River State Hospital for the Insane, two miles north of Poughkeepsie, there are the Vassar Brothers Institute, Pringle Memorial Home, Saint Barnabas Hospital, and several other institutions. College Hill Park contains 100 acres, and from its highest point commands a fine view of the picturesque surroundings.

The manufacturing interests of Poughkeepsie, according to the census of 1900, represented a capital of \$5,688,000, with products valued at \$6,827,000. Among the important establishments are mowing machine works, foundries and machine shops, a shoe factory, patent medicine factories, slaughtering houses, tobacco, cigar, and cigarette factories, cooperage shops, and lumber mills. The government is administered under a revised charter of 1900, which provides for a mayor elected every two years, and a unicameral council. The majority of administrative officials are appointed by the mayor, whose nomination of members of the board of health, however, are made with the consent of the council. The water-works are owned and operated by the municipality. The Dutch made a settlement about 1698 on the site of Poughkeepsie, which was called by the Indians *Apokeepsing* (safe harbor). During the Revolutionary War (after 1778) it was the State capital, and here in 1788 met the State convention which, under the influence of Alexander Hamilton, ratified the Federal Constitution. The village was incorporated in 1799 and a city charter was granted in 1854. Population, in 1890, 22,206; in 1900, 24,029.

POUGIN, pô'zhân'. ARTHUR (1834-). A French musical and dramatic critic and writer. He was born at Châteauroux (Indre), and studied music at the Paris Conservatory under Alard (violin) and Reber (harmony). In 1855 he became conductor at the Théâtre Beaumarchais, and afterwards leader at Musard's concerts. He was also sub-conductor at the Folies-Nouvelles. From 1860 to 1863 he was first violin at the Opéra Comique. He was in turn *feuilletoniste* to the *Soir*, *Tribune*, *L'Événement*, and *Journal Officiel*, besides being a frequent contributor to *Le Ménestrel*, *La France Musicale*, *L'Art Musical*, *Le Théâtre*, and *Chronique Musicale*. He is a prolific writer, and a sound critic, his biographical sketches being especially sympathetic. His work in connection with Fétis's *Biographie universelle*, for which he prepared a supplement (two volumes 1878-80), has, however, been found to be lacking in thoroughness.

POUILLET, pô'ya', CLAUDE SERVAIS MATTHIAS (1790-1868). A celebrated French physicist, born at Cusance, in the Department of Doubs. He was educated at the Ecole Normale and later was an instructor in this same school. He became professor of physics at the Collège Bourbon, then at the Ecole Polytechnique, and later of the Faculté des Sciences. In 1829 he was

elected sub-director and in 1831 director of the Conservatoire des Arts et Métiers. In 1849 he resigned his various positions and devoted himself to the study of physics. Pouillet is best known as the author of a text-book of physics which was translated into German by J. H. J. Müller, and has passed through many editions; as the inventor of the tangent and sine galvanometers; and for his work on solar radiation, in the course of which he invented a form of pyrheliometer which is still in use. His other work in physics was wide and included such subjects as the measurement of high and low temperatures, measurements of extremely short intervals of time, the latent heat of vapors, etc.

POUILLET, EUGÈNE (1835—). A French lawyer, born in Paris. He was admitted to the bar in 1858, in 1861 was made secretary of the Conférence des Avocats, and subsequently to the lawyer Etienne Blanc, and became known as an authority in patent and copyright law. He appeared in numerous important cases, and published a valuable series of works, including such titles as: *Traité théorique et pratique de la propriété littéraire et artistique* (2d ed. 1894); *Traité théorique et pratique des dessins et marques des fabriques* (3d ed. 1899); and *Traité théorique et pratique des brevets d'invention* (4th ed. 1899). A collection of his verse appeared in 1872, *Poésies nouvelles*, under the pseudonym E. Pevénil.

POUJOULAT, ΠΩΨΖΗΘΩΨΛΑΨ, JEAN JOSEPH FRANÇOIS (1800-80). A French historian, born at La Fare (Bouches du Rhône). He went to Paris in 1826, assisted Michaud in his *Bibliothèque des croisades*, and traveled with him in the East. In the Constituent Assembly of 1848 and the Legislative Assembly of 1849 he was a member of the Right. His extreme royalism made him hostile alike to Louis Philippe and to Napoleon III., after whose coup d'état in 1851 Poujoulat retired from public life. He wrote: *Correspondance d'Orient* (1833-35, with Michaud); *Histoire de Jérusalem* (1840-42; 5th ed. 1865); *Histoire de la révolution française* (1848; 6th ed. 1877); *Souvenirs d'histoire et de littérature* (1868 and 1886); and *La Bédouine* (1835), a novel crowned by the Academy.

POULPE. A French name for an octopus, specifically the common species of the Mediterranean (*Octopus vulgaris*). The term has passed into literature with a rather indefinite application to any cuttlefish, and sometimes even to polyps—a totally different sort of animal. The most conspicuous case of its use and misuse was by Victor Hugo in *The Toilers of the Sea*, where an animal is described under this name which combines characteristics and habits so totally diverse as to make the whole story zoölogical nonsense.

POULTICE (from Lat. *puls*, Gk. *πόλος*, *polos*, porridge), or CATAPLASM. A soft mass composed of substances such as slippery elm bark, meal, flaxseed, bread, herbs, or mustard, for application to the surface of the body. The mass is mixed with hot water and spread to the thickness of about half an inch upon linen, cheesecloth, or even paper. Poultrices may be employed for their heat alone or as vehicles for some therapeutic agent. In the early stages of an inflammation a poultice will assist nature in softening and absorbing inflammatory products, and when

the inflammatory process has advanced they will hasten pus formation. Poultrices of green soap are often employed before surgical operations to soften and sterilize the skin. Cold poultrices, as those of cotton, steeped in water, are sometimes applied to prevent inflammation and mitigate pain.

POULTON, EDWARD BAGNALL (1856—). An English scientist, born at Reading. He was educated at Jesus College, Oxford, in 1877-79 was demonstrator under Professor Rolleston in the anatomical department of the University Museum, and from 1880 to 1889 was lecturer in natural science and tutor in Keble College. He was also lecturer in natural science in Jesus College from 1880 to 1888. In 1893 he became Hope professor of zoölogy at Oxford. He was elected fellow of the Royal Society in 1889, was a member of its council in 1897-99, and in 1898 became a fellow of Jesus College. In 1894 he delivered at Boston, Mass., a course of Lowell lectures on "The Meaning and Use of the Colors of Animals." He contributed valuable papers to the *Proceedings* of the Royal Society and of the Zoölogical Society, to the *Quarterly Journal* of the Geological Society and of the Microscopical Society, and the *Transactions* of the Entomological Society and the Linnæan Society. Among his published volumes are *The Colors of Animals* (1890; in the "International Scientific Series") and *Charles Darwin and the Theory of Natural Selection* (1896).

POULTRY (OF. *pouleterie*, from *poulet*, *poulette*, *polette*, Fr. *poulette*, pullet, fowl, diminutive of *poule*, from ML. *pulla*, hen, fem. of Lat. *pullus*, young animal, chicken; connected with Gk. *πῶλος*, *pōlos*, Goth. *fula*, OHG. *folo*, Ger. *Fohlen*, AS. *folu*, Eng. *foal*). A collective name for useful domestic birds. It is sometimes limited to the domesticated gallinaceous birds—chickens, peafowl, guinea-fowl, turkey, guan, and pigeon—but its ordinary use includes ducks, geese, swans, and all other birds reared for economical purposes. Under the influence of domestication the group has exhibited a great capacity for variation in externals, as color, combs, etc., and especially in size, as appears when the diminutive bantams are compared with great shanghais, and to this capacity for adaptation the usefulness of fowls is largely due. See GALLINÆ; FOWL; and the names of the various birds, as DUCK, TURKEY, etc.

POUND. See WEIGHTS AND MEASURES.

POUND (variant of *pond*, from AS. *ge-pyn-dan*, to shut up, impound). An inclosure for the temporary confinement of stray animals. Where domestic animals stray upon the public highways, or upon the land of individuals, any person injured thereby may take possession of and 'impound' them, that is detain them in a pound until the owner pays him for any damage they may have caused. A pound may be one established by law, known as a public or common pound; or where there is no public pound, a person on whose land cattle or other domestic beasts stray may confine them in an inclosure on his own land, with the intention of thereby impounding them. In the latter case, the person so confining the animals is responsible for them. To obtain a release of the beasts the owner must pay him for their keep, as well as for the damage they have done.

DOMESTIC FOWLS



- 1 DORKING HEN
- 2 SILVER SPANGLED HAMBURG COCK AND HEN
- 3 BLACK MITHORCA COCK
- 4 WHITE WYANDOTTE HEN
- 5 BARRED PLYMOUTH HEN
- 6 WHITE CRESTED BLACK POLISH HEN
- 7 PARTRIDGE COCHIN COCK
- 8 RED GAME COCK

Where cattle are taken to a public pound the person taking them should leave with the poundkeeper a certificate, containing a brief statement of the cause of impounding, and the amount of damages he claims. The poundkeeper then becomes responsible for the keep of the animals. The compensation of the poundkeeper is usually derived from fees, which must be paid by the owner before the poundkeeper is obliged to release them. In most States, either the poundkeeper or the person impounding the animals must give notice to their owner if he can be ascertained and found. If the owner does not redeem his animals within a time fixed by statute, or, in absence of such provision, within a reasonable time, after notice, the poundkeeper may advertise and sell the beasts, satisfy all charges against them, and hold the balance to the credit of the owner. Consult Ingham, *Law of Animals* (1898).

POURBUS, pōōr'bus. A family of Flemish painters.—**PIETER THE ELDER** (c.1463-?) was born at Gouda. Three portraits, supposed to be by him, are in the Vienna Gallery.—**PIETER THE YOUNGER** (c.1510-84) was born at Gouda, settled at Bruges, and became a member of the Guild of Saint Luke in 1543. He painted religious subjects and portraits. In the Academy and churches of Bruges there are a number of good works by him.—**FRANS THE ELDER** (c.1540-c.1581) was born in Bruges. He was the son and pupil of Pieter the Younger, and of Frans Floris. He lived principally in Antwerp. His portraits are notable for their fine, mellow color. There are also religious pictures by him in the Ghent Cathedral, the Ghent Museum, the Antwerp Academy and elsewhere.—**FRANS THE YOUNGER** (c.1570-1622) was born in Antwerp. He was the pupil of his father, Frans the Elder. He became Court painter to the Duke of Mantua in about 1600, and afterwards worked at the Court of France, and died in Paris. There are portraits of Henry IV. of France and of Maria de' Medici in the Louvre, Paris, by him; a portrait of Catharine de' Medici (in the Madrid Museum), "Henry IV. Lying in State" (Berlin Museum), portrait groups (Hermitage Museum, Saint Petersburg), and a portrait of himself (in the Uffizi, Florence). He also painted historical pictures. By some critics he is considered a better colorist than his father.

POURCEAUGNAC, pōōr'sō'nyāk', MONSIEUR DE. A bright prose comedy ballet by Molière, in three acts (1669), containing the author's attacks on the medical profession. The hero is a young man of Limoges who goes to Paris in search of a wife and is involved in many trying situations through the plots of the suitor of his lady love. The play is said to have been written in retaliation for Molière's treatment at the hands of the inhabitants of Limoges.

POUR LE MÉRITE, pōōr le mā'rēt' (Fr., for merit). A Prussian order conferred for military and civil distinction. It originated in the Order of Generosity, founded in 1667, and in 1740 was reorganized by Frederick II. into an order of merit. In 1810 it was expressly made a reward for distinction in battle. The decoration is a blue cross of eight points, the arms separated by golden eagles, and bearing the inscription, "Pour le mérite." A civil class was established in 1842 for distinction in battle. The decoration is a

blue band with the name of the order, inclosing a central gold medallion with the Prussian eagle. See Plate of ORDERS.

POURPOINT, pōōr'point, *Fr. pron.* pōōr'-pwān' (OF., *Fr. pourpoint*, from ML. *perpunctum*, quilted garment, from Lat. *perpungere*, to pierce through, from *per*, through + *pungere*, to pierce). A doublet made of quilted cloth, worn for defense both by soldiers and civilians in the fourteenth, fifteenth, and sixteenth centuries. See GAMBESON.

POURTALES, pōōr'tā'lēs', LOUIS FRANÇOIS DE (1824-80). An American naturalist, born at Neuchâtel, Switzerland. He was a pupil of Agassiz, whom he accompanied in 1840 on glacial expeditions in the Alps and in 1847 to America, where in 1848 he entered the United States Coast Survey. In 1851 he assisted in the triangulation of the Florida reef, and from 1854 until his resignation in 1873 was in special charge of the office and field work of the tidal department of the survey. In 1873 he became custodian of the Harvard Museum of Comparative Zoölogy, in which he had previously been assistant in zoölogy. He was the first in the United States to undertake deep-sea dredging, and was an authority on marine zoölogy. The name Pourtalesia was given to a variety of sea-urchin. Pourtales presented his extensive collections to the museum. He was a member of the National Academy of Sciences, and wrote various contributions to the Coast Survey reports, to Silliman's *Journal*, and to the *Proceedings* of the American Association for the Advancement of Science. He published, under the auspices of the museum, several works, including: *Contributions to the Fauna of the Gulf Stream at Great Depths* (1867-68); *Deep-Sea Corals* (1871); *Corals and Crinoids* (1878); and *Report on the Corals and Antipatharia* (1880).

POUSSIN, pōōs'sān', GASPARD (1613-75). An Italian landscape painter, the son of a Frenchman, settled in Rome. He was the pupil of Nicolas Poussin, who had married his sister, and from respect to that great artist adopted his name in place of his own, which was Dughet. He was called by the Italians Gasparo Duché, and he inscribed his etchings, eight in number, in that way. He never left Italy, and lived chiefly in Rome, where he died May 27, 1675. His landscapes are composed in general from studies in the Campagna of Rome and the surrounding country, worked out with the feeling of a mind deeply imbued with classical associations, and tending toward melancholy reflection, by contrasting the glory of the past with the decadence of the present. He excelled in the portrayal of the wind and the storm, the sombre effects of his paintings being increased by the influence of time in darkening the colors. His first period was marked by a certain constraint, but under the influence of Claude Lorraine his style became warmer, and he acquired mastery over light and air. He was a very facile painter; nearly all European galleries possess examples of his works, which are especially numerous in the public and private collections of Rome, Vienna, and London. His most ambitious undertakings were in Rome: the series of frescoes of the Life of Elias, in the Church of San Martina; the cycle of 12 tempera landscapes in the Colonna Palace; and

another of 25 large landscapes in oil in the Doria Pamfili Palace.

POUSSIN, NICOLAS (c.1594-1665). A French painter, the originator of the classic and academic element in French painting. He was born at Villers, near Les Andelys (Normandy), probably the son of a gentleman of Picardy, who had fought under Henry IV. Placed with a Latin master, he preferred design, and having studied, against the wishes of his parents, at Les Andelys under Quentin Varin, he went to Paris. There, under great privations, he worked with Ferdinand Elle and Georges Lallemand. His association with the mathematician Courtois, whose collection of engravings he studied, filled his mind with the fixed determination to reach Rome. After two vain attempts he succeeded, through the aid of an Italian friend, Marini, arriving in Rome in the spring of 1624. Together with the Flemish sculptor Duquesnay, who had been his friend in Paris, and with Allgardi, afterwards one of the greatest Baroque sculptors, Poussin studied antique statues. He also dissected with the surgeon Larchi, sketched after Raphael and Giulio Romano, and made a thorough study of landscape in wanderings about the Campagna. A great admirer of Domenichino, he was admitted to that master's studio and was much influenced by him in composition.

He was at first unsuccessful in Rome, and during a serious illness was taken care of by a countryman, Dughet, whose daughter he married. But through the pictures executed under the patronage of Cardinal Barberini, he became famous, winning in especial the favor of Richelieu, who was the means, after two years of persuasion, of inducing him in 1640 to return to Paris. He was received with high honor, made first painter to the King, and allotted an income of 3000 livres a year. Besides a number of other paintings he produced eight cartoons for the Gobelins and the designs for a scheme of decoration, representing the "Labors of Heracles," for the Louvre. But, ever homesick for Rome, and disgusted with the intrigues of Vouet and others, he returned in September, 1642, passed the remainder of his life there in quiet, unremitting activity, and died November 19, 1665.

Although Poussin learned his art and passed the best part of his life in Italy, he may properly be classed with the French school, into which he introduced the classical element, which even now forms one of its chief characteristics. He exercised the greatest influence upon the French painters who studied at Rome—Claude Lorrain, Lebrun, Mignard, Bourdon, etc. His art may be divided into two periods, the dividing point of which is his sojourn in France in 1640-42. His early manner is more brilliant and facile, and better in color; afterwards his art is more dominated by ideas and rigid in execution. His composition is symmetrical, though not always free; his drawing correct; his coloring has suffered much from the dissipation of surface pigments. In his figure compositions he renders the feeling of the antique as had no man before him, besides which he was, more than any one else, the creator of the classic or heroic landscape, afterwards developed by Claude Lorrain.

Nearly all of the galleries of Europe possess examples of Poussin's works. The Louvre is

richest with 39, among the best known of which are the "Triumph of Flora" (1630); "Philistines Stricken by the Pestilence;" "Eleazar and Rebecca;" two "Bacchanals;" the "Last Supper;" "Orpheus and Eurydice;" "The Shepherds of Arcady," celebrated for its curious inscription *Et in Arcadia ego*, and his own portrait. In the Vatican is his "Martyrdom of Saint Erasmus;" in the Barberini Palace (Rome) the "Death of Germanicus." Other examples are in the galleries of Hampton Court, Berlin, Munich, Dresden, Vienna, the Uffizi (Florence), Madrid (21), and in the private collections of England. His works were engraved by the most celebrated engravers of the day, including Audran, Pesne, and Stella. Consult: Poussin's *Letters* (Paris, 1824); his *Œuvres complètes* (ib., 1845); and his *Life* by Gault de Saint Germain (Paris, 1806); Graham (London, 1820); Genée (Paris, 1823); Bouchitté (ib., 1858); Gandon (ib., 1860); and Poillon (Lille, 1875).

POUT, or HORNED POUT. See **BULLHEAD.**

POUTER PIGEON. A breed of domestic pigeons capable of pulling out the throat and chest enormously by inflating the crop, which it does frequently. See **PIGEON**; and **Colored Plate of PIGEONS.**

POUTRINCOURT, pō'utrān'kōōr', **JEAN DE BIENCOURT** (1557-1615). A French colonizer. He went to Canada in 1603, under the leadership of De Monts, and in 1604 was given a grant of Port Royal. He busied himself principally, however, in trading with the Indians, and his colony suffered in consequence. In 1606 he fortified Port Royal and joined Champlain on an exploring expedition as far as Point Fortune, now the town of Chatham, in the Province of Ontario. His opposition to the Jesuits prevented him from carrying out the French King's wishes in regard to missionary work among the Indians. He returned to France in 1612, sailed again for Acadia after its desertion by the English in 1614, but did nothing for his Port Royal colony, and finally returned to France the same year.

PÓVOA DE VARZIM, pō'vwā dā vār-zēn'. A town of Portugal, in the Province of Entre-Minho-e-Douro, situated on the Atlantic Ocean, 18 miles north of Oporto (Map: Portugal, A 2). It is a bright and lively town and a favorite bathing resort for the people of Northern Portugal and Spain. Its permanent population, consisting chiefly of fishermen, numbered in 1900 12,623.

POWDER. See **EXPLOSIVES**; **GUNPOWDER.**

POWDERLY, TERENCE VINCENT (1849—). An American labor leader, born at Carbondale, Lackawanna County, Pa. He received a common-school education, in 1862 became a switchman for the Delaware and Hudson Railway, in 1864 a car-repairer, and in 1866 an apprentice to the machinist trade in the shops of the company. In 1869 he entered the employ of the Delaware, Lackawanna and Western Railway at Scranton, Pa. He became president of the Machinists' and Blacksmiths' National Union, held several offices in the local and district assemblies of the Knights of Labor (q.v.), and in 1879 was elected General Master Workman of the latter organization. He reorganized the order and greatly furthered its interests, but in 1893 resigned owing to internal differences arising from opposition to his

policy. In 1878, 1880, and 1882 he was elected Mayor of Scranton as candidate of the Labor Greenback Party, and in 1891 Republican delegate-at-large to the projected State constitutional convention. He studied law in 1893-94, was admitted to the bar of Lackawanna County, Pa., in 1894, and to that of the United States Supreme Court in 1901. From 1897 until his resignation in 1902 he was United States Commissioner-General of Immigration. During the Presidential campaigns of 1896 and 1900 he appeared as a Republican stump speaker in the West and South. He assisted in establishing the *Labor Advocate* at Scranton in 1877, regularly contributed to the *Journal of United Labor*, and wrote on economic subjects for various periodicals of the United States and Canada. He was also known as a lecturer, and published *Thirty Years of Labor: 1859-89* (1889-90); *The Labor Movement: The Problem of To-Day* (1890, with James and others); and *Trusts* (1892, with Dodd).

POWELL, pou'el, BADEN (1796-1860). An English mathematician and divine, born at Stamford Hill. He was educated at Oriel College, Oxford, and graduated in 1817 with highest honors in mathematics. He was ordained in 1820 and appointed vicar at Plumstead, in Kent, 1821, but still devoted his leisure time to mathematics. In 1824 he was elected a fellow of the Royal Society, and in 1827 Savilian professor of geometry at Oxford, which he held till his death. He was also involved in theological controversies and wrote some works on this subject. Among his works may be mentioned: *A Short Elementary Treatise on Experimental and Mathematical Optics* (1833); *Revelation and Science* (1833); *A Historical View of the Progress of the Physical and Mathematical Sciences* (1834); *The Connection of Natural and Divine Truth* (1838); *A General and Elementary View of the Undulatory Theory as Applied to the Dispersion of Light* (1841); *Essays on the Spirit of the Inductive Philosophy* (1855); *Christianity Without Judaism* (1857); *The Order of Nature Considered with Reference to the Claims of Revelation* (1859); *On the Study and Evidences of Christianity* (1860).

POWELL, FREDERICK YORK (1850—). An English historian and Icelandic scholar. He studied at Rugby and at Christ Church, where he was law lecturer, tutor, and student, later becoming fellow of Oriel and delegate of the Clarendon Press. But he is better known as an author and a contributor to the *Encyclopædia Britannica* and the *English Historical Review*. With Vigfusson he edited and translated the *Corpus Poeticum Boreale* (1883), *Islandica Antiqua*, and an Icelandic Reader. Alone, Powell wrote *Early England Up to the Norman Conquest*, *Alfred the Great and William the Conqueror*, and *Old Stories from English History* (1894), as well as syllabi for the study of Dante and Shakespeare, and an essay on the sources of *Saxo Grammaticus* in Elton's translation of that work.

POWELL, JOHN WESLEY (1834-1902). An American geologist and anthropologist, born at Mount Morris, N. Y. His parents came to the United States from England a short time before his birth, and his early childhood was passed in

Ohio, Wisconsin, and Illinois. He studied for a while in the Illinois College, at Jacksonville, later at Wheaton, Ill., and still later at Oberlin College, Ohio. When the Civil War broke out he at once enlisted as a private in the Union Army; after short service he rose to the rank of major, and was subsequently offered the commission of colonel, but declined. While serving as major at the battle of Shiloh he lost his right arm. With the close of the war he accepted a position as professor of geology in the Illinois Wesleyan University, at Bloomington, later resigning this to take a similar position in the Illinois Normal University. In 1867 Major Powell visited the Rocky Mountains of Colorado for exploration and research. The following year he organized a party of mountaineers and explored a portion of the Colorado River region, finally going into winter quarters on the White River. On May 24, 1869, the party of ten started on their voyage through the cañon, which lasted over three months and was fraught with great dangers and hardships. The result of this daring voyage brought Major Powell into prominence before the scientific world, and from that time until his death he was an active and conspicuous personage among American scientists. In 1869 he induced Congress to establish a geological and topographical survey of the Colorado River and its tributaries, an undertaking which consumed the following ten years. The establishment between 1865 and 1875 of many surveys of the Western country, which acted independently and often in competition with each other, led Major Powell to attempt a satisfactory adjustment of these surveys under some combined system of operation. As a result of this, Congress in March, 1879, discontinued the separate surveys and established the United States Geological and Geographical Survey, which had Clarence King as its first director. During Major Powell's Western work he gathered much valuable ethnological and anthropological material among the American Indians for the Smithsonian Institution, and in 1876 this appeared in a volume entitled *Contributions to North American Ethnology*. On the retirement of Mr. King from the directorship of the Geological Survey in 1881, Major Powell was appointed his successor. In 1894 he resigned this office to devote himself to the directorship of the Bureau of Anthropology, and to ethnological and philosophical studies. He died at Haven, Me., September 23, 1902.

Major Powell was a member of most of the important scientific societies of the United States, and served as president of the Anthropological Society of Washington and of the American Association for the Advancement of Science. He was the recipient of many honors from foreign societies, among which was the Cuvier prize, awarded to him and his associates on the Survey in 1891. His important contributions to scientific literature include the following: *Exploration of the Colorado River of the West and Its Tributaries* (1875); *Report on the Geology of the Uinta Mountains* (1876); *Report on the Arid Region of the United States* (1879); *Introduction to the Study of Indian Languages* (1880); *Studies in Sociology* (1887); *Canyons of the Colorado* (1893); and *Physiographic Processes, Physiographic Features, and Physiographic Regions of the United States* (1895).

POWELL, MAUD (1868—). An American violinist, born in Peru, Ill. She studied music (1881-85) in Leipzig, Paris, and Berlin, where she was a pupil of Joachim. She was soloist with the orchestras of Thomas, Seidl, Nikisch, and Damrosch, accompanied the New York Arion Club on its European tour in 1892, and played in England and on the Continent in 1898-99. Her playing was marked by intelligent interpretation, an unusual purity of tone, and adequate technique.

POWER (OF. *pouvoir*, *pouvoir*, *poer*, Fr. *pouvoir*, It. *potere*, power, from ML. *potere*, for Lat. *posse*, to be able). In the English and American law of real property, an authority vested in one or more persons enabling them to make valid conveyances of land, irrespective of their having any interest therein themselves. Such a power may be created by any instrument capable of transferring real estate, but it is most frequently conferred by will. It may be *general*, authorizing the person in whom the power is vested (known as the *donee* of the power) to convey to any person whatsoever, including himself, or *special*, where the exercise of the power is restricted to certain persons or classes of persons. The latter is its more usual form.

The will of the person creating the power (known as the *donor*) must be strictly observed, not only as to the persons in whose favor it may be exercised, but also as to the time and mode of its execution, whether during the lifetime of the donee, by deed, or at his death, by last will and testament. The power when duly executed is operative to divest the estate of the person by whom the land is then held and to vest it in one or more others according to its terms. But the deed or will by which this result is produced is regarded not as that of the donee executing the power, but as that of the donor by whom it was created, and it derives its efficacy from the instrument by which the power was created. Its operation, therefore, is to invalidate (or, more properly, to 'revoke') the previously existing title and to substitute the title of the new 'appointee' in its stead. Accordingly, where, as in the ordinary case, the real property is vested in one person and the power of appointment, as it is more fully described, in another, the legal title of the former is held in strict subordination to the power held by the latter, and the due execution of the power will invalidate any conveyance or incumbrance of the property by such owner.

Powers are described as owing their efficacy to the Statute of Uses, which had the effect of transforming into legal estates the equitable interests in land, which, under the former practice of conveying property to one person to the use of another, might have been created by parol appointment. Thus the owner of land might give to another the use thereof, reserving to himself or giving to another the right or power of revoking such use or trust and appointing another in lieu thereof. It will be seen that it needed only the touch of the statute, converting these uses into legal estates, to put into effect the elaborate system of powers above described. This system forms an important and intricate chapter in the law of real property. It has, however, been greatly modified by statute in many of the United States. See Sugden, on *Powers*;

Leake, *Law of Property in Land*; Tiffany, on *Real Property*; Williams, *Real Property*.

POWER (in physics). The work done by a machine or any agency in a unit of time. In the C. G. S. system the unit of power is one erg per second. Other units are, however, in practical use. Such are the 'watt,' or 10⁷ ergs per second, and the 'horse-power,' or 33,000 foot-pounds per minute (this equals 746 watts approximately).

POWER (in mathematics). See EXPONENT.

POWER, TRANSMISSION OF. The processes and methods of transmitting the power generated by prime motors to the machines and mechanisms operated in performing useful functions is one of the most important problems of modern engineering. In practically all cases the power generated by a prime motor (steam-engine, water-wheel, or windmill) has to be transmitted through an appreciable distance to be applied to the machine which utilizes it in performing work. The means by which this is accomplished are various and may be classed as gears or gearing, belts and ropes, compressed air, hydraulic pressure, and electricity.

GEARING is one of the oldest and most extensively used methods of power transmission for short distances. If two cylinders with parallel axes are pressed together and one of them is rotated on its axis, it will drive the other by means of the friction between the surfaces. If actual teeth are formed upon the two cylinders, we have a pair of gear wheels which drive each other by pressure upon the faces of the teeth if the teeth are properly shaped. If the driving gear and the driven gear are of equal diameter, they have the same speed of rotation; if the driven wheel is smaller than the driving gear, it rotates faster, and if it is larger it rotates slower. Intermediate gear wheels are commonly introduced between the driving gear wheel and the driven gear wheel, which may be of the same or different diameters. By the suitable arrangement of gear wheels and proper variations of their relative size and form, the motor shaft speed may be either increased or diminished and the direction of rotation may be changed to any angle with the driving shaft. See illustration of typical gear wheels, in article **GEARING**.

BELTS. Next to gear wheels the most familiar means of power transmission are *belts*. (See **BELT**.) If two cylinders mounted on parallel shafts are set so far away from each other that their surfaces do not touch, one may be driven from the other by encircling both with an endless flat belt of flexible material. The driving power from the motor shaft is transmitted to the driven shaft by means of the friction between the surface of the belt and that of the two pulleys. Change of speed is accomplished by increasing or decreasing the diameter of the driven pulley as compared with the driving pulley. Change in the direction of rotation is accomplished by twisting the belt; thus a horizontal or an oblique pulley can be driven from a vertical pulley. Belt transmission is particularly an American development and is more extensively used in this country than elsewhere. In English practice for many years gearing was preferred to belts, and at present rope drivers are used in England in preference to belts. Rope transmission is similar to belt transmission in principle and operation, but in place of flat belts, embracing smooth-faced pulleys, one or

more parallel endless ropes are used, embracing groove-faced pulleys. Rope transmission, like belt transmission and transmission by gearing, involves the use of shafting as a part of the transmission system. See **SHAFTING**.

The dynamic or wire rope transmission is a special development of rope transmission, whose most familiar example is perhaps the cable railway. The dynamic transmission is especially suited to distances up to about one mile. Water under high pressure (700 to 2000 pounds per square inch and upward) affords a very satisfactory method of transmitting power to a distance, especially for the movement of heavy loads at small velocities, as by cranes and elevators. The system usually consists of one or more pumps capable of developing the required pressure (see **PUMPS AND PUMPING MACHINERY**); one or more accumulators by which a quantity of water may be accumulated at the required pressure (see **ACCUMULATORS**); the distributing pipes, and the presses, cranes, or other machinery operated. (See **HYDRAULIC PRESS**; **CRANE**; **HYDRAULIC ENGINE**.) Systems of hydraulic transmission for general industrial purposes exist in London, Liverpool, Hull, Birmingham, and Manchester, England; in Antwerp, in Holland; in Zurich, and in Geneva, Switzerland; and in many other places.

Air under pressure is one of the most extensively employed means of power transmission at present practiced. Some of the great variety of uses to which compressed air is put at present are listed in the article on **AIR COMPRESSORS**. The system for compressed air transmission usually consists of an air compressor plant, including receivers, for compressing air and storing it under compression (see **AIR COMPRESSORS**), the pipes for conveying and distributing the compressed air, and the drills, hoists, and other motors operated. (See **DRILLS**; **PNEUMATIC TOOLS**; **HAMMERS**; **AIR BRAKES**; **COMPRESSED AIR**; **LOCOMOTIVES**; **PNEUMATIC DISPATCH**.) The longest distance to which air has ever been transmitted in America is three miles, at the Chapin mine, Iron Mountain, Michigan.

The most modern and in some respects the most important means of power transmission is electricity, which is now used for lighting, street railway, and general purposes, in constantly increasing amounts. The system for electric power transmission consists of the generating plant of engines and dynamos (see **DYNAMO-ELECTRIC MACHINERY**), the transmission line wires, cables or bars, and the motors operated. (See **ELECTRIC RAILWAYS**; **ELECTRIC LIGHTING**; **STORAGE BATTERIES**; **TRANSFORMERS**.) One of the earliest attempts at long distance electric transmission was made between Munich and Meisbach, Germany, in 1882. The distance was 32 miles. In 1886 power was transmitted between Creil and Paris, France, 36 miles, and in 1891, on the occasion of the electric exhibition at Frankfort, Germany, power was transmitted from Tauffen to Frankfort, 109 miles. The longest transmission line in America is from Redlands to Los Angeles, Cal., 80 miles. There is also a 24-mile line from Folsom to Sacramento, Cal., and a 35-mile line at Provo, Utah.

BIBLIOGRAPHY. For the best available literature on power transmission, see Kent, *Mechanical Engineers' Pocket Book* (New York, 1900); Flather, *Rope Driving* (New York, 1895); Mark, *Hydraulic Power Engineering* (New York, 1900);

Richards, *Compressed Air* (New York, 1895); Unwin, *Development and Transmission of Power* (London, 1894).

POWER, D'ARCY (1855—). An English surgeon, born in London. He was educated at New and Exeter colleges, Oxford; in 1878-79 was demonstrator of comparative anatomy at University College, London, and in 1878 was appointed a demonstrator of physiology at Saint Bartholomew's Hospital, where he subsequently became assistant surgeon, teacher of surgery, and surgeon in charge of the throat department. In 1883 he was admitted a fellow of the Royal College of Surgeons of England, in which he held the posts of examiner and Hunterian professor of surgery and pathology. He was also appointed assistant professor in the Royal Veterinary College. His published writings include studies of cancer, intestinal obstruction, and other medical subjects, *Memorials of the Craft of Surgery* (1886), a *Life of William Harvey* (1897), and biographies of eminent surgeons contributed to the *Dictionary of National Biography*.

POWER, HENRY (1829—). An English ophthalmologist, born in Nantes, France. He was educated at Cheltenham College and Saint Bartholomew's Hospital, in 1854 became fellow of the Royal College of Surgeons, and afterwards was its vice-president. He served as consulting ophthalmic surgeon to various London charities, and was appointed lecturer on physiology at Westminster Hospital and professor of physiology at the Royal Veterinary College. He wrote *Illustrations of the Principal Diseases of the Eye* (1869), and *Elements of Human Physiology* (1884).

POWER, MARGUERITE. The maiden name of the English society leader Countess Blessington (q.v.).

POWER, (WILLIAM GRATTAN) TYRONE (1797-1841). An Irish comedian, born near Kilmacthomas, County Waterford. He was taken to Wales while a child, and there about 1813 made his first appearance on the stage. He met with little success, however, and for some time filled only minor rôles. In London he made his first success in the part of Larry Hoolagan O'Halloran in 1824, and from that time confined himself almost exclusively to the portrayal of Irish characters. His acting was distinguished by keen wit combined with tender pathos. He made four successful tours in the United States, and was lost at sea on the return voyage of the last trip. In addition to dramatizing several works, he wrote two novels and *Impressions of America* (2 vols., 1835).

POWER OF APPOINTMENT. An authority or power vested in a person to create a new interest or estate in property in favor of some one whom he may select. For example, A may convey land to B for life, with power to appoint some person to whom the property shall go on B's death. A power of appointment is to be distinguished from a power of revocation, which authorizes the donee of the power to divest or destroy an existing estate. Consult Sugden on *Powers*; see also **POWER**.

POWERS, HIRAM (1805-73). An American sculptor. He was born July 29, 1805, on a small farm in Woodstock, Vt. As the farm proved insufficient for its support, his family

moved to Ohio, where the boy first worked in a clock factory. Later he was employed for seven years to model and repair wax figures in a museum in Cincinnati. This occupation led to the making of wax portrait busts of leading men of the time, General Jackson, Daniel Webster, John C. Calhoun, Chief Justice Marshall, and others, which, being modeled from life, brought him into intimate relations with his famous subjects, especially with Webster at Marshfield. In 1837 he carried the plaster casts of his busts to Italy, and to superintend their execution in marble, he established a studio in Florence, where he spent the rest of his life. Within a year he had completed a statue, "Eve Tempted," which met with the approval of Thorwaldsen, and in 1843 he finished the well-known nude female statue, the "Greek Slave," of which many duplicates were made. A bust of "Proserpine," a statue of a "Fisher Boy" (1846), an "American" (1854), and a "Californian" (1858), are in the same style as the "Greek Slave." He made also statues of Franklin (1862), in the Capitol at Washington, and "Jefferson" (1862), of Washington for Louisiana, Webster for Massachusetts, and Calhoun for South Carolina (1850). His best work, however, is in busts. Among the best, besides those mentioned above as modeled in wax, are those of John Quincy Adams, Martin Van Buren (1835), Edward Everett and John Preston (1845), Longfellow and General Sheridan (1865). He had a strong mind and was a realist by temperament, accustomed to face the facts of nature and to represent them in a truthful matter-of-fact way. Consult Tuckerman, *Book of the Artists* (New York, 1867).

POWHATAN, pou'hâ-tân' (c.1550-1618). A famous Indian sachem. His real name was Wahunsoacook, Powhatan being the name of his tribe. Captain John Smith (q.v.) described him in 1609 as a "tall, well-proportioned man, with a sower look, his head somewhat gray, his beard so thinne that it seemed none at all, his age neare sixtie, of a very able and hardy body to endure any labor." He was originally a chief or *werowance* of eight tribes, but gradually gained control over thirty out of the forty tribes in the surrounding country, and, for an Indian, lived with the greatest pomp and ceremony, generally having a guard of 200 warriors about him, and enforcing implicit obedience upon his followers. He lived part of the time at a village, Powhata, near the site of the present Richmond, and part of the time at another village, Weronomoco, in the present Gloucester County, about fifteen miles from Jamestown. In 1607 he held Captain John Smith as a prisoner for a time and was said to have condemned him to death and to have spared him on the intercession of Pocahontas (q.v.). In 1609 Smith and Captain Christopher Newport visited him to secure provisions, and formally crowned him, with much ceremony, as the 'Emperor of the Indies.' Capt. Smith having attempted to capture him, he planned, in retaliation, the destruction of the English, who were saved by the timely warning of Pocahontas. For the most part he was very suspicious of the colonists, but during his later years lived on terms of peace with them.

POWHATAN CONFEDERACY. A confederacy of Algonquian tribes of eastern Virginia, deriving its name from its organizer and ruling

chief, Powhatan (q.v.). The territory of the confederacy comprised all of tidewater Virginia from Chesapeake Bay inland to the falls of the principal rivers, or just west of a line drawn through Fredericksburg, Richmond, and Petersburg, and may possibly have included also the Virginia counties on the eastern shore, although this may be considered doubtful. The tribes included within the confederacy were some thirty in number, of which the Pamunkey, Chickahominy, Nansemond, Nantaughtacund, Potomac, and Wicocomoco were the largest. Their total population was estimated by Smith in 1607 at 2400 warriors, possibly 8000 souls, occupying some 200 villages and small settlements along the streams. The confederacy as it then existed was of recent extension, all excepting those tribes adjoining the site of Richmond and upon the Pamunkey and its branches having been conquered and annexed by Powhatan during his lifetime. It was not until the settlement of Jamestown in 1607 that continuous intercourse between the whites and the Powhatan tribes began. The first contact was generally friendly, but a hostile feeling soon sprang up between the two races, which was fast leading to open warfare when, on account of the marriage of Pocahontas to John Rolfe, Powhatan was induced to make a treaty of peace and friendship with the English. This peace lasted until after his death in 1618, when his successor, Opechancano, organized a conspiracy to drive the whites from the country. On March 22, 1622, the war began with a general massacre in which 347 persons perished and the majority of the scattered settlements were destroyed.

A war of fourteen years' duration ensued, until both sides were exhausted, when peace was made in 1636. The greatest event of this war was the battle of Pamunkey in 1625, when Governor Wyatt engaged and defeated nearly 1000 Indian warriors and destroyed the principal town of the confederacy. In 1644 Opechancano organized a second conspiracy, which began, as before, with a general attack upon the settlements, resulting in the death of about 300 settlers. It was the last effort against the invader. The Indians were already decimated and impoverished and unable to follow up their temporary advantage. Within a year the war was ended by the capture and death of the old chief, and each remaining tribe made what terms it could for itself, and the confederacy came to an end. In 1669 a census showed that the 2400 warriors of sixty years ago had been reduced to 528, a diminution from perhaps 8000 to about 1600 souls, or hardly one-fifth the original number. In the war of Bacon's Rebellion, 1675-76, they were again hunted down like wild animals until the fugitives took refuge in a palisaded fort near the site of Richmond. The fort was stormed, and men, women, and children massacred by the whites. Those who escaped were allowed to live on condition of an annual tribute from each village. In 1684 four chiefs attended as delegates at the making of a treaty at Albany by which the Iroquois agreed to cease their attacks upon the Virginia remnants. This is their last prominent appearance in history. In 1705 they had four towns, the largest being Pamunkey, with about 200 souls. There are now about 600 representatives of the old stock, living chiefly in four communities, viz.: Pamunkey, 140 persons, on a small State reserva-

tion on Pamunkey River, King William County; Mattapony, 50 persons, on another smaller reservation on Mattapony River, in the same county; Chickahominy, 220, along Chickahominy River, in New Kent and Charles City counties; Nansemond, 180, near Portsmouth, in Norfolk County.

All the typical Indian customs of scalping, tattooing, dancing, and medicine men were found among the Powhatan tribes when first known to the whites. They wore very little clothing beyond the G-string for men and a short skirt for women, with a robe for state occasions or in very cold weather. The men commonly shaved the hair on one side and left it flowing loosely on the other. Their houses were wigwams of wagon-top shape, with frame-work of poles covered by bark or mats, sometimes built closely together and surrounded by stout palisades. They cultivated corn, beans, squashes, and tobacco, which, with fish, game, and wild fruits, gave them an abundant subsistence. They were expert at shaping dugout canoes and weaving fish-nets and baskets. The dead were buried in the ground or preserved in a mummified condition in houses built for the purpose. In some cases the bones were gathered up and cleaned for preservation after the body had decayed. They had an elaborate mythology and ceremonial, of which very little is known, with sacred temples guarded by priests. Tribal government was based on the clan system, with descent in the female line. Their history proves that they were brave and expert warriors. Their modern mixed blood representatives are either fishermen or farmers. See VIRGINIA; PAMUNKEY; POWHATAN; OPECHANCANO; POCAHONTAS.

POWN'ALL, THOMAS (1722-1805). An English statesman and colonial official. He was born probably at Lincoln, graduated at Trinity College, Cambridge, in 1743, and soon afterwards obtained a place in the office of the Board of Trade and Plantations. In 1753 he came to New York as private secretary to Governor Osborn. The next year he was present at the Albany Congress, and while there became convinced of the desirability of intercolonial union. About this time he made the acquaintance of Benjamin Franklin, and the friendship then formed lasted until Franklin's death. In 1757 Pownall became Governor of Massachusetts, and shortly afterwards of New Jersey also, but soon resigned the latter office. He was very active in raising troops to fight against the French, and for a time was popular, but ultimately his vanity and love of gay attire and society gained him the ill-will of many. Having grown tired of his office and applied for his recall, he was in 1759 appointed Governor of South Carolina, but he returned to England without visiting that colony. In England he proved himself a staunch friend of the colonists. He contended that they were entitled to the same rights as Englishmen, and proposed a scheme for what would now be called 'imperial federation.' From 1768 to 1780 he was a member of Parliament, and as such denounced the oppressive acts directed at the Americans; but when war broke out he gave some support to Lord North, and opposed Burke's conciliatory bill of November, 1775. Soon afterwards, however, he declared that the colonies were lost forever, urged that to circumvent the French a commercial treaty should be negotiated with the colonists, and in 1780 brought in a bill for mak-

ing peace. By most of his contemporaries Pownall was regarded as a visionary on political matters, but he really possessed profound insight, and he foresaw, among other things, the future preponderance of the English race in America. As a scientist, antiquary, and man of letters he was better appreciated, and was a member of the Society of Antiquaries and of the Royal Society. He wrote on a great variety of subjects. His works include: *Administration of the Colonies* (1764); *Topographical Description of the Middle Colonies* (1776); *Memorial to the Sovereigns of America* (1783); *Hydraulic and Nautical Observations on the Currents of the Atlantic Ocean*, with notes by Dr. Franklin (1787); and *Memorial to the Sovereigns of Europe and the Atlantic* (1803).

POYNINGS, Sir EDWARD (1459-1521). An English statesman. In 1483 he was a leader in the Kentish uprising in behalf of Buckingham in the latter's insurrection against Richard III. His name having appeared in Richard's proclamation, he fled to the Continent, identified himself with the fortunes of Henry, Earl of Richmond (later Henry VII.), and landed in England with the Earl in 1485. In that year he became a Privy Councillor, and in 1492 was sent with a force of 1500 men to reinforce Maximilian I. in the contest with his rebellious subjects in the Netherlands. He effectually did away with rebel privateering, and with the Duke of Saxony captured Sluis. In 1494 he was sent with an army to Ireland as Lord Deputy, with the purpose of completely subjugating the country, and in the same year convoked a Parliament which, under his direction, passed various acts which crushed the Yorkist Party in Ireland and placed the administration of Irish affairs under the direct control of the English Crown and Privy Council. (See IRELAND.) He made two expeditions to Ulster, drove the Pretender, Perkin Warbeck, to Scotland, and was recalled in 1496. Subsequently he held various posts, including that of warden of the Cinque Ports, sat in Parliament, and conducted the negotiations for Henry VIII. when that monarch joined the 'Holy League' against France.

POYNINGS LAW. A statute enacted by the Irish Parliament at Drogheda in 1494. See IRELAND (*History*); POYNINGS.

POYN'TER, Sir EDWARD JOHN (1836—). An English historical and decorative painter and author. He was born in Paris, March 30, 1836, the son of an architect. From 1854 to 1856 he was a pupil of Leigh's Art School in London, and of the Royal Academy, and from 1856 to 1859 he studied in Paris under Gleyre. In 1860 he returned to London, where he has since resided. He was Slade professor of fine arts at University College, London, from 1870 to 1875, when he became director of the art schools at the South Kensington Museum, and in 1894 he was appointed director of the National Gallery. Elected Royal Academician in 1876, in 1896 he succeeded Millais as president of the Academy. Poynter executed some decorative work in mosaic in the House of Parliament, in Saint Paul's Cathedral, and in Westminster Palace, London. He also made two sets of designs for the English coinage of 1894. Among his easel paintings are: "Israel in Egypt" (1867); "Helen of Troy" (1881); "The Meeting of Solomon and the Queen of

Sheba" (1891); "Idle Fears" (1894); and the "Ionian Dance" (1899). His masterpiece, "A Visit to Æsculapius," is considered in point of technique one of the best products of English Classicism. He published *Ten Lectures on Art* (1879).

POYN'TING, JOHN HENRY (1852—). An English scientist, born at Monton, Lancashire. He was educated at Owens College, Manchester, and Trinity College, Cambridge, was demonstrator under Prof. Balfour Stewart in the physical laboratory of the former in 1876-79, in 1878 became a fellow of Trinity College, Cambridge, and in 1880 was appointed professor of physics at Mason College, Birmingham (now the University of Birmingham). His writings include contributions to the *Philosophical Transactions* and the *Proceedings of the Royal Society* on the transfer of energy in the electro-magnetic field, the mean density of the earth, the connection between the electric current and the electric and magnetic induction in the surrounding field, and other topics. His Adams prize essay (Cambridge, 1891) on *The Mean Density of the Earth* was published in 1891. He also collaborated with J. J. Thomson (q.v.) on *A Text-Book of Physics*.

POYSER, poi'zēr, Mrs. A prominent character in George Eliot's *Adam Bede*, a farmer's wife, whose shrewd and humorous sayings are inimicable.

POZHARSKI, pō-zhār'ské, DMITRI MIKHAIL-OVICH, Prince (1578-1642). A Russian patriot, liberator of Moscow from the Polish domination (1610-12). He fought against the Polish invaders, who had helped to place a pseudo-Demetrius upon the Russian throne, and for his successes was appointed Voivode, or administrative official, of Zaraisk. In 1611 he marched upon Moscow against stubborn resistance, but was severely wounded and compelled to retreat. Subsequently he assumed command of the volunteer forces assembled by Minin, a butcher of Nizhni Novgorod. With these he succeeded in expelling the Poles from Moscow, which they had held for two and a half years. He also conducted further campaigns, was appointed boyar in 1613, and was sent to Sweden on a diplomatic mission. Consult the biography by Malinovski (Moscow, 1817).

PÖZL, pōts'l, JOSEPH VON (1814-81). A Bavarian jurist, born at Pechternersreuth. He studied at the University of Munich, and became professor of law at Würzburg in 1845. Two years afterwards, on the appearance of his *Kompendium des bayrischen Staatsverfassungsrechts* (1847), which was in direct opposition to the practices of the Ministry, he was called to the chair of constitutional law at Munich. A member of the Frankfort Parliament of 1848, in 1858 he entered the Bavarian lower chamber, of which he became first president in 1865. His works on Bavarian law are many and valuable; especially important are the *Lehrbuch des bayrischen Verfassungsrechts* (1851, and often reprinted); *Sammlung der bayrischen Verfassungsgesetze* (1852 et seq.); and *Die Gesetzgebung des Königreichs Bayern seit Maximilian II.* (1852 et seq. with Dollmann).

POZZI, pō'tsé', SAMUEL JEAN (1846—). A French anthropologist and surgeon, born at Bergerac. He studied medicine under Broca

in Paris, and in 1883 became head of the Hôpital de Lourcine (afterwards called Broca). Devoting himself to gynecology and the reform of its methods, Pozzi was frequently commissioned by the Ministry of Education to study foreign medical schools in Germany, England, Austria, Italy, and the United States. He founded the French 'surgical congress,' was president of the Surgical Society of Paris, and in 1898 entirely remodeled the Hôpital Broca, making it one of the best equipped hospitals in the world. He wrote on anthropology and comparative anatomy, was chosen president of the French Anthropological Society, and published some valuable works on his medical specialty, including a *Traité de gynécologie clinique et opératoire* (1890; 3d ed. 1897; trans. into German, English, Spanish, Italian, and Russian). In 1898 Pozzi was elected Senator from Dordogne.

POZZO DI BORGO, pō'tsō dē bōr'gō, CARLO ANDREA, Count (1764-1842). A diplomat in the Russian service. He was born at Alata Corsica, March 8, 1764, and studied law at the University of Pisa. He practised as an advocate in Corsica, and won a high reputation for acuteness and eloquence. He was on terms of somewhat intimate friendship with the Bonapartes until his association with Paoli (q.v.) estranged them, and this estrangement became a positive antagonism. Pozzo represented Corsica in the French National Assembly (1791-92), and was one of the moderates. He returned to Corsica, where he again attached himself to Paoli's party; and on the failure of that chief's plans, retired to London. Here he became the agent of the French émigrés; and in 1798 he went to Vienna to promote an alliance of Austria and Russia against France, and accompanied the Russian army in the subsequent campaign of 1799. In 1803 he entered the Russian service as a councilor of State, from this time devoting his whole attention to diplomacy. He was largely concerned in the Russo-Austrian alliance, which was dissolved by the battle of Austerlitz (1805); but after the Treaty of Tilsit, fearing lest Napoleon might insist upon his surrender, he retired to Austria, from which Napoleon in 1809 demanded his extradition. The Emperor Francis refused; but Pozzo retired to England (1810), where he stayed for some time, and then returned to Russia. He was instrumental in bringing about the rupture between Alexander I. and Napoleon, and this was followed by the campaign of 1812. He also brought about the defection of Murat and Bernadotte from the Napoleonic cause; and after the victorious Allies had driven Napoleon across the Rhine, Pozzo, at the congress of Frankfort-on-the-Main, drew up the declaration "that the Allies made war not on France, but on Napoleon." From this time his whole energies were devoted to the task of keeping Alexander inflexible with regard to Napoleon's seductive offers of accommodation; but after his old antagonist's downfall he exerted himself with equal vigor at Paris (where he signed the Treaty of 1815 as Russian Ambassador) and at the Congress of Aix-la-Chapelle (1818) to ameliorate, as much as possible, the hard conditions imposed upon France. His presence in Paris as Russian Ambassador was exceedingly unpopular after 1830, and in 1834 he accepted the post of Russian Ambassador in London. He retired from public life in 1839, and

settled in Paris, where he died, February 15, 1842. His correspondence with Nesselrode (1814-18) was published with an introduction and notes by Count Charles Pozzo di Borgo in two volumes (Paris, 1890-97). Consult also: Maggiolo, *Pozzo di Borgo* (Paris, 1890); Vuhrer, *Notice biographique sur le comte Pozzo di Borgo* (Paris, 1842).

POZZUÓLI, pōt'sōō-ō'lé (Lat. *Puteoli*). A port in the Province of Naples, Italy, situated on the gulf of the same name, 6 miles west of Naples, with which it is connected by rail and by tramway (Map: Italy, J 7). It lies on a hill in a volcanic district, which is exceptionally rich in old Roman ruins of every description, including ancient piers and a few fragments of Cicero's famous villa. The Roman amphitheatre rises on three rows of arches, around which extends an exterior court. The arena is 369 feet long and 216 feet broad, and could be flooded with water for naval contests. Nero entertained guests here with gladiatorial combats, and here Saint Januarius was in vain cast before wild beasts. The curious temple (or perhaps market hall) of Serapis was a square court with numerous small apartments surrounding it. It had 48 huge columns and its portico was graced by a frieze. In the court rose a round temple, with columns. The lower sections of the ruin are below sea level. The purpose and history of the building are in doubt. The famous Solfatara in the immediate vicinity is the oblong crater of a semi-extinct volcano. Sulphurous gases rise in it constantly, and the ground is hollow. Pozzuóli has mineral baths. An excellent cement is made from a peculiar puzzolana earth found about the town. Near Pozzuóli is an important branch of the manufacturing firm of Armstrong & Co. It manufactures cannon and armor plate for the Italian navy and is fostered by the Government. The harbor has of late been improved by the Government. The population in 1901 (commune) was 22,907.

The foundation of Pozzuóli is ascribed to fugitives from Samos in B.C. 528, who called their new town Dicearchia, which Greek name later gave place to the Latin name Puteoli. At first under the sway of Cumæ, and later of Capua, it fell into the hands of the Romans, along with the latter city, in B.C. 338, and was fortified and held by them against Hannibal. After the conclusion of the Second Punic War, the Romans planted a colony there, and the great prosperity of the city began, and continued throughout the Empire. A mole was built, and Puteoli became the great emporium of trade with the Orient. It was also one of the most important cities of Italy for manufactures, and the beauty of its coast and the healing qualities of its sulphur springs enabled it to vie with its neighbors, Baia and Cumæ, as a fashionable watering place.

PRABODHA-CANDRODAYA, prā-bōd'hā chān-drō'dā-yā (Skt., rise of the moon of intellect). A Sanskrit drama of the eleventh century by Krishna Misra, who wrote it for Kirtivarman the Chandella (1056-1116). The drama is in six acts, and is an ardent defense of Vishnuite Vedantism (see *VEDANTA*) against infidelity, Jainism (q.v.), and Buddhism (q.v.). The dramatis personæ are 44 in number, all of them abstract in character, as Maya (q.v.),

Purusha (q.v.), Reason and Revelation with their children Intellect and Science, Hypocrisy and his son Falsehood, Passion, his officer Anger, and his female attendants Delusion and Allurement, while the heretical sects have each a typical representative. The action of the drama, while not rapid, does not drag, and the repeated attempts of Passion and his followers, who quickly captivate the heretics, but fail utterly with Reason and his subjects, to overthrow faith in Vishnu (q.v.), are treated vividly. The play closes with the overthrow of the hosts of Passion and the triumph of Reason. The *Prabodha-Candrodaya* has been edited by Brockhaus (Leipzig, 1845) and in the *Niraya-Sagara* Press Series (Bombay, 1898), and it has been translated into German by Goldstücker (Königsberg, 1842) and Hirzel (Zurich, 1846), and into English by Taylor (Bombay, 1811; reprinted ib., 1893). Consult Lévi, *Théâtre Indien* (Paris, 1890).

PRACTICE (from OF. *practiser*, *pratiser*, *practiquer*, *pratiquer*, Fr. *pratiquer*, to practice, from ML. *practicare*, *praticare*, to perform, from *practica*, business, fem. sg. of Lat. *practicus*, from Gk. *πρακτικός*, *praktikos*, practical, from *πράσσειν*, *prassein*, to do). In general, the acquisition of a special skill or dexterity by frequent performance of an action, or of a special experience by long familiarity with a subject. Psychologically regarded, it is a state of consciousness (see *ATTENTION*), varying in degree with the amount of time and attention devoted to a problem, and characterized in its higher stages by a maximal concentration of attention (together with all the advantages for observation that this insures) and by a maximal capacity of reproduction (extent and accuracy of memory). It is thus the converse of fatigue (q.v.). "To practice is due a steady increase in delicacy of perception and readiness of judgment; to fatigue, a steady decrease in both" (Külpe). The determination of the stage of practice at which one is working is, therefore, of extreme importance in experimental psychology, especially in work of such fineness as, e.g. the comparison of short intervals of time. (See *DURATION*.) Thorkelson, in an investigation of the 'time sense,' distinguishes no less than six degrees of practice, each of which has its characteristic difference limen. (See *DISCRIMINATION*, *SENSIBLE*.) Where an unpracticed observer can discriminate differences of 1/10, an observer in the advancing stages of general practice can cognize differences of 1/12 to 1/15; with complete general practice, differences of 1/15 to 1/18; with advancing special practice, differences of 1/18 to 1/20; with a higher degree of special practice, differences of 1/20 to 1/25; while maximal special practice still remains as the limiting term of the series.

The distinction here made between general and special practice is important. General practice implies a familiarity with problems or actions of the same class or kind as those in hand: thus, any student who has worked in a psychological laboratory may be regarded as 'generally practiced' in experimental psychology, whereas on entering the laboratory he was wholly unpracticed. So any one who has had piano lessons in childhood may be said to be 'generally practiced' in musical appreciation and rendition. General practice furthers accuracy of observation and

power of judgment at large. It does not imply, as special practice does, a peculiar facility for work of a special kind. General practice will assist a man in a general way for work upon the time sense; but special practice must be acquired in the course of that work itself. In the same way, general practice in piano-playing does not assist one, in more than a general way, toward facility in rendering new compositions at sight; this facility must be gained by special practice with such compositions. Hence "general practice increases in direct proportion to special, but the reverse is not necessarily true."

The characteristics which we have assigned to the practiced consciousness—maximal degree and constant direction of attention, delicacy of perception, extent and accuracy of memory, confidence of judgment—are evidently of a functional nature; they tell us nothing of the contents or structure of consciousness. Practice introduces no new contents. It has, however, the effect of narrowing consciousness. The practiced observer is able, by the very fact of practice, to hold himself exclusively to the practiced subject-matter, and to ignore distracting influences. In this respect the structure of the practiced consciousness differs considerably from that of the unpracticed, whose attention is discursive and whose contents are more numerous and disconnected.

BIBLIOGRAPHY. Wundt, *Physiologische Psychologie* (Leipzig, 1893); Külpe, *Outlines of Psychology*, trans. (London, 1895); Titchener, *Experimental Psychology* (New York, 1901).

PRACTICE. In its strict legal sense, the manner or order of conducting civil or criminal actions, with reference to the successive steps necessary to be taken in order to bring the proper parties before the court, and to bring the action or proceeding to a final determination. It is less comprehensive than the term 'procedure,' which includes the greater part of the *adjective* law, that is, the law relating to remedies, as opposed to substantive law, which defines rights. For a more general treatment of the subject, consult: Aldrich, *Equity Pleading and Practice* (2d ed., Boston, 1902); Daniell, *Pleading and Practice of the High Court of Chancery* (6th Am. ed., Boston, 1894); Stringer, *A. B. C. Guide to the Practice of the Supreme Court* (London, 1903); Tidd, *Practice of the Court of King's Bench* (4th American ed., Philadelphia, 1856). See PROCEDURE; PLEADING.

PRADIER, prá'dyá', JAMES (1792-1862). A French sculptor. He was born in Geneva, May 23, 1792, of a family of French Protestant refugees. His talent was discovered by Baron Denon, and the boy educated in Paris under the sculptors Gérard and Lemot. He won the Grand Prix de Rome in sculpture in 1813. Pradier became a prolific sculptor. He made his debut in the Salon of 1819 with a statue of a "Centaur and Bacchante," now in the museum at Rouen. Similar works are the "Toilette d'Atalante" (Louvre), the "Odalisque" (Museum of Lyons), the "Poetry" (1846), the "Three Graces" (Château de Versailles), and "Sappho" (Louvre). His most important works, however, are the decorative figures of the Fontaine Molière, the figures in the spandrels of the Arc de Triomphe, the twelve Victories which surround the tomb of Napoleon at the Invalides, and the statues of the cities of Lille and Strassburg in the Place de la Concorde, all in Paris. He also made the figures

of the Fontaine Louvois; statues of Saints Andrew and Augustin, in the Church of Saint Roch; the statue of Saint Peter in Saint Sulpice; a group of the "Marriage of the Virgin," in the Madeleine; and statues of Cuvier, Baron Gérard, Jean Jacques Rousseau, and Marshal Soult.

Pradier's quiet, elegant, and formal manner had many imitators, and created what may be called the style Louis-Philippe; but his influence disappeared under the Romanticism of the following period. He was made a member of the Institut and professor at the Ecole des Beaux-Arts in 1827. He died at Bougival, June 14, 1852. For his biography, consult Etex (Paris, 1859).

PRADIER-FODÉRÉ, fô'dá'rá', PAUL LOUIS ERNEST (1827—). A French jurist and educator. He was born and educated at Strassburg, and was admitted to the bar in Paris, where subsequently he occupied the chair of public law in the Armenian College. In 1874 he went to Lima on the invitation of the Peruvian Government to reorganize the legal department. Returning after the war with Chile, he became judge in the Court of Appeals at Lyons (1882). Among his works are: *Précis de droit administratif* (1853; 7th ed. 1876); *Principes généraux de droit, de politique et de législation* (1869); *La question de l'Alabama et le droit des gens* (1872); *Cours de droit diplomatique* (1881); and *Traité de droit international public européen et américain* (1885-94).

PRADILLA, prá-dé'lyá', FRANCISCO (1847—). A Spanish historical and genre painter, born at Villanueva de Gallego, Province of Saragossa. He studied art under distressing privations, first at Saragossa, then under Serri in Madrid, until a successful competition secured him a place as pensionary in the Spanish Academy in Rome, of which afterwards he was director (1881-83). The second of his more important works, "Joanna the Mad Following Her Husband's Coffin" (1878, Madrid Museum), of which he subsequently painted several replicas on a smaller scale, was awarded the medal of honor at the Paris Exposition of 1878, and with "The Surrender of Granada, 1492" (1882, Senate Chamber, Madrid), he created a sensation in Rome and won a gold medal at Munich in 1883. His genre scenes from popular life frequently of miniature dimensions and distinguished for subtle characterization, equal his large composition in point of sterling technique. The best of them include "Market Day Near Vigo" (1892); "Washerwomen at the Brook" (Breslau Museum); and "Pilgrims to the Madonna at Genazzaro" (1895). He was the foremost colorist among the Spanish painters of his day, won gold medals also in Vienna and Berlin, and was appointed director of the Madrid Museum in 1896.

PRADO, prá'dó', MARIANO IGNACIO (1826—). A Peruvian soldier and politician, born at Huánaco. In 1854 he took a prominent part in the revolution that overthrew General Echenique, and again in 1865 was a leader in the movement against President Pezet, whose temporizing attitude toward Spain he strongly opposed. He forced Pezet to resign, and was himself elected President. An offensive and defensive alliance with Chile was formed by him, and, having declared war against Spain, he repulsed the Spanish fleet from Callao (May 2, 1866). His posi-

tion was, however, unconstitutional, and he was obliged to flee in 1868. Subsequently he returned to Peru, where he was elected President in 1876, and in 1879 he declared war against Chile. In the latter part of that year he met severe reverses, and sailed for Europe, leaving the conduct of affairs to La Puerta, the Vice-President. Prado was permitted in 1886 to return to Lima, where he took no further noteworthy part in politics.

PRADON, prá'dôn', NICOLAS (1632-98). A French dramatic poet, born at Rouen. Nothing is known of his life except that he came to Paris at an early age and devoted himself to play-writing. His *Phèdre et Hippolyte* (1677) was ordered by the Duchess de Bouillon and her brother, the Duke de Nevers, who were at the head of the plot against the *Phèdre* of Racine. A *claque* was hired to applaud the worse than mediocre play of Pradon at the cost of Racine's, and such was its success that the latter poet gave up the drama entirely. Other works by Pradon are *Pryame et Thisbé* (1674), *Tamerlan* (1675), and *Regulus* (1688). Collections of his works were published in 1679, 1682, and 1700.

PRADT, prêt, DOMINIQUE DE (1759-1837). A French prelate and diplomat. He was born at Allanche, in Auvergne, studied first in a military school, but was ordained priest in 1783, and pursued his theological studies at the Sorbonne, becoming doctor of theology in 1785. Made vicar-general of the diocese of Rouen in the same year, he represented it in the States General of 1789, and, siding with the Clerical Party, was forced to number himself among the 'émigrants' in 1791. After the 18th Brumaire (November 9th), 1799, however, he returned to Paris and was introduced to Bonaparte, who, on becoming Emperor, appointed him chaplain in ordinary, and shortly thereafter Bishop of Poitiers. For his part in negotiating the Treaty of Bayonne, in 1808, by which Napoleon de-throned the House of Bourbon in Spain, he was rewarded with the Archbishopric of Mechlin. Sent to Warsaw as ambassador, in 1812, his failure on this mission turned the favor of the Emperor, and he was retired to his diocese. He now openly embraced the cause of the Bourbons and Louis XVIII. nominated him grand chancellor of the Legion of Honor, but in less than a year he was replaced by Marshal Macdonald and also relieved of his Archbishopric of Mechlin, in exchange for which, however, he received a pension of 12,000 francs from the King of Holland. He retired to his estate in Auvergne, devoted himself to literary pursuits, and, being elected Deputy from Clermont in 1827, sided with the opposition. He renewed his allegiance to the royalist party after the revolution of July. Among his numerous works may be named: *Histoire de l'ambassade dans le grand-duché de Varsovie en 1812* (1815; 9th ed. 1826); *Du congrès de Vienne* (1815); *Mémoires historiques sur la révolution d'Espagne* (1816); *Des colonies et de la révolution actuelle de l'Amérique* (1817); *L'Europe et les colonies depuis le congrès d'Air-la-Chapelle* (1821). Consult De Lastie-Rochegonde, *Dominique de Pradt* (Saint-Armand, 1897).

PRÆCOCES, prêt-kō'sēz (Lat. nom. pl., premature, precocious). Those birds which, like the domestic fowl, run about and look after

themselves, picking up their own food as soon as they are hatched; opposed to 'Altrices.' See BIRD and NIDIFICATION.

PRAED, prêt, Mrs. CAMPBELL. An Australian author. See AUSTRALIAN LITERATURE.

PRAED, WINTHROP MACKWORTH (1802-39). An English poet, born in London, July 26, 1802. He was educated at Eton and at Trinity College, Cambridge, where he was distinguished for his Greek and English verse; was elected fellow of Trinity (1827); called to the bar (1829); sat in Parliament (1830, 1834, 1837); became secretary to the board of control (1834); and afterwards deputy high steward to the University of Cambridge. He died July 15, 1839. Praed was one of the prime movers in establishing a national system of education. His light essays and poems were contributed to various periodicals. As a writer of society verse, Praed stands in the first rank. His typical moods—gay, pensive, and tender—are well represented by "Araminta," "The Vicar," and "My Little Cousins." Consult: *Poems*, ed. with memoir, by Derwent Coleridge (2 vols., London, 1864); selections from the poems, ed. by Cooper for the Canterbury Poets (ib., 1886); and select essays in Morley's *Universal Library* (ib., 1887).

PRÆMUNIRE (Lat., to forewarn). In English law, an offense of the nature of a contempt against the sovereign and his government, and punishable with forfeiture and imprisonment. The name is derived from the first words (*præmunire*, or *præmonere*, *facias*) of a writ originally introduced for the purpose of repressing Papal encroachments on the power of the Crown. The first statute of *præmunire* was passed in the reign of Edward I. The suspension, for the time, of the right of the patron, and the nomination of his own authority to vacant benefices by the Pope, was the immediate cause of various subsequent statutes of *præmunire*, which made it penal to endeavor to enforce the authority of Papal bulls and provisions in England. By later statutes, a number of offenses of a miscellaneous description have been rendered liable to the penalties of a *præmunire*, as (by 6 Anne, c. 7) the asserting, by preaching, teaching, or advisedly speaking, that any persons other than such as are entitled under the acts of settlement and union have any right to the throne of Great Britain and Ireland, or impugning the validity of any acts of Parliament limiting and defining the succession to the throne.

PRÆNESTE, prêt-nēs'tè. The modern Palestina. A very ancient city of Latium, situated on the slope of the hills about twenty miles southeast of Rome. Tradition ascribed its foundation to Telegonus, the son of Ulysses, or to a certain Caenulus, son of Vulcan. It was one of the important cities in the early Latin League, and is first mentioned by Livy (ii., 19, 2) as taking the side of Rome against the other cities of the league in B.C. 499. We hear no more of Præneste until B.C. 383, when the town began to lord it over the allies of Rome, and two years later even dared to declare war on Rome itself. It was soon vanquished and forced to surrender to the Roman dictator, Cincinnatus (B.C. 380). In the Hannibalic war the Prænestines were faithful to Rome and were rewarded with an offer of Roman citizenship, which, with lofty local pride, they refused to accept. They spoke a

dialect of Latin which seemed amusing to the Romans, and their habits were regarded as provincial in the metropolis. During the civil wars Marius made Præneste his headquarters, but the city was taken and destroyed by Sulla (B.C. 82), who rebuilt it with great splendor and settled a Roman colony there. Under the Empire Præneste was a favorite summer resort, on account of its lofty position. Horace (*Odyssey*, iii.; 4, 22) finds equal charm in *frigidum Præneste*, *Tibur supinum*, and *liquida Baiæ*. Præneste was renowned for its large and magnificent Temple of Fortune with an oracle much frequented by worshippers. (Cf. *Sortes Prænestinae*, Cicero, *De Div.*, ii., 41.) During the Middle Ages Palestrina was long a bone of contention between the popes and the powerful Colonna family, and was destroyed in 1436, but afterwards rebuilt. In 1630 Pope Urban VIII. ceded it to the Barberini. Palestrina is now a squalid town occupying approximately the site of the ancient Temple of Fortune; its population is 6100. Besides the Barberini Palace, it contains fine remains of the ancient polygonal walls. The great composer Giovanni Pierluigi da Palestrina was born here.

PRAET, præit, JULES VAN (1806-87). A Belgian statesman and historian, born at Bruges. He studied law at Ghent, was appointed archivist of Bruges, later became secretary to Prince Leopold of Saxe-Coburg, and after the latter assumed the title of Leopold I., confidential adviser in the royal suite. In the various difficulties attending the beginnings of the monarchy he was of great assistance. He wrote a *Histoire de la Flandre* (1828), defective owing to the non-critical use of sources; and *L'origine des communes Flamandes* (1829), of much value. But his most important work is his *Etudes sur l'histoire politique des derniers siècles* (3 vols., 1867, 1874, 1884), an admirable series of essays on European politics, in which the analysis of noteworthy historical personages occupies important place. Consult Wanters, *Notice sur Jules van Praet* (Brussels, 1889).

PRÆTOR (Lat., leader, governor, commander). The title of an important magistrate among the ancient Romans. The name meant originally simply 'leader,' and as such was first applied to the two consuls, after the expulsion of the kings. As a separate office the prætorship was first created in B.C. 366, open only to patricians as a compensation for the consulship, to which plebeians were now made eligible. Thus the patrician prætor was a sort of third consul, and in fact was called 'colleague of the consuls,' and was accompanied by six lictors, as the consuls were accompanied by twelve. In B.C. 337 the prætorship too was thrown open to the plebeians, and became the highest judicial office within the city, and the immediate stepping-stone to the consulship. With the growth of Rome's foreign relations and the increase in the city's foreign population, the judicial business became too vast for one magistrate, and in B.C. 246 a second prætorship was founded. From now on, the original prætor, known as *prætor urbanus*, or 'city prætor,' presided over litigation between Roman citizens, while the 'foreign prætor,' or *prætor peregrinus*, presided over cases where one or both of the litigants were foreigners. In B.C. 227 two more prætors were appointed, for the special administration of af-

fairs in Sicily and Sardinia, while Spain received two more in B.C. 197, and in course of time the number was still further increased, until it reached the maximum of eighteen, among which we hear of *prætores ærarii*, or *ad ærarium*, connected with the national treasury, and *prætores tutelarii*, a sort of judges of probate. The prætorship was ordinarily of annual tenure, and the age required was thirty years. After his year of service in Rome the prætor went as governor to some province.

PRÆTORIAN GUARD (Lat. *prætoria cohortes*, *prætoriani*). The body-guard of the Roman emperors. A *prætoria cohort*, or select guard of the most valiant soldiers, was attached to the person of Scipio Africanus; but it was to Augustus that its institution as a separate force was due. He formed nine cohorts, each consisting of 1000 men (horse and foot), under the command of a præfect; but kept only three of them in Rome, the rest being dispersed in cities not far off. Tiberius, however, assembled the nine cohorts at the capital in a permanent camp, and Vitellius increased their number to sixteen. The prætorians served at first for twelve and afterwards for sixteen years; they received double pay; the privates were held equal in rank to the centurions in the regular army, and on their retirement each received 20,000 sesterces. They soon acquired a dangerous power, which they exercised in the most unscrupulous manner, deposing and elevating emperors at their pleasure. Aspirants for the Imperial dignity found it advisable, and even necessary, to bribe them largely; while those who acquired that dignity without their assistance were accustomed on their accession to purchase their favor by liberal donations. The prætorians, however, had no political or ambitious views; they were simply an insolent and rapacious soldiery, fond of substantial gratifications, and unmindful how they got them. After the death of Pertinax (A.D. 193) they actually sold 'the purple' for a sum of money to Didius Julianus; but in the same year their peculiar organization was entirely broken up by Severus, who formed new cohorts altogether out of the best legions serving on the frontiers, which he increased to four times the number of the old. After several other changes, they were entirely abolished by Constantine (A.D. 312).

PRÆTORIUM. A Latin word, adopted into later Greek, signifying originally the tent of the prætor or general; then the military council gathering there. It also designated the official residence of a provincial governor; after the time of Augustus, any princely house; finally, the Imperial bodyguard. In the New Testament the Greek word is variously rendered, owing to the effort of the translators to convey in each case the local or specific significance of the term. Hence in the Authorized Version it is called 'the common hall' (Matt. xxvii. 27); 'judgment hall' or 'Pilate's house' (John xviii., 28, 33; xix. 9); 'Herod's judgment hall' (Acts xxiii. 35); and 'the palace' or 'Cæsar's court' (Phil. i. 13). The Revised Version renders the term either by its transliterated form 'prætorium' or 'palace.' Whatever building the governor occupied at any time was, by virtue of the fact, the Prætorium. In Jerusalem this was probably the well-known palace of Herod, described by Josephus (*Ant.*, xv., ix., 3). Consult for further details the various commentaries on the passages enu-

merated above, and Ramsay, *Saint Paul the Traveller and the Roman Citizen* (New York, 1896).

PRAGA, prä'gá. A suburb of Warsaw (q.v.).

PRAGMATIC SANCTION (Fr. *pragmatique*, from Lat. *pragmaticus*, from Gk. *πραγματικός*, *pragmatikos*, relating to civil affairs, from *πᾶγμα*, *pragma*, deed, from *πράσσειν*, *prassein*, to do). A solemn ordinance or decree of a sovereign dealing with matters of primal importance and regarded as constituting a part of the fundamental law of the land. The term originated in the Byzantine Empire, and signified a public and solemn decree by a prince, as distinguished from the simple rescript, which was a declaration of law in answer to a question propounded by an individual. The name is given in later European history to several important decrees, of which the principal are: (1) Those issued by the Emperor Frederick II. in 1220 and 1232 confirming certain customary rights of local authority wielded by bishops and nobles in the German Empire. (2) The Pragmatic Sanction of Louis IX. of France asserting the rights of the Gallican Church (1269), a document the authenticity of which has been doubted for a long time and now generally abandoned. (3) An ordinance of Charles VII. of France for the reformation of the Gallican Church issued in 1438 after the Council of Basel. (4) The decree of the Emperor Charles V., issued in 1547, declaring his Burgundian inheritance indivisible and the perpetual appanage of the House of Hapsburg. (5) The ordinance by which the Emperor Charles VI. (q.v.), Emperor of Germany, having no male issue, settled his dominions on his daughter, the Archduchess Maria Theresa. The decree was issued in April, 1713, as a family law of the Hapsburgs, and between 1620 and 1624 was ratified by various national diets under the Austrian Crown, becoming thereupon a part of the organic law. The act provided that in default of male issue to Charles VI., the Austrian territories, which were declared inseparable, should descend in the female line according to the law of primogeniture. To lend greater security to the act, Charles VI. sought to gain first the ratification of the great powers, and to this end Austrian policy was directed during the greater part of his reign. Among the guarantors of the sanction were Great Britain, France, Prussia, Russia, and Holland. Nevertheless, the death of the Emperor was followed by a speedy repudiation of their pledge on the part of a number of the powers, and an attack on the Austrian dominions by Prussia, Bavaria, Saxony, and France, Spain entering into alliance with the last-named power. England supported Austria. The conflict is known as the War of the Austrian Succession. Consult Varenbergh, "La pragmatique sanction de Charles VI., sa garantie et son infraction," in *Académie d'archéologie de Belgique*, vol. xxviii. (Antwerp, 1872). (See CHARLES VI.; MARIA THERESA; SUCCESSION WARS; AUSTRIA-HUNGARY.) (6) The settlement of the succession of the Kingdom of Naples, which was ceded by Charles II. of Spain in 1759 to his third son and his descendants.

PRAGUE, präg (Bohemian *Praha*, Ger. *Prag*). The capital of the Austrian Crownland of Bohemia, situated on both banks of the Moldau, 150 miles northwest of Vienna (Map: Austria, D 1). Excluding the suburbs, Prague con-

sists of seven parts; the Altstadt, on the right bank of the river; the old Ghetto, known as the Josephstadt, and surrounded by the Altstadt; the Neustadt, which incloses the Altstadt; the Kleinseite, on the slopes of the Laurenzberg along the left bank of the river; the Hradschin, the kremlin of old Prague, lying on an elevation northwest of the Kleinseite; the new quarter of Wiscchrad, on the right bank of the river south of the Neustadt; and the industrial quarter of Holeschowitz-Bubna in the northeast.

The Moldau is spanned in Prague by nine bridges, of which the best known is the Karlsbrücke (1357-1507), 546 yards long, with two mediæval towers and many buttresses embellished with statues of saints. They include that of Saint John Nepomuk, who is supposed to have been thrown into the river here by order of King Wenceslas, and is regarded by the Bohemians as a patron saint of bridges. The most interesting portion of Prague is the Altstadt, which has still preserved its mediæval appearance. Its centre is the Grosser Ring, a fine square, with a monument (Mariensäule) erected in 1650 in commemoration of the liberation of the city from the Swedes. On the eastern side of the square stands the old Hussite Teyn Church (begun in the fourteenth century), adorned with two striking towers, and containing the tomb of the Danish astronomer Tycho Brahe, marble statues of the apostles to the Slavs, Cyril and Methodius, and a fine winged altar.

Opposite the Teyn Church is the town hall. It is a handsome building with a tower, and contains the council chamber of the old structure which has been so closely associated with the eventful history of the city. Its balcony is embellished with statues, and the council chamber contains a large painting by Brožík, "Huss Before the Council of Constance." Besides the buildings of the famous university (see PRAGUE, UNIVERSITY OF), the Altstadt contains also the Rudolphinum, a fine Renaissance edifice on the Rudolfs Quai, with a conservatory of music, an art industrial museum, and an extensive picture gallery containing many very good paintings by Bohemian as well as by Dutch, Italian, French, and German masters; the Kreuzherren-Kirche, modeled after Saint Peter's; the palace of Count Clam Gallas (1701-12) in the baroque style; the Kinsky Palace, with a valuable library; the Pulverthurn, a relic of the old wall which once separated the Altstadt from the Neustadt; and the Königshof, formerly the palace of the Bohemian kings, now used as barracks.

The Josephstadt formed the Ghetto of Prague until 1848, but is now inhabited mostly by Gentiles. It is the most densely populated portion of the city and contains the old Jewish synagogue dating from the twelfth century, and the curious Jewish burial ground crowded with ancient tombstones having Hebrew inscriptions and various symbols denoting the tribe of the deceased. The Hradschin contains a vast Burg begun, it is fabled, by Princess Libussa and completed by Maria Theresa. In the council chamber of the Burg is shown the window from which the two Imperial counselors were hurled in 1618—the initial act in the Thirty Years' War. The unfinished Gothic cathedral in the Hradschin was begun in 1344 and its choir completed in 1385. Among the interesting objects in the interior are the marble mausoleum

of the Bohemian kings; the Chapel of Saint Wenceslas, embellished with precious stones and faded frescoes; and the silver monument to Saint John Nepomuk.

In the western part of the Hradschin is the Premonstratensian Abbey of Strahow (founded in the twelfth century), with its Church of the Assumption, containing the tomb of Saint Norbert, the founder of the Order, a valuable picture gallery, a fine library, and a good natural history collection. Among other prominent features of the Hradschin mention should be made of the barracks, formerly the palace of Count Czernin; the Capuchin monastery; the Renaissance palace called the Belvedere, erected by King Ferdinand I. in 1538; the archiepiscopal palace; and the Schwarzenberg Palace. The Kleinsseite, although inferior in interest to the Altstadt and the Hradschin, possesses some buildings of historical and architectural interest. Chief among them are the churches of Saint Nicholas and Saint Thomas; the interesting palace built by Wallenstein in 1623-30, with a fine garden and many valued relics of the great general, and a chapel containing a number of paintings by Dürer and others; the palace of Nositz, with a notable picture gallery; the Lobkowitz Palace, with an extensive library; the hall of the Provincial Diet; and the Supreme Court.

The Neustadt, the largest part of Prague, with its fine streets, its modern public buildings, and the general air and stir of a modern city, presents an impressive contrast to old Prague. It contains the imposing Czech National Theatre, completed in the Renaissance style in 1883; the Bohemian National Museum, with its various collections and library; the new German theatre; the courts of justice, formerly a Rathaus; a number of fine banks and hospitals; an exchange, etc. Among its churches may be mentioned the Maria Schnee-Kirche and the churches of Saint Peter and the Karlshof. In the quarter of Wischegrad is situated the modern citadel built on the site of the old fortress destroyed by the Hussites.

During the latter part of the nineteenth century Prague greatly improved in appearance. It also considerably extended its municipal activity, so that at present it owns the water-works, the gas and electric plants, the markets, etc. The sanitary conditions have improved, and the park area has been enlarged. The administration is in the hands of a burgomaster and two deputies, an assembly, and a council. The municipal budget exceeds \$4,000,000 and the indebtedness \$8,000,000. The fame of Prague as an educational centre dates from the Middle Ages, when its university was the leading institution of higher learning in Germany. During the latter half of the nineteenth century the struggle for supremacy between the Germans and the Czechs, and the development of a national consciousness among the latter, have given a strong stimulus to the intellectual life of the people.

This found its expression in the establishment of many national educational institutions in this, the centre of Czech culture. In 1882-83 was established the Czech university, whose attendance is nearly three times that of the German university here. Many of the secondary schools have also since been duplicated, and show a steady increase in their attendance. Besides the two universities and the twelve German and six

Czech secondary schools, Prague has a German and a Czech polytechnic, seminaries for teachers, a school of art, a noted conservatory of music, and many special schools. The most prominent scientific organizations are the Bohemian Academy of Science, Literature, and Art, founded in 1890; the Royal Bohemian Scientific Association, founded about 1770; and the Society for Literature in Bohemia, founded in 1891.

Situated on one of the chief waterways of Bohemia and at the junction of seven railway lines, Prague is naturally the economic centre of the crownland. Its industries are of a wide range, including the manufacture of various metal products, railway cars, leather, cotton goods, gloves, chemicals, beer, and flour. Prague is a great sugar market, and trades extensively in local manufactures and raw products. The population of Prague proper was 170,521 in 1880, 182,530 in 1890, and 204,478 in 1900. The last figure could have been increased to 385,238 by adding the population of the adjacent suburbs economically connected with the city. A significant fact between 1890 and 1900 was the increase of the Czech element. The Czech population is estimated at 87 per cent. of the total. Over 90 per cent. of the population is Roman Catholic.

HISTORY. Nothing definite is known about the foundation of Prague. As the residence of the kings the town played a prominent part in the early history of Bohemia. The Altstadt obtained municipal rights and was surrounded with walls in the first half of the thirteenth century. The Neustadt was established about a century later. Under the rule of Charles IV., Prague became, with the establishment of the university (1348), one of the principal cities of the German Empire. In the following century, however, it became the theatre of the Hussite wars (see **HUSSITES**), and many of its churches and a part of its fortifications were destroyed. It soon recovered and entered upon a new period of prosperity, which culminated under Rudolph II. In the seventeenth century came the Thirty Years' War, which began with the 'defenestration' of the Imperial counselors at Prague (1618). In the battle of the White Hill, fought close to the city, the forces of Frederick of the Palatinate, the 'Winter King,' were completely defeated by the Imperialists in November, 1620. Prague was taken by the Saxons in 1631 and retaken by Wallenstein in 1632. In 1635 a peace was concluded here between Ferdinand II. and the Elector of Saxony. In 1648 the Swedes captured the Kleinsseite—the last episode of the Thirty Years' War. The city was taken by the French, Bavarians, and Saxons in 1741, and capitulated to Frederick the Great in 1744. Frederick won a victory over the Austrians here in 1757, and then unsuccessfully besieged the city. For the history of Prague during the nineteenth century, see the history of Bohemia. The peace of Prague, August 23, 1866, terminated the Seven Weeks' War between Prussia and Austria.

Consult: Erben, *Statistische Handbücher der königlichen Hauptstadt Prag* (Prague, 1873-95); *Oesterreichisches Städtebuch* (Vienna, 1895); Wirth, *Prag* (Leipzig, 1901).

PRAGUE, UNIVERSITY OF. Prague has two universities, one German, the other Bohemian. Of these, the older and more famous is the

former, which is the oldest of German universities. It was founded by Charles IV. in 1348 on the basis of an older school dating back to the middle of the thirteenth century, and was organized on the model of Paris, with the four faculties of theology, law, medicine, and arts, and all rights and privileges of a Studium Generale. It had also one college, founded by Charles and endowed by Wenceslas IV. The Hussite movement interrupted the remarkable prosperity of the foundation, as Huss was one of the leading spirits of the institution, and rector in 1403. Owing to an order of Wenceslas IV., growing out of the Hussite disturbances, that the Bohemian 'nation' should have three votes to the German one in the university convocation, the Germans seceded and founded the University of Leipzig (q.v.). Others joined Heidelberg and Cologne. The Hussite movement had been joined to a national Bohemian movement, and had developed into a political as much as a religious agitation, and the university from the time of the secession lost its cosmopolitan character, and became more identified with Bohemian interests and development. In 1419 Catholics were expelled from the university, and in the troublous times that followed it lost most of its students and nearly all its property. In the latter part of the fifteenth century, however, the foundation of many colleges in great part repaired this loss. In the seventeenth century its religious complexion was changed, and in 1654 it was united with the Jesuit college, coming under the influence of that Order. The Czech movement of the nineteenth century found expression at the University of Prague, first in the increase of lectures in the Czech language, and eventually in the foundation of the Czech University of Prague, in 1882-83, with the three faculties of law, medicine, and arts, to which theology was added in 1891-92. The Czech university has since that time much outgrown its German rival. The number of students in the German university in 1901 was 1179; in the Czech university, 3184.

PRAIRIAL, *prâ'rê'âl'*. The ninth month in the French Republican calendar, extending from May 20th to June 18th in the years I-VII., and from May 21st to June 19th in the years VIII.-XIII.

PRAIRIE (Fr. *prairie*, It. *prateria*, from ML. *prataria*, meadowland, from Lat. *pratium*, meadow). In general, an undulating, grass-covered plain, as distinguished from a forested plain on the one hand and a semi-arid region or steppe on the other. The name is applied more specifically to the extensive plain which stretches from southern Michigan and western Ohio across Indiana, Illinois, Missouri, Iowa, Wisconsin, and Minnesota, thus including almost the entire area between the Ohio and the Missouri-Mississippi rivers. West of the Missouri River this level expanse is continued by the Great Plains to the base of the Rocky Mountains, while on the east it merges imperceptibly into the Allegheny Plateau. Its surface is unbroken by marked elevations, but the monotony is relieved by the broad undulations and by the channels of the streams tributary to the Ohio, Mississippi, and Missouri, which have been worn down in places so as to expose vertical walls or bluffs 100 feet or more in height. The elevation above sea-level ranges from 300 to 1500 feet. The prairies are underlain by Palaeozoic sandstones and limestones in

nearly horizontal position; but the surface formation is largely of glacial origin and consists of boulder clay and sand more or less rearranged and decomposed by weathering and erosion. A fine sandy deposit resembling the loess of China occurs over wide areas in the Mississippi Valley. The prairies are characterized by a heavy rich soil admirably adapted for the growth of cereals, and while formerly covered only with grass and supporting herds of buffalo and deer, they have been brought under a high state of cultivation. As to the characteristics of their vegetation, prairies may be divided into two general groups: climatic, which include typical portions of the western part of the Mississippi Valley; and edaphic, which are smaller and are developed almost without exception from swamps. Among the theories commonly held to account for the treelessness of the great Western prairies are: (1) the lack of sufficient rainfall; (2) the grazing of animals and the action of fire; and (3) the excessive transpiration, due to wind—all of which prevent the growth of trees. In apparent proof of the first theory, trees gradually disappear as the distance from the seaboard increases, and this change is paralleled by a gradual reduction in the rainfall; of the second, trees have appeared in some parts of Kansas and Nebraska, where cattle-grazing and prairie fires have been stopped; of the third, transpiration is so great, especially during winter, that certain trees cannot be successfully grown unless in situations sheltered from the winds. Perhaps all of these theories are more or less tenable. See UNITED STATES; INDIANA; ILLINOIS; etc.

PRAIRIE, THE. A novel by J. Fenimore Cooper (1827). It is the last of the Leatherstocking series, showing Natty Bumppo in the far West after the Louisiana Purchase opened the country to settlers, and giving a touching account of his old age and death.

PRAIRIE CHICKEN. See GROUSE.

PRAIRIE DOG. A Western American ground-squirrel, two species of which (*Cynomys columbianus*, west of the Rockies, and *Cynomys ludovicianus*, east of these mountains) are locally common from the Canadian to beyond the Mexican boundary of the United States. The prairie dog is about a foot long and of robust form, with strong limbs and claws, well calculated for digging. Its home is the dry upland plains, where it dwells in colonies, whose permanent 'towns' or burrows, each marked by a hillock of earth about the entrance, spread densely over many acres under the natural prehistoric conditions, but now sometimes cover hundreds of square miles. The burrows are deep and extensive, and at first go down at a very steep slope to a depth of 12 to 15 feet, when they suddenly turn and run in a horizontal direction, and here and there branch into chambers, some of which are elevated and form family rooms, while in others fodder is stored, or refuse and dung are deposited. The mound about the hole is packed hard, not only by the tramping of the animals, but by crowding it down with their noses; this hillock prevents water from running into the burrows when the plain is flooded by heavy rains, and also serves as a tower of observation. The prairie dogs feed upon grass and herbage, which is soon exhausted near the burrows, compelling the animals to go far-

ther and farther away for food. This they dislike to do, as it exposes them to attack from enemies; and after a time they prefer to dig a new burrow nearer a supply of food. Thus a 'town' is always spreading and contains many empty burrows. Like other animals habituated to desert regions, they do not drink at all, and the early belief that subterranean pits were dug by them, down to a water supply, has been proved erroneous. Artesian wells within dog-towns have failed to strike water as often as elsewhere. The animals are diurnal and most active morning and evening. They come out daily during the winter, except when it is very stormy; but this practice varies with the latitude and climate.

They are prolific, especially in the southern half of their territory, and would multiply with excessive rapidity were it not for numerous enemies, especially rattlesnakes and other serpents. These are courageously resisted by the prairie dogs, which sound the alarm the moment a snake enters a hole, gather, and proceed to fill the entrance with earth, packing it down, thereby sometimes entombing the snake forever. Probably few snakes go down the passages, which are so steep they could with difficulty climb out, but depend upon lying hidden in the grass and striking down the young squirrels when out at play or in search of food. This is the method of the coyote, kit-fox, wildcat, hawks, and owls, who find the dog-towns a profitable hunting ground. Badgers, however, can, if they will, easily dig up a burrow and devour the helpless family. The worst enemy is the black-footed ferret, a weasel of the plains, which easily penetrates the burrows, and against whose ferocity and skill the squirrels can make little defense. Every prairie-dog town is also tenanted by many little burrowing owls (q.v.).

All these conditions together served in the natural state of things to hold the prairie dogs in check, but the changes brought about by civilization have been so favorable to these little animals, by the reduction of their enemies on the one hand, and the augmentation on the other hand of their food-supplies by the farmers' plantations of meadow-grass, alfalfa, and grain, that they have increased into a very serious pest. Dr. Merriam stated in the *Yearbook* of the United States Department of Agriculture for 1901 that colonies 20 to 30 miles in length were then not rare; and one in Texas was known to cover an area of 2500 square miles, with a probable average of 25 holes to an acre and of one animal to each hole. At this rate the prairie-dog population of this district would be 40,000,000; and on the carefully studied estimate of students that 250 squirrels will devour annually the same amount of grass as a cow, the pasturage consumed by this great colony would support about 160,000 cattle. When such a colony spreads over a district devoted to farming the loss is increased, for the space occupied by their mounds is a waste of valuable land; the animals are likely to cut irrigation canals, draining off the water, and they devour the planted crops, especially of alfalfa. Both the Federal Government and local authorities have tried various methods for relief, but are almost helpless in view of the large spaces between cultivated districts, where the pest can only be overcome by public and united effort, and also by

coöperation among the ranchmen. The squirrels may be killed by poison in various ways; but best by the use of bisulphide of carbon. A teaspoonful of this cheap liquid is placed upon some absorbent substance (a nodule of dry horse-dung or half a corn-cob will serve the purpose well) and dropped down the hole, which should then be stopped with earth. The fumes are heavy, sink into the depths of the burrow, and kill the inhabitants. Bisulphide of carbon is not only poisonous, but inflammable and explosive; it should be kept in cans or bottles, tightly corked, and never opened near fire. See *PLATE OF GOPHERS, LEMMINGS, AND MARMOTS.*

PRAIRIE DU CHIEN, *prā'rē dū shēn*. A city and the county-seat of Crawford County, Wis., 60 miles south of La Crosse; on the Mississippi River, and on the Chicago, Burlington and Quincy and the Chicago, Milwaukee and Saint Paul railroads (Map: Wisconsin, B 5). It has a College of the Sacred Heart, and Saint Mary's Institute for Girls. The ruins of old Fort Crawford, built in 1825, are of historic interest; and the mineral springs in the vicinity make Prairie du Chien of considerable importance as a health resort. It is the commercial centre of a fertile agricultural section, and manufactures woollens, pearl buttons, pickles, barrels, egg cases, veneer, etc. Population, in 1890, 3131; in 1900, 3232.

Near Prairie du Chien a fort seems to have been built by the French as early as 1689, but this was soon abandoned and another was built in 1755. The present settlement dates from 1783. The village and fort were surrendered by the English to the United States in 1786, though they were again captured during the War of 1812 and held until 1816. Prairie du Chien was first incorporated in 1872. Consult: Durrie, *Annals of Prairie du Chien* (Madison, 1872), and an article, "Early Days of Prairie du Chien," in the *Wisconsin Historical Society Collections*, vol. v. (Madison, 1868).

PRAIRIE FOX. The kit-fox (q.v.).

PRAIRIE PIGEON, or **PRAIRIE PLOVER**. A local name in the Western United States for both the golden plover and the upland 'plover' (a sandpiper).

PRAIRIE RATTLESNAKE. The small rattlesnake, or massasauga (*Sistrurus catenatus*), of the prairie regions of the Central United States. See **RATTLESNAKE**.

PRAIRIE WARBLER. A wood-warbler (*Dendroica discolor*) of the Eastern United States, olive-green above, spotted with dull red, and lower parts rich yellow, with conspicuous black streaks upon the cheeks and along the sides of the body. It frequents brushy districts, and its habits, song, nest, and eggs resemble those of the common yellow warbler. Consult Coues, *Birds of the Northwest* (Washington, 1874).

PRAIRIE WOLF, or **RED WOLF**. The coyote.

PRAJĀPATI, *prā-jā'pā-tē* (Skt., lord of beings). The name of a Hindu divinity. In the Rig-Veda the word is used also as an epithet of Savitar (q.v.), the revivifying aspect of the sun, and of the invigorating Soma (q.v.). Prajapati's character was essentially that of a creator, and he thus became not only a synonym of Brahma (q.v.), but also, when Brahma's creative godhood

was to be emphasized, of those divine personages who, produced by Brahma, created all existing beings, including gods and demons. Manu names ten such Prajapatis engendered, through pure meditation, by Brahma, Marichi, Atri, Angiras, Pulastya, Pulaha, Kratu, Prachetas or Daksha, Vasishtha, Bhrigu, and Narada. The Puranas (q.v.) contain many legends about them, together with varying accounts both of their number and origin. In modern India the cult of Prajapati has almost disappeared, although the Kumbars, or potter caste, of the Punjab still worship him. Consult: Muir, *Original Sanskrit Texts* (London, 1868-74); Hopkins, *Religions of India* (Boston, 1895); Macdonell, *Vedic Mythology* (Strassburg, 1897).

PRĀJÑĀ PARAMITĀ, prā'nyā pä'rā-mē-tā (Skt., wisdom which has gone to the other shore; absolute or transcendental wisdom). The title of the principal Sutra of the Mahayana School of the Buddhists. Its main object is metaphysical, and its doctrine is the entire negation of the subject as well as the object, teaching that the supreme good, defined by it as the wisdom which releases from transmigration, has no more reality than he who strives to gain it. The commencement of the work is merely a eulogy of Buddha, and of the Bodhisattvas, who form his retinue. Other parts contain narratives of wonderful phenomena connected with the apparition of Buddhist saints, descriptions of the benefits arising from an observance of Buddhist doctrine, or verses in which the Buddha is praised by his disciples. Both on account of the extent to which such episodic topics could easily be expanded, as well as by reason of the amplifications of the real substance of the work, several recensions of the Prājñā Paramitā are in existence. Some of these do not contain more than 7000 slokas, or distichs, but others amount to 18,000, 25,000, or even 100,000 slokas.

PRĀKRIT, prāk'rit (Skt. *prākṛta*, natural, unrefined, vernacular, from *prakṛti*, element, foundation, from *pra*, before + *kar*, to make). The mediæval popular Aryan languages of India, standing chronologically between Sanskrit and the modern Aryan dialects of the peninsula, such as Hindustani, Gujarati, Bengali, and others. While there were doubtless a great number of Prakrit dialects, we have trustworthy information about very few. According to the *Prākṛta-sarvasva* of Markandeya Kavindra, who wrote probably about the middle of the seventeenth century, there were four main divisions of Prakrit, *bhāṣā vibhāṣā*, *apabhraṃśa*, and *pāśāca*. The *bhāṣās*, or languages proper, included Maharashtra, Sauraseni, Pracya, Avanti, and Magadhi. In his view the Ardhamagadhi was a variety of Magadhi somewhat resembling Sauraseni, while Bahliki also differed little from Magadhi. The *vibhāṣās*, or dialects, comprised Śakari, Candali, Śabari, Abhriki, and Śakki, but not, as some native grammarians held, Odri or Dravidi. The *Apabhraṃśas*, or patois, included twenty-seven dialects, all of which were derived from three, Nagara, Vracada, and Upanagara, although it is not improbable that, as a matter of fact, each literary Prakrit, whether *bhāṣā* or *vibhāṣā*, had its patois, or *apabhraṃśa*, beside it. The *pāśācas*, popularly interpreted as demon languages, but probably originally the dialects of the north or west of India, had eleven varieties, derived, according to Markandeya, from three,

Kaikeya, Saurasena, and Pancala. Of all the Prakrits by far the most important was Maharashtra, which is the one implied by the native grammarians when they speak simply of Prakrit. This is the dialect which is employed sometimes in two slightly modified forms called Arsha or Ardhamagadhi, and Jaina Maharashtra, in the sacred texts of Jainism (q.v.). An important source for the great majority of Prakrits, however, is the Indian drama. According to the conventions of Hindu dramaturgy only the principal male characters speak Sanskrit. The lower male and all the female rôles are in various Prakrits, often corrupted in course of time by careless or ignorant scribes and editors. According to a passage in the Sanskrit rhetorical treatise, entitled the *Śāhityadarpaṇa*, noble women employ in dramatic prose Sauraseni, but in verse Maharashtra, courtiers speak Magadhi, ministers and princes Ardhamagadhi, buffoons Pracya, rascals Avanti, gamblers and citizens Dakshinatyā, woodcutters Paisaca, and so on. On the other hand, women of high birth, their friends, courtesans, and celestial nymphs may speak Sanskrit as well as Prakrit. While there is little doubt that such an elaborate division of Prakrits as we find in the drama was artificial, it finds an analogue in the princely retinues of modern India, where many different districts with diverse dialects are represented in one place. It also leads to the inference that Sanskrit was probably not spoken by all classes of people, although it was intelligible to many who were obliged to reply in the vernacular. Prakrit is not derived from classical Sanskrit (see SANSKRIT LANGUAGE), but from a dialect-group closely akin to Vedic Sanskrit. As analogues between Prakrit and Vedic Sanskrit may be cited the change of intervocalic *d* to *l*, as Sanskrit *garuda*, name of a mythical bird, Prakrit *garula*, cf. Sanskrit *idē*, 'I praise,' Vedic Sanskrit *ile*; instrumental plural in *-ehim*, as Prakrit *vacchēhim*, 'with trees,' Vedic *vrksēbhīh*, but classical Sanskrit *vrksūh*, Prakrit *rukha*, 'tree,' Vedic *rukṣa*, not found in classical Sanskrit.

The chief phonological characteristics of Prakrit are the loss of Sanskrit *r*, the shortening of the Sanskrit diphthongs *ē*, *ō* before consonant groups, the frequent elision of intervocalic *k*, *g*, *j*, *l*, *d*, *p*, *b*, *v*, the common change of medial *kh*, *gh*, *th*, *dh*, *bh* to *h*, the change of *n* to *ṇ* throughout, and of *ś* and *ṣ* to *s* or rarely to *h*, and the simplification of consonant-groups.

In morphology the inflection is characterized especially by the growth of *a*-stems at the expense of the *r*- and consonant stems, as Sanskrit *pitar*, 'father,' but Prakrit *piara*, Sanskrit *karmaṇ*, 'deed,' Prakrit *kaṃma*. The old dual is lost excepting in *dō*, *duvē*, *bē*, 'two;' and the genitive assumes the functions of the dative. The pronominal declension is to a very large extent influenced by the nominal, while in all periods of Sanskrit the two systems are kept distinct. In conjugation there is but one system, apart from some scattered forms, as contrasted with the nine present formations in Sanskrit. Verbs are, therefore, conjugated according to the Sanskrit *a*-class, as Sanskrit *varṭati*, 'turns,' Prakrit *vartāi*. Excepting the past participle, the middle voice has almost disappeared. The tense system is extremely meagre, consisting only of present and future. Of the

imperfect, aorist, and perfect some sporadic examples have survived. These tenses are regularly formed in Prakrit by *bhū* and *as*, 'to be,' with participles, as *gaō atthi*, 'is gone,' Sanskrit *jāgāma* (classical Sanskrit also *gatō 'sit*). The moods are the indicative, optative, and imperative, but the subjunctive, as in classical Sanskrit, is lost. As is natural, the dialects differ much from each other in regard to inflection and frequency of forms. Thus the ending of the second person plural present indicative (*-tha* in Sanskrit) is *-ha* in Maharashtri, Jaina Maharashtri, and Ardhamagadhi, *-dha* in Sauraseni and Magadhi, *-hu* in Apabhramśa; the optative is very common in Ardhamagadhi and Jaina Maharashtri, comparatively rare in Maharashtri, and almost never found in the other dialects. As an example of the difference between Prakrit and Sanskrit a stanza in the Maharashtri dialect from the poet Hala may be cited:

Prakrit.

ajja maē tēna viṇā
aṇhūāsukhāi sām̐bharaṇṭiē
ahinaramchāṇa ravō
nisāmīō vajjhapaḍuḥō vva.

Sanskrit.

adya mayā tēna vinā
aṇbhūtasukhāni samsmarantīyā
abhinaramcchāṇam ravō
niśāmītō vadhyapaṭaha iva.

"Lorn of my love to-day—
But blisses gone, remembering:
The heavy thunders fall
Like dooming drums, on me remembering."

Since the Prakrit forms in the literature have been corrupted in countless instances by ignorant or pedantic scribes, the most trustworthy sources are the native grammarians, especially Hemacandra (edited and translated by Pischel, Halle, 1877-80), the most complete, although rather late, dating about the twelfth century. Vararuci (edited and translated by Cowell, London, 1868, again edited by Tailanga, Benares, 1899), the earliest, and Canda (edited by Hoernle, Calcutta, 1880). The Apabhramśa is treated in the *Prakṛtapīṅgalasūtra*, edited with Lakshmināthabhatta's commentary by Sivadatta and Parab (Bombay, 1894). There are also several grammarians whose works exist only in manuscript, and a lexicon by Dhamapāla, entitled *Pāyialacchī Nāmamālā* (edited by Bühler in vol. iv. of Bezzenberger's *Beiträge zur Kunde der indogermanischen Sprachen*, Göttingen, 1878). The literature proper is quite extensive. It includes not only parts of the Sanskrit drama as well as the Jaina texts already mentioned, but also epic and lyric poetry. The former class is represented by two Maharashtri poems. Of these the first is the *Ścūbandha*, or Building of the Bridge, also called *Rāvaṇavaha*, or Death of Ravana, by an unknown author, but frequently erroneously attributed to Kalidasa (q.v.). It was known as early as the seventh century, and deals, as its name implies, with the Rama cycle. (See RAMAYAṆA.) It has been edited and translated by Goldschmidt (Strassburg, 1880-83) and edited with Ramadasa's commentary by Sivadatta and Parab (Bombay, 1895). The second epic is the *Gāūdavaha*, an historical poem by Bappairra (Sanskrit *Vākpātirāja*) about the

beginning of the eighth century. It has been edited with Haripala's commentary and an index by Pandit (Bombay, 1887). The lyric is represented by the *Sattasai*, or Seven Centuries, by Hala who lived probably between the third and seventh centuries, at any rate before 1000. This collection of lyrics, many of which are of much beauty, has been edited and translated by Weber (Leipzig, 1881) and again edited with Gangadharabhatta's commentary by Durgaprasad and Parab (Bombay, 1889). In the drama we have the *Karpūramāñjari* of Rajasekhara (q.v.), edited with Vasudeva's commentary by the same scholars (ib., 1887) and again edited with a masterly English translation by Konow and Lanman (Cambridge, Mass., 1901). Other works were composed in Prakrit, such as the *Bṛhatkathā*, or Great Story, of Guṇadhya, now lost, which formed the basis of Somadeva's *Kathāsaritsāgara*, and was written in Paisaca dialect, while the *Gitagōvinda* of Jayadeva (q.v.) was apparently adapted from an Apabhramśa original.

Consult: Hoefler, *De Prakrita Dialecto* (Berlin, 1836); Lassen, *Institutiones Linguae Praeriticae* (Bonn, 1837); Delius, *Radices Praeriticae* (ib., 1839); Muir, *Original Sanskrit Texts*, vol. ii. (3d ed., London, 1874); Cowell, *Short Introduction to the Ordinary Prakrit of the Sanskrit Dramas* (ib., 1875); Rishikesh Sastri, *Prakrita Grammar* (Calcutta, 1883); Lal Chandra, *Prakrit Grammar* (Benares, 1901); Pischel, *Grammatik der Prakrit-Sprachen* (Strassburg, 1900); Hoernle, "Sketch of the History of Prakrit Philology," in *Calcutta Review*, vol. lxxi. (Calcutta, 1880); Haag, *Vergleichung des Prakrit mit den romanischen Sprachen* (Berlin, 1869); Gray, *Indo-Iranian Phonology* (New York, 1901); Jacobi, *Ausgewählte Erzählungen in Māhārāshtri* (Leipzig, 1886).

PRAKRITI, prā'krē-tē (Skt. *prakṛti*, element, foundation). In Hindu philosophy, potential matter, which must be carefully distinguished from nature, for it exists only conditionally, and develops consciousness only when beheld by Purusha, or Man, who may thus be called the efficient cause of the world as contrasted with its material cause, Prakriti. The union of these two principles gives rise to Buddhi, or perception (also called Mahat, or the great), as well as to Ahankara, or belief in the existence of the ego, and the Tanmatras, or elements of the senses, both in their subjective and objective aspects, to which manas, or perception, is added. Prakriti is uncreated and is coeternal with Brahma (q.v.). Manas, the five Tanmatras, Buddhi, and Prakriti are often called the eight Prakritis, the first seven being productive as well as produced, while the primal Prakriti has the distinctive epithet *aryakta*, or unmanifested. Consult Müller, *Six Systems of Indian Philosophy* (New York, 1899).

PRAM, prām, KRISTEN HENRIKSEN (1756-1821). A Danish poet and editor, born in Norway of Danish parents. He was a man of wide learning and great mental activity. The number of his works, however, is much greater than their value. Of his poems, there need be mentioned only *Emilies Kilde*. His principal work was done for the *Minerva*, a monthly critical journal published in Copenhagen, of which he was one of the founders. He was sole editor

from 1790 until Rahbeh took charge in 1794. His works were edited by Rahbeh (1824-29).

PRAM, or **PRAAM** (Fr. *prame*, Dutch *praam*, Ger. *Prahm*, *Prahme*, from OChurch Slav. *pranŭ*, Pol. *prom*, ferry; ultimately connected with Skt. *par*, to cross, Eng. *fare*). A large flat-bottomed boat or lighter used in the Continental ports of the North Sea and Baltic for loading and unloading merchant ships. It is frequently decked over or roofed over. As late as the early part of the nineteenth century prams were used as armed gunboats for the defense of the smaller ports.

PRANG, LOUIS (1824-). A German-American engraver, lithographer, and publisher. He was born in Breslau, Germany; participated in the Revolutionary movement of 1848; emigrated to the United States in 1850, and settled in Boston, where he became successively a wood engraver (1851), a lithographer (1856), and a publisher (1861), and originated the Prang method of art instruction, publishing the books and material needed for the carrying out of that method. He also became president of the Prang Educational Company, of Boston, and of the Taber-Prang Art Company, of Springfield, Mass. He wrote *The Prang Standard of Color* (1898).

PRASE (Fr. *prase*, leek-green, from Gk. *πράσον* *prason*, leek). A transparent, crystallized, or crypto-crystalline variety of quartz, varying in color from a dull leek to deep green. It is sometimes cut as a gem. Specimens of prase are found on Staten Island, N. Y., and at various other localities in the United States, none of which, however, are of a quality suitable for gems.

PRASLIN, *prá'lán'*, EUGÈNE ANTOINE HORACE, Comte de Choiseul. See CHOISEUL-PRASLIN.

PRATER, *prät'ēr*, THE. The principal park of Vienna (q.v.).

PRATI, *prät'é*, GIOVANNI (1815-84). An Italian poet, born at Dasindo. He studied law at Padua, but gave more attention to poetry than to jurisprudence. His first notable poem was the *Edmenegarda* (1841), a work which shows him under the influence of Romanticism. Going to Milan, he there published the *Canti lirici*, the *Canti pel popolo*, and the *Ballate*, all of which reflect his civic feelings as well as his adherence to the romantic doctrines. At Turin in 1844 he put forth the *Memorie e lacrime* and the *Nuovi canti*. On account of his *Albertismo*, glorifying Charles Albert, he was expelled from Tuscany by order of Guerrazzi, who was then in power, and took refuge in Piedmont. With the change of capital he passed from Turin to Florence and thence to Rome, becoming Counselor of Public Instruction and Senator in 1876. He died at Rome, May 9, 1884. To this latter period of his life belong two collections of verse, the *Psiche* (1875), and the *Iside* (1878), which contains his best lyrics of this time. Consult his *Opere varie* (5 vols., 1875); De Gubernatis, *Ricordi biografici* (Florence, 1873).

PRATINAS (Lat., from *Πρατίνος*). A Greek poet, born in Philus, in the Peloponnesus, who lived in Athens about B.C. 500. According to Suidas, he was a contemporary and rival of Æschylus, and was the first to introduce the satyric drama into Athens. He also wrote tragedies, lyrics, and *hyporchemata*, of which a considerable

and interesting fragment has been preserved by Athenæus (xiv., 617). For the fragments of his lyrics, consult Bergk's *Poetæ Lyrici Græci* (Leipzig, 1843).

PRATO, *prät'ò*, or PRATO IN TOSCANA. A city in the Province of Florence, Italy, situated on the Bisenzio, 11 miles northwest of Florence (Map: Italy, F 4). The city is well built, surrounded by walls, and protected by a citadel. The cathedral, partly Tuscan-Romanesque and partly Gothic, was completed in the fourteenth century. The interior is beautifully decorated with paintings, frescoes and reliefs. The Madonna delle Carceri is a church in the Renaissance style of the fifteenth century. There are several other churches, a town hall with a picture gallery, a music academy, and a library of 25,000 volumes. The city has a gymnasium, a lyceum, and a technical school. The industries are straw-plaiting, and manufactures of woolen and cotton goods, silk thread, biscuits, hats, and machinery. There are also iron and copper works, and productive serpentine quarries. Population (commune), in 1881, 42,190; in 1901, 51,453. Prato was an independent city before it became subject to Florence in the fourteenth century.

PRÄTORIUS, *prä-tò're-us*, MICHAEL (1571-1621). A German composer and writer, born at Kreuzberg. He occupied the position of kapellmeister at Lüneburg, and later was kapellmeister, organist, and secretary to the Duke of Brunswick. With the exception of these facts nothing is known of his life. Among his compositions are: *Musa Sionia*, collection of 1244 vocal numbers in nine parts: *Eulogia Sionia* (1611); 60 motets; *Missodia Sionia* (1611); *Terpsichore* (1612), which included dance pieces by Prätorius and some French composers; *Peuricinium* (1621); 14 church songs; and many anthems, songs, and contrapuntal pieces. His great work, *Syntagma Musicum*, consisting of three volumes. Vol. i. 1615, divided into two parts, is a descriptive and historical work in Latin on ancient and ecclesiastical music, and on ancient musical instruments. Vol. ii., written in German in 1620, is divided into five parts and an appendix. This is beyond question the most valuable extant treatise on contemporary musical instruments, especially the organ. The appendix is devoted to woodcuts of the principal instruments described. Vol. iii. treats in an interesting manner of contemporary secular composition, solmization, and notation. Prätorius was a skillful composer, but is of more value to the musical historian for his erudite treatises. He died at Wolfenbüttel.

PRATT, CHARLES. See CAMDEN, first Earl of.

PRATT, CHARLES (1830-91). An American merchant and philanthropist, born at Watertown, Mass. He removed to New York City in 1851 and began his business career in the oil and petroleum trades. In 1879 he became president of the Board of Trustees of the Adelphi Academy, in Brooklyn, and in 1887 he founded the Pratt Institute (q.v.), in Brooklyn.

PRATT, EXOCH (1808-96). An American philanthropist, born at North Middleborough, Mass. In 1831 he settled in Baltimore, Md., where he soon became prominent in the iron trade, as well as in financial circles. He founded the House of Reformation and Instruction for Colored Children at Cheltenham, Md., and the Mary-

land School for the Deaf and Dumb, at Frederick, and the Pratt Free Library, which he presented to the city of Baltimore and which was opened in 1886.

PRATT, ORSON (1811-81). A Mormon apostle, born at Hartford, N. Y. He received only a common school education, but in later life managed, despite great difficulties, to acquire considerable knowledge, particularly of mathematics. He joined the Mormon Church in 1830, and soon rose high in the organization, becoming one of the Council of Twelve in 1834 and one of the Twelve Apostles in 1835. He was accounted one of the most eloquent preachers in the Church, and made numerous missionary journeys to England and elsewhere. Because of his championship of his faith as a writer and speaker, he became known as the Paul of Mormonism. Pratt was many times a member of the Utah Assembly, and was several times its Speaker. From 1874 until his death he was Church historian and Church recorder. He was also professor of mathematics in the University of Deseret. He discovered in 1854 the "law of planetary rotation," and wrote a number of books on mathematical subjects. His published works include: *Divine Authenticity of the Book of Mormon* (1849); *Great First Cause* (1851); *Cubic and Biquadratic Equations* (1866); *Bible and Polygamy* (1870); *Key to the Universe* (1866).

PRATT, PARLEY PARKER (1807-57). A Mormon apostle, called the Isaiah of his people, brother of Orson Pratt. He was born in Burlington, N. Y., joined the Mormons in 1830, and five years afterwards had risen to the dignity of one of the Twelve Apostles. He worked as a missionary in the East and Middle West; in 1840 was sent to England and at Manchester established the *Millennial Star*; and on his return to America accompanied the party which first visited the valley of the Great Salt Lake, in which Parley's Peak and Parley's Cañon were named for him. After missionary work on the Pacific Coast he set out for the East, but was murdered near Van Buren, Ark. His works include: *Voice of Warning* (1837); *History of the Persecutions in Missouri* (1839); and *Key to the Science of Theology* (1854).

PRATT, SAMUEL JACKSON (1749-1814). An English writer, better known in his day as COURTNEY MELMOTH. His father was a brewer of Saint Ives in Huntingdonshire. The son was ordained in the English Church, but he soon abandoned the pulpit for the stage. For several years he performed with little success in London, the provinces, and Ireland. Pratt published an immense number of books, some of which went through several editions and were translated into French. They comprise verse, travel, criticism, biography, and the drama.

PRATT, SILAS GAMALIEL (1846—). An American composer, born in Addison, Vt. His musical education was obtained under native teachers, until he was 22 years old, when he went to Berlin for advanced work under Bendel and Kullak, and, on a subsequent visit, with Dorn (in score-reading). He organized the Apollo Club of Chicago in 1871. His opera *Zenobia* was given in 1882. In 1890 he was appointed professor of piano in the New York Metropolitan Conservatory. He published a lyric opera, *Lucille* (1887), several symphonies, sym-

phonic suites, songs, and part-songs, many of which have been very successful.

PRATT INSTITUTE. A coeducational school for manual and industrial training, in Brooklyn, N. Y., established in 1887 by Charles Pratt. Besides the high school, which provides a general education, the Institute comprises normal, technical, and trade departments, with a total attendance, in 1902, allowing for duplications, of 3183 (2100 being women), distributed as follows: High school, 262; fine arts, 927; domestic arts, 757; domestic science, 250; science and technology, 611; kindergarden, 166; library, 38; gymnasium, 524. The department of domestic art is especially known for its excellent courses in cooking and sewing. A banking institution, known as the Thrift, is maintained for saving and investment by the students. The Institute conducts both day and evening classes, and as it has a liberal endowment, amounting in 1902 to \$2,383,926, it makes merely nominal charges for tuition. The buildings, which are seven in number, well-equipped with excellent laboratories and museums, were valued in 1902 at \$1,179,473, and the income was \$144,093. The library contains 76,000 volumes. The management is in the hands of a board of five trustees under the presidency of Charles M. Pratt.

PRATZ, PRÄTS, LE PAGE DU (?-1775). A French explorer in America. He was born in the Low Countries, served in the French army, and, about 1718, having acquired an interest in the French Compagnie d'Occident, went to New Orleans. His attempts to found a colony were unsuccessful, but he explored the basins of the Missouri and Arkansas, spending eight years inland. Du Pratz returned to France in 1734. He published *Histoire de la Louisiane* (1758), a work of considerable historic value.

PRAWN (formerly also *praun*, *prane*, probably from Lat. *perna*, sea-mussel, ham). A shrimp-like crustacean of the family Palæmonidae, remarkable for a long serrated beak projecting from the carapace. Many of them are semi-transparent, and exhibit very fine colors; they are also very active creatures, and most interesting inmates of an aquarium, but are excessively voracious, and apt to make great havoc among its other inhabitants. The common European prawn (*Palæmon serratus*) attains a length of three or four inches. It is even more esteemed for the table than the shrimp. Several species of edible prawns occur on the coasts of the United States, but the best known and most abundant of these is *Palæmonetes vulgaris*, which is found among the eel-grass in shallow water from Massachusetts to South Carolina.

PRAXÆAS. A Unitarian schismatic of the end of the second century. He was born in Asia Minor; became an ardent Patripassionist, and an upholder of other anti-trinitarian views; and preached this heresy at Rome, and then in Carthage where Tertullian opposed him in defence of Montanism. Tertullian's attack on Praxeas's monarchism, *Adversus Praxæam* (between 206 and 210), is our only source for his life.

PRAXITÆLES (Lat., from Gk. Πραξιτέλης). A celebrated sculptor of ancient Greece, of whose life little certain is known, except that he was a citizen of Athens, and lived in the fourth century B.C. Pliny gives Olympiad 104 (B.C. 364-361) as his date, and Vitruvius says he worked on the

Mausoleum at Halicarnassus, about B.C. 353. The former date seems connected with the battle of Mantinea, and the activity of Praxiteles, Cephisodotus (q.v.), perhaps an elder brother, and other Athenian artists at this period in the Peloponnesus. There is nothing in the statements about Praxiteles that indicates artistic activity after B.C. 330. His most famous works have perished, and are known to us, if at all, only through Roman copies. The most famous was the Aphrodite of Knidos, which Pliny calls the finest statue in the world. In it the goddess was represented as having just laid aside her clothing to enter the bath; she was naked, but, while conscious of her beauty, showed plainly her reluctance at displaying it even to herself. The only good complete copy is a statue in the Vatican, which has been disfigured for a hundred years or more by a mass of tin drapery about the lower limbs. The best head is in private possession in Berlin. The statue shows how the ideals of the fifth-century art had been modified. The gods and goddesses of this period have lost the superhuman element, and are little more than idealized men and women. Praxiteles himself seems to have avoided the sensuous and weak, but his copyists and imitators were not so fortunate. Another famous statue was the Eros of Thespia, dedicated by the hetera Phryne, the mistress of Praxiteles and the most famous beauty of her time, who was said to have served as a model for the Aphrodite. This statue is by some thought to be the original of the Eros of Centocelli in the Vatican, though this is doubtful. The artist was celebrated for his satyrs, and two very frequent types may with probability be referred to his originals. One is the youthful satyr who pours wine from a pitcher in his raised right hand into a bowl in his left, well represented by the Palermo copy; the other is the resting satyr, best known from the Capitoline statue immortalized by Hawthorne in his "Marble Faun." Another work is one reproduced in the statues which represent the youthful Apollo playfully threatening with an arrow a lizard crawling toward him on a tree-trunk, which must be Praxiteles's Apollo Sauroctonos, or Lizard Slayer. More fortunate than other artists of antiquity, Praxiteles is known to us by one undoubted original, the Hermes of Olympia, which was found May 8, 1877, during the excavation of the Heræum, where it was seen by the traveler Pausanias. The youthful god is here represented as the protector of his baby brother Dionysus. He rests his left elbow on a tree-trunk, over which his cloak is hung, while on the lower arm sits the baby stretching one hand toward some object (probably a bunch of grapes held in the extended right hand of the god). The attitude is easy and the pose graceful, giving opportunity for a variety of contrasting curves, while the technical execution is beyond praise. But the chief beauty of the work is in the wonderful head, which is strong and thoughtful yet full of sensitiveness and delicacy. The lines are finely curved, and in the modeling every part receives equal attention, so that the effect is produced by an infinite number of details, without giving undue prominence to any part, thus contrasting somewhat strongly with the methods of Scopas (q.v.). Another work which makes strong claim to being an original of this artist, and is almost certainly executed from his drawings, is the Basis from Mantinea, where on three slabs is reproduced the

strife of Apollo and Marsyas in presence of the Muses. The figures are in low relief, and full of grace, though without the perfection which characterizes the Hermes. A fine marble bust found at Eleusis is also regarded by many competent judges as the original of a Eubuleus by Praxiteles. It certainly shows strong resemblance to the Satyr and other works of this artist, but the identification cannot be regarded as certain. In addition to the histories of Greek art (q.v.), consult: Furtwängler, *Masterpieces of Greek Sculpture*, trans. by E. Sellers (London and New York, 1895), Klein, *Praxiteles* (Leipzig, 1898), both to be used with caution; Kekulé, *Der Kopf des Praxitelischen Hermes* (Stuttgart, 1881); Amelung, *Die Basis des Praxiteles aus Mantinea* (Munich, 1895).

PRAY, GEORG (1723-1801). An Hungarian scholar and historian, born at Neuhausel. In 1741 he entered the Jesuit Order, subsequently was an instructor in various educational institutions, including the Theresianum at Vienna and academies at Tyrnau and Buda, and was permitted by his superiors to transfer his activities to historical research. Upon the suppression of the Jesuits by Clement XIV. he was appointed royal historiographer of Hungary, and in 1777 custodian of the library of the University of Buda (removed in 1784 to Pesth). He also received otherwise from the Crown assistance and distinctions. He is to be ranked with Stephen Katona (1732-1811), also a Jesuit, as a founder of scientific Hungarian history. His publications, strongly patriotic in tone, include *Annales Veteres Hunnorum, Avarorum et Hungarorum* (1761), *Annales Regum Hungariæ* (1764-70), and *Specimen Hierarchæ Hungariæ* (1776-79).

PRAY, ISAAC CLARK (1813-69). An American journalist, playwright, and actor. He was born in Boston and graduated at Amherst College in 1833. He began newspaper work in his native city, but shortly afterwards produced in New York his plays of *Giulietta Gordon* and *The Old Clock*, the latter based on a story of his own. In England, in 1846, he appeared as an actor in *Hamlet* and *Othello*. In 1850 he became dramatic critic for the New York *Herald*, and later for a time he edited the Philadelphia *Inquirer*. He also engaged successfully in theatrical management, besides being the author of *Virginus* and other plays. Among his works are *Prose and Verse* (1836), *Poems* (1837), *Book of the Drama* (1851), and *Memoirs of James Gordon Bennett* (1855).

PRAYER (OF. *priere*, Fr. *prière*, from ML. *precaria*, prayer, from Lat. *precar*, to entreat; connected with OChurch Slav. *prositi*, Skt. *prach*, to ask, Goth. *frah*, I asked, OHG. *frāgen*, Ger. *fragen*, AS. *frigan*, prov. Eng. *frain*, to ask). In its broadest sense, a verbal address made to a spiritual being. Such a communication usually embodies a petition, but may also contain confession, apology, thanksgiving, tidings, explanation, or meditation. From the point of view of comparative religion the main characteristics of prayer may be arranged under several heads. (1) *Universality*.—It would seem that the act of prayer must be as general as belief in spirits, that is to say common to humanity, but this view has been contested. Lubbock maintained that lower forms of religion are almost independent of prayer, which, in his opinion, involves a belief

in the divine goodness. He cited statements made by Park and Livingstone in relation to Africans, who were not inclined to offer petition to the deity, considering him too exalted to listen to human appeals. Other travelers have given similar reports concerning Bushmen, Eskimo, and other tribes. The African observers, however, seem to have had in mind habitual worship of a nature similar to that practiced by Christians and Mohammedans; at any rate, later writers have given abundant testimony to the frequency of prayer in heathen Africa. As to the greater deities, it is frequently held that they are inaccessible to ordinary persons, but should be addressed through the medium of an intercessor. Minor gods, on the other hand, are open to appeal from any quarter. Prayer is offered also to the departed souls of the family, who are supposed to exercise a sort of guardianship over their kindred. In all lands, probably, hunters and fishermen entreat the particular patron of their craft, or the spirit which resides in the fetish they carry. Thus, African boatmen, while crossing a river, offer prayer to a crocodile as a divine being. In Australia also it is said that any person whosever may approach the abode of a spirit, to whom is addressed information and advice, on which the latter is expected to act. From such testimonies it may be inferred that prayer, in a wide sense, is universal, and that supposition of its absence has arisen from prejudice, misunderstanding, or limitation of the practice to one familiar type. (2) *Ethical Character.*—The view is frequently maintained that in lower stages of culture prayer is quite unethical, and that only at higher levels does it encourage virtue and restrict vice. It is indeed true that prayers of savages are usually direct and simple requests for temporal blessings, and it is thought to be only in early civilizations that we begin to find repentance for sins committed. Yet it may be doubted whether the beginnings of ethical prayer are not to be found in a much earlier social state. It is at any rate certain that petitions of barbarians are by no means prompted simply by selfish considerations, but, on the contrary, that these also are inspired by affection, sentiment, and sense of natural and spiritual beauty. Among American Indians, for instance, ceremonial prayers are full of poetry, feeling for nature, and desire for communion with the gods. (3) *Imprecation.*—As prayer is employed in order to obtain benefits for the pleader, so by a natural antithesis it is used to injure enemies, on whom it invokes the divine anger. This function of cursing is as ancient and universal as that of blessing. It is the regular business of shamans and medicine men to bring disaster on foes, cause their injury and death, blight their crops, and destroy their armies. In the same manner prayer is employed to undo the evil spirits, as in old Babylonian exorcistic formulas. (4) *Formalism.*—In parts of Africa prayers addressed to the gods are not in any stereotyped form, but worshipers ask for what they desire in natural language, with a certain amount of added adulation, just as they might prefer a petition to a chief. Here prayer has not reached that stage of development in which it is always offered in certain formulas, which, becoming traditional, are after a time believed to possess some peculiar efficacy of themselves, and to be as it were incantations or charms. Yet it is likely that even in the most

savage religions this process has already begun, and that prescribed or traditional prayers are everywhere to be found. (5) *Posture.*—The attitude and gesture of prayer are conventional, and have greatly varied. The principles seem to be two: first, the closest possible contact with the being addressed; secondly, the adoption of such position as is considered to belong to a suppliant. The belief that the divine being resides in the firmament, widely spread in all periods and conditions of culture, often causes the worshiper to raise eyes and hands toward heaven. This practice was common in ancient Greece; but the posture was affected by circumstances. In supplication at the altar, the hands might be made to touch the sacred relics or images; if the appeal was made to the powers below, the hands might be placed on the earth; the suppliant might embrace the knees of the statue, in the prescribed attitude of entreaty. The Roman veiled his head, either as a symbol of concentration, or for the purpose of shutting out ill-omened sights and sounds; he might bow the body or prostrate himself. Lifted hands, prostration, or kneeling, and covered head were also the attitude of prayer among the Jews. A common mediæval position was kneeling with palms joined and hands extended; the folding of hands seems to have been of more recent adoption.

In the Christian sense, prayer is any voluntary expression of communion with God, whether formal or informal, brief or prolonged, individual or collective. Adoration, thanksgiving, confession, intercession, are all joined with petition in Christian prayer. It is fundamental that the praying Christian must be perfectly submitted to the will of God and desirous of finding more completely what is its application to his own conduct and affairs. His petitions may then embrace the supply of all his wants, physical and spiritual; and he may be sure that he will be heard and answered as God's infinite wisdom shall see best for him and all concerned in his welfare.

Prayer being regarded by Christians as an ordinance of God, it follows that they must seek to be guided in prayer by the rules of His revealed will, in so far as His will has been revealed. It is therefore held by Christians in general, in accordance with their doctrine of the atonement (q.v.) and of the intercession of Jesus Christ (see INTERCESSION, DOCTRINE OF), that the only true way of access to God is through the mediation of Jesus Christ, and that prayer must be made in the exercise of faith in Him, the worshiper taking his stand upon the ground of the obedience or "finished work and accepted sacrifice" of Christ, and looking up to Christ as now interceding in heaven. It is also held, in accordance with the doctrine of man's corruption, that prayer can be truly made, in faith, and for things agreeable to God's will, only by the help of the Holy Spirit.

The best discussions of prayer from the Christian standpoint will be found in the treatises on systematic theology and apologetics. The following works may also be consulted: Bickersteth, *A Treatise on Prayer* (18th ed., London, 1853); Liddon, *Some Elements of Religion* (London, 1873); Clarke, *The Christian Doctrine of Prayer* (Boston, 1874); Monrad, *The World of Prayer* (Eng. trans., Edinburgh, 1879). For modern objections to prayer, consult: Tyndall, *On*

Prayer (New York, 1874); Romanes, *Christian Prayer and General Law* (London, 1874).

PRAYER, WEEK OF. A season marked by special devotional meetings among Christians of many denominations throughout the world at the beginning of each new year. It originated in the Presbyterian mission of Lodiana, India, in 1858. Reports of the remarkable religious awakening in the United States the year before having reached India (see REVIVALS, RELIGIOUS), the members of this mission, at their annual meeting in November, issued an invitation for a universal concert of prayer, to be held yearly, beginning with the first week in January, 1860. The request met with a hearty response, and the week of prayer has been regularly observed ever since.

PRAYER-BOOK, COMMON. The name commonly given to the service-books used in public worship by the churches of the Anglican communion, designated on the title page as "The Book of Common Prayer, and Administration of the Sacraments, and other Rites and Ceremonies of the Church." As the only official liturgical book of these churches, it thus contains in small compass all that was left by the reformers of what in the Roman Catholic Church is spread out into the missal, breviary, pontifical, and ritual. The purpose of the compilers was explicitly, in addition to substituting English for Latin and removing all that they considered 'superstitious or ungodly' in the pre-Reformation books, to simplify and abridge the service so that the laity might take an intelligent part in it. The process began in the reign of Henry VIII., but the earliest complete book was that published in 1549, and known as the first prayer-book of Edward VI. It was drawn up with great prudence, altering as little as possible what had been familiar to the people. This book was compiled by Cranmer and Ridley, assisted by eleven other divines, and revised by Convocation. The matins, lauds, and prime of the breviary were combined into the "order for morning prayer," while the evening prayer was made up from vespers and compline. The communion service was largely based on the old English missals, especially that of Salisbury, which had been the one most used. The ordination services were added in 1550.

The influence of the more radical and especially the Continental reformers (such as Bucer and Peter Martyr) was exerted in favor of a more thorough-going change, and a revised book, the second prayer-book of Edward VI., appeared in 1552, marking the furthest point of departure from the older ways. Many of the ancient ceremonies which had been retained in the first book were now omitted; the surplice for priests and deacons, and the rochet for bishops, were prescribed as the authorized vestments, whereas it is to the standard of the first book that the ritualistic party in modern times appeals for sanction (see ORNAMENTS RUBRIC, THE); prayers for the dead were omitted, and the formula used in the communion of the people was made to satisfy a Virtualist or even a Zwinglian view of the sacrament. (See LORD'S SUPPER.) In 1559, however, under Elizabeth, who had little sympathy with the extreme and aggressive reformers, such changes as were made were in the nature of a return to the first book; and some further

changes made by James I. in 1604, after the Hampton Court Conference, had a not dissimilar bearing. After the use of the prayer-book had been absolutely prohibited by law under the Commonwealth, and restored with the monarchy, the question of revision came up once more, and was discussed in the lengthy sittings of the Savoy Conference; but such changes as were made in 1662, when the English book practically assumed its final form, were not of a nature to conciliate the defeated Puritans. An attempt to reopen the matter with this end in view was made in 1689, after the Revolution, but nothing came of it except the report of a commission. In Scotland the Episcopal Church uses the English book, with the exception of a permissive use, under certain circumstances, of a different communion office, based upon Laud's proposed book for Scotland. The disestablished Church of Ireland made a thorough revision in 1878, in a more strongly Protestant sense than any other of the current books.

The history of the American Book of Common Prayer has distinct and interesting features of its own. When the separate Episcopal Church in the United States was organized, a book was compiled in 1783, now known as 'the Proposed Book,' which had only a qualified and informal acceptance. The changes of this book were too sweeping to commend themselves to the temper of that day, though several important ones were adopted at the recent revision. The book actually adopted by the General Convention of 1789 disclaims in its preface the intention of departing from the Church of England in any essential point of doctrine, discipline, or worship. Its variations, accordingly, are chiefly those required by local circumstances or made for the purpose of removing archaisms in the language, though more serious things were either done or contemplated, as in the omission of the Athanasian Creed. The influence of the Scottish bishops from whom Seabury obtained his consecration was felt in the restoration, following their own use, of the invocation of the Holy Ghost in the central prayer of the eucharistic office, after primitive models. In the middle of the nineteenth century the far-seeing Dr. Muhlenberg made a plea for liturgical flexibility and enrichment, which was taken up thirty years later and carried to a successful conclusion in regard to both of these advantages. Minute, careful, and deliberate processes of revision, lasting over nine years, resulted in the publication in 1892 of a prayer-book which probably will remain materially unchanged for many a year. While both flexibility of use and enrichment by the addition of liturgical forms were sought, a return to a nearer approach to conformity with the English book was a natural outcome of the increasingly close and friendly relations between the mother and daughter churches. Consult: Maskell, *The Ancient Liturgy of the Church of England* (3d ed., London, 1882); Blunt, *Annotated Book of Common Prayer* (ib., 1892); Procter, *History of the Book of Common Prayer* (ib., 1855); Luecock, *Studies in the History of the Book of Common Prayer* (ib., 1881); Gasquet and Bishop, *Edward VI. and the Book of Common Prayer* (ib., 1890); Barry, *Teacher's Prayer-Book* (ib., 1884); Huntington, *Short History of the Book of Common Prayer* (New York, 1893), specially full on the American revisions; Dix,

Lectures on the First Prayer-Book of Edward VI. (ib., 1881).

PRAYER FOR THE DEAD. The practice which prevails in the Roman Catholic, Greek, and other Oriental churches of praying for the souls of the deceased with the intention and expectation of obtaining for them an alleviation of their sufferings after death, because of venial sins, or of the penalty of mortal sins, remitted but not fully atoned for during life. The doctrine of purgatory, or a middle state of purgation after death before the soul can enter heaven, naturally gives rise to the practice of prayer for the dead, though there are those who pray for the dead, yet do not explicitly accept the doctrine of purgatory. The two doctrines are, however, closely connected, especially in conjunction with the related doctrine of the communion of saints. (See SAINTS.) A belief in the efficacy of prayer for the dead existed in practically all of the ancient religions, especially those of Egypt, India, and China. The existence of this belief, implicit, if not explicit, affords the only rational explanation of many of the practices of the Greeks and Latins with regard to their dead. Among the Jews the custom of prayer for the dead is attested by the well-known text in II. Maccabees xii. 44, 45, that it is "a holy and wholesome thought to pray for the dead that they may be loosed from their sins." The practice of prayer for the dead is equally recognizable in the early Christian Church. The parable of Lazarus and the rich man evidently portrays a definite belief in the inter-communion of this earth with the world beyond the grave. The Fathers of the first centuries, Clement of Alexandria, Tertullian, Saint Cyprian, and especially Saint John Chrysostom, Saint Cyril of Jerusalem, and Saint Augustine, frequently allude to prayers for the dead. The Liturgies of all the rites without exception contain such prayers. Prayer for the dead has been a constant tradition of the Roman Catholic and Eastern churches. The Protestant churches, with some exceptions, have repudiated the practice. Prayers for the dead were not forbidden in the English Church, and there is an almost unbroken tradition of ecclesiastical authorities, including such names as Andrewes, Barrow, Ken, Wesley, and Keble, who approved of it. Consult: Luckock, *After Death* (ib., 1879); Plumtree, *The Spirits in Prison* (ib., 1884); Mumford, *Two Ancient Treatises on Purgatory* (New York, 1894).

PRAYING INSECT, or MANTIS. See MANTIS.

PREACHING FRIARS. See DOMINICANS.

PRE-ADAMITES. Supposed inhabitants of the earth anterior to Adam. The term is applied particularly to a theory advanced by Isaac de la Peyrère (better known by his Latinized name *Pererius*), which he attempted to prove from the Bible. Peyrère was born of a Calvinist family of Bordeaux in 1594, and was attached to the service of the Prince of Condé. His theory was first made public in Paris in 1655, in the form of a commentary on Romans v. 12-14 entitled *Præadamitæ*. The same year he published the first part of a formal treatise on the pre-Adamite hypothesis, and the theological consequences to be derived therefrom, entitled *Systema Theologicum ex Præadamitarum Hypothesi*. According to his hypothesis Adam was the progen-

itor of the Jewish race only, and it is only of him and his race that the Bible is designed to supply the history. Other races existed on earth before that of Adam; but of them the Bible contains no record, nor did the Mosaic law regard them or impose any obligation upon them. It was only under the gospel that they began to be comprehended in the law, which through Christ was given to all the human races of the earth; and it is in this sense that sin is said (Rom. v. 13) to "have been in the world until the law," but not to have been "imputed when the law was not." For the pre-Adamite race, as the law was not, there was no *legal* offense. The only evil which Peyrère recognized was natural evil. The same limited interpretation he extended to most other details of the Mosaic history. Thus he regarded the deluge as partial, being confined only to the Adamite race. Other miraculous narratives of the Pentateuch and even of other books he restricted similarly.

As his book was published in the Low Countries, he fell under the animadversion of the Inquisition, and eventually was arrested in the diocese of Mechlin, but was released at the instance of the Prince de Condé. He afterwards went to Rome, where he conformed to the Roman Catholic Church, and made a full retraction of his erroneous opinions (*Epistola ad Philotimum*, Rome, 1657). He was offered preferment by the Pope, Alexander VII., but returned in preference to Paris, where he entered the Seminary of Notre Dame des Vertus, in which he resided till his death in 1676. For a modern discussion of this theme, consult Winchell, *Preadamites* (Boston, 1880).

PRÉAULT, præ'ò, AUGUSTE (1809-79). A French sculptor, born in Paris. He was a pupil of David d'Angers and an ardent admirer of the Romantic School. For fifteen years both Salons were closed against his sculpture, because of his defense of these principles. His works include "Clemence Isaure," "Jacques Cœur," "Ophelia," a bronze bas relief, and several statues and funeral monuments in the Paris churches and cemeteries.

PRÉ AUX CLERCS, præ ó klärk, LE. A large plain once extending to the gates of Paris, northeast of the Abbey of Saint Germain des Prés, on the left bank of the Seine, so called because in the Middle Ages it was a resort of the students of the university. The part owned by the abbey attracted students by being nearer, and riots with the monks resulted in legislation by which it was ceded to the university in 1368. Later it was a resort of fashion and duellists. It is now covered by the Faubourg Saint Germain.

PREB'END (ML. *præbenda*, prebend, allowance of food and drink, fem. sg. or neu. pl. of Lat. *præbendus*, gerundive of *præbere*, *præhibere*, to offer, from *præ*, before + *habere*, to have). Originally, a portion of food, clothing, or money allowed to a monk or other cleric out of the revenues of a cathedral or collegiate church. After the organization of chapters of canons for the maintenance of the daily services in the Bishop's church, endowments came to be made for their support, the canons usually living in common. When, about the eleventh century, canons ceased to live in common, each received a share of the revenues of the cathedral, called a prebend. At the present time in the Church of England all

prebendaries in residence are by law styled canons, but the holders of disendowed prebendal stalls are still known as prebendaries.

PREBLE, prēb'l, EDWARD (1761-1807). An American naval officer. He was born in Portland, Me., ran away from home in 1777, joined a privateer, and soon afterwards entered the Massachusetts marine as a midshipman on board the *Protector*. In 1779 he was captured and imprisoned on the prison-ship *Jersey* in New York harbor; but was soon released, and until the close of the war served on the *Winthrop*. While attached to this vessel, he boarded with only 14 men a British brig in Penobscot harbor, Maine, and took her out in the face of a battery. When the United States Navy was organized, in 1798, he was one of the first to be commissioned as lieutenant, and in 1799 was promoted to the rank of captain. In the same year, while in command of the *Essex*, he convoyed from Batavia a fleet of merchant vessels. In May, 1803, he was put in command of the squadron fitted out against the Barbary Powers. Arriving off Tangiers in October, he forced the Sultan of Morocco to renew the treaty of 1786 (see BARBARY POWERS, WARS WITH THE), and then cruised for some time in the vicinity of Tripoli, which port he kept closely blockaded for several months. On July 25, 1804, his fleet then consisting of a frigate, three brigs, three schooners, two bomb-vessels, and six gun-boats, he attacked the defenses of Tripoli and the Tripolitan fleet with great vigor, captured three gun-boats, and sank three more. In five subsequent attacks on August 3d, August 7th, August 24th, August 29th, and September 3d, he inflicted considerable damage with small loss to himself, but on September 10th was superseded in his command by Commodore Samuel Barron, who soon concluded a satisfactory treaty of peace with the Pasha. Returning to the United States, Preble received a medal and a vote of thanks from Congress, and in 1806 was urged by President Jefferson to enter the Cabinet as Secretary of the Navy, but declined on account of failing health, and in 1807 died of consumption at Portland.

PREBLE, GEORGE HENRY (1816-85). An American naval officer, born at Portland, Me. He entered the United States Navy as a midshipman in 1835, and during the war with Mexico participated in the operations along the Gulf coast of that country. In 1853 he was assigned to the *Macedonian*, one of the fleet with which Commodore Matthew C. Perry made his visit to Japan, and while in the Far East he was sent on an expedition to punish the Chinese pirates. During the early part of 1862 he commanded the gun-boat *Katahdin* and participated in Farragut's operations against New Orleans. He was promoted to the rank of commander in July, 1862, and while he was commanding the *Oucida* off Mobile his blockade was broken by the Confederate cruiser *Oreto* or *Florida*. For this he was dismissed from the service until it was learned that the *Florida* owed her escape solely to her superior speed. Preble was then reinstated. He commanded the *Saint Louis* in European waters during the greater part of 1863 and 1864, was then ordered home, and was placed in command of the fleet brigade which coöperated with General Sherman's army. He was chief of staff of the North Pacific Squadron in 1868-70, commandant of the

Philadelphia navy yard in 1873-75, and commanding officer of the South Pacific Station in 1877-78. In 1876 he was promoted to the rank of rear-admiral, and two years later retired from the service. In the latter part of his life he devoted considerable attention to historical subjects, contributed frequently to the *New England Historical and Genealogical Register* and to the *United Service Magazine*, and published: *A History of the Flag of the United States of America and of the Naval and Yacht Club Signals, Seals, and Arms, and the Principal National Songs of the United States* (1880); and *A Chronological History of the Origin and Development of Steam Navigation* (1883).

PRE-CAMBRIAN FORMATIONS. A term usually applied to all formations which are older than those containing the Olenellus fauna of the Cambrian period. The reason for applying such a general name to this series of rocks is that the Pre-Cambrian strata are often so highly metamorphosed, and devoid of organic remains, that their stratigraphic relations are indistinct, and it is therefore impossible to assign them an exact position in the geologic scale.

The Pre-Cambrian rocks consist in general of: (1) A great series of more or less highly metamorphosed igneous and sedimentary strata, such as gneisses, schists, slates, quartzites, crystalline limestones, etc.; (2) igneous rocks but slightly altered; (3) recognizable sedimentary rocks, which in rare cases contain fossils. In addition to the intense metamorphism which some of these rocks have undergone, they are often interfolded and much broken by faults. The mere fact that rocks are highly metamorphosed, however, does not determine them to be of Pre-Cambrian age, for such changes have sometimes taken place in rocks of much later date, as in the Devonian and Carboniferous.

The length of time occupied by the Pre-Cambrian periods must always be largely a matter of speculation, but geologically it extended from the time of formation of a solid crust up to the beginning of the Cambrian. Judging from the variety of forms that are found developed in as early a period as the Cambrian, and the length of time that has been required to develop the present fauna and flora found on the earth, the length of Pre-Cambrian time must have undoubtedly been very great. The highly altered character of the Pre-Cambrian rocks has unfortunately obliterated many fossil remains that were buried in the sedimentary strata, and it is only in the younger members of the series that distinct fossils have been found. Such traces have been discovered at several localities, notably in Newfoundland, Canada, the Lake Superior district, the Grand Cañon of the Colorado, and in Great Britain. The Pre-Cambrian rocks are at the present time divided into a lower system—the Archæan and an upper system termed the Algonkian. The former is sometimes also termed the basement or fundamental complex, and consists of igneous and highly metamorphosed rocks, so altered that their original condition is a matter of great uncertainty. Under the Algonkian are included the younger Pre-Cambrian rocks, which can usually be identified as sedimentary, although igneous intrusions also took place in this period. An earlier classification grouped all the Pre-Cambrian rocks as Archæan, subdividing them into a lower series called the Laurentian.

and an upper series, the Huronian, which corresponds to the present Algonkian.

The Pre-Cambrian rocks are widely distributed and form a series of disconnected areas, some of them of considerable extent. Their exposure at the surface may be due to their having remained uncovered since early geologic times, or because the overlying sediments and other rocks of later date have been worn away. The more important Pre-Cambrian areas found in North America are the following: (1) Laurentian area of Canada, consisting of a basement complex or Archaean system known as the Ottawa gneiss, which grades up into the Grenville series of Algonkian age. (2) The Hastings district southwest of Ottawa. (3) The original Huronian area bordering the north channel of Lake Huron and extending west to Lake Superior. Both the Archaean and Algonkian are recognizable here, the latter being subdivided into an upper and lower Huronian. (4) Adirondaek area of eastern New York. (5) The Lake Superior region. Probably a greater amount of work has been done in this area than any other of Pre-Cambrian age and the stratigraphic details have been most carefully worked out. (6) Eastern United States; a belt extending from Maine through New Hampshire, Massachusetts, Connecticut, New York, New Jersey, Pennsylvania, Maryland, Georgia, North Carolina to Alabama, and consisting of a complex series of semi-crystalline and holocrystalline rocks. (7) Black Hills area. (8) Southeast Missouri area. (9) Central Texas. (10) Scattered areas in the Cordilleran region. Pre-Cambrian rocks are also known in Great Britain, Scandinavia, Central Europe, China, India, and Australasia.

The Pre-Cambrian rocks are rich in mineral deposits. Almost inexhaustible supplies of iron ore are found in the Lake Superior region, and important deposits of the same metal are known in New York and New Jersey. Many valuable quarries of building stone are located within the Pre-Cambrian areas, while the other economic minerals include graphite, garnet, apatite, talc, emery, feldspar, gold, copper, and nickel.

BIBLIOGRAPHY. Van Hise, "Principles of Pre-Cambrian North American Geology," *Sixteenth Annual Report United States Geological Survey* (Washington, 1896); Geikie, *Text-Book of Geology* (London, 1893); Van Hise, "The Iron Ore Deposits of the Lake Superior Region," *Twenty-first Annual Report United States Geological Survey* (Washington, 1901); Adams, "On the Typical Laurentian Area of Canada," *Journal of Geology* (Chicago, 1893); Adams, "Origin and Relations of the Grenville and Hastings series in the Canadian Laurentian," *American Journal of Science*, 4th series, vol. iii. (New Haven, 1897); Matthew, "The Effusive and Dike Rocks Near Saint John, New Brunswick," *New York Academy of Sciences Transactions*, vol. xiv. (New York, 1895); Kemp, "Pre-Cambrian Sediments in the Adirondaeks," *Science*, vol. xii. (ib., 1900); Kemp, "Crystalline Limestones, Opheleites, and Associated Schists of the Eastern Adirondaeks," *Geological Society of America Bulletin*, vol. vi. (Rochester, 1895); Van Hise, "Correlation Papers. Archaean and Algonkian," *United States Geological Survey, Bulletin No. 86* (Washington, 1892); Leith, "Reviews of Pre-Cambrian Literature," *Journal of Geology*, from vol. i. to date

(Chicago). See ARCHÆAN SYSTEM; ALGONKIAN SYSTEM; LAURENTIAN SYSTEM; etc.

PRECEDENCE (ML. *præcedentia*, from Lat. *præcedere*, to go before, from *præ*, before + *cedere*, to go, yield; connected with *cadere*, Skt. *śad*, to fall). The order in which individuals are entitled to follow one another in a state procession or on other public occasions. In former days questions of this sort were considered of great importance; thus the memoirs of Saint-Simon are largely occupied with minute histories of acrid controversies on these points. In modern times, with the gradual diminution of court ceremonial, less interest attaches to them; but they are still minutely regulated in some countries, either by statute law, by royal letters patent, or by ancient usage. The order of precedence among different countries is in modern practice reduced, as in the signing of treaties by several powers, to the alphabetical order of their names. Precedence among the diplomatic representatives accredited to any government depends upon the date of the presentation of their credentials, ambassadors, however, ranking envoys and ministers plenipotentiary. Precedence involves the right to be presented, or to pass into a room, first; but in processions, especially those of ecclesiastical dignitaries, the persons of highest rank regularly come last.

In the United States the only positive precedence is that given by official position; and in the settling of uncertain questions arising under this system, there is no final authority, different administrations having acted in different ways. The position of foreign ambassadors, for example, is questionable. It has been claimed for them that as the personal representatives of sovereign powers, accredited to the Executive, they should come next to the President, and before the Vice-President, who is only, so to speak, an heir apparent. There has been no official settlement of the question. It is also contended by some that the Governors of sovereign States of the Union should precede the General of the Army and the Admiral of the Navy, who are officers subordinate to the Federal Executive. A question has also been raised as to the position to be assigned to a United States ambassador when on leave at home. He is the personal representative of the Federal Government, and it may be held that he should have higher rank than the General of the Army or Admiral of the Navy. Great uncertainty, however, has prevailed in the usage of Washington on similar points. The most generally accepted order of official precedence at the national capital is as follows:

The President; the Vice-President and President of the Senate; Ambassadors in their order; the Chief Justice of the United States; Senators; the Speaker of the House; Representatives in Congress; Associate Justices of the Supreme Court; the Secretary of State, members of the diplomatic corps other than ambassadors, and foreign members of international commissions; the Secretary of the Treasury; the Secretary of War; the Attorney-General; the Postmaster-General; the Secretary of the Navy; the Secretary of the Interior; the Secretary of Agriculture; the Secretary of Commerce and Labor; the General of the Army and the Admiral of the Navy; the Governors of States; the Chief Justice and Associates of the Court of Claims; Circuit

and District Judges of the United States; the Justices and Associates of Territories and District of Columbia; the Lieutenant-General and the Vice-Admiral; diplomatic representatives of the United States; major-generals, rear-admirals, and staff officers of equal rank; brigadier-generals and commodores; chiefs of quasi-independent civil bureaus; chiefs of departmental bureaus in the order of their chief officers. Colonels, captains of the navy, staff officers of equal rank, the Colonel of the Marine Corps; Consuls-General and consuls of foreign governments, according to date of exequatur, and the same of the United States, according to seniority of service; lieutenant-colonels and majors of the army, commanders and lieutenant-commanders of the navy, and staff-officers of equal rank; the Commissioners of the District of Columbia, Governors of Territories, Lieutenant-Governors, and other elective State officers in their accepted order at home; captains, first lieutenants and second lieutenants of the army, lieutenants, masters, and ensigns of the navy, and staff officers of equal rank; assistant secretaries of executive departments, secretaries of legations, secretaries of the Senate and House of Representatives; and the clerk of the Supreme Court.

For the full table of precedence in England, consult any peerage; for that of Germany, Stillfried, *Ceremonialbuch des preussischen Hofes* (Berlin, 1878); for the older Continental usage, Hellbach, *Handbuch des Rangrechts* (Ansbach, 1804).

PRECEDENT (from Lat. *præcedens*, pres. part. of *præcedere*, to go before). In a general sense, any act or determination which is taken as a guide to action under similar circumstances thereafter, as personal habits are precedents automatically followed, and social and legal customs are precedents which have, by long observance, acquired the sanction of moral or civil law.

In its technical legal sense the term precedent has come to be employed to designate (a) the settled practice of the bar and (b) the judicial determination of questions of law by the courts. The popular expression 'forms and precedents' points to the former use of the word, as in the forms of pleading and the forms employed in conveyancing, which have acquired commanding authority in the legal profession, and are implicitly followed by successive generations of lawyers, until changed by statutory authority, only because of a long continued exact observance.

Of a different character is the judicial precedent. This has intrinsic authority and exerts a more or less binding force from the hour of its promulgation. It is not, as is generally believed, peculiar to the common-law system of England and the United States, but is essential to the administration of every legal system. Indeed, it is involved in the very conception of law as a *rule* of conduct that the same acts shall produce the same legal consequences, that the same combination of circumstances, however often it may arise, shall invariably be dealt with in the same way.

In this respect, however, the difference between our system and that which obtains under the civil-law system is that we have given a narrower range and at the same time a more conclusive authority to precedent. The common law denies the effect of precedent to legal writ-

ings, with the exception of a few texts of great antiquity (as Littleton and Coke), as well as to the unofficial expressions of legal opinion by eminent lawyers and judges, restricting it to judicial opinions officially delivered: while, on the other hand, it regards such decisions as of binding force, and not, as under the civil law, of merely persuasive authority. See **DICTUM**; **LAW**; **CIVIL LAW**; **CONSTITUTIONAL LAW**; etc. Consult: Wambaugh, *The Study of Cases* (Boston, 1894); Blackstone, *Commentaries*.

PRECENTOR (Lat. *præcentor*, leader in music, from *præcincere*, to sing before, from *præ*, before + *cincere*, to sing). The official in a chapter, whether cathedral or collegiate, whose duty it was to lead the singing. He commenced the psalm or hymn which was taken up and repeated either by the celebrant or another of the body, or by the rest of the choir. In modern chapters, the precentor ranks next in dignity to the provost or dean. He generally has charge of training the choir, and of the selection of the music. Among the non-episcopal bodies the precentor is the person who starts and conducts the singing, and who generally stands in front of the pulpit, sometimes at one side of it.

PRECEPT (Lat. *præceptum*, rule, doctrine, maxim, precept, neu. sg. of *præceptus*, p.p. of *præcipere*, to instruct, admonish, take beforehand, from *præ*, before + *capere*, to take). In law, a command or mandate in writing, directed to a sheriff or other ministerial officer, and constituting his authority to do the act named therein. It is generally considered as synonymous with the word process.

In Scotch law, a 'precept of sasine' is an order of a superior to an agent or public officer, as a notary public, to give possession of lands to an under-tenant or vassal. A 'precept of *clare constat*' (literally, 'it is clearly established'), in Scotland, was a deed by which a superior acknowledged the right of an heir of a deceased vassal to succeed to the lands of his father. By statute this is no longer necessary.

PRECEPTORY (ML. *præceptorius*, relating to instruction, from Lat. *præceptor*, instructor, from *præcipere*, to instruct, admonish, take beforehand). The name given to certain houses of the Knights Templars, the superiors of which were called knights preceptors. All the preceptories of a province were subject to a provincial superior, called grand preceptor; and there were three of these who held rank above all the rest, the Grand Preceptors of Jerusalem, Tripolis, and Antioch. Other houses of the Order were called 'commanderies.' See **TEMPLARS**.

PRECESSION (ML. *præcessio*, advance, precedence, from Lat. *præcedere*, to go before). The points in which the equator intersects the ecliptic, called the equinoctial points, do not remain stationary, but retrograde slowly, i. e. move from east to west. This motion is called the precession of the equinoxes (q.v.). The word 'precession' is used because if on one day one of the equinoctial points arrive at the meridian of a place simultaneously with a fixed star, it will next day arrive at the meridian sooner than the star, or will *precede* it in transit. The amount of this movement is about 50" each year, and the equinoctial points will therefore require 25,800 years to make a complete circuit

in the heavens. This movement of the equinoxes also explains the want of coincidence between the signs of the zodiac and those of the ecliptic. See **ARIES**.

If the earth were truly spherical and homogeneous; or if it were composed of spherical layers each of uniform density; or, more generally, if it were such that the resultant of the gravitational attractions exerted on all its parts by any other body should always pass through a single definite point in its mass, its diurnal rotation would not be affected by the attractions of any other bodies. If originally rotating about a principal axis of inertia, it would forever revolve about it, and the direction of the axis would remain fixed in space. To put this in more popular language, the pole star (q.v.) would always be the same star. But, although the earth rotates about an axis almost exactly coinciding with its axis of figure, the attraction of various bodies, especially the sun and moon, on the oblate protuberant portion at the equator, tends to give it a rotation about an axis in the plane of the equator; and the combination of these two rotations gives rise to a shifting of the instantaneous axis of rotation in the earth and also in space. If this attracting force were constant, the pole of the equator would move about the pole of the ecliptic in a circle. But, owing to a disturbance called nutation (q.v.), produced by the unequal attraction of the moon, this motion is waved and not exactly circular. Thus the plane of the equator does not remain fixed, and consequently the points in which the equator intersects the ecliptic will also vary, and this causes the precession of the equinoxes. See **LUNAR THEORY**.

PRECHTL, prĕk't'l, JOHANN JOSEPH VON (1778-1854). An Austrian physicist, born in Bishofsheim and educated at Würzburg. He settled in Vienna in 1802 and in 1814 became director of the Institute of Technology there. He founded in 1809 the Naval Academy at Trieste. Prechtl wrote many articles for the *Technologische Encyclopädie* (1830-55), of which he was editor, and for the *Jahrbücher des Polytechnischen Instituts* (1819-39), which also was under his editorial charge; and published *Grundlehren der Chemie in technischer Beziehung* (2d ed. 1817), *Praktische Dioptrik* (1828), and *Untersuchungen über den Flug der Vögel* (1846).

PRÉCIEUSES RIDICULES, prä'syēs' ré'dé-ku'l', LES (Fr., the ridiculous blue-stockings). A brilliant comedy by Molière, first produced on November 18, 1659, in the Hôtel du Petit-Bourbon in Paris, and acted in 1660 before the King, who presented 3000 livres to the actors. The success of the play was instantaneous and owed little to its plot, but sprang from the general delight at Molière's scathing and brilliant satire of the *esprit précieux*, developed in the Hôtel de Rambouillet, and exhibited in its most exaggerated form by Mlle. de Seudéry and her school.

PRÉCIEUX, prä'syē' (Fr., finical, affected). An epithet applied to the affected style which developed in France during the seventeenth century. It was the outcome of a movement for purity and refinement in language, fostered in various Parisian salons, notably in that of the Hôtel de Rambouillet. It soon became itself a menace to the language, degenerating into a mere affectation of fine sentiment and fine words.

Under its influence, fantastic turns of speech replaced simple expressions to such a degree that the whole movement acquired a ridiculous character and led Molière to write his brilliant satire *Les Précieuses Ridicules*, which gave the death blow to the school. See **RAMBOUILLET**, **HÔTEL DE**.

PRECIOUS METALS. As the predominant use of the precious metals is for monetary purposes and radical changes in the quantity of the metals affect all prices, much interest attaches to their production. From the collapse of the Roman Empire to the discovery of America it is probable that no important additions were made to the world's monetary stock. With the discovery of America a new era came in, but it was not before the conquest of Mexico (1521) and of Peru (1533) that appreciable additions were made to the world's stock of silver and gold. The course of gold and silver production since 1493 is given in the following table:

AVERAGE ANNUAL PRODUCTION IN FINE OUNCES

	Gold	Silver
1493-1520.....	186,470	1,511,050
1521-1600.....	238,071	8,660,207
1601-1700.....	293,304	11,970,731
1701-1800.....	610,882	18,336,720
1801-1840.....	512,214	20,028,887
1841-1850.....	1,760,502	25,090,342
1851-1860.....	6,508,293	28,792,113
1861-1870.....	6,082,534	39,226,778
1871-1880.....	5,567,062	71,046,308
1881-1890.....	5,073,250	102,063,872
1891-1895.....	7,882,564	157,581,331
1896-1900.....	12,461,478	165,390,822
Total production		
1493-1850.....	152,779,050	4,817,930,012
1851-1900.....	334,031,609	4,026,051,467

See **GOLD**; **SILVER**.

PRECOCITY (from Lat. *præcox*, ripened too soon, from *præcoquere*, ripen beforehand, from *præ*, before + *coquere*, to cook; connected with Gk. *πέρνειν*, *peptein*, Skt. *pac*, to cook). A premature development, especially of the mental functions. The chief problems of precocity are (1) the relation between mental precocity and bodily abnormalities, (2) the relation between precocity and genius, (3) the course of training that the precocious child should receive. Experts disagree in their answers to the first two questions. It is, however, agreed that precocious children should receive physical attention, while their intellectual bent should not be too much fostered. It is popularly supposed that precocious children are subject to diseases of the nervous system, various scrofulous symptoms, rickets, a stunted body, and other tokens of constitutional enfeeblement, and that they are prone to subsequent mental degeneration, if not to idiocy and premature death. On the other hand, Sully, Galton, and other writers deem an early manifestation of genius not incompatible with a prolonged development. From data furnished by Sully, Donaldson concludes that of 287 geniuses (musicians, painters, sculptors, scholars, poets, scientific men, novelists, and philosophers), 80 per cent. gave distinct signs of promise before 20, 80 per cent. produced work before 30, 84 per cent. attained fame before 40. Musical talent is especially apt to be precocious; only 6 per cent. of the great composers failed to show marked ability as children.

BIBLIOGRAPHY. Chamberlain. *The Child: A Study in the Evolution of Man* (London, 1900); Donaldson, *The Growth of the Brain* (ib., 1895); Ellis, *Man and Woman* (ib., 1894); F. Galton, *Hereditary Genius* (ib., 1892); Lang, "Genius in Children," *North American Review*, vol. clxiv. (New York, 1897).

PRECOGNITION (Lat. *præcognitio*, foreknowledge, from *præcognoscere*, to know beforehand, from *præ*, before + *cognoscere*, to know). In Scotch law, an examination before a judge ordinary or justice of the peace, corresponding to a preliminary examination under penal statutes and the taking of depositions in the United States. In Scotch practice the term is also applied to an examination of witnesses by a solicitor before the trial of a civil cause, at which time it is customary for him to write down the substance of their testimony, the writing itself being sometimes called a precognition.

PREDESTINATION (Lat. *prædestinatio*, from *prædestinare*, to determine beforehand, from *præ*, before + *destinare*, to determine). A theological term signifying the eternal decree of God whereby certain men are appointed unto salvation. The opposite decree is called that of reprobation. The two ideas of an eternal God who works by plan in governing the world, and of such a sinful condition among men as demands the active interference of God by grace if any are to be saved, logically lead to the idea of predestination. This connection of thought is found in Saint Paul, was elaborated by Augustine, and established in the Reformed theology by Calvin. The term, by its connection with the word destiny, conveys an unfortunate implication, as if predestination had to do with fate. Theologians have always, however, maintained that predestination did not destroy the freedom of the will. With Augustine, predestination is an affair of grace, and concerns chiefly what God will Himself do, the persuasives He will employ to elicit the good choice of the will. He made no attempt to exhibit the reasons why some are brought to faith and salvation and others not. It was a matter of the inscrutable wisdom and mercy of God. In this reticence he has been imitated by most of his followers. Negatively, the Reformed theology emphasized with great force the position that the predestination of God did not depend upon the divine foreknowledge of faith which would be exercised by the elected individual, for that faith, as the entrance into the kingdom of God and the condition of salvation, is the result of the election. They did not, however, exclude all foreknowledge of the individual. The Arminians were sometimes thought to condition predestination upon foreknowledge of faith, but no creed states this (except certain creeds of the Greek Church). The main contention of Augustine, that salvation begins in the initiative of God, is generally accepted by evangelical Christians; but the adjustment of this position to human freedom is a point in reference to which much diversity prevails. In recent times the drift of opinion has been against efforts to make such an adjustment, and the current of discussion has carried theological interests into other departments of thought. Present tendencies are to emphasize the known, the facts of consciousness, and avoid inferences of a precarious nature as to the unknown. Consult: the

treatises on systematic theology, particularly Hodge (New York, 1871-72); Mozley, *A Treatise on the Augustinian Doctrine of Predestination* (London, 1878); Forbes, *Predestination and Free Will* (Edinburgh, 1879). See ARMINIANISM; AUGUSTINE, SAINT; CALVINISM; ELECTION; FREE WILL.

PREDICABLE (Lat. *prædicabilis*, what may be spoken of, from *prædicare*, to declare, from *præ*, before + *dicare*, frequentative of *dicere*, to say). A term in the scholastic logic connected with the scheme of classification. There were five designations employed in classifying objects on a systematic plan—*genus*, *species*, *difference*, (differentia), *property* (proprium), and *accident* (accidens). Genus is the name of any class—marked off by some attribute or attributes, called generic—subdivided into further classes, which are called the species of the genus. The other three designations—difference, property, accident—are names given to attributes, other than the generic, possessed by objects classified. The difference, or more frequently the specific difference, is what distinguishes classes which are called species of the same genus; as, for example, the peculiarities wherein the cat differs from the tiger, lion, and other species of the genus *felis*. The property designates any mark peculiar to a class but not used as a basis of classification. Thus, 'the use of tools' was regarded as a property of man, for it was thought to be an exclusively human characteristic, and yet was not used as the basis for classifying man as a species distinct from apes, etc. The accident is any feature which is neither a generic attribute, a specific difference, nor a property. For instance, the high value of gold is an accident; gold would still be gold though it were plenty and cheap. There is much confusion of thought and conflict of usage in connection with the terms property and accident. It would be well to omit the term property from consideration altogether. Then accident would be an inclusive term comprehending all the qualities which are neither generic nor specific. Consult the logical works mentioned under LOGIC.

PREDICATE. See JUDGMENT.

PREDIS, *prâ'dès*, AMBROGIO DE (c.1455-c.1515). An Italian painter, born probably in Milan. He is supposed to have been first taught by Christophorus de Predis, the miniature painter, and was afterwards influenced by Vincenzo Foppa and Leonardo, to the extent that his works have been confounded with theirs for many years. He was the favorite painter of Ludovico Sforza, il Moro, and probably went to Innsbruck in 1499 with the Duke and his family. The portrait by him of the Emperor Maximilian (dated 1502), who married Bianca Sforza, is in the Vienna Gallery. De Predis was rescued from oblivion by Giovanni Morelli, the great art critic, who credits him with the following portraits: a female portrait in the Ambrosiana, Milan, hitherto ascribed to Leonardo; Gian Galeazzo Maria Sforza, belonging to Count Porro at Milan; Francesco de Bartolommeo Archinto, in the collection of Fuller-Maitland, London; two profile portraits in the *Libro del Jesus*, belonging to Prince Trivulzio, Milan; two portraits of youths, in the Bergamo gallery, and another in the Poldi collection in Milan. De Predis is one of the most interesting painters of the Milanese

school, despite certain defects of drawing. Consult Morelli, *Italian Painters* (London, 1892).

PRÆMPTION (ML. *præemptio*, a buying before, from Lat. *præ*, before + *emptio*, purchase, from *emere*, to buy). In international law, the right of a nation to seize provisions and other articles belonging to a foreign nation or its citizens, while they are being shipped across the territory of the former, as being probable contraband of war, and for which proper compensation or indemnity is made to the owners. The English rule is to pay the market value of the goods seized, together with a reasonable probable profit, usually estimated at 10 per cent. on that amount. By the treaty of November 19, 1794, between the United States and Great Britain, certain articles, as munitions of war and naval stores, were classed as absolute contraband of war and subject to confiscation, and it was further stipulated that all other articles seized as contraband of war should be bought at a reasonable price and the owner indemnified for all damages sustained thereby. See CONTRABAND OF WAR; INTERNATIONAL LAW; and consult the authorities mentioned under the latter title.

In the English law, the term præemption is employed to denote a contract right to buy real property, in event of a sale, at a price equal to or greater than the highest price offered by any other person to the owner within the stipulated time. This sort of a right is commonly included under the phrase 'option to purchase,' in the United States.

PRÆMPTION RIGHT. A right formerly given to citizens of the United States under our public land laws to buy a quarter section of public lands at a limited price in preference to all other persons, provided they complied with certain regulations. The præemption laws were repealed by act of Congress, March 3, 1891 (26 U. S. Stat. at Large, p. 1097), but the rights of those who had previously filed their claims were saved. This means of acquiring public land differed from the homestead laws, which require occupation and cultivation. See HOMESTEAD LAWS; PUBLIC LANDS.

PRÆESTABLISHED HARMONY. THE DOCTRINE OF. The theory propounded by Leibnitz to account for the empirical fact that a regular connection exists between changes in the body and modifications in the mental life, and for the correspondence between the experiences of different persons. Leibnitz held that the bodily changes do not cause the mental changes, and that the correspondence between the experiences of different persons are not due to external influences working on them from without, but that from the beginning God has so ordained the course of each person's life that there shall be such a correspondence between his experiences and his bodily changes, and between the experiences of different persons under like conditions. This view differs from occasionalism (q.v.), propounded by Geulinx, in that the latter holds that the correspondence is produced by God *at the particular time* on occasion of what we call causes, while according to the doctrine of præestablished harmony the correspondence has been *previously* ordained and leaves no necessity for the perpetual intervention of God.

PRÆEXISTENCE, DOCTRINE OF. The belief that human souls were in existence before the

generation of the bodies with which they are united in this world. The idea has always been widely spread throughout the East. The Greek philosophers too, especially those who held the doctrine of transmigration (q.v.), as the Pythagoreans, Empedocles, and Plato, were familiar with the conception. With some of the early Christians, as Origen, the assumption of such præexistence was connected with the belief that God had created the souls of men before the world, and that these were united with human bodies at generations or at birth. Subsequently the followers of this opinion were termed *præexistencists*, to distinguish them from the *traducianists*, who held that children received soul as well as body from their parents. Direct interest in this doctrine has nearly ceased in modern times, although in the later philosophy of Germany it has been revived by the younger Fichte; it also forms the basis of Julius Müller's *Die christliche Lehre von der Sünde* (Breslau, 1839; 2d ed. 1888; Eng. trans., Edinburgh, 1856), and is involved in the theory of a universe consisting solely of eternal conscious personalities each *causa sui*, advocated by Howison in *The Limits of Evolution* (New York, 1901).

PREFECT (Lat. *præfectus*, overseer, governor, from *præficere*, to set over, from *præ*, before + *facere*, to make). The title of many officers and magistrates in ancient Rome. The most important was the *præfectus urbi*, or city warden, an appointive office of high rank established in very early times. In the kingly period the city prefect represented the King during his absence from the city in time of war, and under the Republic he performed the same office for the consuls, being himself always an ex-consul. Later, with the establishment of the office of city prætor (see PRÆTOR), that of city prefect lost its importance, until renewed in the reorganization of the government by Augustus. It now became an Imperial magistracy of very high importance, and, as before, only ex-consuls were eligible. The duty of the *præfectus urbi* was to maintain order in Rome; he was thus a sort of chief of police, as in France and Italy to-day. Other prefects of high (senatorial) rank under the Empire were the *præfectus alimentorum*, in charge of the public grain supply; the *præfectus ararii Saturni*, or head of the civil treasury and the *præfectus ararii militaris*, or head of the military treasury. Members of the second, or equestrian, rank were eligible, under the Empire, to another class of prefectures, of which the most important was the command of the Emperor's body-guard (the 'prætorian guard'), with the title *præfectus prætorio*. The power of the prætorian prefect was often great enough to cause the overthrow of an emperor and dictate the choice of his successor. The *præfectus annonæ*, in charge of the free distribution of grain to the poor, and the *præfectus Ægypti*, viceregent of the Emperor in Egypt, were both men of equestrian rank, as were also the admirals stationed at the navy-yards of Ravenna and Misenum (*præfecti classis*) and the captain of the city police (*præfectus vigilum*). In the army also there were prefects in charge of the camp, and of the separate legions, cohorts, and *ala*. Finally, in some towns of Italy the highest local magistrate had the title of *præfectus iure dicundo*.

PREFORMATION (from Lat. *præformare*, to shape beforehand, from *præ*, before + *formare*,

to shape, from *forma*, shape). A view originating in the seventeenth century with Malpighi and Bonnit. They assumed that the germs of all coming generations were contained in one primordial egg. According to this view all the parts and organs of the chick are present in the germ or egg, there being no differentiation, but only an unfolding of parts ('evolutio') existing, infinitesimal in size, in the egg. Haller emphatically stated that there was no such thing as the differentiation of parts, that no part of the body was made before another, but that all the organs were simultaneously created. It logically followed that the germ destined to give origin to the animal—the ovum according to ovulists, the sperm as claimed by the spermatists (q.v.)—contained within itself the germ of the next generation, that of the next after, and so on indefinitely, so that the first created male or female of each species contained within its sperms or ova the germs of all future generations, inclosed within one another, like a nest of Chinese boxes. The theory of incasement (emboitement) propounded by Swammerdam in 1733 was that the form of the larva, pupa, and imago of the butterfly preëxisted in the egg, and even in the ovary; and that the insects in these stages were distinct animals, contained one inside of the other. This explanation Swammerdam extended to the entire animal kingdom.

Consult, for recent statements, Delage, *La structure des protoplasma et les théories sur l'hérédité* (Paris, 1895); Parker and Haswell, *Text-book of Zoölogy* (New York, 1897); Packard, *Text-book of Entomology* (New York, 1898).

PREGEL, prä'gël. The principal river of East Prussia, formed by the confluence of the Ister and the Angerapp, below Insterburg (Map: Prussia, J 1). It flows in a western direction and enters the eastern end of the Frisches Haff about 5 miles below Königsberg. Its total length is about 80 miles and it is navigable from Insterburg.

PREGNANCY. See OBSTETRICS; MENSTRUATION.

PREHNITE (named in honor of Colonel *Prehn*, who discovered it at the Cape of Good Hope in the latter part of the eighteenth century). An aluminum-calcium orthosilicate that crystallizes in the orthorhombic system. It has a vitreous lustre and is light green to white in color. It is widely distributed and occurs in eruptive rocks, usually associated with zeolites, fine specimens being found in France, the Harz Mountains, and Scotland, and in the United States at Bergen Hill and Patterson, N. J., and in the Lake Superior copper region. When cut and polished it yields a gem resembling chryso-prase in color and lustre, and polished slabs have been cut from masses in China.

PREL, prä'l, KARL, Baron du (1839-99). A German philosophic author. He was born at Landshut, studied at Munich, and, after thirteen years (1859-72) in the Bavarian army, devoted himself to philosophy. His chief works are: *Oncirokritikon*. *Der Traum vom Standpunkte des transcendentalen Idealismus* (1868), which won him an honorary doctorate from Tübingen; *Der Kampf ums Dasein am Himmel* (1874; 3d ed., *Entwicklungsgeschichte*, 1882); *Die Philosophie der Mystik* (1885; Eng-

lish version, 1889); *Die Mystik der alten Griechen* (1888); and *Die Magie als Naturwissenschaft* (1899). His selected works in fifteen volumes were published at Leipzig in 1900.

PRELATE (ML. *prælatus*, prelate, Lat. *prælatus*, set before, p.p. assigned to *præferre*, to set before). A title given to certain ecclesiastics of a higher order, usually to patriarchs, metropolitans, archbishops, bishops, and in the Roman Catholic Church to the heads of religious houses and certain other officials. In the Roman Curia many such officials, although not bishops, wear the episcopal purple and are addressed as 'Monsignore' and 'Right Reverend.' These prelates are often intrusted with weighty diplomatic and other missions, and their office is commonly a training-school for the cardinalate. By the derived term prelacy is understood such an ecclesiastical polity as provides for a gradation of the clergy in rank, as distinguished from a system in which all the clergy are on an equality.

PRELL, HERMANN (1854—). A German historical painter, born at Leipzig. He was a pupil of Grosse in Dresden and of Gussow in Berlin, then went to Italy to study fresco painting, in which branch he produced his most important works, to wit: eleven mural paintings symbolizing the "Main Epochs in the History of Architecture" (1881-82, Banquet Hall, Architects' Union, Berlin, for which he also painted a ceiling-piece in oil, "Ars Vietrix," 1886); "Justice" and "Valor," and "Henry IV. Granting Privileges to Worms in 1074" (City Hall, Worms); cycles of historic episodes and allegorical scenes, respectively, in the City Halls at Hildesheim (1888-92) and Danzig (1896), and in the staircase of the Breslau Museum (1894); mythological scenes in the Albertinum, Dresden (1900). Of his easel pictures the Dresden Gallery contains the "Betrayal of Christ" (1886), and the Breslau Museum a "Repose in Egypt" (1890). The cartoons to his Hildesheim frescoes were awarded the great gold medal in Berlin in 1893. From 1886 to 1891 he taught at the Berlin Academy, then was appointed professor in Dresden. He published *Die Fresken im Rathaus zu Hildesheim* (1894) and *Die Fresken im Treppnhaus des Schlesischen Museums*, text by Janitsch (1895). For his biography, consult Meissner (Vienna, 1897) and Rosenberg (Bielefeld, 1901).

PRELLER, FRIEDRICH (the Elder) (1804-78). A distinguished German landscape painter, to whom the "historic" landscape owes its highest development in the nineteenth century. Born at Eisenach, April 24, 1804, he removed in infancy with his parents to Weimar and early gave proof of artistic talent. Through Heinrich Meyer (q.v.), who subsequently was his instructor, Goethe became interested in him and henceforth influenced the development of the young artist. In 1821 Preller went to Dresden, where he copied after Ruisdael and Potter and was much impressed by the works of Claude Lorrain and Poussin. Back at Weimar, his work attracted the attention of the Grand Duke Charles Augustus, who in 1824 took him to Antwerp, where Preller now devoted two years to the study of the human figure at the Academy under Van Brée. With a stipend from the Grand Duke, he went in 1826 to Milan, and in 1828 proceeded to Rome, where an intimate acquaintance with antique models and the master works of the Italian

Renaissance, together with the mighty impulses received through the influence of Koch and the closest study of Claude and Poussin, fully developed his powers. On a trip to Naples in 1830 he first conceived the idea of his life-work, the "Odyssey Landscapes," and there he also met Dr. Härtel, who was to give him the first opportunity to realize his dream, by commissioning him in 1832 to paint in his Roman house at Leipzig "Seven Scenes from the Odyssey" (1834). Landscape and figure elements appear there in their intimate relation, blended into an harmonious whole. Preller succeeded Meyer as professor at the school of drawing in 1832 and received at the same time the commission to execute "Six Thuringian Landscapes with Historical Figures" for the ducal palace. There he also painted in tempera "Five Scenes from Oberon" (1834-39) in the Wieland room. Among the results of journeys to the isle of Rügen (1837 and 1839) and to Norway (1840), the views of the sublime Norwegian coast scenery, well represented by three specimens in the Weimar Museum, one (1850) in the Dresden Gallery, and one (1853) in the National Gallery, Berlin, are especially noteworthy.

More than twenty years elapsed before he found occasion to resume his favorite theme and to compose an enlarged version of the "Odyssey Landscapes" in sixteen charcoal drawings (1854-56, National Gallery, Berlin), which on their exhibition in Munich, 1858, produced an immense impression. The monumental execution of this cycle being secured by the Grand Duke Charles Alexander for the new Museum at Weimar, Preller started for Italy in 1859 to make new studies, which resulted in another modified series of sixteen compositions, the cartoons (1860-63) having found a permanent place in the Leipzig Museum and the encaustic paintings, executed 1865-68, constituting one of the chief ornaments of the Weimar Museum. The cycle traverses Homer's entire narrative. In the meanwhile he had also painted the easel pictures of "Calypso" and "Leucothea" for the Schack Gallery in Munich, and of "Nausicaa" for the Raczynski Gallery in Berlin. Two further sojourns in Italy (1869 and 1875) occasioned another series of fine oil paintings, of which the "Rape of Nymphs by a Centaur" (1874) adorns the Dresden Gallery and "Acqua Acetosa Near Rome" (1874) is the most remarkable. Preller also has twenty-eight plates of excellent etchings (1832-47) to his credit. Productive and planning to the last, he died, after a short illness, at Weimar, April 23, 1878, and was buried on his birthday. Consult: Atkinson, in *Art Journal* (London, 1881); Roquette, *Friedrich Preller* (Frankfort, 1883); Pecht, *Deutsche Künstler des neunzehnten Jahrhunderts*, i. (Nördlingen, 1877); Reber, *Geschichte der neueren deutschen Kunst*, ii. (Leipzig, 1884); Rosenberg, *Geschichte der modernen Kunst*, ii. (ib., 1899); Schöne, *Friedrich Prellers Odysseelandschaften* (ib., 1863); and Jordan, *Die Odyssee in Prellers Darstellung* (ib., 1873).

PRELLER, FRIEDRICH (the Younger) (1838-1901). A German landscape painter, born at Weimar, the son, pupil, and worthy follower of Friedrich the Elder, whom he accompanied to Italy in 1859. He studied there until 1862, and again in 1864-66 in Rome. In 1867 he settled in

Dresden, where he found a wider sphere for his activity and in 1880 became professor at the Academy. Developing into a fine colorist, he surpassed even his father in point of technique, and with predilection chose for his subjects scenes with historic associations, such as the "Gulf of Baja," the "Forum Romanum," "Monastery of Santa Scolastica, Near Subiaco" (1872, Dresden Gallery), "Landscape with Sappho" (1879, Leipzig Museum), and "Pieve di Cadore," the home of Titian (1880). His mural paintings of mythological and historic landscapes in the Albrechtsburg at Meissen (1878), in the Royal theatre, the Albertinum (1891), for which he made special studies in Greece in 1890, and in the university (1897), number among the best of their kind.

PRELUDE (OF. *prelude*, Fr. *prélude*, from Lat. *præluere*, to play before, from *præ*, before + *luere*, to play). In music, a short preface or introduction to a more extended movement or composition, or to a dramatic performance or church service. It is in the same key with the selection which it is to introduce, and to which it is intended as a preparation. For a long time the prelude constituted an essential portion of the older sonata and suites. In the seventeenth century Corelli in his *Sonate da Camera* introduced the custom of beginning all such works with *preludio* in slow time; hence the *introduction* (q.v.) in our modern sonatas and symphonies. The German composers developed this idea. In some of the suites of J. S. Bach the prelude is as important as any of the regular movements. When this master wrote the *Well-Tempered Clavichord* he prefaced each fugue with a prelude. Bach's *organ preludes* are masterpieces, notably the magnificent one in E flat introducing the Saint Ann's fugue. Mendelssohn followed Bach in his six *Preludes and Fugues* for piano (op. 35). Chopin wrote a book of preludes which rank among the most beautiful of his shorter compositions, but they are entirely independent compositions, complete in themselves. Richard Wagner, from the time of his writing *Lohengrin*, uses the word prelude (*Vorspiel*) instead of overture. He aimed to give in the orchestra introduction to his dramatic works either a complete synopsis of the drama or its fundamental idea. He has, indeed, done this also in his overtures to *The Flying Dutchman* and *Tannhäuser*. Only in *Lohengrin* does the prelude end with a complete cadence; in all the other works the prelude leads without a cadence directly into the first act. See FORM; OVERTURE.

PREMILLENARIANS. See ADVENTISTS; MILLENNIUM; MILLER, WILLIAM.

PREMISE (in logic). See SYLLOGISM.

PREMISES (OF. *premissæ*, Fr. *prémisse*, from ML. *præmissa*, premise, fem. sg. of Lat. *præmissus*, p.p. of *præmittere*, to send before, put before, from *præ*, before + *mittere*, to send, Skt. *miv*, to push). In law, 'premises' was originally employed exclusively to describe the introductory part of any legal writing, which usually contains preliminary statements or descriptions, necessary to a complete understanding of the main body of an instrument, as the 'stating' part of a bill in equity, or the part of a deed which precedes the *habendum* clause, and which contains a description of the property conveyed. As a result of this custom of speaking of the description of

the property in a deed as the premises, popular usage has extended the meaning of the term to include lands, tenements, and hereditaments themselves.

PREMONSTRATENSIANS, called also **NORBERTINES**. A religious Order which, during the four centuries from the twelfth to the sixteenth, was one of the most numerous and powerful monastic bodies in Europe. Its houses were especially numerous in Germany, but there were many monasteries also in England, where, because of the color of their habit, the Norbertines were called White Canons. The Order was founded by Saint Norbert, a native of Xanten, in the Diocese of Cleves, who was born about 1080. Norbert's youth had been irregular, but, converted at the age of 35, he afterwards lived very strictly, devoting himself to the conversion of others. While engaged in this work he realized the need for missionaries to help the local clergy. He was soon joined by thirteen companions to whom he gave the rule of Saint Augustine, and founded his first monastery in the forest of Coucy, near Laon, at a place called Pré Monstré (the field shown), or Prémonstré (foreshown), because Norbert felt that this was the place that had been pointed out to him by a vision. This became the mother house and the Order came to be named from it. The rule adopted by Saint Norbert was very strict. It imposed perpetual fasting, that is, allowed only one meal a day, not to be taken before noon, and required entire abstinence from meat. Besides the daily chanting of the office, the monks were bound to the duties of preaching and hearing confessions in connection with the parish clergy.

The Order spread rapidly, first in France and the Low Countries, and, after Norbert's election (1127) as Archbishop of Magdeburg, also in Germany. The abbot of the mother house at Coucy held the rank of general and was superior of the entire Order. This continued to be the case until the French Revolution. Saint Norbert also founded an Order of nuns which spread almost as rapidly and as widely as that for men. At the end of the fifteenth century the Premonstratensian Order had not less than 1500 monasteries for men and 500 for women, most of them situated in France, Germany, and England, for the Order never made much progress in Italy or Spain. It maintained its first fervor for several centuries, but mitigations of the rule gradually crept in and were followed by relaxations, which made various reforms necessary. Toward the close of the sixteenth century (1573), as the result of the Catholic reaction that followed the Council of Trent, a reform movement similar to that in the Franciscan Order made considerable modification of the existing Premonstratensian Institute. The reformed communities remained united with the older body, however, and in 1630 the modified rule was accepted by all the communities. Since the end of the seventeenth century the Order has declined in numbers. The female branch became almost extinct in the eighteenth century. There was a reawakening in the nineteenth century in the male branch, but the Order has suffered much from suppression in Italy, Spain, the German Empire, and Switzerland. It flourishes in Austria and Holland, however, and there are some houses in England. In the United States there is a house at De Pere, Wis., which was founded from the

Abbey of Heeswijk (Holland). Consult Currier, *History of Religious Orders* (New York, 1894).

PRENCE, or PRINCE, THOMAS (c.1600-73). An American colonist, born at Lechdale, in Gloucestershire, England. He was one of the company of Puritans that settled in Leyden, Holland, and in 1621 he followed the Pilgrims to New Plymouth. He was a man of considerable wealth, and soon became a person of influence in the colony and was chosen to fill its most responsible offices. He was elected Governor in 1634 and 1638, and annually from 1657 until his death in 1673, the law requiring the Governor to live in Plymouth being waived in his favor. From 1635 until 1637 and from 1639 until 1656 he was one of the assistants, and in 1654 he was sent to Kenebec patent, where he established a government subordinate to that at Plymouth. In religious affairs he represented the intolerance of his age, but, on the other hand, he may be considered the founder of the New England public schools, for he zealously advocated the establishment of a system of free education and secured the passage of a law appropriating the profits of the Cape Cod fisheries to the support of a school in Plymouth. Consult Baylies, *An Historical Memoir of the Colony of New Plymouth* (1866).

PREN'DERGAST, SIR HARRY NORTH DALRYMPLE (1834—). An English soldier, born in India. He was educated at Brighton College and the East India Company's College at Addiscombe, entered the military service in 1854, was with the sappers and miners during the Persian War of 1856-57, and as a member of the Central India field force distinguished himself in 1858. In the Abyssinian War (1867-68) he commanded the detachment of Madras sappers and miners, and in 1885-86 he commanded the expedition which obtained the annexation of Upper Burma to the British Empire. He then (1886) commanded all the British forces in Burma, and subsequently occupied various posts, including that of officiating resident at Mysore and chief commissioner of Coorg in 1891-92. In 1887 he attained the rank of general of Royal Engineers.

PRENDERGAST, JOHN PATRICK (1808-93). An Irish politician and historian, born at Dublin. He was educated at Trinity College, Dublin, was admitted to the bar in 1830, and was active as a writer of pamphlets and newspaper articles from the Liberal Nationalist point of view. His chief work was, however, in connection with Irish history, in which he published the following studies: *The History of the Cromwellian Settlement of Ireland* (1863; 2d ed, 1875); *The Tory War in Ulster* (1868); and *Ireland from the Restoration to the Revolution* (1887).

PRENTICE, GEORGE DENISON (1802-70). An American journalist, born at Preston, Conn. He graduated at Brown in 1823, studied law and was admitted to the bar, but never practiced, and in 1828 became the first editor of the *New England Review*. In 1830 he removed to Kentucky and there published his popular campaign life of Henry Clay (1831). He established in the Whig interest at Louisville in 1830 the *Journal*, which soon came to be the best edited and most read newspaper in that section. He did much to increase the *Journal's* circulation and his own fame through originating the brief, pointed paragraph, theretofore almost unknown. A collection of these

paragraphs, edited by himself, appeared in 1860 as *Prenticiana* (rev. ed. 1870). Prentice was a vigorous opponent, and was so frequently involved in duels as to become a subject of jest. He was antagonistic to secession, and it is said that his editorials had an important influence in keeping Kentucky from withdrawing from the Union. He published in the *Journal* considerable verse, later edited by Piatt (Cincinnati, 1876). He also contributed for some time a column of 'Wit and Humor' to Bonner's *New York Ledger*. He retired from the editorship of the *Journal* in 1867. Consult the sketch by Piatt, in the edition of the *Poems* above referred to, and Watterson, *Memorial Address* (Cincinnati, 1870).

PRENTISS, BENJAMIN MAYBURY (1819—). An American soldier, born at Belleville, Va. (now W. Va.). In 1841 he settled in Quincy, Ill., and three years later he became first lieutenant of a militia company, organized to aid in quelling the Mormon disturbances. He served during the Mexican War as a captain of volunteers, and at the outbreak of the Civil War organized a company which he offered to the Federal Government. Soon afterwards he was appointed colonel of the Seventh Illinois, and on May 17, 1861, was promoted to the rank of brigadier-general of volunteers, and was given command of Cairo, then one of the five principal military centres of the Union. In September, however, he was succeeded by General Grant. On December 28, 1861, he defeated the Confederates at Mount Zion. On April 3, 1862, he joined Grant at Shiloh and was given command of the new Sixth Division, composed of raw troops. This division with that of Sherman occupied the most exposed position, and upon them fell the unexpected onslaught of the Confederates on April 6th. After making a creditable resistance General Prentiss and the greater part of his division surrendered. He was exchanged in October, and the next month was commissioned a major-general of volunteers, while attending the court-martial called to try Fitz John Porter (q.v.). On July 3, 1863, while commanding at Helena, Ark., he repulsed an attack by a superior force of Confederates under Generals T. H. Holmes and Sterling Price. On October 28, 1863, he resigned his commission.

PRENTISS, GEORGE LEWIS (1816—). An American clergyman. He was born at Gorham, Me., graduated at Bowdoin College in 1835, and taught for a year in Gorham Academy. Following this he went abroad and spent two years at the universities of Halle and Berlin. After a period in England, he returned to America and became pastor of the South Trinitarian Church, New Bedford, Mass., in 1845. From 1851 to 1858 he was pastor of the Mercer Street Presbyterian Church, New York, resigning to seek health by foreign travel. In 1860 he began the organization of the Murray Hill Church of the Covenant, New York, and served as its pastor from 1862 to 1873, when he was made professor of pastoral theology, Church polity, and mission work in Union Theological Seminary. In 1896 he became professor emeritus. His most important published work is *The Union Theological Seminary in the City of New York, Historical and Biographical Sketches of Its First Fifty Years* (1889), and a supplementary chapter dealing with the history of the veto power of the General Assembly over the election of professors of Union Seminary and its application to Dr. Charles A.

Briggs, entitled *The Agreement Between Union Seminary and the General Assembly* (1891). His wife, ELIZABETH PAYSON PRENTISS (1818-78), was born in Portland, Me., a daughter of the Rev. Edward Payson. She was educated in Portland and Ipswich, taught school for a few years, and was married to Dr. Prentiss in 1845. She was the author of books for children and several popular religious works, the most important of which was *Stepping Heavenward* (first published serially in the *Chicago Advance*, 1869). Her life and letters were published by her husband (New York, 1882).

PRENTISS, SEARGENT SMITH (1808-50). An American lawyer and orator, born in Portland, Me. At the age of nineteen he graduated at Bowdoin College, and then settled in Natchez, Miss. Here he supported himself for two years by private tutoring, and at the same time studied in a law office. He was admitted to the bar in 1829, and his keen intellect and unusual oratorical ability made him at once successful. In 1832 he removed to Vicksburg, where he soon became very influential. In 1835 he was elected to the State Legislature by the Whigs, and two years later was returned to Congress, but was unseated. He was reelected, however, in the following year, and this time was allowed to serve. In 1840 he made speeches in many parts of the country in support of W. H. Harrison, but withdrew from politics in 1842, and thereafter took but little part in public affairs save in opposing the repudiation of the State debt. In 1845, having by an unfavorable legal decision lost much of his property, he removed to New Orleans and practiced with success in that city. Of his speeches, which were much admired by such contemporaries as Edward Everett and Daniel Webster, only a few have been preserved. His life was written by his brother, George Lewis Prentiss (2 vols., New York, 1855 and 1870). Consult, also, Lynch, *Bench and Bar of Mississippi* (New York, 1881).

PRENZLAU, prēnts'lou, or **PRENZLOW**. A town in the Province of Brandenburg, Prussia, on the Ucker and the Lower Ucker Lake, 58 miles north-northeast of Berlin (Map: Prussia, E 2). Among its churches is the handsome Gothic Saint Mary's, built of brick. The town has a gymnasium and a teachers' seminary. Sugar, cigars, machinery, woolen yarn, leather, oleomargarine, and finished wood products are manufactured. Prenzlau is first mentioned in the twelfth century, and was the capital of the Ucker Mark. It is noted as the scene of the surrender of the Prussians under Hohenlohe to the French under Murat in 1806. Population, in 1890, 18,019; in 1900, 20,228.

PREPARATION (Lat. *præparatio*, from *præparare*, to make ready beforehand, from *præ*, before + *parare*, to make ready). A term in music applied to the introduction of dissonances. According to the older theorists no dissonance could be introduced without being *prepared*, i. e. the note forming a dissonance had to occur in the preceding chord and in the same part as a note of harmony. Modern composers are very free with the introduction of dissonances. See CONSONANCE; DISSONANCE.

PREPOSITION (Lat. *præpositio*, from *præponere*, to place before, from *præ*, before +

ponere, to place). In grammar (q.v.), an indeclinable word preceding a noun or a pronoun in an oblique case and showing the relation of such a noun or pronoun to another noun, pronoun, adjective, or verb. Originally the preposition was only a specialized form of the adverb, and is consequently in the last analysis a stereotyped case-form of a noun. Thus the Indo-Germanic **peri*, 'around,' which is represented by Sanskrit *pari*, Greek *περ*, Latin *per*, Gothic *fair*, and German *ver-* in such verbs as *vergehen*, 'to go to destruction,' was primarily the locative case of an inferred noun **per-*, connected with the verbal root **per*, 'to cross.' The adverbial nature of prepositions is shown by their use in verbal compounds, as Latin *per astra*, 'through the stars,' beside *perire*, 'to go through, to perish.' In an earlier period the preposition did not "govern its case." The preposition was purely adverbial and the case of the noun depended altogether on other syntactic considerations. In such a sentence as Latin *it ad flumen*, 'he goes to the river,' *ad* primarily pointed out the direction, while *flumen* was an accusative denoting in itself the end of the motion implied in the verb. The decay of feeling for the force of inflectional endings led to an increased value of prepositions, which developed from local adverbs to words which actually governed case relations. The term preposition is a faulty one, as these words may in many languages stand after the noun which they govern, and they are then sometimes called postpositives or postpositions. In English the preposition has lost in great part its adverbial character, although traces of this value survive in such uses as 'to see a thing through,' as compared with 'to see through a thing.' As connectives they govern the objective case only, as in *the house*, *to the house*, *from the house*, where more conservative languages would employ a locative, an accusative, and an ablative respectively. The possessive case has been supplanted in great measure by the objective case with *of*. The principle is frequently maintained that a phrase or sentence should not end with a preposition, on account of the weak termination thus given. Many of the best literary authorities, however, disregard this, and there is no good reason for a rigid observance of such a rule either on stylistic or on historical grounds. Consult Delbrück, *Vergleichende Syntax der indogermanischen Sprachen*, vol. i. (Strassburg, 1893).

PREPOTENCY (Lat. *præpotentia*, superior power, from *præposse*, to be superior in power, from *præ*, before + *posse*, to be able). The power of exerting a preponderating influence in the act of reproduction. Thus some one male ancestor excelling in some physical or mental character, such as form, color, and disposition, is known to have transmitted his qualities through many generations. Not only may the individuals of a normal species thus transmit their marked or superior qualities, but also aberrations or 'sports' may thus be transmitted, unless bred out by crossing. In certain historic families some one ancestor, and after him others in the same family have shown great power in transmitting their likeness through the male line, as in the case of the Austrian emperors of the House of Hapsburg, and so with the mental qualities of certain Roman families. It is especially noticeable among domesticated animals, where qual-

ities and ancestry have long been recorded. The famous bull 'Favorite' is said to have exerted a prepotent influence on the short-horned race of cattle. A ram of a goat-like breed of sheep from the Cape of Good Hope had offspring scarcely distinguishable from himself when crossed with ewes of twelve other breeds. Other cases are mentioned by Darwin. Darwin says that the law of prepotency acts when species as well as when races or individuals are crossed, giving examples among plants. The jackal is prepotent over the dog, the ass over the horse, and this runs more strongly through the male than the female ass. The intricacy of prepotency is reiterated by Ewart, and is likely to be difficult to understand until the laws of heredity are better understood. He says the leader of any given wild herd may be decidedly prepotent, but unless he is mated with members of some other herd presenting different characters the prepotency may escape notice. The Jews are more prepotent than the English race, are of better, i.e., purer breed, but the prepotency only declares itself when intermarriages take place. In nature prepotency may (1) arise spontaneously and abruptly along with sports in one or more directions, or gradually with the help of natural selections; (2) it may be gradually acquired when a few individuals of any given species or variety are so isolated that inbreeding is inevitable. In cases of crosses between different breeds, says Redfield, prepotency appears to lie with that breed which has had its characters most firmly fixed by in-and-in breeding. Hence animals of pure blood are prepotent over mongrel stock. In the life of an individual a character is more firmly fixed in middle life than in youth, and observation has shown among horses that the older individual is or tends to be more prepotent than young males.

Consult: Darwin, *The Variations of Animals and Plants Under Domestication* (London, 1888); Ewart, *The Penyeuk Experiments* (London, 1899).

PRERADOVIĆ, prá-rá'dó-vich, PETER (1818-66). A Croatian poet, born at Grabonitz. He entered the Austrian Army in 1830 and rose to the grade of general (1866). When he was stationed in Dalmatia (1842), he took up the study of his native tongue, which he had almost forgotten, and began to write in that language. His works, which rank him as the greatest Croatian poet of the century, include *Procnci* (1846), *Nove pjesme* (1851), and the epics *Provi Ujuti* and *Slavenski Dioskuri*. The collected edition, published at national expense (1872), contains a biography and criticism of Preradović by Trnski. A few of his poems were turned into German by Spicer (1895).

PRE-RAPHAELITES. A term which, properly signifying the Italian painters before Raphael, is now commonly applied to their imitators in the nineteenth century. It was first used in this sense of a group of young German artists who, after their expulsion from the Vienna Academy in 1810, established themselves in the deserted Franciscan convent of San Isidoro at Rome. They formed an art brotherhood which was to live in seclusion and sanctity, and were nicknamed "The German Lay Brothers," and afterwards "The Nazarenes." Their object was the restoration of Christian art to its mediæval purity, and they took as their guides the Pre-Raphaelite masters. They regarded the mental

conception as the chief feature of a work of art, and form as the chief vehicle of its expression, color being subsidiary. The leader and moving spirit of the school was Overbeck (q.v.); other members were Cornelius, the brothers Schadow, Philip Veit, Selnorr von Carolsfeld, Führieh, and Steinle. They afterwards scattered throughout Germany, some, like Cornelius, relinquishing their tenets, but Overbeck remained at Rome, faithful to the end. Their art is characterized by a certain naïveté, and is technically very primitive.

The name is much more widely applied to the school which arose in England about the middle of the nineteenth century, and accomplished great results both in art and literature. The movement originated with a band of seven young men—Dante Gabriel Rossetti and his brother William Michael, John Everett Millais, William Holman Hunt, Frederick George Stephens, James Collinson, and Thomas Woolner the sculptor. The Brotherhood was formed in the autumn of 1848, and its work really began with "The Eve of Saint Agnes," a picture by Holman Hunt, who was the first of them to realize the purity of work in the early Italian painters and to seek to rival their sincerity, though they owed much to the influence of an older man, Ford Madox Brown. For a time in 1850 they published a periodical called *The Germ*, in which some of Rossetti's earliest poetical work and his fine prose study "Hand and Soul" first appeared. Like the German school, they were convinced that modern traditions had led painters away from the only true principle and the only worthy practice of their art, and that it was necessary to go back for inspiration to the work of the time when art had not ceased to be simple, sincere, and religious. Both in literature and in art, they wished to revert (in Mr. Watts-Dunton's phrase) from "the temper of imitation, prosaic acceptance, pseudo-classicism, and domestic materialism" to that of "wonder, reverence, and awe." Their official manifesto in *The Germ* declares their intention "to encourage and enforce an entire adherence to the simplicity of nature, either in art or poetry." They were defended and warmly praised by Ruskin, who found in their art the modern incarnation of his theories; but by others they were held to have recurred "to a style of painting unadapted to our age, to an ignorance of technical knowledge, and to a religious feeling that could not be voluntarily recalled in a period of different tendencies."

A closer adherence to form followed in the work that felt the influence of the movement. In seeking truth of detail the ensemble was often lost; religious and mystic tendencies occasionally degenerated into affectation which presented an easy mark for caricature. Millais began to break away from the Brotherhood between 1855 and 1857, but Hunt remained faithful, and Burne-Jones's work throughout showed a strong sympathy with the school. In his later life Rossetti threw off the trammels of the narrower Pre-Raphaelitism, while adhering to the mystical attitude. In poetry, the movement may really be considered as a recurrent phase of the wider Romantic movement, whose teaching had been somewhat obscured in the half-century since its proclamation in England. In its looking back to the Middle Ages, it harmonized with the Oxford Movement of its own day, and with the Gothic

revival of Pugin. Its mental attitude is magnificently represented in the highly colored, imaginative 'painter's poetry' of Rossetti and in much of the work of William Morris and some of Swinburne's.

Consult: Destrée, *Les Préraphaelites* (Brussels, 1894); Janson, "Deutsche Präraphaeliten," in *Zeitschrift für bildende Kunst* (Leipzig, 1901); Wood, *Dante Rossetti and the Pre-Raphaelite Movement* (New York, 1894); Bate, *The English Pre-Raphaelite Painters, Their Associates and Successors* (London, 1899); W. M. Rossetti (ed.), *Pre-Raphaelite Diaries and Letters* (ib., 1900); Holman Hunt, "The Pre-Raphaelite Brotherhood," in *Contemporary Review* (ib., 1886); Noble, "A Pre-Raphaelite Magazine," in *The Sonnet in England* (ib., 1896); and see ROSSETTI, DANTE GABRIEL; ROMANTICISM.

PRERAU, prä'rou. A town of Moravia, Austria, situated 40 miles northeast of Brünn (Map: Austria, E 2). It contains an ancient castle, a Gothic town-hall, a Bohemian college, an agricultural and a trade school. There are considerable manufactures of textiles, also of sugar, hardware and agricultural machinery. Prerau was formerly the chief seat of the Moravian Brethren. Population, in 1890, 12,955; in 1900, 16,727.

PREROGATIVE. In law, a term most frequently employed to describe the rights and privileges of a sovereign or other person in a high official position. It implies an authority or right in the sovereign, not controlled by any other power. For example, the right to *treasure trove* (q.v.) is a royal prerogative, the King having a superior right to any of his subjects. Certain franchises are said to be 'branches' of royal prerogatives granted to subjects. The term is sometimes employed in the United States to denote the authority vested in a public official, but not in the same sense as it is used in the English law. See Pollock & Maitland's *HISTORY OF THE ENGLISH LAW*; Blackstone's *COMMENTARIES*.

PRESBYOPIA. See SIGHT, DEFECTS OF.

PRESBYTER (Lat. *presbyter*, from Gk. *πρεσβύτερος*, *presbyteros*, comp. of *πρεσβύς*, *presbys*, old). In the most general meaning, one advanced in years or rank. The term was used by the Jews to designate the chief official of the synagogue or a member of the Sanhedrin, and was naturally adopted in the Christian Church. For different views as to the institution and duties of the office, see BISHOP; ELDER; ORDERS, HOLY; PRESBYTERIANISM.

PRESBYTERIANISM AND THE PRESBYTERIAN CHURCHES. Presbyterianism is a system of Church government by presbyters, or elders. This fact distinguishes it from other forms of Church government, the papal, the episcopal, and the congregational. "In the presbyterian system all ecclesiastical authority is in the body of presbyters called by Christ, and ordained by presbyters to rule over the Church. . . . The Presbyterian churches exalt the Scriptures above the Church, and urge that Christian men and Christian assemblies should wait upon God, and listen for the voice of His Spirit speaking infallibly in his Word." Calvin has been regarded as the founder of Presbyterianism, and it is true that he was the first to organize the Reformed Church on a Presbyterian model; but it should be remembered that government by a

body of elders was maintained by the Waldensians and others from a much earlier age.

The name being derived from the form of Church government, the term Presbyterian properly includes all those who accept the presbyterian government, even though there may be differences in their theological beliefs. So in the general Presbyterian Council held at Edinburgh in 1877, the German State establishments and the French and Dutch Reformed churches were represented. Presbyterians are generally Calvinistic in doctrine, and for the most part accept the Westminster Assembly's Confession of Faith and the Larger and Shorter Catechisms as the symbols of belief. They do not, however, all agree in the interpretation of those standards.

PRESBYTERIAN POLITY rests on representative government and an ascending series of appellate courts. There are three classes of officers in every well-organized church—the minister or pastor, who is also called a teaching elder; the body of ruling elders, who, with the pastor, have the spiritual oversight of the church; and the deacons, who have care of the relief of the poor and in some churches manage also the financial affairs. The primary governing body is the church session, which consists of a pastor and the ruling elders, chosen by the congregation. Elders were formerly chosen only for life, but now in some branches of the Church hold office for a term of years. The church session is under the control of the presbytery to which it belongs. The presbytery consists of the pastors and churches of a given district. The presbyteries are united in a larger governing body called the synod. The larger synods of the United States are representative bodies consisting of ministers and elders chosen from the presbyteries according to some definite ratio. The smaller synods are undelegated bodies, all the ministers and one elder from each church constituting the body. In some of the smaller branches of the Church the synod is the ultimate court. The completed system, however, includes a General Assembly, which is the supreme court. It meets annually and consists of ministers and elders chosen by the respective presbyteries in some definite ratio. Appeals and complaints are carried from the lower to the higher judicatory, beginning with the session and terminating with the General Assembly. In the Presbyterian Church in the United States appeals from the synods to the General Assembly are limited to cases involving doctrine or government. In the other Presbyterian churches appeals from the synods to the Assembly are allowed in all cases. The Assembly also has general jurisdiction over the various agencies of the Church, such as the theological seminaries and the boards doing the benevolent and missionary work.

THE PRESBYTERIAN CHURCHES IN SCOTLAND. Christianity was probably introduced into Scotland about the beginning of the third century, and the claim has been made that the early Celtic churches were non-prelatical. However that may be, they were later brought into the Roman obedience, and remained thus until the Reformation. Since that time the history of the Presbyterian Church in Scotland has been practically a history of the country. The life of John Knox (q.v.) is the epitome of the Scottish Reformation. The first public movement toward the organization of the Presbyterian Church was the drawing of a bond known as "The First Covenant."

It was signed at Edinburgh, December 3, 1557, by some of the most powerful Scotch barons, and by many of the lesser nobility. This act brought forth a proclamation from the Queen Regent forbidding any one to preach or administer the sacrament without the authority of a bishop, but the Reformed party triumphed and in 1560 Parliament abolished the Roman Catholic form of worship, adopted a confession of faith agreeing with those of the Reformed churches of the Continent, and appointed ministers of the Protestant faith to various parts of the kingdom. On December 20, 1560, the first General Assembly of the Church of Scotland was held in Edinburgh. It consisted of six ministers and thirty-four laymen. In this same year a committee of five persons, including Knox, had been appointed "to commit to writing their judgments touching the reformation of religion." Their *First Book of Discipline* was rejected by the nobles, though accepted by the Church. In 1581 the *Second Book of Discipline* was adopted by the Assembly, and is still in force together with the Westminster standards. The undaunted perseverance of John Knox and Andrew Melville at last procured complete recognition of the Calvinistic faith, and the Presbyterian form of government, as the established religion of Scotland. This was ratified by Parliament, with the consent of King James (I. of England, and VI. of Scotland) in 1592. His duplicity, however, soon made itself manifest when he tried to force the episcopal polity on his Scottish subjects. In this he was followed by his successors, Charles I., Charles II., and James II. The ecclesiastical affairs of the country were in great confusion. In 1610 the Glasgow Assembly restored the episcopal government. In 1638 the Assembly rescinded the acts of six previous Assemblies, condemned and deposed the bishops, and abolished episcopacy. In 1661 Parliament passed the Rescissory Act, which repealed the legislation of the previous twenty-one years, and episcopacy was restored to its former position. After the accession of William and Mary in 1689 civil and religious liberty were restored and Presbyterianism was revived. In 1690 an Act of Settlement was passed, prelacy done away with, and the Westminster Confession adopted. Though both England and Scotland had been under one crown for nearly a century, they still continued separate kingdoms, each with its own Parliament and executive, independent of the other, but upon their union in 1707 the position of Presbyterianism was guaranteed, and it has since continued to be the established religion of Scotland. The Church of Scotland is the established Church, from which the other bodies have from time to time withdrawn. It differs from them chiefly in maintaining a connection with the State.

The question of patronage caused great dissension at an early period, for the Scotch claimed the right to elect their own clergy, or at least the privilege of vetoing an unsatisfactory appointment. A worldly spirit manifested itself, men who were lax in principle obtained important positions, and strange doctrines were taught: the result was the secession of several important bodies. The first party to withdraw were the *Covenanters* or *Cameronians*, who objected to the interference of State with Church, and who therefore on July 27, 1712, renewed the Covenants

(q.v.). They were lineal descendants of the covenanted presbytery, and logically true to their principles. The former Covenanters protested against the errors of prelacy, and their successors were now equally emphatic against the backsliding of presbytery. Another body led by Ebenezer Erskine (q.v.) came out in 1733, forming a party known as the *Associated Presbytery* or *The Seceders*. Again, in 1760, another body left the mother Church. These men were known as *The Relief Synod*. On May 13, 1847, these churches united, forming the *United Presbyterian Church of Scotland*.

The Free Church of Scotland originated in a protest against civil patronage of the Church, the civil courts claiming not only the right to control the temporalities of the Church, but also the power to rule in spiritual affairs. In 1834 the General Assembly passed the 'Veto Act,' under which the Church courts might reject a 'presentee' of the State, if by them deemed unfit for his office. This act was annulled by the civil courts and the House of Lords in 1839. The Assembly could not agree thus to surrender what it believed to be a right bestowed by the head of the Church. The collision between the civil and ecclesiastical courts was so direct that those who held to the independence of the Church saw only one way of relief, which was to leave the established Church. Therefore, in 1843, 470 members, under the lead of Chalmers, Candlish (qq.v.), and others, signed an "Act of Separation, and Deed of Demission," and the Free Church of Scotland was the result. It renounced all benefits of establishment, but expressed its firm adherence to the doctrine and maintained the forms of worship and discipline of the Church of Scotland.

The United Free Church of Scotland was the result of a movement toward union between the two great bodies which had left the established Church. On October 31, 1900, a Uniting Act was formally adopted by the Free Church Assembly and the United Presbyterian Synod sitting in Edinburgh. On the following day the ministers of the two churches, some 3000 in number, marched in procession from their respective halls to Waverly Market, where they convened as the first General Assembly of the United Free Church. Principal Rainy was the first moderator. The new Church received from the United Presbyterian Church 637 ministers and 199,089 communicants; from the Free Church, 1149 ministers and 296,089 communicants. A minority of 27 ministers and 500 elders voted against the union, and resolved to continue the Free Church.

The Reformed Church of Scotland, descended from the Covenanted Church, glories in its adherence to the principles for which Cameron, Renwick, and Cargill shed their blood. In 1660 the Act of Supremacy was passed, which constituted the King supreme judge in all matters, civil or ecclesiastic; and the oath of allegiance, which declared it to be treason to deny the supremacy of the King in Church and State, was imposed. The Covenanters asserted their belief in the covenants, and renounced their allegiance to the King on the ground that he had broken his vow, made at his coronation, and had forfeited his right to rule. As a matter of course persecution followed, the leaders perished on the scaffold, and the people were left without a head. They resolved themselves into

societies for worship and mutual edification. This caused them to be called the 'Society People,' though they spoke of themselves as the 'Persecuted Remnant.' Later the spirit of compromise entered the Church, and in the desire to comply with the King's wish to include as many as possible of the prelatic clergy, the Church received a large number of the very men who had been most earnest in its persecution under the old régime. The 'Society People' could not approve of the conduct of either King or Church, and it was therefore impossible for them to identify themselves with the Established Church. For lack of sufficient number of ministers, the first presbytery of this people was not formed till August 1, 1743; but from this time the Reformed Presbyterian Church went steadily forward, adhering to its peculiar principles with great firmness of purpose, increasing, indeed, with such rapidity that it was for a time beyond its power to supply ministers sufficient for the needs of the people. Later, however, it gradually declined, and nearly all its members joined either the Free or the United Presbyterian Church of Scotland.

THE PRESBYTERIAN CHURCH OF ENGLAND. In England the principles of the Puritans were practically Presbyterian, although they were for the most part more concerned with resistance to power, exercised as they believed against the Word of God, than with the development of Church government. Still the ministers of London and its vicinity organized a presbytery at Wandsworth, in Surrey, in 1572, and other presbyteries followed in spite of the hostility of Queen Elizabeth. In July, 1643, in obedience to a summons from Parliament, the Westminster Assembly met in Westminster Abbey and continued in session until 1647. The documents known as the Confession of Faith, the Form of Church Government, the Directory for Worship, and the Larger and Shorter Catechisms, drawn up by this assembly, were approved by Parliament in 1648. (See CREEDS AND CONFESSIONS.) Parliament in 1647 passed an ordinance making Presbyterianism the established religion of England, but this law never went into practical effect. When Cromwell and the Independents came into power, their influence was thrown against Presbyterianism, partly perhaps because of the resistance of the latter to the trial and execution of Charles I. After the Restoration, by command of Charles II., the Savoy Conference (q.v.) was held at the residence of the Bishop of London in 1661. The purpose was, nominally, to alter and reform the Liturgy in such a way as to meet the feelings of those who had serious scruples against its use. The negotiations were a failure, as the bishops refused to make any changes. This conference was followed by the Act of Uniformity, which took effect August 24, 1662. Two thousand ministers who would not consent to abjure the Solemn League and Covenant, or to be episcopally reordained, resigned their charges or were ejected from them. Sixty thousand church members were imprisoned or fined, five thousand of whom died in prison. After the Revolution and the Act of Toleration in 1689, Presbyterianism flourished again. In 1691 the Presbyterians entered into articles of agreement with the Independents, giving up presbyteries and synods. Arian and Socinian doctrines prevailed to such an extent that the name Pres-

byterian became synonymous in England with Unitarian. In the meantime, there existed in England a few congregations connected with the Scottish Church formerly known as the Secession Church, later as the United Presbyterian Church. At the formation of the Free Church of Scotland, the greater number of the English churches connected with the Church of Scotland espoused the cause of the Free Church, and took the name of the *Presbyterian Church of England*. On June 18, 1876, the first synod of the Presbyterian Church of England was constituted by the union of the Presbyterian Church and the United Presbyterian. The united Church has grown from 263 congregations, in 1876, to 311 in 1900. They carry on an extensive home and foreign missionary work.

THE IRISH CHURCH. The history of Presbyterianism in Scotland is also essentially its history in Ireland. The first presbytery in Ireland was organized in 1642 by Scotch chaplains accompanying the army sent there to subdue the 'Great Rebellion' of that period. The Presbyterian population increased by immigration from Scotland. Early in the eighteenth century doctrinal differences began to appear, and in 1726 a schism took place. Those who would not subscribe to the Westminster Confession formed themselves into the *Presbytery of Antrim*. The orthodox body was called the *Synod of Ulster*. Scotch Seceders, coming over in the middle of the eighteenth century, did much to maintain purity of doctrine in the northern provinces. Owing to laxity of doctrine in the Irish Church, the Covenanters made steady progress, and in 1792 their first Irish presbytery was formed. In 1835 the Synod of Ulster endeavored to stem the tide of lax doctrine by requiring subscription to the Confession of Faith. The grounds of separation between them and the Seceders being thus removed, a union was happily consummated in 1840. The General Assembly of the Presbyterian Church of Ireland consisted at its organization of 433 congregations. It has steadily increased and now numbers nearly seven hundred ministers, with more than one hundred thousand communicants.

The Presbyterian Synod of Seceders in Ireland was formed in 1818 by a union between the two sections of the Scottish Secession Church in Ireland, the Burghers and the Anti-Burghers. The division arose in Scotland in 1747 in regard to the propriety of an oath administered to the burghesses which pledged the taker to support "the true religion presently professed within the realm and authorized by the laws thereof." Those who defended the taking of the oath were called the Burghers; those who condemned it the Anti-Burghers. This controversy spread to Ireland. At the time of the union of these two bodies there were 97 ministers. In 1840 the Synod of Seceders united with the Synod of Ulster, taking the title of the *Presbyterian Church in Ireland*.

THE CALVINISTIC METHODIST OR PRESBYTERIAN CHURCH OF WALES has been Calvinistic in its doctrine from its beginning. In 1735-36 Howell Harris, Howell Davis, and Daniel Rowlands began to preach in different parts of Wales. Whitefield heard of them and worked with them, and for a short time the Calvinistic Methodists of Wales were associated with the Methodists of England, but after 1748 Whitefield ceased to act

as their head and their connection with England was gradually broken off. In 1811 they held a General Synod at Bala, when 21 persons were ordained to the ministry. In 1864 the churches of North and South Wales came under the control of one General Assembly. In this Church every elder is a member of presbytery. In 1901 it reported 158,114 members, with total collections of \$1,419,515. There is a branch of this Church in the United States, with 186 congregations and 108 ministers.

THE PRESBYTERIAN CHURCH OF THE BRITISH COLONIES. In Canada the Presbyterian Church dates from the Conquest in 1759. Its first preacher is supposed to have been the Rev. George Henry, chaplain of a British regiment stationed in Quebec. In Montreal the first Presbyterian church was organized in 1790. In Upper Canada the pioneers of Presbyterianism were from the Reformed Dutch Church. One of the earliest missionaries was the Rev. Robert McDowell, who was sent by the Classis of Albany in 1798. Other ministers were sent from Scotland, and later, with immigrants from Scotland and the north of Ireland, Presbyterianism took firm root in Canada. In 1831 *The Synod of the Presbyterian Church of Canada* was formed in connection with the Church of Scotland. It consisted of 25 ministers. The Secession Church of Scotland was also represented, and was known as the *Synod of the United Presbyterian Church in Canada*. In 1844, after the disruption in Scotland, a division took place in the Presbyterian Church in Canada, and 25 ministers withdrew, calling themselves the *Presbyterian Church of Scotland*. In 1861 this body and the United Presbyterian Church in Canada united under the name of the *Canada Presbyterian Church*, with a roll-call of 226 ministers. The same churches in the lower provinces also united as the *Presbyterian Church of the Lower Provinces*. After the confederation of the provinces which now form the Dominion of Canada, there arose a natural desire for an ecclesiastical union which had long been contemplated. Negotiations were begun in 1870, and the union was happily brought about June 15, 1875, in the city of Montreal, the Church thus united numbering 634 ministers and 90,658 communicants.

There are also Presbyterian churches in all of the other colonies. The *Australian Presbyterian Church* was founded while that country was still a penal colony. In 1836 the first Presbyterian minister was there in the person of Rev. Mr. Clow, a retired chaplain of a Highland regiment. The representatives of the different forms of Presbyterianism united in 1867 on the abolition of State aid. There were in 1900 six Assemblies or General Synods in Australia and Tasmania, comprising about 1000 ministers and 55,000 communicants, with total contributions to all purposes of about \$980,000. In August, 1901, the Presbyterian churches of Australia united and signed the deed in Sydney, the Rev. Dr. Meiklejohn being the first moderator of the new body.

The New Zealand Presbyterian Church was founded about the year 1840. In 1900 it comprised two assemblies—the Otago and the Southland—with 201 ministers and about 26,000 communicants, and its contributions were about \$310,000. On October 31, 1901, these two bodies united and now form the Presbyterian Church

of New Zealand. The first united Assembly was held in Dunedin and the Rev. James Gibbe was made moderator.

The *Presbyterian Church of South Africa* comprises three branches: The General Assembly of the Presbyterian Church of South Africa, the Synod of the Free Church Mission of Kaffraria, the Synod of the Presbyterian Church of Basuto Land. They had in 1900 71 ministers and about 18,000 communicants, and raised about \$73,000.

The *Presbyterian Church of Jamaica* numbers 30 ministers and about 12,000 communicants, and contributes about \$340,000.

THE PRESBYTERIAN CHURCH IN THE UNITED STATES was founded by the Scotch, Irish, French, German, and Dutch Reformed immigrants to this country. Fugitives from persecution, they took refuge in the more liberal colonies of Pennsylvania, Maryland, New Jersey, Virginia, and the Carolinas, and some in New England. The founding of a Presbyterian colony on Massachusetts Bay took place in 1625. With the arrival of more colonists in 1629 a church was fully constituted under the Rev. Samuel Skelton. Christ's Presbyterian Church was established at Hempstead, Long Island, in 1644. The Rev. Francis Doughty, an English Presbyterian minister, was the first Presbyterian to preach in New York. He ministered there from 1643 to 1648. A Presbyterian Church, however, was not organized until 1717. Francis Makemie, an Irish minister of the Presbytery of Laggan, is considered the father of organized Presbyterianism in America. He founded several churches in Maryland and Virginia. Later he crossed the ocean to appeal to the mother Church for help. In 1707 he was imprisoned in New York for preaching without permission, for at that time the Episcopal Church was practically the established Church, and no dissenter was allowed to preach without a license. In the meantime other Presbyterian churches had been founded, one in Freehold, N. J., in 1692, one in Philadelphia, in 1698, under the care of Jedediah Andrews. The first American presbytery was organized in Philadelphia, probably in 1706—the precise date having been lost—and consisted of seven ministers, Francis Makemie, Samuel Davis, John Hampton, and George McNish, from Ireland; Nathaniel Taylor and John Wilson, from Scotland; and Jedediah Andrews, from New England. The growth of the Church was rapid, and in 1716 the Synod of Philadelphia was formed, consisting of four presbyteries: Philadelphia, with six ministers and churches; New Castle, six ministers and churches; Snow Hill, three ministers and churches; Long Island, two ministers and several churches. There is no record at this time that any standards of doctrine had been adopted by the Synod, although as most of the ministers were of Scotch descent, it is probable that the Westminster standards were those to which the young Church adhered. In 1729, by an 'adopting act,' the Synod made the Westminster Confession of Faith their doctrinal standard, "as being in all the essential and necessary articles good forms of sound words and system of Christian doctrine." They also agreed that no one should be ordained to the ministry or received into membership who had scruples as to the Confession, "save only about articles not essential and necessary to doctrine, worship, and government." The ministers from abroad, however, were more

strict in their doctrinal ideas, and laid more stress on scholarship, than the native ministers, who insisted more on a living Christian experience, and who, in view of the great needs of the new country, were disposed to receive into the ministry students who were sound in doctrine, but whose opportunities for education had been limited. In 1739 party feelings were stirred by the visit of George Whitefield, and the Synod was divided into a party warmly befriending revivals and a party standing aloof from that form of work. By 1741 this dissension resulted in a schism and two Synods were formed: the *Old Side*, called the *Synod of Philadelphia*, insisting on a thoroughly educated ministry; the *New Side*, or *Synod of New York*, which laid more stress on piety and zeal. There was but slight difference between the two bodies as to doctrine or discipline. After a separation of thirteen years this breach was healed and the two Synods united under the title of the *Synod of New York and Philadelphia*, with more than 100 churches under its care.

At this time the tide of population was flowing rapidly westward. The frontier communities contained many men of lawless habits. Hostile Indians were numerous. The opposition of the State Church added to the difficulties of the Presbyterian pioneer. Men of education and strength of character were needed. The Church found them in the Tennents of New Jersey, Brainerd, the missionary to the Indians, Davies, of Virginia, and many others whose work still lives in the Christian communities they established. In 1766, fearful of the legal establishment of the Church of England, the Synod agreed to meet in annual convention with the General Assembly of Connecticut "to unite their endeavors and counsels for spreading the Gospel and preserving the religious liberties of the Church." This arrangement was continued till the war of 1776.

During all the struggle of the United States for independence the Presbyterians stood as one man for the defense of the civil and religious liberty of the country. John Witherspoon, one of its most prominent ministers, was a signer of the Declaration of Independence, and before Congress made one of the most effective pleas for the liberty of our country. Although during the Revolutionary War many buildings were destroyed and congregations disbanded, still the vitality of the Church continued, and when peace was restored it grew so rapidly that the need of a General Assembly became evident. In 1785 a large committee was appointed to consider a form of complete organization for the Presbyterian Church in the United States. In May, 1788, the Synod met and resolved itself into a General Assembly, which held its first meeting in Philadelphia the following year. The first Congress of the country was in session in New York at the same time. The first General Assembly embraced 4 synods (New York and New Jersey, Philadelphia, Virginia, and the Carolinas), 17 presbyteries, 419 congregations, and 180 ministers. This Assembly adopted the Westminster Confession of Faith after making changes in chapters 20, 23, and 31, and the Larger and Shorter Catechisms. The form of government of the Scottish Church was also adopted, but modified so as to deny to the civil magistrate any right of interference in Church affairs, except for protection only.

In 1801 a plan of union was agreed upon between the Presbyterian Church and the Connecticut General Association which provided terms for mutual help in the weaker communities. Presbyterian ministers might serve Congregational churches and vice versa.

The Presbyterian Church, at the time of the union, numbered 26 presbyteries, 300 ministers, and nearly 500 congregations. Early in the century there were many revivals, especially in the southwestern part of the country, which brought into service many as catechists and exhorters who were neither highly educated nor firm believers in the peculiar doctrines of the Presbyterian Church. The controversy over these questions brought about the secession of the Presbytery of Cumberland, and resulted in 1810 in the formation of the Cumberland Presbyterian Church (see below). The beginning of the nineteenth century showed increased zeal on the part of the Presbyterian Church for missionary enterprise. Within a few years, in New York, Pennsylvania, and New England, missionary societies were formed to send the Gospel to the Indians and among the pioneers. In 1802 the General Assembly organized a 'Standing Committee of Missions' consisting of 7 members, later increased to 19 members, whose duty it should be "to collect during the recess of the Assembly all the information in their power relative to the concerns of missions and missionaries," and to "superintend generally under the direction of the Assembly the missionary business." In 1816 the title of the committee was changed to Board of Missions, and it was authorized to act with a larger measure of independence. The growth of the Church was rapid. In 1834 it contained 32 synods, 111 presbyteries, and about 1900 ministers. At this time signs of the future schism which divided the Church for so many years into the 'Old' and 'New' schools became apparent. For some time there had existed a diversity of doctrinal beliefs among the ministers and churches. New doctrines, coming largely from New England, were adopted by the members of the New School party. In the Old School branch there was a leaning to the strict doctrine and discipline of the Scotch Church; Albert Barnes (q.v.), of Philadelphia, and Lyman Beecher (q.v.), of Lane Seminary in Cincinnati, were both subjected to trial and censure by their presbyteries. The Church was shaken by the controversy. The agitation over slavery divided it still further. The New School party felt called upon to denounce it, while the Old School thought that duty did not require that the Church should pronounce on the subject. In 1837 the Assembly, having (for the first time in five years) a majority of Old School members, disowned or excised three of the synods of western New York and one in Ohio, with all the churches and ministers belonging to them. Great excitement prevailed throughout the Church. A meeting of the excluded synods was held at Auburn, New York, in August, 1837, as the true constitutional Assembly, at which trustees were appointed for the care of the property of the corporation. These trustees later brought legal action to determine their rights, and a verdict was given in their favor, but on appeal to a higher court the decision was overruled on points of law, and a new trial granted. The matter was not pressed further. In 1838 the New School members demanded

enrollment for the excluded commissioners of the preceding year. This was refused and the bodies separated, each claiming to have the constitutional succession, and using the title the General Assembly of the Presbyterian Church in the United States of America. The Old School Church had seminaries at Princeton, N. J.; Allegheny, Pa.; Columbia, S. C.; Danville, Ky., and Chicago. The New School seminaries were Union, N. Y.; Auburn, N. Y.; Lane, at Cincinnati; and Blackburn, Ill. Each Church carried on its work with great zeal, both at home and abroad; each branch was active in encouraging educational institutions, and as they flourished side by side, each grew more confident of the orthodoxy and usefulness of the other. The Old School Assembly of 1837 had organized its Board of Foreign Missions, and it continued to support the Boards of Home Missions and of Education which had been organized before the division. The New School carried on its home mission work through the American Home Missionary Society. Later, however, it organized permanent committees on Home Missions, Education, and Publication, through which its work was carried on, while its foreign work was conducted through the American Board of Commissioners for Foreign Missions.

But now signs of the approaching national storm began to appear. In 1858 the southern part of the New School Church, dropped off and organized under the title of the *United Synod of the Presbyterian Church, South*. A hundred ministers and 200 churches constituted this synod, which remained a separate organization until 1864, when it joined the General Assembly of the Southern Presbyterian Church. In 1861 the Old School branch suffered a similar defection, as the Assembly of that year took action which grieved the Southern commissioners, who withdrew and organized the *Southern Presbyterian Church* (see below). With the abolition of slavery and the close of the Civil War a new spirit arose in the two branches of the Church in the North. The New School has proved its soundness in the faith, and the inheritance of a common ancestry asserted itself. In 1866 the two Assemblies met in Saint Louis, and for the first time in a generation partook of the Lord's Supper together. A committee was appointed to consider plans for union, these plans were submitted to the various presbyteries, and in 1869 the two Assemblies met and paved the way for the union which was consummated in November, 1869, in Pittsburg. The next year both Assemblies met in the First Church of Philadelphia as one body. At this time the ministers numbered 4238, the churches 4526, and the members 446,561. In 1888 the General Assembly celebrated in the city of Philadelphia the first century of its organization. In 1788, at the time of the first Assembly, there were but 419 churches and not more than 20,000 communicants. At the centennial there were 6436 churches reported, and about 700,000 communicants.

In 1889 the General Assembly received overtures from a number of presbyteries asking for some revision of the doctrinal standards. In reply that Assembly sent overtures to all the presbyteries asking whether revision were desired, and to what extent. About two-thirds of the presbyteries expressed a desire for revision, and the Assembly of 1890 appointed a committee on re-

vision, consisting of 15 ministers and 10 ruling elders. This committee presented a report in 1892 recommending sundry changes in the Confession of Faith. This report was sent to the presbyteries, affirmative votes from two-thirds of the presbyteries being needed to secure the adoption of the submitted changes. During this discussion the Church was agitated by the trial of Prof. Charles A. Briggs of Union Theological Seminary on the charge of heresy. This so unsettled the mind of the Church that many who under ordinary circumstances would have voted for revision believed it an inopportune time to subject the standards to discussion or change. The overtures from the Assembly therefore failed of the constitutional majority and revision was for the time abandoned. The demand for some modification of the Confession continued, however, and by 1900 had become so general that the Assembly of that year appointed another committee of 15 to consider the whole question of a restatement of doctrine. It reported progress in 1901, was enlarged and continued with instructions to report the next year. At the Assembly of 1902 in the city of New York a unanimous report was made. The committee recommended that additional statements concerning the love of God for all men, missions, and the Holy Spirit be added in the form of new chapters to the Confession of Faith. It recommended a declaratory statement in reference to chapter iii. and chapter x., section 3; and textual modifications in chapter xvi., section 7; chapter xxii., section 3; chapter xxv., section 6. These by direction of the General Assembly were transmitted to the presbyteries for their action—report to be made to the Assembly of 1903. The committee also presented a brief statement of the Reformed Faith in 16 articles which was designed not to take the place of the Confession of Faith as a doctrinal standard of the Presbyterian Church, but to be an interpretation of it. This "Brief Statement of the Reformed Faith" was adopted with only two dissenting voices. It relates to the principal subjects of the Reformed Faith such as the Being of God, revelation, the eternal purpose, the creation, the sin of man, the grace of God, election, the Holy Spirit, the resurrection, and the life to come, the Church and the sacraments, the last judgment, and Christian service.

The great national expansion following the war with Spain in 1898 gave a marked advance to the missionary operations of the Church. The field of home missions, which already extended to Alaska, was widened to include Porto Rico, and, later, Cuba, while in the Pacific the Philippine Islands were added to the vast foreign missionary territory.

The Presbyterian Church has also been true to her historic devotion to education, secular and sacred. Presbyterian academies and colleges are found in all the States and Territories, while 13 theological seminaries under the care of the Assembly provide for the Church an educated ministry. They are as follows: Princeton Theological Seminary, at Princeton, N. J. (founded 1812); Auburn Theological Seminary, at Auburn, N. Y. (1820); Western Theological Seminary, at Allegheny, Pa. (1827); Lane Theological Seminary, at Cincinnati (1832); Union Theological Seminary, New York (1836); McCormick Theological Seminary, at Chicago (under General As-

sembly 1859); Danville Theological Seminary, at Danville, Ky. (1859); San Francisco Theological Seminary, at San Anselmo, Cal. (1871); the Theological Seminary at Omaha, Neb. (1891); and two German theological seminaries, at Bloomfield, N. J. (1869), and at Dubuque, Iowa (1852). There is also a theological department in connection with Biddle University for Freedmen, established in 1868, and with Lincoln University at Oxford, Pa., established in 1871; both of these are supplying ministers for the colored population. For further details, see the separate articles on the more important of the institutions named above.

THE PRESBYTERIAN CHURCH IN THE UNITED STATES. In May, 1861, the General Assembly, meeting in Philadelphia, adopted a paper in reference to the Civil War, which asserted the loyalty of the Church to the Union and promised the support of all its churches and ministers to the Federal Government. The Southern Presbyterians, feeling that the Church had exceeded her rights in pronouncing on a political question, "concluded that a separation from the General Assembly aforesaid was imperatively demanded. Not in the spirit of schism, but for the sake of peace and for the protection of the liberty with which Christ had made them free." Accordingly the representatives of 47 presbyteries commissioned for that purpose met in Augusta, Ga., on December 4, 1861, and organized a new Assembly, designated as the *Presbyterian Church in the Confederate States of America*. After the war, however, the word *United* was substituted for *Confederate*, and of *America* was dropped. The Southern Presbyterian Church disavows all connection with political matters, and emphasises its purely ecclesiastical mission. The words of the Rev. Dr. B. M. Palmer, in 1886, voice the sentiment of the Church: "The simple fact remains that we were separated from the Church of our fathers upon a strictly political issue, which a spiritual court had no authority, either human or divine, to adjudicate. Whether we ourselves fully comprehended or not the significance of our withdrawal, the logic of the case constituted us the asserters and guardians of this vital truth, the non-secular and non-political character of the Church of Jesus Christ, and whether we will or no, we must preach to the world this Gospel of the Kingdom." At the time of its organization the Southern Church included 10 synods, 47 presbyteries, about 700 ministers, and 75,000 communicants, of whom 10,000 were of the African race. The missionary work of the Church is conducted by permanent committees, and is carried on in many foreign lands, as well as in our own country. The interests of Publication and Colored Evangelization are also conducted by efficient committees. The standards of the Church are: The Westminster Confession of Faith, the Larger and Shorter Catechisms, the Form of Government and Directory for Worship, somewhat altered to suit the circumstances of the Church. Every Church officer is required to adopt them.

This Church has theological seminaries at Richmond, Va. (Union Theological Seminary), and Columbia, S. C. (Columbia Theological Seminary). The seminary at Louisville and Danville Seminary have been united and the seminary is now at Louisville, Ky. There are also theological departments in connection with the University of

Texas and the Southwestern Presbyterian University at Clarksville, Tenn.

THE CUMBERLAND PRESBYTERIAN CHURCH was organized in Tennessee on February 14, 1810, by three Presbyterian ministers, Finis Ewing, Samuel King, and Samuel McAdow. They called the organization the Cumberland Presbytery. This act was the crisis of a movement begun a dozen years earlier, the great spiritual revival which had stirred that part of the Southwest, under the leadership of James McGready and others. This revival was widespread, and its converts were so many that the demand for ministers was far in excess of the number the Church could furnish. Under the advice of some of the most honored ministers of the time, men of approved intelligence and religious character were chosen as exhorters, even though they had not had the education usual to candidates for the ministry. The urgency of the need seemed to the Revival Party a sufficient reason for the custom. The men so ordained were permitted to adopt the Westminster Confession of Faith with the exception of 'the idea of fatality.' The controversy along these two lines increased till it resulted in the formation of the new Church. In 1813 the Cumberland Presbytery had so increased as to make necessary its division into three presbyteries and the formation of a synod. One of its first acts was to appoint a committee to prepare a Confession of Faith. This committee simply modified the Westminster Confession, the chief changes being in chapters iii. and x. The Presbyterian polity was retained. Before the Civil War there were about 20,000 colored Cumberland Presbyterians worshipping with the white congregations. In 1869, however, the colored people asked and received consent of the General Assembly to the organization of the African Cumberland Presbyterian Church. The Cumberland Presbyterian Church has a theological seminary at Lebanon, Tenn.

THE UNITED PRESBYTERIAN CHURCH OF NORTH AMERICA was organized in Pittsburg, Pa., on May 26, 1858, by a union of the Associate and the Associate Reformed churches. By one line the United Presbyterian Church is descended from the Covenanters of Scotland, by the other line it is descended from a body of men who were imbued with the ideas which later brought forth the Free Church of Scotland. The basis of the union was the Westminster Standards together with a 'Testimony.' The Testimony consists of 18 articles designed to set forth the views of the Church on "certain points not distinctly introduced into the Confession of Faith." The Church holds to a restricted communion; it has been and still is distinguished by its attitude on the subject of Church psalmody, using only the Psalms for its worship of song. In 1881 the General Assembly by a very small majority repealed the rule

forbidding the use of instrumental music in the worship of God. The United Presbyterian Church has always maintained a high standard for the ministry. As early as 1794 the Associate Church established a theological seminary in Pennsylvania, the first on the Continent. Other seminaries and colleges have been founded. Home and foreign mission work has prospered as well as freedmen's work, publication, and ministerial relief. At the union, in 1858, there were 408 ministers, and the contributions were \$253,150 for all purposes. The United Presbyterian Church has two theological seminaries—one at Allegheny, Pa., founded in 1825, and one at Xenia, Ohio, founded by the Associate Synod in 1794 at Service, Pa., removed to Canonsburg in 1821, and to Xenia, Ohio, in 1825.

THE REFORMED PRESBYTERIAN SYNOD was founded in 1743 by members of the Covenanting or Reformed Presbyterian Church of Scotland. In 1798 a presbytery was organized in Philadelphia. In 1800 it enacted a law that no slaveholder should be a communicant, a position always maintained. Members of this Church neither vote at political elections, enlist in the army, nor serve on juries. In 1833 the questions relating to the extent of severance between Church and State led to the disruption of the Church, the *General Synod of the Reformed Presbyterian Church* being formed of those who, while adhering to the Standards, permitted their members to discharge the duties of citizens. This body has a theological seminary at Philadelphia, founded in 1807. The Reformed Presbyterian Church (Covenanter) has a theological seminary at Allegheny City, Pa.

THE ASSOCIATE REFORMED PRESBYTERIAN SYNOD OF THE SOUTH was organized in 1803 at Brick Church, Fairfield County, South Carolina. Until 1822 it was connected with the General Synod, composed of the Synods of New York and the West. But the General Synod always met in New York, and as the Southern men could so seldom attend, it was decided in 1822 to become an independent synod. The separation was not on account of slavery or sectionalism. It has churches in every Southern State and flourishing mission work in Mexico. Its educational institutions are Erskine College, Erskine Theological Seminary, and Due West Female College, all located at Due West, S. C.

THE ASSOCIATE SYNOD OF NORTH AMERICA is a small body which declined to enter the union which in 1858 constituted the United Presbyterian Church. It has twelve ministers and about a thousand members, and coöperates with the original Seceders of Scotland in mission work in India.

STATISTICS. The following tables give the latest available figures for the different Presbyterian churches:

	Presbyteries	Ministers	Churches	Church members	S. S. pupils	Home work	Foreign work
Pres. Ch. in United States America.....	233	7,617	7,748	1,045,338	1,063,683	\$1,203,453	\$898,079
Pres. Ch. in United States.....	79	1,501	3,017	229,642	149,482	162,614	151,756
United Pres. Ch.....	69	1,030	998	119,358	121,030	87,531	146,772
Cumberland Pres.....	118	1,719	2,944	184,493	111,772	83,459	40,046
Reformed Pres. Synod.....	12	126	112	9,722	10,644	5,141	22,317
Welsh Pres. or Calvinistic Methodist	184	93	1,300	1,400	2,000	2,000
Associate Reformed Synod of the South.....	9	104	151	11,903
Reformed Pres. Ch., Gen. Synod.....	38	45	5,394	2,567	3,189
Pres. Ch. in Canada.....	1,368	1,492	219,670	182,335	195,000	158,561

	Presby- teries	Church members	Sunday school pupils
Church of Scotland.....	84	661,629	222,944
United Free Church of Scotland.....	64	488,795	362,372
Presbyterian Church of England.....	12	78,037	89,584
Presbyterian Church of Ireland.....	37	106,487	108,668
Reformed Presbyterian Church of Ireland.....	4	4,000	3,500
Calvinistic Methodist or Presbyterian Church of Wales.....	24	160,000	200,000

BIBLIOGRAPHY. W. Stephen, *History of the Scottish Church* (2 vols., Edinburgh, 1894-96); Hetherington, *History of the Church of Scotland* (7th ed., ib., 1848); Reid, *History of the Presbyterian Church in Ireland* (3d ed., by Killen, Belfast, 1867); Killen, *Ecclesiastical History of Ireland* (2 vols., London, 1875); Hodge, *Constitutional History of the Presbyterian Church in the United States of America* (Philadelphia, 1840); Gillet, *History of the Presbyterian Church in the United States of America* (2 vols., ib., 1873); Glasgow, *History of the Reformed Presbyterian Church in America* (Baltimore, 1888); Harper, *The Church Memorial, Containing Important Historical Facts and Reminiscences Connected with the Associate and Associate Reformed Churches* (Xenia, Ohio, 1859); Hays, *Presbyterians: A Popular Narrative of Their Origin, Progress, Doctrines, and Achievements* (New York, 1892); Latham, *History of the Associate Reformed Synod of the South* (Harrisburg, 1882); Lindsley, "Sources and Sketches of Cumberland Presbyterian History," in the *Theological Medium* (Nashville, 1877-78); McDonnold, *History of the Cumberland Presbyterian Church* (ib., 1888); *Centennial Historical Discourses* (Philadelphia, 1876); *Addresses Delivered at the Centennial Celebration of the General Assembly of the Presbyterian Church, Philadelphia, May 23, 1888* (ib., 1888); Nevin, *Encyclopædia of the Presbyterian Church in the United States of America* (ib., 1884); Sprague, *Annals of the American Pulpit*, vols. iii., iv., ix. (New York, 1869); Briggs, *American Presbyterianism* (ib., 1885); R. E. Thompson, *A History of the Presbyterian Churches in the United States*, in the "American Church History Series" (ib., 1895); C. L. Thompson, *The Presbyterians*, in the "Story of the Churches Series" (ib., 1903).

PRESBYTERY (ML. *presbyterium*, from Gk. *πρεσβυτέριον*, assembly of elders, from *πρεσβύτερος*, *presbyteros*, elder). Generally, the body or class of presbyters or elders in the Christian churches taken collectively. More specifically, in the churches having a Presbyterian form of government, it is one of a series of judicatories, ranking next above the session, the court of a local church, and below the synod (qq.v.). The presbytery as an ecclesiastical judicatory is most completely developed in the Presbyterian Church in the United States of America, where its composition and powers are defined in the Form of Government as follows: "A presbytery consists of all ministers, and one ruling elder for each congregation, within a certain district. The presbytery has power to receive and issue appeals from church sessions, and references brought before them in

an orderly manner; to examine and license candidates for the holy ministry; to ordain, install, remove, and judge ministers; to examine and approve or censure the records of church sessions; to resolve questions of doctrine or discipline seriously or reasonably proposed; to condemn erroneous opinions which injure the purity or peace of the Church; to visit particular churches for the purpose of inquiring into their state and redressing the evils that may have arisen in them; to unite or divide congregations, at the request of the people, or to form and receive new congregations; and in general to order whatever pertains to the spiritual welfare of the churches under their care." Such a presbytery corresponds to a classis in the Reformed churches. The name presbytery is also commonly applied in the Roman Catholic Church to the pastoral residence of the priest or priests of a parish.

PRESBYTERY. The space in the choir of a church in which the high altar is placed; the name is sometimes extended to the whole choir, but is usually applied to the part inclosed in mediæval churches by the choir-stalls.

PRESCOTT. A city, formerly the capital of the Territory of Arizona, and the county-seat of Yavapai County, 137 miles north of Phoenix; on the Santa Fe, Prescott and Phenix Railroad (Map: Arizona, B 2). The city is situated at an elevation of over 5000 feet, in a rich gold, copper, and silver mining country. The industries include stock-raising and lumbering. There is a public library. Population, in 1890, 1,759; in 1900, 3,559.

PRESCOTT, ALBERT BENJAMIN (1832—). An American chemist, born in Hastings, N. Y. He studied medicine at the University of Michigan, and was made dean of the school of pharmacy there in 1876 and director of the chemical laboratory in 1884. He wrote *Qualitative Chemical Analysis* (1874), *Outlines of Proximate Organic Analysis* (1875), *First Book of Qualitative Chemistry* (1879), *Manual of Organic Analysis* (1888), *Periodides* (1896), and *Assay of Alkaloidal Drugs* (1899).

PRESCOTT, GEORGE BARTLETT (1830-94). An American electrician, born at Kingston, N. H. He learned telegraphy soon after the system had been put into practical use, and by 1858 had become superintendent of the lines of the American Telegraph Company. In 1866 he was given the same position in the Western Union Company; from 1873 until 1880 was electrician of the International Ocean Telegraph Company; was one of the early promoters of the telephone; and was connected with numerous telegraph and telephone companies. In 1852 he discovered that the aurora borealis is an electric phenomenon, and the discovery, accounts of which he published in the *Boston Journal* and the *Atlantic Monthly*, attracted much attention among scientists. He invented an improvement in telegraph insulators in 1872; with Thomas A. Edison invented and introduced the duplex telegraph and the quadruplex telegraph; and also introduced from Europe the system of sending messages in pneumatic tubes. He published: *History, Theory, and Practice of the Electric Telegraph* (1860); *Electricity and the Electric Telegraph* (1877); *The Speaking Telephone* (1878); *Dynamo-Electricity* (1884); *Bell's Electric Speaking Telephone* (1884); and *The Electric Telephone* (1890).

PRESCOTT, OLIVER (1731-1804). An American soldier; born at Groton, Mass. He graduated at Harvard in 1750, became brigadier-general of militia for the County of Middlesex, and a member of the Board of War in 1776. From 1777 to 1780 he was a member of the Supreme Executive Council of State, in 1779 was made judge of probate for the County of Middlesex, and in 1781 was promoted to the rank of second major-general of State militia. In 1786-87 he took a prominent part in the suppression of Shays's Rebellion.

PRESCOTT, WILLIAM (1726-95). An American soldier, born at Groton, Mass. In 1755 he served with distinction as lieutenant and captain under Wilson in an expedition against Nova Scotia, but at the end of the war declined a commission in the Regular Army offered him by the British general, and retired to his large estate in Pepperell. There he remained until the battle of Lexington, when he organized a regiment of minute men, and marched as its colonel to Cambridge. On June 16th he was ordered to Charlestown, and threw up intrenchments at Breed's Hill, near Bunker Hill. In the next day's battle, during which he is generally considered to have been the patriot commander, he displayed great bravery, and was the last to leave the field. After serving about two years longer, he returned to his farm, but again served as a volunteer for a short time at Saratoga in 1777. He was subsequently a member of the Massachusetts Legislature for several years. Consult Parker, *Colonel William Prescott, the Commander in the Battle of Bunker's Hill* (Boston, 1875).

PRESCOTT, WILLIAM HICKLING (1796-1859). An American historian. He was the son of a distinguished lawyer and statesman and grandson of Col. William Prescott, and was born at Boston, May 4, 1796. He entered Harvard College in 1811, as a sophomore, and graduated in 1814. While there he lost the sight of one eye by an accident, and the other was so affected that he had to pass several months in a darkened room. He partly recovered the sight of it, but he could use it only a little each day and never in any difficult work. He entered his father's law office, but in January, 1815, the injured eye became inflamed and refused to yield to remedies; so it was determined in the autumn that he should seek health by wintering at Saint Michael's and get medical advice in the spring. At the Azores, where he often had to live in a darkened room, he acquired the accomplishment of learning almost by heart long passages which he had thought out and which he meant to have written. Physicians told him that the sight was hopelessly gone from one eye, and that the preservation of the other depended on his health. Prescott now returned to Boston and on May 4, 1820, married Miss Susan Amory. A legal career was, of course, out of the question, but Prescott's family were well off; so his half blindness was not made still more cruel by the trammels of poverty. Having at this time decided to devote himself to literature, he set to work on the study of Murray's *Grammar*, Johnson's *Dictionary*, Blair's *Rhetoric*, and the English classics from Elizabethan times to his own. The reading of Gibbon's autobiography increased his passion for historical writing. In 1820 he contributed to the *North American Review* a review of Byron's *Let-*

ters on Pope. He soon turned to French literature and made a comparison of French and English tragedy; then took up Italian and German, but Ticknor, his friend and biographer, aroused in him a still greater interest in the literature and history of Spain. He had begun the study of Italian literature in 1823. In 1824 he wrote an essay on *Italian Narrative Poetry*, and had thoughts of taking up Roman history, but, in 1826, he chose the Spanish field.

Owing to his bad eyesight, he was obliged to have the aid of readers and secretaries, and for his own writing had recourse to a writing frame designed especially for the blind. After ten years of hard labor, he produced the first results of his research, the *History of the Reign of Ferdinand and Isabella the Catholic* (3 vols., 1838). The work at once gained favor, and was soon translated into French, Spanish, and German. He then spent six years on what is probably his most brilliant work, a *History of the Conquest of Mexico, with a Preliminary View of the Ancient Mexican Civilization, and the Life of the Conqueror, Hernando Cortes* (3 vols., 1843). His third work in the series was the *History of the Conquest of Peru, with a Preliminary View of the Civilization of the Incas* (3 vols., 1847). These greatly added to his reputation. He was made corresponding member of the French Institute, and on his visit to Europe in 1850 was received with honor. In 1855 appeared two volumes of the *History of the Reign of Philip the Second, King of Spain*, and three years later the third volume, but the work was cut short by a stroke of apoplexy which caused Prescott's death. He had, however, added to his series by editing Robertson's *History of the Reign of Charles the Fifth* (3 vols., 1857), adding thereto a supplement embracing the life of the Emperor after his abdication. Aside from his histories, his literary work consists of a preface to Mme. Calderon de la Barca's *Life in Mexico* (2 vols., 1843); *Biographical and Critical Miscellanies* (1845); *A Memoir of the Honorable John Pickering* (1848); and *A Memoir of the Honorable Abbott Lawrence* (1856).

Prescott is eminent in American letters as one of the first and most accomplished of the historians. Slightly younger than Irving and later in acquiring literary reputation, he excelled him in the extent and system with which he treated his work. To him, with Irving in history and romance, Ticknor in Spanish literary research, and Motley, a few years later, in history, belongs the honor of having introduced and made popular to the English-speaking and a good part of the foreign world the story of the Spanish nation. Technically, as an historian, Prescott has been justly criticised for a tendency to color his pictures too highly and to allow his admiration for his heroes to get the better of his judgment; nor is he altogether successful in dealing with political complications. His most serious defect is one for which he cannot fairly be held responsible. American archaeology has been revolutionized since his day by the labors of Morgan, Bandelier, and others, and the more or less romantic and distorted pictures of Mexican and Peruvian development given by the Spanish chroniclers on whom Prescott relied have been corrected. Thus his work needs to be read in the light of modern research and to be corrected at various points, but with the proper

allowance and viewed as literature its high rank seems assured. His style is dignified, refined, and always eminently readable, and his histories have truly become household classics. There is a *Life* by George Ticknor (Boston, 1864; revised, London, 1875). The best edition of Prescott is that by Kirk in 16 vols. (Philadelphia, 1870-74).

PRESCRIPTION (Lat. *prescriptio*, from *prescribere*, to prescribe, from *præ*, before + *scribere*, to write). A formula by which the physician directs the compounding and dispensing of medicines. Prescriptions were formerly written entirely in Latin, the common scientific language; but at the present time and in this country the tendency is to restrict the employment of Latin to the names of the ingredients of the formula, English being used for the directions. Since the botanical or chemical names are the only ones by which vegetable or mineral drugs can be definitely known, Latin is retained for this part of the medical formula. The formal prescription consists of four parts: (1) The *superscription* comprises the name of the patient, date, and the sign R. The latter is an abbreviation of the Latin word *recipe* (take). (2) The *inscription* or body of the formula consists of the names and quantities of the drugs to be compounded. The names of the ingredients, as before stated, are written in abbreviated Latin, and the quantities set down in apothecaries' measure or according to the metric system. (3) The *subscription* is made up of directions to the apothecary. (4) The *signature* (Lat. *signetur*, let it be labeled) consists of directions to the patient: dose, time, and method of taking. This is followed by the physician's signature or initials. The body of a prescription may be composed of one or many ingredients, arranged in a specific manner, and each having a definite purpose to fulfill. The most important of these is the *base* or substance from which the chief therapeutic action is expected. This may be assisted in its operation by another ingredient, the *adjuvant*, and corrected or modified by a third called the *corrigent*. Lastly, for the sake of convenience of administration, to secure a definite quantity or consistency, to increase solubility and obtain uniform subdivisions into proper doses, certain substances having little therapeutic virtue in themselves, and variously known as the *vehicle*, *diluent*, *excipient*, or *menstruum*, are added. See Bartholow, *Materia Medica and Therapeutics* (New York, 1903).

PRESCRIPTION. In Roman legal procedure, a prescription was a plea which the praetor placed at the beginning of the instruction (*formula*) which he sent to the referee (*judex*), in order that it might be examined before all other disputed issues. The 'prescription of long time' was one of the most important of the Roman prescriptions; and in mediæval procedure the word prescription was used only to designate such a plea. In the broadest sense, prescription means the legalizing of an existing state of things in consequence of lapse of time—the establishment of legal rights by the prolonged exercise of corresponding powers, and the extinction of rights by prolonged failure to use the powers which they are supposed to confer. In early law the field of prescription is practically unlimited. In highly developed law no substantive rights are acquired or lost by prescription,

except rights in things. Remedial rights, or rights of action, however, are regularly lost by non-user.

Civilians divide prescription into 'acquisitive,' by which rights are created, and 'extinctive,' by which they are destroyed. For the prescription of actions, the English law employs the term limitation. See LIMITATION OF ACTIONS.

ROMAN LAW. PRESCRIPTION OF RIGHTS IN THINGS. According to the Twelve Tables, movables (except stolen things) were acquired 'by use' (*usucapio*) in one year, immovables in two. In the later Republic the praetors and provincial governors developed for provincial real estate a 'prescription of long time.' Justinian fused the two institutions, limiting the term usucapion to movables and prescription to immovables. Under the rules which he laid down, the person who acquired possession (q.v.) in good faith, and who maintained uninterrupted possession for a certain period, became owner. The period, in the case of movables, was three years; in the case of immovables, if the owner lived in the same province, it was ten years; if he lived in another province, it was twenty years. Public and ecclesiastical property was excluded from this ordinary prescription; also all property of which the owner had been dispossessed by theft or violence, although it had subsequently come into the hands of an honest possessor.

Justinian further enacted that when the owner's action of recovery was extinguished by prescription, the possessor, if he had acquired possession in good faith, should become owner. Property excluded from the ordinary prescription was in most instances capable of being acquired by this *prescriptio longissimi temporis* (thirty or forty years).

PRESCRIPTION OF ACTIONS. At early Roman law rights of action, as such, were perpetual: they ceased to exist only when the substantive right was lost (as by usucapion). The equitable actions given by the praetors, however, were limited; and Imperial legislation finally limited all actions. The periods varied from six months to forty years; the ordinary period was thirty years.

Acquisitive prescription and the prescription of actions were regularly suspended in the case of persons unable to exercise their rights, e.g. persons under household authority and infants.

IMMEMORIAL PRESCRIPTION. A survival from early law, when prescription had a wider range, is found in the rule that any state of things which has existed so long that no memory remains of its origin is presumed to have been legally established. The Roman jurists, however, invoked this rule only to protect public use of private property—e.g. rights of way and artificial water-courses—and to prevent interference with ancient dikes and channels regulating the flow of surface water.

MODERN CIVIL CODES. Prescription has lost much of its importance by reason of changes in the law of property (q.v.). The general retention or adoption of the old German rule that honest acquisition of movables gives title has left no room for prescription of movables except as regards lost or stolen things. In these cases the honest possessor apparently becomes owner when the former owner's action of recovery is extinguished, which occurs in periods varying from two to ten years. As regards real property, the

importance of prescription has been greatly lessened by official registration of titles and the indisposition of the law to recognize other than registered rights. Immemorial prescription has found no favor in the eyes of modern legislators.

Prescription of actions, in all the codes, is substantially Roman. There is a tendency, however, to shorten the period of limitation for ordinary debts, and to permit prescription to run against persons under guardianship, the guardians being of course responsible to their wards for losses due to their negligence.

GROUND OF PRESCRIPTION. Prescription rests primarily upon social interests. Statutes of prescription terminate controversy; they are 'statutes of rest.' The extinction of rights by prescription and limitation is further defended on the ground that it is a just penalty for negligence. In modern discussion, the shortening of the periods within which debts are recoverable is defended on the ground that long credits are undesirable.

In estimating prescription it should be remembered that it has other functions besides making bad titles good and liberating persons who are really debtors. It operates constantly to transform derivative titles, which are not always easy to prove, into original titles, based on recent facts and conditions. It also operates to relieve those who are not debtors, because they have discharged their obligations, from the burden of proving payment. In both cases, proof becomes increasingly difficult with the lapse of time; and the relief which prescription gives to true owners, and to persons who are not truly debtors, is invaluable and indispensable.

Consult authorities cited under CIVIL LAW; also Unterholzner, *Verjährungslehre* (2d ed., Leipzig, 1858); and Grawein, *Verjährung und gesetzliche Befristung* (1880).

ENGLISH AND AMERICAN LAW. In the common-law system prescription is employed in a narrower sense than in the legal systems derived from the Roman law, being restricted to the acquisition of the interests in land described as *incorporal*, such as easements and profits *a prendre*, the acquirement of title to personal property and to *corporal* interests in land by lapse of time being comprehended under the heads of ADVERSE POSSESSION and LIMITATION OF ACTIONS (qq.v.). The common-law theory of the effect of prescription is also radically different from that of the civil law, as its operation is not to sanction a wrongful possession, but to furnish evidence, more or less conclusive, of the lawful origin of the right claimed. This theory in English law took on the grotesque form of the doctrine of a lost grant, the open and notorious enjoyment of the right claimed without interruption for the prescriptive period raising a presumption that it was originally conferred by deed from the owner of the land affected, the tender of the deed in court being excused by the further fiction of its loss. This presumption may still be rebutted by showing that the alleged grantor could not possibly have made the grant in question, but in England (where prescriptions are now mainly governed by statute), as well as in the United States (where they are still regulated by the common law), the fiction of a lost grant has now generally been abandoned and the whole doctrine placed on a more rational basis by being assimilated to the principles governing adverse posses-

sion of lands. The latter, however, still retain many of the peculiarities derived from the feudal doctrines of seisin and disseisin (qq.v.), the legal title of the adverse holder of land being in theory based not on the length of his possession, but upon his seisin, however wrongful this may have been—the lapse of time operating only to 'quiet' the title thus obtained.

The period of prescription has varied from the 'immemorial enjoyment' of the earlier common law (interpreted to signify an uninterrupted user from the accession of Richard I., 1189) to the modern period, which, by analogy to the limitation of real actions by statute, is usually fixed at twenty years. As in the case of limitation, also, the prescriptive term will not begin to run during the existence of a legal disability—as infancy, insanity, or coverture—in the owner of the land over which the right in question is asserted, nor if the land is at the time of the adverse user in the possession of a tenant or disseisor. An easement or profit once acquired, however, against the tenant in fee simple binds the land into whosoever hands it may thereafter come.

The operation of the principle of prescription is further restricted by limiting it to rights of enjoyment of a common and well-known sort, and, in the United States, to such as answer the description of positive or affirmative, as distinguished from negative rights. Thus while rights of way, of drainage, and the like, may be gained by prescription everywhere, the negative easements of light and of lateral support cannot generally be acquired in this way in the United States, although in England no such distinction is recognized. But new and unusual incidents of ownership resting on prescription—such, for example, as the right to the access of air to a wind-mill or the right to a fine view—will not be admitted even in Great Britain. Such rights, as well as the negative easements, in this country arise only by grant.

Strictly speaking, prescriptive rights, as the expression is used in English law, are to be further distinguished from public or quasi-public rights in the nature of easements or profits, such as commons appendant, customary rights of way, and the like, even when these rest, as they commonly do, on immemorial enjoyment. The distinction rests on the fact that prescription in legal theory always presumes a grant; and if the right in question is claimed by an indefinite number of people, as in the case of a custom, it cannot rest on a grant, and is therefore not strictly prescriptive in character. Consult: Gale, *Easements* (7th ed., London, 1899); Washburn, *Easements and Servitudes*; 3 Harvard Law Review, 183.

PRESENTATION AT COURT. See COURT, PRESENTATION AT.

PRESENTMENT (OF. *presentment*, *presentement*, from *presenter*, to present, from Lat. *presentare*, to set before, from *presens*, pres. part of *presens*, to be at hand, from *præ*, before + *esse*, to be). An informal accusation by a grand jury, as to a crime coming to its notice, and afterwards reduced to the form of an indictment. It is usually the result of an investigation conducted before it, or based upon information as to a crime communicated to it by some one while it is in session. A presentment differs from an indictment in that the latter is

found by indorsing the words 'a true bill' on a formal bill of indictment prepared and laid before the grand jury by a prosecuting officer. The words presentment and indictment are frequently used as being interchangeable, but this is not sanctioned by the best authorities. See GRAND JURY; INDICTMENT.

Presentment also has a special meaning in the law of negotiable paper, as describing offering of a bill of exchange for acceptance, or a formal demand of payment. See BILL OF EXCHANGE; NEGOTIABLE PAPER.

PRESERVATION OF FOOD. See FOOD, PRESERVATION OF.

PRESIDENT (OF, *president*, Fr. *président*, from Lat. *presidens*, president, pres. part. of *presidere*, to preside, direct, sit before, from *præ*, before + *sedere*, to sit). The chief executive officer of the United States Government, chosen for a term of four years by an electoral college. In case of removal, resignation, death, or inability to discharge the duties imposed by the Constitution and laws he is succeeded by an officer called Vice-President. The electors by whom the President is chosen are appointed in each State in such manner as the Legislature thereof may direct, each State being entitled to as many electors as it has Senators and Representatives in Congress. At present the practice in every State is to choose the electors by popular vote on a general ticket. This election takes place on the Tuesday following the first Monday in November of the year preceding that of the Presidential election. These electors assemble in their respective State capitals on the second Monday of January following for the purpose of casting their votes, which are in turn transmitted to Congress and officially counted by that body on the second Wednesday of February. In case no candidate receives a majority of the electoral votes the election is taken to the House of Representatives, where the members voting by States choose a President from the three highest candidates on the list. This happened in 1800 and again in 1824. The President is inaugurated on the 4th of March following the election. He is eligible for reelection without limit as to the number of terms, but the precedent set by Washington of refusing a third term has never been broken. Eight Presidents have, however, served two terms each. The convention which framed the Constitution of the United States was well nigh unanimous in opinion as to what should be the character of the Presidential office, although there were differences of opinion as to what should be the tenure and mode of election. The State Governors and Presidents afforded a tolerably clear model for the creation of the national executive, and it may be said that these were followed rather than the British executive. The qualifications for the Presidency are fixed by the Constitution. They are citizenship acquired by birth in the United States, fourteen years' residence in the United States, and the completion of the thirty-fifth year of age. The President is required before entering upon the discharge of his duties to swear or affirm that he will faithfully execute the duties of the office to which he has been elected and to the best of his ability preserve, protect, and defend the Constitution of the United States. On the occasion of the inauguration the President delivers a public address in

which he announces his political policy, and annually upon the meeting of Congress he sends a message to that body containing information of the state of the Union and making such recommendations as may seem to him wise and expedient.

The President receives compensation for his services in a salary at present fixed by statute at \$50,000 per year and which can neither be increased nor diminished during the term for which he is chosen. He is also allowed the use of the executive mansion, together with the furniture and effects kept therein. He is prohibited by the Constitution from accepting any other emolument from any one of the Commonwealths or from any foreign Prince, King, or State. He is privileged from the jurisdiction of any court or magistrate, but may be impeached by the House of Representatives for treason, bribery, or other high crimes and misdemeanors, and upon conviction by the Senate must be removed from office. Being then divested of his official character, he is subject to indictment and trial in the regular courts as any other private individual. The privilege of resigning from office is recognized by the Constitution, and the formalities of relinquishment are prescribed by a statute of Congress.

The powers and duties of the President include the management of the foreign relations of the United States; the calling together of Congress in extraordinary session, and the furnishing it with information concerning the Government; the power to veto legislative measures; the command of the army and navy; the granting of reprieves and pardons; the execution of the laws; and the appointment of the officers of the United States. For a more detailed discussion of the duties and powers of the President, see UNITED STATES, and for the electoral votes cast for the various candidates for the Presidency and the Vice-Presidency, see ELECTORAL VOTES. See, also, ELECTORAL COLLEGE. Consult Stanwood, *History of the Presidency* (Boston, 1898).

PRESIDENT, THE. A United States frigate of 44 guns, built in 1794, at New York, and taken by the British in 1815.

PRESIDIO (Sp., garrison, guard) OF SAN FRANCISCO (Cal.). A United States military post, established in 1850, and comprising a reservation of 1480 acres in the suburbs of San Francisco and on the southern border of its harbor. It was originally a Spanish military post, was continued as such by Mexico, and eventually (1848) ceded to the United States. It has long been an artillery post, and in 1902 had quarters for 30 officers and 500 men.

PRESS. See METAL-WORKING MACHINERY; PRINTING; HYDRAULIC PRESS; DIES AND DIE-SINKING; etc.

PRESS, FREEDOM OF THE. The immunity of the printing press from responsibility to the Government for the character of the matter which it publishes except in the case of matter deemed libelous. (See LIBEL.) In the early history of the printing press no such immunity was recognized, and it became an established rule that a free press was wholly incompatible with an absolute government. The censorship of the press originated in the attitude of the Roman Catholic Church, which in 1515 formally decreed through the Council of the Lateran that no publication should be issued from any place over

which the Church had jurisdiction without the written sanction of the Bishop or of the Inquisitor of the diocese. The institution of the censorship gradually became a feature of the policy of the civil authorities in the various States of Continental Europe, from some of which it has not yet disappeared. At present no censorship exists in France, Switzerland, Sweden, Spain, Italy, Norway, the Netherlands, Belgium, Denmark, and Germany, but the press laws are very rigid in some of these, such as Spain, France, and Germany, and their governments claim and exercise the right to suppress in a summary manner journals deemed obnoxious to the public peace and security. The Constitution of France contains no guarantee in behalf of freedom of the press. That of Switzerland does, but authorizes the Cantonal governments to enact laws to prevent the abuse of the same and empowers the Federal Government to punish similar abuses when directed against its authority or that of its officers. The Constitution of Prussia secures to every person the right to express his opinion freely by word, writing, print, or pictorial representation, and prohibits the establishment of a censorship, but in the same article empowers the Legislature to place restrictions upon the press and to enact laws for the punishment of abuses of the liberty of printing. The laws enacted in pursuance of this provision are very severe and place substantial limitations upon the freedom of the press. In Russia the censorship in an arbitrary form still exists. There newspaper publishers are required to obtain permission to print and then lodge with the Government a considerable sum as caution money. Those who are unable to comply with the latter requirement are required to send their articles to a censor three days previous to publication.

In England, after a long struggle, almost complete liberty of press now prevails. From the time of the Reformation until the Commonwealth the English press was subject to a censorship under the direction of the Crown. During the period of the Civil War and the Commonwealth it was practically free from molestation, but upon the restoration of the Stuarts the old restrictions were revived. In 1694 the censorship of the press was discontinued. During the reign of Anne severe acts were passed against printers and some of the most distinguished men of letters of England, including Steele and De Foe, were punished for violating these laws. At the same time numerous tracts, books, and newspapers were burned by the common hangman. The censorship, however, was not revived. With a view to the repression of the obnoxious Whig press, the Tory Government imposed on printers a stamp duty which in the reign of George III. was increased to fourpence on every paper. Likewise taxes on advertisements were imposed. But these measures proved ineffective, and were finally repealed toward the middle of the nineteenth century. One of the most prolonged struggles in behalf of the freedom of the press in England was in relation to the publication of Parliamentary debates. Until 1729 newspaper reports of Parliamentary proceedings were unknown. About that time fragmentary reports began to appear in the newspapers, whereupon the Commons resolved that it was a breach of privilege, as it tended to make members answerable to their constituencies, and this is the theory to-day. For breach of this privilege many printers were prosecuted and

fined, in the year 1764 no less than 200 informations being filed in behalf of the Crown. (See WILKES, JOHN.) The real liberty of the English press dates from the passage of the Fox Libel Act of 1792, which enacted that the decision in libel suits belonged to the jury and not to the judge. This reversed the view which the courts had acted on for many years. At present the only restriction upon the press, except in case of libelous matter, is the common-law rule that the publication of anything against the Constitution of the country or the established system of government is an indictable offense.

In the American colonies the attempt was made to introduce the British system of a rigid censorship, and among the instructions to the colonial Governors was that they were to provide by all necessary orders that no person keep any press for printing, and that no book, pamphlet, or other matter be printed without their special leave and license first obtained. There were numerous instances of the public burning of books and the punishment of printers. (See BRADFORD, WILLIAM; ZENGER, PETER.) After the overthrow of British authority in the colonies the principle of the freedom of the press was incorporated in the first State Constitutions, and has been continued in all succeeding ones and without exception. The following is a common provision of the State Constitutions on the subject: "The printing press shall be free to every one who undertakes to examine the proceedings of the Legislature or any branch of the Government, and no law shall ever be made to restrain the right thereof. The free communication of thoughts and opinions is one of the inviolable rights of man, and every citizen may freely write and print on any subject, being responsible for the abuse of that liberty." It is usually further provided that in prosecutions for libel the truth may be given in evidence, that the motive shall be taken into consideration, and that the jury shall determine both the law and the facts. The great freedom with which the newspapers criticize and often ridicule public officials, especially by means of cartoons and pictures, has sometimes led to something of a reaction in favor of more stringent libel laws. As an example of this may be mentioned the stringent law passed in Pennsylvania in 1903. The Constitution of the United States prohibits Congress from passing any law abridging the freedom of the press. Notwithstanding this provision, Congress in 1798 passed an act for the punishment of persons convicted of printing matter calculated to bring the Government into disrepute. It was in force two years and there were a number of notable prosecutions under the law. See ALIEN AND SEDITION LAWS.

PRESS ASSOCIATIONS. Associations of newspapers or news agencies for the gathering and dissemination of news were unknown prior to 1849. Hitherto it had been entirely a matter of individual enterprise, but in that year, as a direct result of the rapid development of the telegraph, and steam transportation both on sea and on land, almost simultaneously the business of newsgathering through associated effort or special news agencies was begun both in Europe and the United States. In Europe the initiation of the service was due to Baron Julius Reuter, a Prussian, who during 1848 had been experimenting with schemes for facilitating the

transmission of news on the Continent. In 1849 he appeared in London and attempted to interest various daily newspapers in a plan for increasing the scope and efficiency of their foreign news service by acting in combination. His project was not favorably received at first, but one by one the great London dailies came to recognize the value of the new service, and although for the first ten years the more conservative confined their patronage to the department of financial news, a succession of lucky strokes in supplying early accounts of great political events at length won for the Reuter agency a world-wide recognition as the greatest existing factor in the gathering of international news. It maintains correspondents in every part of the world, and by a coöperative arrangement with the Associated Press in America its service is greatly extended. In England the exclusive distribution of all the Reuter telegrams to the provincial papers in the United Kingdom is in the hands of an organization in London known as the Press Association. This organization was formed in 1868, when the British telegraph lines were by act of Parliament taken over by the Government. It is a co-operative corporation, formed and controlled by the provincial papers, maintains an office with manager, editors, and correspondents in London, and has representatives in every town in the United Kingdom. Other British news associations include the Central News Agency, organized on the same lines as the Press Association save that it has foreign correspondents, the National Press Agency and the Exchange Company.

In the United States the first move toward associated effort in gathering news was made in 1847 in the formation of the Associated Press of New York, an organization of daily papers to reduce useless competition. This organization, finally launched in 1849, was the forerunner of all other similar associations in America. It extended its activities and scope rapidly, and as other news gathering agencies were formed throughout the country, it made such arrangements with them as practically to control the collection and distribution of news in the entire country. The monopoly enjoyed by the old Associated Press, which had practically absorbed an organization known as the Western Associated Press, lasted for many years. The refusal of the association to admit a paper to membership became almost a prohibition upon publication, and the withdrawal of a franchise proved likewise disastrous. Dissensions finally arose within the organization, and after several competing associations had been formed and failed, the United Press was finally successfully launched in 1882. The original Associated Press finally dissolved, and the greater part of the large metropolitan dailies joined the new organization. A rival to the United Press, however, soon appeared in the field in the new Associated Press, organized in Illinois on a mutual plan by Southern and Western papers. Subsequently, as a result of dissensions, the United Press dissolved, most of the New York members joining the Associated Press. In 1900 the Associated Press underwent a reorganization and was reincorporated in New York as a result of a decision of the Illinois courts in a suit brought to compel it to furnish news to other than association members. There are in the United States numerous

local Associated Press organizations, such as the New York City News Association, practically a branch of the Associated Press, and also numerous agencies for the dissemination of special sorts of news, such as financial, market, or agricultural. Other agencies having a more or less national service are the Laffan Bureau, organized by the New York *Sun* on the break-up of the United Press, and the Scripps-McCrea Syndicate.

PRESSBURG, prës'boörk (Hung. *Pozsony*). A royal free city and the capital of the County of Pressburg, Hungary, situated in a beautiful region, on the north bank of the Danube, 35 miles east of Vienna (Map: Hungary, E 2). It is one of the finest cities of Hungary. The fortifications of the old town have given place to spacious boulevards. The Danube is here spanned by the new King Francis Joseph iron bridge. The most attractive of the churches is the eleventh-century Gothic cathedral, in which the kings of Hungary were crowned. On the tower is a pyramid surmounted by a gilded royal crown. The old castle, burned in 1811 and existing now only as a ruin, was once the residence of the kings of Hungary. The beautiful thirteenth-century town hall contains a museum of Roman antiquities. The city has several handsome palaces, including the winter palace of the Primate of Hungary. Other interesting features are the Landhaus, the seat of the Hungarian Diet till 1848; the new theatre; the park with an open-air theatre; and the race course. The equestrian statue of Maria Theresa, erected in 1897, is also noteworthy. Among the educational institutions are a royal law school, a Catholic gymnasium, a Protestant lyceum, a priests' seminary, several industrial schools, and a rich library. The philanthropic institutions of Pressburg are among the best in Hungary. Pressburg has a large dynamite factory, a famous brush factory, and a new petroleum refinery. It also manufactures pastry, turnery ware, cabinet-work, tobacco, ribbons, cloth, machinery, leather, chemicals, champagne, etc. There is a lively trade, chiefly in grain, cattle, and wine. Population, in 1890, 52,411; in 1900, 61,537, of whom about two-thirds were Germans and three-fourths Catholics.

Pressburg is first mentioned in the ninth century. In the twelfth century it was strongly fortified, and became a place of great strategic importance. From 1541 to 1784 it was the capital of Hungary. Here in 1687 the Hungarian Diet formally accepted the hereditary succession of the Hapsburgs. After the battle of Austerlitz in 1805, Napoleon and the Emperor Francis concluded the Peace of Pressburg (December 26), by which Austria ceded the former Venetian dominions to the Kingdom of Italy, and Tyrol to Bavaria. Consult Ortway, *Geschichte der Stadt Pressburg* (Pressburg, 1892-98).

PRESENSE, prä-sän'sä', EDMOND DEHAULT DE (1824-91). A French Protestant clergyman. He was born in Paris, January 7, 1824; studied theology at Lausanne, Halle, and Berlin, and was pastor of the Free Evangelical Congregation of the Taitbout, Paris (1847-70). He was Deputy to the National Assembly (1871-76), and advocated amnesty to the National Guards who had joined the Commune, moderation in legislation concerning the 'International' organization, and free education. From 1883 he was a life Senator. He was an earnest advocate of the independ-

ence of the Evangelical Church from the State. He died in Paris, April 8, 1891. He founded the *Revue Chrétienne* and the *Bulletin Théologique*, and wrote many popular works, of which the following have appeared in English translation: *The Redeemer: Discourses* (1864); *The Land of the Gospel: Notes of a Journey to the East* (1865); *Jesus Christ: His Times, Life, and Work* (1866); *The Mystery of Suffering, and Other Discourses* (1868); *The Church and the French Revolution; a History of the Relations of Church and State, from 1789 to 1802* (1869); *Rome and Italy at the Opening of the Œcumenical Council* (1870); *Contemporary Portraits* (1880); *A Study of Origins; or, the Problems of Knowledge, of Being, and of Duty* (1883).

PRESENSE, FRANCIS DEHAULT DE (1853—). A French publicist, born in Paris. He entered the diplomatic service in 1879, was appointed secretary of embassy at Constantinople in 1880, and later in the same year at Washington. Having turned to journalism, he became one of the principal contributors to the *Temps*. He was prominent as a defender of Dreyfus, and through the press and by lectures carried on an important campaign in behalf of the accused captain. Among his publications are: *L'Irlande et l'Angleterre depuis l'acte d'union jusqu'à nos jours* (1889); *Le cardinal Manning* (1896); and *Un héros. Le lieutenant-colonel Picquart* (1898).

PRESS-GANG. See IMPRESSMENT.

PRESSLER, MAX ROBERT (1815-86). A German forester, born in Dresden. He studied at the School of Technology there, and taught in Zittau and in the Academy of Forestry at Tharandt until 1883. Pressler contributed largely to the advance of forestry by his inventions, among which the most important is the *Mess-knecht* for measuring the height of trees, and by his writings, which are full of novel theories for the most part based on exact calculation. *Der rationelle Waldeirt und sein Nachhaltswaldbau höchsten Reinertrags* (1858-85), his chief work, is a protest against the methods of the old school.

PRESTER JOHN, i.e. Presbyter, or Priest John. A supposed Christian king and priest, whose territory was believed during the Middle Ages to lie either in Asia or Africa. The first record of this personage appears in the chronicle of Otho of Freisingen, who lived in the twelfth century. From that time the legend grew and developed. It was believed, and various travelers so reported, that the Nestorian Christians had built up a large monarchy ruled over by a priest-king named John. Letters from this mysterious personage addressed to the Byzantine Emperor or the Pope were circulated, giving marvelous accounts of the inhabitants and the wealth of the territory. In the fourteenth century the home of Prester John was generally believed to be in Africa, where it was identified with the Christian Kingdom of Abyssinia. Consult: Yule, *Cathay and the Way Thither* (Hakluyt Society, 2 vols., London, 1866); id., *Book of Sir Marco Polo* (2 vols., London, 1874); Oppert, *Der Presbyter Johannes in Sage und Geschichte* (2d ed., Berlin, 1870); Zarneke, *Der Priester Johannes* (Leipzig, 1876-79).

PRESTO (It., quick). In music, a direction that a piece should be performed in a very rapid manner. In this tempo conductors mark only the

first beat. The term *prestissimo* is also sometimes used to denote the utmost possible rapidity of execution.

PRESTON. A manufacturing and market town in Lancashire, England, on the Ribble, at the head of its estuary, 21 miles north-northeast of Liverpool (Map: England, D 3). The town is well laid out and is surrounded with pleasing scenery. The chief public buildings are the town hall, which contains the guild hall and exchange; the Preston and County of Lancashire royal infirmary; the corn exchange and market house; the house of correction and court-house; the institution for the diffusion of useful knowledge; the public library; and the institute and school for the blind. Saint Walburge's Roman Catholic Church is noted for its lofty spire, 306 feet high. Preston's great municipal enterprise was the acquisition of the dock and harbor rights of the Ribble in 1883 for \$364,000 and an outlay on improvements of over \$6,000,000. The channel was deepened to admit vessels of 1000 tons, and a dock of 40 acres with warehouses and 6798 feet of quays was built. About 2500 vessels of about 350,000 tons burden enter and clear the port annually. Its principal export is coal; its imports are grain, iron, and timber. Besides the Ribble harbor rights, the town owns its water supply, tramways, markets, refuse destructor, sewage farm, and maintains baths, free libraries, and three large public parks. Cotton and linen are extensively manufactured. There are iron and brass foundries, iron ship-building yards, carriage works, machine shops, and malting, brewing, and rope-making establishments. Several great fairs are held here during the year, besides the usual weekly markets.

Originally called Priest's Town, from its ecclesiastical institutions, it received its first charter from Henry II. The celebrated Preston guild of merchants has held bi-decennial festivals since 1329, the earliest on record. During the Civil War the town declared for the King, but was taken by the Parliamentary forces, and near the town Oliver Cromwell overwhelmed the Scots in 1648. It figured in the Jacobite rebellions of 1715 and 1745. In 1832 Joseph Livesey here originated the total abstinence movement. Population, in 1891, 107,573; in 1901, 112,982. For histories of Preston, consult: Hewitson, *History of Preston* (Preston, 1883); Fishwick, *History of the Parish of Preston* (Roehdale, 1900).

PRESTON, HARRIET WATERS (c.1843—). An American novelist and translator, born in Danvers, Mass. Her chief original works are: *Aspendale* (1872); *Love in the Nineteenth Century* (1874); *Is That All?* (1876); *A Year in Eden* (with Louise Dodge, 1886); *Private Life of the Romans* (1893). Noteworthy among her translations are: *The Life of Madame Svecchine*, *The Writings of Madame Svecchine*, *Celebrated Women* (selected from Sainte-Beuve's *Portraits de femmes*), *Sainte-Beuve's Madame Desbordes-Valmore*, *Paul de Musset's Alfred de Musset*, *Mistral's Miréio and Calendau*, and *The Georgics of Vergil*.

PRESTON, JOHN SMITH (1809-81). An American political leader and a soldier in the Confederate service, born at Abingdon, Va. He graduated at Hampton-Sidney College in 1824, and after study at the University of Virginia and

at Harvard, traveled extensively in Europe. On his return to America he settled at Columbia, S. C., which continued to be his home, though he had large agricultural interests in Louisiana. He was a lover of the fine arts and liberally aided the American artist Hiram Powers (q.v.). His ability as an orator and a writer gave him a more than local celebrity, and he was for several terms a member of the South Carolina State Senate. As the Civil War drew near he became an ardent secessionist and was chosen to lead his State's delegation at the Charleston convention of 1860. The next year he was appointed one of the commissioners to Virginia, and he made a notable speech at Richmond urging the Virginians to leave the Union. At the outbreak of the war he entered the Confederate military service, and participated in the first battle of Bull Run. Soon afterwards, however, he was appointed chief of the Conscription Bureau, with the rank of brigadier-general. At the close of the war he went to Europe, where he remained several years, and though he finally returned to the United States, he continued until his death bitterly hostile to the established Government.

PRESTON, MARGARET (JUNKIN) (c.1825-97). An American authoress, born in Philadelphia, Pa. She married T. L. Preston of the Virginia Military Institute and lived afterwards in Virginia and Maryland. Her first writing appeared in 1849 in *Sartain's Magazine*. Her first book, *Silverwood* (1856), was a novel. Her later writings are almost entirely poetical, and express deep religious feeling and ardent sympathy with the cause of the South in the Civil War, especially in *Beechenbrook* (1866), in which are some widely known lines on Stonewall Jackson's grave, and a lyric "Slain in Battle." Other poems are collected in *Old Songs and New* (1870); *Cartoons* (1875); *Colonial Ballads* (1887); and *For Love's Sake* (1887). Later volumes are *Aunt Dorothy* (1890) and *A Handful of Monographs*. She wrote also a good translation of the Latin hymn "Dies Irae" (1855). She died in Baltimore.

PRESTON, RICHARD GRAHAM, Viscount (1648-95). An English Jacobite politician and conspirator. He was born in Netherby, Cumberland, and was sent to Westminster School, thence to Christ Church, Oxford, and became a member of Parliament for his native shire at the age of twenty-seven. For his support of the Stuarts, he was rewarded with a Scotch peerage (1681), and the following year as Viscount Preston he was sent on a diplomatic errand to France, but returned (1685) to enter the Parliament of James II., and became a member of the Privy Council. After the downfall of the Stuarts Preston continued to be their agent in France, and upon one of his visits to London was imprisoned in the Tower for six months, but continued his conspiracies and was regarded by the Jacobites as the true Secretary of State. In 1691 he was again captured and tried and was condemned to death by the English Government, but saved himself by betraying his fellow plotters. Once again he was imprisoned for refusing to give evidence against Jacobites, but finally retired and devoted himself to the revision of his translation of *De Consolatione Philosophiæ* by Boëthius, which was published posthumously.

PRESTON, THOMAS SCOTT (1824-91). An American Roman Catholic clergyman. He was

born at New Hartford, Conn., of Protestant parents. Though the son's early influences were adverse to ritualism, when he graduated from Trinity College, Hartford, in 1843 with the determination of entering the ministry, he took the vow of celibacy. After completing his course at the General Theological Seminary in New York, he became attached to Trinity Church, later to the Church of the Annunciation in New York, the Holy Innocents, West Point, and Saint Luke's, New York. He was among the first in America to respond to the influences of the Tractarian movement, and accepting the Roman Catholic faith, after a brief course of study at Saint John's College, Fordham, he was ordained to the Roman Catholic priesthood at Albany in 1850. He was first assigned as curate to the old Cathedral in Mulberry Street, New York, then transferred to the Church of the Immaculate Conception at Yonkers. Returning to the cathedral in 1853, he became secretary to Archbishop Hughes, and in 1855 assumed the direction of the chancery, which he continued to administer until his death. In 1861 he was appointed rector of Saint Ann's to succeed Dr. John M. Forbes (q.v.). In 1874 he became vicar-general of the archdiocese; two years later the Pope conferred the title of Monsignor, and in 1888 he was named a Prothonotary Apostolic. He was a strict disciplinarian and warm supporter of parochial schools. In this he was opposed by a faction whose prominent members were Dr. Edward McGlynn and Father Ducey (q.v.), the latter at one time his assistant at Saint Ann's. He published a number of books on devotional and controversial subjects, among which *Protestantism and the Bible* (1880) and *Protestantism and the Church* (1882) have been extensively used.

PRESTON, WILLIAM CAMPBELL (1794-1860). An American lawyer, orator, and educator, born at Philadelphia. In 1809 he entered Washington College (Va.), but the next year entered the South Carolina College, at which he graduated in 1812. About 1817 he went abroad, met Washington Irving and his brother, and with them made walking trips through Wales and Scotland. He returned to the United States in 1819, was admitted to the bar in 1820, and removed to Columbia, S. C., in 1822. He soon won a great reputation, particularly as a jury lawyer. From 1828 to 1832 he was a member of the Legislature, and was a prominent advocate of Nullification. In 1837 he was elected to the United States Senate as a Calhoun Democrat. In 1842, on account of differences of opinion with his constituents, he resigned and resumed the practice of law. From 1845 to 1851 he was president of the South Carolina College, and lectured on belles-lettres. Though very successful, he was forced to resign on account of failing health. Preston was recognized as one of the most finished orators in the United States.

PRESTONPANS, prës'ton-pänz'. A village in Haddingtonshire, Scotland, on the Firth of Forth, eight miles east of Edinburgh (Map: Scotland, F 4). It gives its name to the battle fought in the vicinity in which the Jacobites under Prince Charles Edward routed the royal army under Sir John Cope, capturing their cannon, baggage, and military chest, September 21, 1745. Population, in 1891, 2200; in 1901, 1721.

PRESTWICH. A cotton-manufacturing town in Lancashire, England, $4\frac{1}{2}$ miles north-north-west of Manchester (Map: England, D 3). It is a favorite residential suburb of Manchester merchants. Population, in 1891, 10,900; in 1901, 12,800.

PRESTWICH, JOSEPH (1812-96). An English geologist. He was born at Clapham, London, and was educated at University College, London. Though engaged as a wine merchant until his sixtieth year, he frequently contributed to the *Transactions of the Geological Society*, and in 1874 was appointed professor of geology at Oxford (1874-88). His reputation rests chiefly on his classification of the Tertiary deposits of England, which he was the first to correlate with the strata of the Paris basin, and on his promulgation of the theory of man's contemporaneity with other Pleistocene mammals. Of his publications, the most important is his treatise on *Geology* (2 vols., 1886-88), which is considered one of the best existing presentments of the principles of the science from the point of view of the anti-uniformitarian. Professor Prestwich was president of the Geological Society of London (1870-72); vice-president of the Royal Society (1870-71); and president of the International Geological Congress (1888). Consult the *Life and Letters of Sir Joseph Prestwich*, by his widow (1899).

PRESTWICHIA (Neo-Lat., named in honor of Prestwich, an English geologist. A fossil crab found in the Carboniferous coal measures of North America and Europe, and probably closely ancestral to the modern horse-shoe crab or *Limulus*. The chief interest of this fossil lies in its close resemblance to one of the larval stages of *Limulus*, in which respect it forms a link in the history or phylogeny of the latter peculiar organism.

PRESUMPTION (Lat. *præsumptio*, anticipation, from *præsumere*, to presume, anticipate, take for granted, from *præ*, before + *sumere*, to take). In law, in its broadest sense, an inference as to the existence of a fact not known or proved to exist, which inference arises from its logical connection or association with certain other facts which are known or proved. As thus defined, a presumption may be nothing more than a mere inference of fact such as a jury is required to make in rendering a verdict. Thus, proof of the loss of a vessel in a storm with the other attendant circumstances may create a presumption or inference of the fact of death of a passenger sufficient to justify a jury in finding the death of the passenger as a matter of fact, unless the 'presumptive' proof of the fact of death is rebutted or explained away by proof of other circumstances.

In a narrower and more important sense the term signifies an inference of fact which is required by some positive rule of law to be made from the proof or known existence of certain other facts. Thus, the proof that one has not been seen or heard from by his friends or acquaintances for a considerable period, together with other circumstances, may or may not give rise to the presumption of his death; but if the absence is prolonged for a period of seven years, it is a positive rule of the common law that such absence, when unexplained, shall be deemed presumptive evidence of death.

It is evident that the effect of a presumption of this class is to give a weight or significance to facts actually proved in a given case not warranted by logic and not justifying in the absence of an express rule of law a finding by the court or jury of the existence of the fact presumed. Such presumptions are based upon considerations of convenience and serve a useful purpose in aiding in the proof of facts which it might be impossible to establish by any inference logically flowing from facts actually proved. It is for this reason that presumptions of this class are sometimes called 'presumptions of law'; that is, presumptions required by the law, as distinguished from mere logical inferences of fact. In strictness, however, such presumptions are true presumptions of fact. The effect of the presumption is *prima facie* to establish a fact, which, however, may be rebutted by the proof of other facts inconsistent with the fact presumed.

There is still a third class of presumptions so called, which are not true presumptions at all, but legal fictions. They are in reality rules of substantive law, although stated as presumptions of fact, and consequently they cannot be explained or rebutted. Thus the conclusive 'presumption' that a child under the age of seven has not capacity to commit a crime, or that one is presumed to know the law or the contents of certain public records, is not a presumption, but a positive rule of law which cannot be controverted. Oftentimes such rules of law originated as presumptions of fact, as, for example, the rule that twenty years' use of a right or interest in real estate gives rise to the conclusive presumption that such use is by virtue of a lost grant and is therefore lawful. Originally the presumption was a presumption of fact, which might be rebutted like any other true presumption, but with the sanction of a long line of judicial decisions the presumption became adopted as a rule of substantive law, if there had been twenty years' user of the property which established the lawfulness of the use as a matter of law, and the question as to whether the use of property was by virtue of a lost grant ceased to be a jury question.

The function of true presumption is primarily to aid a litigant in sustaining the burden of proof cast upon him by the pleadings in a case or by the rules of procedure.

Some of the typical presumptions, in addition to those already mentioned, are: One charged with a crime is presumed to be innocent. Infants between the age of seven and twelve are presumed to be incapable of committing a crime. A state of facts proved to exist is presumed to continue to exist. Letters having been proved to have been properly mailed are presumed to have been received. The unexplained failure of a party to a litigation to testify in his own behalf gives rise to the presumption that his testimony would be unfavorable to his case. This rule, however, has no application to one placed on trial upon a criminal charge, as the effect of such a presumption would be to deprive the accused of his legal right not to testify. There are many other presumptions of less frequent use which are founded upon the same general principles. See *Burden of Proof*, under EVIDENCE. Consult the authorities noted under EVIDENCE; also Lawson, *The Law of Presumptive Evidence* (2d ed., San Francisco, 1899).

PRETENDER (from *pretend*, OF. *pretender*, Fr. *prétender*, from Lat. *pretendere*, to pretend, allege, hold out, from *pre*, before + *tendere*, to stretch). The name borne in English history by the son and the grandson of the dethroned James II., the two being specifically known as the Old Pretender and the Young Pretender, respectively. See STUART, JAMES FRANCIS EDWARD; STUART, CHARLES EDWARD LOUIS PHILIP CASMIR.

PRETENSE, ESCUTCHEON OF. See ESCUTCHEON.

PRETI, præ'tè, MATTIA (sometimes MARCO, or MARIA) (1613-99). An Italian painter of the Neapolitan School, born at Taverna, Calabria. He was also called Il Cavaliere Calabrese, and Cordisco. He was a pupil of Lanfranco in Rome, or, according to other authorities, of Guercino in Cento, and also studied in France, Spain, and Antwerp, and ultimately settled in Malta, where he died. He was a follower of Caravaggio and Sabbatino, and has the same skill in the use of chiaroscuro. His works include "The Prodigal Son," in the Naples Museum, and frescoes in the Church of the Carmine, Modena, and in San Pietro a Majella, Naples.

PRETORIA. The capital of the Transvaal Colony, formerly the South African Republic, British South Africa. It is situated 4500 feet above sea-level on the southern slope of a spur of the Magalies Berge, in the south central part of the colony, 35 miles by rail, north-north-east of Johannesburg (Map: Transvaal Colony, E 4). It was regularly laid out on an extensive scale, with wide and straight streets crossing at right angles, but, although it became the converging point of the main railroad lines from Delagoa Bay and Port Elizabeth, it never acquired much economic importance, owing to the competition of Johannesburg. The Raadzaal or former Parliament House, 126 feet high, surmounted by a statue of liberty, is the most important building. The population is about 15,000, of whom 10,000 are whites. Pretoria, named after the Boer General Pretorius, was founded in 1855 to succeed Potchefstroom as capital of the Transvaal Republic. In May, 1900, it surrendered to the British, after which its four imposing but useless fortresses were dismantled. Consult Boyd, "Pretoria," in *Anglo-Saxon Review*, vol. iv. (London, 1900).

PRETORIUS, Dutch pron. præ-tò'ri-us, MARTINUS WESSELS (1827-1901). A South African soldier and statesman, the first president of the South African Republic. He was born in Natal, the son of Andries Pretorius, one of the leaders of the 'Great Trek,' and subsequently commandant-general of the Boer forces. He succeeded to his father's rank and position upon his death in 1852, and strove to carry out his policy, which had for its object the consolidation of the various independent Boer states. He won distinction as a military commander in the wars with the Kafirs, and in 1860 was chosen president of the Orange Free State. When, in 1864, the small Boer states north of the Vaal River combined to form the South African Republic, Pretorius left the Free State and threw in his fortunes with the new republic, of which he was at once elected president. He was re-elected in 1869, but in the following year, because of dissatisfaction over the arbitration agreement to which he had assented, in reference to territory

claimed by the Baralong tribe, he resigned office. The acts of his successor, President Burgers, led in 1877 to friction with the British authorities, and to a proclamation annexing the Transvaal to the British Empire. Pretorius took a prominent part in the revolt which followed, and after the independence of the Republic was recognized in 1880 he, with Kruger and Joubert, organized a provisional Government. Pretorius expected to be chosen president, but the commanding position won by Paul Kruger in the struggle led to his election in 1883, and the final retirement of Pretorius to private life. He was one of the most conservative of Boer leaders, and during his last years bitterly opposed the war policy of Kruger, declaring prophetically that it meant the final extinction of both the Boer republics.

PREUSCHEN-TELMANN, proi'shën tsel'mân, HERMINE VON (1854—). A German painter and author. She was born at Darmstadt, studied under Keller in Karlsruhe, and attained her earliest and greatest fame in floral paintings, marked by brilliant colorings. She traveled widely, and devoted herself to still life, and then to a symbolic manner which she described as 'historical still life.' Her most striking picture is "Mors Imperator." Her literary labors include the poems, *Regina Vita* (1888); *Via Passionis* (1895); and *Vom Mondberg* (1900); and the fiction, *Tollkraut* (1893); *Von ihm und Ihr* (1900); and *Dunkelkammer* (1901).

PREVESA, præ-vä'sá. A fortified seaport of Turkey in Europe, in the Vilayet of Janina, situated at the entrance to the Gulf of Arta in the extreme southwestern corner of the country (Map: Balkan Peninsula, C 5). It has considerable trade. Population, about 7000.

PREVIOUS QUESTION. A question put to a parliamentary assembly upon motion of a member to ascertain whether it is the will of the assembly to vote at once and thus put a stop to further debate on the subject under consideration. The form of the previous question is: "Shall the main question now be put?" If the vote is in the affirmative, the subject under discussion must then be voted on without further debate on the main question or amendment. This puts it in the power of a bare majority to shut off debate at any time. Under the name of 'closure,' this method of parliamentary tactics was first extensively resorted to by Mr. Gladstone in the House of Commons in 1882 in order to prevent dilatory or obstructive motions of the minority. It has been frequently resorted to in the United States House of Representatives from the earliest time, but up to the present time has not yet been tried in the Senate, where the practice of unlimited debate is allowed. In the House of Representatives the defeat of the previous question operates to keep the business before the House as though no motion had been made, but in the English Parliament it has the effect of postponing consideration for the day. The object of the practice in the United States is to hasten action, and a motion is made by a friend of the measure; in the English Parliament the purpose is to get rid of the subject for the time, and the motion is made with the purpose of voting against the measure. Thus in the United States House of Representatives the mover of the previous question votes for it, while in England he votes against it. At first in the House

of Representatives the previous question was debatable, and if it was negatived the main question was postponed for the day, according to the English practice; but in 1805 a rule of the House declared it to be undebatable, and in 1860 a rule was adopted by which consideration of the subject is resumed when the previous question is negatived, thus completely changing the English practice. The original rule of the House provided that the effect of the adoption of the previous question was to cut off all motions except the main question, but this was later changed so as to allow a vote first on the pending amendments and then on the main question.

PREVOST, pré'vó', AUGUSTINE (1725-86). A British soldier. He was born in Geneva, Switzerland; entered the British army, and in the French and Indian War distinguished himself in Wolfe's attack on Quebec, holding at the time the rank of a captain in the Sixtieth Regiment. He became lieutenant-colonel in command of the regiment in 1761, and after the death of General Henry Bouquet in September, 1765, succeeded him in command of the British troops in the Southern Department, with headquarters at Pensacola. He was still in command on the southern frontier at the outbreak of the Revolution, and late in 1778 he invaded Georgia, captured Sunbury, and with Colonel Campbell, who had captured Savannah, practically subdued for the time being the uprising in Georgia. In March, 1779, he abandoned Augusta on the approach of General Ashe, but later, at Brier Creek, turned and administered a severe defeat to his pursuers. He then drove Moultrie back on Charleston, laying waste the country with fire and sword as he advanced, and encouraged his Cherokee allies to acts of the greatest barbarity and cruelty. Before he could take Charleston, however, Moultrie, its commander, was joined by Pulaski with reinforcements from the Northern Army, and Prevost withdrew into Georgia. In October, 1779, he repulsed an attack on Savannah by the combined French and American forces under D'Estaing and Lincoln. For this success he was promoted to be major-general, but took little further part of any importance in the operations in the South.

PRÉVOST, prá'vó', EUGÈNE MARCEL (1862—). A French novelist, born in Paris May 1, 1862. He was educated by the Jesuits and at the Polytechnic School, engaged in tobacco manufacturing, and entered the literary field in 1891. In 1887, however, he published *Le Scorpion*, an attack on Jesuit education; and this story was followed by *Chonchette* (1888) and *Mademoiselle Jaufré* (1889), both of which were less crude and more sentimental and idyllic, though with some affectation of moralizing. *Cousine Laura* satirized the distortions of love, and the author pursued the theme in *La confession d'un amant* (1891). His next work, *Lettres de femmes* (1892), was the first to win distinct notice. It was succeeded by *Nouvelles lettres de femmes* (1894) and *Dernières lettres de femmes* (1897). The series are gracefully written, witty, ironical, ingenious, and thoroughly seasoned to the moral taste of the French. The dominant note is sensual perversity. *L'automne d'une femme* (1893) is nobler, but *Les demi-rierges* is distasteful, and *Le moulin de Nazareth* (1894) may be classed as revolting. *Notre compagne* (1895), a collection of stories, is, on the other hand, never vulgar, always

clever, and often pure; and *Le jardin secret* (1897) is a strong and worthy narrative of conventional marriage, with the moral of Goethe's *Die Mitschuldigen*. In 1900 appeared *Les vierges fortes*, which was composed of two volumes, *Prédérigue* and *Léa*. In 1901 *L'heureux ménage* was published. These last volumes deal with the woman question, both as concerns the education and the free life of young girls, and the marriage relation. M. Prévoſt does not appear to find that the new or higher education for young women, as he understands its development in England and America, points to anything very satisfactory for the French. As a whole, his stories suggest Bourget and Maupassant. At his best he is less powerful, less searching, but in narration he is admirably deft, lucid, compact, swift, and unerring. His feminine psychology is masterly, and probably no French author of his generation has so intimately understood the delicate, intricate nature of women.

PREVOST, Sir GEORGE (1767-1816). A British soldier and administrator. He was born in New York, entered the British Army in 1783, when he became a captain, and between 1790 and 1801 saw considerable service in the West Indies, commanding the British troops in Saint Vincent in 1794-95, and acting as Military Governor of Saint Lucia from 1798 to 1801, after which for a year he was Civil Governor. In 1802 he was appointed Captain-General and Governor-in-Chief in Dominica. Created a baronet in 1805, he was the same year made a major-general, and three years later a lieutenant-general. In 1808 he was appointed Lieutenant-Governor and commander-in-chief of Nova Scotia; in 1809 was second in command at the capture of Martinique, and in September, 1811, succeeded Sir James Craig as Governor of Lower Canada and Governor-General of British North America, which position he retained throughout the War of 1812, nominally, but not always actually, directing, as commander-in-chief, the British operations in Canada. On May 29, 1813, in concert with Sir James Yeo, he made an unsuccessful attack upon Sacketts Harbor, N. Y., and on September 11, 1814, in conjunction with Downie, who commanded the naval forces, was again unsuccessful in an attack upon Plattsburg, N. Y., where he was repulsed by the Americans under Macomb. For his faint-heartedness, or lack of enterprise, on the latter occasion he was called before a court-martial, but died before a verdict could be rendered.

PRÉVOST D'EXILES, prá'vó' däg'zól', ANTOINE FRANÇOIS (1697-1763). A French novelist, best known as the author of *Manon Lescaut* (q.v.). Prévoſt was born at Hesdin, April 1, 1697. His father was a petty official. Antoine had been by turns a student of the Jesuits, a novice among them, a soldier (1713-14), a Jesuit, a soldier again, and, as "the unhappy end of a too tender attachment," a Benedictine (1721-28). Then we hear of him as wanted by the police for a libel on the Duke of Tuscany and for alleged breaches of conventual discipline. It was a fateful period in the history of the French novel when Prévoſt sought refuge in England (1728), where he remained for two or three years, and, after a hasty and not wholly voluntary departure, returned thither in 1733 famous as author of the *Mémoires d'un homme de qualité*, the seventh volume of which is his greatest and shortest

novel, *Manon Lescaut* (1731). Prévost remained once more two years in England, viewed askance by the Huguenot colony, and so thrown more with the English, the result of which appears in *Clévaland, ou le philosophe anglais* (8 vols., 1731-38); *Les mémoires de M. de Montcal*; and an Irish novel, *Le doyen de Kilerine* (6 vols., 1735-40), which he followed after his return by a story based on the life of the fascinating Greek girl, Mademoiselle Aïsse, a then reigning Parisian celebrity. He died at Chantilly, November 23, 1763. Prévost wrote also two other novels, *Mémoires pour servir à l'histoire de Malte*, and *Mémoires d'un honnête homme*; but the latter years of his life were devoted almost wholly to translations of the novels of Richardson, begun in 1742, by which he influenced literature more even than by *Manon Lescaut*, propagating an indiscriminating interest in England and the English, whose democratic spirit inspired him to warm enthusiasm. Thus he helped to shake French confidence and pride of social and intellectual superiority, and to pave the way both for a cosmopolitan literary spirit and for Rousseau. Most of his novels are exotic in scene and in ethics, extravagantly romantic in structure, and with a new intensity of sentiment in depicting the tragedy of middle life.

His average work closely resembles the lesser novels of Defoe, but *Manon* is the proclamation in fiction of the "divine right of passion." It affected radically the novels of Rousseau and Diderot, and can be traced through Hugo, and Dumas, and George Sand, to the present day. Prévost himself tells us that the story is "a terrible example of the force of passion." The author does not preach, though his sympathy seems to go out toward his attractive sinner. The book is a portrayal of a coquette whose love of dress and finery as well as her passion for her chevalier are in desperate conflict with the miseries of life, to which contribute a pack of scoundrels, including her own brother. The style of this epoch-making work is more natural than that in any other of the author's books. In Richardson Prévost found a fuller expression of himself than he had yet been able to attain. *Pamela* in English began to appear in 1740. Prévost recognized its value instantly, and in 1742 his French version appeared in London. The English *Clarissa* is of 1748-49, the French of 1751; Richardson begins *Graudison* in 1753; Prévost, while awaiting its completion, busies himself in an attempt to spread English and German literature in France through founding with Rousseau a *Journal étranger*. Prévost's work was that of editor, as much as translator, and Richardson greatly profited by the process. Prévost's *Œuvres choisies* appeared in 39 volumes (Amsterdam, 1783-85; 1806). Of *Manon Lescaut* the editions are many. Consult: Texte, *Jean Jacques Rousseau and the Cosmopolitan Spirit in Literature*, trans. (New York, 1899); Sainte-Beuve, *Portraits Littéraires*, vols. i.-iii. (2d ed., Paris, 1864); id., *Causeries du lundi*, vol. ix. (ib., 1857-62); Harisse, *L'Abbé Prévost* (Paris, 1896).

PRÉVOST-PARADOL, pa'ra'dôl', LUCIEN ANATOLE (1829-70). A French journalist and author, born in Paris, August 8, 1829. He studied at the Collège Bourbon and at the École Normale, and in 1851 obtained the French Academy's prize

for eloquence. After obtaining his degree of doctor of letters in 1855, he was appointed to the chair of French literature at Aix; but in the following year resigned his professorship and became one of the editors of the *Journal des Débats*, writing most of the leading articles. He also wrote for the *Courrier du Dimanche*, and his opposition to the Empire and his advocacy of a responsible Ministry brought him into difficulties with the censorship. He was twice an unsuccessful candidate for a seat in the Corps Législatif. In 1865 he was elected a member of the Academy, and in 1868 visited England, where he received a warm welcome. Believing that the Empire had at last adopted the principle of parliamentary government, he consented in 1870 to fill the post of envoy at Washington; but, undeceived by the events connected with the proclamation of war with Prussia, he committed suicide at Washington, July 20, 1870. His chief works are: *Revue de l'histoire universelle* (1854); *Essais de politique et de littérature* (1859-63); *Quelques pages d'histoire contemporaine* (1862-66); *La France nouvelle* (1868). Consult Gréard, *Prévost-Paradol* (Paris, 1894).

PREYER, pri'ēr, WILHELM THIERRY (1841-97). A German physiologist and psychologist, born at Moss Side, near Manchester, England. He was educated at the universities of Bonn, Berlin, Heidelberg, Vienna, and Paris; became a lecturer in the philosophical faculty at Bonn in 1865; in 1867 in the faculty of medicine also; and in 1869 was appointed professor of physiology and director of the physiological institute at Jena. In 1888-93 he was a lecturer at Berlin. He made laboratory investigations in regard to spectrum analysis, propounded a theory of sleep, investigated the limits of perception of pitch, and applied the principles of H. G. Grassmann's (q.v.) theory of extension to psychology. He also conducted researches in connection with the blood, respiration, the color-sense, and other subjects. In addition to papers contained in the publications of learned societies and contributions to Pflüger's *Archiv für die gesamte Physiologie*, Liebig's *Annalen*, and other scientific periodicals, he wrote several volumes, including *Die Blausäure* (2 pts., 1868-70); *Die Blutkrystalle* (1871); *Naturwissenschaftliche Thatsachen und Probleme* (1880); *Biologische Zeitfragen* (2d ed. 1889); *Die Seele des Kindes* (4th ed. 1895); *Zur Psychologie des Schreibens* (1895); and *Darwin; sein Leben und Wirken* (1896).

PRIAM (Lat. *Priamus*, from Gk. Πρίαμος). In Greek legend, a son of Laomedon and Strymo or Placia (others give his mother other names), and last King of Troy. His name was originally Podarees, but was changed to Priam, on account of his having been ransomed by his sister Hesione from Heracles, who had made him prisoner when he captured Troy from Laomedon. His first wife was Arisbe, daughter of Merops, whom he gave away to a friend in order to marry Hecuba, by whom, according to Homer, he had nineteen sons; though from other wives the number was increased to fifty and as many daughters, whose names, with some variations, may be found in Apollodorus and Hyginus. The best known of the sons are Hector, Paris, Deiphobos, Helenus, Troilus, and of the daughters, Cassandra and Polyxena. Priam is represented as too old to

take any active part in the Trojan War; and in Homer, only once appears on the field of battle to ratify the truce before the duel of Paris and Menelaus. He, however, takes part in Trojan councils, and after the death of Hector visits the Grecian camp, guided by Hermes, to ransom the body of his son from Achilles. The later epics recounted his death at the capture of the city in somewhat different ways. The usual account represents him as slain by Pyrrhus, son of Achilles, in his own palace court at the altar of Zeus Herkeios, where he had taken refuge, after a feeble attempt at resistance.

PRIAPUS (Lat., from Gk. Πρίαπος, *Priapos*, Πρίπος, *Priēpos*). One of the lesser figures in the ordinary Greek and Roman mythology, though at Lampsacus, Cyzicus, and other places in the fertile districts on the Hellespont and Propontis he was held in high honor. The Lampsacene tradition called him son of Dionysus and Aphrodite, but his parentage was variously related. He was a god of fruitfulness and reproduction, particularly of gardens and vineyards, though his protection was also extended to the flocks and herds. In art he was sometimes represented as old and effeminate, clothed in Asiatic garb, a kerchief on his head, and with the folds of his garment held up and filled with fruit. More commonly his image was set up in gardens and vineyards to scare away birds and thieves. The character of these images led to many coarse jests in the poets and elsewhere. The *Priapea* is a collection of 80 short Latin poems, partly collected from the walls of the Temple of Priapus, and for the most part apparently not later than the Augustan age. Edited by Bücheler, *Petronius*, etc. (3d ed., Berlin, 1894).

PRĪBRAM, przhĕbrám, or **PRZIBRAM**. A town of the Crownland of Bohemia, Austria, 33 miles southwest of Prague (Map: Austria, D 2). It derives its importance from extensive lead and silver mines in the neighborhood, the largest in the Empire. They were worked as early as 1330, and since 1819 have been mainly the property of the Government. One of the shafts, the Albertschacht, is about 3400 feet deep. Close to the town is the Heilige Berg, a shrine visited by more than 100,000 pilgrims yearly. Population, in 1900, 13,576, mostly Bohemians.

PRIBER, prĕbār', **CHRISTIAN**. A French Jesuit who came among the Cherokee in 1736 and settled at Great Tellico town, in what is now East Tennessee. He at once set to work studying the Cherokee language, compiling a dictionary and grammar, and adapting himself to the native dress and mode of life for the time, in order better to accomplish their civilization and conversion. He drew up for their adoption a regular form of government modeled upon the European plan, with a prominent chief as principal ruler and himself as secretary. Fearing that the result would be to win over the Cherokee to the French interest, the English Government of South Carolina undertook to arrest him, but the Indians refused to give him up, and the commissioner was obliged to return under safe-conduct of an escort furnished by Priber. In 1741, however, he was seized by some English traders while journeying in Alabama and sent as a prisoner to Frederica in Georgia, where he soon afterwards died in prison.

PRIBYLOV, prĕ'bĕlŏf', **PRIBILOFF** (or **SEAL**) **ISLANDS**. A group of small volcanic islands in Bering Sea, belonging to the United States, 200 miles northwest of Unalaska, Alaska (Map; Arctic Regions, A 5). They aggregate 170 square miles in area, Saint Paul and Saint George being the largest. They are perfectly isolated and surrounded by fog, which causes the fur-seal to select these grounds for the purpose of breeding, so that these islands are the principal centre of the Bering Sea seal fisheries. They have about 400 permanent inhabitants.

PRICE, **BONAMY** (1807-88). An English economist. He graduated at Worcester College, Oxford, in 1829, taught from 1830 to 1850 at Rugby, and from 1868 until his death held the Drummond professorship of political economy at Oxford. He was an earnest advocate of the principles of free trade, and, in a series of lectures delivered in the United States (1874), he gave vigorous expression to his opinion on the subject. His publications include: *The Principles of Currency* (1869); *Currency and Banking* (1876); and *Practical Political Economy* (1878).

PRICE, **IRA MAURICE** (1856—). An American educator, born near Newark, Ohio. He graduated at Denison University in 1879, and for a year was professor of Greek and modern languages at the University of Des Moines—now Des Moines College—in Iowa. He was professor of Hebrew and cognate languages in the Baptist Union Theological Seminary in 1888-92, and then associate professor of the Semitic language and literature in the Graduate School of the University of Chicago. His works include: *An Introduction into the Inscriptions Discovered by Mons. E. de Sarzee* (1887), and *Syllabus of Old Testament History* (1891).

PRICE, **JOHN** (1600-c.1676). An English scholar, born in London. He studied at Christ Church, Oxford, and in 1635 attracted the attention of scholars by his edition of Apuleius's *Apologia*. Subsequently he held the Greek chair at Pisa, and still later was at Rome under the patronage of Cardinal Barberini. He was generally ranked among the foremost scholars of the time, this estimate being based for the most part on his work in Apuleius. Other publications by him are the *Metamorphoses* of Apuleius (1650), and numerous biblical commentaries, particularly on New Testament books, whose value is impaired by unwarranted emendations.

PRICE, **LANGFORD LOVELL** (1862—). An English economist and author, born in London. He was educated at Trinity College, Oxford, in 1888 became fellow and treasurer of Oriel, and was Newmarch lecturer in statistics at University College, London, in 1895-96. In 1897 he became governor of Dulwich College, and in 1898 was appointed an examiner in the moral sciences tripos at Cambridge. His publications include: *Industrial Peace* (1887); *Economic Science and Practice* (1896); *A Short History of English Commerce and Industry* (1900); and other works on subjects of political economy.

PRICE, **RICHARD** (1723-91). A British non-conformist divine, author, and political and moral economist. He was born at Tynnton, Wales, the son of a dissenting minister of stern Calvinistic tendencies. He completed his education

at the Fund Dissenting Academy in London, was a private chaplain at Stoke Newington from 1743 to 1756, and in 1758 was appointed preacher at Stoke Newington; later, until the year of his death, he held this appointment in conjunction with the ministry of Hackney. In 1769 he published his *Treatise on Reversionary Payments*; this was followed by his *Appeal on the Subject of the National Debt*, and by the compilation and publication of the celebrated *Northampton Mortality Tables*, and various works relating to life assurance and other annuities, forming most valuable contributions to the branches of science to which they respectively refer. In 1776 appeared his *Observations on Civil Liberty and the Justice and the Policy of the War with America*. Of this work 60,000 copies are said to have been sold in a few months. So greatly was it admired in the United States that the American Congress in 1778, through Franklin, communicated to him their desire to consider him a fellow citizen, and to receive his assistance in regulating their finances; an offer which he declined, principally on the ground of age. The work procured him the freedom of the city of London, and in 1783, at the same time as Washington, he received the honorary degree of LL.D. from Yale University. He died April 19, 1791. Consult Morgan, *Memoirs of the Life of Richard Price, D.D.* (London, 1815).

PRICE, STERLING (1809-67). An American soldier, born in Prince Edward County, Va. He was educated at Hampden-Sidney College, but removed to Chariton County, Mo., in 1831. In 1844 he was elected to Congress, but in 1846 he resigned and raised the Second Missouri Cavalry for the Mexican War. Under Gen. Stephen W. Kearney he marched from Fort Lavenworth to Santa Fé, suppressed an insurrection, and completed the conquest of California. He was promoted to be brigadier-general of volunteers July 20, 1847, marched to Chihuahua, and defeated a Mexican force in one of the last battles of the war at Santa Cruz de Rasales, March 16, 1848. From 1853 to 1857 he was Governor of Missouri. In the beginning of 1861 he was a 'Conditional Union' man, and co-operated with F. P. Blair (q.v.) and his 'Unconditional Union' party in calling the convention, of which he became president, to consider the secession of the State. He eventually joined the secessionists, was appointed major-general of State troops, May 18th, and began to organize the forces. He participated, under McCulloch, in the battle of Wilson's Creek, August 10, 1861; retreated before General Frémont, and spent the winter at Springfield. On the approach of Gen. S. R. Curtis, he retreated into northwest Arkansas. On March 7-8, 1862, he participated, under Van Dorn, in the battle of Pea Ridge, and soon afterwards was made a major-general of the Confederate Army, his commission being dated the day before this battle. Next he served around Corinth, and joined General Beauregard at Tupelo. He was assigned to command the Army of the West, but operated first in Tennessee. On September 19, 1862, he was defeated by Rosecrans at Iuka, Miss., and on October 3-4, 1862, took part in General Van Dorn's unsuccessful attack on Corinth. He served in northern Mississippi until February, 1863, when he was transferred to Arkansas. On July 21, 1863, he

took part in the unsuccessful attack on Helena. While in command of the district of Arkansas, under Gen. E. Kirby Smith, he opposed Gen. Frederic Steele. In September, 1864, he made a raid into Missouri, fought a number of battles and skirmishes, and gained 5000 recruits, but was forced to retreat into southwest Arkansas. At the close of the war he went to Mexico and became interested in a colonization scheme, but returned in 1866. Consult Snead, *The Fight for Missouri* (New York, 1886).

PRICE, THOMAS RANDOLPH (1839-1903). An American scholar, born in Richmond, Va. He studied at the University of Virginia, and at Berlin and Kiel until 1861, when he came home and served in the Confederate Army during the Civil War. In 1867 he was appointed to the professorship of Latin and Greek at Randolph College, and afterwards had the chair of Greek and English there, and the chair of Greek in the University of Virginia until 1882, when he was made professor of English language and literature in Columbia University. He edited *Othello* in the Bankside Shakespearé (1890), and published previously *The Teaching of the Mother-Tongue* (1877) and *Shakespeare's Verse Construction* (1889).

PRICE, SIR UVEDALE (1747-1829). An English dilettante, born at Foxley, in Herefordshire. He was educated at Eton and Christ Church, Oxford, but did not take a degree. At school and college he formed a close friendship with Charles James Fox, with whom he traveled in Italy and Switzerland, visiting Voltaire at Ferney. He was made a baronet in 1828. Price's principal publication was the *Essay on the Picturesque* (1794; enlarged 1796; completed in 3 vols., 1810). In this famous essay he argued in favor of natural beauty against artificial landscape. Scott followed his views in laying out Abbotsford.

PRICE'ARD, JAMES COWLES (1786-1848). An English physician and ethnologist. He was born at Ross, in Herefordshire, England. He was educated under private instructors, and later studied medicine at Bristol, London, and Edinburgh. His real interests, however, were in ethnology, in which he maintained the theory of the primitive unity of the human race. In addition to his classical studies and the mastery of French, Italian, Spanish, and modern Greek, he devoted himself to Celtic, and was the first to show the Indo-Germanic character of the Celtic group of languages. He published several works on insanity, one of which, his *Treatise on Insanity and Other Disorders Affecting the Mind* (1835), was long a standard work, and was made commissioner in lunacy in London, where he died. Prichard was practically the founder of anthropological science in England. Among his numerous works the most important are: *De Generis Humani Varietate* (1808); *Researches into the Physical History of Mankind* (5 vols., 1836-47); *A Review of the Doctrine of a Vital Principle* (1829); *Eastern Origin of Celtic Nations* (1831); *Different Forms of Insanity in Relation to Jurisprudence* (1842); *Natural History of Man* (1855); and *On the Relation of Ethnology to Other Branches of Knowledge* (1847).

PRICKLY HEAT. The popular name for *miliaria papulosa*, formerly known as *lichen*

tropicus. It is an eruptive skin disease characterized by a large area of small, red, acuminate papules crowded closely together, with excessive sweating, heat, and itching. In tropical countries it is a formidable disease. In this country it is frequently seen in a mild form during hot weather. Carthartics internally, and cooling lotions (such as weak carbolic acid, solution of boric acid, or of bicarbonate of soda) locally, give relief. See MILIARIA.

PRICKLY PEAR, or INDIAN FIG (*Opuntia*). A genus of 200 or more species of cacti, fully half of which occur in the Southwestern United States. Their fleshy, spiny or hairy stems, generally formed of compressed or cylindrical articulations, are leafless, except upon younger shoots, which produce small, cylindrical, early, deciduous leaves. The flowers which spring from among the clusters of pickles, or from the margin or summit of the articulations, are solitary, or corymbose-paniculate, generally yellow, rarely white or red. The fruit, which resembles a fig or pear, with clusters of pickles on the skin, is mucilaginous, and generally eatable. Some species are used for hedge-plants in warm countries. The common prickly pear or Indian fig (*Opuntia vulgaris*), a low-growing native of the Eastern United States, from Massachusetts southward, is naturalized in many Mediterranean and other warm countries. It grows well on rocks, and spreads over expanses of volcanic sand and ashes too arid for almost any other plant. Its yellow or purple tinged oval fruit, somewhat larger than a hen's egg, has a pleasant acid flavor, but is inferior to that of *Opuntia ficus indica* (supposed by some authors to be a form of *Opuntia Tuna*), of which there are many distinct varieties. It is extensively used in many countries as an article of food. The dwarf prickly pear, a variety of *Opuntia vulgaris*, very similar, but smaller, and having prostrate stems, is naturalized in Europe as far north as the sunny slopes of the Tyrol. The tuna (*Opuntia Tuna*), much used in some parts of the West Indies as a hedge-plant, and also valuable as a food of the cochineal insect, has red flowers with long irritable stamens and an edible fruit. *Opuntia Engelmanni* (see Plate of CACTI) is one of the larger flat-jointed species common from Texas westward. From Texas to California and in Mexico are many species with cylindrical stems and upright habit of growth, some attaining a height of 10 feet or more. Some of the thick, fleshy, flat-jointed species are eaten by stock in spite of their spines. Sometimes the spines are singed off to make the plants less difficult to eat. Spineless varieties are grown for the especial use of stock. In the Cape of Good Hope, Australia, and elsewhere the species introduced for stock food have become a serious pest.

PRIDE, THOMAS (?-1658). A soldier during the great Civil War in England of whose early life practically nothing is known. In 1644 he entered the Parliamentary Army as captain, and for a time served under Essex. His promotion was rapid, and he distinguished himself in several of the great battles, notably at Naseby in 1645, where he commanded Harley's regiment. In the quarrel between the army and Parliament he energetically supported the former, and was given command of Harley's regiment. On December 6, 1648, under orders from Fairfax, he

prevented over a hundred members from sitting in the House of Commons, arresting over forty of them, in order to prevent an agreement with Charles I. This incident has gone down in history as Pride's Purge. Pride was a commissioner at the trial of the King, and was one of those to sign the death warrant. He died October 23, 1658. At the Restoration he was attainted, but his body does not seem to have been exhumed.

PRIDE AND PREJUDICE. A novel by Jane Austen (1813), written in 1796. It describes English country life in the family of Mr. Bennett and his five daughters. The plot consists in the overcoming of Elizabeth Bennett's prejudice against Mr. Darcy, her wealthy suitor, and of his pride in his position, the two obstacles to their marriage.

PRIDEAUX, prē'dō, HUMPHREY (1648-1724). An early English Oriental scholar. He was born at Padstow, in Cornwall. He was educated at Westminster School, under Dr. Busby, and at Christ Church, Oxford, where he took the degree of B.A. in 1672. In 1676 he published in Oxford an account of the Arundelian marbles, under the title of *Marmora Ozoniensia*. In 1679 the Lord Chancellor Finch appointed him rector of Saint Clement's at Oxford, and in 1681 a canon at Norwich. In 1688 he became Archdeacon of Suffolk and in 1702 Dean of Norwich. His principal works are his *Life of Mahomet* (1697), which was long very popular, but was inaccurate and is now entirely superseded; and *The Connection of the History of the Old and New Testament* (1715-16). The latter treats with much learning, but less discernment, the affairs of ancient Egypt, Assyria, Persia, Judea, Greece, and Rome, as far as they bear on the subject of sacred prophecy. His life from material supplied by his son was published in London, 1748, and his letters, from 1674 to 1722, to John Ellis were edited for the Camden Society by Thompson (London, 1875).

PRIDEAUX, JOHN (1718-59). An English soldier, born in Devonshire, Eng. He became ensign in the British Army in 1739; took part in the battle of Dettingen in 1743; fought in America against the French; became colonel and brigadier-general; was intrusted by General Amherst with the command of the expedition to reduce Fort Niagara in 1759, and while preparing for the siege was killed in the trenches by the accidental bursting of a shell. For an account of his expedition, consult Parkman, *Montcalm and Wolfe* (Boston, 1884).

PRIDE OF INDIA. See CHINA TREE.

PRIDE'S PURGE. The forcible exclusion in 1648 of over one hundred members from the House of Commons by Col. Thomas Pride (q.v.).

PRIEGO DE CÓRDOBA, prē-ā'gō dā kōr'-dō-nā. A town of Southern Spain in the Province of Córdoba, situated 40 miles southeast of the city of that name (Map: Spain, D 2). It has a very old church and the ruins of an old castle. The chief manufactures are cotton textiles and olive oil. Population, in 1890, 16,745. Priego was an important fortress under the Moors, and was several times captured and recaptured.

PRIENE, prī-ē'nē (Lat., from Gk. Πριήνη). A Greek city of Asia Minor, situated on the north shore of the Latwic Gulf on a projecting

spur of Mount Mycale. The Acropolis and earliest settlement were on a plateau inaccessible except by rock-cut steps, while the later city covered a series of lower terraces. Priene was one of the twelve cities of the Ionian League, and claimed as its founder Æpytus, son of Neleus, though tradition told of a second body of settlers from Beotia, who gave the place in early times the name Cadme. At that time the city was close to the shore and possessed a small but good harbor, which has now been completely destroyed by the alluvial deposits of the Mæander, which have filled the greater part of the ancient gulf. Even in Strabo's time the city was over four miles from the coast, and the distance is now much greater. The city was from an early period involved in a quarrel with Samos about the ownership of lands on Mount Mycale, and inscriptions show that the dispute was not settled until Roman times. It was conquered in the second half of the seventh century B. C. by the Lydian King Ardys, and later, for its support of a Lydian revolt, it was severely treated by the Persians. Its prosperity was renewed by the wise councils of Bias (q.v.), but it again suffered for its participation in the Ionic revolt. Later it came under the rule of the Athenians, and was about B.C. 442 placed by them under the protection of Miletus. During the fifth and fourth centuries it seems to have been of small importance, and its real development took place after Alexander's conquest of Asia. Under his patronage was erected the beautiful temple of Athena Polias, the work of the architect Pythias, who seems also to have laid out the new city on the lower terraces. This temple was excavated by Pullan and Newton for the Society of Dilettanti in 1868, and found to be a masterpiece of Ionic architecture, rivaling in its proportions and finish the Erechtheum at Athens, though with interesting variations in details. The gradual silting up of the bay must have made the place unhealthy, and under the Byzantine emperors the city was deserted. Fortunately, no later settlers were attracted to the site, and thus the ancient houses and buildings fell into ruin, or were destroyed by earthquake and buried in débris.

From 1895 to 1900 excavations were undertaken by the Berlin Museum, and as a result the ancient city has been recovered, and for the Greek town life of the Hellenistic age Priene must take a place similar to that occupied by Pompeii (q.v.) for the life of Italy under the early Empire. The city was planned with great care. East and west, parallel to the mountain-side, ran a series of straight streets, connected at regular intervals by narrow lanes, which ascend the hill. The rectangles thus formed were normally 35 × 47 meters, and contained four houses, whose entrances were on the side streets, so that on the thoroughfares were only blank walls, unbroken save perhaps by windows in the upper stories. The theatre, council house, market-place, temple of Æsculapius, and other public buildings were also laid bare, and a wealth of inscriptions and smaller objects recovered. No complete publication of the results has yet (1903) appeared, but preliminary reports may be found in the *Archäologischer Anzeiger* published in the *Jahrbuch des archäologischen Instituts* (Berlin, 1900). A popular account by A. L. Frothingham was published in the *Century Ma-*

gazine, vol. lxii. (New York, 1901). For the temple of Athena Polias, see Pullan and Newton, *Antiquities of Ionia*, published by the Society of Dilettanti (London, 1881). For the ancient history, see Lenschau, "De Rebus Priensibus," in *Leipziger Studien*, vol. xii., 1890.

PRIESSNITZ, prēs'nīts, VINCENZ (1799-1851). The founder of hydrotherapy. He was born at Gräfenberg, in Austrian Silesia, and at first devoted himself to farming. It appears that a neighbor, who had been in the way of healing trilling wounds on himself and others by means of cold water, treated Priessnitz in this way for a serious injury from the kick of a horse; and having had his attention directed to the virtues of cold water, Priessnitz, indisputably possessed of sharpness of intellect and some aptitude for the practice of the healing art, began to cure ailments with cold water, and soon attained considerable reputation. As the number of applicants for advice went on increasing, he gradually came, by experiment, to form a system of treatment for the various cases presented. Opposition to him on the ground of unlicensed practising gave way before special authority from the Austrian Government, and in 1822 the Gräfenberg water-cure was established. In 1829 there were 49 patients, and in 1837 the number had risen to 586. In 1833 Priessnitz abandoned farming in order to devote himself to the care of the establishments which he had to provide for the reception and treatment of his patients. See **HYDROTHERAPY**. Consult: Philo von Walde, *Vincenz Priessnitz als Begründer des Wasser- und Naturheilverfahrens* (Berlin, 1897).

PRIEST (AS. *prēost*, OF. *prestre*, Fr. *prêtre*, priest, from Lat. *presbyter*, elder, presbyter). The title, in its most general signification, of a minister of public worship, but specially applied to the minister of sacrifice or other mediatorial offices. In the early history of mankind there is no priest. Such a state of affairs may be seen to-day in Central Australia, where, although there are many religious observances, there are no priests of any kind. A secondary stage is that of the Shamanistic Altaic tribes, whose religion is a spirit-worship and whose priests are called Shamans. The Shaman may believe in the existence of a supreme god, but he and his co-religionists pay attention only to the evil spirits whom alone they reckon with. The Shaman priest is a conjurer, an exorciser, and goes clad with amulets and charms of various sorts. He is called in to aid the afflicted as well as to rout devils, and so approaches the position of a medicine-man. The latter, however, as represented by the redskins, is a priest in a community that recognizes higher divinities than evil spirits and pays worship to gods without the help of the medicine-man. One step higher, and a patriarchal form of society invariably evolves the family priest, the head of the family, who represents them before the gods by performing sacrifice. From this to the clan chief priest and royal priest is but a series of steps in the same direction. Thus the Akkadian matriarchal state of society produced priests who were just such Shamans as to-day represent priesthood among the Finns and Samoyeds, while the patriarchal Aryans had as far back as we can trace them the father-priest.

The chief formal priesthoods of antiquity, certainly those most elaborately developed, were those of the Hebrews, the Egyptians, and the Hindus. Compared with these, the priests of Greece and Rome formed a less compact social organization. — (See GREEK RELIGION; ROMAN RELIGION.) The early Babylonian priests were little more than exorcisers. They attained their greatest dignity when their office was amalgamated with that of the king. They presided over sacrifice and offered libations, but with the common people they were chiefly renowned as devil-tamers and sorcerers. In course of time a priestly caste was developed, but it lacked the homogeneity and power of the Hindu priestly caste. Another powerful priesthood was that of the sun-god of the Aztecs, but this was a hierarchic power assumed from the beginning by the king, who was the high priest of the nation, all his family being regarded as sacred to the sun, the women of the king-priest being vestal virgins sacred to the god and king. The development of the priest and different ideas associated with his office are illustrated by the following account of the priesthood among the Hebrews, ancient Egyptians, and Hindus.

THE HEBREW AND JEWISH PRIESTHOOD. The Hebrew word for priest (*kōhēn*) is of uncertain origin; the Arabic *kāhin* means diviner, which corresponds to one of the most distinctive functions of the priesthood. According to the later Jewish theory, the priesthood belonged exclusively to the family of Aaron, while the remainder of the tribe of Levi held but the subordinate position of attendants at the sanctuary. But the examination of the historical records proves that this limitation of priestly prerogative was of late origin. The earlier strata of the historical books exhibit sacrifice as the right of all, especially of the heads of families. (Cf. the histories of the Patriarchs, and of Manoh and Micah, Jud. xiii., xvii., xviii.) Particularly was this the prerogative of national and religious leaders, of prophets like Samuel (I. Sam. xvi.) and Elijah (I. Kings xviii.), and of princes like David (II. Sam. vi., where he is clothed with the priestly ephod) and Solomon (I. Kings viii.; cf. ix. 25). Also David's sons are said to have been priests (II. Sam. viii. 18). But from the beginning of the national history there existed a family or caste to which the priesthood was a profession—the so-called tribe of Levi. Moses' institution of the ark required its ministers, and either he established a priestly caste, or, as is more probable, inasmuch as he belonged to the same family, he made use of an already existing caste. The part his brother Aaron played is obscure, but there is no reason to doubt that he exercised some special priestly functions.

The *locus classicus* for the position of the Levites in the early history is the story of Micah (see above), where, while a Levite is not necessary, he is much preferred; the Levite in question appears to be a grandson of Moses (Jud. xviii. 30, R. V. (See GERSHOM.) Again, the priest at the ark in Shiloh is Eli, of the line of Ithamar, son of Aaron; doubtless this connection gave the Levites a prerogative in priestly functions, of which they were enabled to take advantage upon the settlement of the ark in Jerusalem, and especially upon the building of the Temple by Solomon. From this time on, it

would seem, the sacerdotal functions of the religion of Yahweh in the Southern Kingdom came gradually to be monopolized by the Levites. The prestige of the Temple naturally tended in Judah to the exaltation of a special religious caste throughout that land. As for the kingdom of Israel, it is not stated (except in the doubtful passage I. Kings xii. 31) whether the priests belonged to the Levites or not; at all events, the prophets find no fault with their sacerdotal character. During the monarchy hierarchic grades arose; thus Abiathar of the line of Ithamar is the leading priest under David, to be dispossessed under Solomon by Zadok of the line of Eleazar. With the expansion of the caste and the growth of the sacred ritual, differentiations in office ensued, which resulted in the sacrificial functions being reserved for 'the sons of Aaron,' the remaining Levites, including Moses' descendants, being degraded to lower ministries. In Ezekiel's ideal sketch of the restored theocracy, the priesthood is confined to 'the sons of Zadok,' but in Chronicles the line of Ithamar is admitted, the high-priestly descent remaining, however, in the former family. The Restoration immensely exalted the position of the priesthood, especially of its chief. (Cf. Zech. iii., vi.) But it possessed no political force and little spiritual stimulus, so that it became a close corporation, intent upon enjoying and increasing its temporal privileges, leaving the development of religion in the hand of more popular leaders. The priesthood was raised to its highest honor through the assumption of the monarchy by the priestly Maccabean family, so that for seventy years a priest-king ruled Israel. (See MACCABEES.) With the fall of the Maccabean kingdom and the destruction of that family by Herod, the priesthood fell back to its conventional position, becoming the tool of the Romans, who made and unmade the high priest. (Cf. Annas and Caiaphas in the Gospels; also Acts xxiii. 2 sqq.) It had a small but strong party behind its back in the Sadducees (q.v.), so named after the above-mentioned Zadok. With the destruction of the Temple in A. D. 70 the priesthood ceased, as sacrifice was no longer legitimate. The tradition of the ancient caste is still faintly preserved in certain Jewish families.

As for the functions of the priesthood, in addition to the sacrificial acts, which were accompanied with blessing and prayer, there was the important office of the divine oracle, for which the instrument of Urim and Thummim (q.v.) was used, in all kinds of questions. (Cf. the histories of Saul and David.) Also the priests at the various sanctuaries possessed the right of giving the *torah* or instruction of God in all matters. (Cf. Deut. xvii. 8 sqq.) With the codification of the law, the teaching function passed from the priests to the more zealous lay expounders, the Scribes (q.v.). The support of the priests came in earlier times directly from the worshipers; they had the right to certain portions of the sacrifices, to the tithes, and other offerings. (Cf. I. Sam. ii. 12 sqq.; Neh. x. 32 sqq.) Later there was established a more definite provision for the support of the Temple and its priests in a poll-tax levied upon all Jews. (Exod. xxx. 13; Neh. x. 32; cf. Matt. xvii. 24, R. V.) The number of the priests grew to vast proportions, according to Josephus over 20,000, and

they were divided into 24 classes (I. Chron. xxiv.), the individuals coming up to Jerusalem at their appointed seasons. (Cf. Luke i.) The priests alone had access into the Holy Place, the high priest alone into the Holy of Holies. For the dress of the priests, see Exod. xxviii.; for general regulations, Levit. xxi., and *passim* in the Priestly Code. Consult the works mentioned in the article LEVITES; and Schürer, *History of the Jewish People* (Edinburgh, 1885-90); Wellhausen, *Prolegomena zur Geschichte Israels* (4th ed., Berlin, 1895). See AARON; LEVITES; HIGH PRIEST.

THE EGYPTIAN PRIESTHOOD. From the earliest times each Egyptian nome had its own local cult administered by a priesthood who formed a sort of collegiate body and were divided into several classes. The most numerous, and at the same time the highest, class were the priests called by Egyptians *hen nuter*, or 'servants of the god.' Their functions are not very clearly defined, but it would seem that they conducted the temple services with the aid of the inferior clergy, and delivered the oracles of the god. The duty of the *kheri-heb* (i.e. 'he with the book') or 'reciter priest' was to recite from the ancient sacred books, and he usually officiated at funerals, where he read over the deceased the appropriate chapters of the Book of the Dead (q.v.). As these old religious texts were believed to possess magical powers, the *kheri-heb* came to be regarded by the people as a magician. Lowest in order of rank stood the *we'b*, a name which signifies 'pure.' The *we'b* was required to examine into the purity of sacrificial animals before they were laid upon the table of offerings; he also poured out drink offerings and performed the rites of ceremonial purification by sprinkling with holy water. At the head of the priestly college of each nome stood the chief prophet or high priest, who in some localities bore a distinctive title. Thus the high priest of Memphis was called the 'Master Craftsman,' and the high priest of Heliopolis was the 'Great Seer' or 'He who sees the secrets of Heaven.' Under the Old and Middle Empires membership in the local priestly guild was hereditary, and the office of chief prophet was usually, though not necessarily, held by the ruling nomarch. During this period brotherhoods of pious laymen, termed *Unnut*, or 'hour-priests,' were attached to the various temples. Each member devoted a certain portion of his time to the temple services and the association took part in a body on stated occasions. Nobles and high officials usually held one or more priestly offices, but it is probable that in the majority of cases their duties were more or less perfunctory. The funerary chapels attached to the tombs of important personages were served by priests entitled 'servants of the Ka' (*hen ka*), and in the temples connected with the pyramids of Egyptian kings the worship of the deceased monarchs was conducted by priests styled 'prophets of the pyramid.'

Under the New Empire the position of the priesthood changed considerably, though to a less extent in the smaller country temples and in the ancient sanctuaries than in the great temples of the new capital, Thebes. The priesthood of Ammon, which may be considered as fairly representative of the later period, contained five gradations of rank: the first, second, and third

prophets, the divine father, and the *we'b*. The high priest or first prophet of Ammon held a very exalted position; he not only directed the affairs of the great national sanctuary, at the head of which he stood, but also exercised a sort of pontificate over all the temples of Egypt. The second prophet of Ammon had, among other duties, the superintendence of the artists belonging to the temple, and the *we'b* officiated as 'reciter priest.' The priestly office was no longer hereditary, as in the older period, and though the sons of priests often followed their fathers' profession, this was largely due to personal or family influence. A young man might be appointed to the priesthood in his fifteenth or sixteenth year, and his subsequent progress depended upon his abilities and upon the influence he could exert.

Priests of all classes were bound to observe rigid personal cleanliness. They shaved their heads, wore pure linen garments, and, in case of contact with anything ceremonially unclean, must perform the necessary rites of purification before they could exercise their sacred functions. Under the Old Empire they do not seem to have worn a characteristic dress, but in the time of the New Empire the ecclesiastical costume is quite distinctive. The details of the dress varied with the rank and functions of the wearer, but all wore a white linen skirt of ancient fashion. Some wore over this a wide cape which hung from just below the armpits, while others enveloped the body in a great cloak. Certain priests officiating at funerals are represented as wearing a panther skin, and the high priest of Heliopolis wore a panther skin dotted with stars, in allusion to his title of 'He who sees the secrets of Heaven.' The high priest of Memphis wore about his neck a curious necklace of elaborate design, and judges, who were all priests of *Mat*, wore an image of the goddess when on the bench.

In the older period noble ladies frequently bore priestly titles; they were usually prophetesses of Neith or Hathor, though to what extent they actually took part in the temple services is difficult to say. It is probable that such titles were chiefly honorary. Under the New Empire women of all ranks were connected with the various temples, especially that of Ammon of Thebes, as singers or musicians. They were regarded as forming the harem of the god and held different degrees of rank. Certain women of high rank, for example, bore the title of 'chief concubine' of the god, and at the head of the mystical harem of Thebes stood the 'legitimate wife of the god,' usually the Queen herself, who represented the goddess Mut, the heavenly consort of Ammon.

Connected with the Serapeum (q.v.) of Memphis and with other temples of Serapis in Egypt was a regularly organized monastic system. The monks lived in cells, which they were not permitted to leave, and received their food through air-holes in the wall, their sole channel of communication with the outer world. They called each other brethren, and sought by pious meditation to overcome their passions and attain a condition of insensibility to external impressions. Consult: Brugsch, *Aegyptologie* (Leipzig, 1891); Wilkinson, *Manners and Customs of the Ancient Egyptians* (London, 1878); Erman, *Life in An-*

cient Egypt (London, 1894); Deveria, *Monument biographique de Bakenkhonsou* (Paris, 1862). See also EGYPT.

THE HINDU PRIESTHOOD. The priesthood of India belongs to the first or Brahman caste exclusively. The growth of a priest caste can be traced in the history of Hindu literature. Originally a king, or pater-familias, whether of priestly caste or not, could officiate as a priest. Any defective knowledge on the part of a priest or any defective performance by him of the sacrificial rites was supposed to entail upon him the most serious consequences both in this life and in the future. As the duration of a Hindu sacrifice varies from one day to a year, or even more, the number of priests required at such a ceremony likewise varied. Again, as there are sacrificial acts at which verses from the Rig-Veda only were recited; others requiring the inaudible muttering of verses from the Yajur-Veda only; others, again, at which verses only of the Sama-Veda were chanted; and others, too, at which all these three Vedas were indispensable—there were priests who merely knew and practiced the ritual of the Rig-Veda, or the Yajur-Veda, or the Sama-Veda, while there were others who had a knowledge of all these Vedas and their rituals. The full contingent of priests required at a great sacrifice amounts to sixteen. Other inferior assistants, such as the ladle-holders, slayers, choristers, and the like, are not looked upon as priests. From one to four priests sufficed at the minor sacrifices, or those of daily occurrence. These were the rules and practices when the Hindu ceremonial obeyed the canon of the Vedic ritual; and the latter probably still prevailed at the epic period of India, though many additions to it are perceptible in the *Mahābhārata* (q.v.) and *Rāmāyanā* (q.v.). But at the Puranic period, and from that time downward, when the study of the Vedas had fallen into disuse, almost every Brahman not utterly ignorant became qualified to be a priest.

By a sort of historical retrogression to early conditions, in the latter-day sects of the Hindus it was not even necessary that a priest should be a Brahman. He might be of any caste, and priestesses as well as priests were permitted. The radical difference between the Vedic and Puranic ritual was in the abolition on the part of the latter of the Vedic service and in the method of slaughtering the sacrificial victim. In Vedic rites the victim is throttled; in Puranic rites its throat is cut, or very often no victim at all is offered, only vegetable offerings being made. The Puranic rites required no knowledge of the Vedas whatever. For the priesthood of the Buddhists, Jains, and Tibetans, see BUDDHISM; JAINAS; LAMAISM.

In the history of the Christian Church the question of the existence of a priesthood properly so called has given rise to fundamental divisions. On the one hand, Roman Catholic theologians contend that the Apostles were definitely made by Christ partakers of His mediatorial priesthood, with power to hand it down to their successors (see John xx. 21), and assert that from the date of this commission there has been an unbroken tradition of sacerdotal power, whose most important function is the offering of sacrifice for the living and the departed (see MASS); that the Christian ministry is as truly

a priesthood as that of the Jewish law, though with higher functions. There is a sense in which they admit this priesthood to be shared by the whole body of the faithful; but its specific exercise they claim is strictly limited to those who have been set apart by episcopal ordination. The Protestant bodies generally deny the existence of any such class or powers, and have therefore usually abandoned the use of the word 'priest,' substituting for it 'presbyter' or 'minister'—though Milton, dissatisfied with the thoroughness of the English Reformation, complained that "New presbyter is but old priest writ large." See ORDERS, HOLY; BISHOP; APOSTOLIC SUCCESSION.

PRIESTLEY, JOSEPH (1733-1804). An English clergyman and scientist. He was born at Fieldhead, near Birstall, in Yorkshire, the son of Jonas Priestley, a woolen cloth dresser. At six years of age, owing to his mother's death, he was adopted by his father's sister. He gave every evidence of an aptness for languages, studying Latin and Greek at school and Hebrew under a clergyman. Later he mastered Italian, French, and German himself, and ultimately acquired Chaldee and Syriac. He also had a mathematical mind and was given to scientific research. He was brought up a Calvinist; but as he grew older and began to think for himself he appears to have resented the Calvinist doctrine of original sin, which was synonymous with total depravity. In his twentieth year he was sent to the Non-conformist Academy at Daventry, where he remained three years. While there he joined freely in the theological discussions which prevailed, and found himself on every occasion on the heterodox side of the questions at issue. He next announced himself a necessitarian and finally became a Socinian and denied the divinity of Jesus Christ. Despite his unorthodox views, however, and a serious impediment in his speech, he sought the ministry, beginning at 22 years of age with a small congregation at Needham Market, in Suffolk. While there, he wrote *The Scripture Doctrine of Remission*, which was published in 1761. From Needham he went to Nantwich, and from there to Warrington, where he was appointed a teacher of languages and belles-lettres in a Nonconformist academy. Here he married and spent six of the happiest years of his life. The University of Edinburgh gave him an honorary degree in recognition of his literary work and he became acquainted with Franklin and Price.

He now manifested another side of his nature. Chemistry was then unborn, but Priestley, living next door to a brewery in Leeds, where he had removed to take charge of Mill Hill Chapel, became interested in the production of carbonic acid and succeeded in forcing it into water. He also wrote a *History of Electricity* and afterwards published political tracts and papers, some of which were opposed to the Government's attitude toward the American colonies. In 1772 he became librarian and "literary companion" to Lord Shelburne at a salary of £250 a year, and in 1774 he accompanied him on a Continental tour in France and Germany. About this time he wrote the *Letters to a Philosophical Unbeliever* and other works criticising the doctrines of Hume and others. He also made the discovery of oxygen and other gases, which gave him his scientific

reputation. In 1777 he published his *Disquisition Relating to Matter and Spirit*. This led to the severance of his relations with Lord Shelburne, and in 1780 he became the minister of a dissenting chapel at Birmingham. Here he made the acquaintance of James Watt and Dr. Darwin, the grandfather of the famous author of the *Origin of Species*, and here he had his celebrated controversy with Bishop Samuel Horsley, in which he was the recognized champion of Socinianism. His reply to Edmund Burke's *Reflections on the French Revolution* led to his being made a citizen of the French Republic and unhappily resulted in his house and chapel being burned by a mob and all his books, manuscripts, and scientific instruments being destroyed. This occurred in 1791, and because of the attack he left Birmingham and took up ministerial work at Hackney, London. He preached there for three years, and then, in 1794, removed to America, whither his sons had emigrated the year before. He settled at Northumberland, Pa., and spent the rest of his life there. He preached and lectured occasionally, but his services were not in great demand and his oratorical powers were failing. He declined the offer of a professorship of chemistry at Philadelphia, and later the principalship of the University of Pennsylvania. Most of his time was spent with his books and in scientific experiment, and he continued to write liberally till the hour of his death, although his later years were clouded by the physical infirmities of age. He died February 6, 1804.

Priestley was in many ways a remarkable man. He presented the unusual combination of theologian, scientist, and politician. His manifold and varied publications gave evidence of the scope of his genius. His pen was untiring. In religion and in politics he was a radical, but he was a sincere seeker after truth and a man of unblemished reputation and irreproachable moral character. His *Theological and Miscellaneous Works* and *Memoirs and Correspondence* were collected and edited by John T. Rutt, the former in 26 vols. (London, 1817-32), the latter in 2 vols. (ib., 1831-32). The edition contains over one hundred and thirty separate works, varying in size from short pamphlets to four-volume treatises, and the subjects treated of cover almost the whole ground of human knowledge and speculation.

PRIESTLEY, Sir WILLIAM OYEREND (1829-1900). An English obstetrician, a grand-nephew of Joseph Priestley. He was born near Leeds, studied at King's College, London, in Paris, and at the University of Edinburgh. In 1856 he settled in London, where for ten years (1862-72) he was professor of obstetric medicine at King's College, and from 1866 to 1876 was examiner in midwifery at the English Royal College of Surgeons. Priestley was knighted in 1893 and entered Parliament in 1896 as representative of Edinburgh and Saint Andrews. Following his master Simson, whose works he edited (1855-56), he devoted himself to the systematization of midwifery and largely contributed toward raising it from a position of mere empiricism.

PRIETO, pré-ã'tò, JOAQUIN (1786-1854). A Chilean politician, born at Concepcion. Although at first a Royalist, he took the patriot side in 1811, and was one of the foremost in the fight for independence. In the Civil War of 1829-30 he

defeated Friere at the Battle of Lircay (1830) and was made provisional President of Chile. This appointment was ratified six months afterwards, and he was reelected President in 1836. In the same year a war with Peru was begun in which Chile assisted the dissatisfied Peruvians to overthrow the Peruvian-Bolivian Confederation. General Prieto was commandant at Valparaiso at the time of his death.

PRIG, BETSEY. An ignorant, brutal nurse, the friend of Mrs. Sarah Gamp, and her "frequent pardner," in Dickens's *Martin Chuzzlewit*.

PRIGG VS. PENNSYLVANIA. An important case decided in 1842 by the Supreme Court of the United States, which defined the rights and duties of the various States with reference to the rendition of fugitive slaves. In 1826 Pennsylvania passed a law against kidnapping which imposed severe penalties upon any one who should remove any negro from the State with the intention of reducing or returning such slave to a condition of slavery. In 1837 a slave woman, Margaret Morgan, who five years before had escaped from her owner in Maryland into Pennsylvania, was seized by one Edward Prigg, the attorney of her owner, and, together with her children, was delivered to her mistress. Prigg was thereupon tried and convicted of kidnapping in the court of Yorke County, Pa., and the decision of this court was confirmed by the Supreme Court of Pennsylvania, to which Prigg appealed. The case was then carried before the Supreme Court of the United States which, by a vote of five to four, reversed the earlier decisions, and, among other things, decided (1) that by the Constitution the National Congress had the exclusive right to legislate concerning the rendition of fugitive slaves; (2) that the Legislatures of the various States had no power to pass legislation upon this subject; (3) that Pennsylvania's law of 1826 was therefore void; (4) that "the owner of a slave is clothed with entire authority in every State in the Union to seize and recapture his slave, whenever he can do it without any breach of the peace, or any illegal violence;" and (5) that no State could be compelled to aid the enforcement of a United States law on this subject. Though the right of slave-owners to their fugitive slaves was unequivocally confirmed, this decision has been regarded by many as in one respect a "triumph of freedom," since it relieved the various free States of any necessary participation in the catching and returning of fugitive slaves and encouraged them to pass laws, known as "Personal Liberty Laws," prohibiting all State officials, under heavy penalties, from aiding slave-catchers in any way and forbidding the use of State jails for the detention of captured fugitives. Consult Thayer, *Cases on Constitutional Law*, vol. i. (Boston, 1894); and 16 *Peters* 539.

PRILLIEUX, pré-yè', ÉDOUARD ERNEST (1836-). A French botanist, born in Paris. In 1877 he was appointed professor of botany at the Institut National Agronomique; in 1883 he was made inspector-general of agriculture, and in the same year became an officer of the Legion of Honor. His publications include articles on vegetable parasites, contributed to various French periodicals, and *Maladies des plantes agricoles et des arbres fruitiers et forestiers* (1895-97).

PRILUKI, præ-lōŭ'kâ. A district town in the Government of Poltava, Russia, situated 145

miles northwest of Poltava (Map: Russia, D 4). It has a considerable milling industry, and trades in the agricultural and animal products of the neighborhood. Population, in 1897, 19,055.

PRIM, *prém*, **JUAN**, Marquis de los Castillejos, Count of Reus (1814-70). A Spanish general and statesman. He was born in Reus, Catalonia, December 6, 1814, entered the army at an early age, rendered Narvaez (q.v.) efficient assistance in securing the downfall of Espartero in 1843, and was made a count. He was active in bringing about the return of Queen Christina, but in 1844, on account of his defection from Narvaez, was sentenced to imprisonment on a charge of conspiracy against the latter's life. In 1845 he was pardoned by the Queen, who made him Governor of Porto Rico. He led the progressive party in the Cortes (1848-53), was in exile 1853-58, and served in the campaign in Morocco in 1859-60. For his victory at Los Castillejos, January 1, 1860, he was made a marquis. In 1862 he was commander of the Spanish troops in Mexico, despatched to act in conjunction with the French and English forces, but disapproving of the plans of the Emperor Napoleon, he returned to Spain, where the Cortes sanctioned his course. In 1864 he was driven from Madrid, accused of participating in a military conspiracy, and in 1866 he began an unsuccessful insurrection against the Government of O'Donnell (q.v.), and was forced to flee to England. In 1868 he joined Serrano in the revolution which dethroned Isabella. In the provisional Government (October) Prim became commander-in-chief, Minister of War, and president of the Council. He was responsible for the choice of Prince Leopold of Hohenzollern to fill the vacant throne, a choice which brought on the Franco-German War (q.v.). Afterwards, through his agency, Amadeus I. (q.v.) was called to the throne. Prim was shot by an assassin December 28, 1870, and died from his wounds on the 30th, before Amadeus arrived in Madrid. Consult: Guillaumot, *Juan Prim et l'Espagne* (Paris, 1870); Blairet, *Le général Prim et la situation actuelle de l'Espagne* (Paris, 1870).

PRIMARY ELECTIONS (Lat. *primarius*, relating to the first or earliest, from *primus*, first, from *pro*, before; connected with Gk. *πρό*, *pro*, Skt. *pra*, Goth. *faür*, OHG. *fora*, Ger. *vor*, AS., Eng. *for*). The term used to designate the means through which candidates for elective offices are nominated. In a more restricted sense it refers to the election of delegates to nominating conventions (q.v.). A primary election differs from a regular election in that it is participated in only by the members of a particular political party. Thus there are Democratic primaries, Republican primaries, etc., at each of which the party convention is chosen or the party candidates are nominated directly. Until recently the primary election was a wholly extra-legal institution, that is, it was unregulated by statute. Each party framed its own rules and devised its own machinery for the selection of its candidates without legal restriction. The theory was that whatever political action antedated the election was beyond the domain of law, and hence the manner in which each party brought forward its candidates was to be determined by its own action. Every proposal to place the primary under the supervision of the State was attacked as a

species of despotism repugnant both to the liberty of parties and to the private rights of politicians. For a long time the non-officially conducted primary was the source of little or no abuse, but with the enormous growth of the city population and the complexity of political life in general the opportunities for fraud and corruption multiplied so that in many communities, especially in the larger cities, the primary degenerated into a confederation of selfish partisan associations from which a large majority of the voters were excluded. Thus in the city of New York the primary organizations came to be clubs with such rigid tests for membership that the number of members did not exceed one-fourth of the party voters, and in some cases was not more than one-sixth. Moreover, the party regulations did not afford sufficient means for identifying the voters of a given organization, with the consequence that the voters of one party could and sometimes did participate in the primaries of another party for the purpose of bringing about the nomination of unpopular candidates, with the hope of defeating them in the regular election. As a result of these conditions the demand for primary reform increased, and within the last decade laws have been passed in most of the leading States, including Minnesota, Nebraska, Ohio, New Jersey, Pennsylvania, Georgia, Kentucky, Mississippi, South Carolina, Texas, Wisconsin, Michigan, Missouri, Maryland, Massachusetts, California, Illinois, and New York, for the purpose of regulating primary elections and placing them under the supervision of the State.

In general these laws provide that sufficient public notice shall be given; that the elections shall be by ballot; that the election officers shall be sworn; that the expense of conducting the primaries shall be borne by the State, or, in some cases, as in Mississippi, by the candidates; that frauds shall be punished according to prescribed penalties; and that these requirements shall be compulsory in the large cities and optional elsewhere. A few of the most recently enacted statutes go even further and provide methods for securing, prior to the primary election, a fair and full enrollment of the voters of each party; for a proper test by which to determine who shall be considered a member of a particular party; for fixing a uniform primary election day; for using the 'blanket' form of ballot; for direct nomination of candidates, or, if through a convention, by delegates chosen by a pledging ballot at the primary; and for various regulations with regard to the organization and action of the convention. So far the most comprehensive and thorough-going measure of the kind is the primary election of Minnesota. Its distinguishing features are that it is compulsory; that it is general, applying to the nomination of county, municipal, and judicial officers and Representatives in Congress; that the elections for all parties are held on the same day as in the case of general elections; and that primary election day is also the first day for the registration of voters for the general election. The New York primary election law is equally thorough-going in several particulars. In Mississippi all nominations for State, district, county, and local officers are now made by primary election in accordance with the law governing the general election, but under the supervision of party committees. The general result of this legislation is to elevate the so-called primary to

the dignity of a preliminary election and surround it with the safeguards of law. It is undoubtedly a great step in the direction of purity of elections. See CAUCUS; CONVENTION; ELECTIONS.

PRIMARY QUALITIES. Those qualities which are in some systems of philosophy supposed to belong to the object as it is in itself; its antonym is secondary qualities, which are supposed to belong to the object only as it appears in consciousness. Various lists of primary qualities have been given. Locke's list includes: "Solidity, extension, figure, motion or rest, and number." The distinction between primary and secondary qualities cannot be consistently maintained, for the reason that the qualities of the thing-in-itself, even if there were such a thing, could never be known. See KNOWLEDGE, THEORY OF.

PRIMATE (Lat. *primas*, chief, from *primus*, first). A title in some of the Christian churches applied to a bishop as first in a province or group of provinces. A metropolitan is a primate as presiding in his province, or one of several metropolitans as presiding over others. The title does not seem to have come into ordinary use until the ninth century, after which it was given to the metropolitans of certain sees as the special representatives of the Pope. It strictly belongs to the Latin Church, but in its general use it corresponds with that of exarch in Eastern churches. In early usage the primate, as such, was the head of a particular Church or country, and held rank, and in some churches a certain degree of jurisdiction, over all the archbishops and bishops within the national Church. This jurisdiction, however, was confined to the right of visitation and of receiving appeals. In Africa the Bishop of Carthage, without the title, possessed all the rank and authority of a primate. The chief primatial sees of the Western Church have been: in Spain, Seville and Tarragona, afterwards united in Toledo; in France, Arles, Rheims, Lyons, and Rouen (the Archbishop of Lyons claiming the title of *primat des primats*); in England, Canterbury and York; in Germany, Mainz, Salzburg, and Treves; in Ireland, Armagh, and for the Pale, Dublin; in Scotland, Saint Andrews; in Hungary, Gran; in Poland, Gnesen; and for the Scandinavian countries, Lund. In England, as a settlement of the quarrels between Canterbury and York, the Pope designated the Archbishop of Canterbury as primate of all England, while the Archbishop of York was to be known as primate of England.

The title of primate is also given to several bishops of the Church of England in the British colonies. In the Episcopal Church of Scotland the title *primus* is given to the presiding bishop. He is chosen by vote of all the bishops without their being bound to give effect to seniority of consecration or precedence of diocese. See METROPOLITAN; PATRIARCH.

PRIMATES (Lat., chiefs). The highest order of mammals, including man, monkeys, and lemurs (qq.v.). They are characterized by the presence of well-developed clavicles, two pectoral mammae, and orbits directed forward, encircled by bone and shut off from the temporal fossae. The innermost digit of the hands and feet are usually opposable to the others; this is always so in at least one pair of limbs. The terminal joints of the digits bear flat nails, rarely claws. The incisor teeth are typically two in each jaw, direct-

ly in front, and canine, premolar, and molar teeth are also present. The brain (except in lemurs) exhibits a high type of structure, the cerebrum being very large and covering the cerebellum, and the surface of the former is much convoluted. Excepting man, the Primates are arboreal forms and are peculiarly well fitted for such a life. The tail is often long and sometimes prehensile. They are mostly small or medium-sized animals, though some of the anthropoid apes are large. They are omnivorous eaters, but fruit, berries, and other vegetable matter form a large part of their diet. The order is easily divided into two distinct sub-orders, the *Lemuroidea* and *Anthropoidea*, the former containing only lemurs and their near allies, spectres, pottos, aye-ayes, etc. (qq.v.), while the latter includes all the marmosets, monkeys, baboons, apes, and man (qq.v.).

PRIMATICCIO, prĕ'mā-tĕt'chō (called by the French "Le Primaticcio"), FRANCESCO (1504-70). An Italian painter. He was born in Bologna, and was the pupil of Innocenzo da Imola and Bagnacavallo, but was mainly influenced by Giulio Romano, his next master, whom he assisted in the decorations of the Palazzo del Te, in Mantua. In 1532 he was called by Francis I. to France, and with Rosso was employed at Fontainebleau. When Rosso died, Primaticcio took his place as director of works there. Before Francis's death Primaticcio had executed his most important frescoes in the Gallery of Ulysses at Fontainebleau, which were destroyed when the palace was remodeled in 1738. Under Henry II., Francis II., and Charles IX., he gained in fortune, and in 1554 he was made Abbé of Saint Martin of Troyes. Catharine de' Medici appointed him Court architect. In this capacity he made designs for the Valois tombs at Saint-Denis. During the years he spent at the Court of France his taste formed the so-called "school of Fontainebleau." He introduced Italian mannerism and so gave France that love for things Italian which predominated its art for more than two centuries.

PRIME. See BREVARY.

PRIME, EDWARD DORR GRIFFIN (1814-91). An American clergyman and journalist. He was born at Cambridge, N. Y., and graduated from Union College in 1832. He studied at the Theological Seminary at Princeton, where he completed the course in 1838. After some years with the Presbyterian Church of Scotchtown, N. Y., in 1849 he went to New Orleans for the benefit of his health, and then assumed the pastorate for a year of the Presbyterian Church in Eighty-sixth Street, New York City. In 1853 he became substitute editor of the *New York Observer*, while his brother, Samuel Irenæus, was in Europe. After the brother's return the two maintained an editorial association until 1885. He continued to edit the paper for a year after his brother's death. He made several extended journeys abroad, spent the winter of 1854-55 in Rome, and made a journey round the world in 1869-70 with the special object of studying the religious condition of Eastern countries. He published: *Around the World* (1872); *Forty Years in the Turkish Empire; or Memoirs of Rev. William Goodell* (1876); *Civil and Religious Liberty in Turkey* (1875); and *Notes, Genealogical, Biographical, and Bibliographical, of the Prime Family* (privately printed, New York, 1888).

PRIME, SAMUEL IRENÆUS (1812-85). An American clergyman, traveler, and writer. He was born at Ballston, N. Y., and graduated from Williams College in 1829. Three years later he entered Princeton Theological Seminary, but a severe illness compelled him to abandon his theological course in the first year. He was licensed to preach by the Presbytery of Bedford in 1833, and in 1835 was installed pastor of the Presbyterian Church at Ballston Spa, N. Y., but again illness compelled a change of occupation and he became principal of the academy at Newburgh, N. Y. He resumed preaching in 1837, being located at Matteawan, N. Y., but three years later entered upon the chief work of his life as editor of the *New York Observer*, a paper of which he afterwards came to be the principal owner. He was for a time one of the secretaries of the American Bible Society, a corresponding secretary of the Evangelical Alliance, the founder and president of the New York Association for the Advancement of Science and Art, president and trustee of Wells College, and a trustee of Williams College. He died at Manchester, Vt. Besides a large number of books of religious character he published: *Life in New York* (1846); *Travels in Europe and the East* (1855); *Letters from Switzerland* (1860); *The Power of Prayer* (1858); *American Wit and Humor* (1859); *The Alhambra and the Kremlin* (1873); *Life of Samuel F. B. Morse* (1875); *Irenæus Letters* (1880, 1885).

For his life, consult the autobiography in *Irenæus Letters*, series ii. (New York, 1885), and the sketch with bibliography in *Notes Genealogical, Biographical, and Bibliographical of the Prime Family*, by E. D. G. Prime (privately printed, New York, 1888).

PRIME, WILLIAM COWPER (1825—). An American journalist, born at Cambridge, N. Y. He graduated at Princeton in 1843, was admitted to the bar three years later, and practiced law in New York City until 1861, when he became part owner and editor-in-chief of the *New York Journal of Commerce*. In 1869 he gave up his editorial work and revisited Egypt and Palestine, where he had spent some time in 1855-56. He was a lover of art and in 1884 induced the authorities at Princeton to establish a chair of the history of art, of which he became the first incumbent. His interest in this subject brought him into close connection with the Metropolitan Museum in New York, of which he was first vice-president after 1874. He wrote, *Boat Life in Egypt and Nubia* (1857); *Tent Life in the Holy Land* (1857); *Coins, Medals, and Seals, Ancient and Modern* (1861); *The Owl Creek Letters* (1848); *Pottery and Porcelain of All Times and Nations* (1877); and the hymn "O Mother, Dear Jerusalem" (1865). He also edited *McClellan's Own Story* (1886).

PRIME MERIDIAN CONFERENCE. The terrestrial longitude of any place (see LATITUDE AND LONGITUDE) is the angle between two great circles on the earth's surface, both passing through the terrestrial poles, and touching respectively the place in question and some other place selected as the origin of longitudes. The great circle passing through the place thus selected as origin is called the prime longitude meridian. As early as 1630 an international conference was called to meet in Paris to fix a common prime meridian. The meridian of the island of Ferro, one of the Canaries, was selected, but the position

of the island with reference to points on the continent was not known, and was never authoritatively determined, so that practically this effort failed. In 1882 the United States Congress passed a joint resolution authorizing the President "to call an international conference to fix and recommend for universal adoption a common prime meridian to be used in reckoning longitude, and in the regulation of time throughout the world." The conference assembled in Washington, October 1, 1884. Delegates representing twenty-six countries were present, but they were not able to agree unanimously upon a prime meridian. However, most of them favored the adoption of Greenwich, England, as the origin of longitudes. The French delegates represented the only important nation that would not agree; and at present French authorities and navigators still reckon from Paris. The other important maritime nations now count from Greenwich, and in this number the United States are included.

PRIMER. A device for igniting the propelling charge in firearms or artillery. Cannon were first ignited by red hot irons or port fires applied to loose powder on the vent (touch-hole). These were replaced by slow match and later the powder was put into tubes or quills for insertion into the vent. In 1782 flint locks were used upon naval cannon. Friction composition was invented in 1807, and a few years afterwards percussion caps were introduced for cannon. Later, and to a certain extent at present, friction primers were used. A copper tube extending into the vent holds an explosive charge which is ignited by pulling a roughened wire through the friction composition in a housing in the outer end of the tube. This has been largely displaced by fulminate caps set in the bases of metallic fixed-ammunition cases and exploded by percussion or electricity. In percussion primers, a firing-pin strikes the fulminate of mercury which rests on an anvil. In electric primers the current heats a fine platinum wire set in guncotton. See GUNS, NAVAL; CARTRIDGE; SMALL ARMS; and ORD-NANCE.

PRIMES (from Lat. *primus*, first). One of the two classes into which integers are divided according to divisibility. Integers that are not exactly divisible by any integer except themselves and one are called *primes*, all others being called *composite* numbers. Thus, 1, 2, 3, 5, 7, 11, 13, 17, 19, 23, 29, are primes. Two integers are said to be prime to each other, or relatively prime, when they have no common factor except unity. Thus, 11 and 21, 15 and 32, 15, 32, and 48 are relatively prime. One of the earliest and best known methods of selecting primes is the sieve of Eratosthenes (B.C. 200). This consists in writing down all the odd numbers from 3 on and then striking out all the multiples of 3, 5, 7, Tehebitcheff (q.v.) (1850) was the first to reach any valuable conclusions in the way of ascertaining the number of primes between two given limits. Riemann (1859) also gave a well-known formula for the limit of the number of primes not exceeding a given number. See NUMBER.

PRIMITIVE BAPTISTS. See BAPTISTS, heading *Old School, or Primitive*.

PRIMITIVE METHODIST CONNECTION. See METHODISM.

PRIMITIVE SOCIETY. See GENS; MARRIAGE; SOCIETY; SOCIOLOGY; TRIBE.

PRIMO (It., first). A term used in music with the following significations: *prima donna*, the leading female singer (soprano); *prima vista*, at first sight; *prima rotta* (abbreviated *l*) is always followed by a bracket extending over one or more measures before a *repeat* begins; *tempo primo* denotes a return to the original rate of speed; *primo uomo*, the leading male singer (first tenor or soprano). This term is now no longer used, but was in general use during the seventeenth and eighteenth centuries, when in Italy the principal rôles in operas were written for and sung by male sopranos.

PRIMOGENITURE (ML. *primogenitura*, from Lat. *primogenita*, rights of the first born, neu. pl. of *primogenitus*, first-born, from *primus*, first + *genitus*, p.p. of *gignere*, to produce). In the law of inheritance, the right of the first born to take by descent the real property of a deceased ancestor, to the exclusion of all others of equal degree of consanguinity. The term has sometimes been employed in a wider sense to describe any priority which, in various legal systems, the law has accorded to the first born, thus comprehending the birth-right of the Hebrew and of Hindu law (where that belonged, as was not always the case, to the eldest son), which was at the most a right to a double portion of the inheritance, as well as the right of the eldest of the heirs in certain forms of Anglo-Saxon tenure to the chief house (*mansio*) of the ancestor. But the term is in modern law usually restricted to the persistent rule of inheritance which has for centuries maintained itself in our common-law system, whereby the eldest son of his issue, or, failing lineal descendants, the eldest male in the next degree of consanguinity, takes all the real estate of which his ancestor died seised and intestate, to the exclusion of all female and of junior male descendants of equal degree. Although not confined to lineal descendants, but comprehending the remotest degrees of consanguinity, the principle of primogeniture has never in the common law of land been applied to female heirs, who have, whether lineally or collaterally descended from their common ancestor, always been permitted, in default of male heirs, to share the inheritance equally.

This rule of descent, due, in its origin, to the exigencies of the feudal system, was formerly common to feudal Europe, but it has long since disappeared everywhere but in England. It has not generally been adopted in the English-speaking colonies of Britain, and though introduced with the rest of the common-law system into the American colonies, it was abrogated and abandoned by them at an early period in their history. See DESCENT; INHERITANCE. Consult Maine, *Ancient Law*, and id., *Early History of Institutions*.

PRIMORSKAYA, prê-môr'ská-yá. The Russian name of the Maritime Province (q.v.) in Siberia.

PRIM'ROSE, CHARLES. The Vicar in Goldsmith's *Vicar of Wakefield*, a simple-minded, devout, charitable man, bearing misfortunes with resignation and nobility.

PRIMROSE FAMILY. A popular name for an order of plants. See PRIMULACEÆ.

PRIMROSE LEAGUE, THE. A political league founded in London in 1883 in support of the principles advocated by the Earl of Beaconsfield (see DISRAELI), the name being adopted, it is said, on account of a preference shown by him for that flower. The membership includes both sexes, and the titles applied to members are Knight and Dame. There are associate members also and the branches or divisions of the league are known as habitations. The titles of the officers are grand master, chancellor (who is chairman of the grand council), and vice-chancellor.

PRIMULA (ML., fem. of Lat. *primulus*, diminutive of *primus*, first; so called in allusion to the early bloom), PRIMROSE. A genus of plants of the natural order Primulacæ, comprising about 150 species, mostly perennials, generally having only radical leaves and bearing the flowers in an umbel, more rarely solitary, on a scape. This genus is indigenous to Asia and Europe and more than half the number of species are native to the Himalayas, China, and Japan. Two small unimportant species are found in North America. Their fine colors and soft, delicate beauty have led to the cultivation of some of the species, and numerous varieties and hybrid forms with single and double flowers of various tints have been developed. They are extensively grown in ornamental gardening and also as house and conservatory plants. The common primrose (*Primula vulgaris*) is abundant in woods, hedges, and meadows in most parts of Europe. It has spoon-shaped and deeply veined leaves and bears its yellowish-white blossoms on single-flowered



EUROPEAN WILD PRIMROSE (cultivated form).

scapes. It is the parent species of many cultivated varieties. The name primrose belongs especially to this species. The English cowslip (*Primula officinalis*) is allied to the common primrose, and the oxlip (*Primula elatior*) is an intermediate between the two species. The Chinese primrose (*Primula sinensis*) is a popular ornamental plant in residences and conservatories and is commonly sold in flower markets. It is highly prized for its numerous large flowers of a variety of colors borne in umbels above the foliage. *Primula oboconica* is another beautiful Chinese species largely grown in conservatories for its numerous pale lilac or purple and sometimes nearly white blossoms.

The garden primroses prefer a rich, moist, loamy soil, and shady positions. The greenhouse varieties are potted in light soil chiefly composed of leaf mold with some sand and loam. The varieties grown in the open are propagated by seed or by dividing the clumps. The seed is sown out of doors in summer, preferably in pans; the young plants are potted and kept in a cold frame or the greenhouse over winter. In the spring the plants are set out in the pots where desired. Sometimes strong seedlings are planted in the open directly from the seed pans. The tender varieties grown under glass are also increased by seeds and offsets started in the greenhouse. The name primrose has reference to the early flowering of the plants of this genus. See *AURICULA*; *POLYANTHUS*; and Colored Plate of *GREENHOUSE PLANTS*. In America certain species of *Oenothera* (q.v.) are called evening primrose.

PRIMULA'CEÆ (Neo-Lat. nom pl., from ML. *primula*, primrose), PRIMROSE FAMILY. An order of dicotyledonous herbs, containing more than 350 known species, some of great beauty, mostly natives of temperate and cold regions. The flowers, often terminal on scapes, are regular, usually five-parted, and followed by capsular fruits. Among the best known genera are *Primula*, *Androsace*, *Lysimachia*, *Glaux*, *Cyclamen*, and *Dodecatheon*.

PRIMUM MOBILE (Lat., the first part movable). In the Ptolemaic system of astronomy, the tenth or outermost of the crystalline spheres, supposed to revolve from east to west every twenty-four hours, carrying the other spheres with it.

PRINCE (OF., Fr. *prince*, from Lat. *princeps*, from *primus*, first + *capere*, to take). An epithet which was originally applied to the *princeps senatus* of the Roman State, and afterwards became a title of dignity. It was adopted by Augustus and his successors; hence the word was afterwards applied to persons enjoying kingly power. In various parts of Continental Europe the title Prince is borne by families of eminent rank, but not possessed of sovereignty; and in England a duke is, in strict heraldic language, entitled to be styled 'high puissant and most noble prince,' and a marquis or earl as 'most noble and puissant prince.' Practically, however, in England, the term prince is restricted to members of the royal family. In Germany and Austria the ambiguity of applying the same title to the members of the royal houses and princely families, not sovereign, is avoided, the former being styled 'Prinz,' the latter 'Fürst.' The German Fürst takes rank below the duke (Herzog). In France the title has frequently been borne by e.g. the son of a duke, thus denoting no special rank or precedence.

PRINCE, THOMAS (1687-1758). An American historian and antiquary, born in Sandwich, Mass., of an old colonial family. He graduated at Harvard in 1707, was ordained, traveled in the West Indies and England, returned to Boston (1717), and was made assistant at the Old South Church (1718), with which he was connected till his death, which occurred at Boston, October 22, 1758. In 1703 he began a collection of manuscripts and books on the history of New England, which were deposited in the Old South Church tower, and partly destroyed by the Brit-

ish (1775-76). What remained forms the Prince collection in the Boston Public Library. Of the books, a catalogue was prepared by that institution in 1868, reëdited in 1870. Prince's chief work is *The Chronological History of New England* (1736-55; new ed. 1826), which he was not sufficiently encouraged to prosecute. Thus it does not come beyond the year 1633; for a large portion was devoted, according to the custom of early writers, to an abridged annalistic history of the world before the landing of the Pilgrims. Prince was so accurate, however, that what he wrote was of great value. Noteworthy, too, are his *Account of the English Ministers at Martha's Vineyard* (1727) and his *Earthquakes of New England* (1755). He published sermons during his lifetime, and several were printed after his death. As a scholar he probably surpassed all colonial Americans save Cotton Mather.

PRINCE ALBERT LAND. A large island of unknown area, lying to the north of the Mackenzie District of Canada, and constituting a part of the newly established Canadian District of Franklin (Map: Canada, G 2). It is typically Arctic in its character and has been but little explored. Its southern portions are known as Victoria Land and Wollaston Land.

PRINCE EDWARD ISLAND. The smallest province of the Dominion of Canada. It is situated in the southern part of the Gulf of Saint Lawrence, being separated from New Brunswick and Nova Scotia by the Strait of Northumberland (Map: Canada, S 7). Length, 130 miles; breadth, 4 to 30 miles; area, 2133 square miles. The surface is undulating; none of the hills, the chief of which are in the middle of the island and run from north to south, exceed 500 feet in height. The coasts are generally low and sandy, but in some places there are bold cliffs, varying in height from 10 to 100 feet and composed of Triassic red sandstone, the principal underlying formation. The island is indented with numerous bays and inlets, several of which, as Cardigan Bay on the east, the approach to Georgetown, and Hillsborough Bay on the south, the approach to Charlottetown, are deep and spacious and afford safe anchorage for large vessels. The rivers are short tidal streams. The climate is very healthful, being milder than that of the continental regions in the vicinity and free from the fogs which prevail on Cape Breton and Nova Scotia.

Forests originally covered the entire island. About two-thirds of the area is now cleared. Aside from some of the boggy and swampy lands, the whole of the island is cultivable. The soil, which is well watered with numerous springs and rivers, rests upon red sandstone. It consists for the most part of a layer of vegetable matter above a light loam, which rests upon stiff clay above sandstone, and is of great fertility. The agricultural products are about double the quantity required for local consumption. The natural fertility of the soil was injured by too great a succession of cereal crops, but it has been renewed through the application of mussel mud (a natural fertilizer dredged from the bays and rivers). According to the census of 1901 there were 161,472 acres of oats, 42,318 of wheat, 181,996 of hay, and 33,405 of potatoes. Turnips produce phenomenally and are extensively raised. Bar-

ley and buckwheat are grown. Fruit does not flourish so well as in Nova Scotia. The island has long been noted for its large production of eggs. Dairy farming is growing in prominence. Stock, especially cattle, are increasing in numbers. Prince Edward Island is extremely poor in minerals. Coal exists, but not under conditions which have made mining profitable. The neighboring waters abound in fish of many varieties, and the location of the island is most favored for fishing, yet the people have not engaged as extensively in the industry as have the populations in the sister provinces. In 1899, however, the catch was estimated at over \$1,000,000, the lobster fisheries constituting nearly one-half of the amount. Manufactures are not important, and are principally for domestic wants. Butter and cheese factories number 30 and 40 respectively and are constantly increasing in importance.

The Prince Edward Island Railway, which runs the length of the island, was built by the Dominion Government, by whom it is still owned and operated. All parts of the island are traversed by coach-roads. Regular water communication is maintained with the maritime provinces and Boston, except during the cold months, at which time navigation is impossible for the ordinary steamer. The Government has constructed a special boat which keeps up communication with New Brunswick throughout the winter.

The colonial government is vested in a Lieutenant-Governor, an executive council appointed by the Lieutenant-Governor, and a legislative assembly consisting of a single house whose members are elected by the people. The Province receives an annual subsidy from the Dominion, which constitutes nearly two-thirds of the total Government revenue. In 1901 the amount was \$196,931. The island is divided into three counties—Prince, Queens, and Kings—of which the chief towns are respectively Summerside, Charlottetown, and Georgetown. But most of the local affairs are in the hands of the provincial assembly.

POPULATION. The population decreased between 1890 and 1900 from 109,000 to 103,259. The density per square mile (50) is the highest for any Canadian province. This is true also of the average size of family (5.6.) The inhabitants are of British origin. Charlottetown, the capital, had a population of 12,080 in 1900. The strongest religious denominations are, in their order: the Roman Catholic, Presbyterian, Methodist, Anglican, and Baptist. Anglican episcopal authority over the province is exercised by the Lord Bishop of Nova Scotia, and Roman Catholic by the Bishop of Charlottetown. The free school system was established in 1851, and the schools are supported by Government grants and district assessments. The system is administered by a superintendent and council appointed by the Government. There is an average annual enrollment of 13,000 pupils, the expenditure for 1900 being about \$7.50 per enrolled child, of which amount the Government grants were nearly three-fourths.

The island is supposed to have been seen by Cabot in 1497. It came with Canada into English hands in 1763. The Legislature of Prince Edward Island at first declined to agree to the plan for a union of the British

North American colonies which resulted from the negotiations begun in 1864; but at last, in 1873, the colony entered the confederation and became one of the provinces of the Dominion. Consult Campbell, *History of Prince Edward Island* (Charlottetown, 1875).

PRINCE OF WALES, CAPE. See CAPE PRINCE OF WALES.

PRINCE OF WALES ISLAND. An island belonging to the Straits Settlements. See PENANG.

PRINCE PRETTYMAN. A character in the Duke of Buckingham's farce *The Rehearsal*. He is in love with Floris, and appears sometimes as a fisherman and sometimes as a prince. He is a parody on Leonidas in Dryden's *Marriage à la Mode*.

PRINCE RUPERT'S DROPS. Drops of glass thrown, when melted, into water, and thus suddenly consolidated. They have usually a form somewhat resembling a tadpole. The thick end may be subjected to smart hammering on an anvil without its breaking; but if the smallest fragment of the tail be nipped off, the whole flies into fine dust with almost explosive violence. The phenomenon is due to the state of strain in the interior of the mass of glass, caused by the sudden consolidation of the crust.

PRINCE'S-FEATHER. An annual plant. See AMARANTH.

PRINCE'S ISLANDS. A group of nine small islands, anciently called *Demonesi*, in the Sea of Marmora, 13 miles southeast of Constantinople. There are several monasteries on the islands, a theological seminary of the Greek Church, and a naval college. A favorable climate and fine scenery have made the group a popular place of resort. An earthquake in 1894 caused great destruction of life and property. Prince's Islands are of considerable historic importance. The population is estimated at about 10,000, though but four of the islands are inhabited.

PRINCES OF THE TOWER. The name given to Edward V. (q.v.) of England and his brother, Richard, Duke of York, the sons of Edward IV. (q.v.). In May, 1483, they were seized by their uncle, Richard, Duke of Gloucester (see RICHARD III.), and imprisoned in the Tower of London, while Gloucester was recognized by the Royal Council as Protector. The fate of the princes is a mystery. At first it was rumored that they had been murdered, although later they were popularly supposed to have been exiled. After twenty years Sir James Tyrrell alleged that on the refusal of Brackenbury, Constable of the Tower, to murder the princes at Richard's instigation, he himself with two servants had smothered them in their sleep. The testimony of Tyrrell, a notorious blackguard, in the reign of Henry VII. (q.v.), the enemy and successor of Richard, is by no means above suspicion. In the reign of Charles II. two skeletons were found at the foot of a staircase of the White Tower, and were buried in Westminster Abbey as the remains of the two princes. Here again the evidence is weak. The popular prejudice against their uncle in the Tudor reigns, perpetuated in great part by the pathetic scenes in Shakespeare's *Richard the Third*, are doubtless responsible for the attribution to Richard of a crime which has never been proved.

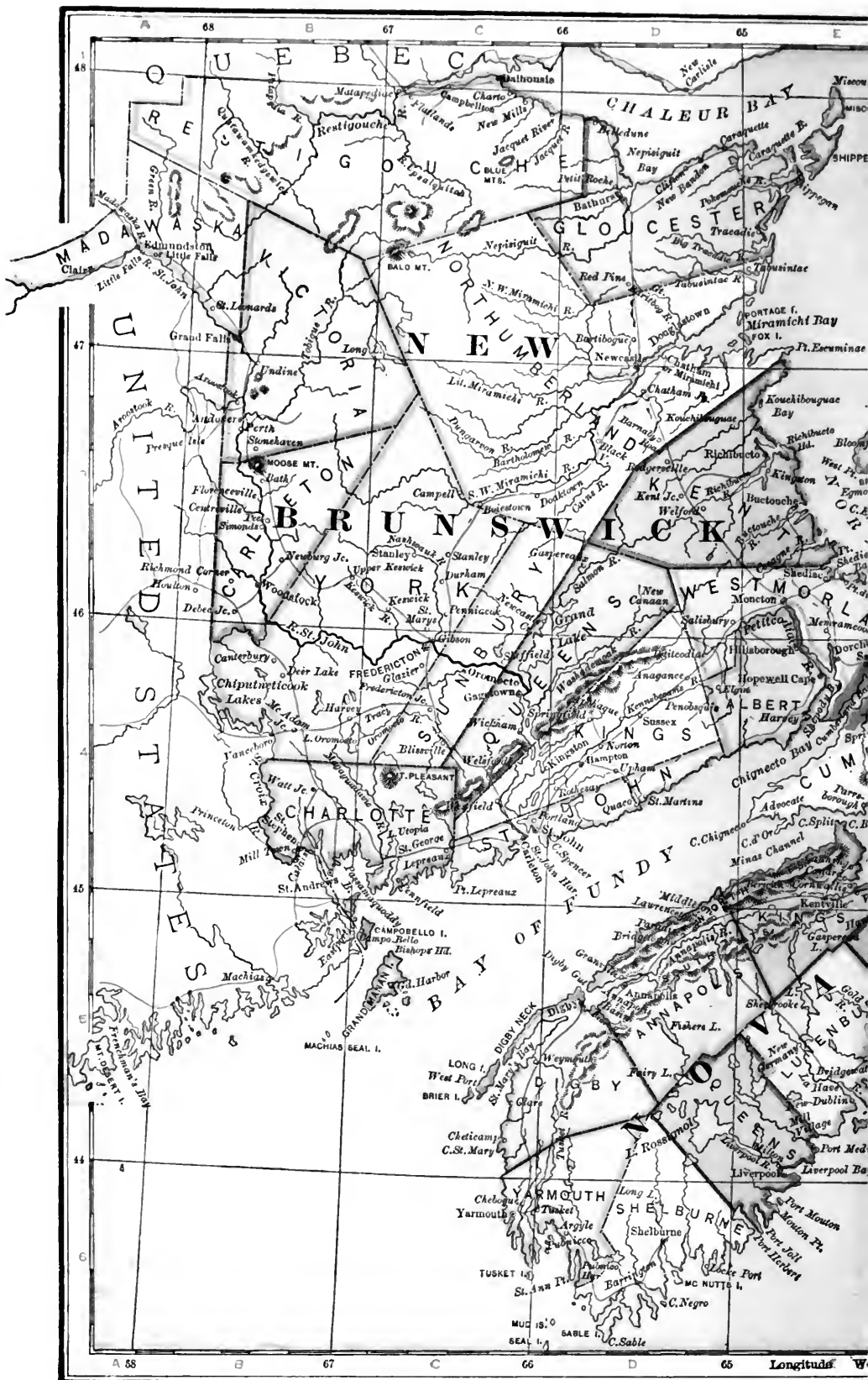

68 67 66 65

48

47

46

45

44

68 67 66 65

Longitude W

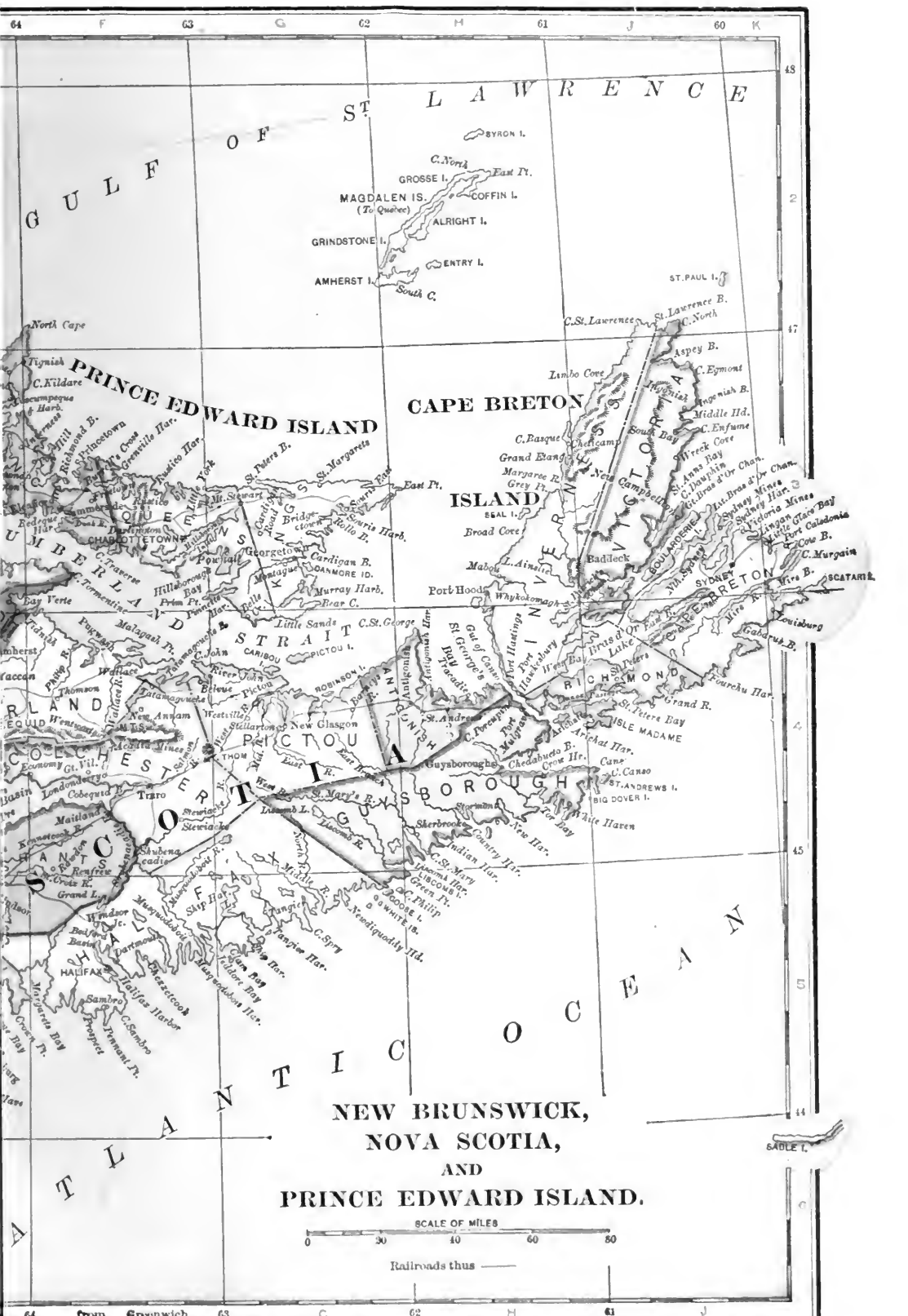

NEW BRUNSWICK,
NOVA SCOTIA,
AND
PRINCE EDWARD ISLAND.

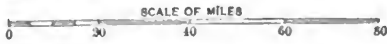

Railroads thus —



PRINCE'S PINE. An American evergreen plant. See WINTERGREEN.

PRINCESS, THE. A poem by Tennyson (1847). Mediæval in setting, but modern in thought, it is a kind of epic on the question of woman. The Princess Ida, to carry out her views, founds a college from which all men are debarred. The prince to whom she is betrothed enters with companions disguised as girls, and finally wins her love. The songs interspersed are some of the noblest lyrics of the last century.

PRINCESSE DE CLEVES, prân'sês' de klāv, LA. A novel by Madame de la Fayette (1677). The scene is the time of Henry II., but the plot is imaginary. The heroine loves the Duke de Nemours, but duty conquers, and her husband, though aware of her distress, never knows the name of his rival, a painful situation delicately treated. These characters stand for the author, her husband, and La Rochefoucauld.

PRINCES STREET. A famous street in Edinburgh, Scotland, overlooking the gardens beyond which stands the Castle. On one side it is lined with public buildings and monuments, and on the other is a beautiful terrace.

PRINCETON, prins'ton. A city and the county-seat of Bureau County, Ill., 103 miles west by south of Chicago; on the Chicago, Burlington and Quincy Railroad (Map: Illinois, C 2). It has the Matson Public Library and the library of the township high school, which was one of the first institutions of its kind established in the State. The surrounding district is fertile, and is engaged in farming and cattle-raising and coal-mining. The water-works and electric light plant are owned and operated by the municipality. Princeton was settled in 1830, incorporated in 1838, and chartered as a city in 1884. Population, in 1890, 3396; in 1900, 4023.

PRINCETON. A city and the county-seat of Gibson County, Ind., 27 miles north of Evansville; on the Evansville and Terre Haute and the Southern railroads (Map: Indiana, B 4). It has a fine court-house and a public library. The principal industries are farming and coal-mining, and the manufacturing of flour, carriages, wood handles, lumber, and brick. Shops of the Southern Railroad also are here. Princeton was settled in 1814. Population, in 1890, 3076; in 1900, 6041.

PRINCETON. A borough in Mercer County, N. J., 10 miles north by east of Trenton; on a branch of the Pennsylvania Railroad (Map: New Jersey, C 3). Princeton is a very picturesque town. It has an elevated site of great natural beauty, enhanced by wide avenues and fine shade trees. Its handsome residences, too, many of which are in the colonial style, add to its attractiveness. Princeton University (q.v.) is the chief feature of the borough. Other educational institutions in Princeton are the Princeton Theological Seminary (q.v.) and the Princeton Preparatory School. Population, in 1890, 3422; in 1900, 3899.

Princeton was first settled about 1696 and received its present name in 1724. It was of little importance, however, until the removal here from Newark of the College of New Jersey in 1756. On August 27, 1776, the first State Legislature of New Jersey assembled here and on the 31st chose William Livingston as Governor.

Washington here surprised and defeated a body of British on January 3, 1777. (See PRINCETON, BATTLE OF.) Congress, driven from Philadelphia by mutinous soldiers, met in Nassau Hall, Princeton, in June, 1783, and was in session until November 4th. It was here that news reached it on October 31st of the final signing of the definite treaty of peace with England. Consult: Hageman, *History of Princeton and Its Institutions* (Philadelphia, 1870), and a sketch in Powell, *Historic Towns of the Middle States* (New York, 1899).

PRINCETON, BATTLE OF. A battle of the American Revolution, fought January 3, 1777, at Princeton, N. J., between an American force under General Washington and an inferior British force under Colonel Mawhood and General Leslie. On January 2d Cornwallis with about 8000 men took up a position on the west bank of the Assunpink, at Trenton opposite the American army, which was inferior in every way to his own. Washington, unable on account of the floating ice to retreat across the Delaware, immediately resolved to attack the British detachments at Princeton and New Brunswick, and, leaving his camp fires burning, marched around the British left during the night. Reaching the Stony Brook Bridge, about three miles from Princeton, at sunrise, he sent General Mercer with about 400 men to destroy the bridge on the main road to Princeton, and went himself by a shorter way. The British force at Princeton, on its way to Trenton, encountered Mercer's brigade at the bridge. The Americans, occupying a piece of rising ground, began a vigorous fire upon the British, who soon made a bayonet charge and drove them from their position. During the fight General Mercer was mortally wounded, and his troops slowly retreated. The British pursued, but were soon stopped by a force of regulars and militia under Washington, who displayed the greatest personal gallantry. After a short but fierce engagement, the British retreated rapidly, some toward Trenton and some toward New Brunswick, while Washington entered Princeton and seized the military stores left there by the enemy. On the approach of Cornwallis, he withdrew, and took up a strong position at Morristown. The British loss was more than 100 killed and wounded, and about 230 prisoners. The American loss was about 100. Strategically the battle was very important, as it forced Cornwallis to fall back to New York, and left New Jersey in the possession of the Americans, besides inspiring the hitherto discouraged people to renewed efforts against the enemy. Consult: Stryker, *Battles of Trenton and Princeton* (Boston, 1898); and Johnston, *Campaign of 1776 Around New York and Brooklyn* (Brooklyn, 1878).

PRINCETON THEOLOGICAL SEMINARY. One of the oldest Protestant schools of theology in America. In 1809 the proposal to found a theological seminary for the Presbyterian Church was introduced before the General Assembly in the form of an overture from the Presbytery of Philadelphia. In 1812 the General Assembly fixed the location of the seminary temporarily at Princeton. The first session began on August 12, 1812, with three students in attendance, and in 1822 an act was passed incorporating the institution under the name of the Trustees of the Theological Seminary of the Presbyterian Church.

During its existence over 5000 students have been matriculated, coming from nearly every State of the Union and from foreign countries. The curriculum as at present organized embraces eight departments of study. The teaching force consists of ten professors and seven instructors. The biblical criticism of Princeton is conservative. The theology taught is the type of Calvinism set forth in the Westminster Confession of Faith and Catechisms, interpreted in the light of the classical literature of the English Puritan, Swiss, and Dutch theologians who wrote after the Synod of Dort. The representative publications of the seminary are the essays in the old *Princeton Review*, written by its professors, and in the *Presbyterian and Reformed Review* and the current *Princeton Theological Review*; together with the writings of Archibald and Joseph Addison Alexander, especially the commentaries of the latter on the Psalms and the Prophecies of Isaiah; the works of Samuel Miller, chiefly in ecclesiastical history; the three volumes of *Systematic Theology* by Charles Hodge; and the critical works of William Henry Green on the various Pentateuchal questions. The seminary had in 1903 a library of 70,600 volumes, and 30,000 pamphlets, grounds and buildings valued at \$526,150, an endowment of \$1,423,333, and a gross income of \$70,557. Its total attendance was 172 including 15 graduates and 8 special students.

PRINCETON UNIVERSITY. An institution of higher education at Princeton, N. J., founded in 1746. About 1726 William Tennent, a graduate of the University of Edinburgh, had established in Bucks County, Pa., a school known as the Log College, the success of which led in 1739 to a movement by the Synod of Philadelphia toward the establishment of a larger college for the middle colonies. The plan was abandoned owing to the unsettled condition of the times. In 1742 internal conflicts led to the division of the synod, and members of the newly formed Synod of New York determined on independent action. They sought a charter for the founding of a college in New Jersey, without assistance from either of the old synods, and secured it on October 22, 1746, from John Hamilton, Acting Governor of New Jersey. The institution was called the College of New Jersey and was situated at Elizabethtown. The first president was Rev. Jonathan Dickinson. A second charter was granted in 1748 by Jonathan Belcher, royal Governor of New Jersey, owing to doubts as to the validity of the first charter, and in order to give other religious communions a share in the administration of the institution. President Dickinson died in 1747 and was succeeded by the Rev. Aaron Burr, to whom belongs the credit for the organization of the curriculum, the procedure, and the discipline of the college. The institution was soon removed to Newark, where the first commencement was celebrated in 1748. In 1752 it was voted that the college be fixed at Princeton upon condition that the inhabitants secure to the trustees 10 acres of cleared land, 200 acres of woodland, and the sum of £1000. In 1754 the cornerstone was laid for the first building, which was named Nassau Hall. The college was completed and the students removed from Newark to Princeton in the fall of 1756. President Burr died in 1757 and was succeeded by Rev. Jonathan

Edwards, who died a month after assuming office. He was followed by Rev. Samuel Davies, who devoted much time to building up a college library. Davies was succeeded by Rev. Samuel Finley (1761-66) and in 1768 John Witherspoon, D.D., a Scotch clergyman, was inaugurated as president. He was a bold and active advocate of American independence. Among the students of this period were many later conspicuous as leading spirits, among them James Madison, Aaron Burr, William Bradford, Philip Freneau, and Henry Lee. The college suffered heavily during the war. The course of instruction was interrupted by the presence of both armies; Nassau Hall was wrecked, the library scattered, and the philosophical apparatus ruined. Yet only one commencement, that of 1777, was omitted, and the seven members of the graduating class for that year received their degrees a few months after the regular time.

President Witherspoon was succeeded in 1795 by Samuel Stanhope Smith, under whose administration the curriculum was broadened and the first provision for regular instruction in chemistry in an American college was made. On March 6, 1802, the interior of Nassau Hall was destroyed by fire, but was rebuilt in 1804. During the administrations of Presidents Ashbel Green (1812-22) and James Carnahan (1823-54) the institution had a rapid development. A department of law was established in 1846, but was abandoned in 1852 from lack of funds. Under President John Maclean (1854-68) four new professorships were established, with an endowment of \$195,000. On March 10, 1855, the interior of Nassau Hall was again burned, and was rebuilt in 1860. James McCosh of Queen's College, Belfast, was elected president in 1868, and resigned the office in 1888. During his term the attendance increased from 281 to 603, and the faculty from 10 professors and 7 tutors to 31 professors, 4 assistant professors, and 5 instructors. Gifts amounting to upward of \$3,000,000 were received, of which \$1,000,000 was expended in the erection of 14 buildings. Among the more important changes in the curriculum were the introduction of the system of elective studies (1870); the founding of the John C. Green School of Science (1873); and the establishment of the Graduate Department (1877). Francis Landey Patton (q.v.) became president in 1888. During the fourteen years of his administration the college increased from 603 to 1354 students, and the faculty from 40 to 100 instructors, while 17 new buildings were added to the equipment. On October 22, 1896, the one hundred and fiftieth anniversary of the signing of the first charter of the College of New Jersey, the corporate title was changed to Princeton University. Dr. Patton resigned the presidency in June, 1902, to resume the work of teaching in the Princeton Theological Seminary, and, at his own request, was succeeded by Woodrow Wilson (q.v.), the first lay president of the institution.

The government of the university is in the hands of a self-perpetuating board of trustees under the presidency of the Governor of New Jersey. In 1900 five alumni trustees were added to the board, holding office for five years. The requirements for admission to the college, since June, 1903, conform to the recommendations of the National Educational Association and the

College Entrance Examination Board, whose certificate is accepted in place of the regular examination. The university is organized in three departments, the Academic, the School of Science, and the Graduate School. The college course embraces instruction in the three departments of philosophy, language and literature, mathematics, and natural science. Most of the studies of the freshman year are required, with election between French and German. The elective studies of the sophomore year are Latin, Greek, mathematics, French, and German, while the elective course of the junior year occupies two-thirds of the student's time, and the senior year offers seven elective courses. Optional courses are also offered for those who wish to extend their work in special studies. In the John C. Green School of Science four-year undergraduate courses in general science lead to the degree of B.S., and the courses in chemistry and electricity to the degrees of C.E. and E.E. The graduate department offers over 200 courses of study leading to the master's and doctor's degree in arts and science. A number of fellowships, ranging in value from \$200 to \$600, are offered for advanced work.

The university campus now consists of 225 acres. Nassau Hall (1756) contains the histological and paleontological laboratories, the laboratory of experimental psychology, the department library of geology and paleontology, and the museum. The dormitories include West College (1836); Reunion Hall (1870), named to commemorate the reunion of the Old and New Schools of the Presbyterian Church; Witherspoon Hall (1877); Edwards Hall (1880); Albert B. Dod Hall (1890); David Brown Hall (1891); Blair Hall (1897), a sesquicentennial gift from the Hon. John Insley Blair; Stafford Little Hall (1899), which is joined by an extension erected in 1902; and University Hall (1876). Upper and Lower Pyne buildings were erected in 1896. The sod was turned by President Wilson for a new dormitory, presented by the class of 1879, on the day of his inauguration, October 25, 1902. There are two library buildings, the Chancellor Green Library (1873), refitted as the working library of the university, and the New Library Building, dating from the sesquicentennial. It is connected with the Chancellor Green Library. The general collection occupying the united buildings in 1903 numbered 175,000 volumes and 47,000 unbound periodicals and manuscripts. Departmental libraries and special collections raise the number of volumes at the disposal of the students to a total of over 265,000. The museums comprise those in geology and archaeology, biology, historic art, and mathematical models. The laboratories include the magnetic observatory, in connection with the School of Electrical Engineering; the chemical, histological, biological, paleontological, and civil engineering laboratories, with the mineralogical collections of the School of Science. Other important university buildings are the Halsted Observatory, containing the Clark equatorial, of 23 inches aperture, for scientific work, chiefly in the department of astronomical physics; the observatory of instruction, with a Clark equatorial of 9½ inches aperture, devoted entirely to the use of students; the Isabella McCosh Infirmary, erected by alumni and friends of the university; Dickinson Hall (1870), for the work of the academic

department; Marquand Chapel (1881); Alexander Hall, seating 1500 persons, and used for commencement exercises and other public occasions; and the gymnasium (1869). A new gymnasium was erected in 1902-03 by the alumni at a cost of more than \$280,000.

The university provides pecuniary aid to deserving students through a large number of endowed scholarships and charitable funds. In 1903 the total student attendance was 1383, and the faculty numbered 108. The endowment is about \$2,500,000, and the annual income about \$275,000.

PRINCIPAL (Lat. *principalis*, chief, from *princeps*, first, chief, prince). A legal term having several different applications. Thus, in criminal law, all actually participating in the commission of a crime or who are present aiding and abetting in its commission are principals, while those who aid or abet before or after its commission are termed accessories. Actual physical presence is not necessary to constitute one a principal. One may be a principal who is only constructively present at the commission of the crime by aiding in its commission at the time. See **ACCESSORY**.

In the law of agency, one who appoints an agent is called a principal. (See **AGENT**; **MASTER AND SERVANT**.) In the law of suretyship, the principal debtor for whom another becomes surety is known as a principal. See **SURETY**; **FRAUDS, STATUTE OF**.

PRINCIPAL. The name given to an important stop of the organ, of 4-foot pitch on the manual, and 8-foot pitch on the pedal. It is sometimes termed the octave stop, because it is tuned one octave above the diapasons. It stands midway in pitch between the diapasons and the fifteenth; and in tuning an organ it is, owing to its clearness of tone, the best stop to begin with for the adjustment of other stops; probably from this fact it derives its name. See **ORGAN**.

PRINCIPAL AND AGENT. The legal rules governing this relationship are set forth under the heading **AGENT**, and the subject in its general aspects is there discussed. For the special doctrines applicable to the most important examples of this relationship, see **ATTORNEY**; **AUCTIONEER**; **BROKER**; **COMMISSION MERCHANT**; **DEL CREDERE**; **COMMISSION**; **SHIPMASTER**.

PRINCIPAL AND SURETY. A phrase descriptive of two persons who are indebted to a third, but whose relations are such as to make it the duty of the principal to discharge the debt and save the surety harmless therefrom. See **GUARANTY**; **SURETYSHIP**; and the authorities there cited.

PRINCIPE, prín'thâ-pâ. A district on the east coast of Luzon, Philippine Islands, belonging to the Province of Tayabas (q.v.).

PRINCIPE (prín'châ-pe), IL (It., the Prince). A celebrated short political treatise by Niccolò Machiavelli (1513) showing how a ruler might gain and extend absolute power. Cesare Borgia was presumably the model for the prince, and the dissimulation and treachery advocated to attain success made Machiavelli's principles synonymous with political infamy. A modern view has credited him with ardent longing for Italian unity and with the purpose of portraying merely the methods of his day.

PRINCIPIA (Lat., principles). A famous mathematical treatise in Latin, by Sir Isaac Newton (1687). It consists of three parts, two on the motions of bodies and one on the solar system, and contains the full development of Newton's great discovery, the principle of universal gravitation.

PRINCIPES. See AGAPEMONE.

PRINDLE, CYRUS (1800-77). An American abolitionist and one of the founders of the Wesleyan Church of America. He was born in Vermont, and entered the New York Conference in 1821; an abolitionist in principle, he was removed from important appointments to the poorest; in 1843 with others he seceded from the Methodist Episcopal Church and founded the Wesleyan Church; when the work of the Church was done, with about 100 others of his ministerial associates, he came back to the Methodist Episcopal Church.

PRINGLE, priŋ'g'l. Sir JOHN (1707-82). An English physician, born at Stichel, Roxburghshire, and educated at Saint Andrews, at Edinburgh, at Leyden, and in Paris. In 1734 he was appointed professor of metaphysics and moral philosophy in Edinburgh University. He settled in London in 1748, where he became physician to the Queen in 1761 and to the King in 1774. His most important work was done as an army sanitarian, in which field his *Observations on the Diseases of the Army* (1752) is regarded as a classic. His life by Kippis is prefixed to *Six Discourses Delivered at the Royal Society* (London, 1783).

PRINGLE, THOMAS (1789-1834). A Scottish poet, born at Blaiklaw, Teviotdale, Roxburghshire. He was educated at the University of Edinburgh. In 1811 he became clerk in the register office, Edinburgh, and with his friend, Robert Story, began writing clever satirical verse. A poem contributed to Hogg's *Poetic Mirror* (1816) resulted in a friendship with Scott. Helped by James Cleghorn, he edited Blackwood's *Edinburgh Monthly Magazine* (six numbers, April to September, 1817). Having quarrelled with the publisher, he resigned, and *Blackwood's Magazine* (established October, 1817) took the place of the older periodical. In 1820, to better his fortune, Pringle sailed for South Africa, where he formed the settlement of Glen-Lynden, became librarian at Cape Town, founded an academy, and started a Whig newspaper and a magazine, both of which were suppressed by the Government. Returning to England (1826), he became secretary to the Anti-Slavery Society (1827). In his new position he displayed great energy. He died just as he was about to sail for South Africa, on December 5, 1834. Pringle's works comprise a collection of his early poems entitled *Ephemerides* (1828); *African Sketches* (1834), composed of poems inspired by South Africa and the "Narrative of a Residence in South Africa." The latter volume contains "The Emigrants" and "A Farm in the Desert." Pringle's finest poems. Editions by Conder (1835) and Ritchie (1838) contain biographical sketches.

PRINGLE-PATTISON, ANDREW SETH (1856—). A British philosopher. He was born at Edinburgh; was educated there and in Germany; became professor of logic, rhetoric, and metaphysics at Saint Andrews (1887), and professor of logic

and metaphysics at Edinburgh in 1891. In 1898 he assumed the name Pringle-Pattison on succeeding to the Haining estate. He has published: *The Development from Kant to Hegel* (1882); *Essays in Philosophical Criticism*, with R. B. Haldane (1883); *Scottish Philosophy* (1885); *Hegelianism and Personality* (1887); *Man's Place in the Cosmos* (1897); *Two Lectures on Theism* (1897).

PRINGSHEIM, prings'him, NATHANAEAL (1823-94). A German botanist, born at Wziesko, near Landsberg, Silesia. For a time he studied medicine, associated himself with the Liberal political movement, and then turned definitely to natural science, in which cryptogamic botany soon became his speciality. After studying at the universities of Breslau, Leipzig, Berlin, and Paris, he submitted, at Berlin, an essay *Zur Entwicklungsgeschichte der Achlya proliferata* and became a lecturer there. As a result of his essays *Grundlinien einer Theorie der Pflanzenzelle* (1854) and *Ueber die Befruchtung und Keimung der Algen und das Wesen des Zeugungsaktes* (1855-57), he was chosen in 1858 a member of the Royal Academy of Scientists. In 1857 he founded the *Jahrbuch für wissenschaftliche Botanik*, which he edited up to the time of his death. He was professor of botany at Jena from 1864 to 1868 and then returned to his lectureship at Berlin, but he had little interest in teaching and devoted himself almost entirely to research. In 1882 he founded and became the first president of the German Botanical Society. Pringsheim, Thuret, and Bornet are regarded as the founders of the scientific study of the algae, and the German was one of the first investigators to prove the existence of a sexual process in this kind of vegetation. During the last twenty years of his life his attention was directed more to plant physiology than to the morphological questions in which he won his greatest successes. He made extensive researches in the effect of light on plants, and developed a new, though not wholly satisfactory, theory of the function of chlorophyll. He was one of the foremost cryptogamic botanists of the nineteenth century. Among his works, which were published in four volumes at Jena in 1895-96, are the following: *Beiträge zur Morphologie der Meeresalgen* (1862); *Ueber die Embryobildung der Gefässkryptogamen und das Wachstum von Salvinia natans* (1863); *Ueber Paarung von Schwärmsporen* (1869); *Weitere Nachrichten zur Morphologie und Systematik der Saprolegniaceen* (1873); *Untersuchungen über das Chlorophyll* (1874).

PRINSEP, JAMES (1799-1840). An English architect and Orientalist, who studied under Pugin, the celebrated architect. Owing to impaired eyesight, he gave up for a time his studies, and went out to India (1819), where he became in turn assistant assay-master in the Calcutta mint, assay-master in the Benares mint, and eventually assay-master in the Calcutta mint (1832). At Benares he designed the mint, built a bridge over the Karamasa and took down and restored the minarets of the Mosque of Aunrungebe. At Calcutta he constructed a canal between the Hugli and the Sunderbands. In numismatics he won distinction by *Useful Tables Illustrative of Indian History*. At Calcutta he edited *Gleanings in Science*, afterwards the journal of the Asiatic

Society, of which he became secretary. Giving his attention to antiquities, he succeeded in deciphering inscriptions which had hitherto baffled scholars. Weakened in health, he returned to England in 1838, and died two years later. Consult the *Essays on Indian Antiquities, Historic, Numismatic, and Palæographic, of the Late James Prinsep* . . . with *Memoir by Henry Thoby Prinsep*, edited by Thomas (London, 1858).

PRINSEP, VALENTINÉ CAMERON (1838—). An English painter and author, born in Calcutta, India. He was a pupil in London of Leighton, whose style he imitated, and of Gleyre in Paris, and began to exhibit at the Royal Academy in 1862. His paintings "A Minuet," "A Bientôt," and "The Linen Gatherers," were at the Exposition of 1878. He went to India to paint the "Declaration of Queen Victoria as Empress" in 1876, a large canvas with many portraits. He was elected to the Royal Academy in 1897. His publications include *Imperial India: An Artist's Journal* (1879), several plays, and some writings on art.

PRINSTERER, GUILLAUME GROEN VAN. See GROEN VAN PRINSTERER.

PRINT (by apheresis, from ME. *emprinten*, *enprinten*, to imprint, from OF., Fr. *empreinte*, imprint, p.p. of *empreindre*, It. *imprimere*, to impress, imprint, from Lat. *imprimere*, *inprimere*. to impress, from *in*, in + *primere*, to press). In the arts, anything which is the result of, or which takes its principal characteristic from, having been printed upon or impressed. The most important use of the term, especially in connection with fine arts, is as being the only proper term for that picture which is produced by taking an impression, as upon paper, from an engraved plate or block. It is much the custom in the United States to speak of such pictures as 'engravings,' but this is, of course, erroneous and misleading, and the term 'print' is the one which should be used in such cases. The art of printing from an engraved plate is not wholly mechanical, because there are many cases in which the impression taken is not merely a flat transfer from the unmodified, hard surface. Thus, in printing woodcuts, it is customary to use what are called overlays, which are pieces of thin paper cut in peculiar shapes, accommodated to the design engraved upon the block; and these overlays are placed where needed behind the paper upon which the transfer is to be made in such a fashion as to cause certain parts of the printing to be stronger and blacker than others. So in the printing from dry point (q.v.) plates in which that process has been used for the completion of an etching (q.v.) it is quite usual to leave a certain amount of ink upon the surface of the copper plate. As in the *Liber Studiorum* (q.v.) the plates are etched and also charged with mezzotint or aquatint, so, in prints made by this process, the line work of the draughtsman is completed in a way by the surface work or gradation made by the printer. In ordinary commercial use, the word 'print' is used in a special sense, as meaning one of the more ordinary impressions from the block or plate in contradistinction to the proofs of different kinds. See PROOF.

PRINTING. The process of taking impressions, generally on paper in ink, of printing types or of designs, drawings, or photographic prints,

which have been previously cut, etched, drawn, or engraved on some solid surface. Printing with ink is done by three methods: (1) from a raised surface in high relief, as in type or woodcuts; (2) from a sunk or incised surface, as in copper-plate engraving; (3) from a flat surface on stone made repellent to ink in portions by daupening the stone, as in lithography (q.v.). As the raised surface is easiest inked and impressed, typography is found most generally useful.

The Chinese methods of printing were practiced at a very ancient date. As early as B.C. 50 the Chinese had originated a method of printing in ink on paper by means of engraved blocks, although it was not until nearly a thousand years later that printing in this manner was extensively practiced. In A.D. 925 the principal Chinese classics were printed for the Imperial College of Peking from blocks of wood engraved in relief. The method of producing these printing-blocks is described as follows: The work which is intended to be printed is first written on sheets of thin transparent paper. Each of these sheets is then pasted face downward upon a block of wood and an engraver with suitable tools cuts away the portions of the paper and block on which nothing is traced, thus leaving the characters in relief and producing a printing-block. To print from these blocks, they are inked; a sheet of paper is carefully laid on and a brush is passed over the paper, pressing it upon the inked surface and thus securing a printed impression. By this process a separate engraved block had to be prepared for each printed sheet or page. The Chinese are also credited with having used movable type as early as the twelfth and thirteenth centuries, and such types are now used extensively by the European missions in China for printing Chinese books and papers. The chief difficulty in using movable types for printing Chinese is due to the fact that each Chinese word requires a separate character instead, as in the European languages, of being composed of letters or characters which are resolvable into an alphabet. The native Chinese printer to-day, when uninfluenced by European teaching, uses the primitive printing-blocks described above.

In Europe in classical and mediæval times books were made by transcribing them in manuscript (q.v.). About the thirteenth century, in Italy and Spain, these manuscripts began to be produced with the initial letters stamped in ink from engraved blocks of wood. This practice was gradually developed until printing-blocks were quite commonly employed in printing images and text, generally of a religious character, on paper sheets which were bound together in book form. In short, the gradual development of printing in relief was as follows: (1) initial letters, autographs, and trade marks; (2) playing cards; (3) figured or ornamental textile fabrics; (4) religious pictures with and without lettering; (5) engraved words without pictures; (6) types of single letters founded in a mold.

Whether he was or was not the first to employ movable printing types, John Gutenberg (q.v.) is usually named as the inventor who first established typography on anything like a scientific basis. The claimant who seems to have the best right to contest with Gutenberg the invention of typography is Laurens Janszoon Coster (q.v.) of

Haarlem, Holland, who is said to have invented types of wood about 1428, and at a later date types of metal, with which he printed several small books. Coster's types are stated to have been stolen by one of his workmen and conveyed to Mainz, Germany, where this workman introduced typography. Among those for whom the honor of the invention is claimed are: Albrecht Pfister, of Bamberg, Germany; Pamphilo Castaldi, of Feltré, Italy; Johannes Mentel, of Strassburg, Germany; and Procopius Waldvogel, of Prague, whose claims are based on unreliable authority. None of the alleged inventors established the art or left worthy successors. It is to Gutenberg that we owe the practical establishment of typography. The facts in Gutenberg's career as a printer are meagre. There is an unsatisfactory record that he experimented with printing at Strassburg in 1439. In 1448 he had a printing office at Mainz; in 1455 he was sued by John Fust (q.v.), who was associated with him in the enterprise, for the recovery of money lent, and judgment being secured against him, Fust seized his printing house equipment. Another printing establishment was started by Gutenberg, who operated it until his death, about 1468, with his son-in-law, Peter Schöffer. Meanwhile Fust had continued the operation of the printing establishment founded by Gutenberg. Upon the sacking of Mainz by the Archbishop Adolf in 1462 the pupils and workmen of these printers were scattered and the art, which had been carefully guarded as a secret, became widely known. Printing was practiced in Rome in 1467; in Paris in 1469; in Spain in 1474; and in England in 1477, the first press in this last country being set up at Westminster Abbey by William Caxton (q.v.). The first press in the New World was established at the City of Mexico in 1540 and this was followed by one in Peru at Lima in 1584. The first press in the British colonies of North America was set up at Harvard College in 1638, and this press still continues under the name *University Press*.

In a brief review of the development of printing it is impossible more than to allude to the work of such famous printers as Aldus Manutius (q.v.), who, with other members of the same family, published the famous Aldine Editions (q.v.), the Elzevirs (q.v.), whose activities extended from 1583 to 1712, and the Stephens (q.v.) of Paris, famous for their editions of the Scriptures and the classics.

MODERN PRINTING TYPES. Types of metal are manufactured by a process of founding. (See **TYPE-FOUNDING**.) The earliest types used were of the style known as Gothic or black-letter, which was afterwards superseded, except in Germany, Russia and Greece, by the Roman letter. (See **BLACK-LETTER**.) Printers have a distinct name for each size of type, and use about 16 sizes in different descriptions of book-work; by the older terminology the smallest is called *brilliant*, the next *diamond*, and then follow in gradation upward, *pearl*, *agate*, *nonpareil*, *minion*, *brevier*, *bourgeois*, *long primer*, *small pica*, *pica*, *English*, *great primer*, and *double pica*. The larger sizes generally take their names thus—*two-line pica*, *two-line English*, *four*, *six*, *eight*, or *ten-line pica*, etc. Other nations designate many of these sizes by different names. Some of these names were given

from the first maker; others from the books first printed with the particular letter. Thus, *Cicero* is the name of a type in France and Germany, with which Cicero's letters were first printed (Rome, 1467); *pica* is from the service of the mass, termed *pica* or *pic*; *primer*, from *Primarius*, the book of prayers to the Virgin; *brevier*, from *breviary*; *canon*, from the *canons* of the Church, etc. The following illustrates the size of the various types named:

1—Brilliant,	International.
2—Diamond,	International.
3—Pearl,	International.
4—Agate or Ruby,	International.
5—Nonpareil,	International.
6—Minion,	International.
7—Brevier,	International.
8—Bourgeois,	International.
9—Long Primer,	International.
10—Small Pica,	International.
11—Pica,	International.
12—English,	International.
13—Great Primer,	International.

At present in Europe and America, generally, printers use a numerical nomenclature instead of the old nomenclature given above and commonly used by the layman. This nomenclature, as adopted by the United States Typefounders' Association in 1886, is as follows:

OLD NAME	Square of "body" in inches	New name
Excelsior.....	0.0415	<i>point</i> 3
.....	0.0484	3½
Brilliant.....	0.0553	4
Diamond.....	0.0622	4½
Pearl.....	0.0692	5
Agate.....	0.0761	5½
Nonpareil.....	0.0830	6
Minion.....	0.0968	7
Brevier.....	0.1107	8
Bourgeois.....	0.1245	9
Long Primer.....	0.1383	10
Small Pica.....	0.1522	11
Pica.....	0.1660	12

A complete assortment of types is called a *font*, which may be regulated to any extent. American founders assort characters by weight and not by count. As types of the same body vary in width (some thin and some wide), a specification by count of single types would be misleading as to weight. The following table shows the relative frequency of the letters in composition:

e.....	1,000	m.....	272
t.....	770	f.....	236
a.....	728	w.....	190
l.....	704	y.....	184
s.....	680	p.....	168
o.....	672	g.....	168
n.....	670	b.....	158
h.....	540	v.....	120
r.....	528	k.....	88
d.....	392	j.....	55
l.....	360	q.....	50
u.....	296	x.....	46
c.....	280	z.....	22

The types used in printing offices are sorted in different boxes of two shallow trays known as *upper* and *lower case*, the latter lying nearest the compositor upon the frame for their support. The lower case is placed

immediately under his hand, the upper case directly above in a slanting position, and the under part of the frame is stocked with cases of different fonts. In the upper case are placed all the capitals, small capitals, and a few of the characters used as references to notes. In the lower case are all the small letters, figures, most of the points, and the spaces for blanks between the words. In the lower, alphabetical arrangement is not preserved; each letter has a larger or a smaller box allotted to it, according as it is more or less frequently required; the letters in most request are placed at the nearest convenient distance to the compositor. See article CASE for illustration.

TYPE-SETTING OR COMPOSING. The setting of printing types in proper order for printing is termed composing, and may be performed either by hand or by machine. (For machine composition, see TYPE-SETTING MACHINES.) In hand composition, the compositor places the copy before him on the upper case, and standing in front holds in his left hand a short tray of iron, known as a composing-stick. The stick has a movable slide, which may be regulated to any width of line. One by one the compositor picks up and puts together the letters of each word and sentence, and the appropriate points, into his stick, securing each with the thumb of his left hand, and placing them side by side from left to right along the line. When he arrives at the end of his line, the compositor must separate the words, so that they will fill the width of the measure. Spaces of varying thickness are inserted as evenly as possible between the words. When the compositor has set up as many lines as his composing-stick will hold conveniently, they are lifted by grasping them with the fingers of each hand, as if they were a solid piece of metal. He then places the mass upon a shallow tray termed a galley, which has a ledge on two or three sides.

The printer's unit of measurement by which the compositor is paid is the *em* in America and the *en* in Great Britain. An *em* is the square of the body of the type selected; the number of *ems* that fill a line, multiplied by the number of lines in a page gives the total number of *ems* of type in the page. The piece compositor is paid an agreed rate per 1000 *ems*, but the rate varies with different kinds of composition. Tabular matter, mathematical formulas, etc., are usually paid for on a time basis.

Composed type that has served the purpose for which it was set is known as *dead* matter, and its separate letters have to be distributed into the case for re-use, in new work. The compositor first wets the composition so that the separate types will slightly cling together. He then places a number of lines upon his composing rule, picks up a few types between thumb and forefinger, and drops them one at a time, into their proper compartments in the case.

MAKE-UP is done by taking composed type from the galley in sufficient quantity to make a page of prescribed size. It is then tied up so that it can be safely handled and is put upon an imposing-stone or iron-topped table. When the page consists of several columns, as in newspapers, the type of one column is placed after another, upon the stone. The pages are separated by suitable blanks, and the whole mass of type is 'locked up' by filling the angular space around the type and inside the iron frame with strips

of wood or metal and by wedging them with screw clamps or quoins, so tightly that none of the type can fall out. Proofs are taken from the type in galley and in page form, which are read for errors, so that corrections may be made before the type is sent to press. At least two proofs of the type—a galley proof and a page proof—are always taken and read for errors, and very often in careful work several proofs of each kind are 'pulled' and read by different persons. See **PROOF-READING**.

The printer's *form* may consist of any number of pages from 2 to 128. 'Imposition' is a method of arranging pages so that they will follow one another upon the printed paper in the proper consecutive order. The method of imposition or the order of arrangement differs according to the number of pages in the form, but the general principle of the process may be understood from the following diagram of a 16-page form, in which the numeral in each case indicates the number of the page in that form and its location

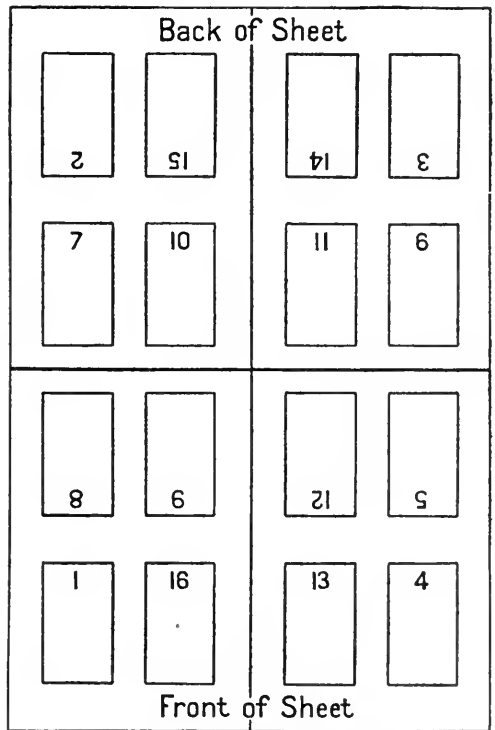

the top of the page. To guide the binder in arranging the printed sheets in their proper order, letters or numerals known as signatures are placed at the foot of the first page of each section. The letters J, V, and W are not used for this purpose.

STEREOTYPING is a process by which the composed types of a page are founded in one piece. The object is to preserve composition so that it cannot be distributed, to cheapen cost, and save wear of type. Many methods have been invented, but two only are now in use: stereotyping by the papier-maché process, and electrotyping. The papier-maché process is preferred for its speed by daily newspapers; electrotyping by book printers for its greater accuracy, and its applicability

to fine engravings in relief. Crude experiments at soldering composed types together and at making duplicates by the pressure of pages on type metal softened by heat were made in the eighteenth century, but the first practical work was done by William Ged, a goldsmith, of Edinburgh, in 1725. His invention was not kindly received by the printers and publishers of England, and soon fell into disuse, but it was revived and improved by Earl Stanhope of London, about the year 1802. For nearly fifty years afterwards it was preferred for book work, and was generally known as the plaster process. The page of type to be stereotyped was put in an iron pan and a preparation of plaster of Paris poured over it, which was afterwards baked dry in an oven. The dried mold so made was then submerged in melted type metal that penetrated every crevice. When properly cooled, the mold was broken, and a duplicate of the composed type appeared on one side of the plate. The rough side of the plate was planed down, its edges were beveled, and faulty letters corrected, until it became a presentable duplicate of the type work. Stereotyping by plaster was brought to Newark by David Bruce in 1813. Stereotypes have also been made by pressing the types upon prepared dampened china clay, but the clay process is rarely used. The papier-maché process, invented by Genoux, of France, in 1829, was neglected for many years, but is now in favor with all daily newspapers. Sheets of thin tissue paper, pasted together and backed with damp unsized thicker paper, constitute the mold or matrix for the papier-maché process. They are firmly and evenly impressed on the page of type, which may be flat or curved, and are then dried upon the page. When dry the matrix is removed, and adjusted to an iron mold on which melted type metal is poured from several openings. The plate so made is then cooled, planed, and beveled to fit the press. All the operations, aided by machinery, are made with great speed. Ten minutes is the ordinary time.

ELECTROTYPING. For fine book work and for duplicating engraved illustrations, electrotyping is the process preferred. By this process the type page is impressed in a thin sheet of wax which is first dusted with a coating of powdered graphite and then with a coating of iron filings. The wax mold so prepared is immersed in a bath containing a solution of sulphate of copper through which passes an electric current from a dynamo. This deposits a thin film of copper on the wax mold. (See **ELECTRO-CHEMISTRY, INDUSTRIAL APPLICATION OF.**) When thick enough to be stable the film or shell of copper is backed with a solder of tin, and afterwards with a firmer basis of type metal, applied in a melted state. This type metal base is then planed and beveled, so that it can be neatly fitted to a thicker base of hard wood that makes it type-high. Electrotypes plates may be curved by passing them through shapers or suitable bending rolls. Electrotypes plates for printing were made by Joseph A. Adams, a wood engraver of New York City, in 1839-41, but they did not supplement stereotype before 1850.

INKING ROLLERS. Printing ink is a trituration (not a chemical union) of boiled oil, smoke black, coloring matter, and other ingredients. By the old process for inking types, stuffed leather balls were made use of, but they were difficult to keep in proper order, and were inapplicable to

cylinder printing. The first improvement on the stuffed balls consisted in covering them with the elastic composition of glue and treacle then employed in the Staffordshire potteries. Catching at this idea, the inventors of cylinder printing machines made inking rollers by casting them in a cylindrical mold. This invention came generally into use between 1814 and 1818, everywhere superseding balls, and rendering printing machinery practicable. Inking rollers for type work, now made of a mixture of glue, glucose, sugar, and glycerin, are found more durable than those made from glue and molasses only. The quantities of each constituent must be varied to suit the speed of the machine, the nature of the presswork, and the temperature of the press-room.

PRINTING PRESSES. The earliest engraving of a printing press shows a stout framework of wood posts, firmly braced against the ceiling to resist upward pressure, a bed plate of stone as a rest for the form of type, which could be exposed to receive ink, and then be slid upon ways under the platen or pressing surface. Impression was given by a large screw of wood over this platen and this screw was moved by a long bar of wood and iron. The sheet of paper to be printed (about 16×20 inches was a common size) was laid upon an inclined framework of wood covered with blanket or parchment, which was hinged to slide on the ways and to be placed under the platen. This platen impressed only one-half of one side of the paper; to print the sheet 16×20 on both sides the pressman had to give four pulls on the bar. To print with uniform margin and in accurate register, the sheet on its

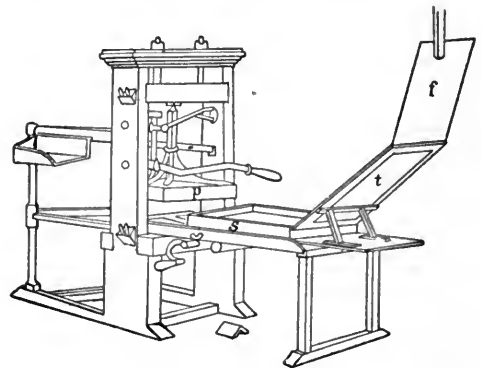

OLD COMMON PRESS.

p, platen; *s*, sole or bed; *t*, tympan; *f*, frisket.

first impression was pierced with small perforations on the front side, and afterwards suspended from holes so made on properly placed points when the second side was printed. Although the mechanism of the press was rude and even petty, good printing was done upon it by a competent pressman. The first improvement in construction was made by Blaew, of Amsterdam, in 1601, who in addition to other devices attached springs to the platen moved by the screw, so that it could have a quick return movement without special exertion from the pressman. In 1786 M. Pierres, of Paris, invented a printing press entirely of iron, and strong enough to print one side of the sheet by one pull of the bar, but it did not meet with favor. About 1804, Earl Stanhope, of Lon-

PRINTING

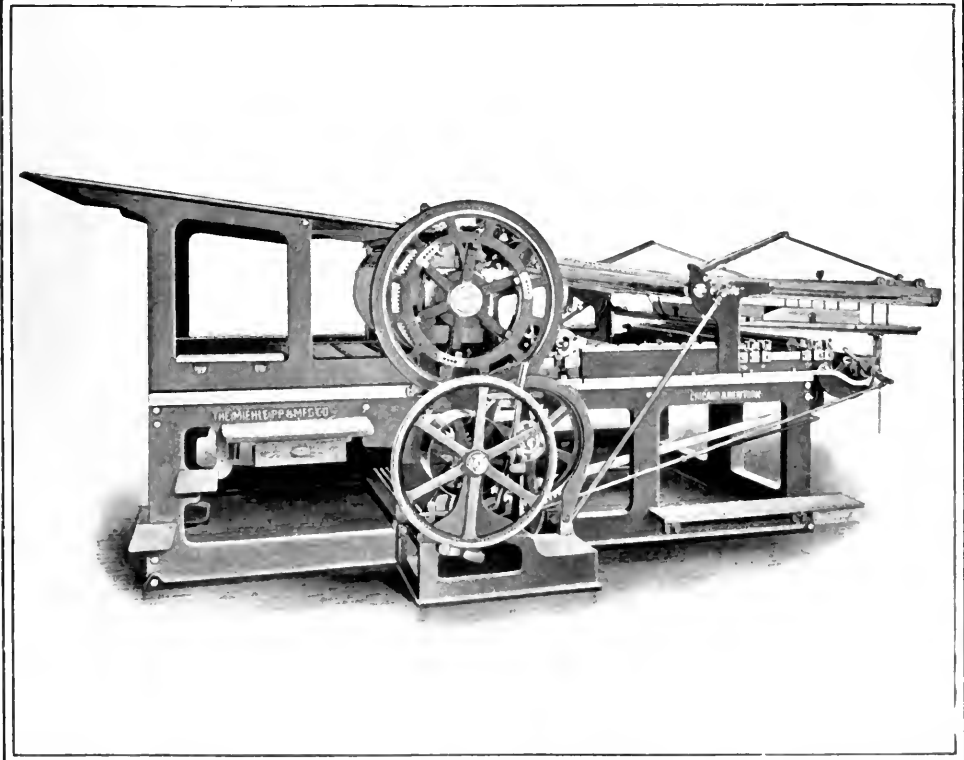
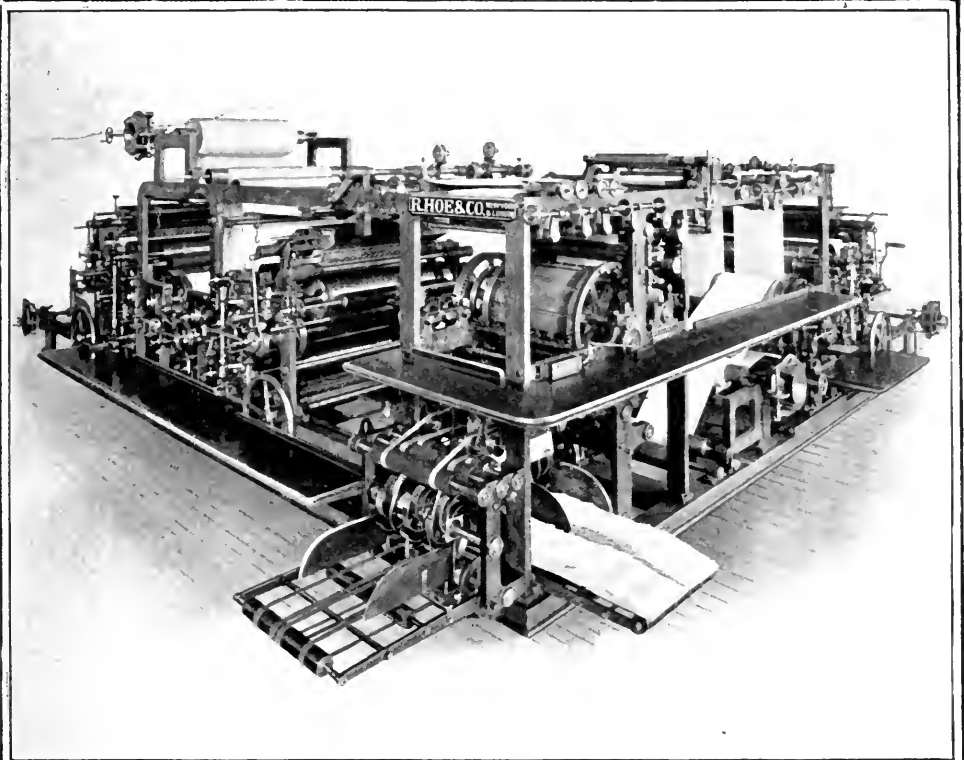

1. HOE ROTARY PERFECTING PERIODICAL AND BOOK PRESS.
2. MIEHLE TWO-REVOLUTION CYLINDER BOOK AND MAGAZINE PRESS.

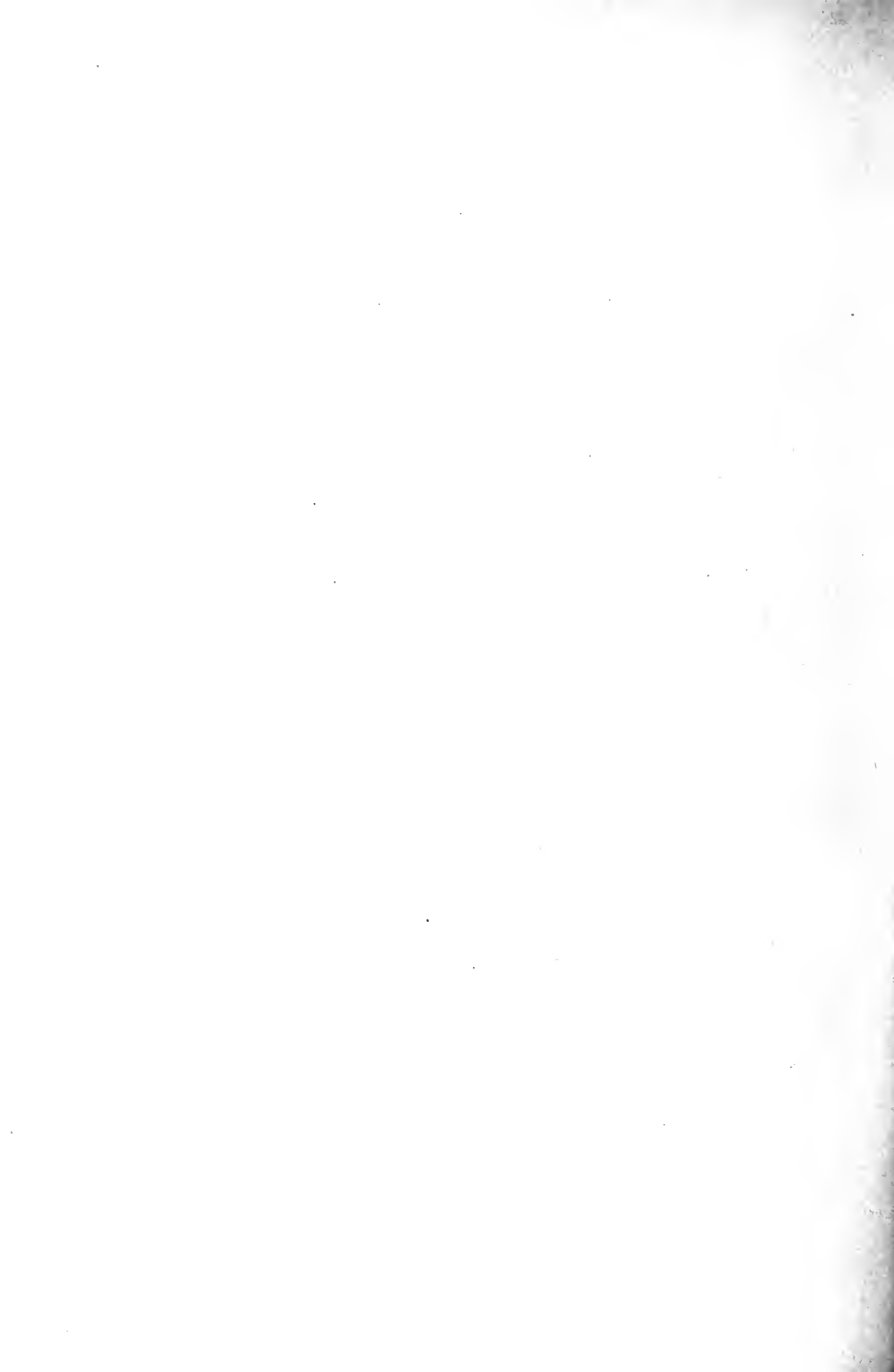

don, made great improvements on the large iron press of Pierres, adding many clever devices of his own for the lightening of labor. In 1806 Koenig, of Saxony, went to London with the model of an improved platen press, which he failed to introduce. His associates were more successful in reviving a patent issued to William Nicholson, of London, in 1790 for printing on a flat surface

son were rejected after fair trial by all book-printers. The old publishing house of Harper & Brothers used hand presses only in 1835, but soon after introduced the Adams power press. A prominent firm of law-book publishers in New York had all their work done on hand presses as late as 1849. The preference for hand-press work has been more marked in Great Britain. The fine books of Pickering and Whittingham and more

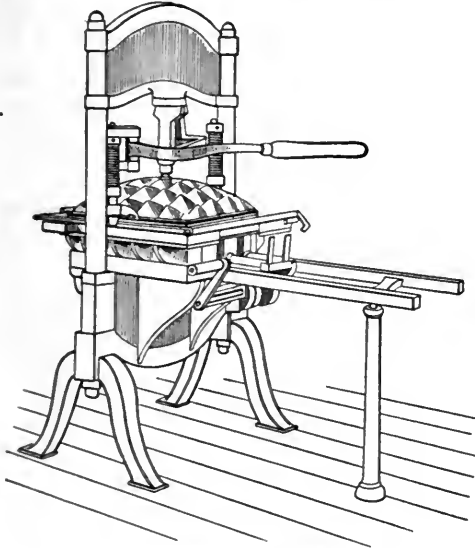

WASHINGTON HAND PRESS.

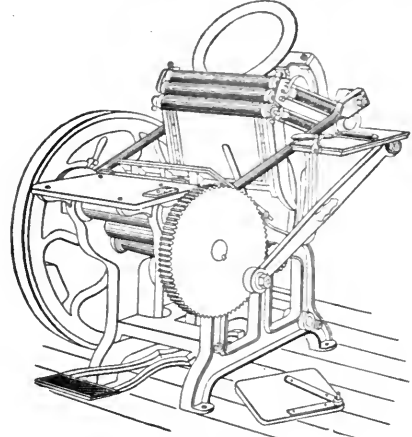

GORDON PRESS.

with cylindrical pressure. The new method was fairly tested upon a book form in 1811 and the new machine began to do the regular edition of the *London Times* in 1814. Soon after this all 30 daily newspapers had cylinder presses, for their greater speed and economy were advantages not to be neglected, but book work of all kinds continued to be done on platen presses of new construction. The Columbian Press, invented by

recently those of William Morris and his disciples were printed on a hand press. The hand press was found too slow and the cylinder press too cumbersome and costly for the small forms of commercial printing required before 1850. To supply this demand many small and inexpensive platen printing presses were devised for cards and circulars. In 1840 S. P. Ruggles, of Boston, invented a platen machine that printed a sheet of letter size at the speed of 1000 an hour, power being furnished by the foot of the pressman moving a treadle and attached crank. In 1850 George P. Gordon, of New York, patented a form of

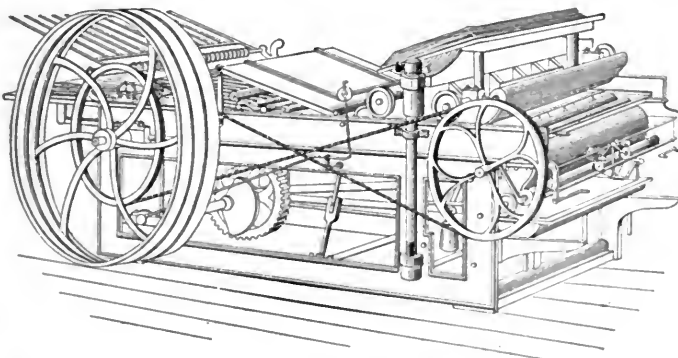

ADAMS BED AND PLATEN PRESS.

George Clymer, of Philadelphia (1816); the Adams Power Press, made in 1830, by Isaac Adams, of Boston; the Washington Press, of Rust, of New York, in 1827, were for many years the favorites. The last two mentioned are yet in daily use in many printing houses of the United States. Cylinder printing machines, the first made, although indispensable to early newspapers, were damaging to type, and for that rea-

son still in use for small job work; (2) the two-revolution cylinder, that rotates at greater speed, and gives impression at every other rotation, is much used for book work; (3) the stop-cylinder, that stops its rotation after each impression, has been preferred for its accurate register and superior printing of engraved illustrations; (4) the double cylinder, that produces two prints from the same form

on each reciprocating movement of the bed, still finds some favor for newspapers of small editions: (5) the perfecting cylinder, that prints both sides of the sheet at the same operation. Other constructions, some of value, could be named, but those here specified are in most favor. The perfecting cylinder last mentioned is the only construction of flat-bed press that attempts to print both sides at once, but its movement is relatively slow. The high speed required by daily newspapers can be had only by the full use of the rotary principle for the pressed and the pressing surfaces. In 1835 Rowland Hill, of England, devised a press on this plan purposed to print upon an endless roll of paper, but his scheme was never put to practical use. In 1850 Thomas Nelson, of Edinburgh, exhibited at the World's Fair a little cylinder which did print a handbill on both sides at great speed from this endless roll. It was not favorably regarded as a practicable apparatus. In 1685 William Bullock, of New York, constructed a rotary press, which printed from an endless roll, 10,000 copies in an hour. R. Hoe & Co., of New York, had produced in 1847 a type-revolving printing machine.

is fed from three rolls of paper and can print, cut, paste, fold, and count 24,000 papers of 14, 20, or 24 pages each, 36,000 papers of 16 pages each, 48,000 of 10 or 12 pages each, and 72,000 of 8 pages each during every hour of its daily operation. In 1900 three octuple presses were installed for the *New York Journal*. Each press weighs, when in running order, about 200,000 pounds, and has 11 pairs of printing cylinders, 40 ink-distributing cylinders, 100 composition rollers, 22 ink fountains, 5 sets of oil fountains, and 850 gear wheels.

These presses are operated by electricity, and are 35 feet long, 10 feet wide, and 15 feet high. An 80 horse-power electric motor is required to start one of them from a state of rest until it attains its proper speed, after which it performs its work at a considerably less expense of power.

In these machines five-cylinder color presses are combined with a full black press, which also has extra facilities for turning out fine newspaper work from electrotype plates; consequently half-tone plates and colored illustrations can be printed in connection with the text.

In 1903 a press of still greater dimensions was

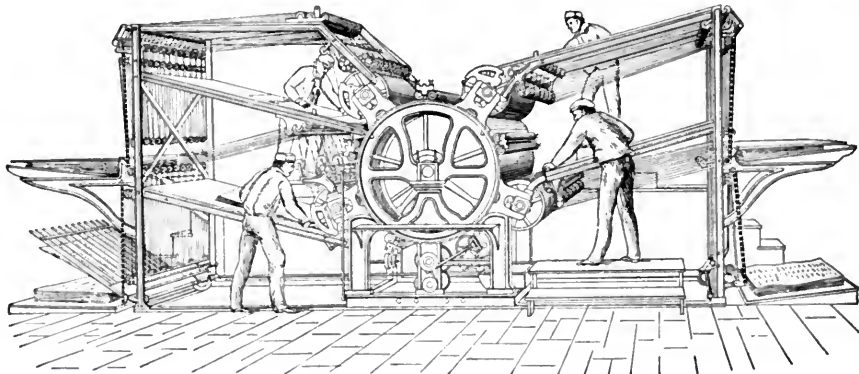

HOE FOUR-CYLINDER ROTARY TYPE-REVOLVING PRESS.

In this construction a large central cylinder contained the form of type on a small portion of its circumference, the rest of that circumference being used for the movement of inking rollers. The types were held in place by grooved and rebated column rules and screw clamps. Around this large cylinder were placed at graduated distances 4, 6, 8, or 10 impression cylinders, for each of which separate piles of paper and separate feeders had to be provided. Every revolution of the central cylinder produced from four to ten copies, but these copies were printed on one side only, and this defect limited its value as a newspaper machine. In 1871 R. Hoe & Co. invented a rotary press, which printed on both sides, from curved stereotype plates at the rate of 12,000 an hour. This machine, a favorite at the start, has been reconstructed on new lines with many improvements for the different requirements of eight-page or forty-eight-page newspapers. Two or more distinct machines are geared together in one construction and are known as the quadruple, sextuple, and octuple machines.

A sextuple press built for the *New York Herald* in 1889 is composed of about 16,000 pieces and weighs 116,000 pounds. This press

constructed by R. Hoe & Co., which uses when running at full capacity, eight rolls of paper, each four newspaper pages wide. This machine requires 125-horse power to drive it, and when running at its full capacity consumes in an hour about 70 miles of paper, the width of the roll, or 280 miles of paper of the width of the newspaper page. In addition to the eight rolls of paper already mentioned eight other rolls are in position, so that when any of the rolls run out the roll-carrier may be turned on a turntable, and the new roll of paper quickly pasted to the end of the depleted roll. The running speed of this press is 96,000 papers an hour, four, six, eight, ten, twelve, fourteen or sixteen pages, or 48,000 eighteen, twenty, twenty-two, twenty-four, twenty-six, twenty-eight, thirty, or thirty-two page papers, all delivered, folded to half-page size, pasted, and counted. Other rotary presses of merit are made in this country, and in France and Germany, but they contain no distinctive principle that calls for minute description.

TYPE-SETTING MACHINES. The output of newspaper presses would have been much smaller if type-setting machines had not furnished composed type at greater speed and lower cost. In

PRINTING

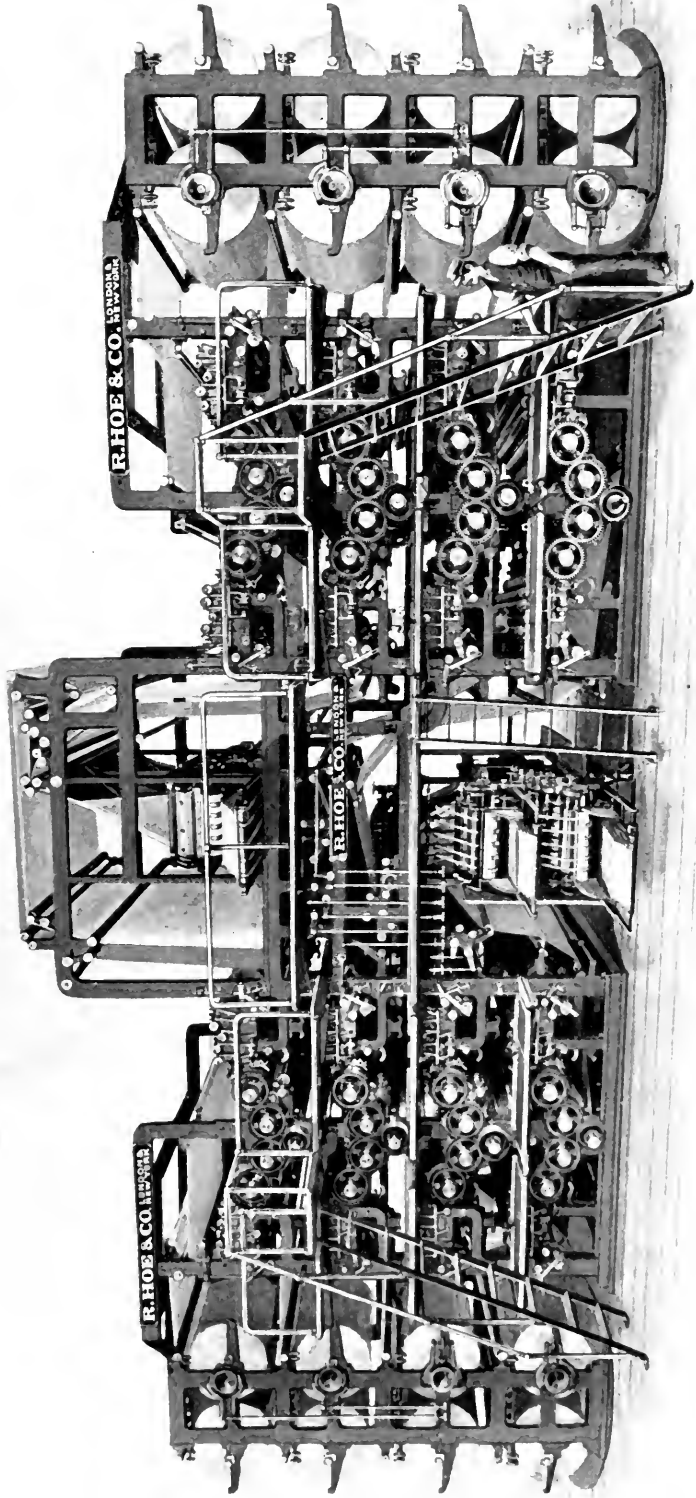

HOE DOUBLE OCTUPLE NEWSPAPER PRESS—1903 MODEL

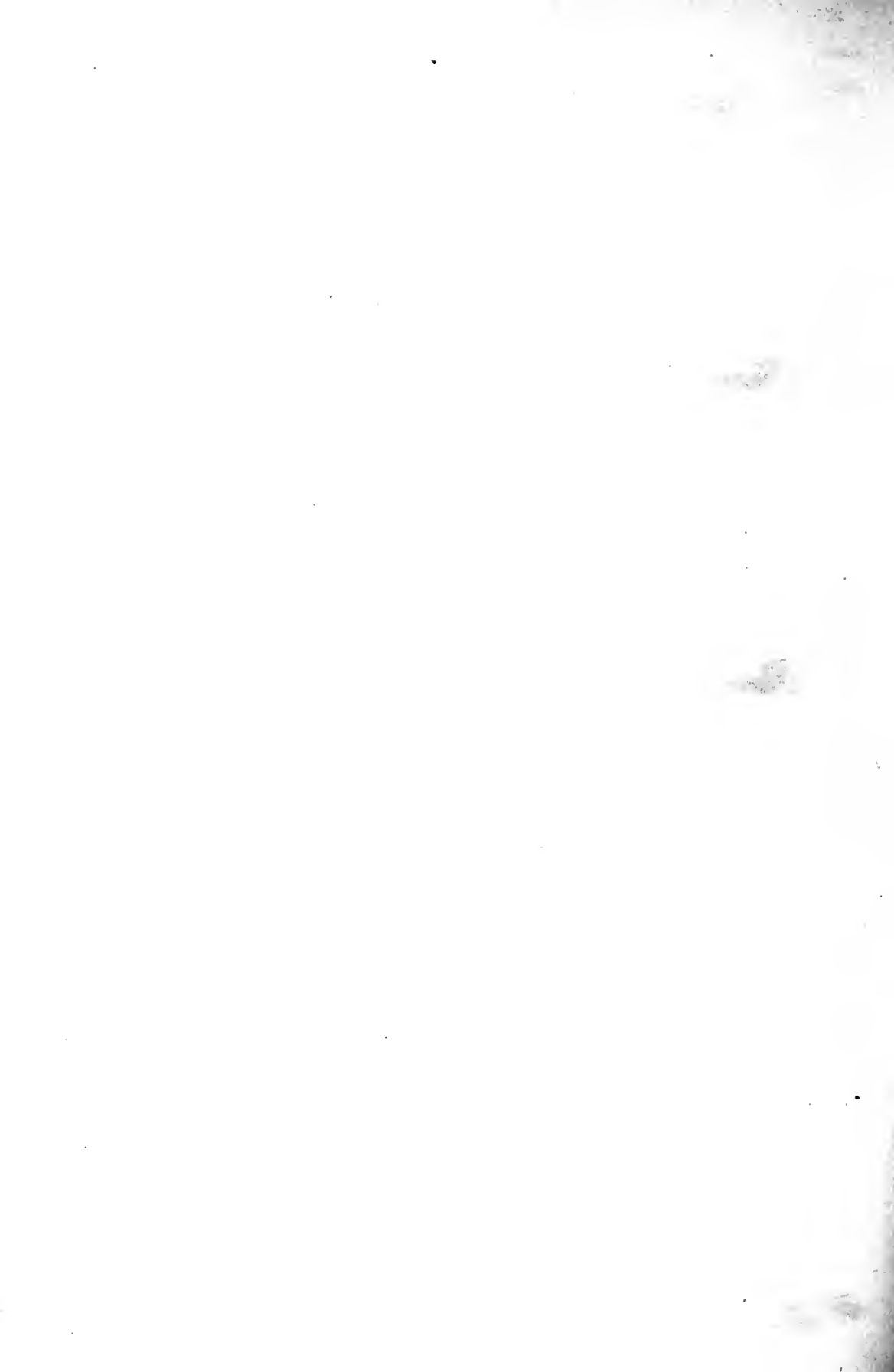

1821 William Church, of Connecticut (but then a resident of London), proposed a method for casting and setting type by one operation with great rapidity, but the machine for this purpose was never put to practical work. In 1853 William Mitchell invented a type-setting machine that was used for many years in the printing house of John F. Trow, of New York, but it was not generally approved. Other machines succeeded, and many had merit. The Mergenthaler or linotype, a complex mechanism that casts composed types in solid lines, is the approved machine for daily newspapers, and is used to some extent for book composition. The Lanston machine by different apparatus casts and composes isolated types with nearly equal speed. Either machine, in the hands of a skilled operator, can produce as much composed type in one hour as was done in a day by the hand compositor. See TYPE-SETTING MACHINES.

PAPER. Improvements in paper-making have been great aids in the development of printing. In 1827 the Fourdrinier paper machine, that produced paper in the so-called endless roll needed for rapid newspaper printing, was introduced in the United States. It made paper of more uniform thickness, of larger size, and at lower price. Cotton rags were used until the supply diminished. In 1860 Henry Voeltner invented a method for grinding soft woods for conversion into paper pulp. His method has been improved by chipping the wood and treating it with suitable chemical agents, which have largely reduced its cost. Book papers that sold for 16 cents in 1850 are now sold for 5 cents or less, but the quality is not so good. See PAPER.

The methods of book and news presswork have been seriously changed. Before 1870 the rough paper then in use had to be dampened before it was thought fit for press, and type work was impressed upon it against a thick woolen or rubber blanket, which produced thick and strong print. This elastic impression was fatal to engravings with close and shallow lines which were choked with ink, to the damage of proper light and shade. Then paper-makers began to provide paper with a smoother surface, and printers undertook to print this paper in its dry state. Soon after, the newly discovered art of photo-engraving, which became common in books and magazines, compelled the making of still smoother paper. To supply this demand, a thin fabric of paper was coated with whitening, which, after proper smoothing or calendering, had a surface as smooth as polished metal. To print photo-engravings on this paper the elastic impression resistance had to be abandoned, and an inelastic resistance of hard cardboard substituted. Under this treatment the delicacy of fine lines in an illustration could be properly preserved; the inelastic resistance improved the appearance of the illustration, but it did not improve the readability of the type work, and it did add to the cost of presswork.

The increasing circulation of magazines that were filled with illustrations compelled the abandonment of the flat-bed cylinder press about 1884. The rotary principle then and now employed in newspaper work had to be adopted, but with finer mechanism nicely adjusted. In 1886 R. Hoe & Co. made for the printing of the *Century Magazine* a rotary press that took on 64 large octavo pages and printed them in a

satisfactory manner and with a speed not possible by any form of flat-bed cylinder.

BIBLIOGRAPHY. The bibliography of printing is very voluminous, and only a few of the principal books treating of the art can be named here: Han-sard, *Typographia* (London, 1825); De Vinne, *The Invention of Printing* (New York, 1878); id., *Historic Printing Types* (ib., 1886); id., *Plain Types* (ib., 1900); id., *Correct Composition* (ib., 1901); Faulman, *Geschichte der Buchdruckerkunst* (Vienna, 1882); Ringwaldt, *Encyclopædia of Printing* (Philadelphia, 1871); Thomas, *History of Printing in America* (Worcester, Mass., 1810, and Albany, N. Y., 1874); Hoe, *A Short History of the Printing Press* (New York, 1902); Bigmore and Wyman, *Bibliography of Printing* (London, 1880-86); *Dictionary of Printing and Bookmaking* (New York, 1891-94); Waldow, *Illustrirte Encyclopædie der graphischen Künste* (Leipzig, 1880-84).

PRINTING-HOUSE SQUARE. (1) A London court, so called from the former office of the King's Printer, which occupied the site. On it stands the office of the *Times*. (2) The open square fronting on City Hall Park, New York, about which are grouped the buildings of most of the daily newspapers.

PRINTZ, JOHAN (c.1600-63). A Governor of New Sweden. He was born in Bottneryd, Sweden, about the year 1600. He served as a cavalry officer in the Thirty Years' War, and for having surrendered the Saxon town of Chemnitz was dismissed from the service, but in 1641 was restored to royal favor, was ennobled, and was appointed Governor of New Sweden. He reached Fort Christina in 1643, and desiring to control the trade of the river and be as close as possible to the Dutch at Fort Masson, he established a settlement on the island of Tinicum, a few miles below the site of Philadelphia, and built a fort and also a mansion called 'Printz Hall.' His administration was a vigorous one, and during it the colony increased in numbers and in prosperity. He caused other forts to be built at various places for the protection of the colony, carried on a large trade with the Indians, and successfully maintained himself against the English and the Dutch. He quitted the colony in 1653, and two years later it was conquered by the Dutch under Stuyvesant. When Printz reached Sweden he was made a general, and a few years later became Governor of Jönköping. Consult: Winsor, *Narrative and Critical History of America* (8 vols., Boston and New York, 1889); and Brodhead, *History of the State of New York* (2 vols., New York, 1853-71).

PRIOR. See MONASTERY.

PRIOR, MATTHEW (1664-1721). An English poet and diplomatist, born July 21, 1664, probably in Wimborne, Dorsetshire, where his father was a joiner. The family moved to London, and the young Prior was placed in Westminster School, where he formed a life-long friendship with Charles Montagu, afterwards Earl of Halifax. He graduated B.A. from Saint John's College, Cambridge (1686), and was elected fellow (1688); through the influence of the Earl of Dorset he was made secretary to Lord Dursley, Ambassador to The Hague, where he remained several years, enjoying the friendship of King William III.; secretary in the negotiations at

the Treaty of Ryswick (1697); secretary to the Embassy at Paris (1698); secretary to the Board of Trade (1699); sat in Parliament (1701); and soon after forsook the Whigs for the Tories. He had a hand in the negotiations preliminary to the Peace of Utrecht, and was for a short period Ambassador at Paris; on the advent of the Whigs to power he was impeached and imprisoned for two years (1715-17). His last years were passed at Down-Hall, in Essex. He died September 18, 1721, and was buried in Westminster Abbey.

Prior gained recognition among the wits by *The Country-Mouse and the City-Mouse* (1687), written in conjunction with Charles Montagu. It is a readable travesty on Dryden's *Hind and Panther*. In 1700 he published a panegyric on King William, called *Carmen Seculare*. While in prison he amused himself with a long whimsical poem, entitled *Alma; or the Progress of the Mind*. A collection of his poems appeared in 1709, and another in 1718; the latter brought him four thousand guineas. Prior's short poems, comprising odes, epistles, and epigrams, are among the choicest specimens of English occasional verse. We may cite "To a Child of Quality Four Years Old," "The Merchant," "A Better Answer," "A Song," "To a Lady," and "For My Own Tomb-Stone." His verse tales have perfect grace. Consult the *Selected Poems*, ed. by Dobson, Parcliment Library (London, 1889); and the edition by Johnson in the Aldine series (London, 1892); and Thackeray's *English Humorists* (London, 1853).

PRIPET, prĕp'ĕt (Russian *Pripyat*). A river of Western Russia, the largest right tributary of the Dnieper. It rises in a group of lakes and marshes in the Government of Volhynia, near the boundary of Poland, and flows eastward through Volhynia and Minsk, then southeast into the Government of Kiev, where it joins the Dnieper some distance above the town of Kiev (Map: Russia, C 4). For the greater part of its course of 500 miles it flows through immense marshes and forests, which are almost uninhabited, and through which the river and its branches form a network of side channels and backwaters. The Pripet is navigable to Pinsk, and is connected by canals with the Vistula and the Niemen.

PRISCIAN, prĭsh'an (Lat. *Priscianus Cæsariensis*). A Latin grammarian, perhaps, in point of reputation, the first of Latin grammarians, though one of the last in point of time. He belongs probably to about the early part of the sixth century, for he is mentioned by Paulus Diaconus as a contemporary of Cassiodorus. He taught Latin at Constantinople, probably at the Imperial Court, for he enjoyed a Government salary. The work which has mainly preserved his name is his *Commentariorum Grammaticorum Libri XVIII.*, dedicated to his patron, the Consul Julianus. The first sixteen books treat of the different parts of speech as conceived by the ancients; the remaining two are devoted to syntax, and in one manuscript bear the separate title of *De Constructione Libri Duo*. Priscian's Commentary is, for the time, a solid and comprehensive work, the production of a man of great learning and good sense, and is enriched with quotations from many Greek and Latin authors no longer extant. The epitome executed by the German

bishop, Rabanus Maurus, in the ninth century, was very popular in the Middle Ages. Besides the Commentary, Priscian wrote six smaller grammatical treatises, and two didactic poems in hexameter, *De Laude Imperatoris Anastasii*, and a free translation of the *Periegesis* of Dionysius. The first edition of the grammar appeared at Venice (1470); the best is that by H. Keil (Leipzig, 1884). The two poems will be found in vol. v. of Baehrens's *Poetæ Latini Minores* (Leipzig, 1883).

PRISCILLA and **AQUILA**. The names of two persons, wife and husband, connected with the personal work of Saint Paul and the early history of the Christian Church. The name Priscilla is a diminutive from the original Prisca, in which form it is found in the best texts in the three references to her in Saint Paul's Epistles. Her husband, Aquila, is described in Acts xviii. 2 as "a man of Pontus by race, lately come [to Corinth] from Italy, with his wife Priscilla, because Claudius had commanded all the Jews to depart from Rome." This decree was promulgated in A.D. 52. Like Paul, they were tent-makers by trade (Acts xviii. 3). It seems very probable that Aquila and Priscilla had accepted the Christian faith before leaving Rome; if so they were among the earliest believers there, and may have given Paul his information concerning the conditions obtaining among the Roman Christians (Rom. xvi. 17-19). They remained with Paul eighteen months after reaching Corinth, went thence with him to Ephesus, and tarried there while he went on to Jerusalem (Acts xviii. 11, 18, 19, 20). From there they returned later to Rome (Rom. xvi. 3). Still later they were at Ephesus again (II. Tim. iv. 19). These changes are quite consistent with the shifting character of Jewish life at the time, and with their function as missionaries of the new faith. They were regarded most affectionately by Saint Paul, who reckoned their service as hazardous and precious. There are no reliable sources of information concerning the close of their lives. The name of Priscilla (Prisca) figures quite largely in later tradition. There is a church in Rome bearing her name; a volume of *Acts of Saint Prisca* goes back at least to the tenth century; and one of the oldest catacombs in Rome is called *Cæmeterium Priscille*. The reason why the wife's name is placed first in so many cases has not yet been fully cleared up. The names of these two early Christians have recently become more prominent through the interesting hypothesis, put forward by Prof. Adolf Harnack of Berlin, in 1900, that the authors of the Epistle to the Hebrews were Aquila and Priscilla. Consult Sanday-Headlam, *Epistle to the Romans (International Critical Commentary, New York, 1899)*.

PRISCILLA. The heroine of Longfellow's *Courtship of Miles Standish*, wooed by John Alden for his friend Standish, but won for himself.

PRISCILLIAN (Lat. *Priscillianus*) (?-385). A Spanish Christian of prominence, who, while still a layman, started a reform movement with the view of deepening religious life and encouraging asceticism. He afterwards entered holy orders and was made Bishop of Avila, in Central Spain. His theology diverged from orthodoxy at some points, and in the end he was

charged with holding Gnostic, Manichean, and other heresies, although he himself disavowed the opinions of Manes. He seems, however, to have held peculiar views respecting the influence of the heavenly bodies upon men. He believed that the Church still possessed the gift of prophecy, and he gathered his followers into private assemblies, which lent color to the charge of sectarianism, later brought against him. A council at Saragossa (380) reproved the ascetic and separatist tendencies of the day, although without mentioning Priscillian by name, and a controversy ensued. His views were soon carried over into the Gallic Church, and within eight or ten years of its first appearance the party included several bishops and a large number of the clergy. In the course of the controversy Priscillian appealed to Pope Damasus (c.382), and further appeals to the Emperor were made by both parties. After Priscillian had protested against the jurisdiction of a synod convened at Bordeaux (384), he was tried before a civil tribunal, condemned for sorcery, and put to death, along with six others, by the Emperor's command. The Priscillianists continued for some time longer in a state of schism, and are found even as late as the sixth century. The literary remains of Priscillian are published in the *Corpus Scriptorum Ecclesiasticorum Latinorum*, vol. xviii. (Vienna, 1889).

PRISHTINA, prěsh'tě-nà. A town of European Turkey. See PRISTINA.

PRISM (Lat. *prisma*, from Gk. *πρισμα*, *prism*, something sawed, from *πριω*, *pricin*, *πριω*, *prizein*, to saw). A polyhedron (q.v.) two of whose faces (the bases) are equal polygons and whose lateral faces are parallelograms. When the lateral edges are perpendicular to its bases, the prism is called a *right prism*, otherwise *oblique*. A *regular prism* is a right prism whose bases are regular polygons. A prism whose bases are parallelograms is called a *parallelepiped* (q.v.). The volume of any prism equals the product of the base and the altitude. Consult Holzmüller, *Elemente der Stereometrie* (Leipzig, 1902).

PRISM, DISPERSIVE EFFECT OF. See LIGHT; DISPERSION.

PRISMATOID (from Gk. *πρισμα*, *prisma*, prism + *ειδος*, *eidōs*, form). A polyhedron (q.v.) which has for bases any two polygons in parallel planes, and for lateral faces triangles or trapezoids which have one side in common with one base, and the opposite vertex or side in common with the other base. Consult Holzmüller, *Elemente der Stereometrie* (Leipzig, 1902).

PRISON ASSOCIATION OF THE UNITED STATES, NATIONAL. An organization of prominent philanthropists interested in the subject of prison discipline reform, founded in Cincinnati, Ohio, in 1870, under the presidency of Governor Rutherford B. Hayes. The association was incorporated in New York State in April, 1871, the charter being granted to Governor Horatio Seymour (then and until his death president of the association) and twenty-four associate members. The management is in the hands of a board of directors, from which an executive committee of seven members is chosen annually, which discharges the active duties of the board

between the annual meetings. The other standing committees are on criminal law reform, police, prison discipline, discharged prisoners, juvenile delinquency. There is also a volunteer committee of correspondence for reform and aid of discharged prisoners in the various States.

PRISON BREACH, or PRISON BREAKING. The act by which a person escapes by force and violence from a place where he is confined in lawful custody. The act is a misdemeanor, and to constitute it there must be a lawful commitment, an actual breaking of the prison by force and violence by the prisoner or by others in his behalf and by his procurement, and he must fully escape, although, of course, subsequent recapture does not affect his act of breach. Similar escape by the violence of others without his procurement is a *rescue*. Consult the authorities referred to under CRIMINAL LAW.

PRISONER. Any person who is confined, or restrained in his liberty, against his will; a person subjected to imprisonment. The term is ordinarily used to designate persons whose bodies have been attached or seized in criminal or quasi-criminal proceedings and persons who are captured in war. For further information as to prisoners in the general and ordinary legal usage, see such titles as IMPRISONMENT; FALSE IMPRISONMENT; ESCAPE; PRISON BREACH; ATTACHMENT; BAIL; RECOGNIZANCE, etc. The rights of prisoners of war have changed greatly for the better within comparatively recent historical times. Among the Greeks and Romans, and for many centuries before and since, prisoners of war were the property of those by whom they were captured, and might be slain, kept as slaves, or sold at the caprice of their captors. This is still the case among savage races and among some of the semi-civilized races of the Orient. A mind picture of the treatment accorded to prisoners of war in early antiquity among all the races of the East is given by the accounts of the Jewish victories in the Old Testament. The custom of ransoming, and later when mercenaries and professional soldiers were largely used mitigated the hardships of the prisoners. The modern humane doctrine as to the rights of prisoners of war is laid down in the rules made by the Brussels Conference in 1874, which have been generally accepted. Under these a prisoner of war is a lawful combatant captured in war, and such non-combatants, as guides, balloonists, telegraph operators, and others who are identified with the army and rendering it direct service, and important public officials. Surgeons and chaplains, and, now, the hospital attendants of the Red Cross Society are exempt as such from being prisoners of war. A prisoner of war has no protection from the laws of the State and civil remedy; but he is protected by the rules of war against unlawful acts against his person. For further information consult such titles as WAR, LAWS AND USAGES OF; RANSOM; BRUSSELS CONFERENCE; ALIEN; INVIOABILITY; etc. Consult the authorities referred to under INTERNATIONAL LAW.

PRISONER OF CHILLON, THE. A poem by Byron (1816), founded on the history of François de Bonniard, a Genevese imprisoned by Charles, Duke of Savoy, in the Castle of Chillon, on the Lake of Geneva, from 1530 to 1536.

PRISON LABOR. Labor done by convicts or misdemeanants in prison. See CONVICT LABOR.

PRISONS (OF, Fr. *prison*, from Lat. *prænsio*, seizure, from *prendere*, *prehendere*, to seize, take, from *præ*-, before + *-hendere*, Gk. *χαραδύειν*, *chardancin*, to seize; connected with Goth. *bi-gitan*, to find, OHG. *firgezzen*, Ger. *vergessen*, to forget, AS. *gitan*, Eng. *get*). Prisons have been used from antiquity as places of detention or seclusion, but only in modern times as places of punishment for crime. Of the former class were the famous Tower of London, the Bastille of Paris, the Bicêtre, the Seven Towers of Constantinople, and the Castle of Spielberg in Austria. In the sixteenth century workhouses were erected in England, and also on the Continent, to which vagrants were committed; London (1550), Amsterdam (1588), Nuremberg (1588). There was at first little classification, and conditions were bad. Gradually, however, improvements were introduced. The rules and regulations necessary to the sheltering and employment of vagrants developed into prison discipline, while the necessity for classification led to the development of prison architecture. Imprisonment under the new conditions came to be viewed in a different light, and thus became a recognized punishment for crime.

Prisons were first looked upon as a possible means of reformation in 1704, when Pope Clement XI. established the Hospital of Saint Michael at Rome. This was not strictly a prison, but in the criminal wards the plan was introduced of having separate cells at night with work in common by day, silence being maintained. This plan is the basis of what is now known in America as the Auburn plan. A prison which became the architectural prison model for Western Europe and America was constructed at Ghent in 1773. The cells were in blocks, tier upon tier, radiating from a central octagon. The corridors were thus against the outer walls. This probably suggested the form of the Eastern Penitentiary at Philadelphia, in which, however, the corridors were placed in the centre of the blocks of cells, as at Saint Michael's. These plans, which make the entrance to each cell visible from the central room, have been adopted in many later prisons. Beccaria (q.v.), in his great treatise on *Crimes and Punishments* (1764), protested effectively against barbarous punishments, and John Howard (q.v.), who spent sixteen years in visiting the prisons of Europe, was able to effect radical changes in the prison régime of England. Two plans were henceforth followed. In one the prisoners are separated. They eat, work, and sleep in their cells apart from all other inmates. This is theoretically the policy of the Eastern Penitentiary of Pennsylvania and that adopted in Europe. By the other plan, the men have separate cells, but work, and often dine, together. This is the common plan in America. In either case much of the corrupting influence attendant upon the intermingling of prisoners is to a large extent avoided. Early prison conditions in America were exceedingly bad. At Simsbury, Conn., an abandoned copper mine was used as a State prison from 1773 to 1827. Reform began with the building of the Eastern Penitentiary at Philadelphia in 1817 and the Auburn State Prison of New York (1816), which became the

models for American prisons. Between the two systems fierce rivalry arose, but after many trials the Auburn plan has been generally adopted. With the introduction of steam heat, electric lights, and modern sanitary conveniences, prisons have been greatly improved. About the prisons are usually high walls on which guards are stationed, while the electric lights make undetected escape over the walls by night extremely difficult.

Prison management and discipline have not kept pace with mechanical improvements. The old forms of torture and barbarous punishment have, however, disappeared, while escapes are relatively infrequent. In the larger institutions there is great reluctance to tolerate idleness, which is always found to be demoralizing in the extreme. The question as to the proper occupation of the convict, however, is difficult of solution. (See CONVICT LABOR.) Inefficient management often destroys many of the good influences which modern penology demands shall surround the prisoner. Trained men are more and more needed both for efficient financial management and for wise discipline.

Places of imprisonment in the United States include 'lock-ups,' jails, and prisons proper. In each town or city are local 'lock-ups,' 'calabooses,' or 'police stations' for the detention of arrested persons pending immediate trial before the magistrates. Persons convicted of misdemeanors are confined in the county jails or houses of correction. Presumptive felons, bound over to the grand jury, are kept in the county jails pending trial, and then, if sentenced, are confined in the State penitentiaries. United States prisoners are usually kept in State institutions, as the general Government maintains only a few prisons. As a rule, county jails are breeding places of crime. The houses of correction are better managed. Few county jails provide work for prisoners. In some of the States the prison system is not yet well worked out. These institutions are for adults. There are also reformatories (q.v.) for younger delinquents. There is a general feeling that local jails should be given up, and that all prisoners should be under State control, as in England, where the general Government assumed control of all prisons in 1878.

The question of prison reform has received much attention in America as well as in Europe. The National Prison Congress, the National Conference of Charities and Correction, as well as local organizations, have had great influence in the past in bringing about improvements. The meetings of the International Prison Congress (q.v.) have been of great value. Consult: *International Prison Congress, Prisons and Reformatories at Home and Abroad* (London, 1872); Wines, *State of Prisons in the Civilized World* (Cambridge, 1880), a very useful compendium of facts; id., *Punishment and Reformation* (New York, 1895), an historical sketch of the rise of the penitentiary system; Barrows, *Prison Systems of the United States* (Washington, 1900); and id., *The Reformatory System in the United States* (ib., 1900). See CRIMINOLOGY; CONVICT LABOR; JUVENILE OFFENDERS; PENOLOGY; PUNISHMENT; REFORMATORIES.

PRISREND, préz'rënd. The capital of the Vilayet of Kosovo, European Turkey, situated on a small alluvial of the Drin, 75 miles east of Scutari (Map: Turkey in Europe, C 3). It is one of the most beautiful, richest, and most industrious towns in European Turkey. It has a citadel situated 1100 feet above sea-level, and a large number of bazaars, and carries on an active trade in flints, saddlery, glass, and copper and steel wares. Among its edifices are twenty-four mosques. The town is the seat of a Catholic archbishop, a Greek metropolitan, and a Servian theological school. Population variously estimated at from 30,000 to 60,000.

PRISTINA, prësh'tè-nà, or **PRISHTINA**. A town in the Vilayet of Kosovo, European Turkey, 30 miles north-northeast of Prisrend (Map: Turkey in Europe, C 3). It has several mosques and churches, and a Greek Catholic school. Population, 18,000, mostly Mohammedans.

PRITCHARD, CHARLES (1808-93). An English astronomer, born in Alberbury, Shropshire. He was educated at Christ's Hospital and at Saint John's, Cambridge. From 1834 to 1862 he was head of Clapham Grammar School, and in that period became a prominent member of the Royal Astronomical Society. Elected Savilian professor of astronomy at Oxford in 1870, he planned the new observatory, invented the wedge photometer about 1881, and in 1885 published *Uranometria Nova Oæoniensis*, a photometric catalogue for which in 1886 he received half of the Astronomical Society's medal. The measurement of stellar parallax by photography seems original with Pritchard. He died very soon after undertaking a share in the international stellar chart. He contributed to the *Encyclopædia Britannica*, and wrote *Occasional Thoughts of an Astronomer on Nature and Revelation* (1889).

PRITCHARD, MRS. HANNAH (1711-68). An English actress. She was found in 1733 singing in a booth at a public fair; from that time she appeared at the Haymarket and other London playhouses till, for the last twenty years of her life, she became a member of Garrick's company at Drury Lane. Though lacking in cultivation, she was an actress of great gifts in both comedy and tragedy. She played Cleopatra in *All for Love*, Zara in *The Mourning Bride*, and many other noted characters of the time. Her last appearance was in Lady Macbeth, her most famous rôle, in which only Mrs. Siddons could surpass her. A few months after her retirement, in 1768, she died at Bath, wealthy and universally respected. Consult: Doran, *Annals of the Stage* (ed. Lowe, London, 1888); Russell, *Representative Actors* (London, n.d.).

PRITCHARD, JETER CONNELLY (1857-). A United States Senator and jurist, born at Jonesboro, Tenn. He received an academic education at Martins Creek Academy, and was apprenticed to a printer. In 1873 he removed to Bakersville, N. C., where he worked at the printers' trade and became editor of the *Roan Mountain Republican*. He was a member of the Legislature in 1884, 1886, and 1890, and was admitted to the bar in 1887. He was the Republican candidate for Lieutenant-Governor in 1888, and the nominee of his party for United States Senator in 1892. The same year he was defeated for the Lower House of Congress, but helped to

bring about a fusion of Populists and Republicans on State affairs which was successful in 1894. He was elected to the United States Senate in 1895 for an unexpired term, and in 1897 was reelected for six years. As the only Republican Senator from the Southern States his influence was great. He was one of the leaders in the attempt to build up a white Republican party in the South, the so-called Lily-White movement, claiming that as the negro had been deprived of his vote in many of the States, it was unfair that he should control conventions and keep away desirable recruits from the ranks of business men. On the expiration of his term in 1903 he was appointed associate justice of the Supreme Court of the District of Columbia.

PRITCHETT, HENRY SMITH (1857-). An American astronomer, born in Fayette, Mo. After his graduation from Pritchett College, Glasgow, Mo., in 1875, he went to Washington to study practical and theoretical astronomy under Professor Asaph Hall in the United States Naval Observatory, where he became assistant astronomer in 1878. Two years afterwards he was appointed to the same position in the Morrison Observatory, Glasgow, Mo. He was sent to New Zealand in 1882 to observe the transit of Venus, and in 1883 was made professor of astronomy at Washington University, Saint Louis, Mo., and director of the observatory there. Six years afterwards he went to California in charge of the Government expedition for viewing the solar eclipse. He was superintendent of the United States Coast and Geodetic Survey, with headquarters at Washington, in 1897-1900, and was then elected president of the Massachusetts Institute of Technology, Boston.

PRITHU, prith'hoō. The name of several legendary kings of ancient India, especially one who is a hero in the Puranas (q.v.). His father was Vena, who was slain on account of his impiety. As Vena had left no offspring, and the kingdom consequently had no ruler, the sages assembled and consulted how to produce a son from the body of the dead King. First they rubbed his thigh, from which came forth a being called Nishada. By this means the wickedness of Vena was expelled. They then proceeded to rub the right arm of the dead King, and by this friction Prithu came forth, having in his right hand the mark of the discus of Vishnu, which destined him to be a universal emperor, whose power would be invincible even by the gods. Prithu soon removed the grievances of the people. He protected the earth, performed many sacrifices, and gave liberal gifts to the Brahmans, thus undoing his father's wickedness. During the interval in which the earth had been without a king, all vegetable products had been withheld, and consequently famine raged. He therefore marched against the earth, which, assuming the figure of a cow, fled from him. Seeing no escape, she at last promised to renew her fertility if he would make the world level. Prithu therefore uprooted mountains, and induced his subjects to take up their abodes where the ground had become a plain. The earth now fulfilled her promise; and as Prithu, by granting her new life, became, as it were, her father, she was henceforth called Prithivi.

PRIVAS, prè'vâ'. The capital of the Department of Ardèche, France, 43 miles northwest

of Orange by rail (Map: France, L 7). The town is built upon a ridge overlooking the valley of the Ouyèze, at the foot of the Coiron Mountains, and has a fine esplanade shaded with plane-trees, opening upon a panorama of great extent and beauty. It has important iron mines, the ore of which is exported, and it manufactures silks, woolens, leather, and brandy. Its buildings are unimportant. It was a Huguenot stronghold and was destroyed in 1629 by order of Louis XIII. and Richelieu. Population, in 1901, 7561.

PRIVAT-DOCENT, *prê-vât' dô-tsënt'* (Ger., private teacher). A private instructor in German and some other European universities. The privilege to thus offer instruction is acquired by promising scholars, holding the doctorate, after having gone through the process technically known as 'habilitation.' This process consists in publicly defending a scientific dissertation embodying the results of the candidate's original research. Usually the privat-docent draws his fees from the students.

PRIVATE (Lat. *privatus*, individual, p.p. of *privare*, to separate, from *privus*, one's own, from *præ*, OLat. *prai*, before). In the United States Army, all enlisted men, except the non-commissioned officers, are termed privates. See ARMY ORGANIZATION; and for pay, see PAY AND ALLOWANCES.

PRIVATE BILL. A technical term, employed to designate a bill introduced into the English Parliament for the benefit of one or more individuals, corporations, cities, or a particular locality, as distinguished from a general bill or act affecting the entire country or community. In the United States a measure affecting individuals is usually called a special act. See BILL; LEGISLATION; STATUTE.

PRIVATEERING. One of the usages of war according to which private individuals are authorized by the Government of one belligerent to fit out at their own expense vessels of war designed to prey upon the commerce of another belligerent. A privateer is an armed vessel fitted out for this purpose, owned and officered by a person or persons acting under a commission usually called a letter of marque (q.v.). Before granting such a commission it is usual to require the lodgment of caution money or the execution of a bond by way of security against illegal conduct. Citizens of the United States are forbidden by statute to accept letters of marque from powers at peace with the United States, and this is a general rule among nations. The commission is revocable upon proof of abuse, and according to English law the holder is liable in damages. As a further safeguard, a privateer is always subject to visitation and search by public vessels of war with a view to the verification of the genuineness of the commission under which it sails.

The practice of privateering is an old one among nations. In Europe it runs back to the time when public navies had not come into existence. During the Middle Ages, European States having few or no ships of war hired merchant vessels for the uses of war, and eventually the practice of issuing commissions to persons who owned ships or could procure them, authorizing them to prey upon the commerce of the enemy, came into general use. By way of compensation the person so commissioned was

allowed a share of the booty which he might capture. Such means enabled an inferior maritime power to call into existence on brief notice and at little or no expense a temporary force sufficient to enable it to cope with a more powerful rival. It was by this means that the Southern Confederacy during the Civil War drove the merchant marine of the United States from the high seas and seriously crippled its commercial interests. The practice is still sanctioned by international law, but it is rapidly falling into disfavor, and is not likely to be again extensively resorted to by any civilized nation. In the first place, a privateering force is never available for general naval operations, being restricted to the capture of unarmed merchant vessels. Secondly, the control over privateers is at most slight. Those who engage in the privateering service are often bold, adventurous, and sometimes lawless men, who tend to become robbers, since their motive is plunder and their reward booty. The belligerent employer of such persons has but little or no security against their aggressions upon neutral commerce, although he is held strictly responsible.

As the rights of neutrals increase, the disadvantage of employing this method of naval warfare becomes more potent. States having small navies find it possible upon the outbreak of war to increase their naval strength by purchasing or chartering ships. See DECLARATION OF PARIS.

PRIVATE SECRETARY, THE. A farce adapted by William H. Gillette from Von Moser's *Der Bibliothekar*, produced as *Digby's Secretary* in 1884, simultaneously with another adaptation, *The Private Secretary*, by Hawtrey, under A. M. Palmer. The best parts of each were combined later in the present form.

PRIVET (probably a corruption of *primet*, apparently from *prim*, privet, from Lat. *primus*, first, so called in allusion to its early bloom), *Ligustrum*. A genus of shrubs and small trees of the natural order Oleaceæ. Common privet (*Ligustrum vulgare*), a shrub growing in bushy places and about the borders of woods in the middle and south of Europe, is naturalized in some parts of North America. It has half-evergreen, smooth, lanceolate leaves, and black, rarely white, yellow, or green berries about the size of peas. The flowers have a strong and sweetish smell. The berries, which persist during winter, have a disagreeable taste, but serve as food for birds. They are used for dyeing. A rose-colored pigment obtained from them is used for coloring maps. The hard wood is used by turners and for making shoe pegs. Privet, though spineless, is much used for hedges, since it bears clipping well, and withstands the smoke and shade of towns. It is not hardy in Iowa and adjoining States, though introduced Russian forms seem able to withstand the winters. The so-called California privet (*Ligustrum ovalifolium*), a native of Japan, is one of the best varieties for hedges. Some species, natives of the East, have been introduced into American shrubberies. All species grow readily from cuttings.

PRIVET WEBWORM. The larva of a pyralid moth (*Diaphania quadristigmalis*), which feeds upon privet hedges in the United States. The soft, light-green eggs are fastened to the leaf near its midrib in clusters of fifty or more. The light-green caterpillars hatch in

early summer and feed upon the young leaves, hiding themselves in silken webs either between the upper leaves when still quite small, or lower down on the older leaves when fully grown. After three weeks they transform to the chrysalis condition within silken cocoons in folded leaves. The best remedy consists in trimming the hedge at the proper time, and afterwards applying an arsenical spray.

PRIVILEGE (Lat. *privilegium*, prerogative, from *privus*, one's own + *lex*, law). In law, a benefit or immunity growing out of some special rule of law or statute by virtue of which an individual or a class enjoys certain immunities or rights distinct from or beyond the provisions of law generally applicable to the community. It differs from a *dispensation* inasmuch as the latter merely relaxes the existing law for a particular case or cases, while the privilege is a permanent and general right. Of ancient and mediæval legislation the law of privilege formed an important branch, the so-called privileged classes being governed by a substantially different body of law from the other classes of society. In early law there were two privileges enjoyed by the clergy which deserve special notice from the frequency of the historical allusions to them—the 'privilege of the canon' (*privilegium canonis*) and the 'privilege of the forum' (*privilegium fori*). By the former the person of the clergyman, of whatever degree, was protected from violence by the penalty of excommunication against the offender; by the latter—known in England as 'benefit of clergy' (q.v.)—the clergyman upon claiming his privilege was exempted from trial by the ordinary civil tribunals, and could only be tried in the ecclesiastical court. Early English statutes placed limitations upon this latter privilege, and it was finally completely abolished. (See **BENEFIT OF CLERGY**.) In modern law there is scarcely any trace of the various form of class legislation which characterized the Middle Ages, and in most, if not all, of the States, class legislation is restricted by their respective constitutions. Privileges in the legal sense so far as they exist at all in modern law rest upon grounds of public policy, and in certain cases in the United States are sanctioned and protected by provisions of the State and Federal Constitutions.

Some forms of privilege have been considered in connection with other topics, in the law of which they constitute an essential part. Thus for a discussion of *privileges of witnesses*, that is, the circumstances under which witnesses are privileged from giving testimony, see **EVIDENCE**; **WITNESS**. For a discussion of the privilege which exempts one from liability for libel and slander, see **LIBEL**. See also **MONOPOLY**, and for the special privileges accorded to ambassadors and diplomatic agents by international law, see those topics respectively.

PRIVILEGES OF LEGISLATORS. It is essential to the maintenance of free government that members of legislative bodies should be privileged from arrest, both civil and criminal, during the term or session of the legislature, and for a reasonable time before the beginning and end of the session, and that they should not be called to any legal account for any language uttered by them during the course of their legis-

lative business. Such is the common law relating to members of Parliament. The United States Constitution provides (Art. 1, Sec. 6) that the Senators and Representatives "shall in all cases, except treason, felony, and breach of peace, be privileged from arrest during their attendance at the session of their respective Houses, and in going to and returning from the same, and for any speech or debate in either House they shall not be questioned in any other place." This provision has been substantially incorporated into the constitutions of the several States as applicable to the members of State legislatures.

PRIVILEGES AND IMMUNITIES OF CITIZENS. The Constitution of the United States nowhere undertakes to enumerate the privileges and immunities of citizens of the United States, although the Fourteenth Amendment assumes that there are such, and expressly prohibits the States from making or enforcing any law which shall abridge them. The Civil Rights Act declares that they include, among other things, the right to make and enforce contracts, to bring suit in the courts, to give evidence, to inherit, purchase, lease, hold, and convey real and personal property, and to enjoy the full and equal benefit of all laws and proceedings for the security of person and property. The Supreme Court of the United States in the noted Slaughterhouse cases, decided in 1872 (16 Wallace's U. S. Reports, p. 36), undertook to enumerate some of the more important of the privileges and immunities of United States citizens. According to the opinion of the court, they include a citizen's right of free access to the seat of government of the United States in order to assert any claim he may have upon that Government, to transact any business he may have with it, to seek its protection, to share its offices, to engage in its administrative functions; free access to the seaports, the sub-treasuries, land offices, and courts of justice; protection of life, liberty, and property when on the high seas, or within the jurisdiction of a foreign government; the right to assemble peaceably and petition for redress of grievances; the privilege of the writ of habeas corpus; the right to use the navigable waters of the United States; all rights secured to our citizens by treaties with foreign nations; the right to become a citizen of any State of the Union by a *bona fide* residence therein, with the same rights as other citizens of that State, etc. Of course, no enumeration can be complete, but the one given above is the most exhaustive and authoritative yet made. They include, as the court well says, the rights and privileges which of right belong to the citizens of all free governments. In the decision above cited the Supreme Court declared that there is a citizenship of the United States distinct from that of the State, and that only the privileges and immunities appertaining to United States citizenship are under the guardianship of the national authority, and that those appertaining to State citizenship must rest for their security and protection upon the action of States. With regard to the latter, the Constitution provides that the citizens of each State shall be entitled to all privileges and immunities of citizens in the several States. No complete enumeration of these has ever been attempted. Mr. Justice Washington, sitting in the United States Circuit Court, gave the opinion

that they might all be comprehended under the following general heads: protection by the Government, the enjoyment of life and liberty, the right to acquire and possess property of every kind, the right to pursue and obtain happiness and safety, the right to pass from one State to another for the purpose of trade, agriculture, professional pursuits, or otherwise, the privilege of the writ of *habeas corpus*, the right to maintain actions in the courts, to acquire and hold property, and the right of exemption from higher taxes than are paid by citizens of other States (*Carfield v. Coryell*, 4 Wash. c.c. 371). See also Cooley, *Constitutional Law*, pp. 206-208.

PRIVILEGED COMMUNICATION. A term applied to two distinct classes of statements. First, it denotes communications between parties to a confidential relation, which the law does not force the recipient to disclose as a witness. Examples of this class are statements made by a client to his lawyer, by a patient to his physician, those between husband and wife, those between a party and a witness in preparation of a case for trial, and State secrets. They are frequently called confidential communications. The extent to which they are privileged is generally regulated by statute in our States. Second, the term is also applied to statements which are defamatory, but which do not give to the injured party a right of action. Statements of this sort are of two kinds: absolutely privileged and conditionally privileged. Members of Parliament, of Congress, and of our State legislatures are not to be questioned in any other place than their respective Houses for any speech or debate made therein. (See United States Constitution, Art. 1, Sec. 6). Judges also enjoy an absolute privilege from civil action for anything said or written by them as judges. This rule is not made for the protection or benefit of a malicious or abusive judge, but for the benefit of the public, whose interest it is that judicial officers should be at liberty to exercise their functions with independence and without fear of consequences. Similar considerations of public policy have led the English courts to accord the same absolute privilege to the pleadings of litigant parties, to the remarks of counsel, and the statements of witnesses, in the course of judicial proceedings. In this country, however, the courts have generally held the privilege of such persons to be conditional and not absolute. That is, they are not liable in a civil action unless their defamatory statements are not pertinent or material to the case at issue, and are made in bad faith and for a malicious purpose.

A conditionally privileged communication is a defamatory statement made by a person in the discharge of some public or private duty, whether legal or moral; or in the conduct of his own affairs in a matter where his interests are concerned. The publication of legislative and judicial proceedings by newspapers belongs to this class. So do statements made by a lawyer to a client about the solvency of a third person with whom the client is about to engage in business transactions. Communications by a parent to a daughter of full age about the reputation of a suitor are also in this category, as are the warnings by a master to his servants about the character of a fellow-servant, or the statements of an employer about those who have

been in his service. In all of these, and in similar cases, the plaintiff must show that the defendant uttered the defamation in bad faith and for a malicious purpose, or he will fail in his action. See **DEFAMATION**; **LIBEL**; **SLANDER**. Consult Hageman, *Privileged Communications* (Somerville, N. J., 1889); also authorities noted under **SLANDER**; **LIBEL**.

PRIVILEGED DEBTS. In Scotch law, those debts which must be paid first out of bankrupt's, insolvent's, and decedent's estates, corresponding to the class of debts called preferred claims or debts in the United States.

PRIVILEGED DEED. In the law of Scotland, a holograph deed, which is exempted from the statute requiring deeds to be signed before witnesses.

PRIVY COUNCIL. In England, the assembly appointed by the sovereign to give advice on matters of state. In Anglo-Saxon times the kings had been advised by the Witenagemot, and in Norman times this became the Great Council. Naturally, the kings had more intimate counselors, and they separated in time from the larger body to form the Privy Council. There are traces of such a body as early as the minority of Henry III., but the institution did not become definitely fixed until the minority of Richard II. During the reign of Henry V. the name Privy Council first appears, and in the time of Henry VI. this became the official designation.

The period of the greatest power of the Privy Council was during the infancy of Henry VI. It came into frequent collision with Parliament, which was jealous of its power. Its sphere of action was very wide. As a deliberative body it gave advice to the Crown on political questions. It exercised legislative, judicial, and executive functions. Originally its judicial powers were very great. It frequently assumed cognizance of questions of private right; but in 1640 it was enacted that neither King nor Council should have any jurisdiction in matters regarding the estates and liberties of the subject, which should be tried in the ordinary tribunals of the land. The Star Chamber (q.v.), as it was constituted under Henry VII., was practically identical with the Council, except that the two Chief Justices were included among its members.

After the Restoration the executive and consultative powers of the Council began to decline. Vain attempts were made by Clarendon and later by Sir William Temple to give it new vigor. Since the reign of William III. the Cabinet has gradually appropriated all of the political functions of the larger body of which it is legally a part. The Privy Council has ceased to advise the Crown regarding the government of the realm.

Since 1870 a privy councilor may be either a native or a naturalized subject of Great Britain. The honor is conferred by the sovereign's nomination, without any patent or grant, and is completed by taking the oath of office. Among the large number of members of the Council are now included the princes of the royal family; the two archbishops; the Bishop of London; the judges of the House of Lords, the Judicial Committee, and the Court of Appeals; and all the Cabinet Ministers. The office of privy councilor

formerly fell by the demise of the Crown; but by an act of 1708 the Council continues to exist for six months longer unless sooner determined by the successor. Immediately on the decease of the sovereign, the Council assembles and proclaims his successor, the Lord Chancellor affixing the great seal to the proclamation. The body is styled collectively 'His Majesty's most honorable Privy Council.' The councilors are entitled to the designation 'right honorable' prefixed to their names; and they take precedence next after Knights of the Garter. A council can be held only under the presidency of the sovereign. Every other assembly of the members, though they should all attend, is merely a 'committee.'

The functions of the Council are either carefully defined by statute or they are exercised in virtue of the discretionary prerogative of the Crown. Some of them are of a formal or ceremonial character. In council, for example, a minister takes the official oath, a bishop does homage for the temporalities of his see, and the sheriffs for the counties are chosen. In certain cases of emergency proclamations may be issued in council; and under authority of Parliament Orders in Council (q.v.) have the force of law. Furthermore, the administration of various special laws of Parliament is intrusted to the Council. A large part of the administrative business is transacted in committees, either temporary or permanent. Legally the Cabinet (q.v.) is but a committee of the Privy Council. Other standing committees are the Judicial Committee, the Board of Trade, the Local Government Board, the Educational Committee, the Agricultural Committee, and the Committee for the Consideration of Charters of Incorporation under the Municipal Corporation Act of 1882.

Ireland has a Privy Council of her own; but the Privy Council of Scotland was merged in that of England in 1708.

JUDICIAL COMMITTEE. A high tribunal, composed of certain members of the Privy Council, created by the Act of 3 and 4 Wil. IV., ch. 41, in 1833. It was given jurisdiction of all appeals to his Majesty in council, which at that time included appeals from the High Court of Admiralty in both instance and prize cases, and all appeals from the courts of the colonies. The act also provided that the King might refer any other matters to the committee which he might see fit, and, under this clause, many important questions both legal and political in their nature have been decided by this committee. Members of the Council who are or have been justices of the superior courts of Great Britain and Ireland, comprising the Supreme Court of Judicature in England, the Superior Courts of Law and Equity at Dublin, and the Court of Session in Scotland, were included in the committee. The judges of the self-governing colonies, if members of the Council, are ex officio members of the committee. The Chief Justices of Canada, Cape Colony, and South Australia are now members. When it is considered that appeals from the highest courts of the colonies may involve important constitutional questions as to the powers and limitations of their legislative bodies, matters which to an important extent determine the very nature of the Empire itself, the dignity and importance of this Judicial Committee will be appreciated.

The committee has also jurisdiction over cer-

tain cases arising under the Clergy Discipline acts and petitions for the extensions of the terms of letters patent. By the Judicature Acts (q.v.) all jurisdiction of appeals from the High Court of Admiralty and in lunacy proceedings was transferred and vested in the Court of Appeal.

The forms of a secret council or committee have always been observed by the Judicial Committee, and no publication is made of the views or vote of any member. The judgments or decisions of the committee are transmitted to the sovereign in the form of a report, which embodies the views of the majority only.

EDUCATIONAL COMMITTEE. The committee on education was established in 1839 by an Order in Council for the purpose of promoting educational legislation and administering moneys voted by the Commons for school buildings and teachers' training colleges. The funds thus voted were turned over by the committee to two societies for the encouragement of elementary education among the poor, and provision was made for the inspection of schools by Crown officers. The encouragement of pupil teachers by scholarships in training colleges and the offer of salaries, made possible by the grants of 1846, and the administration of special funds for the increase in the salaries of trained teachers, also devolved upon this committee. The importance of the committee was greatly increased when in 1862 the distribution of moneys in aid of schools was made dependent on the character of their work. The committee of the Privy Council has charge mainly of the disposition of Government grants for public elementary education, the curricula, and the certification of teachers engaged in subsidized schools. The act of 1870 has increased its importance by investing it with the additional power of appointing school boards in cases where existing boards neglect their duties. In 1900 the Education Department, including the Department of Science and Art, was placed under the Board of Education for England and Wales, consisting of the Lord President of the Council, the principal Secretaries of State, and the Chancellor of the Exchequer.

Consult: Stubbs, *Constitutional History of England* (Oxford, 1894-97); Smith, *History of the English Parliament* (London, 1892); Gneist, *History of the English Constitution* (London, 1891); Macpherson, *Practice* (new ed., ib., 1873); Macqueen, *Appellate Jurisdiction of the Privy Council* (ib., 1842); Finlason, *The Judicial Committee of the Privy Council* (ib., 1878); Wheeler, *Privy Council Law* (ib., 1893); Dicey, *Privy Council* (new ed., ib., 1887); Anson, *Law and Custom of the Constitution* (Oxford, 1892); *Acts of the Privy Council*, new series, vols. 1-16, ed. by J. R. Dasent (London, 1890-1901).

PRIVY PURSE, KEEPER OF THE. An officer of the royal household in Great Britain charged with the payment of the private expenses and charities of the sovereign.

PRIVY SEAL. A seal of the British Government, which formerly was affixed to documents that were afterwards to be authenticated by the great seal, or that were of such minor importance as not to require the great seal. The officer who has custody of the privy seal is called the Lord Privy Seal. As early as the reign of

Edward III. he was a member of the King's Council and a responsible minister of the Crown. The adixing of the privy seal was for centuries by the authority of the Lord Chancellor. Until the reign of Victoria, all letters patent, patents of inventions, charters, naturalizations, pensions, creations of honors, pardons, and so on, were required to pass from the signet office to the privy seal office, the signet seal being the warrant for the privy seal, as the latter was for the great seal. By the Great Seal Act, 1884 (47 and 48 Vict., c. 30, s. 3), it was provided that all instruments required to pass the great seal need only have a warrant under the sign manual, countersigned by the Lord Chancellor, Secretary of State, or a high official of the Treasury, and that thereafter no instrument need be passed under the privy seal. The Lord Privy Seal still ranks as fifth great officer of State, usually with a seat in the Cabinet, but there is no salary and no definite functions are now attached to the office. A peer above the rank of a baron is usually appointed; but a commoner is eligible. See GREAT SEAL.

PRIX DE ROME, *pré de rôm* (Fr., prize of Rome). The Grand Prix de Rome is a prize given by the French Government to a certain number of painters, sculptors, architects, musicians, and engravers, who have passed a rigid examination in their respective departments of art. The winner of the Prix has four years at the Villa Medici, the Académie de France à Rome, and the annual sum of about 4000 francs for his expenses; he is also exempt from military service. The competition for the Prix is open to any Frenchman between the ages of fifteen and thirty, who has fulfilled certain conditions in the Ecole des Beaux-Arts (q.v.), or elsewhere. A scheduled length of time is allowed the student in which to make drawings or models of a given subject, for the completed design, and ten pupils from each section are selected to enter the final competition. They have three months in which to prepare their work. The awards are made every year to painters, sculptors, musicians, and architects; every two years to line engravers; and every three years to engravers on fine stones and medalists. The Académie des Beaux-Arts, a section of the French Institute, has charge of the school at Rome, and the 'concours' for the Grand Prix. The director of the Academy at Rome is always a French painter chosen from among the members of the Académie des Beaux-Arts. A series of 'envois,' or specimens of work, are sent each year from Rome to the Salon, to show the pupils' progress. In the case of a musician, the 'envoi' goes to the Conservatory, which possesses autographs of all the prize cantatas since the establishment of the Prix.

The Prix de Rome was founded by Louis XIV. in 1666. Its purpose was to educate promising young painters and sculptors, at the cost of the State, by study of the antique in Rome. The first director of the school was Charles Errard (q.v.). In 1720 architects were also allowed to compete for the Prix. During the Revolution the school was inactive, but Napoleon enlarged it, and after 1803 musicians, medalists, line engravers, and engravers of precious stones were added to the list of 'pensionnaires.' At this date also the school was removed to the Villa Medici, the present site of the Académie de France à Rome. The

artistic value of the Prix de Rome is a disputed question. What was perhaps a necessity in the time of Louis XIV. is now said to have outgrown its use, but, on the other hand, the list of prize-winners in every department during the last century embraces many of the great names of France. Consult Baltard, *Villa Medici à Rome* (Paris, 1847).

PRIZE (OF, Fr. *prise*, fem. sg. of *pris*, p.p. of *prendre*, from Lat. *prendere*, *prehendere*, to seize, take). In international law, a term applied to all captures of property made during the course of war upon the high seas or in the territorial waters of a belligerent. The right to capture both the public property of an enemy on the sea and even the private property of his subjects is recognized by the rules of international law, although the right to capture private property on land has been generally abandoned. The capture of enemy's property cannot be lawfully made in neutral waters, and prizes thus taken must be restored to their owners with such reparation as the neutral Government may demand for the violation of its neutrality. Without authority the act of capture must be regarded as piracy and punishable as such. Since the authority to capture enemy's property is derived from the belligerent Government, it follows that the title of the captor to the prize which he has taken is subject to the disposition of his Government according to law. The Government may therefore vest the title in the captor, or it may appropriate the prize to its own use, or destroy it, or sell it, distributing the proceeds among the captors in such manner as the laws of the State may prescribe.

A question of some importance in the law of prizes is the determination of the exact date when the title passes from the original owner to the captor. The right of the captor to that which undoubtedly belongs to his enemy is complete as between him and his enemy so soon as the capture is complete; but as between him and a neutral State which may lay claim to a whole or part of the prize, further evidence of the lawfulness of the capture must be forthcoming. According to one view, the title passes at the moment at which the capture is definitely effected and all resistance has ceased, as is evidenced by striking the flag or voluntarily surrendering. Others claim that the title vests in the captor after twenty-four hours of secure possession. Still others insist that the capture is complete only when the prize has been carried *infra præsidia* and is thus secure against the possibility of recapture. Whatever may be the correct rule, it would seem that the Government to which the captor belongs has an inchoate title at least from the moment the act of seizure has been accomplished. This title may be contested by a neutral Government on the ground that the capture was made in its waters, or by its subjects, or for other reasons. The inchoate title, therefore, is made complete by having the prize sent in to a port of the captor and the question of the lawfulness of the capture authoritatively determined by a judicial tribunal. (See PRIZE COURT.) To this end it is the first duty of the captor to bring in his prize for adjudication if it is capable of making the voyage, otherwise he should destroy it as enemy's property if there be no doubt as to its character, or sell it and turn over the proceeds to the jurisdiction of the proper court for distribution. Formerly the usages of war per-

mitted the captor to take his prize into a neutral port, but neutrals may forbid the use of their ports for this purpose, if they see fit, and this is almost the invariable practice except in case of distress or other emergency, and then only for as short a time as circumstances will allow.

A prize intended to be sent into port for adjudication is put in charge of a prize-master who is aided by a prize crew. They are charged with taking care that the vessel is not despoiled or damaged and that it is duly delivered to the custody of the court with the ship's papers, register, etc. In order to avoid depletion of the fighting strength resulting from the necessity of supplying prize crews where a number of captures are made, or where for other reasons it may be inconvenient to send a prize into port, it is frequently provided by municipal law and is recognized by the law of nations that a captor may destroy his prize, subject, of course, to the liability of the captor's Government for any loss or injury occasioned to neutrals thereby. The right of the captor to accept a ransom for his prize is also recognized. This is an arrangement between the captor and the master of the captured vessel by which the vessel is allowed to continue its voyage upon the promise of the master to pay a specified sum to the captor. The ransom contract serves as a safe conduct for the vessel during the remainder of the voyage and is a guarantee against capture by another vessel of the captor's Government or that of his ally, but not against the perils of the sea. Ransom contracts are valid instruments under international law, and it is customary to allow either party to bring suit on it in the courts of the other. As a means of encouraging the capture of an enemy's vessels, the laws of many States provide for the offering of special rewards to those taking part in operations leading to the capture of vessels belonging to an enemy. Such is the prize money heretofore allowed by the Government of the United States, which consisted of the proceeds of the sale of captured vessels and cargoes lawfully captured and regularly condemned, and distributed among officers and crew. This provision for prize money, which had been a law of the United States from the establishment of the Government, was abolished by an act of March 3, 1899. By this act all laws authorizing the distribution of prize money as well as for the payment of bounties and head-money were repealed. See ADMIRALTY; CONTRABAND OF WAR; DECLARATION OF PARIS; PRIVATEERING; PRIZE COURTS; RECAPTURE; WAR, LAWS OF.

PRIZE COURTS. Special tribunals for the adjudication of questions of prize (q.v.). The submission of the question of the legality of a capture in war to the determination of a court is not a right which an enemy may claim, since it is assumed that all captures are enemy's property. But the fact that property frequently captured is claimed to be owned by neutrals makes a judicial inquiry in such cases necessary in order to determine the responsibility of a belligerent to neutrals. As the determination of questions of this character involves the exercise of admiralty jurisdiction, it is customary to confer jurisdiction in cases of maritime capture upon the admiralty courts. In Great Britain this is done by special commission; in the United States it is a regular branch of the admiralty jurisdic-

tion, which is exercised in the first instance by the district courts. Prize courts differ from other municipal courts in that jurisdiction over the property of a foreigner is acquired, not by his consent expressed or implied, but by force. A prize court usually sits within the territorial jurisdiction of the belligerent under whose authority the capture is made, although it may sit within the territory of an ally. It may not, however, sit in the territory of a neutral even with the consent of the latter.

It is highly desirable that the court may have the prize within its own custody, not only as a means of facilitating the investigation, but to diminish the risks of concealment and fraud and to insure a fair sale or speedy restitution. The question to be decided by the court is whether, according to the law of nations, the ship and cargo in question were liable to capture, and if so whether the capture was lawfully made. If the decision be in the affirmative, the prize is pronounced good, is then sold and the proceeds placed in the hands of an officer of the Government for distribution among the officers and men who made the capture, according to the provisions of the law governing captures. If the decision be in the negative, the vessel is restored to its owners. If in the latter case it has suffered damage from the hands of the captors, the Government of which the captors are subjects is held responsible only for failure to use reasonable care and skill.

The procedure in prize cases is based chiefly on the principles of the Roman law. The common-law doctrine as to the competency of witnesses has no application in the procedure of prize courts. The decision of a prize court is binding upon all parties concerned, but, on account of the magnitude of the interests often involved, provision is usually made in the municipal law of every State for the right of appeal to a higher court. Thus in the United States appeals from the decisions of the district courts lie to the United States Supreme Court.

PRIZE FIGHTING. In law, fighting with the fists, either with or without gloves, in public, and for some reward or prize. It is sometimes said that there must be an intention to fight 'to a finish' in order to constitute a prize fight, but the practice of fixing a limited number of rounds, in order to ostensibly make it a sparring exhibition, has necessitated the adoption of a different rule. The question of the intention of the parties and the promoters of the fight is important. If the intention is for either of the contestants to 'knock out' the other or disable him, and the fight is a public exhibition for money or a prize, it will be considered as a prize fight. The manner of distribution of the prize money between the contestants is immaterial. A prize fight differs from a sparring match in that the latter is not held for a prize, and there is no intention on the part of the contestants to do each other bodily harm. Most of the States define and prohibit prize fighting by statute. See PUGILISM.

PRJEVALSKY, przhá-vál'skè, NIKOLAI. See PRZHEVALSKI.

PROA. See CATAMARAN.

PROBABILISM (from Lat. *probabilis*, probable, from *probare*, to test, examine, from *probus*, good, Skt. *prabhu*, preëminent, from *pra*, before + *bhū*, to be). In Roman Catholic theology, the

doctrine regarding the use of so-called 'probable opinions' in guiding the conscience as to the lawfulness or unlawfulness of any particular action. The word came prominently into discussion in the seventeenth century and seems now fully accepted as a technical name. As the ground of the doctrine, it is assumed that, in human actions, absolute certainty is not always attainable as to their lawfulness or unlawfulness. Short of this certainty, the intellect passes through the stages of 'doubt' and of 'probability.' In the former, it is swayed between conflicting views, so as to be unable to decide, or even to approach toward deciding, what is true. In the latter, although there is a conflict of views, yet the reasons in their favor are not so equal that the intellect cannot see preponderating motives in favor of the truth of one or of the other. Moreover, in the conflict of views, another element will arise, as to their comparative 'safety,' that is, the greater or less danger of moral culpability which they involve; and this greater or less moral 'safety' of a view may or may not coincide with its greater or less 'probability.'

The doctrine of probabilism arose in the Middle Ages from the wide play given in penitential books to the idea of the morally indifferent, and was further promoted by the discussions of the scholastics upon conflict of authorities, and thus upon apparent or real conflict of duties, in the moral sphere. Vasquez introduced (1598) probabilism into the moral theology of the Jesuits, and it soon gained a large place, being developed with great subtlety. In its extremest developments probabilism held that it is lawful to act upon any opinion which has in its favor the authority of any grave and approved doctor, though it may be less probable than its opposite. Escobar taught that a confessor must absolve if a penitent appeals to a probable opinion, even if he himself holds another. In the sequel there was a very great relaxation of the whole moral tone, and serious scandals arose, leading to the condemnation of probabilism by the Sorbonne (1620). Against this theory, called probabilism simple, Pascal (q.v.) directed some of his famous *Provincial Letters* (1656). Discussion upon the subject was long continued, and in 1691 Gonzalez, the general of the Jesuits, issued his *Elements of Moral Theology*, which took the anti-probabilistic side, requiring that an opinion shall be certain before it is acted upon. Later sprang up three schools of probabilism, (1) that of *æqui-probabilism*, according to which, of two opinions one can be chosen only if it is at least equally probable with the other; (2) *probabiliorism*, according to which there are no cases of exactly equal probability, and the more probable is always to be followed; (3) *tutorism*, according to which the safer opinion is to be followed, even if less probable.

The great modern master on the subject is Saint Alfonso Liguori, whose system may be described as a kind of practical probabiliorism, in which, by the use of what are called reflex principles, an opinion which *objectively* is but probable is made *subjectively* the basis of a certain and safe practical judgment. There can be no doubt that the system of probabilism has been pushed by some individual divines to scandalous extremes; but it is only just to add that these extremes have been condemned by authority in the Roman Church; and that, on the other hand, the

principles of the higher Roman schools of probabilism are substantially the same as those of all moralists, whether of the old or of the new schools of ethics.

Consult: Döllinger-Reusch, *Geschichte der Moralstreitigkeiten in der römischen Kirche seit dem 16. Jahrhundert* (Nördlingen, 1889); Luthardt, *Geschichte der christlichen Ethik* (Leipzig, 1892).

PROBABILITY (Lat. *probabilitas*, from *probabilis*, probable). Expressions like the following are in common use: "It will probably rain to-day," "The chance of finding the article is very small," "He is more likely to succeed than to fail," "A is almost sure to be elected." These expressions all imply a lack of knowledge, an uncertainty as to the actual condition of affairs. But they signify different degrees of uncertainty. The first and third are indefinite, the second and fourth are quite definite. In order to answer in mathematical terms the question, "What is the chance of an event happening?" it is necessary to have some standard of measure or of comparison. Suppose we know only one of ten candidates on examination for a degree, and we hear that one passed. What is the chance or probability that our acquaintance is that one? If, according to our knowledge of the case, one candidate is as likely to pass as any other, we may say that the chance of our acquaintance having passed is 1 to 10. If, however, six of the candidates are men, and our acquaintance is a man, and we hear that it is a man who passed, the chance is now 1 to 6. But if we hear the name of the successful candidate, this name corresponding to that of our acquaintance, and observe that the names on the list are all different, the chance is now 1 to 1, or it is a *certainty*. Certainty is called the *unit of probability*. It is the standard which all estimate alike. All other degrees of probability will be expressed as fractions of certainty. E.g., in the above case of the candidate, on the first evidence the chance is 1:10, on the second evidence it is 1:6, on the third 1, or certainty.

If an event can occur in only one of a number of different ways, equally likely to occur, the probability of its happening at all is the sum of the several probabilities of its happening in the several ways. This proposition, the result of common experience, is generally accepted as axiomatic. Thus a coin can fall either head or tail, therefore the chance of its falling head is $\frac{1}{2}$, and of its falling tail is $\frac{1}{2}$, the sum of these chances being 1. This is as it should be, for the coin must certainly fall in order to produce head or tail. The probability of an event not happening is found by subtracting from unity the fraction representing the probability that it will happen. E.g., if the chance of an event happening is $\frac{2}{3}$, the chance of its not happening is $1 - \frac{2}{3} = \frac{1}{3}$. Or, if A's chance of hitting a target is $\frac{1}{3}$ and B's chance of hitting it is $\frac{1}{6}$, the chance of both missing it is $1 - (\frac{1}{3} + \frac{1}{6}) = \frac{1}{2}$. Two probabilities whose sum is unity are called *complementary probabilities*. E.g. the probability of drawing at one trial a white ball from a bag containing 2 white and 3 black balls is $\frac{2}{5}$. The probability of drawing a black ball is $\frac{3}{5}$. Their sum is 1, hence they are complementary probabilities. In general, if an event can happen in *a* ways and fail in *b* ways, all of which are equally likely to oc-

cur, the probability of its happening is defined to be $\frac{a}{a+b}$, and the probability of its failing is defined to be $\frac{b}{a+b}$, the two being complementary.

In this case, the odds in favor of the event are said to be a to b , and the odds against the event are said to be b to a . E.g. there are five ways of drawing one black ball from five black balls and three ways of drawing a white one from three white balls. Hence the probability of drawing a black ball from the whole eight on the first trial is $\frac{5}{8}$, and of not drawing a black ball, or, what is the same thing, of drawing a white one, is $\frac{3}{8}$. The odds in favor of drawing a black ball are 5 to 3. The odds against this are 3 to 5. Likewise, the odds in favor of drawing a white ball are 3 to 5, and the odds against it are 5 to 3.

If the probability of two independent events taking place are respectively $\frac{a}{(a+b)}$ and $\frac{a'}{(a'+b')}$, the probability that both will happen is $\frac{aa'}{(a+b)(a'+b')}$. The probability of both events failing is $\frac{bb'}{(a+b)(a'+b')}$. When *fail* is substituted for *happen*, bb' must be substituted for aa' . Similarly, the probability that the first event happens and the second event fails is $\frac{ab'}{(a+b)(a'+b')}$ and the probability that the first event fails and the second event happens is $\frac{a'b}{(a+b)(a'+b')}$. E.g., if p and p' are the respective probabilities that each of two events happens, then pp' is the probability that both happen. In like manner, if there of two events happens, then pp' is the probability that they will all happen is the product of their respective probabilities of happening.

If p represents the probability of the happening of an event in one trial and q the probability of its failing, the probability that it will happen exactly r times in n trials is

$$\frac{n(n-1) \dots (n-r+1)}{r!} p^r q^{n-r}.$$

The probability that an event will fail exactly r times in n trials is

$$\frac{n(n-1) \dots (n-r+1)}{r!} p^{n-r} q^r.$$

In the expansion of $(p+q)^n$, viz.

$$p^n + np^{n-1}q + \frac{n(n-1)}{2!} p^{n-2}q^2 + \dots,$$

the terms represent respectively the probabilities of the happening of the event exactly n times, $n-1$ times, $n-2$ times, and so on, in n trials. Hence the most probable number of successes and failures in n trials is given by the greatest term in the corresponding series. E.g. the probability of throwing an ace in one trial with a die is $\frac{1}{6}$ and of failing to do so is $\frac{5}{6}$. Also $(\frac{1}{6} + \frac{5}{6})^4 = \frac{1}{1296} + \frac{4}{216} + \frac{6}{216} + \frac{4}{216} + \frac{1}{1296}$, hence the probability of throwing an ace 4 times in 4 throws is $\frac{1}{1296}$, the probability of throwing an ace 3 times in 4 throws is $\frac{4}{216}$, the probability of throwing an ace 2 times in 4 throws is $\frac{6}{216}$, the probability of throwing an ace 1 time in 4 throws is $\frac{4}{216}$, the probability of throwing an ace no time in 4 throws is $\frac{1}{1296}$. Since the last fraction is the largest, the case of no ace in 4 throws of a die is more probable than that of 1, 2, 3, or 4 aces.

A problem in life insurance, a subject to which the theory of probability has been of indispensable service, will serve to show the applications of the subject. A table of mortality gives the numbers alive at each successive year of their age, out of a given number of children born. If A_n and A_{n+1} be the numbers in the table corresponding to the n th and $(n+1)$ th years of age; the inference from the table is, that of A_n individuals now alive, and of n years of age, A_{n+1} will live one additional year at least. Hence, the chance that any one of them die during the year is $\frac{A_n - A_{n+1}}{A_n}$. Calling this $1-p$, p is the chance

that any one of them will survive the year. Of two individuals, one n years old, and the other n' , what are the chances that (a) only one lives a year? (b) one, at least, lives a year? (c) both do not live a year? Calling the individuals A and B, the chance of A living out the year is p , and the chance of his dying within the year is $1-p$. For B these are p' and $1-p'$. Hence that A lives and B dies the chance is $p(1-p')$. That B lives and A dies the chance is $p'(1-p)$. Hence the answer to (a) is $p+p'-2pp'$. The second case includes, in addition to the conditions of (a), the chance that both survive, which is pp' . Hence the answer to (b) is $p+p'-pp'$. In the third case the chance that both live a year is pp' . Hence the chance that both will die is $1-pp'$.

The theory of probability also furnishes a measure of expectation. The law of expectation in its simplest form may be stated thus: The value of a contingent gain is the product of the sum to be gained into the chance of winning it. Suppose A, B, and C have made a pool, each subscribing \$1, and that a game of pure chance (i.e., not dependent on skill) is to be played by them for the \$3. What is the value of the expectation of each? By the conditions, all are equally likely to win the pool, hence its contingent value must be the same to each; and, obviously, the sum of these values must represent the whole amount in question. The worth of the expectation of each is therefore \$1. That is, if A wishes to retire from the game before it is played out, the fair price which B or C ought to pay him for his share is simply \$1. But this is obviously $\frac{1}{3}$ of \$3, i.e. the value of the pool multiplied by his chance of getting it.

Another very important application of the theory of probability is to the deduction of the *most probable* value from a number of observations, each of which is liable to certain accidental errors. In a set of such observations, the probable error is the quantity such that there is the same probability of the true error being greater or less than it, and this probable error has been shown to be least when the sum of the squares of the errors is a minimum. The method for obtaining this least error is called the method of least squares. See LEAST SQUARES, METHOD OF.

The doctrine of probabilities dates as far back as Fermat and Pascal (1654). Huygens (1657) gave the first scientific treatment of the subject, and Jakob Bernoulli's *Ars Conjectandi* (posthumous, 1713) and De Moivre's *Doctrine of Chances* (1718) raised the subject to the plane of a branch of mathematics. The theory of errors may be traced back to Cotes's *Opera Miscellanæ* (posthumous, 1722), but a memoir prepared by Simpson in 1755 (printed 1756) first applied the theory

to the discussion of errors of observation. Laplace (1774) made the first attempt to deduce a rule for the combination of observations from the principles of the theory of probabilities. He represented the law of probability of errors by a curve $y = \theta(x)$, x being any error and y its probability, and laid down three properties of this curve: (1) It is symmetric as to the Y-axis; (2) the X-axis is an asymptote, the probability of the error ∞ being 0; (3) the area enclosed is 1, it being certain that an error exists. He deduced also a formula for the mean of three observations. Among the contributors to the general theory of probabilities in the nineteenth century have been besides Laplace, Lacroix (1816), Littrow (1833), Quetelet (1853), Dedekind (1860), Helmert (1872), and Laurent (1873). On the geometric side the influence of Miller and *The Educational Times* has been marked. The literature of the subject is very extensive. Of the recent works, besides those already mentioned, the following are among the most important: Czuber, *Geometrische Wahrscheinlichkeiten und Mittelwerte* (Leipzig, 1884; French trans., Paris, 1902); Herz, *Wahrscheinlichkeits und Ausgleichungsrechnung* (Leipzig, 1900); Kries, *Die Principien der Wahrscheinlichkeits-Rechnung* (Freiburg, 1886); Poincaré, *Calcul des probabilités* (Paris, 1896); Whitworth, *Choice and Chance* (Cambridge, 3d ed., 1878). The following earlier works are also well known: Cournot, *Exposition de la théorie des chances et des probabilités* (Paris, 1843); De Morgan, *Essay on Probabilities* (London, 1838); Lacroix, *Traité élémentaire du calcul des probabilités* (Paris, 1833); Poisson, *Recherches sur la probabilité des jugements* (Paris, 1837). For the early history of the subject, consult Todhunter, *History of the Mathematical Theory of Probability* (Cambridge, 1865). For the later history and for a brief essay on the theory, consult Merriman and Woodward, *Higher Mathematics* (New York, 1896).

PROBATE COURT (Lat. *probatus*, p.p. of *probare*, to test, examine, from *probus*, good). A court whose original functions consist in the probate of wills and the administration of decedents' estates. In England it dates from the Court of Probate Act of 1857 (20-21 Vict., c.77), a statute which conferred upon this new tribunal all the powers and duties in probate matters, which the Prerogative Court of the Archbishop of Canterbury then had. By the Judication Act of 1873 (36-37 Vict., c.66) it became a part of the Supreme Court of Judication under the title of the Probate Division. Besides the judges of this division of the High Court of Justice, there are various registrars, record keepers, and minor officials assigned to the registry districts into which the kingdom is divided. Each district registrar has power to grant probate of wills or letters of administration, upon estates of persons having a fixed abode within the district at the time of death, provided no opposition is made thereto. In case of litigation, however, the proceedings for probate must be taken in the proper County Court, or in the Probate Division of the High Court.

In the United States, probate courts have been temporal tribunals from the first. This was inevitable, for there were no Church establishments in connection with which ecclesiastical courts could be organized after the English model. Hence the various colonies conferred the powers

of proving and registering wills, of granting letters of administration, and the like, upon some minor civil tribunal, such as the County Court in Massachusetts, or the Court of Burgomasters in New York, while that colony belonged to Holland, or the Court of Common Pleas after it passed under English rule. In many of the States at present probate tribunals are distinct courts, with original and extensive jurisdiction not only over the probate of wills and the administration of decedents' estates, but over the appointment of guardians to minor and other legally incompetent persons, over petitions for the adoption of children, and the change of names. In other States these functions are imposed by statute upon different local tribunals, such as district and county courts. Even in States of the former class, the tribunals are variously designated, as Courts of Probate, Surrogates' courts, Ordinary's courts, or Orphans' courts. They are always inferior courts from whose decisions appeals may be taken to higher tribunals. For their jurisdiction and powers, the statutes in each State must be consulted. See Nelson, *Handbook on Probate Practice* (London, 1901); Powles and Oakley, *Principles and Practice of the Court of Probate* (ib., 1892); Smith, *Practice and Proceedings in the Probate Courts* (Boston, 1894); Redfield, *Law and Practice of Surrogates' Courts in the State of New York* (New York, 1894).

PROBATION AFTER DEATH (Lat. *probatio*, from *probare*, to test, examine). A theological doctrine according to which man's future destiny is not unalterably fixed at death, but either all men or a certain class of men will be placed on trial in another life for a definite period or until they shall have yielded to God's redeeming love. In one form or another this doctrine has been held by many Jews and Christians since, under the influence of Persian and Greek thought, the idea of future punishment developed among them. (See HELL.) Some have thought of a fixed period extending from the death of the individual to the final judgment; others have made the period indefinite in length, depending upon the intensity of the soul's resistance to the grace of God. Some limit probation after death to such persons as have not had opportunity in this life of accepting Christ; others think that the same privilege will be extended to all men. Scriptural support for the doctrine has generally been sought in I. Peter iii. 19-20, iv. 6, in which a critical exegesis unquestionably is obliged to find the belief expressed that Jesus, after his death, went to Hades to proclaim the gospel to one class of the dead, viz. those who had been disobedient in the days of Noah. While the advocates of future probation have emphasized the necessity of actual knowledge of the life, teachings, death, and resurrection of Jesus, many defenders of the officially recognized system of eschatology have regarded such knowledge as of less importance than the moral and religious disposition that under favorable circumstances may find expression in a free and intelligent acceptance of Christ. A changed estimate of the value of the statements of Bible and creeds, and new methods of approach to the whole subject of man's future existence, have tended to remove from public discussion what once was a very burning question. Consult: Dorner, *System der christlichen Glaubenslehre*

(Berlin, 1879-81; Eng. trans., Edinburgh, 1880-84); *Dorner on the Future State*, translation of the eschatological section of the preceding work by Newman Smyth (New York, 1883). See ESCHATOLOGY; IMMORTALITY; JUDGMENT, FINAL; HEAVEN; HELL; UNIVERSALISM.

PROBLEM (OF. *probleme*, Fr. *problème*, from Lat. *problema*, from Gk. *πρόβλημα*, *problem*, from *προβάλλειν*, *proballain*, to place before, from *πρό*, *pro*, before + *βάλλειν*, *ballain*, to throw). In geometry, a proposition in which some operation or construction is required, e.g., the proposition "To construct an equilateral triangle" would be a problem.

PROBLEM OF THE THREE BODIES. An astronomical problem demanding the motion of three bodies attracting one another according to the law of gravitation. A complete solution of this problem has so far defied the mathematicians, although the general differential equations of the motion were given by Laplace. See CLAIRAUT.

PROBOSCIDEA (Neo-Lat., from Lat. *proboscis*, from Gk. *προβοσκis*, *proboskis*, *proboscis*, from *πρό*, *pro*, before + *βόσκειν*, *boskein*, to feed). An order of mammals embracing the elephants (q.v.), living and extinct. The nearest relatives of the Proboscidea are the extinct Toxodontia on one hand, and on the other the Hyracoidae. Consult Beddard, *Mammalia* (London, 1902).

PROBOS'CIS MONKEY, or NOSE-APE. A large, yellowish monkey with the head and long hair of the neck and shoulders chestnut. It is closely allied to the langurs, but is distinguished by having in the adult male a comically long nose, for which reason mainly it has been set apart in a separate genus, and given the name *Nasilis larvatus*. This monkey is a native of Borneo, where it goes about in large bands, the habits of which are little known. It seems to be merely an aberrant form of the genus *Semnopithecus*. See PLATE OF MONKEYS OF THE OLD WORLD.

PROBUS, MARCUS AURELIUS, Roman Emperor A.D. 276-282. He was born at Sirmium, in Pannonia. Probus early entered the army, and had the good fortune to attract the favorable notice of the Emperor, Valerian, who elevated him before the legal period to the rank of tribune. He distinguished himself against the Sarmatians on the Danube, and subsequently in Africa, Egypt, Asia, Germany, and Gaul, winning golden opinions from Valerian's successors, Gallienus, Claudius II., Aurelian, and Tacitus. By the last-named Emperor he was appointed governor of the whole of Rome's Asiatic possessions, and declared to be the chief mainstay of the Roman power; and such was the zealous attachment evinced for him by his soldiers, whose respect and love he had won equally by his firm discipline, by his care in providing for their wants and comforts, and by his liberality in the distribution of plunder, that, on the death of Tacitus, they forced him to assume the purple; and his rival, Florianus, having been removed, Probus was enthusiastically hailed Emperor by all classes (A.D. 276). His brief reign was signalized by brilliant and important successes; the Germans, who, since Aurelian's time, had made Gaul almost a part of Germany, were driven out with enormous slaughter, pursued into the heart of their

own country, compelled to restore their plunder, and to furnish a contingent to the Roman armies. Pursuing his victorious career, Probus swept the barbarians from the Rhatian, Pannonian, and Thracian frontiers, and forced Persia to agree to a humiliating peace. On his return to Rome, Probus celebrated his achievements by a triumph, and then, the external security of the Empire being established, devoted himself to the development of its internal resources. The senate was confirmed in its privileges; liberal encouragement was given to agriculture; numerous colonies of barbarians were established in thinly peopled spots, that they might adopt a civilized mode of life; and all branches of industry were protected and promoted. But Probus, as the Romans had now no enemies, employed the soldiers as laborers in executing various extensive and important works of public utility. Such occupations, considered as degrading by the soldiers, excited among them the utmost irritation and discontent, and a body of troops murdered him October, A.D. 282.

PROBUS, MARCUS VALERIUS. A Roman critic and grammarian, born at Berytus, in Syria, in the second half of the first century A.D. He devoted his attention chiefly to the archaic and classic literature of Rome, and made annotated editions of Horace, Vergil, Lucretius, Terence, and Persius, after the manner of the Alexandrian scholars. His biography of Persius is extant, but the commentary to Vergil's *Eclogues* and *Georgics*, and several grammatical treatises bearing his name, are probably the works of a grammarian of the fourth century. Probus is usually ranked among the greatest Roman philologists. Consult: Teuffel and Schwabe, *Geschichte der römischen Litteratur* (5th ed., Leipzig, 1890); and Steub, *De Probis Grammaticis* (Jena, 1871).

PROCEDURE (OF. *proccedure*, Fr. *procédure*, from Lat. *procedere*, to go forward, from *pro*, before, for + *cedere*, to go). In law, the successive steps or proceedings in the initiation and conduct of a judicial proceeding, and the rules of law governing them. In its broadest sense the term includes evidence and pleading. In a narrower sense the term is used as synonymous with practice, which embraces the rules governing the form and manner of conducting the various steps in a legal proceeding other than the rules of evidence (q.v.) and the rules of pleading (q.v.).

The judicial proceeding may be directed toward the person, when it is said to be *in personam*; or it may be directed toward the property, when it is said to be *in rem*. See IN PERSONAM; IN REM; LAW.

In English jurisprudence three distinct systems of procedure corresponding and adapted to distinct systems of jurisprudence were developed respectively by the courts of common law, the courts of chancery, and the courts of admiralty. While necessarily having many elements in common, these systems for the most part differ widely from each other and their characteristics can be best understood by treating each separately.

COMMON-LAW PROCEDURE. The common-law procedure is much older than the procedure in either equity or admiralty as practiced by the English courts, the *curia regis* which was the forerunner of the English courts of Exchequer, Common Pleas, and King's Bench, in which the common-law procedure was developed, having

been established during the reign of Henry I. (1100-1135). The common-law procedure was early marked by extreme formality, and ultimately it became necessary to simplify the system by means of legislation, which has given to us the various forms of reformed common-law procedure in modern use and in many States of the United States. See CODE; LAW; EQUITY.

The first step in an action at common law was the issuing of the original writ on application of the plaintiff, which commanded the sheriff to summon the defendant to give to the plaintiff the relief demanded by him or to appear before the next term of court and show cause why such relief should not be granted. The effect of the original writ was twofold. It gave the court jurisdiction over the subject matter by authorizing it to proceed with all subsequent steps in the litigation. It also gave the court jurisdiction over the person of the defendant when the sheriff had executed the writ by serving it personally upon him. It could then issue its process or mandate compelling the attendance of the parties and witnesses, direct the filing of pleadings, summon and impanel a jury, and after trial and verdict enter judgment for the successful party and issue its execution or other mandate to the sheriff for the purpose of satisfying the judgment. Historically the original writ is also important, as from it the action took its form, since the plaintiff's pleading was required to conform to the allegations and demand for relief contained in the original writ. See FORMS OF ACTION.

The original writ having been issued and served upon the defendant, it then became his duty to appear in the proceeding and plead, and if necessary the court could compel his appearance by issuance of its process (q.v.) known as a judicial writ as distinguished from the original writ. The method of pleading and of trying the issues raised by the pleadings is fully considered under such titles as PLEADING; EVIDENCE; TRIAL; JURY; etc., to which reference should be made in connection with this subject.

During the course of the proceeding and after verdict, the parties to the action might apply to the court for various forms of relief incidental to the proper conduct of the proceeding. Thus upon application the court might use the subpoena to command the attendance of witnesses, and punish for contempt; and after verdict the unsuccessful party might make motions for a direction of the court in effect reversing or setting aside the verdict of the jury. Thus the unsuccessful party might move: (a) for a new trial on the ground that the judge had not properly instructed the jury or that he had admitted or excluded evidence contrary to law or because of newly discovered evidence; or (b) he might move in arrest of judgment on the ground that some error on the face of the record vitiated all the proceedings; or (c) if the verdict was for the defendant, the plaintiff might move for judgment *non obstante verdicto*—without regard to the verdict—on the ground that he was entitled to judgment on the face of the pleadings; or (d) for a repleader, i.e. allowing the parties to plead anew because they had framed issues upon some immaterial matter; or (e) for a *venire facias de novo*, that is, a judicial writ summoning a new jury because the jury at the trial in the action was guilty of some misconduct invalidating its verdict.

Upon denial of these motions judgment was then entered by the court, usually by signing of the judgment by a proper officer of the court, for the plaintiff (*quod recuperet*) or for the defendant (*nil capiat*) in accordance with the verdict. The successful party was then entitled to enforce the judgment by the writ of execution. (See EXECUTION; JUDGMENT; ATTACHMENT; ARREST; DEBTOR; etc.) If, however, the unsuccessful party deemed the judgment erroneous in law, he was at liberty to remove the entire record of the case to a higher court for review upon suing out a writ of error, which, like the original writ, was issued out of Chancery. See ERROR, WRIT OF.

Such in its barest outline was the method of procedure developed by the common-law courts. The material elements of the system, except possibly those of the system of pleading, remain unchanged, although there has been great modification of the minor details, chiefly in the direction of greater simplicity. The first of these changes was in the use of the original writ. By the use of a series of fictions the common-law courts came ultimately to dispense with the original writ as a means of acquiring jurisdiction, and the action was regularly begun by the issuance by the courts of law of their judicial process, the summons directly, instead of the original writ. In each of the United States there are now courts established by statute having general jurisdiction over actions and authorized to acquire jurisdiction over the person of litigants upon service of its summons or writ. The summons is still issued in the name of the court, but usually attorneys as officers of the court are authorized to issue the summons directly without application to the court. This is true also of many other forms of process, as, for example, subpoenas to appear and testify, and the writ of execution.

The various changes in the system of pleading, which are more substantial than any which have taken place in procedure proper, have been noted under that title, but the system of pleading has been indirectly modified by changes in procedure. Thus the remedy for formal defects, which was formerly by demurrer, is now by statute generally a motion to strike out immaterial matter or to make the pleading more definite and certain. A party may be required to define and limit the scope of his pleading by a motion for an order directing him to give a bill of particulars (q.v.) of his claim. There are also various forms of relief incidental to the proceeding which have been created anew or adopted from the equity practice by statute; as, for example, the examination of witnesses before trial or by commission, the practice of referring some part or all of the controversy to a referee having substantially the power of court, and the granting of various provisional remedies, such as attachment and arrest. The extent to which execution against the person requiring the arrest of a defendant for non-payment of a judgment may be used has been much limited by modern statute, but in many States the plaintiff is given a statutory right to examine the judgment debtor as to his resources and give an appropriate remedy by receiver or otherwise by which the application of moneys due to the judgment debtors to payment of the judgment may be compelled. The practice on appeal has also been simplified, mere notice of the appeal served upon the appellant's opponent being

all that is generally required to perfect the appeal.

Common-law courts also exercised jurisdiction *in personam* by what were known as the extraordinary writs—certiorari (q.v.), habeas corpus (q.v.), quo warranto (q.v.), and mandamus (q.v.).

For the procedure in criminal actions, see PROSECUTOR; PROSECUTION; INDICTMENT; JURY; GRAND JURY; PUNISHMENT, etc.

EQUITY PROCEDURE. Procedure in equity is much simpler than the procedure at common law. Its essential characteristics are based on the fact that the jurisdiction of equity is *in personam* and that the sole power of that court is to command things to be done, and not directly to transfer or otherwise affect the rights of litigants. The first step in a proceeding in equity was to file in the office of the clerk of the court the bill which is the plaintiff's first pleading. Inasmuch as a court of equity acts *in personam* only, it can deal adequately with a many-sided controversy. There was consequently no limit to the number of parties to the proceeding, whose interests might be as diverse as their number, provided they were all interested in the controversy, and they might be brought into the proceeding by a proper bill. Upon service of the subpoena, the plaintiff then became entitled to an answer, failing which he was entitled upon the default of the defendant to the relief asked by the bill, or he could apply to have an attachment issued compelling the defendant to answer. Upon a determination of the questions raised by the pleadings and at the trial, the court might then make its decree adjusting the rights of all parties and commanding them to carry out its directions. If a party refused to obey the decree or order and was willing to accept the punishment for contempt, the court of equity was powerless to execute its decrees; but in modern practice this contingency is avoided by statutes authorizing the court to appoint an officer of the court to do the act required by the decree to be performed by a party and with the same legal effect. See PLEADING; TRIAL; EQUITY.

At any stage of the proceeding, or even before service of process, the court may grant interlocutory or intermediate relief to prevent injury to the parties or the subject of the suit pending the litigation. This is usually in the form of an injunction (q.v.) or the appointment of a receiver (q.v.).

Equity procedure, when it has been maintained as a distinct system, as in the United States courts and in a few States, notably New Jersey, has undergone no substantial change; and when modification has been adopted, it has been usually accomplished by rules of court.

ADMIRALTY PROCEDURE. Procedure in admiralty was founded upon the civil law and corresponds in many particulars to the equity system. It was much more simple and expeditious than the procedure of the common-law courts. It was adapted to proceedings either *in rem* or *in personam*, and, indeed, both forms of remedy might be sought and obtained in a single proceeding.

The first step in an admiralty proceeding was the filing of the libel, which, like the bill in equity, was both the plaintiff's or libellant's first pleading and a petition to the admiralty court to issue its writ or process, which was executed by

an officer of the court by personally serving it upon the respondent in case the proceeding was *in personam*, or by taking possession of the property in case the proceeding was *in rem*. As in equity practice, the libellant might compel the defendant to give discovery (see PLEADING), by annexing interrogatories to his libel. If the respondent failed to appear the libel was taken *pro confesso* upon the default, and an appropriate decree was rendered. Upon the appearance of the respondent, he might either except to the libel or file his answer. The exception might be peremptory, when it was in substance like a demurrer to the substance of the libel; or it might be dilatory, when it was in effect like a demurrer to the form of the libel or a motion to strike out irrelevant or scandalous matter. The effect of the peremptory exception, if sustained, was the dismissal of the bill; otherwise the respondent was required to answer. In the case of dilatory exception, if sustained, the libellant was required to correct his libel by amendment so that it was formally correct, otherwise the respondent was required to answer. The answer might set up any matter of defense or an independent claim against the libellant, when the answer was called a cross libel. No attempt was made to reduce the matter in dispute to a single issue as in the pleadings at common law. As in equity, all evidence was usually taken before a commissioner or corresponding officer of the court and then submitted to the court; and, as in equity, the judgment of the court might be embodied in an interlocutory decree followed by a final decree.

Incidental relief might be granted during the progress of the litigation upon petition, if the application was *ex parte*, or by motion, when notice was given to the other litigants. Thus the court might authorize the sale of perishable goods and the appropriation of the proceeds as directed by the final decree, or it might authorize the return of property from the litigation upon the filing of a proper bond.

Admiralty procedure has undergone but slight modification; and that, as in equity, has been effected for the most part by rules of court.

CODES OF PROCEDURE. The embarrassment experienced as a consequence of the technical character of the common-law procedure led to various attempts at reform by legislation. The earliest of these was directed toward a simplification of the system of pleading, and has been referred to under that title. In 1848 the Legislature of New York adopted a civil code which was intended to be a complete codification of procedure both in law and equity. The New York code served as a model for similar legislation in many other States, while most of the remaining States, though nominally not code States, have so far revised their systems of procedure as to have systems substantially like the codes of procedure. Owing to the inherent difficulties in acceptably codifying a system so complex as the law of procedure, the codes have required frequent amendment and revision, despite which they are still found to have perpetuated many of the faults of the common-law system.

The following are some of the more important changes effected both by the codes and the various statutes enacted for the purpose of reforming procedure. All formal distinctions between the procedure at law and in equity have been abolished, and while the methods of trial in the one

case by a jury and in the other by the court have been preserved, the same court sits both as a court of law and a court of equity. Interlocutory or provisional remedies have been created by which in certain cases the plaintiff is enabled to procure a preliminary writ of attachment directed against the property or person of the defendant pending the litigation. Provision is also made for various motions to correct or amend the pleadings and for examination of witnesses and parties before trial; and the law relating to injunction and receivers is frequently regulated wholly by statute. Various provisions are also made to aid in the enforcement of judgments, usually by way of supplementary proceedings for examination of the judgment debtor and the appointment of receivers to collect sums due to him and apply them in satisfaction of the judgment.

As already suggested, most of the States have adopted codes of procedure or a reformed procedure substantially like the codes in which the law and equity system have been amalgamated and simplified as far as practicable.

Consult: Martin, *Civil Procedure at Common Law* (1899); Clark, *Science of Law and Law Making*; Daniell, *Pleading and Practice of the High Court of Chancery* (6th. Amer. ed., Boston, 1894); Shiras, *Equity Practice in the United States Circuit Courts* (2d ed., 1898); Henry, *Admiralty Jurisdiction and Procedure* (1885); Bishop, *The Law of Criminal Procedure* (4th ed., Boston, 1895); Elliot, *Criminal Procedure in England and Scotland* (London, 1878); Elliott, *Appellate Procedure* (1892); and the works referred to under such titles as COMMON LAW; EQUITY; CODE; ADMIRALTY; PLEADING; etc.

PROCESS (OF, *proces*, Fr. *procès*, from Lat. *processus*, a going forward, from *procedere*, to go forward). In law, a comprehensive term, including all mandates of a court, in either civil or criminal actions or proceedings, whether directed to an officer thereof, or to an individual. The term is also sometimes rather loosely employed to designate all the proceedings in an action or legal proceeding, and it is in this sense that it is used in the familiar phrase 'due process of law.' However, the word 'procedure' is a much better term for that purpose, as it includes many steps in an action which could not strictly be termed process, as, for example, the argument of a case. Process is usually issued in the name and under the seal of a court by an officer thereof, but in some States, where code practice prevails, certain processes, such as civil summons and subpoenas, may be issued in the name of the proper court, by an attorney in his capacity as an officer of the court. Under the common-law practice, 'original process' was the original writ by which the action was commenced, and 'mesne process' (q.v.) was that which was issued afterwards and during the progress of the action. Disobedience of process is contempt (q.v.) of court. See ACTION; PROCEDURE; SUMMONS; SUBPOENA.

In patent law, a process is a mode or manner of accomplishing a particular result by the application or combination of elements or natural forces. See PATENT LAW.

PROCESSIONAL (ML. *processionale*, from Lat. *processio*, procession, from *procedere*, to go forward). The service-book which contains the

prayers, hymns, and general ceremonial of the different processions in the Roman Catholic Church. The processional approved for common use is that of Rome, of which many editions have been published.

PROCESSION OF THE HOLY GHOST. A theological term used to describe the origin or proceeding of the third person of the blessed Trinity. In the early Church, controversies were concerned chiefly with the second person, and the question as to the origin of the Holy Spirit was not raised. In the form of the Niceno-Constantinopolitan creed used by the Greek Church it is said simply that the Holy Ghost "proceedeth from the Father." This was understood in the Latin Church to mean that, as the Son proceeds from the Father, so the Holy Ghost proceeds from both the Father and Son, and in the course of time the words "and from the Son" (*filioque*) were added in the churches of the West. The question has always been one of the chief contentions between the Latin and Greek churches. See FILIOQUE; GREEK CHURCH; REUNION OF CHRISTENDOM.

PROCH, *prôg*, HEINRICH (1809-78). An Austrian composer, born at Böhmisoh-Leipa. While studying law, he took lessons in music and on the violin, and finally gave up law for music. In 1837 he became kapellmeister at the Josephstädter Theater, and three years later was appointed to the Court opera, from which post he retired in 1870. In 1844 he produced a three-act opera, *Ring und Maske*, which was followed by several others. His song compositions, however, were more popular. Notable examples are *Von der Alpe tönt das Horn*, and *Ein Wanderbursch mit dem Stab in der Hand*. He was also highly regarded as a conductor.

PROCHEIN AMI, *prô-shân' à-mé'*. The old Norman-French law phrase for next friend. See NEXT FRIEND.

PROCIDA, *prô'chè-dá*. A small island off the west coast of Italy, situated between the island of Ischia and the mainland, north of the entrance to the Bay of Naples (Map: Italy, H 7). It is about a mile wide and 2 miles long, and of volcanic origin, but low and flat. Two semicircular bays on the south coast are the remains of submerged craters. The island is fertile and populous, having in 1901 a population of 13,964, engaged in vine and fruit culture and tunny fishery. The town of Procida on the east coast lies at the foot of a precipitous rock crowned by a castle. Its population is 3700.

PROCIDA, JOHN OF. A tragedy by James Sheridan Knowles (1840) founded on the history of an Italian physician, who in the Sicilian Vespers lost his only son, Fernando, and finally received the crown.

PROCLAMATION OF EMANCIPATION. See EMANCIPATION, PROCLAMATION OF.

PROCLUS (Lat., from Gk. Πρόκλος, *Proklos*) (A.D. 410-485). The last important teacher among the Greek Neo-Platonists. He was born at Constantinople, brought up at Xanthus in Lycia, and first trained in philosophy at Alexandria by the Aristotelian Olympiodorus. In Athens he was a disciple of the Neo-Platonists Plutarch and Syrianus, and about 450 he succeeded the latter in the chair of philosophy. Hence he received the name Diadochos, the 'Suc-

cessor.' Among his contemporaries he is said to have had the greatest influence because of his learning and piety. He is sometimes known as 'the Scholastic among Greek philosophers,' because of his having labored to collate, arrange, and reduce to a rigidly scientific system the mass of older philosophy which had come down to him. His teaching was a development of that of his master, Plotinus, but is still more mystical and difficult to understand, combining the most transcendental speculation with the common superstitions of his age. Certain features remind us strongly of Gnosticism, and his teaching on evil seems to have been the source of the doctrine of Dionysius Areopagita. He taught, like his predecessors, a primordial essence, an ineffable unity, from which, unlike Plotinus and Iamblichus, he believed a plurality of other unities to proceed. These returned to their source and issued again in an unending cycle of emanations, but each time with a less perfect result, so that the tendency of his philosophy was ultimately pessimistic. Among his works, of which there is as yet no complete edition, the most important are his commentaries to certain of Plato's dialogues and also his work on *Platonic Theology*. His *Philosophical and Theological Institutions* in 211 chapters is a compendium of the principles of Neo-Platonism. Important are his treatises on *Providence and Fate, Doubts About Providence, the Nature of Evil*, etc. His work in eighteen books against the Christians, mentioned by Suidas, has now been lost. He also produced certain encyclopædic works, including a commentary on Hesiod, Euclid, and Ptolemy, and a book *On the Sphere*. Certain hymns have also been preserved. Some of these writings are known to us only in translation. Among the partial editions of his works may be named: *Procli Opera*, edited by Cousin (6 vols., Paris, 1820-27; 2d ed. 1864); a commentary on Plato's *Parmenides*, ed. Stallbaum (Leipzig, 1839, 1848); on Plato's *Timæus*, ed. Schneider (Breslau, 1847); on Plato's *Republic*, ed. Schöll (Berlin, 1886); ed. Kroll (2 vols., Leipzig, 1899-1901). There are English translations of the *Philosophical and Mathematical Commentaries by Taylor* (2 vols., London, 1792); the *Platonic Theology*, and minor philosophical and theological treatises by the same (2 vols., London, 1816); and of the *Commentary on the Timæus* (2 vols., London, 1820). See Zeller, *Philosophie der Griechen* (3d ed., Leipzig, 1881).

PROCNE, prók'nè (Lat., from Gk. Πρόκνη, *Proknè*). In Greek legend, the wife of Tereus and the sister of Philomela (q.v.).

PROCONSUL (Lat., deputy consul). Originally a Roman magistrate not holding the consulship, who was invested with powers nearly approaching those of a consul, not, however, including Rome and its immediate vicinity. In early times the proconsul was an ex-consul who, on completing his term of office, received a continuation of the *imperium* in order to enable him to bring an unfinished campaign to a close. The duration of the office was one year. In the later period, when conquests had added foreign provinces to the Roman rule, the consuls, on giving up their position, received, as proconsuls, either the conduct of a war or the administration of a province. Occasionally the office of proconsul, with the government of a province, was conferred

on a person who had never held the consulship. In the reorganization of the Roman Empire, the administration of the provinces was divided between the Emperor and the senate, and the title proconsul was confined to the governors of senatorial provinces. Under Constantine parts of certain dioceses came to be governed by proconsuls.

PROCOPE, pró'kóp', CAFÉ. The first and most famous of Parisian cafés, situated opposite the Comédie Française when that theatre was opened in 1689, and still existing. Among its frequenters were Voltaire, Rousseau, Robespierre, Gambetta, and other famous men. A journal *Lo Procope*, published by the proprietor of the café, was founded in the seventeenth century to record the history of the café and its frequenters.

PROCOPIUS (Lat., from Gk. Προκόπιος, *Prokopios*). An eminent Byzantine historian. He was born at Caesarea, in Palestine, about the beginning of the sixth century, went to Constantinople when still a young man, and acquired there so high a reputation as a professor of rhetoric that Belisarius, in 527, appointed him his private secretary. Procopius accompanied the great warrior in all his important campaigns in Asia, Africa, and Italy, and appears to have displayed remarkable practical as well as literary talent, for we find him placed at the head both of the commissariat department and of the Byzantine navy. He returned to Constantinople shortly before 542, was highly honored by Justinian, and appointed prefect of the metropolis in 562. His death occurred, it is thought, about three years later. Procopius's principal works (all in Greek) are his *Historiæ*, in eight books (two on the Persian wars from 408 to 553; two on the wars with the Vandals, from 395 to 545; four on the Gothic wars, going down to 553); *Ctismata*, or six books on the buildings executed or restored by Justinian; and *Anecdota*, or *Historia Arcana* (which some have been unwilling to attribute to Procopius), a sort of *chronique scandaleuse* of the Court of Justinian. The most valuable of these productions is the first. Procopius is the principal authority for the reign of Justinian. His style is pure, vigorous, and flexible. The best edition of his complete works is that by Dindorf (3 vols., Bonn, 1833-38). There is an early English translation of the *Historiæ* by Holcroft (London, 1653). The section on the Gothic wars has been edited with an Italian translation by Comparetti (3 vols., Rome, 1895-98).

PROCOPIUS, ANDREW (c.1380-1434). A Hussite leader, known as Procopius the Great. He is also sometimes called the Holy, or the Shaven, in allusion to his having received the tonsure in early life. He studied in Prague, and after traveling for several years in foreign countries he returned to Bohemia and entered the ranks of the insurgent Hussites. His military genius soon raised him to the rank of an influential commander; and on the death of Ziska (q.v.), in 1424, Procopius was elected by the Taborites, who formed the radical section of the Hussites, as their leader. In the ensuing years he ravaged Austria, but in 1426 he vanquished the crusading armies of Central Germany at Aussig. In the meantime another body of Taborites, who called themselves Orphans, had overrun Lusatia, and burned Lauban, under the leadership of Procopius the Lesser, or Younger, who now, in

concert with the more distinguished Procopius, attacked Silesia, and took part in those internal feuds of the Hussite factions by which Bohemia was almost wholly ruined. From 1428 to 1430 Procopius directed raids against Hungary, Silesia, Saxony, Franconia, and other neighboring lands, which were successful and caused the Hussites to be dreaded. The Emperor Sigismund attempted to treat with him, but was unsuccessful, and in 1431 Procopius decisively defeated a German army at Tauss. In 1433 the moderate Hussites or Calixtines accepted the terms offered by the Catholic party. The Taborites and Orphans, under the leadership of Procopius the Great and Procopius the Lesser, refused, however, to have anything to do with the Pope, and hence dissensions arose between them and the more moderate of the Hussites. After many lesser encounters between these factions, a decisive battle was fought near Böhmissch-Brod, on May 30, 1434, in which both Procopius the Great and Procopius the Lesser were slain. Consult Creighton, *History of the Papacy* (6 vols., London, 1897). See HUSSITES.

PROCRUSTES, *prō-krūs'tēz* (Lat., from Gk. *Προκρούστης*, *Prokroustēs*, from *προκρούειν*, *prokrouein*, to beat out, stretch). The surname of a celebrated robber of Attica, named Damastes, or Polypemon. According to the ancient legend, he had two beds, one short, the other long. If a short traveler came to him, he placed him on the long bed and hammered him out to fit; tall visitors he placed on the short bed and cut down to the proper length. Other writers speak of but one bed. On his journey from Troezen to Attica Theseus killed Procrustes in the same way he had slain his victims.

PROCTER, ADELAIDE ANNE (1825-64). An English poet, the eldest daughter of Bryan Waller Procter. She was born in London. In 1853 she became a contributor of verses to *Household Words*, under the *nom de plume* of Mary Berwick, and attracted the attention of Charles Dickens, who did much in the way of introducing her contributions to the public. All excepting four of her poems were first published either in *Household Words* or *All the Year Round*. In 1858 her collected poems were published in two volumes under the title of *Legends and Lyrics, a Book of Verse*. A number of editions were subsequently published, new verses being supplied to several of them, and for the edition of 1866, the tenth, Charles Dickens supplied a memoir. Her verses are distinguished by their tender sympathy and ardent feeling.

PROCTER, BRYAN WALLER (1787-1874). An English poet, better known as BARRY CORNWALL. He was born at Leeds and was educated at Harrow, where he met Peel and Byron. He studied law with a solicitor at Calne, in Wiltshire, and settled in London, where he was admitted to the bar and practiced as conveyancer. Shortly after the death of his father (1816) Procter joined the circle of Leigh Hunt and Charles Lamb and married (1824) a stepdaughter of Basil Montagu. He was commissioner in lunacy from 1832 to 1861. Procter's principal publications were: *Dramatic Scenes and Other Poems*, prompted by Lamb (1819); *Marcian Colonna and Other Poems* (1820), *A Sicilian Story and Other Poems*, both inspired by Hunt (1820); *Mirandola*, a tragedy (1821), performed by Kemble at

Covent Garden; *The Flood of Thessaly* (1823), also inspired by Hunt; and *English Songs* (1832). To the last half of his life belongs his delightful *Charles Lamb*, a memoir (1866-68). His *Essays and Tales in Prose*, originally contributed to annuals, were collected in 1853. Procter wrote nearly three hundred songs on a wide range of theme. It may fairly be said that he restored to the English lyric its melody, such as it had among the Elizabethans. Well known are "The Sea," "A Petition to Time," "Life," "Song to his Wife," "A Lost Chord," and many others. Consult Patmore, *Life of B. W. Procter*, containing the fragment of an autobiography (London, 1877).

PROCTOR (abbreviated from OF. *procurator*, from Lat. *procurator*, manager, from *procurare*, to manage, from *pro*, before, for + *curare*, to care, from *cura*, care). In its legal sense, originally one of the body of men who had the exclusive privilege of appearing in the ecclesiastical and admiralty courts of England; now, any attorney who practices in either of these courts or in a probate court. The former proctors were admitted to practice only by a commission issued in the name of the Archbishop of Canterbury. A proctor might have an advocate do the actual pleading or trial work for him, but he alone could bring and conduct the proceedings in his own name.

On the transfer of the jurisdiction of the ecclesiastical courts over the probate of wills, the administration of estates, and matrimonial causes, to the probate and divorce divisions, the proctors practicing in the former courts were empowered to appear in all the courts of equity and common law in England. In 1877 the Solicitors Act provided that all solicitors should have power to practice as proctors on their admission without further examination. Upon the abolition of the old judicial system of England by the Judicature Acts (q.v.), the authority to practice in both the new courts was given to both proctors and solicitors. Therefore, in England to-day, the old legal distinction between proctors and other members of the bar has been abolished.

However, in both England and the United States the title proctor is still applied to practitioners in the surrogate, probate, and admiralty courts, merely as a matter of description, and without any special legal signification. See ATTORNEY; SOLICITOR; LAWYER.

By other uses of the term in England, it is applied to the representatives of the parochial clergy in convocation (q.v.), and to the officers charged with the maintenance of discipline among undergraduates in the universities of Oxford and Cambridge.

PROCTOR, REDFIELD (1831—). An American political leader and Cabinet officer. He was born in Proctorsville, Vt., and graduated at Dartmouth College in 1851, and from the Albany Law School in 1859. He served throughout the Civil War, rising from a lieutenantancy in the Third Vermont Volunteer Infantry to be colonel of the Fifteenth Vermont. After some practice of law, he devoted himself to his extensive quarry interests, in which he accumulated a large fortune. After several terms in the State Legislature he served from 1876 to 1878 as Lieutenant-Governor, and from 1878 to 1880 as Governor.

In 1889 he entered the Cabinet of President Harrison as Secretary of War, resigning in 1891 to accept an appointment as United States Senator. He was elected for a full term of six years in 1893, and was reelected in 1899. Early in 1898 he visited Cuba to inform himself as to conditions in the island, and on the information obtained by him, especially regarding Weyler's reconcentrado system, the McKinley Administration's decision to adopt a policy of intervention is said to have been largely based.

PROCTOR, RICHARD ANTHONY (1837-88). An English astronomer, born in Chelsea. He was educated at King's College, London, and at Cambridge. He devoted himself for some time to literary pursuits and wrote articles for the *Popular Science Review* and other magazines. He edited the *Proceedings of the Royal Astronomical Society* in 1872-73; constructed star charts and made researches into the transits of Venus in 1874. He visited America and lectured in 1873-74, 1875-76, 1881, and 1884, when he settled in Missouri. He removed to Florida in 1887, but was summoned on business to England in 1888. He died in New York on his way to England. He was one of the greatest popularizers of science. Among his works are *Saturn and His System* (1865); *Half Hours with the Telescope* (1868); *Other Worlds than Ours* (1870); *Transits of Venus* (1874); *A Treatise on the Cycloid*, etc. (1878); *The Romance of Astronomy* (1880); *Hereditary Traits* (1882); *The Great Pyramid* (1883); *Nature Studies* (1883).

PROCLUIANS. A school or sect of Roman jurists during the first two centuries of the Christian Era. Its origin was ascribed to Labeo, the most distinguished jurist of the Augustan age and head of one of the Roman law-schools, as the origin of the rival Sabinian sect was ascribed to Capito, head of another law-school. Each sect, however, took its name from a successor of its founder: the Procluians from Proculus, who was head, after the elder Nerva, of the law-school established by Labeo. Among the noted Procluians were the younger Nerva and Pegasus in the first century, the younger Celsus and Neratius in the second. Pomponius declares that Labeo was inclined to introduce innovations, while Capito was more conservative; but there is no evidence, in the recorded differences of opinion between the schools in the second century, of any such permanent line of division. See CIVIL LAW and SABINIANS; and for literature, consult Muirhead, *Historical Introduction to the Private Law of Rome* (2d ed., Edinburgh, 1899).

PROCURATOR-FISCAL. In Scotland, a public prosecutor, corresponding somewhat to the district or prosecuting attorneys in the United States.

PRODUCE EXCHANGE. See EXCHANGE.

PRODUCTION (Lat. *productio*, a lengthening, from *producere*, to lead forth, from *pro*, before, for + *ducere*, to lead). One of the divisions of political economy devoted mainly to the consideration of the factors which affect the amount of wealth produced. From the standpoint of production the measure of economic efficiency is the extent of the product. Human progress is measured, in the words of Carey, "by man's control over nature." The greater this control, the

larger the volume of products available for man's use, the higher is the scale of development. Political economy starts with the thesis that natural forces (land), human energy (labor), and accumulated wealth (capital) are united in production. The economics of production looks to the maximum result from this conjunction of forces. As land is not reproducible, progress is measured by the degree of utilization of natural forces for human ends. Labor in like manner in relation to production fulfills its function most effectively when it is most fully employed and when it is most efficient. From this standpoint such developments as extend the field of employment and all measures which promote the productive efficiency of the individual laborer and improve the organization of labor are steps in progress. Since capital becomes more efficient as it grows in volume, economics, from the standpoint of production, looks to the development of capital, and in particular is concerned with all that promotes saving the accumulation of capital for future use.

For a long time the ideas here set forth dominated the treatment of political economy. Consciously or unconsciously, its devotees felt that human welfare was bound up with the multiplication of products. Of late years a reaction has set in, the interest in economics as represented in later writers having shifted from the question of how to produce the largest quantity of goods to that of how under our present social organization these goods are to be distributed in the form of rent, interest, profits, and wages to those who share in the production of the goods. See CONSUMPTION; DISTRIBUTION; EXCHANGE; POLITICAL ECONOMY.

PRODUCTUS (Lat. *productus*, prolonged, led forward, p.p. of *producere*, to lead forward, produce). An important genus of fossil brachiopods found in Upper Devonian and especially in Carboniferous rocks. The shells are usually semi-circular in outline, with straight hinge-line, concave or flat dorsal and very convex ventral valve, both of which are often much produced anteriorly. The beak of the dorsal valve is depressed, while that of the ventral valve is very prominent and often projects far behind the hinge-line. The outer surface has radial or concentric wrinkles and the ventral valve has generally a number of long curved hollow spines by which the shell was anchored to the muddy or sandy bottom. The genus *Productus* is a well-known index fossil of the Carboniferous system. *Productus semireticulatus* of the Subcarboniferous limestone has been found in almost all parts of the world; it is perhaps the most widely distributed fossil mollusk known. Another species, *Productus horridus*, is characteristic of the coal measures. *Productus giganteus*, with a width of six to ten inches, is the largest brachiopod known. A number of allied genera of interest are: *Productella*, the Devonian ancestor of *Productus*, a less degenerate type with cardinal area and teeth; *Proboscidella*, a Carboniferous phylogerontic type in which the anterior portion of the ventral valve is much produced to form a sort of siphonal tube; *Strophalosia*, a degenerate type, found in the Devonian and Carboniferous, which by cementation of its ventral valve to foreign objects has lost its symmetry of form. Consult Hall and Clarke, "Introduction to the Study of the Genera of Palaeozoic

Brachiopoda." in *Palaeontology of New York*, vol. viii., part 1 (Albany, 1892).

PRO ECCLESIA ET PONTIFICE, prō ēk-klē'shi-ā ēt pōn-tif'i-sē (Lat., For Church and Pope). A Papal order instituted in 1888 by Pope Leo XIII. on the occasion of the jubilee commemorating the fiftieth anniversary of his entrance into the priesthood. The silver cross of the order bears the Papal arms surrounded by the motto *Pro Ecclesia et Pontifice*, with the date of foundation on the arms of the cross. On the reverse is a bust of Leo XIII. with comets on the arms of the cross. The order was founded originally for the donors and pilgrims to the jubilee, but is conferred in recognition of devotion to the Papacy.

PRÆTUS, prœ'tūs (Lat., from Gk. Πρωϊτος, *Proitos*). The son of Abas. He was expelled from Argos by his twin brother Acrisius, but with the assistance of Iobates of Lycia was restored to his kingdom. His three daughters were made mad by Dionysus or Iere and the contagion spread among the other women of Argos. They were cured by Melampus and Bias, between whom Prætus agreed to divide his kingdom. Bellerophon was charged by the wife of Prætus with improper proposals, and Prætus attempted to put him to death by means of a letter to Iobates. Perseus turned Prætus into stone through the sight of the Medusa head in revenge for his having expelled Acrisius from his kingdom.

PRÆTUS. A genus of trilobites, the species of which range through Ordovician to Carboniferous rocks, and are particularly common in the Devonian. They were small animals with a convex elliptical carapace, semicircular head, with prominent rounded labella and large eyes and distinct thickened margin. The thorax is made up of ten segments and its elevated axis is continued on to the semicircular marginate pygidium. See TRILOBITA.

PROFANITY. Contemptuous mention of or reviling of the name of God, His attributes, or religion. See BLASPHEMY.

PROFERT (Lat., he produces). Under the old common-law system of pleading, a statement or allegation in a declaration, that the plaintiff produces in court a deed or other instrument under seal on which he relies. See OYER.

PROFESSIONAL EDUCATION. The training that fits men for the special vocations in which science is applied to the practical purposes of life. It supposes as its basis the knowledge and discipline which general culture affords. The leading professional schools in the United States, following the example set by European universities, require a liberal education as a prerequisite for matriculation.

Professional education in Europe conforms to two general types: the centralized systems of France and Germany, and the more independent institutions of the British Isles. The French system since the Revolution has displayed at certain periods an extensive governmental control. This was confirmed by the Ferry legislation of 1879 and 1880 dealing with secondary and higher instruction, and relaxed somewhat by the act of 1896, which enlarges the powers of the universities and the responsibility of the communities in which they are situated. The bachelor's degree

is now required for entrance to State professional courses. Preparation for the professions is afforded by the faculties and schools of the State universities, and by the free (independent) faculties whose graduates must take the State examinations. There are 12 preparatory schools and 4 schools of full functions (*écoles de plein exercice*) teaching medical and pharmaceutical science, their students being examined for the doctorate by university faculties. In 1902 there were in the State institutions 127 students in Protestant theology, 10,472 in law, 8,417 in medicine, 3,346 in pharmacy. In private institutions there were 985 in law, 121 in medicine, and 15 in pharmacy. The course in Protestant theology covers three years; in law three years, there being added requirements in each for a doctorate; in medicine four, after which two years must be spent in hospital practice. Midwives are obliged to study for a year in an institution of medical instruction and undergo an examination. Diplomas are granted to foreign students, which confer the doctor's degree without conveying the right to follow a specified profession in France. The Government alone bestows degrees. With a few exceptions, the departments of France and Algiers maintain elementary primary normal schools for men and for women; some maintain superior primary normal schools; and Paris has two superior normal schools for men and for women teachers of secondary schools.

Professional training in Germany shows less than in France the influence of legislation and to a greater degree is built on the foundation of the early universities. The certificate of a gymnasium admits to professional courses. The 21 universities maintain faculties of theology, jurisprudence, and medicine, with the exception of Münster, which has no medical school. In 1902 the students of theology numbered 3926; of law, 11,335; of medicine, 7,341. The numerous pedagogic systems which German thought has produced have profoundly influenced the special preparation of the teacher and stimulated the development of teachers' training schools.

Professional education in Great Britain and Ireland is supplied by the universities of Oxford, Cambridge, Scotland's four university foundations, and the University of Dublin, and by a number of newer institutions, including London, Durham, and Victoria universities and the University of Wales. The Royal University of Ireland holds examinations in law and medicine. The Catholic University of Ireland comprises a medical school and several colleges in which theology is taught. A joint board appointed by the four Inns of Court in London examines candidates for admission to legal study in the Inns, and the Council of Legal Education, nominated by the Inns, superintends studies and examines students for the bar. There are numerous provincial medical schools. The preparation of teachers has enlisted much effort, denominational and undenominational; and many training colleges, for women as well as men, have been established.

In the United States there existed only two professional schools in 1776: the Medical College of Philadelphia (now the medical department of the University of Pennsylvania) and the medical department of King's (now Columbia) College, the former established in 1765, the latter

in 1768. Harvard University Medical School was established in 1782, and the Dartmouth Medical College in 1797. Theological instruction was obtained in the few colleges then existing, which were usually provided with chairs in Hebrew and theology. Private schools of divinity were not unknown; but the theological seminary proper was the product of a somewhat later day. The Seminary of the Reformed Dutch Church was established in 1784; Saint Mary's, in Baltimore, under the direction of the Society of Saint Sulpice, in 1791; and the Theological Seminary of the Associate Presbyterian Church

to education in husbandry and engineering, particularly the latter. In 1901 the departments of engineering and architecture in universities and colleges and the schools of technology reported students as follows: Mechanical engineering, 5623; civil engineering, 3532; electrical engineering, 2696; chemical engineering, 536; mining engineering, 1509; textile engineering, 234; architecture, 391.

The following table shows the respective ratios at the three periods between the numbers engaged in seven of the professions and the total population:

	Clergymen	Lawyers	Physicians	Dentists	Veterinarians	Engineers	Teachers
1860.....	837	947	576	5,608	80,212	1,145	284
1890.....	710	699	598	3,579	9,643	1,448	183
1900.....	680	663	575	2,563	9,303	808	173

of North America, at Service, Beaver county, Pa., 1794. The earliest law school in America was established at Litchfield, Conn., in 1784. The growth since the eighteenth century in the number, teaching force, equipment, endowment, and attendance of American professional schools has been remarkable. In 1901 there were 150 schools of theology, with 7567 students, 988 instructors, grounds and buildings worth \$15,217,164, endowments amounting to \$21,165,174, and libraries containing 1,531,038 volumes. The law schools numbered 100, having 13,642 students, 1106 instructors, grounds and buildings valued at \$1,875,000, endowment funds equal to \$1,151,920, and 338,167 volumes in their libraries. Schools of medicine numbered 154, having 26,757 students, 4752 instructors, grounds and buildings worth \$14,472,635, funds of the value of \$2,048,182, and 187,207 volumes. The 57 dental schools were attended by 8308 students, instruction was given by 1184 instructors, the value of grounds and buildings was \$1,213,122, and books numbered 6860. There were 58 schools of pharmacy, with 4429 students and 522 instructors. There were 12 veterinary schools, with 461 students, 189 instructors. Not less than 448 schools, connected with hospitals, with courses of two or three years, were engaged in the training of nurses, the number of whom under instruction was 11,599. In 1833 the first teachers' classes were formed in New York academies. The first American normal school was established at Lexington, Mass., in 1839. The number of public normal schools in 1901 was 170, with an attendance of 43,372. There were also 118 private normal schools, with an attendance of 20,030, while normal schools, universities, colleges, and high schools, aggregating 1461 institutions, were giving normal instruction to 94,157 students. That year 10,383 students graduated from normal schools. Delaware and Nevada are the only States without normal schools, and these make provision for the training of teachers. Engineering keeps step in development with the sciences of which it is an application and the material expansion which has called it forth. Provisions for instruction in the sciences which lead to the engineer's diploma have multiplied in an extraordinary degree in the last 40 years. The establishment of State colleges of agriculture and the mechanic arts in all the commonwealths under the Federal act of 1862 gave an impulse

The history of professional education is distinguished by the development of new professions, which for the most part have sprung out of the older professions by differentiation. Dentistry is an offshoot from the surgeon's art. Modern veterinary medicine may be said to have originated in attempts to apply the principles of pathology and therapeutics to treating the diseases of animals. In 1873 systematic training for nurses began in the Philadelphia Lying-in, Charity, and Nurse School, which opened in 1828. Medical practice has developed numerous specialties, such as the oculist's, the aurist's, the obstetrician's, besides the major division into physic and surgery. A comparatively recent division of medical practice is State medicine, which has to do with public restrictions for the protection of the general health. It should be noted that the profession of teaching is constantly subdividing; and in this movement a new educational function has been evolved, that of supervision and inspection, not yet recognized generally in special teaching courses, but accepted in all successful school systems. The decreasing proportion of men in the secondary schools of the United States is a fact which educators regard with interest and some concern.

Closely related to teaching is the new profession librarianship, already represented by four prominent schools, besides the departments of library science maintained in several universities. The New York State Library School receives only graduates of registered colleges, and the University of Illinois Library School limits admission to persons who have done three years of college work. The course in these two institutions is two years and leads to the degree of B.L.S. The four prominent schools have 36 instructors besides non-resident lecturers and 171 students. Accountancy is taking rank as a profession and is so recognized by statute in New York, Pennsylvania, Maryland, and California. The last few years have recorded the appearance of commercial courses in universities and academies, leading to diplomas and certificates as well as a title, certified public accountant (C.P.A.), which is protected by law.

Some of the States have exercised a potent influence by assisting in the rapid extension of the high school system, thus affording the means of a thorough preparation for the professional school. State universities maintaining profes-

sional and technical departments present still another form of State assistance. The United States Government has no jurisdiction over the practice of professions in the several States, but, owing to the efforts of the organizations in the several professions within the last thirty years, much has been done by State Legislatures toward protecting the public against incompetency. State supervision now extends to preliminary education, length of courses, degrees and the power to confer them, and entrance to practice, and is effected by means of registration, examination and license. By registration the status of schools and colleges and the value of their credentials receive State approval, and their graduates are admitted to examination for license. The tendency of special schools to become connected with some recognized university has also had a very salutary effect on professional education.

BIBLIOGRAPHY: Taylor and Parsons, *Professional Education in the United States* (Albany, 1900); Butler, *Monographs on Education in the United States* (Albany, 1900); *Reports of the U. S. Commissioner of Education* (Washington); Eliot, *Educational Reform* (New York, 1898); Harriman, "Educational Franchises," *Report of American Bar Association* (Philadelphia, 1898); Rogers, *Address Before National Educational Association* (Washington, 1897); Toner, "Contributions to the Annals of Medical Progress and Medical Education in the United States Before and During the War of Independence," in *U. S. Education Report* (Washington, 1874); Davis, "Contributions to the History of Medical Education and Medical Institutions in the United States of America," in *U. S. Education Report* (Washington, 1877); Shepard, "Inaugural Address," *Transactions of the World's Columbian Dental Congress* (Chicago, 1894); *Proceedings of the American Pharmaceutical Association* (Philadelphia, 1851 et seq.). See EDUCATION; TECHNICAL EDUCATION; LEGAL EDUCATION; MEDICAL EDUCATION; THEOLOGICAL EDUCATION.

PROFESSIONAL WOMEN'S LEAGUE, THE. An organization in New York City, incorporated in February, 1893. The aims of the League are to bring together women engaged in dramatic, musical, literary, artistic, and scientific pursuits for mutual help and encouragement, to assist them financially when in need, to provide class instruction in literature, art, language, music, and other studies at lowest possible rates, and to assist members to obtain outfits necessary to securing employment. Active membership in the League is confined to women engaged in dramatic, musical, or literary pursuits. The dues for active and associate members alike are \$5.50 per annum, and in addition each member, upon being admitted to membership, pledges herself to contribute two articles yearly which can be either sold in the bazaar, or utilized in the costume department.

PROFESSOR, THE. A novel by Charlotte Brontë (1856), written in 1846. William Crimsworth, the hero, is a professor in a school in Brussels, where he meets Frances Henri, whom he marries. Several characters in the story are among the best of Miss Brontë's work.

PROFESSOR AT THE BREAKFAST TABLE, THE. A series of sketches and verses

by Oliver Wendell Holmes, contributed to the *Atlantic Monthly* and published in 1860. The plan is the same as in *The Autocrat of the Breakfast Table*, but the tone is more serious.

PROFIT (OF., Fr. *profit*, from Lat. *profectus*, progress, increase, profit, from *proficere*, to advance, make progress, be advantageous, from *pro*, before, for + *facere*, to make). The excess in the selling price of goods above their cost of production. The term has been variously used, both in common speech and in economic writings, according to the conception of the elements entering into cost. Many of the earlier economists did not regard interest as a 'cost,' and hence included it under the term profit. The rent of land, however, though not regarded as an element in cost, has not usually been classed with profit, although the term 'agricultural profit' is not infrequently applied to it in popular writings.

Modern economists usually exclude from profit the normal or average return to capital, which is classed as interest (q.v.). Whatever an enterprise earns above interest, rent, and wages (including normal wages of management) is profit. If this net income is due to an artificial raising of prices through manipulation of supply, it is known as monopoly profit, or monopoly return. Various theories have been advanced to explain the nature and causes of non-monopolistic profit. The oldest of these is the 'risk theory,' defended by Von Thünen and many later German and some American writers. A business undertaker necessarily incurs a large number of risks which are of too indefinite a nature to be covered by insurance. Since the chance of losing a certain sum is not compensated for by an equal chance of gaining the same sum, no one would undertake the management of business unless it normally afforded a greater volume of gains than of losses. The net gain, in this view, constitutes profit.

A second view, represented by Francis A. Walker, regards profit as a differential gain, imputable to superior management. Prices, it is held, are fixed in the long run by the cost to the least efficient managers who are able to continue production. All managers of greater efficiency produce at lower cost, thus securing a surplus analogous to rent (q.v.). A third theory, not differing from this in essence, ascribes profit to the scarcity of managers of the better grades. This theory sometimes confuses simple profit with monopoly return, through failure to distinguish between scarcity and monopoly values.

Finally, profit has been explained with reference to the dynamic elements that prevent industry from reaching an equilibrium. In this view, which is in the main that of J. B. Clark, labor and capital tend toward a state of uniform productivity, but, owing to friction and to technical improvements, may at any moment vary considerably in productive power. Since the pay of each unit of labor or of capital tends to equal the product of the unit least advantageously situated, those units which happen to be on the more productive situations yield a surplus or profit which the entrepreneur secures for himself. It would appear that the theories given are not mutually exclusive, but merely describe different elements in a composite form of income now commonly termed profit. See INTEREST; MONOPOLY.

PROFIT À PRENDRE, or, in brief, **PROFIT**. A right to take profit, that is, something produced or yielded by the land, from the land of another, as the right to take coal, minerals, gravel, seaweed, grass, game, etc. The right can be acquired only by grant or prescription, and can not be acquired by custom. Although often classed as an easement, especially when attached to other land, it is to be distinguished from a proper easement in that it involves more than a mere use of the land. See **EASEMENT**, and consult authorities referred to there and under **PROPERTY**.

PROFIT SHARING. A modified form of the wages system by which wage-earners receive a part of the surplus of the industry according to some understood plan. Overseers receive salaries, capitalists interest, wage-earners wages, and what remains is divided among these classes, who all are responsible for success or failure. A part or all of the wage-earner's share may be given in cash; or it may be held in trust, invested in capital stock as savings to be used by them in cases of emergency; or it may be used as a social, educational, or amusement fund.

Profit sharing is based upon the principle that work done varies with the degree of interest felt by those who perform it. Profits may be increased by the wage-earner by increasing the quantity of the product, by improving its quality, by better care of implements, by a decreased loss of materials, by lessening superintendence, and by avoiding quarrels with employers. The extent to which profits may be increased varies also with the extent to which the wage-earner is made a sharer in profits, the form in which his share is increased, his intelligence, and the character of the industry. Profit sharing has been successful in many industries, and has sometimes failed where the methods employed were copied from those which had met with success. Upon the whole profit sharing has been most successful in handicrafts where there is a stable market for the products, and where the price paid for labor is a large part of the cost of production.

The origin of profit sharing is unknown. It is said that the American financier Albert Gallatin made a trial of it in his glass works, established at New Geneva, Pa., in 1794. John S. Vandeleur, a disciple of Robert Owen, in 1831 tried an extensive experiment in profit sharing on an estate in the County of Clare, Ireland. It was successful in stimulating the interests of the laborers to the great improvement of the estate and of their condition, until it was unfortunately terminated through the loss of Vandeleur's entire property in consequence of his passion for gambling.

The first notably successful profit-sharing enterprise was begun by Le Claire, a French house painter, in 1842. At the time of his death in 1872, \$220,000 had been distributed to workmen as their share of the profits. According to his plan, capitalists received 5 per cent. on capital invested, managers were paid salaries, wage-earners wages, and then from the profits remaining, one-fourth went to the capitalist class, one-fourth to a Mutual Aid Association of Workmen, and one-half went to wage-earners directly. Since Le Claire's death his business has been conducted on similar lines. At the present time the Association of Workmen receives 5 per cent. of interest on its capital as a half owner of the business,

and also about 20 per cent. additional to its wages, which are about as high as those paid for similar lines of work in Paris. Laroche Joubert, a paper manufacturer, adopted the system in 1843, and the Orleans Railroad Company in 1844. In 1847 J. H. von Thünen introduced the system on his estate near Zellow, in Mecklenburg-Schwerin, where his son and grandson, succeeding in turn to the proprietorship, continued it in force. In 1875 there were about seventy-five profit-sharing establishments in France, and in 1878 a society of the proprietors and directors of these was formed in Paris for a comparative study of methods. Shortly after a profit-sharing scheme was recommended for the State, departments, and communes. The municipal council of Paris devised a profit-sharing arrangement to be used by the city contractors, but it was never put in operation.

In the Bon Marché, the largest retail store in the world, a scheme of profit sharing and industrial coöperation prevails. Of the capital to the amount of 20,000,000 francs, 7,500,000 is held by employees; 6 per cent. is paid on capital. The profits shared assume four forms; the heads of departments to over a hundred, whether they have capital invested or not, participate in the profits according to the percentage of sales; the retiring fund draws about 5 per cent. of the profits; the provident fund takes another share, and what remains is then divided pro rata. Another successful experiment in profit sharing was begun by Godin, a stove manufacturer, at Guise, about 1872. In the first fifteen years \$650,000 were distributed to the workmen in dividends, and a considerable amount besides was invested in capital stock. In France more than one hundred such enterprises are managed with success at present. Elsewhere on the Continent there are comparatively few instances. In Germany the piece-work system with prizes seems to be preferred. There are, however, 47 instances; in Switzerland, 14; Austria-Hungary, 5; Belgium, 6; Holland, 7; Italy, 8; and but nine in Spain, Portugal, Scandinavia, and Russia. In Great Britain there are 95 instances, and in the United States 23.

Conspicuous examples of successful profit sharing in the United States are those of the Proctor & Gamble Co., of Ivorydale, Ohio, and the N. O. Nelson Manufacturing Company, of Saint Louis, Mo. The former company employs largely unskilled wage-earners, who receive comparatively low wages. During the year 1886 the work of the company was interfered with by many strikes, and in the following year profit sharing was introduced to establish harmonious relations with the employees. Reasonable salaries were allowed the active members of the firm, interest was allowed on the capital, and the net profits were divided between the firm and "the employees, in the proportion that the wages paid bore to the whole cost of production." Altogether the profits received by the wage-earners increased their income considerably, they were indifferent to the success of the enterprise until the company divided them into four groups based upon their interest in the work, its excellence, and the prevention of waste. The best group received twice the regular dividend, the second the regular, the third one-half the regular dividend, while the careless and indifferent received none at all. The wholesome influence of this discrimination was at once

seen in larger dividends. The stockholders did not profit directly by this scheme, but the better profited at the expense of the poorer workmen. When the firm became a stock company, in 1890, wage-earners were to receive a dividend of 12 per cent. on wages, which was the same as the profits on common stock. The number of employees receiving profits increased from 225 in 1887 to 550 in 1899, the latter number being 92 per cent. of the total number of wage-earners. Employees are encouraged to become owners of stock and 80 of them own 191 shares. Beginning with 1894, \$500 is set aside semi-annually as a pension fund, of which one-half is contributed by the company and the other half comes from the bonuses of the employees. Since the beginning of the experiment no strikes or labor difficulties have arisen. In 1894 the labor cost, including the 12 per cent. bonus to wage-earners, was only 63 per cent. of what it had been in 1886.

The N. O. Nelson Co., brass manufacturers of Saint Louis, Mo., began a profit-sharing enterprise in 1886. The company pays out all sums needed in cases of sickness and disability as they occur, as a part of the costs of the business. Allowances are made for funeral expenses, and upon the death of an employee his family is supported to the extent of two-thirds of his wages, until it is able to support itself. The crucial test of profit-sharing enterprises is given in periods of crises, when extra efforts of wage-earners are not rewarded by dividends. It is then that wage-earners lose interest in them, and the mortality rate of profit-sharing enterprises is high. For the first ten years, 1887-1897, the dividends to employees were large. In two years, 1893 and 1896, there were no dividends for employees. That no labor difficulties arose and that wage-earners did not lose interest in profit sharing, even though wages were reduced one-fourth, was due largely to the wisdom of the company. Salaries and interest were reduced to the same extent as wages, but the one-fourth thus deducted from these shares was to be paid out of future profits before any bonuses were to be paid. In each instance it was not long before the company was on a dividend-paying basis and profit sharing weathered the storm in safety. One other feature of the management of the N. O. Nelson Company shows how profit sharing may pave the way to industrial coöperation. In 1896 the company made a proposal to employees in the cabinet-making shop which provided for the gradual purchase and management of the enterprise by the employees. The proposal, at first rejected, with a few changes was soon after accepted, and at present this department is owned and managed exclusively by employees.

On January 1, 1903, the United States Steel Corporation announced a plan of profit sharing. Only those employees who hold positions of responsibility share directly in the profits of the corporation. If the net earnings for the year exceed \$80,000,000, but are less than \$90,000,000, one per cent. of such earnings is to be distributed among the employees, the share to be determined by the finance committee, so as to permit the fullest recognition of merit. With every \$10,000,000 increase in net earnings, the share to be distributed increases by $\frac{1}{2}$ per cent. of such increase of earnings. Employees of lower classes are given favorable opportunities for becoming owners of the corporation stocks. To further encourage the

holding of stocks, those who buy such stocks and remain in the service of the company are to receive at the end of five years a bonus of 5 per cent. annually on the face value of the stock held over and above the regular dividends, and the promise of a bonus at the end of another five years is given. A large number of the employees have already acquired stock. It is hoped that this plan will insure stability on the part of the mass of the workmen and the maximum of zeal on the part of the higher employees.

The recent record of profit sharing in the United States has not been such as would give encouragement to its ardent supporters. In 1889 there were thirty-four institutions in the United States, while there were but twenty-three ten years later, and of these twelve have been organized since 1899. Aside from these failures several others were attempted and soon after abandoned. A variety of causes contributed to the abandonment of these institutions during this period. The long period of the financial crisis went hard with all of them, and especially with those which had but recently attempted profit sharing. Changes in management were responsible for its abandonment in other cases. Impatience of success, and abandonment before a fair trial was given, was the situation in a number of other cases. To lack of seriousness in dealing with the matter and to unwisdom in management may be attributed still other failures.

That profit sharing is a scheme which will settle the great difficulties between labor and capital none but its most sanguine advocates would claim. But that it may be used in many enterprises to bring about harmony between the employer and the employee, to elevate workmen and to prepare the way for industrial coöperation, has been proved by experience in institutions which have passed beyond the experimental stage.

BIBLIOGRAPHY. Roberts, *La suppression des grèves par l'association aux bénéfices* (1870); Böhmerts, *Die Gewinnbetheiligung* (Leipzig, 1878; Paris, 1888); Taylor, Sedley, *Profit Sharing Between Capital and Labor* (London, 1884); Giddings, "Report on Profit Sharing," in *Nineteenth Annual Report of the Massachusetts Bureau of Statistics of Labor* (Boston, 1886); Gilman, *Profit Sharing* (Boston, 1889); *A Dividend to Labor* (Boston, 1899); Monroe, "Profit Sharing in the United States," in *American Journal of Sociology*, May, 1896.

PROGNO'SIS (Lat., from Gk. πρόγνωσις, foreknowledge, from προγινώσκειν, *proginōskein*, to know beforehand, from πρό, *pro*, before + γινώσκειν, *ginōskein*, to know). The opinion or decision of the physician as to the probable course and termination of a disease. As the case proceeds, the rapidity or severity of the symptoms, the condition of the circulation, ability to take food, the integrity of the nervous system, are points which influence the prognosis. The usual questions to be answered by a skillful prognosis are as to whether the disease will terminate in death or recovery; if in recovery, whether permanent damage to any organ will result; if in death, the probable duration of the disease.

PROGRAMME MUSIC (Lat. *programma*, from Gk. πρόγραμμα, edict, from προγράφειν, *prographēin*, to write before, from πρό, *pro*, before + γράφειν, *graphēin*, to write). A term in music applied to purely instrumental works which are

intended to reproduce by musical tones a series of definite ideas or events. The idea of reproducing characteristic sounds of nature by means of music is very old. We have a composition by Jannequin, *Cris de Paris*, published in 1529, in which are imitated the cries of Parisian fishmongers and venders of various commodities. In another, *La Bataille*, the same composer imitates the rattling of musketry, trumpet-signals, etc. In his "Pastoral Symphony" Beethoven reproduces the murmuring of the brook and the calls of various birds. Schubert in his famous song *Gretchen am Spinnrad* imitates admirably the hum and buzz of the spinning-wheel by the figure in the accompaniment. But Schumann went further; he gave some purely instrumental works (Carneval) suggestive titles. These instances do not in reality constitute programme music. This form began with Liszt, who wrote long orchestral works (symphonic poems) where every bar is meant to depict some definite emotion or event. He found his inspiration in works of poetry or the plastic arts. Thus *Die Hunnenschlaecht* is intended to reproduce in musical tones the impression aroused by Kaulbach's famous picture. In his Dante and Faust symphonies Liszt has taken certain episodes from Dante and Goethe, and he intends to say in music what the two poets have said in words. This school of programme music has had many followers and is still very powerful. (See STRAUSS, RICHARD.) Opinions differ as to the value of such music. In Schumann's sense Raff and Saint-Saëns, and even Schubert and Beethoven, have written programme music. But these masters never forced music beyond its natural limits. Wagner occupies a distinct position. In one sense his music is programme music, but it is dramatic, and always accompanies and illustrates the spoken word. And even in the purely instrumental passages, such as the Preludes, Siegfried's Rhine-Journey, Funeral March (*Götterdämmerung*), his method of leading motives enables the hearer to follow every bar in detail. Richard Strauss also has taken up this idea of leading motives and applied it to purely instrumental works (*Death and Apotheosis, Till Eulenspiegel, Ein Heldenleben*, etc.). See SYMPHONIC POEM; INSTRUMENTAL MUSIC.

PROGRESO, prô-grâ'sô. A seaport of Mexico, situated on the north coast of the Yucatan peninsula, 25 miles north of Mérida (Map: Mexico, O 7). It is the port of that city, and is connected with it by railroad. It is the principal port of the State of Yucatan, and one of the foremost ports of the Republic in regard to imports. Steamship lines connect the town with Vera Cruz and various ports of the United States. A United States consulate is located here. The chief export is sisal grass. Population, in 1895, 5911.

PROGRESS AND POVERTY. A work by Henry George. See GEORGE, HENRY.

PROGRESSION (Lat. *progressio*, from *pro-gredi*, to go forward, from *pro*, before, for + *gredi*, to go), or PROGRESSIVE EVOLUTION. Nägeli's principle of progression, or the transformation of species from internal causes. Long before Nägeli, Von Baer vaguely wrote of the striving toward an ideal in development. Nägeli and his commentator, R. Hertwig, claimed that it cannot be denied that each species is compelled, by some peculiar internal cause, to develop into new forms independently of the environment, and up to a

certain degree independently of the struggle for existence. In all the branches of the animal kingdom, says Hertwig, we observe a progress going on from lower to higher, very often in a quite similar way, in spite of the fact that the species live under very different conditions of development. To a certain extent, then, an organism is independent of the external world, but the independence is never complete, and Nägeli has not so contended.

PROGRESSION. In music, a term applied to the succession of entire chords or of the individual tones composing any part. The former is called *harmonic*, the latter *melodic* progression. The progression of dissonances is called resolution. See LEADING OF VOICES.

PROGRESSIONS (in mathematics). See SERIES.

PROGRESSIVE BROTHERS. See GERMAN BAPTIST BROTHERS.

PROHIBITION (Lat. *prohibitio*, a forbidding, prevention, from *prohibere*, to forbid, prevent, from *pro*, before, for + *habere*, to have). A form of sumptuary legislation which attempts to abolish the manufacture and sale of alcoholic liquors. Until after the Civil War the movement toward prohibitive legislation in America was merely local. By that time, however, a marked change was observed in the liquor business. German beer was introduced, great breweries were built, attractive saloons were fitted up, and other efforts were made to increase sales. One of the earliest State and national forms of prohibition forbade the sale of liquor to Indians. Some of the early laws enacted local option—which may be local prohibition—following Connecticut's (1839) example. Maine was the first State to establish prohibition. The West Indian trade brought large quantities of rum into the State, and in 1846 an educational campaign was carried on, which resulted in Neal Dow's law. This law was made effective in 1851 and was finally incorporated into the State Constitution. In 1852 Massachusetts, Rhode Island, and Vermont passed laws prohibiting the sale of liquor, which were subsequently repealed by the two former States. Massachusetts presents an excellent example of local option, each town voting to license or not to license the sale of alcoholic drinks. Kansas (1890) and North and South Dakota have constitutional prohibition. Iowa passed a constitutional amendment in 1882, which was declared void, and was superseded by a statute (1884). In 1894 the Mule Law took its place. Prohibitory constitutional amendments have been defeated in Texas, Oregon, Tennessee, Pennsylvania, Nebraska, and Massachusetts. New Hampshire's statute of 1855 was repealed in the spring of 1903 and local option was adopted. In the South, which is strongly for temperance, the States provide as a rule for local option by counties. For the dispensary system in South Carolina, see under that State.

PROHIBITION PARTY. The failure of the advocates of temperance to force a prohibition plank upon either of the great national parties led the Pennsylvania State Temperance Convention in February, 1867, to suggest the organization of a separate party. In 1868 a Prohibition Party was organized in Illinois and Michigan in response to a recommendation made on May 28th of that year by the Grand Lodge of the Good

Templars in session at Richmond, Ind. In May, 1869, the Grand Lodge recommended the calling of a national convention, and in September such a convention was held at Chicago and the National Prohibition Party was there organized. In the State elections of the next three years candidates were nominated by the party, but received relatively few votes. On February 22, 1872, the first National Convention met at Columbus, Ohio, nominated James Black of Pennsylvania and John Russell of Michigan as their candidates for President and Vice-President respectively, and adopted a platform which besides advocating prohibition declared for woman suffrage, a direct popular vote for President and Vice-President, a sound currency, the encouragement of immigration, and a reduction in transportation rates. In the ensuing election only 5,607 votes were cast for the party's candidates. In 1876 Green Clay Smith of Kentucky was nominated for President and G. T. Stewart of Ohio for Vice-President, but the ticket received only 9,787 votes. In 1880 the candidates for President and Vice-President, Neal Dow of Maine and H. A. Thompson of Ohio, received 9,678 votes. In 1884 Governor Saint John of Iowa was nominated on a platform which, ignoring other issues, declared only for temperance. He made an active campaign and received 150,626 votes. In 1888 the Prohibition candidates, Clinton B. Fisher of New Jersey and John A. Brooks of Missouri, received 249,954 votes, the platform in this year declaring for woman suffrage, uniform marriage and divorce laws, restriction of immigration, a tariff for revenue only, and civil-service reform. In 1892 the platform of the party, besides declaring for prohibition, advocated, among other things, woman suffrage, civil-service reform, anti-monopoly laws, currency reform, and restriction of immigration. In this year the party's candidates, John Bidwell of California and J. B. Cranfil of Texas, received 270,710 votes, the largest number so far recorded. A split in the party occurred in 1896. The party in the South was opposed to a woman's suffrage plank and the delegates were divided on the money question. Those who wished to confine the party to a single issue were in the majority, and their opponents left to form a Liberal Party, whose candidate, Bently, received only about 14,000 votes. The regular candidate (Levering) received 131,757 votes. Dr. S. C. Swallow, who represented the broad-gauge party in 1900, was defeated by John G. Woolley, the nominee of those advocating the single issue, who in the Presidential election received 207,368 votes. The party never had a purely national issue until 1900, when the question of the army canteen and liquor in the Philippines attracted attention. The party organ is *The Voice* (New York City), started September 25, 1884.

In a treaty of 1889 between the United States, Great Britain, and Germany prohibition for the Samoan Islands was established. Canada took a plebiscite on prohibition, September 29, 1898, on which occasion 278,487 votes were yeas and 264,571 nays. Since the majority vote was only 23 per cent. of the electorate, the Government has not felt called upon to initiate legislation. In England the United Kingdom Alliance to procure total and immediate legislation for the suppression of traffic in intoxicating liquors and beverages has worked actively for prohibition. The

question of compensation forms a financial barrier to the enactment of a law. In the United States the Supreme Court (December 5, 1887) decided that the Kansas law making no provision for compensation does not violate the Fourteenth Amendment. Prohibition has had no complete trial in the United States, because of the interstate commerce laws. The 'original package' case (*Bowman vs. Chicago and Northwestern R. R.*, 125 U. S. 465) stated that no prohibition States could prevent interstate railroads and express companies from carrying liquors to any point within the State. The conclusions indorsed by the Committee of Fifty, a voluntarily constituted group of distinguished men, who have long been engaged upon a thorough investigation, are: (1) That prohibition has abolished or prevented the manufacture of liquor on a large scale within certain areas; (2) that the suppression of retail trade is dependent upon local sentiment, and is more successful in the country than in the city; (3) that efforts to enforce the law lead to hypocrisy, bribery, corruption, and law-breaking.

Consult: Wheeler, *Prohibition: the Principles and the Party* (New York, 1889); *Cyclopædia of Temperance and Prohibition* (ib., 1891). See TEMPERANCE.

PROHIBITORY DUTIES. See **TARIFF.**

PROJECTILES (from *project*, OF. *projecter*, *projeter*, Fr. *projeter*, to project, from Lat. *pro-jectare*, to thrust forth, frequentative of *projicere*, to throw forward, from *pro*, before, for + *jacere*, to throw; connected with Gk. *βάπτειν*, *iaptein*, to throw). Objects thrown forward by an impulse of short duration. Projectiles have been a form of offensive weapon from the earliest days of warfare when a stone or similar missile was thrown from the hand or from some simple device. The development of guns (see **ARTILLERY**; **GUNS, NAVAL**) necessitated suitable forms of projectiles. The earliest were of stone, sometimes merely bags of round pebbles. The larger stone projectiles were made to fit the gun loosely and were generally, though not always, spherical and often very neatly and smoothly cut. A few stone elongated projectiles are known to have been used, but they were not common. Iron projectiles came into general use in Europe in the fifteenth century, though stone was used more or less for some centuries after this. The difficulty of tightly closing the breech caused the disuse of breech-loading cannon and prevented the early development of the heavy rifled gun. Rifled small arms (q.v.) using a spherical bullet have been in more or less use for three centuries. Smooth-bore guns almost invariably used spherical projectiles very slightly smaller than the bore of the gun, the difference being termed the *windage*.

The resistance to the movement of a projectile through the air is proportional to the cross-section perpendicular to the line of flight, and the power of the projectile to overcome the resistance is proportional to its weight multiplied by the square of the velocity. For a given velocity, therefore, we may say that the ratio of power of resistance varies roughly as $\frac{W}{D^2}$ where W is the weight and D the diameter expressed in the usual units. This is not strictly correct, for there are other factors (shape, den-

sity of atmosphere, etc.) which enter into a precise calculation, but the statement is approximately true and the expression $\frac{W}{D^2}$ is called the

ballistic coefficient. It is apparent by inspection that if we have means of increasing the weight without increasing the diameter (that is to say the area of cross-section) we shall increase the power of the projectile to overcome the resistance of the air and thereby add to its range and accuracy. The elongated projectile evidently fills the desired conditions and the advantages of its use are at once apparent. Robins published his treatise on Ordnance in 1742, and in it he stated very clearly the advantages of rifled guns and elongated projectiles (see GUNS, NAVAL), but his work was far beyond the comprehension of his contemporaries. (See PROJECTILES, MOTION OF, below.) The use of smooth-bore guns and spherical projectiles continued, and the next important improvement was the development of the shell gun. Incendiary shells designed to burst and scatter balls and fragments of the case had been in use for a long time, but up to 1820 these had very thin walls and were fired solely from mortars. In 1821 the Paixhans shell gun was designed in France, and thereafter explosive shells have formed the greater part of projectiles above a pound in weight.

About the middle of the nineteenth century the rifled gun established itself firmly. Difficulties in the breech mechanism caused some nations to develop muzzle-loading systems of construction, but this false step lasted nowhere more than twenty-five years. The projectiles for muzzle-loaders necessarily did not fit closely, and this decreased their accuracy. The revolution of an elongated projectile about its axis is necessary to keep the axis steady and prevent the projectile from 'tumbling' or pitching end over end, which would be fatal to power and accuracy. This was effected in muzzle-loaders by means of various rotating devices such as studs, ridges, expanding base rings or bands, or a bore of special cross-section such as that of a polygon or ellipse.

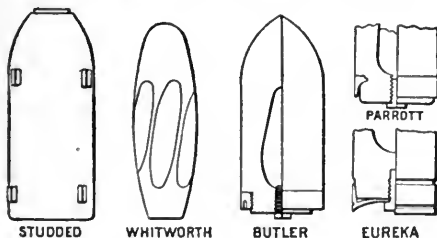

Muzzle-loading projectiles.

The difficulties connected with developing an effective breech mechanism were soon surmounted and modern projectiles quickly took on very nearly their present oblong shape. With breech-loaders the band could be made larger than the bore (being inserted from the rear) and forced in, the lands or grooves of the rifling cutting their way through the soft metal band. Projectiles for breech-loading rifles were first made of plain cast iron and wrought iron, but the advances in armor brought forth first the chilled cast-iron armor-piercing shot and shell, and then the steel shell. For a long time common shells not intended to pierce armor, were made of cast iron,

and some countries still use cast-iron common shell; but in the United States Navy all shells are of forged steel. The common shells have hardened points and are intended to pierce armor two-thirds of a calibre in thickness, while the

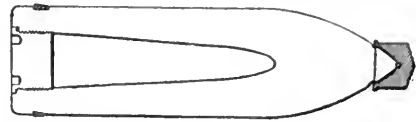

ARMOR-PIERCING PROJECTILE SHOWING STEEL CAP.

armor-piercing shells are designed to pass through any thickness through which they can be driven, not only without breaking up by the shock, but without deformation. Armor-piercing projectiles of a calibre exceeding six inches are not generally loaded, as their walls are so strong that gunpowder charges will not burst them. Several high explosives have been successfully employed for these shells, but none has been definitely adopted for shells of all calibres. (See EXPLOSIVES.) To further increase the penetrative power of armor-piercing shells, they are fitted with a soft steel cap over the point. This cap is cylindrical and about a quarter of the calibre of the shell in diameter, while its height on the outside is about equal to its diameter; inside, the point of the shell extends well up into it. When the projectile strikes a hard-faced armor plate the force of the blow, acting through the cap, slightly dishes the face of the plate and thus strains the metal; while under this strain the point of the projectile passes through the cap and easily ruptures the strained material.

In the United States and British navies shells are about $3\frac{1}{2}$ calibres in length, and their weight is approximately equal to one-half of the cube of the calibre (expressed in inches). In the United States Army guns, the weights of projectiles are about one-sixth greater.

In addition to the two kinds of shell mentioned, shrapnel are used in modern rifled guns, especially in the modern field guns, and in some pieces canister is occasionally employed. Shrapnel are shaped like shell, but have thinner walls and are filled with lead or iron balls from half an inch to an inch in diameter held in a resin

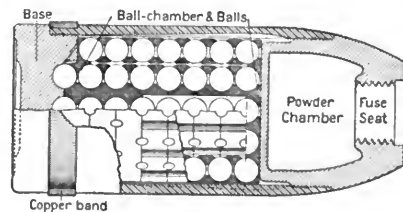

UNITED STATES ARMY 3.2-INCH SHRAPNEL.

matrix or by metal rings. A small bursting charge, located either at the front or rear, breaks up the case in the air and the balls scatter and fly onward, spreading out like shot from a shotgun. In canister the balls, larger than those in shrapnel, are sunk in soft-wood disks piled up to form a cylinder, and the whole covered with a tin case; or, in small calibres, the balls are simply packed in sawdust and enclosed in a cylindrical tin case with wooden ends.

In the days of smooth-bore guns many kinds of projectiles were used, as bar shot, chain shot,

grape shot, hot shot (these were heated in special ovens), shrapnel, canister. Grape shot consisted of iron balls piled around a central spindle rising from a disk which was nearly equal in diameter to the calibre of the gun. A ring of the same size as the disk rested over the outer parts of the balls of each layer, and the next layer above rested partly in the ring. While the rings kept the balls in position, they were additionally held by a canvas cover lashed down tightly over the balls. When the gun was fired, the balls broke loose, but the rings and canvas kept them somewhat together for a considerable distance from the muzzle.

To reduce the expense of target practice (q.v.), sub-calibre ammunition is greatly used. A smaller barrel is fitted in the bore of the gun and its own projectiles used in it. In the United States Navy, one-pounder guns are fitted in the breech of guns of five-inch calibre and larger—musket barrels being used in the smaller guns. To further decrease the cost of the practice, the shells are cheaply made and are *blind* (i.e. they have neither bursting charges nor fuses). See articles on AMMUNITION; ARMOR PLATE; ARTILLERY; EXPLOSIVES; FIELD ARTILLERY; GUNS, NAVAL; BALLISTICS; GUNNERY; ORDNANCE; etc.

BIBLIOGRAPHY. Consult: Cooke, *Text Book of Ordnance and Gunnery* (1878); Ingersoll, *Text Book on Ordnance and Gunnery* (Annapolis, 1899); Bruff, *Ordnance and Gunnery* (New York, 1900); *Proceedings of the United States Naval Institute* (professional notes on projectiles in every issue and numerous articles in different numbers); *Journal of United States Artillery* (Fort Monroe); *Annual Report of the Office of Naval Intelligence* (United States Navy).

PROJECTILES, MOTION OF. By this is understood the path followed by a particle of matter projected either obliquely upward, or horizontally from a height above the earth's surface. The problem of predicting this path was solved by Galileo, the solution depending upon the assumption that the horizontal velocity of projection of the particle is unaffected by the vertical force of gravity which produces a constant vertical acceleration g (approximately 980 on the C.G.S. system). If the particle is projected in an oblique direction upward, which makes the angle θ with the horizon, with a velocity V , it will have a horizontal component $V\cos\theta$, and a vertical one $V\sin\theta$. The former remains unaltered; the latter is subject to a *negative* acceleration g . The particle will continue to rise until the initial vertical velocity is decreased to zero. If t is the time of ascent $gt = V\sin\theta$ or $t = \frac{V\sin\theta}{g}$. In this time the particle will have gone horizontally a distance $V\cos\theta \times t$ or $\frac{V^2\cos\theta\sin\theta}{g} = \frac{1}{2}\frac{V^2\sin 2\theta}{g}$.

After the particle reaches its highest point, it will fall and will take the same time to reach the horizontal plane through its point of projection as it did to rise to the summit of its path. In the entire time, therefore, of rising and falling, the particle will move horizontally a distance $\frac{V^2\sin 2\theta}{g}$. Since the time taken to rise to its highest point was $\frac{V\sin\theta}{g}$ against an acceleration g , the height of this point is $\frac{1}{2}gt^2$, or

$\frac{1}{2}\frac{V^2\sin^2\theta}{g}$. For a given value of V , the greatest distance of horizontal motion, — $\frac{V^2\sin 2\theta}{g}$ is

when $\sin 2\theta$ has its greatest value, viz. 1; for this $2\theta = 90^\circ$, and hence $\theta = 45^\circ$. (This conclusion is seriously modified in practice by the resisting action of the air.)

The path of the particle may be deduced: if horizontal distances are called x , and vertical ones y , then at a time t after projection

$$\begin{aligned} x &= tV\cos\theta \\ y &= tV\sin\theta - \frac{1}{2}gt^2 \end{aligned}$$

If t is eliminated from these equations,

$2yV^2\cos^2\theta = xV^2\sin 2\theta - gx^2$, which is the equation of a parabola.

In the simplest case, when the point of projection is at a height above the surface of the earth, and the particle is projected horizontally with a velocity V ,

$x = Vt$, $y = -\frac{1}{2}gt^2$ where y is vertically down.

Eliminating t , these equations give $y = \frac{g}{2V^2}x^2$.

As a solid moves through the air, it meets opposition of various kinds due to the air. There is an opposing force which diminishes the linear speed. For speeds less than 100 feet per second the resistance of the air varies directly as the square of the velocity, as stated by Newton. According to Duhemin (1842), this resistance $= av^2 + bv^3$ for speeds below 1370 feet per second, and $= cv^4$ for higher speeds. In these expressions v is the speed of the projectile and a , b , c , are factors of proportionality. The first formula has been verified by the recent work of Dr. A. F. Zahm.

If the projectile is rotating on an axis, the angular speed is decreased, owing to friction; and owing to the unequal friction on the various sides, there is a sidewise force producing the 'curves' of a baseball and the 'drift' of a bullet. If the projectile is elongated or broad, the centre of pressure of the air against it and its centre of inertia are not in general in the line of motion; so there is a moment tending to make the projectile turn around an axis at right angles to the plane including the line of motion, the centre of pressure, and the centre of inertia. If the projectile is not rotating, it will turn so as to move with its broadest face front; e.g. a penny falling in water falls face down, not edge down; a sheet of cardboard falling through the air tries to fall face down. If, however, the projectile is rotating around an axis, e.g. an elongated bullet, the effect is to change the direction of the axis.

PROJECTION (Lat. *proiectio*, from *proicere*, to throw forward). The act or result of constructing a figure upon a given surface, usually by means of a pencil of rays, so that it corresponds point by point to another given figure. It thus includes perspective (q.v.), and is most simply illustrated by the shadow of an object thrown by a light on a wall, the shadow being the projection, and the light being the vertex of the pencil or sheaf of rays. If the centre of projection is infinitely distant the projection is called *parallel* projection; if also the projection rays are perpendicular to the plans of projection, we have *orthogonal* projection: The theory of projections is of great importance, both in mathematics and in geography, being in the former

case perfectly general in its application, while in the latter only the projection of the sphere is required. Projections of the sphere are of various kinds, all of which are treated under MAP.

In mathematics, the theory of projections has reached a high degree of perfection, serving to generalize the ancient geometry. (See GEOMETRY.) Its basis is the investigation and determination of those properties which, being true of a figure, are also true of its projections, such properties being necessarily dependent, not on the *magnitude*, but on the *position* of the lines and angles belonging to the figure. These properties are generally called *projective* properties. For instance, the three conic sections (q.v.), the parabola, ellipse, and hyperbola, are merely various projections of a circle on a plane, and all *positional* properties of the circle are at once, by this theory, connected with similar properties of the three conic sections. The introduction of coördinates has extended the applications of the subject, and it is now employed in solving the problems of applied mathematics.

For further information, see the references given under GEOMETRY. For the use of projection in mechanics, consult: Poisson, *Traité de mécanique* (2 vols., Paris, 1811); Klein, *Theorie der Kreisels* (2 vols., Leipzig, 1897-98); and Stade and Seidel, *Das Wichtigste aus dem geometrischen Zeichnen und der Projektionslehre* (Leipzig, 1894).

PROJECTIVE GEOMETRY. A geometry in which the properties and relations are investigated by means of the theory of projections. See GEOMETRY; PROJECTION.

PROKESCH-OSTEN, prō'kësh ôs'ten, ANTON, Count (1795-1876). An Austrian diplomat and author, born at Gratz. He entered the Austrian Army, served in the French campaign in 1813-15, was made professor in the military school of Olmütz (1816), and, after serving as adjutant to Prince Schwarzenberg (whose memoirs he published in 1822), was sent on diplomatic missions to the East. In Greece and Syria he was very successful, and for his services in bringing about the treaty of 1829 with the Pasha of Akka, whereby Christians were granted many privileges in Palestine, he was ennobled with the title of Von Osten (1830). In 1831 he was chief of staff in the Austrian army sent to Bologna, and he was Minister to Athens in 1834-49, and to Berlin, with the title of Ambassador, in 1849-52. He was ambassador to the Frankfurt Parliament in 1853-54 and from 1855 to 1871 represented Austria at Constantinople. He was made a baron in 1845 and a count in 1871. His more important works are *Erinnerungen aus Aegypten und Kleinasien* (1829-31) and *Geschichte des Abfalls der Griechen vom türkischen Reich* (1821).

PROLAPSUS ANI (Lat., falling of the anus). An affection of the terminal portion of the intestinal canal which consists in a protrusion of the mucous membrane of the lower part of the rectum through the anal orifice. When the protrusion includes the whole thickness of the rectal wall the condition is known as *prolapsus recti*. These conditions may depend on a naturally relaxed condition of the parts, such as exists in infancy, or they may be brought about by violent straining as in cases of costiveness, hæmorrhoids, and so on. Whenever prolapse occurs, the parts should be washed, and,

if possible, replaced by careful pressure with the fingers; and if they do not easily return, the forefinger should be oiled and pushed up into the anus, when it will convey the protruded intestine with it, after which the patient should maintain the recumbent posture for some hours. If the protrusion cannot be returned by the above means, surgical assistance should be at once sought. In order to obviate the tendency to prolapse the patient should regulate the bowels so as to avoid costiveness and should sponge the parts, after each evacuation, with cold water. A firm pad is sometimes required to prevent recurrence. Where the trouble persists it may be necessary for the surgeon to provide retraction of the redundant mucous membrane by removing portions of it either by the knife or the cautery. In cases of severe prolapse of the whole of the rectal coats it may be necessary for the surgeon to resect a portion of the rectal wall.

PROLAPSUS UTERI (Lat., falling of the womb). The condition in which the womb falls below its natural position in the pelvic cavity and approaches the outlet of the vagina. If the womb appears outside it is known as *proidentia*, or complete prolapse. Thus we have all degrees of prolapse from a very slight depression to a complete extrusion, and in its descent not only does the womb itself fall down, but it drags with it the vaginal walls, usually a part of the bladder, and less frequently the rectum. The prolapsed portion of the bladder is known as a *cystocele*, that of the rectum as *rectocele*. Prolapse of the uterus is a very common affection, occurring most frequently in women past middle age who have borne many children; but it is also found in unmarried women, and rarely in children. The causes are: (1) Relaxation of the ligaments that normally hold the uterus in place; (2) weakening of the support below due to a loss of tone in the tissues or to injury or laceration during labor; (3) an increase in weight in the uterus, either from congestion or disease; and finally (4) an increased pressure within the abdomen forcing the uterus down, as in straining from constipation. The symptoms of this affection arise partly from the pressure of the womb on other organs, partly from the simultaneous displacement of adjacent parts (as the bladder, rectum, etc.), and partly from reflex action. Patients with only a slight displacement usually complain of a sensation of fullness in the pelvis, of weight and bearing down, of dragging pain in the back, these symptoms being aggravated when the upright position is assumed. The treatment varies with the degree of displacement. In cases of complete prolapse the uterus should be replaced and retained in position if possible by mechanical means, such as tampons of cotton or pessaries or rings. In extreme cases removal of the entire organ may be necessary to afford relief. In cases of moderate severity great improvement is further secured by increasing the general tone of the tissues by tonics and constitutional treatment and by douches and other forms of local applications. The improvement in the general health is of great importance. In many instances an operation is necessary for the repair of the lacerated tissues at the pelvic outlet. Where neglected the condition has a tendency to become aggravated and rectal and bladder symptoms make themselves evident.

PROLÉTAIRES, prô'lâ'târ' (Fr. *prolétaire*, from Lat. *proletarius*, one of the lowest class of Roman citizens, regarded as of value to the State only on account of their offspring, from *proles*, progeny), or PROLETARIATE. That part of the wage-earning class who are entirely dependent on their daily labor for their livelihood. See SOCIALISM.

PROLOGUE (OF, Fr. *prologue*, from Lat. *prologus*, from Gk. *πρόλογος*, preface, introduction, from *πρό*, *pro*, before + *λόγος*, *logos*, speech, word, reason, ratio). In ancient Greek drama, that part of a play (whether an acted scene or an exclamatory speech) which came before the entrance of the chorus. Thus the prologue in the *Œdipus* of Sophocles is a scene in which appear *Œdipus*, the high priest of Zeus, and Creon, whereas the prologue to the *Agamemnon* of *Æschylus* is only the monologue of the watchman on the tower. From the time of Euripides the prologue became a speech explanatory of the situation to be developed, and it continued to be such in Latin comedy. With Plautus and Terence the prologue was divorced from the main body of the drama. In the early English drama the duties of setting forth the theme were shared by the induction, or prologue, and the chorus. When the induction was falling into decay the prologue or chorus supplied or assisted the argument. Their double employment is exemplified in *Hamlet* in the play scene. When the prologue enters, Hamlet says: "We shall know by this fellow; the players cannot keep counsel; they'll tell all." Hamlet explains to Ophelia the relationship of Lucinius and the King, and Ophelia responds, "You are as good as a chorus, my lord." In *Henry the Fifth* a prologue, called 'chorus,' precedes each act, to prepare the audience for the shifting scenes. For other plays Shakespeare wrote no prologue, but in the first scenes he both explained and developed the situation. After the Restoration (1660) a play was hardly complete without its prologue and epilogue. Even in Dryden's time the prologue served as a subject for literary wrangling as often almost as it served any dramatic purpose. Modern plays, save for quaintness' sake, never have a prologue. On the other hand, the playwright is bound to set forth in the first scene the problem or theme to be handled in his play. Thus we observe something like a steady degeneration of the prologue in proportion as the playwright begins more and more to make the main body of his drama a unit of thought and action. Consult G. S. B., *The Prologue and Epilogue in English Literature from Shakespeare to Dryden* (London, 1884). Taken over into oratory the word prologue is also applied to the opening of a speech. See EPILOGUE.

PRÖLSS, pröls, JOHANNES (1853—). A German novelist, son of Robert Pröls. He was born in Dresden, studied at Jena and Leipzig, was literary editor of the *Frankfurter Zeitung* (1880-89), and of the *Stuttgarter Union* (1890 sq.). He wrote some lyric poetry, a life of Schefffel, and a series of novels and sketches: *Emancipierte Novellen* (1880); *In der Alpen-schutzhütte* (1889); *Modelle* (1891); *Das junge Deutschland* (1892); and *Bilderstürmer!* (1895).

PRÖLSS, ROBERT (1821—). A German dramatist and historian of the drama. He was born in Dresden and was at first a merchant there, but

after 1863 gave himself up wholly to literature. In 1847 he wrote *Das Recht der Liebe*, a comedy. His later plays were the tragedies *Sophonisbe* (1862), *Michael Kohlhaas* (1863), and *Katharina Howard* (1865), and the comedies *Eine edle That* and *Die verdächtige Wahrheit*, after Alarcón. His critical and historical essays include: *Erläuterungen zu Shakespeares Dramen* (1874-89); *Das Meiningensche Hoftheater und die Bühnenreform* (1876); *Katechismus der Dramaturgie* (1877; 2d ed. 1899); versions of Marlow, Webster, and Massinger (1880); a life of Heine (1886); and *Kurzgefasste Geschichte der deutschen Schauspielkunst* (1900).

PROME, pröm. The capital of a district in Burma, British India, at the confluence of the Nawin with the Irrawaddy, 113 miles north-west of Pegu (Map: India, B 3). It was formerly surrounded by a brick wall, palisade, and ditch, about two miles in circuit. On account of the flatness of the ground on which it stands, the town is often inundated from the Irrawaddy. The principal thoroughfare is the Strand Road, from which a rectangular plan of streets diverges eastward. The chief native building is the Shwesandau Pagoda, 180 feet high, surrounded by 83 small gilded temples. It is visited by thousands of Buddhist pilgrims on the occasion of each annual festival in March. The European buildings include the Government offices, Law Courts, the Jubilee Clock Tower, and the Anglican Church; the public gardens and the markets are also notable features. The town has many advantages for trade. In the adjacent country are extensive gardens and rice grounds, and there are important manufactures of paper, silk, cotton, sugar, and gold lacquer ware. Population, in 1891, 30,202; in 1901, 27,375. Prome dates from before the Christian Era, when it was the capital of a powerful kingdom. The town was taken by the British in 1825 and in 1852. In 1856 it was almost wholly destroyed by fire.

PROMESSI SPOSI, prô-mäs'sé spö'zè, I. (It., The Betrothed). A novel by Alessandro Manzoni (1825) so admirable that it has become a classic and has been translated into all languages. The story, laid in Milan in the seventeenth century, tells of two peasants, Renzo and Lucia, betrothed but refused marriage by their parish priest, incited by the outlaw Don Rodrigo. After many adventures and suffering during a plague, the novel ends happily for the lovers.

PROMETHEA (Neo-Lat., from Lat. *Prometheus*, name of a giant). One of the commonest of the large North American silkworm moths (*Callosamia Promethea*). The female is reddish brown with white, black, and gray markings. The wings of the male differ both in shape and coloration from those of the female, and are blackish, with the markings characteristic of the female very faint or wholly absent. The fully grown larva is two inches or more in length, bluish green, and armed by large black tubercles in addition to four coral red ones in the thoracic region and one yellow one on the abdomen. The larvæ feed preferably on the wild cherry and ash, but are also found on a great variety of trees and shrubs. The cocoon is elongated and inclosed in a leaf, which is attached to a twig by strands of silk and is thus prevented from falling in the autumn. Although the cocoon resembles very closely that of

the ailanthus silkworm (larva of *Philosamia cynthia*), which has some slight market value, it has never been commercially used.

PROMETHEUS (Lat., from Gk. Προμηθεύς, from προμηθής, *promēthēs*, foresighted, from πρό, before + μήτις, *mētis*, wisdom; connected with μαθεῖν, *matheîn*, to learn; less probably connected with Skt. *pramantha*, fire-drill, from *pra*, before + *mantha*, churning, from *math*, to whirl, churn, produce fire by friction). The hero of one of the most interesting of the Greek myths. The story goes back to a very early period, and in its origin may be compared with the many similar legends as to the origin of fire, usually by a theft from the sun or the gods, or the beneficent gift of some kindly animal or great hero. In this character as the fire-bringing god (ὁ πυρφόρος θεός, *ho pyrphoros theos*) Prometheus had an altar in the Academy at Athens, where he was joined with Hephaestus and Athena, as those who had given to men the arts and crafts that brought civilization. He was honored with a special festival, of which the chief feature was a torch-race from his altar in the Academy to the city. In Hesiod Prometheus is a Titan, son of Iapetus and Clymene, brother of Atlas, Menotius, and Epimetheus. Angry at a trick played on him by Prometheus, Zeus deprived men of fire, but Prometheus stole it from the hearth of Zeus, hid it in the pith of a fennel-stalk, and conveyed it to earth. In punishment Zeus sent Pandora (q.v.) to Epimetheus and bestowed thus upon men the race of women "who dwell as a great plague among mortal men." Prometheus himself was fettered to a column, and visited daily by an eagle who devoured his liver, which always grew again during the night, so that his torment was unceasing till Hercules came, and by the goodwill of Zeus, who thus gave greater glory to his son, slew the eagle and freed Prometheus. In this version the Titan really works men harm in his efforts to overcome by trickery the high designs of Zeus. It should also be noted that the myth of Pandora seems to be originally a separate legend of the origin of suffering and woe, only later connected with the theft of fire. This primitive myth was reworked by the Athenian tragedian Æschylus in his Promethean trilogy, of which the *Prometheus Bound* has survived, and was brought more into harmony with the Athenian cult and the conceptions of a later time. Here Prometheus is the son of Themis (whom the poet identifies with Gæa, the earth), and through her possesses the gift of foreknowledge and prophecy. He thus foresees the ultimate triumph of intelligence over brute force in the struggle between Zeus and the Titans, and consequently joins the winning side. When, however, Zeus, as the establisher of a rule of law and order, plans to replace the wretched race of men by a nobler order of beings, Prometheus in pity defeats this design by stealing fire and instructing men in all the useful arts, so that there now exists no ground for Zeus to remove them from the earth. For this rebellion Hephaestus is required to nail Prometheus to a lonely cliff in Scythia near the ocean. Here the extant play shows him still defiant, execrating the ingratitude and cruelty of Zeus, who can thus punish an ally whose only fault is a desire to benefit mankind, and at the same time exulting in the secret knowledge that the violence of Zeus to his father, Cronos, unless atoned for, must be pun-

ished. His threats and defiance rise to such a pitch that Zeus casts him into Tartarus.

The play seems to represent Prometheus as a martyr and Zeus as a cruel tyrant, but closer examination shows that Zeus is bound to punish the rebel who has tried to overthrow the new reign of law. The later dramas of the trilogy seem to have made this conception clear. Zeus was reconciled to Cronos and the Titans, and Prometheus was brought to yield to the now secure Zeus. Hercules by the will of the god slew the eagle and freed the prisoner, in whose stead the centaur Chiron, suffering from an incurable wound, surrendered his immortality and descended to the regions of the dead. The closing drama seems to have related the establishment of the worship of Prometheus at Athens. In the later versions, especially on the sarcophagi, besides minor variations, we find Prometheus represented as the actual creator of men, whom he fashions out of clay, and at whose death he is sunk in sorrow and meditation. The whole myth in its origin and signification, and especially in its treatment by Æschylus, has been the subject of lengthy discussion and has produced an extensive literature, much of which is to be found in editions of the play. Consult: Welcker, *Die Æschyläische Trilogie Prometheus*, and *Nachtrag* (Darmstadt, 1824, 1826); Hermann, "De Æschyli Prometheo Soluto," in his *Opuscula*, vol. iv. (Leipzig, 1831); these two works developed a great controversy and have historical interest. Consult also: Wecklein's *Prometheus Bound of Æschylus*, trans. by F. D. Allen (Boston, 1891); Preller-Robert, *Griechische Mythologie I.* (Leipzig, 1887). The play has been translated by Mrs. Browning. On works of art see: O. Jahn, "Prométhée," in *Annali dell' Istituto* 19 (Rome, 1847), and "Ueber ein Sarcophagrelief im Museo Borbonico," in *Berichte der sächsischen Gesellschaft der Wissenschaften* (Leipzig, 1849); Milehhöfer, *Die Befreiung des Prometheus. Berliner Winckelmannsprogramm*, 42 (Berlin, 1882); Baumeister, *Denkmäler des klassischen Altertums, s.v. Prometheus* (Munich, 1889).

PROMETHEUS UNBOUND. A lyrical drama by Percy Bysshe Shelley (1820). Though founded on Æschylus's tragedy, it is not Greek in form or spirit. Prometheus, the type of humanity, bears his tortures even with resignation, till the secret is revealed, and Jupiter falls. The Spirit of the Hours announces the release of the hero, and all nature joins in the chorus of redemption. In this poem Shelley (stirred by the spirit of the French Revolution) exults in the deliverance of humanity.

PROMISE. See CONTRACT.

PROMISSORY NOTE (from Lat. *promissor*, promiser, from *promittere*, to promise, send forward, from *pro*, before, for + *mittere*, to send, Skt. *mir*, to push). A written instrument containing an express and unconditional promise by the maker to pay a certain sum in money, on demand, or at a fixed or determinable future time. If it is payable to order or to bearer, it is a negotiable instrument (q.v.). The following is an ordinary form of a negotiable promissory note, payable at a bank:

"\$1000.00. New York, April 1, 1903.
Three months after date I promise to pay to the order of Richard Roe One Thousand Dollars, at the Corn Exchange Bank.

Value received, with interest. JOHN DOE."

Had the words "at the Corn Exchange Bank," been omitted, the note would have been payable at the maker's place of business or residence.

It will be observed that the parties to a promissory note are two—the maker and the payee. If the payee is named, as in the form given above, and the note is payable to his order, his indorsement of it is necessary to its negotiation. He may sell and transfer it, without an indorsement; but his transferee in that case will take it subject to any defenses available to the maker against him. The maker promises absolutely to pay the paper. Hence the holder is not bound to present it at the time and place named in the instrument, as a condition of suing the maker.

The early history of promissory notes is quite obscure. Their earliest appearance in the reported decisions of English courts is during the close of the seventeenth and the opening of the eighteenth century. For a time the judges seemed disposed to follow mercantile usage and to treat them as negotiable instruments. With the accession of Lord Holt to the chief justiceship of the King's Bench, a change of judicial attitude became noticeable. He refused to recognize their negotiable character; and in 1704 Parliament, siding with the merchants, enacted a statute (3 and 4 Anne, c. ix.) which declared that promissory notes "shall have the same effect as inland bills of exchange." In some of the United States this statute has been looked upon as simply declaratory of the common law, while in others Lord Holt's view has been accepted. Everywhere, however, certain forms of promissory notes are now deemed negotiable instruments.

In some States certain forms of notes are declared negotiable by statute which are not negotiable in the common-law sense. For further discussion, and for the liability of indorsers, requirements as to presentation, etc., see such titles as BILL OF EXCHANGE; DUE BILL; NEGOTIABLE INSTRUMENTS; INDORSEMENT; PROTEST; DEMAND, etc. Consult: Bigelow, *The law of Bills, Notes, and Cheques* (2d ed., Boston, 1900), and the authorities referred to under NEGOTIABLE INSTRUMENTS.

PRO'MORPHOL'OGY (from Gk. *πρό*, *pro*, before + *μορφή*, *morphē*, form + *-λογία*, *-logia*, account, from *λέγειν*, *legein*, to say). The study of the simplest of the fundamental forms of organisms. While the simplest plants and animals as well as eggs and seeds are, as the result of the action of gravity, more or less spherical, in other types we are reminded of the forms of crystals, though there is wanting the mathematical regularity and symmetry present in crystalline forms. In the most symmetrical animals certain internal organs are unsymmetrical in relation to the body. See SYMMETRY.

PROMOTER (ML. *promoter*, from Lat. *promovere*, to promote, push forward, from *pro*, before, for + *movere*, to move, Skt. *miv*, to push). One who urges or assists in the organization of corporations or joint-stock companies. A promoter commonly makes the plans for the business operations to be carried on, estimates the possible profits, solicits subscriptions to the stock of the proposed corporation, and, in short, does all he can to bring about its organization. A promoter is held to stand in a fiduciary relation to the

prospective company. Accordingly, he is held to a very strict accountability as to his motives and as to any profits he may endeavor to make out of the proposed organization. Unless he discloses to the subscribers for stock the amount of profits he intends to make by effecting the organization, or by selling the company any lands or things of value, he must account to them for what he receives. If a promoter makes fraudulent misrepresentations as to the prospects of the intended corporation, any subscriber deceived thereby may cancel his subscription, and may recover any damages he may sustain from the promoter. If a person urges others to form a company and buy something he has to sell, and does not himself become identified with the organization, he is not a promoter in the above sense, and may obtain the best price he can induce the company to pay for his property. A corporation, when organized, is not liable for any 'contracts' entered into on its behalf by the promoter prior to its organization. It cannot ratify them, but may 'adopt' them, but this amounts to making a new contract. A promoter may sometimes be held personally liable on such contracts. See Thompson, *On Liability of Directors and Other Officers and Agents of Corporations* (Saint Louis, 1880); and consult the authorities referred to under AGENCY; CONTRACT; CORPORATION.

PROMOTION. See RANK AND COMMAND.

PRONA'OS (Lat., from Gk. *πρόναος*, porch before a temple, from *πρό*, *pro*, before + *ναός*, *naos*, temple). The vestibule in front of the *naos* or *cella* of a temple. It is commonly a portico formed by prolonging the side walls of the cella.

PRONGHORN. The goat-antelope (*Antilocapra Americana*) of the plains of Western North America, generally known as 'antelope,' and by



HEAD OF A PRONGHORN.

Showing the early change from hairy skin to horn at the tips of the young horns.

the Canadian French as 'cabree' (*cabrit*). It ranged from the Missouri River to the Pacific coast and from the Saskatchewan River to the interior of Mexico, most commonly on open plains or in broad valleys. It is not nearly as abundant now as formerly, but it is still plentiful in the less thickly settled parts of the West.

The pronghorn is about 4½ feet long and three feet high. It is yellowish-brown above and white below; there are brown and white markings on the head, and the white buttocks are said to gleam in the sun at a long distance. The shape of the body is deer-like, but more

robust; the head is carried erect, while the bounding gait and alert air are gazelle-like. (See Colored Plate of ANTELOPES.) The animal differs from the true antelopes and from all other ruminants in the total absence of 'false hoofs,' and in the remarkable nature of its horns, which are deciduous. The skull is surmounted by two spike-like horn-cores, rising over the great eye-orbit and leaning outward. These are covered with a skin and coat of bristly hairs which agglutinate at the tip and change into a compressed horny sheath, the change proceeding toward the



SKULL OF A PRONGHORN.
Showing horn-cores and dentition.

base until the whole is sheathed with horn. These stand about a foot in height, are curved inward, often so as to be truly lyrate, and—unlike any other sheath-horn known—are branched, having one prong (occasionally more) on the anterior edge. Every winter these horns are pushed off by new hairy growths beneath them, comparable to the 'velvet' of deer's antlers, which in turn harden into another pair of true horns. This distinction is deemed sufficient to justify placing the pronghorn in a separate family, the Antilocapridæ, intermediate between the giraffes and the Bovidæ. The horns of the female are rudimentary. The pronghorn is provided with several glands which secrete strong-smelling substances, especially during the rutting season. The most notable of these glands are just below the ear, one on each side. In summer the hair of the pronghorn is smooth and flexible, but as winter approaches it lengthens; each hair becomes thick, its interior becomes white and spongy, and it loses its flexibility, at last becoming brittle, so that its point is easily rubbed off. This singular fur forms a close and warm covering for the animal, but renders the skin useless as fur, nor does it make serviceable leather. The flesh, however, is delicious.

The pronghorn is confined to the open plains and thinly wooded parks and valleys of the Western mountains. It is suspicious and timid, and liable to panic, when it will dance up and down; but when once away goes at a leaping pace which few greyhounds can outstrip. Early in spring the does separate from the winter herd and in some retired spot bring forth usually two kids. The does and kids soon gather into bands for mutual assistance in resisting their foes, and in the early autumn they are joined by the bucks, whose horns are new, and who engage in fierce

contests for the possession of the does. In former days these bands numbered thousands, and those in the northern districts regularly migrated to the southward when snow came. At the beginning of the present century the pronghorns had been so reduced and scattered that no herds of great number could gather.

Consult: Caton, *Antelope and Deer of America* (New York, 1877); Lydekker, *Royal Natural History*, vol. ii. (London, 1895); Canfield, *Proceedings of the Zoological Society* (London, 1866); and books on sport in the Western United States and Canada.

PRONOUN (Lat. *pronomen*, word standing in place of a noun, from *pro*, for, before + *nomen*, name, word, noun). In grammar (q.v.), a word which stands for or instead of a noun (q.v.). While the noun is at first concrete, the pronoun is abstract, and thus represents psychologically a much higher concept than the noun. That it is of later development than the noun seems clear from its composite or suppletive inflection, being made up of a number of stems, still seen, for instance, in *I, me, we, us*. It had originally no connection with the noun, from which it differed in inflection and in usage. At a later period, however, the nominal and pronominal systems of inflection (q.v.) influenced each other, so that the pronoun shows a number of terminations which properly belong only to the noun, and vice versa. A careful distinction must be observed between pronouns with gender and those without gender. To the former class originally belonged only the pronouns of the first and second persons and the reflexive pronoun of the third person (represented, for instance, by German *ich, du, sich*). All other pronouns had gender, which was probably natural, not grammatical in character. (See GENDER.) These pronouns are demonstrative (as Sanskrit *sa*, Greek *ὁ*, Latin *ille*, 'that,' later 'the'), from which the modern pronouns of the third person are derived (compare English *he, she, it* with Anglo-Saxon *hē, hēo, hit*); relative (as Sanskrit *ya*, Greek *ὅς*, Latin *quis*, English *who*), which are more intimately connected with the interrogatives than the demonstratives; and the interrogatives (as Sanskrit *ka*, Greek *τις*, Latin *quis*, English *who*). Of these classes the demonstrative, which is local in force, is probably the oldest. The relative, which introduces the relatively late sentence-form of hypotaxis or subordinate clauses as contrasted with the more primitive parataxis or coordination, seems to be the youngest. Between the two, yet nearer to the demonstrative in point of age, stands the interrogative, which introduces a question. Consult: Zimmer, *Vergleichende Grammatik der semitischen Sprachen* (Berlin, 1898); Brugmann, *Vergleichende Grammatik der indogermanischen Sprachen*, vol. ii. (Strassburg, 1892).

PRONUNCIATION OF FOREIGN NAMES (Lat. *pronunciatio, pronuntiatio*, from *pronunciare, pronuntiare*, to pronounce, proclaim, from *pro*, before, for + *nuntiare*, to announce, from *nuntius*, messenger). The correct pronunciation of a proper name chiefly depends upon giving to the letters their correct value and to the syllables their correct degree of stress. Most of the sounds in the modern foreign languages are fairly well represented by the ordinary sounds of spoken English, but there are some that are so distinct that a reasonably correct pronunciation involves

a sound or sounds quite distinct from any represented by any single letter in the English alphabet, and in some cases sounds not heard at all in spoken English.

If the same alphabet with the same letter values were used in all the modern languages and the spelling were phonetic, the correct pronunciation of most foreign names would give little difficulty to a person speaking English; but the values of letters in those languages that use the Roman alphabet vary so greatly from the English values that in fact little can be told of the pronunciation of a foreign name from its spelling by any general rule, except that the vowels probably have the values given to them in Italian. In the case of those languages (as Russian, Turkish, Arabic, Greek, etc.) that use an alphabet differing from the Roman alphabet a new difficulty is involved in understanding the foreign letters, or, if the name occurs spelled in Roman letters, in ascertaining what system of transliteration is used.

Another difficulty is involved in the fact that the names of many foreign countries, cities, and persons have come into English use through the medium of a third language, as through French or German, in which case the spelling is influenced accordingly. In many other cases the spelling that has come into English represents an attempt made by some explorer or traveler to represent some native pronunciation heard by him, as in the case of a number of Chinese names. Owing to these and other difficulties, no general rule can be given for the pronunciation of proper names in all or any number of foreign languages; and in any given language, however phonetic its system of spelling may be, there are many names that present variations from general rules.

The following rules or principles, therefore, are intended to furnish only a general rule to aid in understanding the values of the letters that occur in the names of foreign languages using the Roman alphabet, or essentially that one, and to some extent transliterations from other languages, as the Russian and Greek. For the purposes of this article the best practicable method will be to explain the sounds mentioned by reference to the same sound in the English language or its nearest equivalent, the more accurate and scientific method of describing by the conformation of the mouth organs when uttering the sound being too technical for this place. See the explanation of Visible Speech in the article DEAF MUTE, and also consult the titles A, B, C, etc., in this Encyclopedia.

Loosely, it may be said that each vowel in the foreign languages has a pronounced value, except that in cases of doubled letters two vowels generally make a single syllable. The number of syllables in foreign words is, therefore, generally equal to the number of vowels. In the respelling for pronunciation used in this work the syllables are separated from each other by accents (' for primary stress, and ' for secondary), and hyphens (-), with the use of the apostrophe (') to indicate a lesser degree of separation between consonants than is made by a full vowel constituting a distinct syllable, as in the glides (obscured transitional sounds) and catches (certain spasmodic interruptions of the breath). Every letter in a respelled pronunciation is to be given its value as indicated in

the key to pronunciation. In many cases in English words and names no pronunciation is indicated, either because the pronunciation has already been shown in a preceding word, or because its proper pronunciation seems too evident to need to be indicated. In some cases where the pronunciation of a word is sufficiently indicated by marking the accented syllable, the vocabulary title has been accented without respelling. In such cases it is assumed that the values of the letters are known or evident. In some foreign words, also, only the accented syllable is shown in the same way, in which cases the letters are to be given the values that they would naturally have in an English word spelt in the same way.

ACCENT. In nearly all languages words are pronounced with an accent, or distinguishing stress, upon one syllable or more. In most of the modern languages of civilized races this accent is essentially like that of English, especially in the Teutonic languages; but in none of the languages is the accent thrown upon the accented syllables so much to the exclusion of the others as is done in English. The unaccented syllables in foreign names, therefore, are generally more distinctly pronounced than in English, the vowels retaining the quality of the long accented vowels, but being cut off more quickly in utterance. Conversely the long or accented vowels in foreign names do not usually have the glides that often give the English its drawled effect to foreign ears. In speaking foreign names, therefore, care should always be taken to pronounce distinctly syllables not marked as indistinct or slurred in the respelling, and, on the other hand, not to prolong unduly the vowels of accented syllables.

There are few cases where any general rules of accentuation can be given that are not subject to numerous exceptions. Some, however, are sufficiently general to be of considerable aid in determining the proper pronunciation of foreign names.

In *Arabic* the stress is on the last long syllable, i.e. one having a long vowel, or a short vowel followed by a consonant, except that a final long vowel does not take the accent. If there be no long syllable the first syllable is accented. In *Bohemian (Czech)* the accent is on the first syllable. In *French* there is generally no strong accent, and by some it is said that there is no accent. Probably the best opinion, however, is that there is an accent on the last syllable of importance in conveying the meaning of the word, which in proper names would, naturally, be practically always the last syllable. In accordance with this the heavy accent has been uniformly placed upon the last syllable in giving the pronunciation of French names in this Encyclopedia. The accents printed as a part of French words do not relate to the spoken accent or stress. In *German* the accent is so generally in accordance with the principles of English accent that the sense of the reader may generally be trusted to get it right. In modern *Greek* the stress follows the written accent, and is not governed by the quantity of the vowels. In *Hungarian* the spoken accent is always on the first syllable, and graphic accents are used only to indicate long vowels, whose length is due to prolongation without added stress of voice. In *Italian* most names have the spoken accent on

the penult, or last syllable but one. In names from Latin having a short penult in the Latin the accent is usually on the antepenult in Italian. A graphic or printed accent on a word usually denotes the spoken accent, except when the acute accent occurs over the vowel *i* in the terminations *ia*, *io*, and in a few cases where an accent is used to distinguish words spelt alike, but having different meanings. In *Polish* the accent is usually on the penult. In *Portuguese* the accent is generally upon the last syllable, except in case of names ending in a vowel, when it is mostly on the penult. In *Russian* no rule exists that is sufficiently general to be worth stating. The accent must be determined in each case by itself. In *Spanish* the accent is generally on the penult in words ending in a vowel or in the consonant *n* or *s*, and in other cases it is usually on the last syllable. A graphic accent indicates stress, or spoken accent; and when a final syllable ending in a vowel or in *n* or *s* is accented, the best present usage (that of the Academy) is to place a graphic accent on that syllable, and in like manner when a word terminating in a consonant other than *n* or *s* has the accent on the penult that syllable bears the graphic accent. In *Turkish* the last syllable is generally lightly accented. In *Welsh* the accent is on the penult, except in a few cases where it is on the final syllable.

THE LETTERS—VOWELS AND CONSONANTS. It is impossible within the scope of this article to make any attempt at a complete statement of the values of the letters and their combinations, even in the languages of the modern civilized races. The following alphabetic list is intended only to afford a clue to answer those questions that are likely to be looked up in a general work of this character. The statements refer, of course, only to the modern foreign languages that use the Roman alphabet, except as otherwise noted above.

A generally has the value of *a* in English *far*, *bath*, *fast*, or sometimes one approaching the sound of *a* in English *cat*; in Hungarian *a* is nearly *o* in *hot*, and *á* as *a* in *far*; short *a* in Sanskrit and in many East Indian names is as *u* in *but*; *a* in French is nearly as *a* in *far*.

Á in Rumanian is as *i* in *tin*; in French nearly as *a* in *far*.

Ǽ or **Æ**. See **Æ**, below.

Ȧ in Rumanian resembles *e* in *her*.

Ȧ in Polish is like *a* in *fall* nasalized. See **X** below.

Ȧ in Portuguese. See **AM** below.

Ȧ in Swedish is like *a* in *all*, or sometimes resembling *o* in *obey*.

AA in Danish and Norwegian is like *a* in *all*, or sometimes resembling *o* in *obey*; in Dutch equals older **Æ**. See **Æ**, below.

Æ. In German *a e* (or *ä*) is nearly as *a* in *fate* or in *scute*, or as *e* in *set*; in Dutch *ae* (now spelt *aa*), and in Flemish *ae*, is like *a* in *far*; in Swedish *a e* (or *ä*) is like *e* in *set* or in *there*; in Danish and Norwegian *ae* is often like *a* in *sat*; in Welsh *ae* is somewhat like *i* in *ice*.

Ǽ in Portuguese is like *i* in *ice*, nasalized, or pronounced through the nose.

AI or **AJ** (when *j* is a vowel) is in most cases a proper diphthong, essentially like the sound of *aye*, 'yes.' It is often best represented by a 'long *i*' (*i* in this work). In French *ai* is nearly

as *a* in *fate*; in modern Greek as *e* in *set* or *a* in *senate*; in Hungarian *aj* is as *oi* in *boil*, and *aj* nearly as the sound of *aye*.

AIL, **ILL**, **AIM**, **AIN**, in French. See **IL**, **ILL**, etc., below. **AJ**. See **AI**, above.

AM, **AN**, in French and Portuguese, when final or preceding a consonant other than *m* or *n*, have the sound of *a* in *far*, nasalized. (See **X**, below.) In French *em* and *en*, and in Portuguese *ã*, have the same sound.

ÃO in Portuguese is as *ou* in *house*, nasalized.

AU generally is like *ou* in *house*. In French it is like *o* in *no*; in modern Greek (*au*), like *ar*, except before surd or mute consonants, when it is like *af*.

ÄU in German is like *oi* in *boil*.

AV in Danish is usually like **AU** (see above) before a consonant.

AW in Welsh is like *ou* in *house*.

AY is generally like **AL**. (See above.) When it precedes a vowel, however, the *y* is often treated as a consonant, as in French and Spanish, and the preceding *a* given its proper value.

B at the end of a word, and generally when followed by a consonant, is pronounced like *p* in German, Dutch, and the Slavic languages. In Spanish and modern Greek its sound is like *v* made with the lips alone, and not with the lips and teeth. It is often interchanged with *r*.

BH in East Indian names. See **H**, below.

c before *e*, *i*, or *y* in German is like *ts* (Ger. *z*); in French, Portuguese, and Catalan, like *s*; before *e* and *i* in Italian it is like *ch* in *church*; in (Castilian) Spanish, like *th* in *thin*, but in Spanish America and parts of Spain like *s* in *sun*; in Rumanian before *i* it is like *k*; in Welsh and Gaelic it is always like *k*; in the Slavic languages it is like *ts*.

ç is like *s* in *set*.

č in Bohemian, Croatian, Servian, and Bulgarian is like *ch* in *chin*.

ć in Polish is like *ch* in *chin*.

cc in Italian is like *t-ch*, as in *chit-chat*.

CH in Spanish, and generally in Sanskrit and East Indian names, is pronounced as in *chin*; in Italian and Catalan, like *k*; in German, with the same guttural sounds as *g* (see **G** below); in Polish, with a similar guttural sound; in French and in Portuguese, like *sh* in *shin* (except in some classical derivatives).

cs in Hungarian is as *ch* in *chin*.

cu in Spanish when followed by a vowel is like *qu* in *quick*, unless the *u* has the dieresis (*ü*) or is accented (*ú*).

cz in Polish is like *ch* in *chin*; in Hungarian, like *ts*.

D in German, Dutch, and the Slavic languages (Russian, Polish, etc.), when final, and generally when preceding a surd in the same syllable, is pronounced as *t*; in Spanish, modern Greek, and Danish when between two vowels or final it has a softened sound, usually stated to be like *h* in *then*; in Danish and Norwegian it is silent or mute after an *l* or *n* in the same syllable.

dd in Welsh is like *th* in *then*.

DH in East Indian names. See **H**, below.

DT is like *t* in *bit*.

DZ is like *j* in *jet*.

E is generally equivalent, or nearly so, to *a* in *savior* or *a* in *create*, to *e* in *set*, or to *e* in *there*. In most foreign words the long

sound of *e* does not have the glide that is heard in *â* in English, as in *day*; and care should be taken not to pronounce *â* with this glide when that character is used in the respelling of foreign words in this book. In indicating the pronunciation of French, the character *â* is used both for the short and long quantity of this sound.

In French final *e* unaccented is silent, and it is usually silent or is much obscured when it ends a syllable other than the last. It is also nearly silent in Portuguese when final. In Russian *e* is like *ye* in *yet* when it follows *d*, *t*, *l*, or *n*, or when it is at the beginning of a syllable. In modern Greek it has the values of *e* in *pet* and of *i* in *machine*.

É in French is like *a* in *savior*.

Ê and Ë in French are like *a* in *cerate* or *e* in *there*.

E in Polish is like *e* in *pet*, nasalized. See *N*, below.

É in Bohemian is like *ye* in *yet*.

EAU in French is like *o* in *no*. See *AU*, above.

EEUW in Dutch is like *a* in *fate* followed closely by (Dutch *ie*. See *w*, below. When the *w* is followed by an obscure *e* the *w* has a more consonantal sound.

EI in French is like *a* in *cerate*; in German, Dutch, and Welsh, like *i* in *ride*; and elsewhere it is generally a proper diphthong like *ay* in *fay*.

EIN in French = *IN*, below.

EN in French = *AN*, above; in Portuguese it is like *a* in *cerate*, nasalized. See *N*, below.

EU in French and Dutch is nearly *e* in *her*, and equivalent to *ö*, below; in German, like *oi* in *boil*; in modern Greek (representing *eu*), like *ev* before a vowel or sonant consonant, and like *ef* before a surd. EU is otherwise generally a diphthong composed of the sounds *â* and *œ*, more or less closely united.

G is as *g* in *go*, *get*, in all the European languages before *a*, *o*, or *u*; and also in German whenever initial or followed by a vowel or liquid in the same syllable; in Swedish before *â*, or final after a vowel, or before *e* or *i* when short (except in *ge*); in Polish, before *e* and *i*; in Hungarian always, except in *gy*. (See below.) Before *e*, *i*, or *y* in French (see *GE*, below), Spanish, Portuguese, Rumanian, and Swedish (also in Swedish before *â* or *ö* or after *l* or *r* at the end of a primitive word or syllable), it is equivalent to *j* (see *J*, below) in the same language; in modern Greek it is like *y* in *yes*. Before *e* or *i* in Italian it is like *j* in *jet*. In Dutch *g* regularly has the voiced sound of the German *ch* or final *g*. In German *g* also has a guttural sound, made between the back of the tongue and the soft palate, which may be voiced, as when medial after back vowels (*a*, *o*, *u*), or unvoiced, as when final after *a*, *o*, or *u*; and a fricative sound made between the hard palate and the tongue, which may be similarly voiced, as when medial after front vowels (*e*, *i*, *ö*, or *ü*), or unvoiced, as when final after *e*, *i*, *ö*, *ü*, or a consonant. (See the *Key to Pronunciation*). German *ch* is pronounced like *g* in these positions.

GI is like *g* in *game* in Italian and Rumanian; in Irish it is like *h*, more or less strongly aspirated.

GLI in Italian when followed by a vowel has the sound of *lli* in *million*; if no vowel follows, the usual sound of *i* (Italian) is also added.

GX in French and Italian is like *ni* in *union*. See *Ñ* and *NI*, below.

GU before *e*, *i*, or *y* is like *g* in *go* in French, unless followed by a consonant or *ê*, when the *u* has its usual value; likewise in Spanish, unless the dieresis is put upon the *u* (*ü*), when the *gu* is as *gw* in *Gwilt*, as it is also before *a*, *o*, or *u*; and in Portuguese. In Italian *gu* is like *gw* in *Gwilt* before all vowels.

GY in Hungarian has the value of *d* followed by consonant *y*.

II in French, Italian, Spanish, and Portuguese is silent, or nearly so, except as it is considered in the various combinations *ch*, *gh*, *lh*, *nh*, etc.; in German it is silent between two vowels in the same word, except when followed by *ei*; in East Indian words it is generally pronounced like *h* in *hat*, distinctly heard in all situations, as after *b*, *d*, *t*, etc.; final *h* is often pronounced in Arabic and Persian names, properly with a harshly aspirated sound not heard in English; in Swedish *h* is silent before *j*.

I is usually like *i* in *pique* or *i* in *hit*; and sometimes like *e* in *set*, as in *-ling*, *-ding*, in Danish names.

IE is like *ie* in *field* always when final in French, and when medial in German, and before *r* in Dutch; and often when final in German.

IEN in French is as *IN* (see below) preceded by consonant *y*.

IJ in Dutch is nearly as *i* in *ride*.

IL final and ILL medial in French are as *y* in *yet*, strongly pronounced when following a pronounced vowel, and elsewhere as *i* in *pique* followed by the *y* sound. Formerly the *l* was also heard, as in Eng. *million*, and this pronunciation is still adhered to by some.

IM, IN, in French is *a* as in *bat*, nasalized. See *N*, below.

J in German, Dutch (see *IJ*, above), Italian, Swedish, Norwegian, Danish, Hungarian, and Polish is like *y* in *yet*; in French, Portuguese, and Rumanian it is like *z* in *azure*; in Spanish, like a rough or strongly aspirated *h* (see *X* below); in the Philippine Islands it is often like *sh* in *shun*.

K in Swedish before *e*, *i*, *y*, *â*, or *ö* in the same primitive syllable is almost like *ch* in *church*.

KII in Oriental names is usually properly a harsh guttural aspirate; in Russian names, often like German *ch*; in East Indian names, like separate *k* and *h*. See *I*, above.

L in French is as in English *like*, except after *i* (see *IL*, *ILL*, above); in Polish it is like *LL* in Spanish. See below.

L in Polish resembles *l* in *like*, very strongly pronounced.

LII in Portuguese is like *LL* in Spanish. See below.

LL in Spanish is like the *l-y* sound heard in Eng. *million*. In colonial or dialectic Spanish the *l* sound is sometimes not heard. In Icelandic *ll* is like *dl* in *handlike*; in Welsh, as nearly as can be given in English equivalents, like *ihl* or *tl*.

LY in Hungarian is like Spanish *LL*. See above.

M and N are practically always as in English, except when used as a velar *n*, the *ng* sound following an ordinary nasalized vowel, or used merely to indicate by checking the escape of air through the mouth and forcing it strongly against the soft palate.

\tilde{n} in Spanish, ξ in Polish, and ξ in Bohemian, Bulgarian, Croatian, and Servian are like *ni* in *union*.

ng in German is always like *ng* in *singer*.

nh in Portuguese is like Spanish \tilde{n} . See above.

ny in Hungarian is like Spanish \tilde{n} . See above.

o is usually like *o* in *note*, *obey*, or *for*; but it frequently shades away from these sounds toward those of *o* in *not*, *a* in *far*, *a* in *cast*; but these variations, unless very pronounced, may be sufficiently well represented as the δ (see *Key to Pronunciation*) more or less slurred or clipped in pronunciation. *O* in Swedish has the sound of $\delta\delta$ in *boot* or *u* in *full* when final or constituting a syllable, and also in the syllables *-nord*, *-port* when final.

\acute{o} in Polish is as *u* in *rude* or in *full*.

\ddot{o} (or sometimes *oe*) has no equivalent in English, but resembles *e* in *her*, and is the same as French *eu*.

\hat{o} in French is as *o* in *no*.

o in Portuguese is *o* as in *no*, nasalized. See *M*, above.

OE is sometimes used for \ddot{o} (above), with the same value; in Dutch it is as *u* in *rude*, *full*; in Low German names, like *o* in *note*; in Welsh, somewhat like *oi* in *boil*.

\hat{oe} in Portuguese is like *oi* in *oil*, nasalized. See *M*, above.

\acute{eu} in French is like *EU* (above).

oi is usually nearly like *oi* in *boil*; but in French is regularly nearly like *wa* in *watch*; in modern Greek like *i* in *pique*.

oix in French is French *ix* (above) preceded by English *ic*.

oo is usually *o* as in *no*, *oh*.

ou in French and modern Greek is like *u* in *rude*, *full*; in Dutch and Norwegian like *ou* in *mouse*; in Portuguese, nearly as *o* in *no*.

ouw in Dutch is nearly as *ou* in *mouse*.

ow in Low German names is as *o* in *no*.

r is as in English.

qu in French always, and in Spanish and Portuguese before *e* or *i*, has the sound of *k*; in German it is like *kv*. Otherwise it is usually equal to *kw*, as in Spanish and Portuguese before *a*, *o*, or *u*, in Italian in all situations, etc.

qv in Swedish is equal to *kv*.

R is usually pronounced with much more trill than it has in English. A gutturalized *r* is also heard, as in some pronunciations of French and German, that has no equivalent in English.

\tilde{r} in Bohemian is like *r* followed by the sound of *z* in *azure*.

RZ in Polish is like the sound of *z* in *azure*.

s has the sound of *z* in *zinc*, or nearly so, in German when before a vowel and not preceded by a surd or liquid; in French, when between two vowels or when carried over to the following word. It has the sound of *sh* in *shine* in Hungarian; in Portuguese, when final or before a surd (except *s*); in German, before *p* or *t* (although the sound of *s* is also supported by good usage). It has the sound of *zh* (*z* in *azure*) in Portuguese before a sonant consonant. In Italian *s* before a vowel is sometimes like *s* and sometimes like *z*, depending on usage. Otherwise than as above noted, *s* is usually like *s* in *sin*, as always in Spanish, Dutch, and Swedish.

ξ in Bohemian, Bulgarian, Croatian, and Servian is like *sh* in *shun*.

s in Rumanian is like *sh* in *shun*; ξ is like *sh* followed by *t*, before *e* or *i*.

sc in Italian before *e* and *i* is like *sh* in *shun*.

sch in German is like *sh* in *shun*; in Italian and Rumanian, before *e* or *i*, like *sk* in *skin*; in Dutch before vowels, except obscure *e*, like *sg* (see below), otherwise like *s*.

sg in Dutch is *s* followed by the guttural *g* of Dutch, resembling *sk* in English.

sj in Dutch, Swedish, and Danish is like *sh* in *shun*.

sk is like *sh* in *shun* in Swedish and Norwegian before *e*, *i*, or *y*.

skj in Swedish and Norwegian is nearly as *sh* in *shun*.

ss in Hungarian is a strong *sh* in *shun*; but elsewhere usually indicates a surd *s*, single or doubled, as in German, Dutch, etc.; in Italian it is sometimes equal to *ss*, sometimes to *zz*.

ssz in Hungarian is a prolonged *s* sound.

stj in Swedish is nearly as *sh* in *shun*.

sz in Hungarian is as *s* in *sin*; in Polish as *sh* in *shun*.

T after *n* in modern Greek is as *d*.

τ in Rumanian is as *ts* in *pits*.

th in modern Greek (θ), Welsh, and Icelandic is like *th* in *thin*; otherwise like *t*, or *th* in *thyme*, in all the modern European languages.

tscu in German is as *ch* in *church*.

ty in Hungarian. See *Y*, below.

tz is as *ts* in *pits*.

U is usually as in *rule* (\ddot{u}) or *put* (\ddot{u}). In French and in open syllables in Dutch it sounds somewhat like *u* in *put*. The correct sound may be approximated by attempting to pronounce \ddot{e} with the lips in the position for pronouncing \ddot{o} . In Welsh *u* is like *i* in *machine*; in Rumanian it is usually silent when final.

\ddot{u} (sometimes printed *ue* in German and Turkish) is like *u* in French. See above.

UE, except when representing \ddot{u} , usually combines the sound of *u* and *e*, more or less closely joined in pronunciation.

UI in French is much like Eng. *ice* (but see *GU*, *QU*, above); in Dutch nearly as *oi* in *boil*.

UM, *UN*, in French are nearly as *e* in *her*, nasalized; in Portuguese as Portuguese *u*, nasalized. See *M*, above.

UU in Dutch is Dutch *u* prolonged.

UY in French is like *UI* (see above), except before a vowel, when it is like *UI* followed by *y* as in *you*.

v in German, Dutch, and the Slavic languages (Russian, Polish, etc.) is as *f* in *fin* when final in a word, or (usually) in a corresponding part of a compound; otherwise as *r* in *vine*.

w in German, Swedish, Norwegian, and Polish is like *v* in *vine*; in Dutch it is like a *w* made without rounding the lips; in Welsh it is usually as \ddot{o} in *food*.

x in modern Spanish is usually as *x* in *fox*; sometimes it is as *j* or *g*. (See *G*, above.) In colonial Spanish, especially Mexican, and in some dialects in Spain, it often is as *s* in *sin*. In Portuguese *x* has the sound of *sh* in English.

z is as *ts* in *hats* in German; in Swedish, Danish, and Norwegian, like *s* (see above); in Spanish like *th* in *thin*, but in American Spanish and in some dialects in Spain like *s* in *sin*; in Italian like *ts*, or *dz* (as in English *adze*) or sometimes nearly as the English *z*; in Portuguese, when final, like *sh* in *shun*. Otherwise it is

usually as *z* in *zinc*, as in Dutch, Polish, Hungarian, etc.

y is generally like *i* in *machine*. In Danish, Swedish, and Norwegian it is like French *u*; *ym* and *yn* in French are like *im* and *in*.

ż in Polish is as *z* in *azure*.

ž in Bohemian, Bulgarian, Croatian, and Serbian is like *z* in *azure*, or, when final, like *sh* in *ship*.

ź in Polish is a softened *z*, much like *z* (*zh*).

zs in Hungarian is like *z* in *azure*.

PRONY, *prô'ne*, GASPARD CLAIR FRANÇOIS MARIE RICHE, Baron de (1755-1839). A French engineer and mathematician, born at Chamelet and educated in the Ecole des Ponts et Chaussées. In 1785 he was put in charge of the restoration of the harbor of Dunkirk, and in 1794, after the completion of his great tables of logarithms to twenty-five decimal places, the first made under the metric system, he was named professor of mathematics at the Polytechnique. Four years afterwards he was appointed head of the Ecole des Ponts. Prony held office through the Empire and was connected with the great sanitary measures undertaken in the Pontine Marshes and along the valley of the Po. His more important works include: *Nouvelle architecture hydraulique* (1790-96); *Cours de mécanique* (1815); *Description des marais Pontins* (1823); and *Notice sur les grandes tables logarithmiques* (1824).

PRONYMPH (from Lat. *pro-*, before + *nympha*, Gk. *νύμφη*, *nymphē*, bride, nymph). A stage of development with certain dipterous insects which transform within the last larval skin. This last skin having hardened and contracted, the insect within it loses all apparent structure and becomes an accumulation of soft, creamy matter within a delicate membrane. This condition begins in the resting larva, and the surrounding membrane is probably the larval hypodermis. In this pronymph the organs gradually take shape until a true pupa, corresponding to that of a hymenopterous insect, is formed.

PROOF (OF. *proce*, *preuve*, Fr. *preuve*, from Lat. *proba*, proof, from *probare*, to test, examine). In the mechanical arts, a trial copy or impression. Thus, in the art of die-sinking, the impressions taken from the die from time to time as it is brought to a state of approximate completion are called proofs, as their purpose is to guide the artist. They are, of course, struck in metal of no great intrinsic value except in the case of the last state of the die, or what is expected to be the last, when a proof will be taken in the metal intended to be used. As, however, museums and private collectors compete with one another eagerly for the proof copies of coins, and still more eagerly for proofs of important medallions, it is not unusual to take a number of such impressions from the completed die. These are sometimes marked as proofs by having a peculiar characteristic. Thus, all modern coined money is saved from the attacks of those who clip or pare the edges of silver and gold pieces (which practice was a great abuse as late as the eighteenth century) by having raised letters around the edge, such as "Dieu protège la France," on some French coins of the Third Empire and the Republic, or else by having the edge fluted or reeded with little bars across it. These will be omitted in the proofs.

In the printing of books and periodicals, the

proofs used are of several different kinds, and these are described under the title PRINTING.

The most important use of the word in connection with the arts is the name given to trial impressions from an engraved wood block or plate. (See PRINT.) It is customary to take these proof impressions at different times as the plate approaches completion, and such impressions are called engravers' proofs, and, in spite of their showing an incomplete state of the plate, are sure to command high prices in the case of an engraving of any importance. The engravers' proofs, taken as the plate approaches completion, are extremely brilliant and effective, because they are taken one by one, by hand, and with great care; the same brilliancy is preserved in the earliest proofs which are printed off expressly for sale. These are often classified in some special way. It is customary in the case of a large and important engraving for the artist to etch upon the margin of the plate some very small design, as a head, a figure of a bird or beast, or even a sketched incident with two figures, and this little picture is printed with the large composition which occupies the greater part of the plate. Impressions so taken are called *remarque proofs*, and are recognized as being the earliest. The *remarque* being planed away or the plate cut down, the proofs next taken are known as artists' proofs. All this time the intended lettering on the edge of the plate, that is to say, the title of the picture and the name of the engraver, and of the artist of whose original work the engraving is a copy in so many cases, have not been added. Proofs made from the unlettered plate are called generally *proofs before the letter* or *proofs before any letter*. If, now, the names of the original artist, if any, and of the engraver are added just below the edge of the picture, proofs taken at this stage are called *proofs before the title*, or by some such name invented for the purpose. What is said here of the engraver's or artist's name does not refer to the appearance of any artist's signature within the boundaries of the picture itself; for in many etchings and similar works the signature is almost a part of the design. The proofs with open letters are those in which the large capital letters of the title are inserted, but left in outline. After these letters are completed, the ordinary prints are taken.

There are still to be noted the proofs of artistic engravings, which are never lettered on the margin, which are not intended to have any title, or any name of artist or publisher, or any number or letter whatever on the margin. A conscientious etcher is very careful in noting the number of editions printed from any plate thus unsigned. The plate may be changed after any given printing; new effects may be produced, worn lines strengthened.

From this it will be seen what is the real importance of first state and second state, and the like, in artistic engravings. (See ETCHING; LINE ENGRAVING; MEZZOTINT.) The first state is apt to be preferred, because there is certainty that the plate has not been worn at this stage of its existence. It may be, however, that the second state is preferred for many reasons. There are some of the *Liber Studiorum* in which the second state is admittedly finer. An impression on vellum of the second state of an etching

may be better than an impression on paper of the first state, because prints on vellum are carefully taken and because of the exceptional beauty of a print upon this particular material. Again, the first state may be only known from the second state or other subsequent states by some very slight and hardly noticeable modification.

PROOF. In law, the establishment of facts alleged in the pleadings in a judicial proceeding by competent legal evidence. It is, therefore, the result of evidence, as distinguished from the evidence itself. However, the words proof and evidence are frequently used as synonymous, even by the courts, and when this is done, proof means simply competent legal evidence, as distinguished from irrelevant and incompetent hearsay evidence. See EVIDENCE.

PROOF-READING. The reading of printers' proofs, for correction of errors in the type, or, by authors or editors, for final approval or alteration. Proof-readers are sometimes called *correctors of the press*, and their work *correction of the press*, especially in Great Britain. Of course, the assembling of types, one by one, from their boxes in the printer's case, or the striking of a corresponding number of keys in machine composition, is not done by the average worker without accidents, making errors that need correction; and the work, besides the mere technical minutiae, comprehends reproduction from handwriting that presents many points of perplexity. In fact, typographic composition is liable to error in more ways than any person not a printer could possibly imagine. Thus it may be seen that correction through proof-reading is a most important feature of the production of printed matter. In fact, sometimes the work done on proofs is one of the largest items of expense.

Special marks are universally used by printers in correcting proofs, and authors and editors will find advantage in knowing and using these marks, mainly because of their inherent simplicity. Absolute simplicity in indicating changes, however, is the only essential desideratum. If a desired change is shown on the margin of a proof so plainly that it cannot be misunderstood, its conformity or non-conformity to technicality is of no consequence. One method of marking a proof will almost surely fail, and that method is one that suggests itself instinctively to the novice. It is that of making changes within the bounds of the text, such as a line through an extra letter or word that should be taken out, or writing a comma or other point after a word, with no mark in the margin. Proofs have been so corrected, and great disappointment felt because the final result showed neglect of the corrections. In the words of a puzzled editor who was shown how to change a sentence: "Why, it's nothing but common sense!" Some of the words in the sentence were to remain, but they were to have a different position (they were to be 'transposed'), and it was thought that through some special technicality they must be preserved; but the advice was that the whole sentence be crossed out and the whole new one be written in, directly in line with the erasure. Markings for correction may be enumerated as follows:

(1) In ordering the removal of anything not desired, a novice might write a full direction, as "This is to be taken out;" but the proof-reader makes in the margin, opposite a crossed letter,

word, or words, the sign **3**, which is merely a specialized form of the initial letter of the word 'delete.' One way will secure the desired result as well as the other, but the second plainly shows its economy, which exemplifies that of all marks peculiar to proof-reading. Frequently a number of corrections must be made in the same line, and in this case the only really arbitrary mark is used, being a vertical stroke, placed after each marginal item, merely for separation. Some readers make such a stroke after each correction in the left-hand margin, but before those in the right-hand. It is better always to have it follow, as that practice becomes so instinctive as to free the mind from unnecessary formality, and so assists toward concentration of attention, which is the key to success.

(2) A wrong letter is corrected by making a stroke through it and writing the proper letter in the margin. Exact system in the arrangement of marginal items is very desirable. Thus, a line may contain a number of errors, and it is much easier for the compositor to trace the corrections if made in regular order, exactly in line with the corresponding faults. It is well worth while to cultivate the habit of using the margin on the left for corrections in the first half of the line, and that on the right for others; also to write the first one well out toward the left edge, and the first on the other side near the print. Some proof-readers make the first mark on the right distant from the print, and those for later positions nearer, thus undoubtedly causing loss of time to the correctors of the type, who have to trace out the correspondences.

(3) Change of place, whether of a letter, a word, or many words, is called transposition. Such change within a line is indicated by a line drawn above, below, or around the first letter, word, or words, and under or above those following, to a caret indicating the new place for the matter shifted, and by 'tr.' written in the margin. For transposing letters merely, it is much better to cross them and write the letters themselves in proper order, especially for machine composition. To transpose paragraphs, a line is made alongside the first and a connecting line to its new place, and 'tr.' is written opposite the first. Many write 'transfer,' but 'transpose' is the printers' word.

(4) For change of type, a line should be drawn under the text and 'rom.' written for substitution of roman instead of italic, 'ital.' for changing roman to italic, 'l.c.' for lower-case, 's.c.' or 's. caps' for small capitals, and 'c.' or 'caps' for capitals. For a single letter or two letters together it is economical to write the letters themselves in the margin, with one line underscoring for italic, two lines for small capitals, and three for capitals; but in changing a single letter it is better to write the letter itself, in its proper form, than to use the abbreviations indicating that form, because thus only one character is written instead of four or more. One line is sufficient in any case under the type that is to be removed. In manuscript one line of underscoring directs the use of italic; two, small capitals; and three, capitals.

(5) To correct type of wrong form—too heavy, too light, etc.—'w.f.' meaning 'wrong font' (type of a wrong kind), is written.

(6) A direction to leave unchanged anything that has been crossed is given by making dots

The work of Propertius falls into two classes: first, and by far the more important, love-elegies, and, second, poems of eulogy. Indeed, the great event of the poet's life, and the only one of real importance so far as his literary activity is concerned, was his love for a mistress, somewhat his senior, whom he celebrated as Cynthia, but whose real name, if we may believe Apuleius (q.v.), was Hostia. She was probably the sister of one Hostius, who is known only as the author of a lost epic entitled *Bellum Histricum*. In character she seems to have been light, fickle, vain, and mercenary, yet witty and beautiful. In his early youth the poet had had an ephemeral passion for a slave-girl whom he calls Lycinna, but after his acquaintance with Cynthia he appears to have been loyal to her for several years. At last, probably after some five years, there came a break in their union, although they seem to have been reconciled before her death. In the poems addressed to her Propertius appears at his best, although the letter of Arethuse to her husband, Lycotas, foreshadowing the *Heroides* of Ovid, has a ring of pathos rarely beautiful. The two dominant notes of his poetry are passion and erudition. Less perfect in technique than Horace, he is more real; less sincere than Catullus, he is more balanced and restrained. The poet with whom one involuntarily compares him is Tibullus, yet here one misses the delicate sentimentalism founded on real affection for Delia which Tibullus had, while the erudite touches of Propertius, which justly won him the epithet of 'the learned,' are happily far less evident in his fellow. The distinguishing characteristic of Propertius among Latin poets is this erudition, often carried with visible effort. As his models he took the Greek Alexandrine school of poetry, following especially Philetas and Callimachus, being himself called 'the Roman Callimachus.'

In comparison with his love poems his eulogistic verse is of slight interest. Urged by Mæcenas to write in epic strain, he pleaded his unsuitability to the task. The justice of his self-judgment is confirmed by his elegies on Vertumnus, Tarpeia, Hercules and Cæus, and Jupiter Feretrius, for all of which he probably drew his material chiefly from Varro (q.v.). Yet he treated also contemporary events in his poems on the battle of Actium and the deaths of Cornelia and Marcellus, and the preparations of Augustus against the Parthians.

The first book of the elegies was published by Propertius, probably about 28, under the name of Cynthia. Although the dates of the remaining books are somewhat uncertain, the second and third seem to have appeared about 26, the fourth about 21, and the fifth about 16. The very number of the books is a disputed question. They were supposed to be three until the edition of Lachmann (q.v.), who divided the second book into two. Despite the arguments in favor of such a division, there are objections which may be alleged against it.

The manuscripts of Propertius are very late and extremely corrupt. His works were apparently unknown throughout the Middle Ages, the earliest mention of a manuscript of them being one in the possession of Petrarch. The best is the *Codex Neapolitanus*, dating from the twelfth or thirteenth century, and now in the library of Wolfenbüttel. The influence of the poet on literature has been slight, although it is noteworthy

that he inspired Goethe to the composition of his *Römische Elegien*.

The first edition of Propertius was published at Venice, in 1472. Other important old editions were by Scaliger (Paris, 1577); Passerat (ib., 1608); Broukhus (Amsterdam, 1727); Vulpi (Padua, 1755); and Burmann (Utrecht, 1780). The editions of Lachmann (Leipzig, 1816; Berlin, 1829) were epoch-making in Propertian criticism. Other editions have been published by Jacob (Leipzig, 1827); Hertzberg (Halle, 1843-45); Paley (London, 1872); Bährens (Leipzig, 1880); Palmer (Dublin, 1880); Postgate (London, 1881) and the text only by Keil (Leipzig, 1850); Haupt (5th ed., ib., 1885); and Müller (ib., 1870). English translations have been made by Cranstoun (London, 1875) and Moore (Oxford, 1870). Consult also: Jacob, *Propertius* (Lübeck 1847); Plessis, *Études sur Propertius et ses élégies* (Paris, 1886); Davies, *Catullus, Tibullus, and Propertius* (London, 1876).

PROPERTY (OF. *properte*, from Lat. *proprietas*, property, peculiar nature or quality, from *proprius*, peculiar to one's self), LAW OF. In the broadest sense (which is also in English the ordinary sense), property includes all rights that are primarily economic in their object—all rights that constitute legally protected wealth. It thus includes all rights in corporeal things, whether immovable or movable; all rights to demand from particular persons (debtors) acts or omissions that are primarily of economic value; and all monopolies, such as patent rights, copy-rights, franchises, etc. Excluded in modern law are the rights of a public officer or of a citizen, and the rights of a husband or father or guardian over the person of a wife or child or ward; because, although these rights may have economic value, modern law does not regard them primarily from this point of view. Modern theory, indeed, regards all public and family relations rather from the point of view of duties than from that of rights (q.v.).

EARLY LAW does not draw these distinctions; all early private rights are, in a broad sense, property rights. Our Aryan ancestors apparently used the same word (Ger. *mund*, Lat. *manus*, the hand) to indicate legal power over inanimate things, animals, slaves, delinquent debtors, wives, and children; and it is probable that the powers of owners, masters, creditors, husbands, and fathers were originally equally unlimited. (Cf. MARRIAGE; PARENT AND CHILD.) In early German law the same word (*mund*) was applied to the power of the King; and throughout the Middle Ages governmental powers were generally treated as property rights. Survivals of these early views are found in the English common law; e.g. in the description of an office as an 'incorporeal hereditament' and in the treatment of paternal right as a right to services.

ROMAN LAW sharply distinguished public from private law and political from property rights. The Roman law of property, however, originally included family rights. The earliest classification of property, which appears in the XII. Tables, is (1) *familia*, the household, which includes land and agricultural easements, beasts of draught and burden, slaves, wife and children; and (2) *pecunia* (from *pecus*, a herd), which includes all other things. Since things of *familia* were capable of conveyance only through a formal

sale before witnesses, known as mancipation, they were also termed *res mancipi*, and the things of *pecunia* were termed *res nec mancipi*. In early Roman law these two classes of property seem to have been protected by different remedies and to have been governed by different rules as regards testamentary disposition. In the later law, as modified by the prætors, the distinction lost all practical importance. In the later jurisprudence, family rights were taken out of the category of property (*res*) and put under the law of persons.

It is probable that the debtor was originally regarded as a *res mancipi*; but with the disappearance of the pledge of the debtor's person in the form of sale (*nezum*), rights against debtors (obligations, q.v.) were sharply distinguished from rights over things.

The Roman law also developed a clear distinction between ownership and all other rights in things. (1) Ownership (*proprietas*) included all powers that were neither specifically withheld by the law, in the interest of the community, nor specifically granted by the owner to another person. Ownership was thus at once the general and the residuary right over things. (2) All other rights (*jura in re*) were limited either in content or in duration. These limited rights were either (a) rights of use, viz. servitudes (q.v.) and long leaseholds (*emphyteusis* and *superficies*, q.v.), or (b) rights of eventual sale, created to secure debts, viz. pledge (*pignus*, q.v.) and hypothecation (q.v.). Except as regards the real servitudes and the leaseholds, these rights could be established either over immovables or movables; and substantially the same rules were applied to both classes of property. With rare exceptions, right in things could be freely alienated, and unless restricted to the single life, they were subject to free testamentary disposition. Finally all rights in things run against all the world, title prevailing over possession.

EARLY GERMAN AND MEDIEVAL EUROPEAN LAW. German law drew a sharp distinction between real property (*eigen*) and movable property (*gut*), and the distinction was emphasized by the development of the feudal land-tenures. Different kinds or classes of ownership were recognized as regards real property: the right of a feoffor was described as 'over-ownership' or *dominium emicnens*; the right of the feoffee in possession was described as 'under-ownership' or 'beneficial ownership'—*dominium utile*. A leasehold of a permanent character, such as was frequently held by peasants, was also described as *dominium utile*. At German law the owner of land had not free power of alienation; inherited land, at least, was treated as family property, and was 'tied up' (*verfangen*) in the interest of wife and children. In some territories kinsmen and even neighbors had rights of preëmption. Further restrictions upon alienation came with the development of the feudal tenures. In spite of these restrictions, however, lawful seisin of land was a right resembling Roman ownership, since it was enforceable even against honest possessors.

MODERN CIVIL CODES. In the law of real property, the disappearance of feudal tenures and the conversion of peasant holdings either into ordinary leaseholds or into freeholds has practically reëstablished the simpler Roman categories. Political power has been separated anew from property right, and there is no eminent do-

main except that of the State. On the other hand, the general introduction of official registration of conveyances, mortgages, etc., and the disposition to protect the honest purchaser who relies upon the public records have greatly modified the Roman rules. The registered conveyee or mortgagee is always protected against the holders of unregistered titles, and in modern German law there is, properly speaking, no title without registration.

As to movable property, nearly all the European legislations have accepted the old German rule that honest possession is good title except against a prior possessor by whom the thing was lost or from whom it was stolen; and even in the case of lost or stolen property, the possessor who has purchased the thing "at a fair, in a market, at a public sale, or from a merchant who deals in such articles" is not obliged to surrender it until the price which he paid for it is refunded. In the modern German code the rule is somewhat different: purchase in market overt does not protect the possessor of lost or stolen things, but purchase at a public auction gives him an unassailable title. In the German code, also, the honest possessor of money or of negotiable papers payable to bearer is always owner, and similar rules are contained in the commercial codes of several other countries. It follows from these rules regarding movable property that no hypothecation of such property is recognized, but only pledge accompanied by possession (*gage*, *Faustpfand*).

The principle which underlies all these modern rules is that of 'publicity.' Rights which run against all the world must be evident to, or at least ascertainable by, all the world. This end is gained, as regards real property, by registration of titles. As regards movable property the only public evidence of title is possession.

ENGLISH AND AMERICAN LAW. The common law of property has departed widely from the conceptions of the civil law, owing mainly to the independent development of the law of land under the influence of the feudal system. That system was late in establishing itself on English soil, but once established it impressed itself rapidly and permanently on the law of property. The fundamental distinction between movables and immovables disappeared, and we have, in their place, real and personal property, based on the distinction between real and personal forms of action. The real action was available to recover the very thing (*res*) of which the person instituting it had been deprived—primarily land and its fixtures. The personal action was instituted to recover damages from the person whose detention or destruction of a chattel had rendered him amenable to legal process. The two categories thus formed were swelled by circumstances, by analogy, by considerations of convenience, resulting in a curious composite. To real property were added all the so-called incorporeal interests, whether they had to do with land or not—as easements, profits *à prendre*, rents, tithes, offices. So, too, as real property passed by descent to the heir of a decedent, everything which by local or general custom passed to an heir and not to an executor came to be included in the description of real property—such as the crown, jewels, heirlooms, titles of honor. On the other hand, certain interests in land, as leaseholds, creditors' estates, mortgages, and shares in landholding corpora-

tions, came into the classification of personal property, for the contrary reason that upon the death of the holder they passed not to his heir, but to a personal representative.

But this grouping of property relations was only indirectly and somewhat obscurely determined by the feudal system. Its direct effect was to create a wide and permanent separation between the two systems. This it did by its transformation of real property through the doctrine of tenures. Personal property was left, as in other legal systems, subject to ownership in the full sense of that term. But real property could only be 'held' of some one else and in subordination to the rights of a superior holder. We have, therefore, land-holders, not land-owners. The distinction is of fundamental and far-reaching importance. The only owner of land is the king, the State. The subject can have at most an estate in it, i.e. a *status* with reference to it. The greatest estate possible—the pure fee simple absolute—is less than complete ownership, being a derivative and subordinate right, subject to the superior claims of him—whether a private person or the State—of whom the land is held. Property in land, therefore, is not the land itself, but an estate of longer or shorter duration in the land, together with certain rights of use and enjoyment. These rights depend upon the nature of the estate, whether for life, in fee tail, or in fee simple, and are originally curiously limited, even in such vital matters as alienation and inheritance, by the claims of the superior lord. These feudal restrictions have disappeared with the system which gave them birth, and in recent years the principle of estates has, in a limited form, been extended to personal property, but land is still held of the State, while personal property owes no duty to any one but the owner. See ESTATE; FEE; FEUDAL TENURE.

There is a further refinement in the common-law conception of property to be noticed in order to make our understanding of it complete. There may be rights not amounting to full ownership and yet recognized as property rights and legally protected as such. Just as, in the law of real property, several persons may have estates in the same parcel of land—one for years, another for life, another in fee, and so on—so also may a chattel be subject to a divided ownership. The faint line which divides a rightful possession from ownership has been traced in the article on POSSESSION. It appears most plainly in our law in the doctrine of pledge. The pledger of a chattel does not lose his property therein; but the pledgee gains something more than a mere right of detainer. He also has a 'property' in the article pledged, distinguished as a 'special' property, the pledger or owner (if we may still call him so) having the 'general' property therein. Property is thus, like ownership in Blackstone's famous passage, a complex of rights, all of which may be united in one and the same individual, or which may be divided up among several persons.

In very much the same way may the numerous and important rights in another's land (*jura in re, aliena*), such as easements, profits, and the like, may be regarded. Though falling far short of ownership of the land affected by them, they are true property rights, being protected from disturbance by any person whatsoever and not only against the owner of the land.

Here, then, we reach the outermost limits of

property rights. Other rights there are affecting land or goods which do not attain to the dignity of property. Of this nature is the right of the disseiser who is shut out of his land by an adverse possession, the right of entry for condition broken, the right to enforce a covenant running with the land, and the extensive class of rights known as equitable easements. These are all 'mere rights,' as the common law designates them, rights *in personam*, available against a specific individual, and not property rights, which are, strictly speaking, always rights *in rem*, asserted in the face of the whole world and capable of being infringed by any one who chooses to take the consequences.

The classification of property as *corporeal* and *incorporeal* is also peculiar to our legal system. Of course it has no rational basis. All rights are incorporeal, i.e. intangible, and the things which are the subject-matter of property rights are usually tangible corporeal things. It may, indeed, be admitted that such property as advowsons, tithes, offices, and the like, as well as the more modern forms of property denoted by the terms patent rights and copyrights, are incorporeal in the strictest sense of the term. But in Blackstone's use of the expression it includes easements, commons, and other profits *à prendre*, and all future estates in land, as reversions and remainders. Thus the estate of a tenant for life or years is corporeal property, whereas that of the landlord, being for the time dissociated from the possession of the land itself, is described as incorporeal. But the classification was only a convenient expression for such interests in real property as 'lay in livery' (i.e. were susceptible of physical control and therefore of delivery) and such as 'lay in grant' and could be transferred only by deed and not by livery of seisin. It did not, therefore, aim at philosophic completeness and has never been extended so as to include personal property.

Only the most important of the incidents of property can here be referred to. Where ownership is absolute and undivided, the right to use and enjoy one's own, whether real or personal property, is limited only by the rule that requires a man to use his property in such ways as not to injure his neighbor. Where the ownership is divided, however, the right of enjoyment is hedged about with numerous and complicated restrictions and there is law of waste and of trover to protect the owner who is out of possession. Though now bound up with the very conception of property, the unlimited rights of alienation and of inheritance have not always been recognized by our law, even with respect to personal property. In the case of real property, particularly, those rights, now complete, were wrested with difficulty and only after many years of effort from the feudal system. The right to transmit lands by will was only conceded by Parliament in 32 Hen. VIII. (1527). For other incidents of property, see EMBLEMENT; FIXTURES; WASTE. For modes of acquiring property, see ACCESSION; ALIENATION; CONVEYANCE; DISTRIBUTION; GRANT; INHERITANCE; OCCUPANCY; WILL.

The authorities are numerous. Consult especially Blackstone, *Commentaries on the Laws of England*; Leake, *Digest of the Law of Property in Land* (London, 1874); Williams, *Real Property* (19th ed., London, 1900); Williams, *personal Property* (15th ed., London, 1900); Schouler,

Personal Property; Pollock and Maitland, *History of English Law* (2d ed., Boston and London, 1899); Pollock and Wright, *Essay on Possession in the Common Law* (Oxford, Eng., 1888); Raleigh, *Outline of the Law of Property* (Oxford, 1890); Holland, *Jurisprudence* (9th ed., London and New York, 1900).

PROPERTY, or **PROPRIMUM** (in logic). See **PREDICABLES**.

PROPHECY (OF. *prophécie*, *prophetic*, Fr. *prophétie*, from Lat. *prophetia*, from Gk. *προφήτεία*, *prophēteia*, prediction, from *προφήτεω*, *prophēteuō*, to predict, from *προφήτης*, *prophētēs*, prophet, from *προφάναι*, *prophānai*, to say before, from *πρό*, *pro*, before + *φάναι*, *phānai*, to say). According to the popular acception, prophecy is essentially prediction, a foretelling of events by divinely inspired personages. Inasmuch, however, as the general ideas on the subject are based upon religious phenomena in Hebrew history, it is but proper, in order to determine the exact force of the term and its development, to turn to Hebrew usage. Adopting this method, we find the earlier terms in Hebrew for prophet (e.g. *rō'eh*, 'seer,' *khōzeh*, 'one who has a vision') associated with the prognostication of the future, and there is no reason to differentiate Hebrew prophecy in this stage from the belief common to all peoples in a low state of culture which assigns to certain individuals the power of ascertaining the will of the gods in whose hands the future of an individual or of a community lies. Such beliefs were common among Semites closely affiliated with the Hebrews. In Babylonia we find soothsayers, sorcerers, witches, and magicians recognized as necessary elements of society, and various classes of omen-priests connected with the Babylonian temples; *kāhin*, the Arabic equivalent of the Hebrew word for priest (*kōhēn*), is used to designate the 'soothsayer.' The various classes of soothsayers enumerated in Deut. xviii. 9-14 show not only the prevalence of this belief among the Hebrews up to a comparatively late period, but also the power which the soothsayers continued to exercise even after the period when the Hebrews entered upon a line of religious development destined to mark them off sharply from their fellow Semites.

The Hebrew 'prophet' accordingly traces his origin back to the 'seer,' that is, to the magician, sorcerer, and soothsayer; if he stands out in history as a personage distinct from the 'seer,' it is because there is afterwards added in his case a quality of a higher order. It is not difficult to determine what this quality is. In the proper historical sense, the term 'prophet' is applicable only to the series of teachers and exhorters who arose among the Hebrews in the eighth century B.C., and through whose influence a new conception of Deity and of the relation of the national god Yahweh to his people was evolved. While also concerned with 'prophecy' in the sense of foretelling the future, they dealt not with individuals, but with the nation as a whole or with the two sections of the people—the northern Kingdom of Israel, and the southern Kingdom of Judah. More than this, the prophetic functions which they exercised, or claimed to exercise, were incidental to their main task, which was to impress upon the people the sense of responsibility for their acts to a Deity, who governed, not by caprice, but by high standards of right, purity, and justice, and who was there-

fore to be approached, not by gifts and sacrifices, but by a contrite heart and a genuine spirit of devotion. The prognostications indulged in by those prophets of whose utterances we possess fragments in the 'prophetic' division of the Old Testament are largely concerned with threats of divine punishment for disobedience to Yahweh's will and decrees. They are accordingly based upon the profound conviction of the prophet that wrongdoing is certain to be punished; and in this respect their prophecies differ essentially from the attempts of soothsayers and diviners to determine by means of omens and oracular devices the course that will be taken by events and to ascertain the will of the gods.

This view of the prophetic calling among the Hebrews applies to the prophets from Amos to the anonymous Malachi, including therefore the brilliant galaxy Isaiah, Jeremiah, and Ezekiel. At the same time it must be acknowledged that, even in the case of these exhorters, survivals of the more primitive prophetic functions are to be discerned. While discarding the oracular methods of the soothsayers, they yet stand forth as interpreting certain signs and symbols in connection with Yahweh's purposes, and above all they claim, or are represented as claiming, to have had visions in which the future—generally of the nation—was revealed to them. No doubt it was this claim and the belief in their extraordinary powers that lent them a large measure of the influence that they exerted. And it is not necessary to assume that the prophets of the higher order no longer believed in the supernatural phases of their calling. They deeply felt that they were speaking in Yahweh's name and they were essentially the children of their day in accepting the position that Yahweh made his will known to his people through certain individuals singled out for the purpose.

The importance, therefore, of the Hebrew prophets consists in their paving the way for a new and far higher conception of prophecy, which, becoming in time more and more dissociated with mere foretelling propensities, made the prophet the moral and religious teacher *par excellence*. The highest expression of prophecy in this sense is to be seen in the announcement of a glorious age when with the complete reconciliation of Yahweh with his people a new period is to be ushered in, marked by the triumph of right and justice, and when the worship of Yahweh will be freed from all impurities and unworthy features. That this new era was closely bound up with strictly national ideals represents a natural limitation, the absence of which would have placed both the prophets and prophecy entirely beyond the intellectual and religious horizon of their times. As late as the advent of Jesus, the Messianic period (as the new era was designated) was bound up in the minds of the masses with the restoration of the Jewish Kingdom, and though Yahweh long ere the days of Jesus had ceased to be a merely national deity, yet even the God recognized as supreme and single in the universe was bound by special ties to a particular people; and even when the Messiah was no longer pictured as an earthly king, the limitation of Hebrew prophecy appears in the position accorded to Jerusalem, which, as the chosen seat of the universal God, was to be the spiritual centre of mankind—the gathering place to which all nations would make pilgrimage.

The view of prophecy above unfolded makes it doubtful whether the term prophet is applicable to such personages as Elijah and Elisha, or even to Samuel and Moses. That in the Old Testament the name *nābī'* is distinctly applied to them is simply due to that projection of later conditions into the remote past which is a distinguishing feature of the theory controlling historical compilation in the Old Testament collection. According to this theory, the religious views and ideas of the later prophets are but special expressions of a faith first promulgated by Abraham and given a definite shape by Moses. As a matter of fact the historical rôle of Moses and Samuel, so far as this can be determined, was so essentially different from that of the prophets from the eighth century on, that it is only a source of confusion to apply the term *nābī'* to those who flourished before the beginning of the religious movement that takes its rise with Amos. Elijah and Elisha are in a measure forerunners of this movement, but the religious problem in their days, involving mainly the conflict between the Yahweh cult and the Canaanitish Baal cults, is so entirely different from the one encountered when we come to the prophets in the real sense that we ought likewise to avoid the extension of *nābī'* to individuals of whom Elijah and Elisha are types; or, if the term 'prophet' is to be extended to them, it should at least be recognized that they are prophets of a totally different character, standing far closer to the old Semitic *kāhins*, who, more or less closely organized into a guild, differ from the ordinary representatives of the gods—the priests—only in not being attached to any particular sanctuary, but, passing from place to place, furnish oracles to those who seek them out, and engage in religious practices that are the outcome of primitive religious beliefs.

BIBLIOGRAPHY. Out of the large mass of literature following works are selected: Smith, *The Prophets of Israel* (London, 1882); Kuenen, *The Prophets of Israel* (Eng. trans., London, 1877); Duhm, *Die Theologie der Propheten* (Bonn, 1875); Ewald, *The Prophets of the Old Testament* (Eng. trans., London, 1875); Kittel, *Prophetie und Weissagung* (Freiburg, 1899); Riehm, *Die Messianische Weissagung* (2d ed., Gotha, 1885; Eng. trans., Edinburgh, 1891); Cornill, *Der israelitische Prophetismus* (Strassburg, 1894; Eng. trans., Chicago, 1897); Darmesteter, "The Prophets of Israel," in *Selected Essays* (Boston, 1895); Briggs, *Messianic Prophecy* (New York, 1886); and the Old Testament theologies of Dillmann, Smend, Oehler, and Schultz. See ELIJAH; ELISHA; MOSES; SAMUEL; and the articles on the different prophets of the Old Testament and their books.

PRO'POLIS (Lat., from Gk. *πρόπολις*, bee glue, suburbs, from *πρό*, *pro*, before + *πόλις*, *polis*, city). A substance commonly known as 'bee glue,' which is obtained by the domestic honey-bee from the buds and crevices of trees, and is carried by the workers to the hive in the basket-like cavities on the tibial joints of the hind legs. It is resinous in its chemical composition, and differs with the tree from which it is collected. It is used at once to stop up crevices in the hives, and to varnish the whole interior surface as well as to glue movable portions fast; also in strengthening the attachments of combs, and if the latter are designed exclusively for honey the

edges of the completed cells receive a thin coating. The flight-hole is often made smaller by filling a part of it with masses of propolis, sometimes mixed with old wax. Bees of the Carniolan race gather the smallest quantities of propolis and those of the Tunisian race the greatest amount; on this account the former are better suited to the production of white-comb honey.

PROPONTIS. The ancient name of the Sea of Marmora. See MARMORA, SEA OF.

PROPORTION (Lat. *proportio*, proportion, symmetry, analogy, from *pro*, before, for + *portio*, share; connected with *pars*, part). In mathematics, and equality of ratios. Thus the ratio of 12 to 3 equals the ratio of 8 to 2; hence 12:3=8:2 is a proportion. In general if $a:b=c:d$, a , b , c , d are said to be in proportion. An equality of several ratios, as 1:2=4:8=9:18, is called a *continued* proportion. An equality between the products of ratios, as $\frac{2}{3} \cdot \frac{5}{7} = \frac{10}{21}$, is called a *compound* proportion. In the proportion $a:b=c:d$, a , b , c , d are called the *terms*, a and d the *extremes*, and b and c the *means*. The term d is called the fourth proportional to a , b , c . In the proportion $a:b=b:c$, b is called the mean proportional between a and c , and c is called the third proportional to a and b . If one quantity varies directly as another, the two are said to be *directly* proportional, or simply proportional. E.g. the price of a given quality of sugar varies directly as the weight; the price is then proportional to the weight. Thus at 4 cents a pound, 12 pounds cost 48 cents, and 4 cents : 48 cents = 1 pound : 12 pounds. If one quantity varies inversely as another, the two are said to be *inversely* proportional. E.g. in general, the temperature being constant, the volume of a gas varies inversely as the pressure, and the volume is therefore said to be inversely proportional to the pressure.

A proportion, being an equation, can be solved so as to express any term by means of the other three. Some of the fundamental properties of proportion are: (1) The product of the extremes equals the product of the means; (2) the terms are in proportion by composition, i.e. if $a:b=c:d$, $(a+b):a=(c+d):c$ or $(a+b):b=(c+d):d$; (3) the terms are in proportion by division, i.e. if $a:b=c:d$, $(a-b):a=(c-d):c$ or $(a-b):b=(c-d):d$; (4) the terms are in proportion by composition and division, i.e. if $a:b=c:d$, $(a+b):(a-b)=(c+d):(c-d)$; (5) in a continued proportion,

$$\frac{a}{b} = \frac{c}{d} = \frac{e}{f} = k, k = \frac{\left\{ \begin{array}{l} ma^n + pc^n + qe^n + \dots \\ mb^n + pd^n + qf^n + \dots \end{array} \right\}^{\frac{1}{n}}}{\left\{ \begin{array}{l} mb^n + pd^n + qf^n + \dots \end{array} \right\}^{\frac{1}{n}}}$$

The theory of proportion, often called the 'rule of three' or 'golden rule,' is as old as Plato's time and was called by the Greeks *ἀναλογία*. Euclid in the fifth, eighth, and ninth books of the *Elements* gives a rigorous treatment of the subject, in which the magnitudes are regarded as either commensurable or incommensurable. See RATIO.

PROPORTION IN FINE ART. This has to do with the relative sizes of things represented or embodied in a design; and, in a secondary sense, with the relative importance of certain passages of light and dark, or of color more or less powerful and effective. Thus, the composition (q.v.) may be marred by a disagreeable relation between the heights or the bulks of two figures, trees, rocks, buildings in a picture or in

reality, or parts of a building, in which case they are said to be 'out of proportion.' So in an ordinary house front, as on the street of a city, the proportion between the window openings and spaces between them, and between the window openings of one tier and those of other tiers, and between the cornice and the wall below and between the stone-faced basement and the brick-faced wall between the basement and the cornice, may all be so judicious that the whole front becomes, by the combination of these different proportions, a remarkable work of art. Certain architects of great fame have had no other important claim to the consideration of posterity than a mastery of such proportions as these.

There is no fixed rule for proportion, nor even any body of rules for the government of those who would produce effective proportions in their design. It is true, however, that many attempted analyses have been made of fine designs, both in painting and in architecture, with a view of ascertaining the supposed principles which govern the designer in making admittedly beautiful compositions. For proportion in the fine arts, consult: Viollet-le-Duc, *Dictionnaire de l'Architecture*, articles "Proportion" and "Symétrie;" Robinson, *Principles of Architectural Composition* (New York, 1899); Dow, *Composition* (ib., 1900); Poore, *Pictorial Composition and the Critical Judgment of Pictures* (ib., 1903); Van Pelt, *A Discussion of Composition* (ib. 1902).

PROPOSITION (Lat. *propositio*, representation, a setting before, from *proponere*, to place before, from *pro*, before for + *ponere*, to place). The verbal expression of a judgment (q.v.); but the word is used by many logicians as synonymous with judgment. This usage is to be deprecated as resulting in confusion and as giving rise to the idea that a judgment can be cut up into as many mutually independent parts as result from the breaking up of a proposition into its grammatical elements.

PRO'PYLÆ'A (Lat., from Gk. *προπύλαια*, *propylaiā*, neu. pl. of *προπύλαιος*, *propylaios*, before a gate, from *πρό*, *pro*, before + *πύλη*, *pylē*, gate). In classical Greek, a structure erected outside the entrance gate or door of an important building, or of an inclosure containing several buildings. The word expresses the idea of a building of some elaboration with many parts. Thus the buildings called by classical writers *propylæa* are known to us as rather large roofed halls into which the visitor enters by several doorways or by the inter-columniations of a portico, and from which he reaches the sacred inclosure of a sanctuary or the reserved space around the buildings of a palace. There are *propylæa* whose plan and arrangement can be made out at Eleusis, Epidaurus, and other Grecian towns, but that of Athens is so far in good preservation that its roof is still partly in place, as well as the greater number of its columns; while the outer pediment and other parts which have been rebuilt have been so easily established by the use of their old materials and the like that there can be no doubt of the authenticity of the whole structure. Fortunately, this *propylæa* is also the most important of all Grecian buildings of the kind, so far as can be gathered from ancient authorities and from existing remains. In this case it was necessary to provide a stately entranceway into the sacred inclosure on the top of the Acropolis rock. A solid wall with five doorways, large in propor-

tion to the piers between them, has two porticoes: a shallow one on the inner or eastern side and a much larger and deeper one toward the approach from the west. This larger portico is flanked by two subsidiary buildings. The structure so planned provides two hexastyle Doric porticoes facing east and west, and two much smaller ones fronting the wings and facing one another, each of these with three Doric columns in antis. In addition to these Doric columns there are six Ionic columns flanking the principal gangway of approach; a carriage drive on the uncovered rock is carried right through the *propylæa* from the outer to the inner face, while the porticoes on either side have a raised level pavement with steps leading up to it. The whole *propylæa*, then, is in its principal mass about seventy-five feet square, while the width across the wings is about one hundred and fifty feet.

PROSAUR'IA, PROSAUR'I (Neo-Lat. nom. pl., from Gk. *πρό*, *pro*, before + *σαῦρος*, *sauros*, lizard). A subclass and order, respectively, of reptiles, extinct except the genus *Sphenodon*, with one living species, the tuatara (q.v.). They are mostly represented by Permian and Carboniferous fossils. The subclass contains two orders, *Microsauri* and *Prosauroi*; and the latter two suborders, *Protosauri* and *Rhynchocephali*. These "seem to represent the central stem of the reptilian tree," and the latter has a survivor in *Sphenodon*. Consult Gadow, *Amphibia and Reptiles* (London, 1901).

PROSECUTION (Lat. *prosecutio*, from *prosequi*, to follow, from *pro*, before for + *sequi*, to follow). In its technical legal sense, the institution and conduct of legal proceedings against one who is charged with a crime. In a more general sense it is sometimes used as applicable to civil as well as criminal proceedings. There are three methods of prosecution for crime. First, upon the unsworn complaint of an individual; second, upon the complaint of an officer appointed to institute prosecutions; and third, upon a sworn complaint. The first was the earliest method known to the common law. It was, in England, a permissible method of prosecution under the technical name of appeal as late as 1818. (See **APPEAL**.) The second method obtains in some European countries, but not in England or the United States, where the third method of prosecution upon sworn complaint is now used exclusively.

Prosecution by sworn complaint may be instituted by the complaint of a private individual or by the complaint of the attorney-general or other prosecuting officer, when the complaint is said to be on information; or it may be instituted directly by the grand jury, which makes its complaint in the form of indictment (q.v.) or presentment (q.v.). When made by a private citizen the practice is to file the complaint in the court of a justice of the peace or magistrate, whose duty it then is to issue a warrant for the arrest of the person charged with the crime. A person having been arrested upon complaint or by a peace officer or other person having authority to arrest, the magistrate has authority, if he deems the prisoner probably guilty, to hold him for the action of the grand jury or for trial by the proper court upon information filed by the prosecuting officer. When, however, the accused is a fugitive from justice, the information may be filed without the preliminary examination,

and an indictment may be found or presentment made by the grand jury before the arrest of the accused. Whether the accusation is by information or indictment, the accused when arrested is required to plead to the information or indictment and is then placed upon trial in the court having jurisdiction. For the other proceedings in a criminal prosecution, see ARREST; GRAND JURY; INDICTMENT; PROSECUTOR; PLEADING; PROCEDURE.

PROSECUTOR (Lat. *prosecutor, prosequitor*, from *prosequi*, to follow). One who institutes and conducts a criminal prosecution in behalf of the government.

In most European countries the duty of conducting prosecutions for criminal offenses is imposed on public officers. In England it has been customary for all criminal prosecutions to be conducted by counsel employed by private individuals, except in rare cases of crimes directly affecting the sovereign, when the prosecution was conducted by the attorney-general. In cases of private prosecution in England the person instituting the criminal proceeding is usually required to give a bond conditioned upon his proceeding with the prosecution. He can be relieved from this obligation only by the court or on the entry of a *nolle prosequi* by the attorney-general. The prosecutor is required to bear all the costs of the prosecution, but the court may award him a sum with which to defray his expenses in case of all felonies and most misdemeanors. This sum, however, is in practice usually inadequate. This system of private prosecution seems to have been quite effective, although burdensome to the prosecutor and liable to grave abuses.

In 1879 an act of Parliament (47 and 48 Victoria, c. 54) "more effectually providing for the prosecution of offenses in England" was framed which enacted that the Secretary of State might from time to time appoint an officer called the Director of Public Prosecutions, whose duty it should be to institute and carry on prosecutions under the direction of the Attorney-General. The authority of this officer, however, was somewhat limited, and it is still true that under the English system there is no officer whose duty it is to prosecute for all crimes.

In the United States, while prosecutions by private individuals are permissible, the English system of prosecution by private individuals exclusively is not followed. Both under the Federal Government and the several State governments provision is made for the prosecution of offenders by public prosecutors usually known by the title of district attorney (q.v.).

The prosecuting officer's authority is confined to the preparation and trial of cases. He cannot stipulate for exemption from punishment or as to the amount of punishment which shall be inflicted, although his recommendations are often accepted and acted upon by the court. In most States, but not all, he may with leave of the court accept the assistance of private counsel, but he still remains the responsible instrument of the law. He may, if the evidence or facts within his knowledge justify in his judgment the step, enter a *nolle prosequi*, thus ending the present prosecution, but not barring the right to begin a new action on the obtaining of further proof. In some States he must obtain the consent of the court to do this.

Besides district attorneys, there are in many

States special prosecutors appointed to conduct prosecutions in police and other minor courts with less power than that of district attorneys. Special prosecuting agents are also sometimes appointed to prosecute for violations of the liquor laws. See INDICTMENT; INFORMATION; JEOPARDY; NOLLE PROSEQUI; etc.

PROSELYTE (Lat. *proselytus*, from Gk. *προσήλυτος*, convert, one who has come over, from *προσελθεῖν, proselthein*, to have come toward, from *πρός, pros*, toward + *ελθεῖν, elthein*, to have come). A convert, generally to a new religion. In the Septuagint the Greek *προσήλυτος*, is the usual translation of the Old Testament term *gēr*, i.e. one who takes up his residence in a foreign land and puts himself under the protection of a foreign people. It is applied more particularly to the foreigner residing in Palestine, but in the New Testament is the name given by the Jews to a convert to Judaism. The transition, however, from the former to the latter meaning is already foreshadowed in certain parts of the Old Testament belonging to the exile period, as in certain passages of the Priestly Code (e.g. Num. xv.) and in Isaiah (e.g. chap. xiv.), but it was not until the second century B.C. that the term proselyte fully acquired its technical sense. According to Jewish law circumcision was an essential preliminary to admission into the synagogue as a member. The proselyte is therefore a *gēr* who has been circumcised, but by the side of the proselyte in the full sense Rabbinic literature recognizes a class of persons known as 'proselytes of the gate' who had taken up their residence in Israel's land without embracing Judaism by the act of circumcision. It is almost equivalent to the biblical phrase 'a sojourning *gēr*' (e.g. Lev. xxv. 47). The phrase, however, as well as the class, has only a theoretical significance, and as a matter of fact there was at all times only one class properly designated as proselytes. In view of this, another phrase, 'the god-fearing ones,' which is particularly prominent in the Book of Acts, must not be confused with proselytes, though it might seem that at times the line of demarcation between the two is very faint. The inflow of foreigners into Palestine after the Greek conquest, the more intimate contact of Jews with non-Jews both within and without Palestine, the spread of Jewish influence through the presence of Jews in Egypt, Persia, and elsewhere were important factors in making Judaism attractive to many who had lost their faith in the old gods. The decay of the Greek religion was a powerful stimulus to a movement which at one time promised to increase the numbers of believers in Judaism considerably, but the nationalistic tinge of the Jewish religion as well as its elaborate ceremonialism acted as checks to the movement, and the actual number of those who went over completely to Judaism was not very large. On the other hand, those who might be designated as sympathizers with Judaism, who had cast aside their own religious customs and adopted some of the Jewish ones, such as the observance of the Sabbath, certain dietary laws, contributing to the temple treasury, and the like, while openly proclaiming their belief in the essential doctrine of Judaism—namely monotheism—were very numerous. It is to these that the term 'the god-fearing ones' more particularly applied.

The full proselyte, known in Rabbinical litera-

ture as 'proselyte of righteousness,' in addition to submitting to the rite of circumcision had to receive instruction in the texts of Judaism and usually was obliged to carry out the precepts strictly. He was obliged to cut loose from heathen associations altogether, and after a certain time the ceremony of the ritualistic bath to symbolize his purification from the uncleanness of heathenism was also insisted upon. In Palestine proper converts to Judaism do not appear to have been encouraged by the rabbis. Pharisaism discountenanced missionary efforts and the growth of the new Christian religion, which threatened the lowering of all barriers, led to a further insistence upon the rabbinic ideal, which tended toward the separation of the Jews from the rest of mankind. Among the Jews, however, who lived in the Greek colonies, an active propaganda was carried on, more particularly during the century before our era, and the movement here was not without its effect on those who remained in the mother country.

A part at least of the Hellenistic Jewish literature is distinctly intended for heathen readers, written to convince them of the falsity of their own religion, and of the superiority of Judaism. To be sure, the Judaism advocated in this literature was no longer a pure product, and itself shows traces of the influence of Greek thought; yet in its main lines it was in keeping with the doctrines and tendencies of Palestinian and Babylonian Judaism. As a result of these proselytizing tendencies, Christianity found the way opened when the new religion felt strong enough to begin active missionary efforts; and in the measure that the Jewish Christians abandoned distinctively Jewish customs and rites, they attracted many to their ranks who had been prepared for the new faith by the dissemination of Hellenistic thought. In this manner Christianity reaped the benefits of the labors of the Jewish propagandist and became essentially a missionary religion. Judaism also continued to make converts, as the history of the Khozan Jews seems to show. But it gradually became characterized by a decided discouragement of additions to its ranks, increasing its restrictions and surrounding admission into the synagogue with difficulties that only a very limited number could overcome.

BIBLIOGRAPHY. Schürer, *History of the Jewish People in the Time of Jesus Christ* (Eng. trans., Edinburgh, 1885-90); Bertholet, *Die Stellung der Israeliten und der Juden zu den Fremden* (Freiburg, 1896); Weber, *Die jüdische Theologie* (Leipzig, 1897); Graetz, *Geschichte der Juden*, vol. i. (Berlin, 1854; Eng. trans., Philadelphia, 1873). See GENTILES.

PROSERPINA (Lat., from Gk. Περσεφόνη, *Persephone*, Περσεφόνηα, *Persephoneia*, of unknown etymology). In Greek mythology, the daughter of Zeus and Demeter. The story of her abduction by Hades, the search and sorrow of her mother, and the return of Proserpina for a part of the year to the upper world, is given under CERES, where also is discussed the nature of the two goddesses, who were commonly joined in the cult. In Homer she appears as the dread consort of Hades, the ruler of the lower world, and enemy of life. With this probably belongs the genealogy that made her daughter of the Styx. This side is, however, far more prominent in literature and art than in the cult. In imprecations her name

is frequently invoked along with Hades and the Furies, who in Orphic theology are even called her daughters. So she rules the dead, and death comes in obedience to her command, while it is as her servant that Hermes leads the souls to her kingdom. Not that she is always stern, for in the stories of Orpheus and Alcestis she appears as moved to pity. In art, when with her mother, she is sometimes represented as of more girlish form, but even here she carries the torch of the goddess of the lower world. When represented with Hades, she is altogether the queen, commonly enthroned, and holding the sceptre, or sometimes the bunch of wheat, which conveys a reminiscence of her gentler function.

PROSKUROV, pr'ōskū-rōf'. A town in the Government of Podolia, Russia, situated near the Bug, about 60 miles north of Kamenetz-Podolsk. It has an extensive sugar mill and manufactures of flour and tobacco. Population, in 1897, 22,915.

PROSODY (Lat. *prosodia*, from Gk. προσῳδία, from πρὸς, *pros*, toward + ᾠδή, *ōdē*, song, from ἄδειν, *adein*, to sing). A term which originally meant the tone or accent of a syllable, and later was applied to a song sung to music. At the present time it is loosely regarded as that part of grammar which treats of quantity, accent, and the laws of versification (q.v.).

PROSPECT PARK. See BROOKLYN.

PROSPERITY ROBINSON. A name applied by William Cobbett to Frederick Robinson, Earl of Ripon, who boasted of the prosperity of the country in the House of Commons just before the financial crisis of 1825.

PROSPERO. The banished Duke of Milan in Shakespeare's *Tempest*, a wise and noble magician living on a desert island with his daughter Miranda. Some traits in the character seem to have been intended to suggest James I., before whom the play was first performed; but in more points it resembles Shakespeare himself at the close of his public career.

PROSPER OF AQUITA'NIA, SAINT (c.400-c.463). A learned layman of the fifth century, born in Aquitania. Little is known of his life, except that he was in Gaul from 428 until 434, and after that date probably lived in Rome. It was he who induced Pope Celestine to write a letter to the bishops of Gaul expressly confirming Saint Augustine's doctrine of grace, and he was recognized as the accredited defender of the Church's teaching on the subject against the Semi-Pelagians. His *Chronicle* (*Chronicon Consulare*) was completed in Rome. It is a continuation of that of Jerome and brings it up to 455, dealing especially with the history of dogma and of heresies.

His works, from the Benedictine text of 1711, are in Migne, *Patrologia Latina*, li. For his teaching on grace, consult Wörter, *Prosper von Aquitanien über Gnade und Freiheit* (Freiburg, 1867).

PROSS, SOLOMON. A spy and villain in Dickens's *Tale of Two Cities*. His sister, Miss Pross, a red-haired, ungainly, but unselfish woman, lived with Lucie Manette, and accidentally killed Madame Defarge.

PROSSNITZ, prōs'nīts (Bohemian *Prostějov*). A manufacturing town of the Crownland of Moravia, Austria, in the fruitful plain of Hanna, 11 miles southwest of Olmütz (Map: Aus-

tria, E 2). It manufactures woolen cloth, cashmeres, malt, sugar, brandy, agricultural implements, linen, and cotton stuffs. Population, in 1890, 19,512; in 1900, 24,054, mostly Czechs.

PROSTATE GLAND (from Gk. *προστάτης*, *prostatēs*, one who stands before, from *προιστάμαι*, *proīstanai*, to stand before, from *προ*, *pro*, before + *ιστάμαι*, *histanai*, to stand). A pale, firm, glandular body, surrounding the neck of the bladder and the commencement of the male urethra. The prostate gland secretes a milky fluid having an acid reaction, and when examined with the microscope showing columnar epithelium with granular nuclei. In old age it is liable to become enlarged, and it is also sometimes the seat of various diseases. Inflammation of the organ is rarely idiopathic, but not infrequently occurs as the result of gonorrhœa, or the use of instruments. Abscess may happen either as the result of acute inflammation, or it may occur with comparatively little antecedent inflammation, as sometimes happens in pyemia. Prostatitis is liable to produce retention of urine, either from inflammatory exudation or from the pressure of the congested organ. In such cases the urine must be drawn from the bladder by a catheter, an operation which, under the circumstances, requires considerable skill and knowledge in order to avoid injuring the gland. The enlargement spoken of above as occurring in elderly and aged persons, although liable to affect all classes, is more usual in those who have led irregular lives. In rare cases there is excessive development of the glandular element, and sometimes tumors are developed. The gland is rarely the seat of cancer as well as of tubercle. Prostatic calculi may occur, generally in old people, more rarely in young subjects. Prostatic enlargement is treated surgically by removal of the organ entirely or in part, the operation constituting prostatectomy. It is a grave operation. Consult Park, *Surgery by American Authors* (New York, 1901).

PROSTITUTION (Lat. *prostitutio*, from *prostituere*, to expose publicly, to place before, from *pro*, before, for + *statuere*, to place, from *stare*, to stand). Customary and common practice of lewdness for hire. Prostitution appears to have arisen in every race upon its emergence from the semi-promiscuity of barbaric life; certainly, no highly civilized people has ever been free from it. While it may thus be regarded as universal, it is not, however, a constant phenomenon, since its volume has unquestionably shown great tendency to variation.

The causes of prostitution are too complex for enumeration, but its principal conditions may be briefly indicated. It is most common where large classes of men live under conditions which do not permit of the founding of families, and where numerous women exist in so degraded an environment that they are not greatly influenced by the social abhorrence for professional vice. These conditions are fulfilled in most large cities, and for this reason it is not unnatural that prostitution has increased in the last century, since the proportion of the population living in cities has greatly increased. (See POPULATION.) It may therefore be regarded as a phenomenon of social pathology, since it is closely dependent upon the social grouping of population and distribution of wealth. It may be pointed out that the use of alcoholic beverages increases the num-

ber who live by vice, not only by increasing the attractiveness of such a life, but by creating in many homes conditions of so degraded a character that young children are early familiarized with evil. Recent changes in the mode of life of a large part of the race have no doubt given rise to many forms of physical degeneracy which naturally find expression in this form of vice. Further, the fact that a great deal of money finds its way into the hands of the prostitute renders it inevitable that a class of individuals should arise who make it their business to provide opportunities for vicious indulgence and to secure new victims for prostitution; and although there is no foundation for the popular belief that systematic procuration is responsible for the greater number of prostitutes, it remains true that in many cities there have existed and still exist agencies for procuring unwilling victims for vice.

Attempts to repress prostitution by penal laws have been common in all nations which have developed a high standard of personal purity. Such attempts were frequent in Jewish history. Prostitution was intimately associated with the worship of certain pagan deities (e.g. Astarte), and was therefore more severely punished than a mere moral offense would have been. In the early Germanic tribes prostitution, like any other form of unchastity, was severely punished as an offense against social and religious institutions. The conquest of the Roman Empire by Christianity resulted in the promulgation of repressive laws against prostitution. By the capitularies of Charlemagne, whipping, imprisonment, and exposure were imposed upon the prostitute and those who sheltered her. Repressive enactments appear frequently in the later Middle Ages, especially after the great epidemic of syphilis in the fifteenth and sixteenth centuries, when many States and cities adopted the harshest measures of repression, employing imprisonment, mutilation, and even capital punishment to this end. Upon her accession to the throne of Austria, Maria Theresa entered upon a systematic policy of repression, punishing severely both the prostitute and those who consorted with her. Repressive policies still appear sporadically in both Europe and America, but the inherent difficulties of police control of morals, together with the fruitlessness of past repressive policies, prevent their general adoption.

As an alternative to repressive measures, many governments have adopted the policy of tolerating prostitution itself, but under such regulations as might divest it of its attendant evils. These may be classed as social and hygienic. The social effect which was earliest recognized was its tendency to lower the general standard of chastity, and thus to impair the integrity of the family and to undermine the whole constitution of society. Classical and mediæval regulation endeavored to meet this evil by drawing a clearly defined line between women devoted to vice and those of honorable life. The prostitute was compelled to live in special quarters, and to wear a distinguishing garb. The same spirit evidently lies at the basis of modern police regulations, common in German cities and not uncommon in America, creating a 'reservation' within which prostitutes may live unmolested. It is assumed that when scattered among the general population prostitutes act as centres of contagion of moral disease. In small cities such regulations

have proved effective in centralizing vice, although grave doubts have been cast upon the social expediency of such a policy; and in large cities it has never proved satisfactory even to those who are convinced of the expediency of regulation.

A second social result of prostitution is the encouragement and opportunity it gives to crime. The prostitute and the criminal come to a large extent from the same social classes. The female members of criminal families are frequently prostitutes. Moreover, the fact that both classes are social outcasts tends to bring them into sympathy with each other. Many prostitutes form semi-permanent relations with low criminals (*souteneurs*, 'cadets'), and support them in the intervals of their criminal operations. The brothel furnishes easy opportunity for robbery and theft. To break up this alliance between vice and crime has been one of the constant endeavors of those who seek to regulate prostitution. In the Middle Ages it was a common practice to form quasi-guilds of the prostitutes, imposing upon them collective responsibility for all violence and disorder that might occur in the brothel. The present policy of the French police is to force prostitution, so far as possible, into brothels, the owner or tenant of which may be made responsible for crime. One of the purposes of the plan of confining prostitution in reservations is the greater ease of police supervision that may result from lessening the area in which prostitution operates.

The hygienic effects of prostitution, however, have attracted far more attention from modern students of the problem than the social effects. Prostitution has always been the source of serious contagious maladies, but in early times, owing to the backwardness of medical science, the relation between disease and vice was hardly recognized. The appearance in Europe of syphilis (q.v.) in epidemic form drew attention to this relation. In 1700 the Berlin authorities adopted the plan of periodic examination of prostitutes, with confinement in hospitals of the diseased, a policy now generally known as 'reglementation.' A similar plan was put into systematic operation in Paris in 1802, and during the first half of the nineteenth century was widely adopted in other European cities. The great majority of the large cities of Continental Europe pursue the same policy at the present time. Sanitary control of prostitution received an extended trial in England under the Contagious Diseases Acts, in operation from 1866 to 1883 in twelve stations in England and two in Ireland. A modification of the same plan was tried in America in Saint Louis (1870-73). In parts of Japan reglementation is the accepted method of dealing with vice. The ideal of reglementation is to compel every person devoted to professional vice to submit to periodic inspection for signs of disease. In Paris, which may be selected as typical of cities in which reglementation is well established, inmates of brothels are inspected weekly at their place of residence. These form only an insignificant fraction of the total number. The great majority live in furnished rooms, and are required to report twice a week at the dispensary. Each prostitute who submits to control is given a card which frees her from molestation unless her conduct is flagrantly disorderly. A register is kept of tolerated prostitutes, and when once enrolled upon the register, they cannot be freed

from the obligation of periodic inspection except upon evidence of a change in their mode of life. If they are found to be diseased, they are sent to the hospital of the prison of Saint Lazare, where they are detained until cured.

Registration may take place at the request of the prostitute, or by order of the official head of the 'Morals Police,' a body of police set apart especially for this service. Inasmuch as probably the majority of prostitutes regard their state as only temporary, expecting to return to honorable life sooner or later, they usually resist strenuously the efforts of the police to place them upon the register, since they believe that the register may be employed at any time in their lives to brand them with infamy. The chance of detention for months in a prison hospital in order to be cured of a malady which causes little suffering is another deterrent to the acceptance of police toleration. For these reasons the police are forced, by frequent arrests and imprisonment, to render the position of the unregistered or 'clandestine' prostitute as unsatisfactory as possible; and frequently the office finds it necessary to register prostitutes against their will. In spite of the incessant activity of the police, the number of those who are found on the register is only a small minority of the total number of prostitutes—not over 25 per cent., and probably nearer 10 per cent. What is true of Paris is true in the main of most other cities in which reglementation is practiced. In Berlin the police act with somewhat greater freedom in registering prostitutes against their will, but succeed in subjecting no very large percentage to control. The difficulties in the way of control are less in the smaller cities, and it is claimed that in some towns, e.g. Dorpat in Livonia, clandestine prostitution has been practically eradicated. This is, however, but very rarely the case, and no supporter of reglementation is optimistic enough to hope for equal effectiveness of control in large cities.

It is almost impossible to form a just estimate of the effect of reglementation in checking the spread of venereal maladies. Until the last decade it was generally believed by the medical world that statistical evidence existed which demonstrated clearly the sanitary advantages of reglementation. Those statistics have since been subjected to careful analysis, and have been proven to be practically worthless. Defenders and opponents of the system have practically agreed to discard statistical arguments and to rely upon common sense to defend their positions. Judged from this standpoint, it is obvious that the insignificance of the proportion of registered prostitutes to the total number and the comparatively long interval between inspections must limit narrowly the possible improvement in public health. What is more serious, it appears in the light of recent progress in medicine that the period of confinement for treatment is not sufficiently prolonged, and that many who are dismissed as well are capable of transmitting contagion. These defects in the system hardly admit of a remedy, since the police at present exhaust practically all means at their command to increase the proportion of registered prostitutes, and consequently it is impossible that more extensive registration can be instituted. To increase the frequency of inspections, or the length of the period of compulsory treatment, would greatly increase the difficulty of administration,

since it would diminish the number of those who submit voluntarily to control. If, as seems probable, the system increases the extent of indulgence in vicious pleasures through creating a popular impression that vice is innocuous, it is not inconceivable that relementation, as at present practiced, increases disease instead of diminishing it.

Relementation has always excited vigorous opposition of large classes in society. Adverse sentiment has been especially strong in England and America. The enactment of the Contagious Diseases Acts created a party of 'abolitionists,' who carried on a propaganda against the system until it was finally abolished. The same party has an increasingly influential following on the Continent of Europe, and aims eventually to abolish relementation there. The system is attacked on the grounds, (1) that it legitimatizes vice and encourages it by the attempt to make it innocuous; (2) that it is in violation of the principles of personal liberty, since it creates a class of persons over whom the police have practically unlimited power, and permits the police, on mere suspicion, to subject individuals to arrest and an insulting inspection; (3) that it tends to render difficult or impossible the reform of those who have once fallen into vicious habits of life; and (4) that it increases instead of checking the extent of disease. Furthermore, it creates a popular impression that prostitution is a necessary evil, and thus acts as a check upon efforts to prevent its increase and to assist fallen women to rise from their dishonorable vocation.

How far the charges of the abolitionists are true it is impossible to say. A conservative view is that little good results from relementation; possibly no more than could be gained by the now discredited policy of penalizing prostitution. Permanent amelioration of public health and morals depends upon limiting the absolute extent of vice. There can be little doubt that a greater regard for the welfare of neglected minors in the large cities would diminish the number of those who live by vice. Houses of refuge for those who desire to reform are now quite common. Such institutions have not hitherto been as successful as was expected. Investigation has shown that not more than five per cent. of the inmates of some of these 'Magdalen Houses' were permanently reformed. This has in part been due to the fact that such homes, founded by religious organizations, assumed that the reformed prostitute was to live a life of severe penance. Institutions which have aimed merely to offer a temporary refuge, and have sought to secure the return of the prostitute to an honorable place in society, have been far more successful. Societies for the rescue of girls who have fallen into the hands of professional procurers are also becoming prominent, and have already effected much toward the suppression of this form of slave trade. Finally, much may be expected from the present tendency to furnish greater opportunity to the poorer classes for education and culture, and from public and private endeavors to provide healthful amusement and society for those who otherwise fall a ready prey to morbid desires.

BIBLIOGRAPHY. Behrend, *Die Prostitution in Berlin* (Erlangen, 1850); Parent-Duchâtelet, *De la prostitution dans la ville de Paris* (Paris, 1857). This is the classic work on the subject. Its spirit is thoroughly scientific, but its conclusions require revision in the light of recent in-

vestigations. Acton, *Prostitution Considered in Its Moral, Social, and Sanitary Aspect* (London, 1857); Hügel, *Zur Geschichte Statistik und Regelung der Prostitution* (Vienna, 1865); *Report of the Royal Commission on the Contagious Diseases Acts* (London, 1871); Ames, *Laws for the Regulation of Vice* (London, 1877); Lecour, *La prostitution à Paris et à Londres* (Paris, 1882), a work containing the most satisfactory account of the administration and history of the Parisian system of relementation; Kühn-Reich, *Vorlesungen über die Prostitution im 19. Jahrhundert und die Verhütung der Syphilis* (Leipzig, 1888); Fiaux, *La police des mœurs* (Paris, 1888); Tarnowsky, *Prostitution und Abolitionismus* (Hamburg, 1890); Blashko, *Die Verbreitung der Syphilis in Berlin* (Berlin, 1892); Selhmölder, *Die Bestrafung und polizeiliche Behandlung der gewerbmässigen Unzucht* (Düsseldorf, 1892); Commenges, *La prostitution clandestine à Paris* (Paris, 1897); Sanger, *The History of Prostitution* (revised edition, New York, 1898). This is the most extensive English work on the subject, but it takes practically no account of the scientific progress of the last three decades, and is therefore of limited value. *Conférence internationale pour la prophylaxie de la syphilis et des maladies vénéréennes* (Brussels, 1899-1900), the most valuable compilation on the subject, containing papers and discussions covering practically every phase of the subject. *Report of the Committee of Fifteen (New York) on the Social Evil* (New York, 1902).

PROSTYLE (Gk. πρόστυλος, *prostylos*, having columns in front, from πρό, *pro*, before + στῖλος, *stylos*, column). A temple with a portico in front. A temple with a portico at both ends was termed amphiprostyle.

PROTAGORAS (Lat., from Gk. Πρωταγόρας) (c. 485-c.411 B.C.). A famous Greek sophist of the fifth century B.C., born at Abdera in apparently humble station. He came to Athens as early as B.C. 445, and in that city and in Sicily won his fame as a teacher and philosopher. About B.C. 411 he was charged with impiety, because of his agnostic writings, and forced to flee into exile. He met his death by drowning in the Sicilian Sea. Protagoras was the first to call himself a sophist and to teach for pay; his instructions were valued so highly that tradition reports that he received as much as 100 minæ (\$1800) from a single pupil. He enjoyed the intimate friendship of Pericles and won great reputation for his brilliancy and skill. His chief works were entitled, *Truth* ('Αλήθεια or 'Αντιλογικά) and *On the Gods* (Περὶ τῶν θεῶν). His doctrine was a form of agnosticism, which declared that there was nothing absolutely good or bad—that such qualities are based simply on convention; hence it follows that each individual is his own final authority. This teaching is summed up in the (now proverbial) phrase, 'Man is the measure of all things.' Protagoras further turned his attention to grammar and the explanation of difficult passages in the poets; the distinction of genders and moods is also attributed to him. Consult Frei, *Questiones Protagoræ* (Bonn, 1845); Weber, *Questiones Protagoræ* (Marburg, 1850); Blass, *Attische Beredsamkeit*, vol. i.; Ritter and Preller, *Historia Philosophiæ Græcæ* (7th ed., Gotha, 1888); Zeller, *Philosophie der Griechen*, vol. i. (5th ed., Leipzig, 1892); Ueber-

weg, *History of Philosophy*, English translation, vol. i. (New York, 1872); Erdmann, *History of Philosophy*, English translation, vol. i. (New York, 1890).

PROTECTION (Lat. *protectio*, from *pro-tegere*, to protect, cover over, from *pro*, before, for + *tegere*, Gk. *στέγειν*, *stegain*, Skt. *sthaḡ*, to cover, Lith. *stogas*, roof, OIr. *teḡ*, house, OHG. *dah*, Ger. *Dach*, AS. *þac*, Eng. *thatch*). The term applied to the policy of encouraging and developing home industries by means either of bounties paid to home producers or of duties imposed upon goods imported from abroad. The encouragement afforded by bounties is so direct and certain that they have been preferred to duties by many writers, including Alexander Hamilton. Nevertheless they have been little used in practice, because of their cost and of administrative difficulties connected with them. The latest examples of the use of bounties are afforded by the sugar bounty provided in the United States tariff of 1890 (the McKinley Act) and the export bounties on the same commodity paid by Germany and some other European States. The former remained in force only four years, and is not likely to be revived, while the latter have been abrogated except in the case of Russia by the Brussels Sugar Convention.

Import duties serve to encourage home industries under the following circumstances: They must apply to goods that may be produced within the country imposing them; they must not be offset either by reductions in the export prices of the commodities taxed nor by internal revenue duties on the same commodities produced within the country; finally, they must serve to raise the prices of the taxed articles in the home market sufficiently to make their home production profitable. Given these conditions, a duty is increasingly protective according to the completeness with which it excludes the foreign producer from the home market. Its purpose is directly opposed to the acquisition of revenue, since it becomes perfectly protective only when it prohibits all importation, that is, ceases to afford any revenue whatever. It is for this reason that highly protective tariffs need to be supplemented by revenue schedules and even internal revenue duties to satisfy the fiscal requirements of modern governments. See **TARIFF**.

The policy of protection does not differ outwardly from the restrictive policy advocated by the Mercantilists (see **MERCANTILISM**), but is defended on grounds quite independent of their erroneous balance of trade theory. As pointed out elsewhere (see **FREE TRADE**), protection is the policy practiced by most of the governments of the world. In this article attention will be directed to protection as it has been applied in the United States. Similar arguments to those reviewed are advanced in justification of the policy in other countries, and there is therefore no occasion to repeat them.

When the American colonies gained their independence, free exchange with the mother country was the policy advocated on all sides. The restrictive measures put in force by England herself after 1783 made the realization of this ideal impossible and fostered a sentiment in favor of protection to home industries as a means of rendering the United States industrially, as it had become politically, independent. Tariffs passed by Massachusetts and Pennsylvania in 1785-86

reflect clearly this protectionist attitude, as does the first national tariff passed in 1789. There was still some misgiving as to whether the country was adapted to manufacturing, however, and the first Secretary of the Treasury, Alexander Hamilton, was asked to submit to Congress a report on manufactures, together with recommendations to guide its future policy.

The famous *Report on Manufactures* was submitted in December, 1791, and has remained down to the present day one of the most important documents in the literature of protection. Hamilton reviewed the arguments for and against protection, described the development of manufactures in the United States, the resources of the country fitting it for manufacturing industries, and the policy of Great Britain in taxing its exports. He concluded that in the light of the actual situation a moderate protective policy designed to build up within the country all of the industries necessary to national independence and to the most rapid development of natural resources was advisable. In coming to this conclusion he ascribed great importance to England's restrictive policy, and said repeatedly that but for these restrictions a freer policy on the part of the United States might be desirable. He also emphasized his conviction that industrial independence is indispensable to continuous political independence, and that it is the part of wisdom for a new country to foster within its borders, even at considerable sacrifice, the industries necessary to a complete national life, not forgetting those concerned with the munitions of war. Hamilton's arguments continued to carry great weight with American statesmen down to about 1850, when England's secession to free trade and the undoubted ability of the United States to hold its own in any international complication that was likely to arise had deprived them of their force.

During the years immediately following the completion of Hamilton's report, the situation was so favorable to the development of the shipping industry of the United States that little attention was given to the question of protection. The Napoleonic wars made shipping under the flag of a European State hazardous and gave America, as the only important neutral country, the lion's share of the world's carrying trade. While this condition continued, shipping and commerce flourished in an unprecedented fashion. The situation was abruptly changed by Napoleon's Berlin Decree and the British Orders in Council of 1806-07, which set up a paper blockade of all important European ports and deprived American merchant vessels of the immunity which they had previously enjoyed. The United States retaliated with the Embargo (1807) and the Non-Intercourse Act (1809), and finally became involved in the War of 1812. From 1807 to 1815, in consequence of these difficulties, the United States was more nearly isolated industrially than ever before or since. Foreign trade was almost entirely suspended and the country was forced to produce for itself nearly all of the commodities which it required. It was during this period that manufacturing first developed to the position of an important American industry. When it ended, the industrial situation was so different from that described by Hamilton that the whole question of protection assumed a new aspect.

The Tariff Act of 1816, the first out-and-out protective tariff that the country had known, was defended more on the ground of protecting industries already established than of building up new industries. In fact, the highest duties provided were to remain in force only three years, since it was believed that by that time our manufactures would be adjusted to the conditions of peace and able to hold their own against foreign competitors. The erroneousness of this view was soon demonstrated, and succeeding tariffs continued the protectionist policy, although with modifications, down to 1857. During this period the 'vested interests argument,' the 'home-market argument,' and the 'infant-industry argument' were those most frequently urged in support of protection. The vested interests plea needs no explanation. It is always urged by conservative people in favor of the continuance of an established policy and does not pretend to throw any light upon the expediency or in expediency of the policy itself. The home-market argument, as advanced by Henry Clay, the father of the 'American system,' as protection began to be called, was designed to reconcile the interests of the agricultural South and West with those of the manufacturing North. It rested upon the proposition that the prosperity of the American farmer depends upon a regular and constant market for his products and that such a market is to be obtained only by building up manufacturing centres within the country. The experience of the years from 1816 to 1825 was cited to prove that the foreign market was not to be depended upon, and farmers were exhorted to unite with manufacturers in establishing a system which should bind different sections of the country together by furthering the interests of all. To the greater stability claimed for the home market—a quality now seriously questioned by economists—later analysis has added another merit. The home market calls not only for the stable products which will bear ocean transportation, but for all kinds of perishable goods. Substituting it for the foreign market renders possible diversified farming and enables cultivators to substitute for one-crop systems of agriculture scientific rotation of crops, which serves to preserve and perpetuate the fertility of the soil. This advantage is believed by protectionists to outweigh the admitted losses incidental to the protectionist policy and to insure in the long run a greater degree of prosperity than will result from the free play of economic forces.

The infant-industry argument is the one to which economists generally have conceded greatest weight. It is urged in both a special and a general form. As it applies to special industries, it rests on a recognition of the risks and difficulties which attend the domestication of new branches of production. In the successful prosecution of any industry three factors cooperate—the requisite natural resources, skilled and unskilled workmen of different grades, and the appropriate forms of capital. As regards each one of these the country which has practiced an industry has a marked advantage over the country which has not. The natural resources of the latter may be superior, but they are undeveloped; its labor force may be ample and adaptable, but it is untrained; its people may be competent to use tools and machines, but they have no familiarity with the special forms of capital

needed. Under such circumstances the encouragement of a protective tariff may suffice to induce investors to establish the new industry when without it they would not venture on such a step. After a few years, if the industry to be domesticated has been wisely chosen, the initial difficulties will have been surmounted and the protective duty may be withdrawn without danger of crushing out the now vigorous infant. Advocates of such a policy recognize quite clearly that resort to protection entails a serious burden on consumers. They justify the temporary loss on the ground that the establishment of the new industry on a permanent footing affords in the end a more than compensating gain.

The infant-industry argument in its general form recognizes that countries must usually pass through different stages of industrial development, and advocates protection as a means of accelerating progress during the periods of transition from one stage to another. The best statement of this argument is that given by Friedrich List in his *Das nationale System der politischen Oekonomie* (1841). The conclusions at which List arrived were based on the contrast between an industrial country like England and an agricultural country such as Germany was at the time he wrote. In his opinion England's success as a manufacturing country was due chiefly to the development of certain industrial qualities among her people. Germany, he thought, might develop the same qualities among Germans by means of a protective policy which would force them to manufacture for themselves. Through protection the natural resources of the country necessary to the development of manufacturing would also be opened up to exploitation. From this point of view protection is a temporary means by which an agricultural country may transform itself into an industrial country. After the transformation is completed the new manufacturing industries, or at least a great many of them, will be quite capable of holding their own in competition with the manufacturing industries of other countries and protection will be no longer required.

The last stage in the development of protection in the United States was closely connected with the Civil War. The outbreak of that struggle caused the withdrawal from Congress of the Representatives of the Southern States, who had been the most active opponents of the protective policy. Under the guidance of Representatives from the North and West successive tariffs were passed carrying the policy of protection to the most extreme lengths which the country had known. Factors in this development were the anti-foreign sentiment which resulted from the somewhat hostile attitude of Europe and especially of England to the cause of the North, and the comprehensive system of internal revenue taxation adopted during the war, which had to be offset by higher import duties if American producers were not to be placed at a disadvantage in competition with foreign producers. The change in the level of duties which resulted from this combination of circumstances is indicated by the fact that whereas under the act of 1857 the highest duties imposed were 24 per cent. *ad valorem*, under the act of 1864 the average rate on dutiable articles was over 47 per cent. During the first 15 years after the close of the war the attention of Congress was occupied by questions

of reconstruction, the resumption of specie payments, etc., and no change of importance was made in the tariff except that it became increasingly protective as the internal revenue duties were one by one removed. When attention was again concentrated upon the tariff question the attitude of protectionists was that of conservatives desiring to continue a policy which had been tried and found successful, and upon advocates of free trade rested the responsibility of wishing to overturn an established institution. Down to 1894 all of the important changes made in the tariff were in the direction of increased protection. The Wilson Act of the latter year was a reactionary measure, but was so garbled in its passage through Congress that the tariff-reform President of the period, Mr. Cleveland, allowed it to become a law without his signature. The victory of the Republicans in 1896, although not connected with the tariff issue, involved as an incident a return to a highly protective policy. In fact, the Dingley Act of 1897 marks the extreme limit of protectionist policy in the United States down to date.

During this last period only one new argument of importance has been advanced in support of protection, the 'wages argument.' Before protection was the settled policy of the country one of the reasons urged in its favor was that since wages were higher in the United States, some special encouragement was necessary to the establishment there of new industries in competition with the low-wage labor of Europe. After protection became a settled fact, by an interesting inversion, the high wages of American labor began to be attributed to it. The wages argument runs as follows: In protected industries higher wages are paid in the United States than in similar industries abroad. Protection, it is concluded, causes the high wages, and its withdrawal would pauperize American labor. This view overlooks several important facts. First, equally high wages are paid in unprotected industries, and these industries, which include farming, mining, transportation, and many branches of manufacturing, vastly exceed in importance and magnitude the protected industries. Second, employers, whether protected or unprotected, desire to secure their labor as cheaply as they can, and there is nothing in a protective tariff which forces them to pay higher wages than are current in the community in which the protected industries are situated. In other words, employers in protected industries pay the wages necessary to get the labor they require, and these depend not upon the protective tariff, but upon general industrial conditions. Third, it is not true that high wages and protection always go together. For example, wages in protectionist Germany are distinctly lower than in free-trade England. For these reasons the wages argument, although effective for campaign purposes, has never enjoyed much repute among trained economists. It is, however, urged in a more subtle way by some writers, and in this form merits consideration.

It is argued that the wealth produced in any country is divided into wages, profits, and rent, and that the amount of the last share depends upon the poorness of the marginal land and other natural resources to which resort is made. Protection, as applied in the United States, diverts labor and capital from farming and extractive

industries to manufacturing. In consequence, it is claimed, the margin of cultivation to which resort is made is somewhat higher under a protectionist than it would be under a free-trade policy and rents are lower, while wages and profits together are proportionately higher. Hence, it is concluded, protection raises wages at the expense of rent and 'other monopoly incomes.' In answer to this argument it need only be pointed out that the reasoning, if valid, proves merely that protection secures for labor a larger *relative* share of the total product. If, in so doing, it diverts labor and capital from investments in which they would afford larger returns, as advocates of free trade maintain, it may very well be that labor's larger share of the *smaller* product obtained under the régime of protection is actually less than would be labor's smaller share of the *larger* product that would be secured under the régime of free trade.

Present-day advocates of protection in the United States may be divided into two classes—those who defend it as a temporary and those who defend it as a permanent policy. Among the former it is beginning to be actively discussed whether protection has not done its greatest possible service for the country and whether a gradual transition to a free-trade policy would not be desirable. Writers answering these questions in the affirmative advocate the abolition of the protective duties on raw materials, trust-made manufactures, etc., and emphasize the importance of allowing foreign goods to enter the country more freely in order that American industries capable of developing an export trade may find larger foreign markets for their products. Advocates of protection as a permanent policy urge it not only on economic grounds, but as a means of fostering the sentiment of nationality and of perpetuating those characteristics which distinguish the United States from other countries. Free trade is characterized by them as a cosmopolitan policy, which appeals to the 'foreign-hearted,' while protection is extolled as the national system to the support of which all true lovers of country must rally. Strong as is the appeal which these 'higher considerations' make to the patriotic citizen, there is a certain vagueness about their application to tariff problems which makes the shaping of a law by reference to them difficult. Appeals to patriotism in connection with protection are significant chiefly because they introduce a moral earnestness into discussions which would otherwise be narrowly commercial.

Since Great Britain adopted a free-trade policy in 1846, the leading protectionist country of the world, next to the United States, has been Germany. There also the application of protection has been coincident with a remarkable development of manufacturing industries, which has seemed to justify fully the expectations of advocates of the policy. Germany's success in domesticating manufacturing industries has led France, Austria-Hungary, and, more recently, Russia, to emulate her example. Europe is thus engaged in a war of hostile tariffs, in which each important country is trying to build up its own industries by discouraging importations from its neighbors. In each country there is vigorous opposition to the protectionist policy, just as there is in the United States, but it is doubtful whether this opposition is making much real headway. There

are, however, indications that as time goes on the areas embraced within protectionist barriers in different parts of the world will be enlarged. In Europe there is already agitation for a federation of important States for the purpose of erecting an unbroken tariff bulwark against the 'American invasion.' In Great Britain an imperial federation to include all of the dependencies of the country in a commercial alliance against the rest of the world is beginning to be advocated. Finally, the policy of expansion upon which the United States seems to be embarked must have as one of its incidents the admission of new areas within the American tariff wall. As protectionist areas grow, the difficulty of harmonizing divergent interests by means of protective tariffs is bound to increase, and this affords perhaps the surest ground for a belief in the eventual triumph of free trade.

BIBLIOGRAPHY. Hamilton, *Report on the Subject of Manufactures* (1790), reprinted in Tausig, *State Papers and Speeches on the Tariff* (Cambridge, 1892); List, *Outlines of American Political Economy* (Philadelphia, 1827); id., *Das nationale System der politischen Oekonomie* (1841; trans., *National System of Political Economy*, Philadelphia, 1856); Carey, *Harmony of Interests* (2d ed., New York, 1856); id., *Principles of Social Science* (3 vols., Philadelphia, 1858-59); Phillips, *Propositions Respecting Protection and Free Trade* (Boston, 1850); Thompson, *Protection of Home Industry* (New York, 1885); Patten, *The Economic Basis of Protection* (Philadelphia, 1890).

PROTECTIVE ASSOCIATION, AMERICAN.

A secret organization, commonly known as the A. P. A., which was formed in the United States to combat the influence of Roman Catholicism. Its platform, as published by a Supreme Council held at Des Moines, Iowa, in May, 1894, stated that "subjection to and support of any ecclesiastical power not created and controlled by American citizens is irreconcilable with American citizenship," that State assistance to parochial schools and Church interference with public education are undesirable, and that restrictions ought to be imposed on immigration. Candidates for admission into the order were required to take oath never to favor or aid the choice of a Roman Catholic to political office, and never to employ a Roman Catholic in any capacity if the services of a Protestant could be obtained. The order was first established at Clinton, Iowa, in 1887. It obtained its greatest foothold in the Middle West, but it extended even to Canada, England, and Australia, and an international organization was ultimately effected. In 1896 its president, W. J. H. Traynor, claimed for it a membership of almost 2,500,000. The methods which it used to extend its influence are thus described by a writer in *The Nation*: "Documents purporting to be authoritative utterances of the Roman Catholic hierarchy were passed from hand to hand. No one could tell where these were printed or who was responsible for them. One was entitled 'Instructions to True Catholics;,' another purported to be an encyclical letter from the Pope, calling upon the faithful to rise on a certain date (September 13, 1893) to massacre all Protestant heretics. Certain newspapers, filled with similar literature, with the most alarming reports of Roman Catholics drilling and arming in preparation for an outbreak, and

making the most shocking charges against priests and nuns, were sent to prominent persons and distributed from hand to hand. Accompanying these were exaggerated reports of the number of Roman Catholics holding public office." The order soon began to interfere in politics, and forced many candidates for office to promise to act in accordance with its principles. In 1896 its president claimed that almost one hundred of the National Representatives and many of the Senators chosen in 1894 had given such pledges, although many had broken them. For a time it seemed that the order would probably run a similar course to the Know-Nothings (q.v.), with which it was often compared. Soon, however, the denunciations of clear-sighted, influential men, and the realization that the dangers dreaded were almost if not altogether imaginary, had their effect, and the decline of the order was even more rapid than its rise. Affiliated with the A. P. A. were the United Order of American Mechanics, the Patriotic Order of the Sons of America, and other organizations.

PROTECTIVE COLORATION AND RESEMBLANCE.

All organisms are beautifully adapted to the world around them, and this adaptation in a large proportion of animals extends to their colors. The adaptive coloration of animals, the harmony in tint and form with the trees or herbs on which they live, the moss-grown rocks among which they hide, or the sand over which they run, are a part of the general adaptation or harmony in nature. A desert animal is of a sandy complexion, a silkworm moth is brown, and the zebra, tiger, leopard, and butterflies are striped and barred or spotted, in response to the same agencies of light, heat or cold, moisture or dryness, that have had to do with the origin of species. Owing to this adaptive coloration, certain insects, frogs, reptiles, birds, and mammals are protected from the observation of their natural enemies.

In marine fishes the ground coloration is, according to Jordan, protective in its nature. The fish, especially if swimming near the bottom, is better protected if the olivaceous surface is marked by darker cross sheaths and blotches. These give the fish, he says, a closer resemblance to the weeds about it, or to the sand or rocks on which it lies. As a rule no fish which lies on the bottom is ever uniformly colored. At a depth of from 50 to 150 fathoms in the tropics a large proportion are red of various shades. Several of the large groupers of the West Indies are represented by two color forms; the shore form is olive green, and the deeper-water form is crimson. Deep-sea pikes are black or violet black, with no markings. Desert animals are gray or tawny or sandy; forest animals are green, marine animals olive or reddish, pelagic animals transparent while the typical Arctic mammals and birds are white; the white color of their feathers or fur was undoubtedly primarily due to the cold of the glacial period. The polar bear, hare, snowy owl, and Greenland falcon are white throughout the year, while the fox, lemming, American hare, ermine stoat, and ptarmigan change their summer dress of russet to white. There has been much discussion as to the causes of the white color of Arctic animals. It is by many attributed to cold, and this is evidently the primary cause, but to cold we should add dryness.

The blanching of the hairs is due to partial, not entire, depigmentation.

COLOR PREFERENCE. Different aquatic animals exhibit a marked preference for certain colors of the spectrum in which they 'feel better.' The little fresh-water crustacean *Daphnia* prefers to swim in orange, yellow, and especially green rays. The starfish shuns the red rays. Animals which love the light, as bees, prefer blue or green rays, while the light-shunning or lucifugous insects, such as ants, have less antipathy for red than for other colors. In such cases it has been thought by Cuenot that light doubtless acts as an excitant on respiration. As has been repeatedly noticed, the common house-fly prefers green to lavender, and black to white. On the other hand, locusts are attracted and will alight upon white or light-colored clothes, and not be attracted by dark. The preference of flies for dark cloth may be due to the fact that it absorbs more heat than white cloth, and thus favors quicker respiration and greater activity, especially in the coolness of the autumn.

PROTECTION DUE TO CONSPICUOUS BARS, STRIPES, AND SPOTS. Although the giraffe, the zebra, and the jaguar seem most conspicuously colored, we are assured that the spots upon the jaguar, for example, harmonize with the oval patches of sunlight. Sir Samuel Baker says that the striped skin of the tiger harmonizes with dry sticks, yellowish tufts of grass, and the remains of burnt stumps of its habitat, and even the giraffe is far from conspicuous when found in its native forests. The African antelopes are strikingly marked on the body and head as well as the feet with white stripes and patches in general like those of zebras, which Pooock regards as "representing spots or streaks of sunlight passing through foliage or reflected from leaves," and that these marks are for protection rather than for recognition. He thinks that such markings come within the scope of Thayer's hypothesis of concealment by the counteraction of light and shade. Of the species of elands of Africa one lives in the forest and is reddish and conspicuously striped with white, the neck being black; on the other hand, the common eland is dun-colored with no sign of stripes and lives in deserts. So it is with the koodoos; the lesser one living in thick jungles is much more strikingly marked than the larger species which lives in hilly mountainous regions or on the open plains.

MIMICRY. Many butterflies of the group *Heliconiidae* are associated with species of *Leptalis* belonging to another family (*Pieridae*) which copy the heliconid butterflies in form and color, and which, probably owing to a bad odor secreted by glands in the end of the body, are distasteful to birds. It is supposed by Bates, Wallace, Darwin, and others that were not the mimics disguised as heliconias they would be devoured by birds and thus become extinct. These authors believe that the resemblance has been brought about by natural selection. In his "Contributions to an Insect Fauna of the Amazon Valley," Henry Walter Bates (q.v.) calls attention to the fact that a large number of the species of *Heliconiidae* "are accompanied in the districts they inhabit by other species which counterfeit them." According to Fritz Müller (although Bates states the same idea), the species serving as the model, being unpalatable to birds on account of its repulsive taste and odor, is therefore safe from its

foes, while the mimic, which has no bad taste or odor, is protected from attack. Mr. Bates's own views are moderate compared with those of Wallace and later extreme advocates of Darwinian mimicry. In his original essay Bates shows that the majority of the species of *Heliconiidae* have very limited ranges, and contends that the cause of the formation of the local varieties is "the direct action of physical conditions on the individuals." Several entomologists, Elwes, Packard and others, have not accepted the hypothesis of Bates and Müller, that the mimicry is due to natural selection, but hold that the mimicry is accidental and due to convergence to similarities in the environment. The markings, such as similar hues in models and mimics, bars and spots, Packard believes are due to such effects of light and shade, moisture and temperature, as have produced them in birds, mammals, and reptiles. They may be perpetuated and preserved by natural selection, but the primary cause of this originally is the action of the physical agents mentioned, or at least environmental causes affecting both models and mimics. Much stress is laid on the attacks of birds in bringing about or aiding the process of natural selection of these markings. It is, however, to be observed that neither Bates, Müller, nor Wallace, all of whom lived for many years in the tropics, has ever seen a bird chase and devour butterflies. In fact, only a few insectivorous birds catch butterflies or care to chase them. After several years' special research on the habits of sparrows and other insectivorous birds, Judd states in a report to the United States Department of Agriculture that he does not know of any kind of bird "that feeds upon butterflies during any month of the year to the extent of one-tenth of one per cent. of its food."

It thus appears from a comprehensive survey of the markings of animals of different classes, living both in the sea and on land, that the causes of the similarity in their markings are due to the effects of light and shade, also perhaps to moisture—at all events to the action of the surroundings. It should also be borne in mind that the range of primary colors is not very great, nor of stripes and bars; under similar physical conditions the colors and spots and stripes and their location on the body are repeated in animals of different groups and species. Nature is limited in the disposal of ornamental features. Hence models and mimics may be protectively ornamented with the same hues and patterns, and it is probable that selection and the attacks of birds and lizards have had little to do with the origination of protective coloration.

BIBLIOGRAPHY. Darwin, *Origin of Species* (London, 1859), *Descent of Man* (ib. 1874); Wallace, *Darwinisms* (New York, 1889); Bates, "Contributions to an Insect Fauna of the Amazon Valley. Lepidoptera: Heliconiidae," *Transactions Linnæan Society of London*, vol. xxiii. (1862); Packard, *Half Hours With Insects* (Boston, 1877); Scudder, *Butterflies of the Eastern United States* (ib., 1887-89); Müller, *Transactions of the Entomological Society* (London, 1879); Poulton, *The Colors of Animals* (New York, 1890); Beddard, *Animal Coloration* (ib., 1895); Belt, *The Naturalist in Nicaragua* (London, 1874); Morgan, *Animal Life and Intelligence* (ib., 1890-91); Eimer, *Organic Evolution* (ib., 1890); Marshall and Poulton, "Bionomics of South

African Insects," *Transactions Entomological Society of London, 1892*; Fischer, "Weitere Untersuchungen über die Vererbung erworbener Eigenschaften," *Allgemeine Zeitschrift für Entomologie*, vol. vii (1892); Piepers, *Mimicry, Selektion, Darwinismus* (Leyden, 1903); with the writings of Weismann, Trimen, Cope, Meldola, Haase, Von Linden, Sokolowsky, Portchinsky, Riley, Weir, Semper, Von Wattenwyl, Schröder, Butler, Distant, Zenneck, Werner, Escherich, Peckham, Hickson, Herdman.

PROTECTOR. An English title equivalent to that of regent, denoting a non-regal head of the Government under exceptional circumstances, as during a minority or an interregnum. The title was given to Humphrey, Duke of Gloucester, during the minority of Henry VI. from 1422 until the crowning of the young King in 1430. Richard, Duke of York, father of Edward IV. and Richard III., acted as Protector of the Kingdom at different times during the later years of Henry VI.'s reign. His son, Richard, Duke of Gloucester, was Protector for about two months in 1483, prior to his accession in the same year as Richard III. The Duke of Somerset, at the head of a council during the minority of Edward VI., bore the title from 1547 to 1549, until he was deposed by his colleagues. In 1653 Cromwell was installed as Lord Protector of the Commonwealth of England, Scotland, and Ireland under the provisions of the Instrument of Government (q.v.), and in 1657 was reinstalled under the provisions of the Humble Petition and Advice. On his death, in 1658, his oldest son, Richard, succeeded to the title and authority, but resigned the office in the following year.

PROTECTORATE. A relation assumed by a stronger nation toward a weaker one whereby the former protects the latter from hostile invasion or dictation and interferes more or less in its internal affairs. This relation is established by treaty between the protecting and the protected State, or among a number of States in respect to another State, by which the extent and character of the protectorate are determined. Usually the foreign relations of the protected State, including the right to wage war, are controlled by the protecting State. Examples of existing protectorates are Tunis, under French protection, and North Borneo, Bechuanaland, Somaliland, British Central Africa, and British East Africa, under British protection.

PROTEIDS. See PROTEINS.

PROTEINS (from Gk. *πρωτος, prōtos*, first). A name applied to an exceedingly important group of chemical substances, occurring abundantly in the organisms of animals and plants. The principal component elements of the proteins are carbon, hydrogen, oxygen, and nitrogen. When burned, however, the proteins generally leave behind a certain amount of mineral matter, and it is as yet unknown whether such mineral constituents form with the organic portion of the proteins true chemical compounds, or merely physical mixtures. The classification of the proteins is based, not on their chemical constitution, as in the case of most other groups of carbon compounds, but on a knowledge of some of their physical properties and of their behavior toward certain reagents. Such a classification is from a scientific point of view very imperfect, and so it must remain until light shall be thrown upon the

arrangement of the atoms within their molecules. This, however, is a very difficult problem. In the first place, the proteins are as a rule quite unstable and are strongly affected by ordinary chemical reagents and by relatively slight changes in the physical conditions. Further, any one familiar with the methods of determining the constitutional formula of an organic compound (see CARBON COMPOUNDS) will readily see the difficulty of ascertaining the constitution of a compound, for instance, like the oxyhæmoglobin of horses' blood, whose molecular formula is, according to Häfner, $C_{555}H_{1225}N_{149}S_2FeO_{149} \cdot 28H_2O$. Yet this is a crystalline compound, and so it is probable that it has been isolated. In the case of amorphous substances, as most proteins are, even this often remains uncertain, and then our knowledge is from the point of view of the theoretical chemist very imperfect indeed. It must also be remembered that the protein substances as they exist in the organism of a living animal or plant are probably more or less different from what they are when examined in the test-tube of a chemist. What the difference consists in is not known, for we are entirely ignorant of the nature and character of living matter. And so all statements concerning the proteins refer to dead protein alone.

In discussions of the food and nutrition of man and animals the term 'protein' is commonly applied to the total nitrogenous material present in the food or feeding stuffs of animal and vegetable origin, and includes a number of different groups of compounds with correspondingly different nutritive values. The group in its relation to nutrition is commonly subdivided as follows:

Protein	{	Proteids	{ Albuminoids. Collagens or gelatinoids.
		Non-proteids	{ Amides. Amido-acids, etc.

The albuminoids, sometimes called 'true proteids,' which include albumin, globulin, etc., are the most important of the nitrogenous constituents of foods, examples being the albumin of milk and eggs, the casein of milk, myosin of meat, gluten of wheat, etc. The gelatinoids are mostly of animal origin and include collagen, gelatin, elastin, keratin, etc., bodies which are characteristic of connective tissues as tendons, ligaments, horns, etc. Distinguished from the above are the non-proteids, which include the kreatin, kreatinin, and other extractives of meat, and the amides, amido-acids, etc., of vegetable foods.

In general the protein of animal foods and cereal grains is very largely composed of proteids, especially those designated above as albuminoids or true proteids. The true proteids can be transformed into nitrogenous body material and thus go to form the blood, muscle, tendon, nerve, etc., of the animal body. They are also sources of energy. Gelatinoids, such as gelatin, when burned in the body, yield energy, but cannot go to form nitrogenous tissue. Like carbohydrates and fat, gelatinoids undoubtedly protect protein from cleavage. The non-proteids, though useful to give flavor, etc., appear to have but little nutritive value except in so far as they serve as fuel for the body. It may be that some of them have an especial use as spacers of protein. Thus it has been suggested that asparagin may serve as a nitrogenous nutrient in the place of proteids for

intestinal bacteria. However, too little is known of the functions of the non-proteids to warrant very definite assumptions. From what has been said it is evident that protein is essential for building and repairing the body and that it may also be burned in the body to yield energy, the amount being very often estimated as 9.3 calories per gram digestible protein. Thus protein has two functions, whereas fat and carbohydrates have but one, namely, to serve as sources of energy. See Foon.

As noted above, proteids are widely distributed in products of animal and vegetable origin. Green plants build up proteids from simple bodies, obtaining the necessary nitrogen from complex nitrogenous organic compounds occurring in the humus of the soil, from ammonium salts, from nitrates, and from the nitrogen of the air. Among the higher plants it seems to be principally the Leguminosae which can utilize free nitrogen. This they do by the aid of the micro-organisms present in the tubercles on their roots. (See GREEN MANURING.) Amides and asparagin are intermediate bodies in the formation of proteids in plants. It may be said in general that animals derive their proteids primarily from vegetable sources. The changes which proteids undergo before being added to the substance of the body and the possibility of the formation of proteids from simple nitrogenous substances in the body are questions which are not settled or well understood.

CLASSIFICATION OF PROTEIDS. The following classification of proteids, which is an expansion of that given above, is largely that proposed by Halliburton, and is believed to be applicable to both animal and vegetable proteids. It is based chiefly upon differences in solubility of the various bodies:

Proteids	{	Simple proteids	Albumins (Serum albumin, egg albumin, lact-albumin, gluten and gliadin of wheat, zein of maize, etc.)
			Globulins (Fibrinogen, serum globulin or paraglobulin, egg globulin from white of egg, myosinogen from muscle, crystallin from the crystalline lens, wheat globulins, and other vegetable vitellins.)
			Proteoses (Albumoses, globuloses, vitelloses, etc.)
			Peptones (Diffusible end-products of digestion.)
			Coagulated Proteids
			{ Those coagulated by heat.
			{ Those coagulated by ferments (Fibrin, myosin, casein, etc.)
			Haemoglobin
			Compound proteids
			{ Gluco-proteids (Mucin and mucoids.)
{ Nucleins and nucleo-proteids			
Collagens or gelatinoids* (Collagen, casein, gelatin, elastin, keratin, and chitin.)			
Protamines (Histidin, arginin, and lysin.)			

* Halliburton and some others call this group 'albuminoids.' This term is otherwise applied by many investigators and its use as indicated leads to considerable confusion. The term 'collagens or gelatinoids' is perhaps more commonly used in the United States.

The proteids possess a number of general characteristics. All are insoluble in alcohol and ether. Water will dissolve some, but not all. Many of those insoluble in water are soluble in weak saline solutions, and some are soluble and others insoluble in concentrated saline solutions. With the aid of heat all proteids are soluble in concentrated mineral acids and alkalis, but are transformed as well as dissolved. Proteids are soluble by the aid of ferments, as those in gastric and pancreatic juices, but in this case they also undergo a change, adding water and breaking down into proteids of smaller molecular weight known as peptones, intermediate bodies formed in the process being called 'proteoses' or 'albumoses.' Many proteids soluble in water or saline solutions, especially the albumins and globulins, are rendered insoluble or are coagulated when heated. A familiar example of this is the coagulation of egg white in cooking. The temperature required for coagulation differs with different proteids. With the exception of peptones, proteids are colloids, and pass with difficulty, if at all, through animal membranes. Some animal proteids like haemoglobins are crystallizable. A considerable number of crystallizable proteids have been prepared from seeds, nuts, etc., by Osborne and his associates and others. As regards the action of proteids on polarized light, all the proteids are levorotary, the amount of rotation varying with the different kinds.

There are several color reactions characteristic of proteids. Some of the principal ones follow: With strong nitric acid, the proteids when heated to boiling give yellow flakes or a yellow solution, this being known as the xanthoproteic reaction. When a proteid in the solid state or in solution is boiled with a solution of mercuric nitrate in nitric acid containing some nitrous acid (Millon's reagent) a red coloration is produced. This and the former reaction depend on the presence of an aromatic radicle in the proteid molecule. On treating a proteid substance with a little sugar and some strong sulphuric acid a red coloration is produced. On adding to a solution of a proteid body some caustic potash and then a few drops of a very dilute solution of copper sulphate a violet blue color is obtained (biuret reaction). Peptones and albumoses behave somewhat differently, giving a rose-red color instead of violet if only a trace of copper sulphate is used. After being boiled with alcohol and washed with ether, and dissolved in strong hydrochloric acid, proteids give a blue coloration.

Proteids are precipitated by a great many reagents, the peptones and albumoses being excepted in a number of cases. Thus solutions of proteids are precipitated (1) by strong acids as nitric; (2) by picric acid; (3) by acetic acid and potassium ferrocyanide; (4) by acetic acid and excess of neutral salts like sodium phosphate; (5) by salts of heavy metals, as copper sulphate; (6) by tannin; (7) by alcohol; (8) and by saturation with some neutral salts, as ammonium sulphate. When proteids unite with mineral substances the resulting bodies are called albuminates; thus the precipitate formed when copper sulphate is added to a solution of albumin is copper albuminate.

Precipitation should be distinguished from coagulation. The latter term applies when an insoluble or coagulated proteid is formed from a

soluble proteid, which may be brought about (1) by heat; (2) by ferments, as for instance when milk is coagulated by rennet; (3) and when an insoluble proteid is produced by certain reagents, as nitric acid. There are precipitants of proteids which give a precipitate readily soluble in suitable reagents, as saline solution. In such cases the dissolved proteid continues to show its typical reactions.

BIBLIOGRAPHY. Ritthausen, *Die Eiuweisskörper der Getreidearten, Hülsenfrüchte und Oelsamen* (Bonn, 1872); Hammarsten, *A Text-Book of Physiological Chemistry*, translated by Mandel (New York, 1901); Percival, *Agricultural Botany* (ib., 1900); Osborne and associates, *Studies of Proteids* (Connecticut State Experiment Station's Reports, 1890-1901).

PROTELES. See **AARD-WOLF**.

PROTEROGLYPHA (Neo-Lat. nom. pl., from πρότερος, *proteros*, fore, comp. of πρό, *pro*, before + γλύφειν, *glyphein*, to carve). A section of the great group of colubrine serpents including those in which the anterior maxillary teeth are so deeply grooved as to appear tubular, and which form enlarged 'fangs' for the conveyance of poison into the wound made by their bite. (Compare **OPISTHOGLYPHA**.) All are extremely poisonous, most are viviparous, and they are distributed throughout all the warmer parts of the world, except Madagascar and New Zealand. Boulenger and other recent authorities make the group include the colubrine cobras and coral-snakes (Elapinae); the sea-snakes (Hydrophinae); the Amblycephalidae; and the vipers and rattlesnakes (Viperidae).

PROTESILAUS (Lat., from Gk. Προτεσίλαος). A legendary King of Phylace, in Thessaly, son of Jason, and brother of Podarees. Protesilaus married Laodamia, and soon after sailed with the other Greeks to the Trojan War. According to the story, he was the first Greek to spring on shore, and also the first to fall by the hand of Hector. His young wife, Laodamia, overwhelmed with grief at the news, besought the gods that he might return, if for only three hours. Her prayer was granted; Hermes led Protesilaus back to earth, and when the allotted time had passed Laodamia slew herself that she might not again be separated from her husband. According to another version, which seems to have been followed by Euripides in a lost tragedy, Laodamia made an image of her husband and lavished affection on it. Her father, Acastus, sought to take it from her. Protesilaus, probably at his own prayer, returned for a brief space from the lower world, and Laodamia, as in the other story, accompanied him on his return. The legend is represented on several sarcophagi. There was a tomb and sacred precinct of Protesilaus at Elaios on the extremity of the Thracian Chersonese, and apparently an oracle connected with it. In Thessaly also a festival called the Protesilaia was celebrated with athletic contests.

PROTEST (from Lat. *protestari*, *protestare*, to declare publicly, bear witness, from *pro*, before, for + *testari*, to bear witness, from *testis*, witness), **CERTIFICATE OF**. A formal document by a notary public, or other duly authorized person, attesting the truth of some statement of fact, therein contained. It makes its appearance, at times, in shipping (q.v.) transactions, when it contains a statement on behalf of the master of

accidents, or injury, or breaches of duty by charterers or consignees, causing delay or damage to the ship; or a statement by the shipper against the master for misconduct, or delay or refusal to sign customary bills of lading. It is most frequently employed, however, in connection with negotiable paper, for the purpose of affording inexpensive evidence that the paper therein described has been duly dishonored. The law merchant, as it has been understood in England and in this country, requires a protest only in case of a foreign bill of exchange. By modern statutes, however, it is authorized and the fees and expenses thereof are collectible, in the case of an inland bill, check, or promissory note. The protest is to be made by a notary public under his hand and official seal; or by a respectable resident of the place where the instrument is dishonored, in the presence of two or more creditable witnesses. On the day of dishonor, the notary should make a memorandum of the fact that the paper has been duly presented and dishonored. This is termed 'noting.' At his convenience thereafter, he may extend the protest; that is, draw up, sign, and seal the formal certificate. This document must specify: (1) the time and place of presentment; (2) the fact that presentment was made and the manner thereof; (3) the cause or reason for protesting the bill; (4) the demand made and the answer given, if any, or the fact that the drawer, or acceptor, or maker could not be found.

The term 'protest' is often used to designate all of the proceedings which are necessary to fix the liability of a drawer or indorser. In this sense, it includes the notice of dishonor. As a technical term of the law of negotiable paper, however, it is limited to its original signification of a document prepared to bear witness to (*protestari*) the fact of dishonor. Consult: Brooke, *Treatise on the Office and Practice of a Notary of England* (London, 1901); Daniels, *A Treatise on the Law of Negotiable Instruments* (New York, 1903).

PROTESTANT EPISCOPAL CHURCH.

See **EPISCOPAL CHURCH**.

PROTESTANTISM. A term which has become a general designation for the system adopted by the Reformers in the sixteenth century and followed by their successors in later times. The name Protestant was first applied to the adherents of Luther, from their protesting against the decree passed by the Catholic States at the second diet of Speyer in 1529. This decree had forbidden any further innovations in religion and enjoined those States that had adopted the new principles so far to retrace their steps as to reintroduce the mass, order their ministers to avoid disputed questions, and use and explain the Scriptures only as they had hitherto been used and explained in the Church. The essential principles involved in the protest, and in the arguments on which it was grounded, were: (1) that the Roman Catholic Church cannot be the judge of the reformed churches, which are no longer in communion with her; (2) that the authority of the Bible is supreme, and above that of councils and bishops; (3) that the Bible is not to be interpreted and used according to tradition or use and wont, but to be explained by means of itself—its own language and connection. As this doctrine, that the Bible, explained independently of all external tradition, is the sole authority in

all matters of faith and discipline, is really the foundation stone of the Reformation, the term Protestant was extended from those who signed the Speyer protest to all who embraced the fundamental principle involved in it. The essence of Protestantism, therefore, does not consist in holding any special system of doctrines and discipline, but in the source from which and the way in which it proposes to seek for the truth in all matters of faith and practice; and thus a Church might, in the progress of research, see reason to depart from special points of its hitherto received creed, without thereby ceasing to be Protestant. The symbols or confessions of the Protestant churches were not intended as rules of faith for all time, but as expressions of what was then believed to be the sense of Scripture. When, at a later time, it was sought to erect them into unchangeable standards of true doctrine, this was a renunciation of the first principle of Protestantism, and a return to the Catholic principle; for, in making the sense put upon Scripture by the Reformers the standard of truth, all further investigation of Scripture is arrested, the authority of the reformers is set above that of the Bible, and a new tradition of dogmas and interpretation is created which differs from the Catholic tradition only in beginning with Luther and Calvin, instead of with the Apostolic Fathers. The *Protest* at Speyer has been translated in the "Historical Leaflets," published by Crozier Theological Seminary, Chester, Pa. (No. 1, 1901). See REFORMATION.

PROTEUS (Lat., from Gk. Πρωτεύς). In the Homeric poems, a prophetic 'old man of the sea' (*άλτιος γέρον, halties gerōn*) who tends the seal-flocks of Poseidon (Neptune), and has the gift of endless transformation. His favorite residence was the island of Pharos, off the mouth of the Nile; according to Vergil, the island of Carpathos (now Skarpanto), between Crete and Rhodes. Here he rose at midday from the floods, and slept in the shadow of the rocky shores, surrounded by the monsters of the deep. Here he must be sought, and captured by surprise, for he prophesied most unwillingly, and sought to escape by his power of transformation. If, however, his captor held him firmly in every shape, he resumed his original form and revealed the future unerringly. In Herodotus Proteus has become a King of Egypt, who received Paris and Helena, and retained the latter, while Paris took only a phantom with him to Troy. On the arrival of Menelaus in Egypt after the fall of Troy, Proteus restored to him his wife.

PROTEUS. A slender pennisbranchiate salamander (*Proteus anguinus*), called 'olin' by the Germans, which is closely related to the North American mud-puppy (q.v.), and is found in subterranean waters, in the absolutely dark limestone caverns of Carniola, Carinthia, and Dalmatia. Almost nothing is known of its habits. It is 10 or 12 inches long, seldom above half an inch in thickness, and pinkish-white with the gills carmine-red. Specimens have been kept alive in confinement for several years, in a darkened aquarium, apparently without food. It lays eggs, and fastens them singly to stones under water, and the larvæ nearly resemble the adults. Consult Gadow, *Amphibia and Reptiles* (London, 1901).

PROTEVANGELIUM OF JAMES. See APOCRYPHA.

PROTHALA'MION (Neo-Lat., from Gk. πρό, *pro*, before + θαλάμιος, *thalamios*, nuptial, from *θάλαμος, thalamos*, bridal chamber). A poem by Edmund Spenser (1596), written for the double marriage of Elizabeth and Catherine Somerset, daughters of the Earl of Worcester.

PROTHALLIUM, PROTHALLUS (Neo-Lat., from Lat., *pro*, before + *thallus*, from Gk. *θαλλός, young twig*). The sexual generation (gametophyte) of ferns; often extended to include the gametophytes of seed-plants. See PTERIDOPHYTES.

PROTHERO, prōth'e-rō', GEORGE WALTER (1848—). An English historian and biographer, born in Wiltshire, and educated at Eton, at King's College, Cambridge, and at the University of Bonn. He was tutor at King's and university lecturer in history from 1876 to 1894, professor of history at Edinburgh until 1899, and then editor of the *Quarterly Review*, on which he succeeded his brother. He wrote: *The Life and Times of Simon de Montfort* (1877) and a *Memoir of Henry Bradshaw*; edited *Select Statutes* from the reigns of Elizabeth and James I. (1894) and the *Growth of British Policy* (1895), by J. R. Seeley, whose life he wrote for the *Dictionary of National Biography*; and was editor of the *Cambridge Historical Series* and co-editor of the *Cambridge Modern History*.

PROTHERO, ROWLAND EDMUND (1852—). An English writer, born at Clifton-on-Teme, in Hampshire, September 6, 1852. He was educated at Marlborough School, and at Balliol College, Oxford, where he graduated with honors in both classics and modern history, and obtained a fellowship of All Souls' College (1875). From 1894 to 1899 he edited the *Quarterly Review*. His principal publications are: *Life and Correspondence of Dean Stanley* (1893); *Letters and Verses of Dean Stanley* (1895); *Letters of Edward Gibbon* (1896); *H. R. H. Prince Henry of Battenberg* (1897); *Life of Queen Victoria* (1897); and *Letters and Journals of Lord Byron* (1898-1900).

PROTHESIS. See ETYMOLOGY, FIGURES OF.

PROTHONOTARY WARBLER (OF. *prothonotaire*, Fr. *protonotaire*, from ML. *protonotarius*, chief notary, from Gk. *πρότος, protos*, first + Lat. *notarius*, notary, scribe, from *nota*, mark, from *noscere*, to know; ultimately connected with Eng. *know*). A wood-warbler (*Protonotaria citrea*) of the Mississippi Valley, from southern Illinois southward. It is rich yellow over the head and neck and lower parts, and olive green upon the back, wings, and tail, with the lining of the wings and the tail-coverts white. It is peculiar principally in nesting in holes in old trees.

PROTISTA (Neo-Lat. nom. pl., from Gk. *πρότιστος*, very first, superl. of *πρότος, protos*, first, from *πρό, pro*, before). A group-name proposed by Haeckel in 1878 for the lowest Protozoa and Prolophyta; it forms a neutral kingdom, containing the simplest plants and animals. Haeckel claims that the Protista show in their external form, structure, and vital phenomena such a remarkable mixture of animal and vegetable properties that they cannot justly be assigned to either the vegetable or animal kingdom. Haeckel's chief classes are the following, in the order given: *Monera*, including the bacteria, *Lobosa* (Amœba and allies), *Gregarina*, *Flagel-*

lata, *Catallacta*, *Ciliata* (Infusoria), *Acinetæ*, *Latymithuceæ*, *Bacillaræ* (Diatoms), *Fungi*, *Myxomycetes*, *Metamorphora* (Rhizopoda), *Heli-zoza*, and *Radiolaria*. This grouping satisfies neither the botanist nor the zoölogist, and has not generally been accepted by them. In fact, we should not expect the most primitive organisms to present clearly marked characters; they are undifferentiated forms with a common mode of reproduction.

PROTIUM, *prō'shī-ūm* (Neo-Lat., perhaps from a Javanese name), formerly called *ICICA*. A genus of pinnate-leaved trees of the natural order Burseraceæ, with white flowers in paniced racemes. *Protium Icariba*, a Brazilian species with fragrant resinous seeds, yields American elemi (q.v.); *Protium heptaphyllum* and *Protium Guianense*, natives of Guiana, yield fragrant balsams, which harden into a gray resin, used as incense in churches; *Protium altissimum*, another Guiana tree which attains a height of 100 feet, is used in house carpentry, canoe and furniture making. Its wood is known as white cedar, red cedar, acuyari, Samaria, Mara, and Curana wood.

PROTCERAS (Neo-Lat., from Gk. *πρῶτος*, *prōtos*, first + *κέρας*, *keras*, horn). A primitive ungulate found fossil in the White River beds of South Dakota. The animal was somewhat larger than a sheep and had a long narrow skull, armed in the male with two to six pairs of horns and in the female with one pair of small protuberances. The upper incisors are absent, the lower incisors well developed, and the upper canines of the

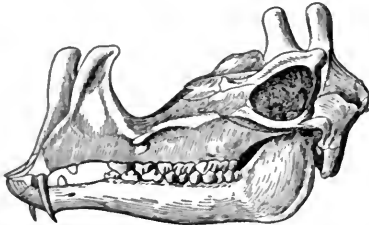

PROTCERAS SKULL.

male are much enlarged to form tusks. The ancestry and descendants of this animal are unknown and it constitutes a distinct isolated family remotely related to the modern chevrotains (*Tragulidæ*) of the Indo-Malayan region and West Africa. Consult Scott, "Osteology and Relationships of Protoceras," in *Journal of Morphology*, vol xi. (Chicago, 1895).

PROTOCOL (ML. *protocollum*, from MGk. *πρωτόκολλον*, *prōtokollon*, protocol, first leaf glued to a manuscript, from Gk. *πρῶτος*, *prōtos*, first + *κόλλα*, *kollan*, to glue, from *κόλλα*, *kolla*, glue). A term of diplomacy applied to the minutes or preliminary draft of an instrument or agreement between two or more States and intended to serve as the basis of negotiations for the conclusion of a definite treaty. The term is also applied to the formally authenticated minutes of the proceedings of a congress or conference, as where a number of friendly powers enter into a preliminary agreement to accomplish certain diplomatic ends by peaceful means.

PROTOGENES (Lat., from Gk. *Πρωτογένης*). A celebrated painter of ancient Greece who was

born at Caunus, in Caria, and practiced his art at Rhodes. He was a contemporary of Apelles, working in the latter part of the fourth century. Pliny, to whom we owe most of our information, says that when Demetrius Poliorcetes besieged Rhodes (n.c. 305-304) he took special care that the painter should be protected and undisturbed in his work. The ancient critics seem to have regarded his paintings as representing the highest art. They seem to have contained usually but few figures, and to have shown but little creative power. His strength lay in execution rather than composition. Besides his "Ialysus," a Rhodian hero, we hear of a "Satyr" resting with his pipes in his hand, the "Paralus and Ammonias" (the eponyms of the Athenian sacred triremes) in the Propylæa at Athens, which some took for Odysseus and Nausicaa, portraits of the mother of Aristotle, King Antigonus, Alexander with Pan, and the Thesmotheta, or the hall of the Athenian senate of five hundred.

PROTOGENESIS. See SPONTANEOUS GENERATION.

PROTOGINE (from Gk. *πρῶτος*, *prōtos*, first + *γίνεσθαι*, *ginesthai*, *γίνεσθαι*, *gignesthai*, to become). Granite (q.v.) of gneissic structure composed of quartz, feldspar, and a greenish micaceous mineral belonging to the sericite or chlorite families which latter covers the lamination surfaces in a more or less continuous wavy membrane. The name protogine is applied chiefly to a rock mass of the Alps and is little used to describe rocks in other regions.

PROTOHIPPIUS (Neo-Lat., from Gk. *πρῶτος*, *prōtos*, first + *ἵππος*, *hippos*, horse). An ancestor of the horse in the Miocene Period. See HORSE, FOSSIL.

PROTONOTARY (ML. *protonotarius*, chief notary). The name properly given to each of the seven members of the Roman College of Papal Notaries, made up of prelates. They make up the first class; besides there are honorary protonotaries, who constitute a second class. The office of notary is very ancient, indeed primitive, for according to the *Liber Pontificalis* Clement I. (91-100) appointed a notary for each two of the fourteen 'regions' of Rome, making seven in all, and these were the forerunners of the first class of Papal protonotaries, whose duties are fixed by the constitution *Apostolicæ Sedis Officium* issued by Pius IX. in 1872. The original notaries were shorthand writers, using the *notæ*, or characters, 1100 in number, invented, it is said, by Ennius, the Latin poet. Later notaries were simply secretaries.

PROTOPLASM (ML. *protoplasma*, from MGk. *πρωτόπλασμα*, first creation, from *πρῶτος*, *prōtos*, first + *πλάσμα*, *plasma*, creation, from *πλάσσειν*, *plassein*, to form). The living substance constituting the cells of plants and animals, or forming the bodies of all one-celled organisms. In appearance it is like thin syrup, filled with highly refractive microscopic granules. It forms the physical basis of life, no living being existing without it; and all the phenomena or activities of life are based on this fundamental substance.

CHEMICAL CONSTITUTION. Protoplasm largely consists of proteins, which are compounds of carbon, hydrogen, oxygen, nitrogen, and sulphur, associated with a large proportion of water. Be-

sides proteids protoplasm contains small proportions of mineral matters, especially phosphates and sulphates of potassium, calcium, and magnesium, as well as sodium, iron, phosphorus, and chlorine found in the ash. It is dissolved by prolonged treatment with weak acids or alkalis. Strong alcohol coagulates it, as does heat. Proteids are unstable, and protoplasm, especially that of animal cells, decomposes with more or less rapidity and gives out a fetid odor. Protoplasm readily stains by the application of neutral or slightly alkaline solutions of carmine, logwood, or acid aniline dyes (eosin and acid fuchsin). Thus by the use of a carmine stain the chromatin in cells is clearly demonstrated. Protoplasm is usually, but not always, alkaline in reaction; red litmus paper is turned blue by it. Protoplasm is evidently a highly complex substance, but it is not known whether it is a definite chemical body, or whether it is a varying mixture of different chemical substances. "Protoplasm," says Hertwig, "is not a chemical, but a morphological conception," and the present organization of protoplasm is "the result of an exceedingly long process of development." For remarks upon the origin of protoplasm, see SPONTANEOUS GENERATION.

GENERAL PROPERTIES OF PROTOPLASM. If we watch an amœba under the microscope we gather that protoplasm first of all is contractile and irritable; that it assimilates its food, and is capable of excreting the waste residue; that it even respire, while it reproduces true to its species by self-division. Under a high power of the microscope the protoplasm of the egg of a starfish or sea-urchin, says Wilson, gives the appearance of a fine meshwork or framework composed of innumerable minute granules, or microsomes, suspended in a clearer, less deeply staining, continuous substance. The spaces of the meshwork (filar substance, spongioplasm, cell-reticulum) are filled with a clear, homogeneous substance, not staining readily, and called the ground-substance (interfilar substance, euchylema).

MOVEMENT AND IRRITABILITY OF PROTOPLASM. This consists of the changes in the form of the body, e.g. of the amœba, or of the white blood-corpuscles (leucocytes), whence such movements are called 'amœboid;' while in the interior streams of granules are seen passing along the body and in the pseudopods. That irritability exists is proved by many facts, as that amœboid movements and the flow of granules can be induced, stopped, or modified by mechanical, chemical, and thermal stimuli.

NUTRITION AND ASSIMILATION. Irritability and the power of motion are essential in bringing about assimilation, which is the change of food substance into protoplasm. Most unicellular animals, as well as the white amœboid blood-corpuscles, and certain cells in sponges, cœlenterates, etc., have been observed to take in or devour solid substances. They take the particles of food into the midst of the protoplasm of their bodies by flowing around them; they extract all the assimilable and reject the indigestible portions. (See AMœBA.) Many Protozoa (q.v.), besides taking in food for their own growth and for replacing worn-out parts, have the power of producing substances, such as lime or silica, or in rare cases cellulose, forming hard coverings or shells, often many-chambered and wonderfully

complex, as well as frequently richly ornamented. This formative power, says Hertwig, is the starting point in the formation of tissue.

HISTORY OF THE DISCOVERY OF PROTOPLASM. In the eighteenth century Corti (1772) and later Treviranus (1807) had seen that the grains of chlorophyll which cause the green color of plants flow rapidly in the interior of cells of certain plants. Mohl discovered that this apparent motion of the chlorophyll grains was due to that of the substance in which they were contained. This substance Mohl in 1846 called 'protoplasm,' while several observers (Siebold, Kölliker, Remak, etc.) afterwards discovered movements similar to those seen in vegetable protoplasm in the lymph corpuscles of animals, and therefore Remak applied the same term 'protoplasm' to the fundamental substance of animal cells. Meanwhile further knowledge of protoplasm was obtained by the study of certain Protozoa, and Dujardin in 1835 applied the name 'sarcode' to the gelatinous granular contractile substance forming their bodies. Ferdinand Cohn in 1850 argued for the identity of 'sarcode' and 'protoplasm.' Finally Max Schultze in 1861, and De Bary, as the result of prolonged investigations, proved the identity of the protoplasm of plants and animals with the sarcode of the Protozoa. Afterwards the cell membrane was found by Nägeli, Leydig, Kölliker, Cohn, etc., to be of minor importance, the protoplasm being the essential, dynamic substance of the cell.

BIBLIOGRAPHY. Dujardin, *Recherches sur les organismes inférieurs* (*Annales des Sciences Naturelles*, Paris, 1835-36); O. Hertwig, *The Cell* (New York, 1895); Wilson, *The Cell in Development and Inheritance* (ib., 1900); Verworn, *General Physiology* (ib., 1899).

PROTOROHIPPUS (Neo-Lat., from Gk. *πρότος*, *prōtos*, first + *ἵππος*, *oros*, mountain + *ἵππος*, *hippos*, horse). An ancestor of the horse in the Middle Eocene Period. See HORSE, FOSSIL.

PROTOROSAURI. See PROSAURIA.

PROTOSPONGIA (Neo-Lat., from Gk. *πρότος*, *prōtos*, first + *σπोंγγια*, *spongia*, sponge). One of the earliest, if not the earliest, fossil sponges known. It consisted of a spherical body which now appears as a faint disk upon the surface of the rock, with the skeleton showing as a regular network of cross-shaped spicules that form square meshes. It is found in the Cambrian formations of North America and Europe.

PROTOTHERIA (Neo-Lat. nom. pl., from Gk. *πρότος*, *prōtos*, first + *θηρίον*, *thērion*, diminutive of *θήρ*, *thēr*, wild beast). The lesser and inferior of the two primary divisions of the Mammalia. It embraces only the small group represented at present by the Australian and Papuan egg-laying duckbill and echidnas, which constitute the order Monotremata (or Ornithodelphia); and possibly also the doubtful and little-known fossil group termed Allotheria or Multituberculata. The mammalian affinities of these extinct forms have been denied by some paleontologists, but the weight of opinion views them as properly included in that category. Both externally and internally the monotremes show much that is distinctly mammalian, including the character of the brain, which in the echidnas at least is surprisingly large and well convoluted. The absence of a corpus callosum is the chief peculiarity differentiating it from the eutherian

brain. The skeleton exhibits many archaic features, one of the most striking of which is the presence of only the capitular head to the ribs. The shoulder girdle has other reptilian features, and a bone (the interclavicle) peculiar to the group. The digestive and circulatory systems differ little from the normal mammalian type, and the great distinction between the Prototheria and other mammals lies in the reproductive system, and the fact that their eggs, instead of being minute and with little or no food-yolk, are large, contain much yolk, and therefore develop, so far as their early stages are concerned, after the meroblastic manner of a reptile's egg. The Prototheria have a temporary ventral 'mammary' pouch in which the young are hatched, or to which they are transferred after hatching, and into which open the ducts of the mammary glands. This pouch is formed by a deep fold of the skin periodically developed in preparation for the young, and contains no teats, but nutrition is supplied by modified sweat-glands. Its homologies are fully discussed by Beddard (*Mammalia*, 1902), who refers to the work and writings of many investigators. See DUCKBILL; ECHIDNA; MAMMALIA.

PROTOZOA (Neo-Lat. nom. pl., from Gk. *πρωτος*, *prōtos*, first + *ζῷον*, *zōon*, animal). The subkingdom or phylum of one-celled animals, represented by the amoeba (q.v.), infusoria, and the like. They are, as a rule, of microscopic size, and are like particles of protoplasm (q.v.), having a gliding motion and constantly changing their form. Protozoa consist of a single cell, and, with the exception of the moners (q.v.), they possess one or more nuclei, but no other organs or true tissues. As the entire body is composed of protoplasm, the simplest protozoan is contractile, absorbs and digests food, is metabolic, automatic, and reproduces by self-division. Motion is not only brought about by the general contraction of the body, but by means of 'pseudopodia' (see AMOEBIA), cilia, and a specialized cilium called 'flagellum,' while in the most specialized infusoria, such as Vorticella and Stentor, little muscular fibrillae have been detected. Besides the nucleus and food-vacuoles, there are other cell-organs called 'contractile vacuoles,' which occur in fresh-water forms and only rarely in marine species. They apparently perform an excretory function, and may be respiratory, since they are supposed to eliminate carbon dioxide. All the vital functions appear to be under the control of the nucleus. Protozoa reproduce by self-division or budding, or they conjugate, multiplying by spores or germs. (See REPRODUCTION; SEX.) They may be naked, or secrete a calcareous shell, consisting of one, two, three, or many chambers; in the latter case (the Foraminifera), the shell is remarkably complex, considering the great simplicity of the animal itself. Apparently the same mechanical laws guide the mode of shell-formation, the chambered shells being irregular, or straight, or twisted, or coiled in a single plane, like the chambered nautilus. While a very few forms are terrestrial (*Amoeba terricola*), the vast majority are marine and fresh-water forms, the shelled forms being marine. The fresh-water forms abound most in still or stagnant water, and may become encysted when the water dries up, or when food is lacking or cold approaches. Thus protected by a

thin resistant outer covering, the monads and infusorians in general may dry up and be blown about by the winds, remaining suspended in the air for a long period. In this way the species have become more or less cosmopolitan. A large proportion of American forms are of the same species as those of Europe.

The discoverer of the microscope, Leeuwenhoek (q.v.), in 1764 first detected and described certain forms living in infusions, and about the same date Wrisberg (*Observationes de Animalculis Infusorius*, Göttingen, 1765) called them 'infusorial animalcules.' The name Protozoa was given in 1845 to the subkingdom by Siebold, who discovered that they were unicellular, disproving Ehrenberg's claim that they possessed a digestive canal, nervous system, muscles, excretory and sexual organs. The earliest traces of shelled Protozoa are those of Globigerina and Orbulina detected by Matthews in the Lower Cambrian rocks of Saint John, N. B.

It is to be observed that if we detect the remains of shelled Protozoa in the Cambrian formation, it is safe to suppose that the seas and fresh waters of that early period harbored numerous soft-bodied or shell-less forms. It is also supposed that the present types of Protozoa are very early forms which have persisted from Cambrian times, the type having undergone but little specialization. The Radiolaria date from the Cambrian. See FORAMINIFERA; RADIOLARIA.

CLASSIFICATION. The phylum Protozoa is divided into five classes: (1) *Rhizopoda*; (2) *Mycetozoa*; (3) *Flagellata* (*Mastigophora*); (4) *Sporozoa*; and (5) *Infusoria*. Of these the Sporozoa are all parasitic, while the malarial germ is a protozoan of doubtful position, its young being provided with flagella.

The latest work is Lankester, *A Treatise in Zoölogy*, part i. (London, 1903), which contains a bibliography.

PROTRACTOR (ML. *protractor*, from Lat. *protrahere*, to draw forward, from *pro*, before, for + *trahere*, to drag, draw). An instrument used for measuring and laying down angles on paper. In its simplest form it consists merely of a semicircular scale of metal or transparent material. The three-arm protractor used in marine surveying is used to solve mechanically the 'three-point problem.' The middle arm is fixed with its reading edge at the zero of the scale; the other arms, pivoting at the centre of the instrument, are arranged to measure angles on each side of the middle arm and all carry verniers. The method of using the protractor is as follows: Three objects (whose positions are marked on the chart or map) are selected. The angle between the right and centre objects and that between the centre and left are measured with sextants or similar instruments. The angles so obtained are transferred to the protractor, which is then laid upon the chart, and, with the edge of the centre arm always kept on the marked position of the centre object, the instrument is slipped along until the side arms fall upon the positions of the other two. The centre of the protractor then indicates the position occupied by the observer when the angles were taken, and crossed wires, a hole in a glass-ended tube, or a needle point serves to fix this position, which, if the angles are simultaneously observed, can be accurately ascertained even when the surveying boat is moving at a higher

rate of speed than is consistent with obtaining correct soundings. In selecting the point of observation care should be taken that the angles exceed 30 degrees if possible, and that the point occupied is not near the circumference of the

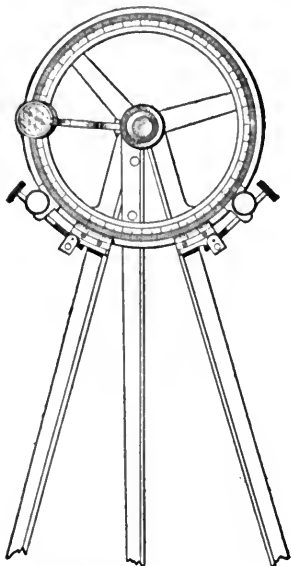

THREE-ARM PROTRACTOR.

circle which passes through the points observed. If the angles are small, a slight error in them is likely to produce a large error in the resulting position; and if the point occupied is on the circle passing through the three observed, its position is indeterminate.

PROU, **prō**, **MAURICE** (1861—). A French historian, born at Sens and educated in Paris, in the Ecole des Chartes and the Ecole des Hautes Etudes. After some time at the French School at Rome, Prou entered the numismatic museum of the National Library, and became professor of diplomatic relations at the Ecole des Chartes in 1900. He edited *Le moyen âge* (1893 et seq.). Besides editions of Hinemar (1884) and of Honorius's registers, his most important works are: *Raoul Glaber* (1886); *Manuel de paléographie* (1889; plates 1892 and 1896); *Catalogue des monnaies françaises* (1892 et seq.); and *La Gaule mérovingienne* (n. d.).

PROUD, **ROBERT** (1728-1813). An American historian. He was born in Yorkshire, England, but emigrated to America and settled in Pennsylvania in 1759. For many years he was a teacher of Greek and Latin in a Friends' academy at Philadelphia. Proud is chiefly noteworthy for his having written *The History of Pennsylvania in North America, from the Original Institution of that Province, under the First Proprietor and Governor, William Penn, in 1681, till after the year 1742*. He wrote the work principally during the period of the Revolution, with which he was not in sympathy, and published it in two volumes in 1797-98. The work contains original material that is of value to the student. Consult Thomson, in "Notices of the Life and Character of Robert Proud," in *Memoirs of the Historical Society of Pennsylvania*, vol. i. (Philadelphia, 1826 and 1864).

PROUD FLESH. The popular term for exuberant granulations (q.v.) springing up in wounds or on ulcerated surfaces. Such granulations must be treated with nitrate of silver or sulphate of copper, either in the solid form or in strong solution. See **LUNAR CAUSTIC**.

PROUDHON, **prō'dōn'**, **PIERRE JOSEPH** (1809-65). A noted French socialist and political writer, born at Besançon, July 15, 1809. He was educated at the College of Besançon, where he proved himself an able student; but on account of the poverty of his parents he was compelled to leave before receiving his degree. In 1828 he obtained employment in a large printing establishment in his native city, and after eight years he set up one of his own, which was not successful. In 1838 he published his *Essai de grammaire générale*, which secured him a triennial pension of 1500 francs from the Academy of Besançon. In the same year he removed to Paris. Here in 1840 he published *Qu'est-ce que la propriété?* (translated by Tucker, Philadelphia, 1888, in which he sums up his doctrines in the celebrated dictum, *La propriété c'est le vol*). At the moment of publication the work attracted little notice, and the sole results to its author were the withdrawal of his pension by the Academy, on the score of his noxious opinions, and the threat of prosecution. In 1842, for a repetition of the offense in his *Avertissement aux propriétaires*, he was prosecuted before the Cour d'Assises of Besançon, but succeeded in obtaining an acquittal. From 1844 to 1847 Proudhon was employed at Lyons in the superintendence of a scheme of water transport on the rivers Saône and Rhône, publishing during this time at Paris the two works entitled *De la création de l'ordre dans l'humanité* and *Système des contradictions économiques*. On the outbreak of the Revolution of February, 1848, Proudhon repaired to Paris, and on April 1st came before the public as editor of the *Représentant du Peuple*. By his vigorous advocacy of extreme democratic and socialistic opinions, he became one of the leading figures of the hour. His paper was suppressed in August; but meantime, on June 4th, he had been elected to the Constituent Assembly as representative of the Department of the Seine. In that body he had comparatively little influence; he attached himself to no political party, but attacked the radical Left and the reactionary Right with equal bitterness. His importance as a writer was much greater, and as editor of three daily journals in succession he had great influence upon the political movements. All three papers were in turn suppressed as anarchistic and obnoxious—*Le Peuple* (November 23, 1848-April, 1849), *La Voix du Peuple* (October, 1849-May, 1850), *Le Peuple de 1850* (June 15th-October 13th). During their continuance Proudhon was repeatedly subjected to fines, which were defrayed for him by popular subscription. In January, 1849, he attempted to put his theories into practice by the institution of a People's Bank. The bank was closed by the authorities, and its originator fled to Geneva to escape threatened imprisonment. In June, however, he returned, and his next three years were passed in the prison of Saint Pélagie. While confined there he married. In June, 1852, he was set at liberty, and, quitting Paris, went to Belgium, where he continued to publish from

time to time on his favorite subjects. He returned to Paris after the amnesty of 1860 and died at Passy, January 16, 1865.

Proudhon's theories are best set forth in his works *Qu'est-ce que la propriété?* and *Système des contradictions économiques*. Property, he declared, is unjustifiable either on the ground of occupation, which can entitle the possessor only to the usufruct, or on the ground of labor, which presupposes occupation. The individual has a right only to the integral product of his labor. One service can only be duly repaid by rendering another; but the owners of land and capital exact many services while rendering none. Society should suppress interest and rent, to which there can be no just claim.

His political programme was equally revolutionary. He was the founder of a school of individualistic or philosophical anarchy. He declared that the State, representing unintelligent conservatism or brutal reaction, must be suppressed. The revolution for the betterment of humanity must come, not from above, through the Government, but from below, through the individual. The indispensable condition of reform is the suppression of government.

In the history of French thought and socialism Proudhon occupies an important position. His destructive criticism was of value; but he also elaborated numerous propositions which are regarded as positive acquisitions by economists and socialists. He gave to federalism and anarchy a doctrine; he conceived of a democratic organization of credit; he outlined the socialistic theories of value, of rent, and of the right of the laborer to the whole product of his labor. His theories were of great influence upon three important movements—the Revolution of 1848, the Commune of 1870 (many of the principal actors in which held his opinions), and the International Workingmen's Association. Moreover, many organizations of workingmen, especially in France, still look for their intellectual leadership to Proudhon. Among his works, in addition to those already mentioned, are: *Explications présentées au ministère public sur le droit de propriété* (1842); *Solution du problème social* (1848); *Banque du peuple* (1849); *Actes de la révolution: résistance* (1849); *Les confessions d'un révolutionnaire* (1849); *Intérêt et capital* (1850); *Idee générale de la révolution au XIXème siècle* (1851); *Philosophie du progrès* (1853); *La guerre et la paix* (1861); *De la capacité politique des classes ouvrières* (1865).

BIBLIOGRAPHY. Desjardins, P. J. *Proudhon, sa vie, ses œuvres, et sa doctrine* (2 vols., Paris, 1896); Diehl, P. J. *Proudhon, seine Lehre und sein Leben* (3 vols., Jena, 1888-96); Müllerberger, P. J. *Proudhon, Leben und Werke* (Stuttgart, 1899); Putlitz, P. J. *Proudhon, sein Leben und seine positiven Ideen* (Berlin, 1881).

PROUST, πρῶ, ANTONIN (1832—). A French politician and author, who sometimes wrote under the pseudonym of Antoine Barthélemy. He was born in Niort, and, after an excellent education and travels in Greece, entered journalism, and in 1864 founded at Brussels *La Semaine Universelle*, in which he bitterly opposed the Empire. Proust became Gambetta's private secretary after the fall of the Empire, and was elected Deputy in 1876 and repeatedly re-elected. From November, 1881, to January, 1882,

he was Minister of Fine Arts under Gambetta. The Museum of Decorative Arts was largely due to his efforts. He was the Commissioner-General of Fine Arts at the Exposition of 1889, and French Commissioner-General to the World's Columbian Exposition of 1893. His chief works are: *Les beaux-arts en Angleterre* (1862); *Un philosophe en voyage* (1864); *Chants populaires de la Grèce moderne* (1866); *La démocratie en Allemagne* (1872); *Le prince de Bismarck* (1876); *L'art français* (1890); *L'art sous la république* (1891); and critiques of the Salons of 1898 and 1899.

PROUST, JOSEPH LOUIS (1754-1826). A French chemist, born at Angers. He studied chemistry there and in Paris, and became chief apothecary to the Salpêtrière. He put on a firm basis the chemical law of definite proportions, sometimes called Proust's law; discovered glucose (1799); and in general greatly advanced the knowledge of quantitative analysis.

PROUSTITE (named in honor of Joseph Louis Proust). A mineral sulphide of silver and arsenic that crystallizes in the hexagonal system. It has an adamantine lustre and a bright red color. It is found in Saxony, Bohemia, Spain, Mexico, South America, and in the United States at various localities in Colorado, Arizona, and Nevada, in association with silver ores.

PROUT, EBENEZER (1835—). An English theorist and composer, born at Oundle, Northamptonshire. His father sent him to London University, where he graduated in 1854. He had but little instruction in music during his boyhood, with the exception of a course under Charles Salaman, but he showed such aptitude for the art that in 1859 he devoted himself to it. In 1861 he became organist at Union Chapel, Islington. In 1894 he was appointed professor of music at Dublin University, having occupied in the meantime the positions of professor of pianoforte at the Crystal Palace School of Art, professor of harmony and composition at the National Training School, and critic on the *Academy and Athenæum*. He took Sullivan's class at the Royal Academy of Music in 1879; was conductor of the Hackney Choral Association, which he succeeded in bringing to a high degree of efficiency; and was editor of the *Musical Record* from 1871 to 1874. His valuable theoretical works are: *Primer of Instrumentation* (1876); *Harmony: Its Theory and Practice* (1889); *Counterpoint: Strict and Free* (1890); *Double Counterpoint and Canon* (1891); *Fugue* (1891); *Applied Forms* (1895); and *The Orchestra* (1898-99). His compositions include four symphonies, two overtures, and many choruses, psalms, chamber-music, and instrumental selections. His cantatas are: *Hereward* (1878); *Alfred* (1882); *The Red Cross Knight* (1887); *Damon and Phintias* (1889); and *Queen Aimée* (1885).

PROUT, FATHER. See MAHONY, FRANCIS SYLVESTER.

PROUT, SAMUEL (1783-1852). An English landscape and architectural painter in water-color, born at Plymouth. His real artistic activity began in 1818 with his travels on the Continent, which were continued throughout his career, and furnished materials for his best aquarelles. Especially well known are his archi-

tektural drawings of old Normandy. Many of his drawings were afterwards lithographed and published in volumes, under the titles, *Facsimiles of Sketches Made in France and Germany* (1833); *Interiors and Exteriors* (1834); *Sketches in France, Switzerland, and Italy* (1839), etc. He was also well known as the author of numerous elementary drawing-books, including *Bits for Beginners*; *Hints on Light and Shade, Composition, etc.* His water-color drawings are characterized by decision of handling, great breadth, and clear and pleasing coloring.

PROVENÇAL (prô'vân'sâl') LANGUAGE.

A family of Romance dialects spoken in Provence (and neighboring districts), or that part of Southern France in which was the Roman province called Provincia. It was with French the first Romance tongue to win importance in literature. Its literary vogue decayed after the period of the Albigensian Crusade (1209-1229), but in modern times it has been rather successfully applied to literary purposes again by Mistral (q.v.) and other writers. From French, its northern neighbor, Provençal is separated geographically by a line which, starting from the mouth of the Gironde, follows the Dordogne for a while, then ascends to the north toward Isle-Jourdain, and, bending to the east as far as Montluçon, descends again in a southerly direction, crosses the Rhone, passes through the regions of Lyonnais and Dauphiné, and reaches the Alps. This line of demarcation serves also to divide it on the northeast from a linguistic territory known as the Franco-Provençal, because it has peculiarities savoring both of French and Provençal. In the southwest of the territory to the south of the dividing line described is found a body of Gascon dialects, which in the Middle Ages were treated as forming a speech foreign to Provençal. The number of persons speaking the modern Provençal dialects (including Gascon) may be estimated at about 8,000,000. Provençal has often been called the *langue d'oc*, as contrasted with French, called the *langue d'oïl*; *oc* and *oïl* were respectively the Provençal and the Old French words for 'yes.'

The older speech, as represented in the literary works of the twelfth century, had eight simple vowels, viz. open and close varieties of *a*, of *e*, and of *o*, the high front vowel *i*, and a rounded form of this last vowel, written *u* as in modern French. Among the more common diphthongs were *ie*, *uo*, *ue*, and *au*. The retention of the Latin diphthong *au* is a characteristic of Provençal as compared with the other Romance tongues. The consonantal sounds comprised the velar stops *k* (written *c* before *a*, *o*, and *u*, and at the end of a word, as in *car*, 'why,' *cort*, 'court,' and *qu*, as in *que*, 'that,' and *quina*, 'fifth'), and *g* (written *gu* or more usually *g* before *a*, *o*, as in *garvir*, *guarvir*, 'to furnish,' *g* before *u*, as in *agur*, 'augury,' and *gu* before *e*, *i*, as in *guerra*, 'war'); the velar nasal with a value like that of the English *ng* in 'ring' (written *n* before the *k* and *g* sounds already described, as in *tenc*, 'he held'); the dental stops *t* and *d*, the former voiceless, the latter voiced; the voiceless sibilant *s* (written *s* and *ss*, the latter usually between vowels, as in *baissar*, 'to lower'); the voiced sibilant *z* (written *z* or *s*, as in *chauza* or *chausa*); the dental spirant *th* (*th* of English 'there;,' written *d*, and after the

middle of the twelfth century *z*, when it probably already denoted the *z* sound, as in *espaza*, 'sword'); the dental nasal *n*; the palatalized *n* (written *n*, *ign*, etc., and more commonly in later times *nh*, as in *renkur*, 'to reign'); a well-pronounced *r*; an *l*; a palatalized *l* (written *lh* or *ill*, as in *acolhir*, *acoillir*, 'to welcome'); the labial stops *p* (voiceless) and *b* (voiced); the labio-dental spirants *f* (voiceless) and *v* (voiced); the labial nasal *m*; the semivowels *y*, *u*, *ü* (represented by *i*, by *ou*, and by *u*, when they stood in hiatus). More complex sounds are *tš* (the English *ch* of 'church,' i.e. a voiceless dental sibilant, represented by *ch* in all positions, and by *g* occasionally in the final position, as in *sapcha*, 'let him know,' *tug* or *tuich*, 'all'); *dž*, the voiced equivalent of the preceding sound (the English *j*, represented by *j* and, before *e* or *i*, by *g*, as in *gen*, 'gentle,' *joytur*, 'minstrel'); the manuscripts often have graphic *i* for *j*); a voiceless dental sibilant *ts* (written *c*, as in *marce*, and *z* or *tz*, especially in the final position, as in *faz*, *fatz*, 'he does'); and a voiced dental sibilant *dz* (written *z*, as in *dizem*, 'we say'); as in French, the last two sounds soon lost their dental component. In the literary documents final *n* is often omitted, and, on the other hand, it is often added to words that should normally end in a vowel; this ease of addition or omission has led to its being called the movable *n*. Even in the earliest times the Provençal region was divided into a northern and a southern linguistic district, the northern marked by the change of initial Latin *ca-* to *cha-* (*chastel*, 'castle'), the southern by the retention of the *k* sound (*castel*) of the *ca-*.

What most distinguishes Provençal as compared with French is the fact that it keeps the Latin accented *a* of free syllables and Latin unaccented final *a*, while French has changed them respectively to *é* and slurred or mute *e* (cf. Provençal *amat* and Old French *amét*, modern French *aimé*; Provençal *bona* and French *bonne*). In modern Provençal the final unaccented *a* has become *o*, and palatalized *l* has tended to become the palatal semivowel *y* as in French. Nasalization of vowels has not at any time been a regular feature of the language. The word-accent has always fallen on the last or the next to the last syllable. In the older period there was a ease distinction of nominative and accusative for substantives, except those coming from the Latin first declension; thus, nominative singular *sor*, 'sister,' accusative singular *seror*, nominative plural *scrors*, accusative plural *scrors*; nominative singular *cavaliers*, 'knight,' accusative singular *cavalier*, nominative plural *caralier*, accusative plural *cavaliers*; but nominative and accusative singular *domna*, 'lady,' nominative and accusative plural *domnas*. In the modern speech the plural sign *s* is silent except in liaison. The four conjugations of Latin persisted in Provençal; but only the first (infinitive in *-ar*) and the fourth (infinitive in *-ir*) remained with sufficient vitality to attract new verbs to them. As in the earliest Old French, and as occasionally even nowadays in Spanish and Portuguese, the Latin pluperfect indicative (*cantaveram*, etc.) had in early documents an indicative value (either pluperfect or aorist, usually the latter); it had oftener, however, the imperfect subjunctive or conditional force that has prevailed also in the Iberian Peninsula.

BIBLIOGRAPHY. Stengel, *Die beiden ältesten*

provenzalischen Grammatiken, Lo Donatz provençals und Las rasos de trobar (Marburg, 1878; editions of treatises on grammar and versification prepared in Provençal as early as the thirteenth century); Suchier, "Die französische und provenzalische Sprache und ihre Mundarten," in Gröber, *Grundriss der romanischen Philologie* (Strassburg, 1888; in French translation, *Le français et le provençal*, by P. Monet, Paris, 1891, with corrections by Suchier); Diez, *Grammatik der romanischen Sprachen* (3d ed., Bonn, 1870-72); Meyer-Lübke, *Grammatik der romanischen Sprachen* (Leipzig, 1890 et seq.; trans. into French as *Grammaire des langues romanes*, Paris, 1890-1900); Creseini, *Manuale eto provençale* (Verona, 1892); Meyer, *Recueil d'anciens textes bas-latins, provençaux et français* (Paris, 1874-77); Suchier, *Denkmäler provenzalischer Litteratur und Sprache* (Halle, 1883); Chabaneau, *Grammaire limousine* (Paris, 1876); Lienig, *Die Grammatik der provenzalischen Leys d'Amors verglichen mit der Sprache der Troubadours* (Breslau, 1890); Koschwitz, *Ueber die provenzalischen Fcliber und ihre Vorgänger* (Berlin, 1894); id., *Grammaire de la langue des Félibres* (Paris, 1894). Dictionaries: Raynouard, *Lexique roman* (6 vols., Paris, 1838-44); is to be used only in connection with E. Levy, *Provenzalisches Supplement-Wörterbuch* (Leipzig, 1828 et seq.); Mistral, *Lou trésor dóu Félibrige ou Dictionnaire provençal-français* (Paris, 1879-86). For additional articles recourse may be had to the various reviews dealing with Romance philology, such as the *Romania*, the *Zeitschrift für romanische Philologie*, the *Phonetische Studien*, the *Annales du Midi*, the *Revue des langues romanes*, the *Romanische Forschungen*, the *Archivio glottologico*, etc.

PROVENÇAL LITERATURE. The literature written in the various dialects of the south of France, and more particularly that written during the Middle Ages in the dialect of Limousin. Its earliest monument, a fragment of a moral poem called *Boëthius*, belongs to the first half of the eleventh century. The courtly lyrics, however, which constitute its main glory, were nearly all written between 1090 and 1350. The songs of over four hundred poets who composed during this period have come down to us, and we know the names of almost seventy others whose works have perished. Among these authors we find not only wandering singers and court minstrels, but knights, ladies, barons, counts, and even kings. The amenity of the climate, the refinement of manners, the frequency of travelers, merchants, and pilgrims, the blithe and easy life in rich cities and baronial palaces, favored the development of a form of poetry which found its inspiration and its support in a luxurious and frivolous aristocratic society. The troubadours (q.v.) wrote, not for readers, but for hearers; their pieces were sung at court festivals either by the authors themselves or by the more humble jongleurs. Music and words were usually composed by the same person. This intimate connection between words and music strongly influenced the form of these lyrics. Elaborate artificiality is a predominant trait. Every variety of rhyming scheme was attempted, the rhymes of one stanza being repeated in all the others throughout a poem. Word-play, alliteration, conceits, and forced constructions

abound, and difficulties of every kind were sought. There even grew up a style called the *trobar clus*, or *oscur*, the chief merit of which was that it could hardly be understood. A treatise on verse written in the fourteenth century (*Leys d'Amors*) mentions many different kinds of poems, the most important of which are the *vers* and *canço*, the *sirventes* and the *tenso*. Between *vers* and *canço* no very clear distinction has been observed, except that the *vers* was the earlier and simpler form. The *canço* was an elaborate lyric of from five to seven stanzas with complicated rhymes, and it dealt always with love, and required a melody of its own. The sort of love thus treated was peculiar to the Middle Ages and seems to have been shaped by the social conditions of the period. The ladies who presided over the almost independent courts of Southern France were the natural subjects of the praise and adoration of the singers, who expressed largely a feigned passion in artificial formulas. Yet, however innocent for the most part these love affairs actually were, the semblance of an illicit relationship was preserved. In general, love is represented as the greatest good, the height of blessings, the source of all virtue and glory. Spring-time is its season; its cause, beauty which, penetrating the lover's eyes, smites his heart, within which it inflicts a wound that causes infinite suffering. Yet he dares not speak, though he grows pale and sleepless. Nothing can change his devotion and his absolute submission to his lady's will; for her noble qualities brighten the world and ennoble all who approach her. Her grace and mercy are his only hope. Such, in general, though played upon in every variety of style, sometimes even in parody, is the subject matter of the *canço*.

The *sirventes*, or service song, was written to fit some well-known and popular air. The subject was moral or religious, political or personal. The poet, with great freedom of language, scourges the vices of nobles or women or clergy, laments the decay of ancient manners and the growth of avarice, stimulates leaders and populace to war, exalts a patron for his political virtues and his generosity, avenges an injury by virulent personal invective, or exhorts laggards to the crusade. Without an intimate acquaintance with the events to which they relate, many of these pieces are now unintelligible, yet to the student of mediæval life they are most interesting; for they constitute the journalism of the age.

The *tenso*, with which may be included the *partimen*, *joes partitz*, and *torneyamen*, was a poetical dispute, a play of wit, in which, often with biting mockery and intense personal bitterness, two or more poets debated, in alternate stanzas, some question of love casuistry, such as: Which are the greater, the benefits or the ills of love? Which contribute more to keep a lover faithful, the eyes or the heart? The decision is commonly left to some lord or lady. Such were the leading artificial forms of the Provençal lyric. There were, however, some others which retain a stronger impress of popular origin: the *alba*, or dawn-song, portraying the parting of lovers; the *ballada*, *dansa*, and *ronda*, to be sung to the dance; the *pastorela*, copied some think from the French, a dialogue between a knight or a clerk and a shepherdess.

The earliest lyrical writer whose songs have been preserved is William IX., Duke of Aquit-

taine and Count of Poitou, but his pieces show such sure skill in treatment, such stability of language, metrical form and artistic character, as could not have been attained without the foundation of a considerable earlier literature. After the middle of the twelfth century the poets became numerous and their art soon reached its culmination. Among the most notable singers are: Marcabrun, distinguished for his biting satire; Jaufré Rudel, Prince of Blaia, hero of a romantic tale, charmingly dramatized by Edmond Rostand in his *Princesse lointaine*; Rambaut d'Orange, who exchanged love songs with Beatrice, Countess of Die; Peire Rogier, who excelled in exaggerated devotion to Ermengarde, the masculine Countess of Narbonne; Bernard de Ventadour, the greatest singer of love; Peire d'Alverhne, who wrote largely in the difficult style; Arnaut de Mareuil, referred to by Petrarch, in comparison with Arnaut Daniel, as 'the less famous Arnaut;' Guiraut de Borneil, 'the master of the troubadours;' Peire Vidal, an erratic genius; Bertran de Born, often called, on account of his stirring war songs, 'the Tyrtæus of Provence,' and put by Dante into hell among the stirrers of dissension (*Inf.* xxviii.); Folquet de Marseille, who sang of love in his youth, then entered the Church, rose to be Bishop of Toulouse, and was one of the most ferocious persecutors of the Albigenses; Pons de Capduell, Rambaut de Vaqueiras, and Peirol, all three lovers and crusaders; Arnaut Daniel, whom Dante met in the last circle of Purgatory, and whom he regards as the greatest of all poets of love (*Purg.* xxvi.); Raimon de Miraval, who sang light-heartedly of amorous intrigues while his country was being devastated by a cruel war and ruin stalked through the land.

After the beginning of the thirteenth century the Provençal lyric rapidly declined. Moral poems largely took the place of songs of love and war. Among the writers worthy of mention are: Aimeric de Peguilhan, the favorite of many nobles; Peire Cardinal, master of the moral *sirventes*; Sordello, the Mantuan, made famous by Dante and Browning; and Guiraut Riquier, who may well be regarded as the last of the Troubadours.

The fall of this brilliant literature began with the Albigensian Crusade of 1209, which soon turned into a savage war of conquest, and ended in the absorption of the fiefs of the south by the French monarchy. The elegant and liberal life of the Provençal nobility, the fount from which this lyric drew all its vitality, was destroyed. The stream of court poetry was dried up at its source. Even the language was condemned by authority. The culture of the region became entirely French, and the *langue d'oc* declined into a mere group of dialects, with a dialectal literature. The poets took refuge in Catalonia, Aragon, and Italy, where for another century their profession flourished.

The art, abandoned by the aristocracy, was taken up by the citizens of the towns. In 1323 seven burghers of Toulouse founded the "Sobregaya Companhia dels VII. Trobadors de Tholoza," the purpose of which was to further their native poetry. This company developed into a formal society with many sharply defined grades of membership. Their chancellor prepared in 1355 a manual of poetic art, the *Leys d'Amors*, degrees of bachelor and doctor of the 'gay science' were

conferred, and annual competitions in song were held, called the "Floral Games," from the fact that gold and silver flowers constituted the prizes. The pieces composed for these competitions celebrated the Virgin under the names *Amors* and *Clemenza*, the stereotyped love-formulas of the ancient poets being employed in the service of religion. Being written according to rule, these poems are uninspired and of small literary value.

Lyric poetry, though the most important, was not the only manifestation of Provençal literature. Almost all the mediæval forms are to be found. There are epics, mostly fragmentary, the most important of which is *Girart de Rossillon*; Arthurian romances, such as *Jaufré*; short versified tales, called *novas*, which are interesting chiefly as presenting the life of the age; and one long and highly artificial love-story, *Flamenca*, which represents the impossible wooing and conquest of a married lady by a young knight. *Flamenca* has kept for us a most valuable picture of Provençal manners before the year 1235, when it was probably composed. Some historical poems are also of importance, among which may be mentioned the *Chanso d'Antioche*, dealing with the First Crusade, and two long fragments on the Albigensian War. A few fables, hymns, prayers, allegories, epistles, and lives of saints remain; also a great mass of moral, didactic, and scientific verse, of which much is still unpublished. To this class belongs an immense work, a sort of encyclopædia, the *Breviari d'Amors* of Matfre Ermengaud, which consists of over 34,000 lines. Of the drama little has been preserved, and of that little none is earlier than the fourteenth century.

Compared with the poetry, Provençal prose is weak and poor. We have some translations of parts of the Bible and of legends of the saints, some chronicles, some quasi-scientific treatises, and works on grammar (*Donat Provensal*, of about 1243, *Las Razos de Trobar*) and poetics (*Las Leys d'Amors*, of about 1356). The most interesting bit of prose is the *Biographies of the Troubadours*, containing more than one hundred lives, together with *razos*, or stories explaining the circumstances under which particular poems were composed. This work, however, is untrustworthy. Many of the notices are romantic tales, products of the imagination, built wholly upon the poems they are designed to interpret.

Provençal literature, it will be seen, is of slight value apart from its lyric poetry, but this lyric poetry is one of the most important artistic manifestations of the Middle Ages. Poor as it was in ideas and sentiments and empty in its courtly refinement, it was original. Very few outside influences were at work at its rise or in its development. It was the spontaneous outgrowth of chivalric manners and institutions acting under favorable conditions upon a race prone to melody. Its fundamental aridity is offset by variety of form, courtly refinement, and superior musical qualities. Though almost without known ancestry, it was not without known offspring. France, Germany, Spain, and Italy echoed its tones and imitated its conventional forms. In Germany, however, a native spirit soon mastered the Minnesingers, and in Italy a school of thoughtful and cultivated writers developed the love theories of Provence till they were fit for the hand of Dante.

For modern Provençal literature, see FÉLIBRIGE.

BIBLIOGRAPHY. Fr. Diez, *Die Poesie der Troubadours* (2d ed., by Bartsch, Leipzig, 1883); id., *Leben und Werke der Troubadours* (2d ed. by Bartsch, ib., 1882); Fauriel, *Histoire littéraire des troubadours* (3 vols., Paris, 1844; Eng. trans. by Adler, New York, 1860), a work which, though brilliant, loses through hazardous theorizing; Bartsch, *Grundriss zur Geschichte der provenzalischen Litteratur* (Elberfeld, 1872); Ristori, *Letteratura Provenzale* (Milan, 1891), of which there is also a French translation (Montpellier, 1894), perhaps the best brief treatment of the subject; Stimming, "Provenzalische Litteratur," in Gröber, *Grundriss der romanischen Philologie*, vol. ii. (Strassburg, 1892-98); and the *Encyclopædia Britannica* (9th ed.), "Provençal Literature," by Paul Meyer. Gaston Paris, in his *Mediæval French Literature* (London, 1902), treats Provençal literature as a branch of the old French. In addition to these works, collections of poems have been published by Raynouard, *Choix des poésies originales des troubadours* (6 vols., Paris, 1816-21), and in the first volume of his *Lezique roman* (6 vols., ib., 1844); and by Mahn, *Werke der Troubadours* (4 vols., Berlin, 1853-56), and *Gedichte der Troubadours* (Berlin, 1856-73). There are also editions of many individual troubadours and of several of the longer epic and didactic works. Several of the manuscripts have also been printed diplomatically. The best introductory selection of old Provençal poetry and prose is Appel, *Provenzalische Chrestomathie, mit Abriss der Formenlehre und Glossar* (Leipzig, 1895), of which the first part of a second edition appeared in 1902. Consult also the authorities referred to under TROUBADOURS.

PROVENCE (Lat. *Provincia*, province). Formerly a province of Southeastern France, comprising the present departments of Basses-Alpes, Var, and Bouches-du-Rhône, and parts of the departments of Vaucluse and Alpes-Maritimes. The name Gallia Provincia or simply Provincia was given to the country by the Romans, who, about B.C. 120, subdued the territory later constituting Provence, Dauphiné, and Languedoc. *Aquæ Sextiæ* (Aix) was the capital of the new province. During the movement of Germanic peoples in the fourth century the Roman power and the name Provincia were restricted to the southeastern portions of this territory lying between the Rhone, the Durance, and the Mediterranean Sea, and with the fall of Arles about 470 this portion, too, passed into the hands of the Visigothic invaders. After being held from 510 to 536 by the great Theodoric, King of the Ostrogoths, the region passed to the Frankish kings, in whose many partitions it was repeatedly parceled out. It was saved from the Saracens by the famous victory of Charles Martel (732). By the partition of Verdun Provence fell to Lothair; it was seized by Charles the Bald in 863, and in 879 attained the rank of a kingdom under Boso, being known as the Kingdom of Provence or Cisjurane Burgundy. (See **BURGUNDY**.) This was united with Transjurane Burgundy in 933 to form the Kingdom of Arles, which existed for 100 years. Soon after the extinction of the Arletan realm the counts of Provence became hereditary feudal princes. They ruled in practical in-

dependence until 1112, when, upon the failure of male issue, the county passed to Ramon Berenguer (Raymond Berengar), Count of Barcelona, whose male line became extinct in 1245, in the person of Ramon Berenguer IV. His daughter, Beatrice, brought Provence in marriage to Charles of Anjou (q.v.), whose last direct descendant, Joanna I. of Naples, made Louis of Anjou her heir (1382). Best known among the counts of the House of Anjou was René I. (q.v.), the last of the troubadours, whose Court became the home of a splendid culture. René left an only daughter, Margaret of Anjou, and in 1481 Provence fell to France, being formally reunited in 1486. In the life of the French nation the inhabitants of Provence have played their full share, exercising no inconsiderable influence on the development of politics, art, and literature. With the shrewd Norman, the wily Gascon, and the well-fed burgher of Touraine, the hot-blooded, poetic, eloquent Provençal ranks as one of the great national types, which has received concrete form in Alphonse Daudet's undying Tartarin.

BIBLIOGRAPHY. Fabre, *Histoire de Provence* (Marseilles, 1833-35); Lenthéric, *La Provence maritime, ancienne et moderne* (Paris, 1880); Berenger-Férand, *Réminiscences populaires de la Provence* (Paris, 1885); Robida, *La vieille France* (Provence, 1893); Castanier, *Histoire de la Provence dans l'antiquité* (Paris, 1893-96); Ribbe, *La société provençale à la fin du moyen âge* (Paris, 1898); Poupardin, *Le royaume de Provence sous les Carolingiens* (Paris, 1901); Oddo, *La Provence* (Paris, 1902).

PROVENCE, COUNT OF. The title borne previous to his accession by Louis XVIII. of France.

PROVERB (OF., Fr. *proverbe*, from Lat. *pro-verbium*, adage, from *pro*, before, for + *verbum*, word). A short, sententious phrase or clause long current in common speech. The last phrase, 'long current in common speech,' serves to differentiate the proverb from the multitude of happy expressions in literature which never become permanently fixed in popular usage. "Patience on a monument" is a happy phrase, often quoted by literary men, but it is not a proverb. "A bird in the hand is worth two in the bush" is a proverb. Another frequent characteristic of proverbs is alliteration or rhymes or rhythmic balance. Thus, "Where there's a will there's a way" shows alliteration; "Birds of a feather flock together" shows both rhyme and rhythm; and "Out of sight out of mind" shows rhythmic balance.

Whence comes the proverb? Lord Russell suggests the apparent origin in the phrase 'the wit of one.' Some one gives apt expression to a general truth or to an apparent truth; taken up by others, it spreads far and wide. Saint Jerome is said to have originated "To make a virtue of necessity." In Sterne's *Sentimental Journey* occurs the most beautiful English proverb, "God tempers the wind to the shorn lamb." And it is assigned either to Sterne or to the Bible, where it does not occur. It is found in George Herbert's *Jacula Prudentum* (1640), under the form, "To a close-shorn sheep God gives wind by measure." Herbert clearly took it from the French, "Dieu mesure le froid à la brebis tondue" (sixteenth century). From this point the proverb may be followed back to

Provençal and Latin; and we find, too, the Turkish "God makes a nest for the blind bird." Sterne had come across the saying, clothed it in exquisite language, and made it immortal. As in this specific case, the proverb is made by many hands. Like the ballad and the fairy tale, it is impersonal; and, like them, it goes back to the remotest times. The age of proverb-making is the age of the folk-song. Its frequent metaphor and alliteration suggest this. Later times remold what comes to them. Among nations far advanced in civilization new proverbs are rare. The press throws off phrases of a proverbial character, but they do not often become a part of our speech. They serve their purpose and then disappear. It is the old phrases that we employ, as those relative to sour grapes, the gift horse, the prophet honored elsewhere than at home, haste and waste, honesty and policy. Except in certain cases, as in the examples just given, we do not usually quote proverbs at length, but some phrase or word from them. With these remnants our speech and our very best literature are pervaded. Shakespeare, for example, refers to two proverbs in the same scene of the *Tempest* (II. ii.): "Good liquor will make a cat speak," and "He must have a long spoon who must eat with the devil."

As we have implied, all countries have their proverbs as well as their folk-songs. There is a rich mine in the East—Arabic, Persian, Hindustani, Japanese, and Chinese. "Where the corpse is, there the vultures gather," for example, is an Indian proverb. Of ancient Hebrew proverbs, a whole book is extant. The language of Christ and the Evangelists is ornamented with them. They were turned to the highest spiritual uses in the Sermon on the Mount. Roman proverbs, often relating to husbandry, inculcate frugality, patience, and independence. Trench cites this against high farming: "Nihil minus expedit quam agrum optime colere" (Nothing pays less than over-cultivation). Italian proverbs are of various import, teaching now distrust and cynicism, now subtle wisdom and plain-dealing. Attention has frequently been called to the respect shown to the Devil in the Italian proverb; whereas in the Teutonic proverb—German, Dutch, and Scandinavian—he is a ridiculous figure. The Gallic wit of French literature is curiously absent from the French proverb.

Proverbs appear in Anglo-Saxon poetry, especially in the gnomic verses. In length the gnomic verse proverbs vary from half a line to eight lines. Here are two Anglo-Saxon proverbs: "The wyrd [fates] change not God," and "O lythe [pleasant] it is on land to him whom his love constrains." At the Renaissance this fund of native philosophy was augmented by importation. Chaucer's Dame Partlet turns the Latin "Somnia ne eures" into "Ne do no fors of dremes" (Heed not dreams). In the early part of the seventeenth century appeared two notable collections of proverbs, partly English and partly foreign—George Herbert's *Jacula Prudentum* (1640), and the volume added to James Howell's *Lexicon Tetraglotton*, published separately in 1659, under the title "Proverbs or old Sayed Saws and Adages in English or the Saxon tongue, Italian, French, and Spanish; whereunto the British [Welsh] for their great antiquity and weight are added." Of all countries, Spain possesses the largest and best store

of proverbs. Don Juan de Iriarte (eighteenth century) collected at least 24,000. Cervantes hardly exaggerated the employment of them among the peasants when he made them crowd thick into the mouth of Sancho Panza and come out haphazard. Even after admonished by Don Quixote, Sancho in the next sentence utters four: "In a plentiful house supper is soon dressed;" "He that cuts does not deal;" "With the repique in hand the game is sure;" "He is no fool who can both spend and spare." As in England, the proverb in Spain was a part of popular poetry. The so-called Spanish *copla* (couplet) is a witty proverbial thrust.

There now remains the question of the origin of the similarity between proverbs in various countries. Have those resembling one another a common ancestry? "One swallow does not make a spring," is current in some form among many peoples, and was a proverb some two thousand years ago. Have all the forms of this proverb a common parent? Such a question cannot be safely answered. All that can be done is to attempt to settle the date when a proverb appears in different countries. The tendency, of course, is to say that all forms derive from the oldest. In many cases the investigation leads to the East, and it is perfectly evident that the native proverbs of Europe have been enriched from that source. The media of diffusion were the Bible, the Arabs in Spain, travelers in the East, and mediæval Latin literature. Still more easy is it to understand how proverbs have been exchanged by the peoples of Western Europe, and how Englishmen, Welshmen, and Irishmen have freely given and taken. In spite of all this, it must be remembered that men's minds work in common ways. That one swallow does not make the spring or summer is a natural observation. The thought may have been expressed by a hundred different men far apart in space and time. So, too, it is not probable that "God tempers the wind to the shorn lamb" derives from "God makes a nest for the blind bird." On the other hand, "Where the carrion is, there the eagles gather," seems to be a variant of the Eastern "Where the corpse is, there the vultures gather."

COLLECTIONS. GENERAL; Erasmus, *Adagia* (Paris, 1500; Eng. trans., London, 1814), and Gryneus, *Adagia* (Frankfort, 1643). ENGLISH: The Old-English Gnostic Verses; Heywood, *Proverbs* (London, 1546?), and *Epigrams* (London, 1562?), reprinted for the Spenser Society (London, 1867); Herbert and Howell as cited above; Ray, *Collection of English Proverbs* (Cambridge, 1670); Bohn, *Handbook* (London and New York, 1855), and *Polyglot of Foreign Proverbs*, with translations (London and New York, 1857; new ed. 1889); and W. C. Hazlitt, *English Proverbs* (London, 1859; new ed., 1882); the agreeable essay by Trench, *Lessons in Proverbs* (New York, 1858); Salbach, *Proverbial Treasury* (ib., 1880); Hoyt and Ward, *Cyclopaedia of Practical Quotations* (ib., 1882); R. Inwards, *Weather Lore* (ib., 1898). SCOTCH: Collections by Fergusson (Edinburgh, 1641), Kelly (London, 1721), Ramsey (Edinburgh, 1737), Henderson (ib., 1832), and Hislop (2d ed., Glasgow, 1868). GAELIC: Macintosh (Edinburgh, 1785), Nicolson (ib., 1882). FRENCH: *Proverbes communs* (fifteenth century); Lebon, *Adages et proverbes* (Paris, 1576); Pancoucke, *Dictionnaire des proverbes* (ib., 1749);

Quitard, *Dictionnaire des proverbes* (ib., 1842); Le Roux, *Livre des proverbes* (ib., 1859); Sauv , *Proverbes de la Basse Bretagne* (ib., 1878). SPANISH: The Infante Don Juan Manuel, *Conde Lucanor* (fourteenth century), where proverbs may be found in the tales; Santillana, *Los proverbios* (fifteenth century), 100 proverbs in rhyme; collections in sixteenth and seventeenth centuries were numerous; *Refranes*, from the dictionary of the Academy (Madrid, 1815); Burke, *Spanish Sall* (London, 1877), as represented by the proverbs in "Don Quixote;" and for full information, J. M. Sbarbi, *Monografia sobre los refranes y las obras que tratan de ellos* (Madrid, 1891). ITALIAN: Giusti, *Proverbi toscani* (Florence, 1853), rev. by Capponi (1884). GERMAN: Wander, *Sprichwörter-Lexicon* (Leipzig, 1867), and Rheinsberg-Düringsfeld, *Sprichwörter der germanischen und romanischen Sprachen* (Leipzig, 1872-75). DUTCH: Harrebom s, *Sprekwoorden boek* (Utrecht, 1858-65). DANISH: Collection by Molbech (Copenhagen, 1850), Gruntvig (ib., 1875). ARABIC: Freytag, *Arabum Proverbia* (Bonn, 1838-43); Burckhardt, *Arabic Proverbs* (London, 1830; new ed., 1875). BELLAR: J. Christian, *Behar Proverbs* (London, 1891). There are also collections of proverbs in Russian, Persian, Hindustani, Chinese, Japanese, and in numerous other languages.

PROVERBIAL PHILOSOPHY. Essays in blank verse, on almost every emotion and condition of life, by Martin Farquhar Tupper, in four series, 1838-76. These meditations, often merely common-place, were once very popular, a million copies, it is said, being sold in America, and were translated into several languages, but are now a synonym for dullness.

PROVERBS, BOOK OF. A book of the Old Testament, containing an anthology of gnomes and sentences, forming, in the Hebrew Canon, the second book of the Hagiographa. Like Job and Ecclesiastes, it belongs to the Wisdom Literature of the Hebrews. The form of these proverbs is manifold—similes, enigmas, theses and antitheses, wise sayings, comparisons, etc., vary constantly. The book falls naturally into eight distinct sections, partially marked off by special titles: (1) Chapters i.-ix., forming a kind of introduction to what follows and chiefly taken up with exhortations to the reader to follow wisdom and flee folly. In chapter viii. Wisdom is personified and introduced as the speaker, while in chapter ix. Folly is likewise personified and the two—Wisdom and Folly—are pictured as women, offering rival invitations and inducements to men. (2) Chapters x.-xxii. 16, with the heading 'Proverbs of Solomon,' constitute the kernel of the collection. Each verse is complete in itself and forms an independent saying. (3) Chapters xxii. 17-xxiv. 22, a small separate collection distinguished from what precedes by a series of maxims that usually extend over several verses—generally two or three, though in one case as many as seven. The address, as in the first collection, is to a 'son' and the exhortations are described as 'words of the wise.' (4) Chapter xxiv. 23-34, forming an appendix to the preceding and distinguished by a separate heading. (5) Chapters xxv.-xxix., with the heading 'These also are proverbs of Solomon collected by the men of Hezekiah, King of Judah.' In this collection

again, each verse, as a general thing, forms an independent saying, though this principle is not consistently carried out. Some of the proverbs in this collection duplicate those found in the second. (6) Chapter xxx., with the heading 'Words of Agur ben Jakeh,' a series of enigmatical sayings. (7) Chapter xxxi. 1-9, exhortations addressed to Lemuel, King of Messa, by his mother, the main theme of which is a caution against wine and women. (8) Chapter xxxi. 10-31, an alphabetical poem devoted to the praise of the virtuous housewife.

It is evident from this survey that the Book of Proverbs is a combination of several distinct collections, to which furthermore a number of fragments from other collections have been added. The name of Solomon is introduced as a symbol of practical and theoretical wisdom, just as elsewhere in the Old Testament Solomon is the symbol of wealth, power, and luxury. Some of the sayings may go back to the days of Solomon, and the tradition (xxv. 1) which ascribes a collection of proverbs to the men of Hezekiah's time may be valid, but this has no bearing upon the collection as a whole, nor does it necessarily settle the date of all the sayings embodied in those portions of the book which are distinctly connected by tradition with the name of Solomon.

The Book of Proverbs represents in all probability a gradual growth that extended over a long period of time. Of the separate collections comprised in the book, all the internal evidence points to the second as the oldest, while the fifth comes next. The first is later. The third and fourth divisions may be regarded as fragments which were added to x.-xxii. 16, and similarly the sixth and seventh divisions are fragments added to xxv.-xxix. The alphabetical poem (xxx.) is an independent composition of a late date. It is doubtful whether the oldest collection belongs to the pre-exile period, and the sections were not put together until after the return from Babylonia. The internal evidence, however, is insufficient for fixing the dates of compilation of the various divisions of the book more definitely. As the latest date for the first section, and therefore the earliest possible date for the compilation in its present shape, we may fix upon B.C. 250. Many of the sayings are no doubt of popular origin, but the great bulk bear a scholastic and pedantic character which points to their rise in literary circles.

BIBLIOGRAPHY. There are commentaries on the Book of Proverbs by Ewald (2d ed., Göttingen, 1867; Eng. trans., London, 1880); Delitzsch (Leipzig, 1873); Nowak (ib., 1883); Strack (Munich, 1888; 2d ed. 1889); Vildeboer (Freiburg, 1897); Frankenberg (Göttingen, 1898); Perowne, *Cambridge Bible for Schools and Colleges* (Cambridge, 1899); and Toy, *International Critical Commentary* (New York, 1899). Consult, also: Cheyne, *Job and Solomon* (London, 1887); Baumgarten, *Etude critique sur l'état du texte du livre des Proverbes* (Leipzig, 1890); Baudissin, *Die alttestamentliche Spruchdichtung* (ib., 1893); Davidson, *The Wisdom Literature of the Old Testament* (London, 1894).

PROVIDENCE (Lat. *providentia*, foresight, from *providere*, to foresee, from *pro*, before, for + *videre*, to see). A term of theology, including two elements, God's preservation and administration of the material universe, and His moral

government over His rational creatures. It may be considered in three aspects. In its *philosophical* aspect, Providence is a direct corollary of the causality of God. If God is the true first cause, that is, if He called all existing things into existence by the exertion of His power, then ultimately they all depend upon Him, and it is impossible to see how they can finally go a way to which He does not consent. If creation includes the gift of free will (q.v.), then there may be opposition to God's will on the part of the creature, or sin. But even the range of this and its outcome will be under God's government, so that it cannot go further than He will have it, and in the realm of nature everything must reflect His will perfectly. In its *religious* aspect the doctrine of Providence meets a universal demand of the moral nature of man. Man demands religion, that is, communion with God. He needs prayer, and the answer of prayer. He needs to know that he can confide himself to the wise and fatherly care of God and will thus be put in safety and under perfect guidance. Particularly in the stress of life, under its burdens and afflictions, he needs to feel that God is supreme, that what is sent to him is for his good and ultimately good itself—else he cannot resign himself to his lot or live in peace of heart and in confidence as to the eternal future. The great proof of Providence from these considerations arises from the conviction that the deepest nature of man reflects God's will, and that demands which He has himself created in man He will satisfy. Providence viewed religiously is of two kinds, general, by which God governs the world at large according to certain wise plans, and special, by which He cares for each individual according to his personal necessities.

In its *biblical* aspect, the doctrine of divine providence is a revealed truth. The Bible is full of expressions of the control of God over nature and man. These expressions are very comprehensive, and often assert, according to Jewish modes of speech, His direct participation in everything, even in the sin of man. He is said to 'create evil,' and to 'harden Pharaoh's heart.' His foreknowledge extends to men's volitions, even their most trifling ones, and to the secrets of their hearts. But the main current of biblical thought provides the due corrective against the hasty erection of such expressions into dogmatic propositions. Man's free will is abundantly recognized, and his responsibility for his sin emphasized. The true meaning of these biblical expressions is that nothing takes place outside of the divine control. That very process which is said to have hardened Pharaoh's heart was designed and calculated to soften it, since it was a long exhibition both of the power and the mercy and forbearance of God. And in the end Pharaoh's wickedness was controlled by God's hand and prevented from going to the point of defeating the divine purposes. The caution may need repeating that we are not to take the popular forms of biblical speech as declaring with metaphysical exactness that no future event can escape the foreknowledge (q.v.) of God and no volition lie outside the scope of His eternal decree. The Bible gives the general law. This is divine government over all things. Ultimately, in the sense of bounding and limiting, every event is governed, in the strictest sense. See PREDESTINATION.

PROVIDENCE. The second largest city in New England, the capital of Rhode Island, and the county-seat of Providence County; 44 miles southwest of Boston and 188 miles northeast of New York (Map: Rhode Island, C 2). It is situated about 35 miles from the Atlantic Ocean, at the head of the Providence River, an arm of Narragansett Bay. Several steamship lines connect with Atlantic coast ports, and the railroad facilities comprise the New York, New Haven and Hartford and leased roads.

The city lies on both sides of the Providence River, its easterly limits being marked by the Seekonk River. Its area is nearly 18 square miles. The surface of Providence is uneven, the west side consisting practically of a sandy plain, while on the east side, the more interesting part of the city, there are several hills, the greatest height of which is some 200 feet. This elevated section offers beautiful sites for residences. The business district is in the centre of the city, and some of the finest business houses are built on made land. There are 228 miles of paved streets, two-thirds of this distance being laid with macadam. In the older part of the city the thoroughfares are narrow and crooked. Providence has 540 acres in public parks, among which is the noteworthy Roger Williams Park. This has been improved at a considerable expense and is a beautiful pleasure-ground. It has a fine system of boulevards, artificial lakes, zoological gardens, and a statue of Roger Williams. The Soldiers' and Sailors' Monument stands in front of the city hall, and near-by is a statue of Gen. Ambrose E. Burnside. What Cheer Rock, on the Seekonk River, is of historic interest as the landing place of Roger Williams.

The new State House, first occupied in 1900, and the city hall are among the finest buildings in Providence. The former is a massive edifice of marble and granite, and has a large dome. Other prominent structures are the public library, the Federal Government building, the county court-house, the Roman Catholic Cathedral of Saint Peter and Saint Paul, the high school buildings, and the Union Railway Station. Among business structures the Arcade is noteworthy, and there are a number of commodious office buildings of recent construction. Brown University (q.v.), with its large buildings on the east side, is one of the principal features of the city. Providence has several noted charitable institutions, among which are the Rhode Island Hospital, Rhode Island Homeopathic Hospital, Butler Hospital for the Insane, Saint Joseph's Hospital, the Dexter Asylum for the Poor, and the State Institute for the Deaf. Besides Brown University, the educational institutions include the Friends' School, which dates from 1818, the State Normal School, the Rhode Island School of Design, and the Rhode Island Law School. The public library contains about 90,000 volumes. Other important libraries are the State Law Library, and those maintained by the Providence Athenæum (62,000 volumes), the Rhode Island Historical Society, and the Rhode Island Medical Society. The Historical Society possesses also a collection of relics, and the Athenæum some valuable pictures.

Providence is a port of entry, but is noted primarily for its manufacturing interests. Its foreign trade in 1901 was valued at \$1,154,000,

of which the exports constituted a very small part. Formerly it carried on considerable foreign commerce, but the trade now is mostly coastwise. Large quantities of coal are handled at its docks, and the city controls extensive wholesale and jobbing interests. The relative unimportance of Providence in foreign commerce is due to the lack of sufficient depth in the harbor for ocean steamships, and to inferior docking facilities. Otherwise the natural waterway through the Providence River and Narragansett Bay forms one of the best harbors on the New England coast. Providence is the first manufacturing city in Rhode Island, its products comprising nearly half of the total output of the State. The various establishments in the census year of 1900 represented an invested capital of \$83,514,000, and had a production valued at \$88,169,000. In the manufacture of jewelry Providence is among the leading cities of the United States; it is noted also for its extensive production of silverware, worsted and woolen goods, cotton goods, engines and boilers, machinery, including cotton milling machinery, fine tools, and files. Dyeing and finishing textiles, refining gold and silver, slaughtering and meat-packing, and the manufacture of rubber and elastic goods, oleomargarine, malt liquors, etc., are other important industries.

The municipal government is vested in a mayor, elected annually, a bicameral council, consisting of a board of aldermen and a common council, and in administrative officers, the majority of whom are elected by the council. The council elects three commissioners of sinking funds, the park commissioners, and the license and fire commissioners. The commissioner of public works is appointed by the mayor. The city treasurer, harbor master, overseer of the poor, and school committee are chosen by popular vote. Providence spends annually in maintenance and operation about \$3,465,000, the principal items being: For schools, \$740,000; for interest on debt, \$640,000; for the police department, \$370,000; for the fire department, \$355,000; for street expenditures, \$290,000; for municipal lighting, \$290,000; for the water-works, \$135,000. The total income for the fiscal year 1902 was \$4,320,000. The water-works, which were constructed at a cost of \$7,100,000, are owned and operated by the municipality. The system now comprises 330 miles of mains. There are 193 miles of sewers. Public bath-houses are maintained as a municipal activity. The bonded debt of the city in 1902 was \$16,825,000, and the net debt \$14,030,000; the assessed valuation of real and personal property was about \$193,000,000.

The population of Providence in 1800 was 7614; in 1850, 41,513; in 1870, 68,904; in 1880, 104,857; in 1890, 132,146; in 1900, 175,597. The total in 1900 included 55,855 persons of foreign birth and 4817 of negro descent.

Providence was founded and named in 1636 by Roger Williams, who, having been expelled from Massachusetts, came here and bought a tract of land from the Narragansett sachems, Canonicut and Miantonomoh. Here a distinct separation was made between spiritual and temporal affairs, complete religious toleration being unequivocally guaranteed. The first Baptist church in America was organized in 1638 under the ministry of Roger Williams. Williams secured in 1644 a Parliamentary charter, under which Providence, Portsmouth, and Newport were

united for governmental purposes as the "Providence Plantations in the Narragansett Bay in New England." In 1676, during King Philip's War, Providence was attacked by Indians and 29 of its 75 houses burned. Near Providence occurred in 1772 one of the first overt acts of the Revolution, the burning of the British cruiser *Gaspee*. In September, 1815, a tremendous gale forced the water back into the harbor and river, flooded part of the town, and destroyed property valued at over \$1,000,000. Providence was incorporated as a city in 1832. Consult: Greene, *The Providence Plantations for Two Hundred and Fifty Years* (Providence, 1886); Bayles, *History of Providence County* (New York, 1891); and a sketch in Powell, *Historic Towns of New England* (New York, 1898). *The Early Records of the Town of Providence* have been printed in 15 volumes (Providence, 1892-99).

PROVINCE (Lat. *provincia*, from *pro*, before, for + *vincere*, to conquer). A term used in geology to designate an area in which the deposition and succession of sediments are uniform. In paleontology it refers to a more or less well-marked district throughout which the animal or plant life was the same.

PROVINCE HOUSE. A brick mansion on Washington Street, Boston, built in 1679. It became the residence of the Governors of the Province in 1715, and after many changes was burned in 1864. It is described in Hawthorne's *Twice-Told Tales*.

PROVINCETOWN. A town in Barnstable County, Mass., 54 miles by water and 120 miles by rail southeast of Boston; on Cape Cod Bay, and on a branch of the New York, New Haven and Hartford Railroad (Map: Massachusetts, G 3). It is situated at the extremity of Cape Cod, and has a deep, spacious harbor. There is a public library with 8500 volumes. Provincetown has some reputation as a summer resort, but is best known for its fishing and whaling industries, the latter of which, however, in recent years has declined considerably. In the town are several wholesale fish establishments, also manufactories of various kinds of oil. Population, in 1890, 4642; in 1900, 4247. On November 21, 1620, the Pilgrims in the *Mayflower* arrived in Provincetown Harbor and remained anchored there for nearly a month. It was here that the celebrated compact was signed and the first Governor, John Carver, was chosen. Permanently settled about 1680. Provincetown formed a precinct of Truro from 1714 until 1727, when it was incorporated. Its growth was very slow and in 1776 it had a population of only 205. Here during the Civil War the Confederate commissioners, Mason and Slidell, were delivered to the British gunboat *Rinaldo*. Consult Freeman, *The History of Cape Cod* (Boston, 1860-69).

PROVING GROUND. An establishment maintained for the sighting and testing of ordnance and the testing of armor and projectiles. In the United States the army proving ground is on Sandy Hook, N. J., and the naval proving ground at Indian Head, on the Potomac River.

PROVINS. *provân's*. The capital of an arrondissement in the Department of Seine-et-Marne, France, on the Voulzie, 59 miles by rail southeast of Paris (Map: France, K 3). Built at the base

and on the slope of a steep hill, with considerable remains of the thirteenth-century ramparts, it has a picturesque mediæval aspect. The chief buildings are the eleventh-century Romanesque Gothic Church of Saint Ayoul; the twelfth-century Transitional Church of Saint Quiriace with its adjacent bell-tower; the twelfth-century Grosse Tour or keep of an ancient fortress; the Church of Sainte Croix, town hall, and hospital dating from the thirteenth century; the sixteenth-century Tour de Notre Dame du Val, and several ancient dwelling houses. The town maintains a museum and public library, and has a public garden and pleasant boulevards. The culture of 'Provins' roses is a local industry of repute; there are manufactures of confectionery, and a trade in the mineral waters of its chalybeate springs. Provins was the Roman *Prucinum*, and under the rule of the counts of Champagne in the Middle Ages was an industrial centre, it is recorded, of over 80,000 inhabitants. Its decay dates from the Hundred Years' War with England and the Religious wars. Population, in 1901, 8794.

PROVISIONAL ORDER (from *provision*, Lat. *provisio*, foresight, from *providere*, to foresee). In England, an order granted under the powers conferred by an act of Parliament, by a department of the Government, by the Secretary of State, or by some other authority, whereby certain things are authorized to be done, which could be accomplished otherwise only by an act of Parliament. The order does not receive effect, however, until it has been confirmed by Parliament. Till that time, it is purely provisional; and even after it has been so confirmed, and is in reality an independent act, it retains the title of a provisional order. Provisional orders have no counterpart in the legislative system of the United States, owing to the political division into States, and to the fact that Congress is thereby relieved of purely local legislation, which in England must be done by Parliament. See PARLIAMENT.

PROVISIONAL REMEDY. Under modern codes of reformed procedure, an extraordinary proceeding to prevent a dishonest defendant from disposing of his property before judgment can be obtained in an action commenced at the same time as the proceeding. Under the New York Code and codes following it, the provisional remedies are: Order of arrest; warrant of attachment; temporary injunction; and receiver. See PROCEDURE; ACTION.

PROVISO (Lat., it being provided, abl. sg. of *provisus*, p.p. of *providere*, to foresee). In law, a clause in a legislative act, or in any legal instrument, which contains a qualification, limitation, or condition affecting or governing the preceding clauses. A common example of a proviso is the defeasance clause in a mortgage, the latter being in form an absolute conveyance, but with a proviso that if the mortgagor, or person who executes it, performs a certain obligation, then the instrument shall become null and void. See CONDITION; DEED; MORTGAGE.

PROVISORS, STATUTE OF. The name of several statutes of England, which were intended to prevent the Pope from presenting to benefices in England, or, as it was technically known, from using the rights of provision and reservation. Since the time of Innocent III. (1198-1216) the

Pope had frequently appointed foreigners to bishoprics and the like. Often these never lived in England, and merely sought to derive as much revenue as possible, leaving the ecclesiastical duties to others. Edward I. in the Statute of Carlisle (1307) sought to prevent the heads of the great monastic Orders from burdening the English monasteries with taxes, and by implication included the Pope in this prohibition. It was not, however, until 1351 that the first Statute of Provisors of Benefices was passed, which seriously aimed to check the various abuses. Heavy penalties were to be imposed for the violation of the law. Nevertheless the statute was not enforced, and it was reënacted in 1362 and again in 1390, the last time with additional safeguards. For diplomatic reasons, however, the kings of England were compelled frequently to give way to the Papal demands, and consequently the statute was in practice always suspended. Moreover, the King himself found it often convenient to override the rights of the cathedral chapters and obtain the appointment of a favorite to some benefice or other by employing the aid of the Papal machinery. It was not until the breach with Rome took place in the reign of Henry VIII. that the abuses which the Statute of Provisors sought to check ceased. The text of the statutes will be found in Adams and Stephens, *Select Documents of English Constitutional History* (New York, 1901). Consult also: Stubbs, *Constitutional History of England* vols. ii. and iii. (Oxford 1895-96); Lingard, *History of England*, vol. iii. (London, 1883).

PROVO CITY. The county-seat of Utah County, Utah, 48 miles south of Salt Lake City; on the Provo River, and on the Rio Grande Western and the Oregon Short Line railroads (Map: Utah, B 1). It has the Brigham Young Academy, one of the largest educational institutions of the Latter Day Saints, a Mormon tabernacle, and the State Insane Asylum. Utah Lake, three miles distant, the Bridal Veil Falls, and the Provo Cañon are much visited for their scenic attractions. Provo City is situated in an agricultural, fruit-growing, and cattle-raising region. It manufactures woolen goods, flour, tin and iron roofing, etc., and there is considerable trade in lumber. Settled in 1849, Provo was chartered as a city in 1851. Population, in 1890, 5159; in 1900, 6185.

PROVOKED HUSBAND, THE. A comedy begun by Vanbrugh as *A Journey to London*, and left unfinished at his death. It was completed by Colley Cibber and published in 1728.

PROVOKED WIFE, THE. A comedy by Vanbrugh, produced in 1697. The hero, Sir John Brute, a rough, mischievous fellow, annoyed his fine-lady wife by swearing, and going home drunk every night after wild escapades. It was Garrick's favorite part.

PROVOOST, pró-vô', SAMUEL (1742-1815). First bishop of the Protestant Episcopal Church in New York. He was born in New York City, of Huguenot descent, and was educated at King's (now Columbia) College. In England he continued his studies at St. Peter's College, Cambridge, and was ordained priest in 1766. He returned to New York and became an assistant minister of Trinity parish, a post he retained until 1774, when he withdrew, it is alleged, on

account of holding views regarding the approaching struggle with the mother country at variance with those entertained by the majority of the parishioners. He declined to serve as delegate to the Continental Congress, though his patriotic impulses led him to join his neighbors in their pursuit of the British after the burning of the town of Esopus. He did not resume the active ministry until the close of the war, when, in 1784, he became rector of Trinity Church, New York, and shortly thereafter a member of the Board of Regents of the University. The following year he became chaplain of the Continental Congress, then meeting in New York. In 1786 he was elected first Bishop of New York at the Diocesan Convention, and in company with William White, Bishop-elect of Pennsylvania, sailed for England, where they were consecrated at Lambeth by the archbishops of Canterbury and York and the bishops of Bath and Wells and Peterborough. As a preacher Bishop Provoost was learned and polished, but without warmth and fervor. In 1800 he resigned the rectorship of Trinity and the following year sought to relinquish his episcopal office, but the House of Bishops, declining to accept his resignation, appointed instead an assistant bishop. Consult: *The Centennial History of the Protestant Episcopal Church in the Diocese of New York, 1785-1885*, edited by James Grant Wilson (New York, 1886); and *The History of the American Episcopal Church, 1587-1883*, by William Stevens Perry (Boston, 1885).

PROVOST (OF. *provost*, *prevost*, Fr. *prévôt*, from Lat. *praepositus*, principal, provost, p.p. of *praepone*, to set before, from *prae*, before + *ponere*, to place). The title of various academic, ecclesiastical, and civil officials. In England the heads of certain colleges, as of Oriel, Queen's, and Worcester at Oxford, of King's College, Cambridge, and of Eton College, are called provosts. In the United States this title is given to the heads of some institutions, as, for example, the University of Pennsylvania. It is applied as an ecclesiastical title to the head of a cathedral or collegiate chapter, especially in Germany. The title is also given to the superiors of certain religious houses of lesser rank which bear a relation to the mother house analogous to that which a priory bears to an abbey. In the Protestant churches of Germany the title of provost is sometimes used as synonymous with that of dean or arch-priest; and occasionally, where several minor churches or chapels are attached to one chief church, the minister in charge of the latter is called provost. The civil use of the title is found chiefly in Scotland, where the chief municipal magistrate of a burgh or city is styled provost. The provost presides in the civil courts together with the bailies, who are his assistants. The chief magistrates of the cities of Edinburgh and Glasgow are styled Lord Provost, and the claims of the provosts of Aberdeen and Perth to the designation of lord, although at one time contested, are now held to be fully established.

PROVOST-MARSHAL. A military official in charge of the military police of a camp, garrison, or in the field. In the United States Army he is required to accept all prisoners handed over to him by an officer belonging to the army or navy, and has also within his province the duty of arresting soldiers guilty of offenses of a gen-

eral nature. In the British Army the provost-marshal has a captain's rank, and authority to punish any offender taken *flagrante delicto* on the spot, according to the provisions and penalties laid down in the Mutiny Act.

In the navy the provost-marshal is an officer attached to a naval court-martial who is responsible for the safe keeping of prisoners under trial before the court; also for the serving of notices to witnesses and executing the processes of the court. He is usually an officer of the navy (not above the rank of lieutenant) or of the marine corps (not above the rank of captain), but in case of the trial of enlisted men a petty or non-commissioned officer may act as provost-marshal.

PROXY (contraction of *procuracy*, from ML. *procuracia*, *procuratia*, charge, care, from *procurare*, to take care of, from *pro*, before, for + *curare*, to care, from *cura*, care). The agency of one person who acts as substitute for another, usually in public assemblies, conventions, and other bodies. It is now rarely permitted in legislative bodies, though formerly it was the privilege of English peers. A result of this privilege was the somewhat notorious non-attendance of the Lords upon the sessions of Parliament. In the United States voting by proxy is quite common in political conventions.

PRUDEN, prūd'den, THEOPHIL MITCHELL (1849—). An American physician, teacher, and author, born at Middlebury, Conn. He was educated at the Yale Medical School, the New York College of Physicians and Surgeons, and at the universities of Heidelberg, Berlin, and Vienna. In 1879 he was appointed assistant in histology and pathology in the College of Physicians and Surgeons, of Columbia University, and in 1892 was given the chair of pathology there. His technical publications include a *Manual of Normal Histology* (1881), a *Handbook of Pathological Anatomy and Histology* (with F. Delafield, 1885), *Story of the Bacteria* (1889), *Dust and Its Dangers* (1891), and *Drinking Water and Ice Supplies* (1891).

PRUDENTIUS, prōō-dēn'shī-ūs (AURELIUS CLEMENS PRUDENTIUS) (348-405?). The greatest poet of the early Latin Church and one of the leading literary figures of the fourth century. He was born in Spain (probably in Saragossa). He received a liberal education, was admitted to the bar, practiced as a pleader, discharged the functions of a Roman magistrate, and received appointment to a high position at Court. His early life was gay and dissipated, but after his conversion he devoted himself to the service of the Church. He lived in an age of great Christian leaders, among them Ambrose, Jerome, and Augustine, and from Ambrose he derived his impulse toward poetic composition. Among his poems the *Cathemerinon*, or 'Daily Round,' includes twelve hymns, of considerable length, designed for devotional use. The *Psychomachia*, or 'Soul's Conflict,' pictures the battle which virtue and vice wage over the soul of a Christian. This is the earliest type of pure religious allegory in the Western Church, and may almost be said to mark an epoch in literary history. In the *Peristephanon*, or 'The Crowns,' we have a collection of fourteen hymns in praise of martyrs and martyrdom, about half of them dealing with Spanish subjects. The two books *Against Symmachus* carry on the battle,

already begun by Ambrose, against the proposed restoration of the altar of Victory to the senate house. Two of Prudentius's poems are distinctly theological, the *Hamartigenia*, on the origin of evil, and the *Apotheosis*, a defense of the doctrine of Christ's divinity. In both these works the influence of Tertullian is unmistakable. Consult: Glover, *Life and Letters in the Fourth Century* (Cambridge, 1901); Ebert, *Geschichte der Literatur des Mittelalters* (2d ed., Leipzig, 1889); Boissier, *La fin du paganisme* (3d ed., Paris, 1898); Thackeray, *Translations from Prudentius* (London, 1890).

PRUD'HOMMES, pru'dôm' (Fr., discreet men), **COUNCIL OF**. Municipal tribunals, which existed first in the Middle Ages at Marseilles, Lyons, and elsewhere in France, exercising an equitable jurisdiction as arbiters of trade disputes. Similar tribunals, under the same name, were re-introduced by Napoleon I. in 1806, and were found to be of great practical utility. They were instituted at first in favor of the silk trade and other trades immediately connected with it. Under the present French Republic the system has been continued, the *Conseils des Prud'hommes* being citizens elected by the people irrespective of their connection with capital or labor. In their original form they somewhat resembled the boards of arbitration established in several of the United States, whose purpose it is to cause a speedy and just settlement of labor disputes.

PRUD'HON, pru'dôn', PIERRE (1758-1823). A French historical and genre painter, born in Cluny. His father was a stone-cutter, and he received his first instruction from the monks of the Abbey of Cluny. Afterwards he studied under Desvoges at Dijon. An unfortunate marriage handicapped the painter in his youth. He worked in Paris with Wille, the engraver, and in 1783 won the *Prix de Rome*. In 1789 he returned to Paris, and at first supported himself by working for the booksellers, but finally attracted the attention of Napoleon, who gave him lodging in the Sorbonne. Under the influence of his friend Constance Mayer, a pupil of Greuze, he painted his best pictures, such as the portrait of Josephine (Louvre) and "Crime Pursued by Vengeance and Justice" (1808, Louvre), for which he received the Legion of Honor. In 1811 he was appointed drawing master to the Empress Maria Louisa, and in 1816 he was elected to the Institute. After the death, by suicide, of Mlle. Mayer, in 1821, Prud'hon completed his picture "The Unfortunate Family" (Louvre), and painted a few religious pieces, including "Crucifixion" (Louvre). Though he nearly always painted classical subjects, he was one of the principal precursors of Romanticism. In Italy he had studied Leonardo, and his women have something of the subtlety of this master. The delicacy of his coloring, the correctness of his drawing, and the simplicity of his conception, make him one of the most pleasing of the successors of David. Consult: Clément, *Prud'hon, sa vie, ses œuvres et sa correspondance* (Paris, 1868 and 1872); De Goncourt, *L'art au XVIIIème siècle* (Paris, 1875).

PRUNE (Lat. *prunum*, plum, *prunus*, plum-tree, from Gk. *πρῦνον*, *prounon*, *πρῦνον*, *prounon*, plum, *πρῦνος*, *prounos*, *πρῦμη*, *proumnê*, plum tree). Any variety of plum which can be successfully cured without removing the pit. Only those varieties which have a large propor-

tion of solids, and sugar in particular, are considered good prunes. The prune industry was started in the Eastern United States in 1854, but failed because the climatic conditions were not favorable for the production of the desired qualities. About 1863 the industry started in California and grew rapidly. In 1880 the output had reached 200,000 pounds annually, and in 1900, 100,000,000 pounds, thus developing in 30 years an industry with an annual output greater than France, hitherto the chief prune-producing nation of the world. Oregon, Washington, and Idaho also grow good prunes, as do also Serbia, Germany, Spain, Australia, and South Africa.

The prune may be cured in three ways. (1) Sun-drying, the common and most economical way where climatic conditions will admit it. This is largely practiced in California, as well as in the European countries. The prunes are not picked until ready to fall, when they are gathered, graded, and dipped in hot lye or run through a pricking machine, after which they are spread on boards or wire-bottomed frames and put out to dry, an operation which takes from 8 to 12 days, depending upon the variety, the size of the plum, and the weather. (2) They are treated by evaporation, the drying being effected by fire heat. In this operation great care and skill are necessary, as too hot a fire will cause the fruits to burst, drip, and finally shrivel. If properly handled the evaporated product is superior to the sun-dried fruits. (3) The fruits in some European countries are partially cooked before being dried. Such prunes are softer than the sun-dried or evaporated ones. After being dried the fruit goes through a curing process, by being thrown into bins or heaps to sweat, which takes from one to three weeks. After this they are ready for 'processing,' which consists in dipping fruits in boiling water and glycerin, steaming, or by 'rattling' in a revolving cylinder. The object of this operation is to improve the color and appearance of the fruit and to destroy the eggs of any insect which may be upon them. They are then ready for packing, the best products being placed in boxes, although many are packed in bags.

PRUNE INSECTS. The insects which damage the prune are mainly those found on plums and peaches (q.v.).

PRUNING (from *prune*, from OF. *proignier*, *progner*, *provignier*, Fr. *provigner*, to prune, from OF., Fr. *provin*, vine, from Lat. *propago*, sucker, from *propagare*, to propagate, from *pro*, before, for + *pangere*, Gk. *πρηνύσαι*, *pēgnynai*, to fasten). The removing of any part of a plant, either root, stem, or branch, to discourage growth in one direction and turn the energies of the plant in another. It is considered an artificial operation, but nature is a constant and very severe pruner, as is shown by the long, slender, limbless boles of many forest trees. When plants are taken from their natural environment and the forces which regulate their habits, pruning becomes a necessity. In this work the gardener must be guided by the well-known laws of plant growth governing the healing of wounds and the balance of parts. At planting time the tops of trees must be pruned in order to establish a proper relation of top to root, which is always unavoidably reduced in the process of digging. This pruning is necessary also because the roots

have no intimate connection with the soil by which the demands of the expanding leaves can be supplied with food and moisture; in fact, the demands of the top should be less than the root can meet in order that a too severe strain shall not be placed upon the organism. Pruning may be performed for the purpose of correcting the habit of growth. The head may be made high or low, compact or open, at will, almost regardless of the natural habits of the tree. In general, however, the peculiar nature of the tree should be taken into account and the pruning made to conform as closely as possible to that form. Where fruit is the object sought the manner of fruit production of the plant must be thoroughly understood, otherwise pruning may induce wood growth at the expense of fruit production. For instance, apples and pears bear fruits upon spurs; peaches, usually on the young branches (sometimes on spurs) of the previous season's wood; grapes, on wood of the current year produced from buds developed the year previous. In order, therefore, intelligently to prune any plant for fruit production, its fruiting habit must be carefully considered. Sometimes desired results are obtained by root pruning, or by cutting away a portion of the bearing wood. In the first case fruit-bearing is induced, in the second the fruits are thinned or their number decreased, the food supply distributed to a lessened number which may be correspondingly increased in size. Pruning also admits light to the tree tops by removing superfluous branches, thus making the fruits higher colored.

Besides these objects pruning is used to change the form of head ('heading'). Whatever be the object, the operation should be performed in the manner least injurious to the plant. This involves the method of removing the branch and the time of year the work should be done. In regard to the season for pruning little exact information can be given. As a rule apples, pears, and cherries suffer least if pruned while, in full vigor of growth. The wounds heal readily and there is less liability to loss of vitality than at other seasons. The peach should be pruned early and severely for wood growth, and late and lightly for fruit production; the same is also true of the grape. All pruning of the grape and peach should be confined to the resting period.

The manner of pruning so as not to lessen the vigor or shorten the life of the plant involves systematic annual pruning, by which the removal of large branches can be avoided. All cuts should be made close to and parallel with the main branch so as to promote the healing process. Large wounds must be covered with some preservative or protective coating to prevent decay. The healing of a wound is accomplished by the formation of a callous from the growing tissues. The process continues, and by the annual deposition of new material the wound is covered. A smooth cut will heal where a jagged cut or bruise will decay. Trees grown upon walls or espaliers require great skill in pruning in order to hold them within bounds, and at the same time secure the maximum production of fruit or flowers. In grape-growing certain styles of pruning have been given special names—e.g. renewal; high renewal; Kniffen, etc.

Ornamental trees are either pruned for the purpose of correcting the habit of growth, as the shortening of a leader in order to thicken the

growth and make the tree broader, or for the purpose of giving the plant a particular form, as is the case with hedge plants and with evergreens used in formal gardens.

Consult Bailey, *The Pruning Book* (New York, 1898), also numerous experiment station bulletins.

PRURIGO (Lat., itch). The name of a skin disease restricted to *prurigo of Hebra*, not including all conditions in which there is pruritis. Formerly dermatologists distinguished *prurigo mitis*, *prurigo formicans*, and *prurigo senilis*, which are now relegated to the eczematia and the lichens (q.v.). True prurigo, also called *prurigo agria* or *ferox*, begins in infancy or in childhood or youth, persisting with recurrences for many years. It resembles *urticaria* (q.v.). The eruption is generally at first a series of white or rosy plaques with itching, agitation, and in-omnia. Then papules appear, as pale red points, excoriated at the summit, usually on the anterior and external portions of the legs and thighs, about the pelvis and buttocks, and also upon the upper extremities. The skin hardens, and becomes thicker, furrowed with folds and covered with crusts. Vesicles may appear, exuding yellowish serum, or sanguineous, and blackened. Impetigo, furuncle, abscess, and lymphangitis, all resulting from inoculation, may complicate the attack. Indolent lymphatic glandular enlargements may appear in the groin. The prognosis is very unfavorable. The disease generally disappears between the eighth and eighteenth year, in the milder cases. Many are incurable. Asthma, emphysema, and chronic bronchitis are very common among the victims of prurigo. Diet, cod-liver oil, pilocarpine, carbolic acid, cannabis indica, and analgesics are of avail. Bran baths, starch baths, cod-liver oil, styrax, sulphur, ichthyol, and resorcin are among the local applications used. Hermetically sealing up the skin is the most effectual treatment of all. Consult Kaposi, *Pathology and Treatment of Diseases of the Skin* (Eng. trans., New York, 1895).

PRUSSIA, prūsh'ā. A kingdom and the largest State of the German Empire. By the Imperial Constitution of 1871 the King of Prussia bears the title of German Emperor. The Prussian territory completely or nearly surrounds that of five of the smaller States of the Empire—the grand duchies of Mecklenburg-Schwerin and Mecklenburg-Strelitz, the duchies of Anhalt and Brunswick, and the Grand Duchy of Oldenburg; also the three free towns of Lübeck, Hamburg, and Bremen. With these exceptions the whole of North Germany and its low plain are embraced in the Kingdom of Prussia. A small detached portion of Prussia, Hohenzollern, is in the extreme south of the Empire. Exclusive of Hohenzollern, Prussia extends from latitude 49° 7' to 55° 54' N., and from longitude 5° 52' to 22° 54' E. It is bounded on the north by the North and Baltic seas and Denmark, on the east by Russia (mainly Poland), on the south by Austria-Hungary, Saxony, the Thuringian States, and the South German States, and on the west by the North Sea, the Netherlands, Belgium, and Luxemburg. With an area of 134,548 square miles, it embraces more than three-fifths of the territory of the German Empire. It also has three-fifths of the population of Ger-

many. The density of population is over 250 to the square mile.

TOPOGRAPHY. Prussia has a frontage of nearly 1100 miles on the North and Baltic seas. The tidal variations of level in the North Sea are not great, but northwest storms have wrought great destruction on the low, flat seaboard of Prussia, so that in the course of centuries a large area of coast has been destroyed by the washing away of the shores. The Frisian Islands, fronting this part of the Prussian coast, are the ruins of a former coast line, and large parts of the present coast are saved from destruction only by costly works of protection. Much of the coast is bordered by marshy land, which affords fine pasturage. The Baltic, still more shallow than the North Sea, also lacks important flood and ebb tides, and no marsh formations are found along this coast. There are fewer islands than along the North Sea, one, however, the island of Rügen, being of considerable size. The coast has several deep indentations, the most important of which are Kiel Bay, Lübeck Bay, Pomeranian Bay, and the Gulf of Danzig. Sand dunes stretching along parts of the coasts have nearly cut off the sea, and the lagoons (Haffs) within are filled with fresh water from the rivers emptying into them, so that the Haffs are only slightly brackish. Outside of Hamburg, Bremen, and Lübeck, Prussia has all the important seaports of Germany.

The great plain which comprises by far the larger part of Prussia is by no means flat or level, though its elevations formed of the accumulations of boulders and ground moraine of the Ice Age rarely exceed 600 feet in height. Communications in all directions meet with no obstacles on this comparatively level surface, stretching in Prussia between the Ems and Russia and southward nearly to the southern boundary of the kingdom. (See GERMANY.) In the south-centre (region of the Harz) and the southwest (lower Rhine Plateau) the surface rises and merges with the hilly and mountainous regions of the South German States; but in the southeast the great northern plain is continued in the low plain of the Oder and only the fringe of the kingdom covers the northern part of the Sudetic ranges.

HYDROGRAPHY. Prussia has the middle and lower courses of all the great rivers of Germany excepting the Danube. It is within its borders, therefore, that the Rhine, Weser, Elbe, and Oder attain their highest availability for navigation, as they flow over the plain gently sloping to the north and northwest. In the northeast are the Vistula, Pregel, and Memel (Niemen), the first and last entering the country from Russia. Naturally the canal system of the Empire has its largest development on the Plain of Prussia, where these artificial highways may most easily be constructed. (See GERMANY for rivers, canals, and lakes.) All the great rivers of the plain receive their large tributaries from the east, so that their courses are near the western limits of their drainage systems.

CLIMATE AND SOIL. The differences of temperature between Prussia and South Germany are not great, the southern States being much more elevated. In winter the south in the same longitude is no warmer than Western Prussia, which has the ameliorating influence of the North Sea. The temperature differences are greater between the west and the east of Prussia, as the

continental influences are intensified toward the east. The Rhine Province is the warmest part and the Baltic lands are the coldest parts of Prussia. There is sufficient rainfall for agriculture, the precipitation being quite evenly distributed and averaging 21 inches per annum, and being as high as 30 inches or more near the North Sea. (See GERMANY, paragraph on *Climate*.) The soils are best in the Rhine Province, but the sandy plain is poor in plant food and is made highly productive only by the most scientific methods of fertilization. Sixty-three per cent. of the soil is poor or mediocre sandy loam or sand, 6 per cent. is bog or marsh, and 29 per cent. is good loam or clay. For **FLORA** and **FAUNA**, see GERMANY.

GEOLOGY AND MINERAL RESOURCES. The whole plain is strewn with sand and clay of Quaternary age that have been spread over the surface by glacial and alluvial action from the Ice Age till the present time. These deposits rest upon areas of all formations from the Primary down through the Tertiary, small parts of these harder rocks projecting here and there above the diluvium and alluvium, as, for example, the chalk cliffs of Rügen and the limestone plateau to the east of Berlin near Riddersdorf. In the southeast, the mountains of Silesia are chiefly composed of granite, gneiss, and schists, while the highlands of the Harz and the lower Rhenish Plateau are composed almost entirely of Devonian and Silurian rocks. Prussia ranks among the great mining countries and leads the German States in value of mineral product. Ninety per cent. of Germany's coal comes from Prussia, chiefly from Silesia, Westphalia, and the Rhine Province. Lignite is extensively mined in the Province of Saxony. The output of coal in 1900 was 101,966,158 tons (metric), and of lignite 34,007,542 tons. Westphalia, Silesia, Hanover, and Hesse-Nassau are the sources of Prussian iron, the output of pig iron in 1900 amounting to 5,781,893 tons (metric). Upper Silesia is the world's largest source of zinc, and the output in 1900 was 155,760 tons. Copper-mining in that year yielded 32,181 tons, and lead 115,105 tons. The total value of mining products in 1900 was 1,096,087,900 marks, and of the smelting products 584,513,724 marks. See GERMANY, paragraph on *Geology and Mineral Resources*.

AGRICULTURE. Prussia is the most important agricultural State of the German Empire, containing about two-thirds of the entire cultivable area. In 1895 the number of acres under cultivation was 70,344,953. Though Germany is one of the European countries in which most of the agricultural holdings are divided among small owners, there are more large estates in Prussia than in any other part of the Empire. They are especially numerous in the eastern provinces, where the land system is much like that of neighboring Poland, in which the country districts are still divided to a large extent among the gentry. In the same way many of the old landed gentry of Prussia still live on estates embracing 2,500 acres or upward; and the estates above 500 acres each aggregate about one-fifth of the land held in agricultural holdings. On the other hand, small holdings (from 5 to 250 acres) vastly predominate in the west and centre, though also numerous in the Province of East Prussia. In spite of the fact that Germany has become a manufactur-

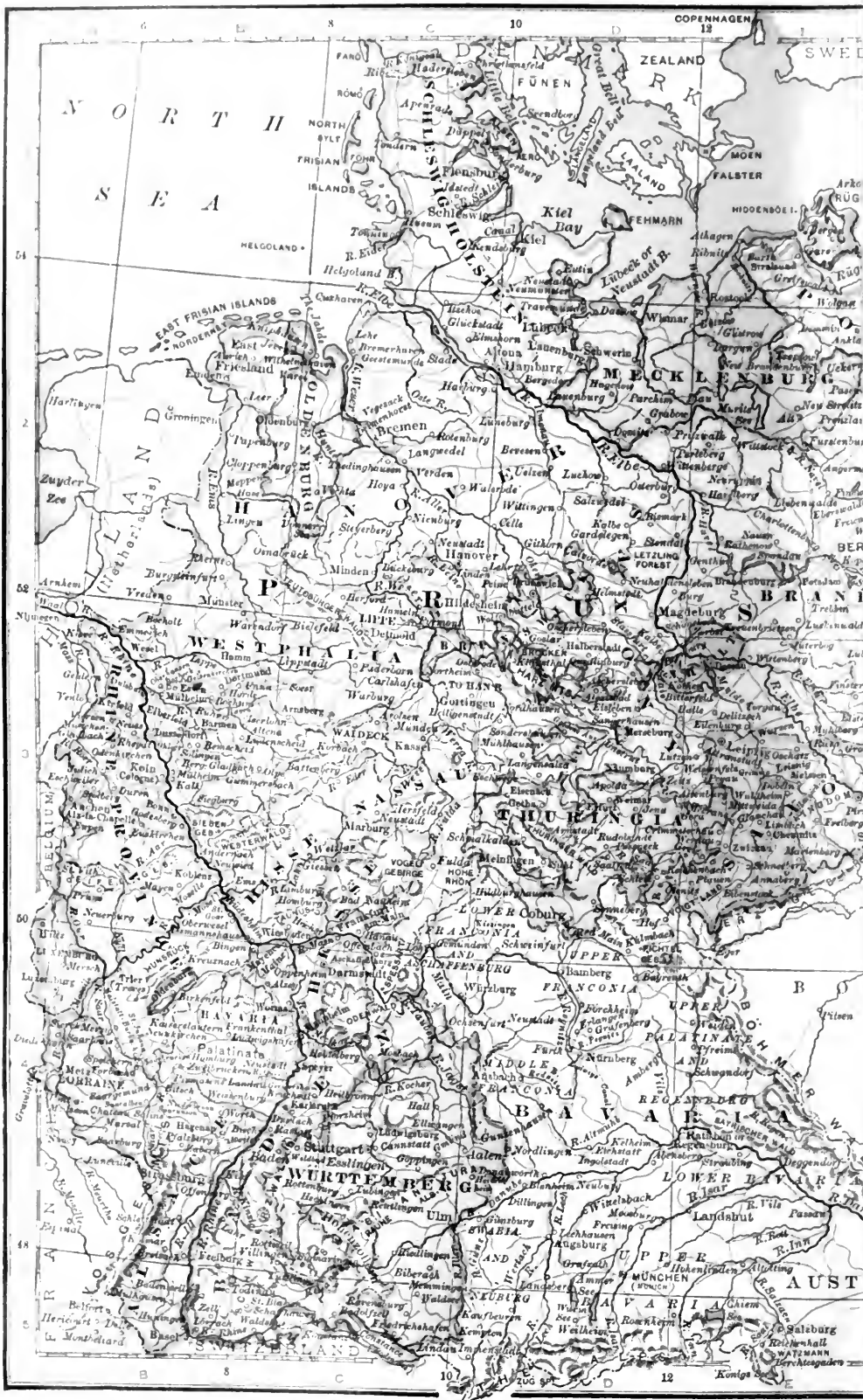

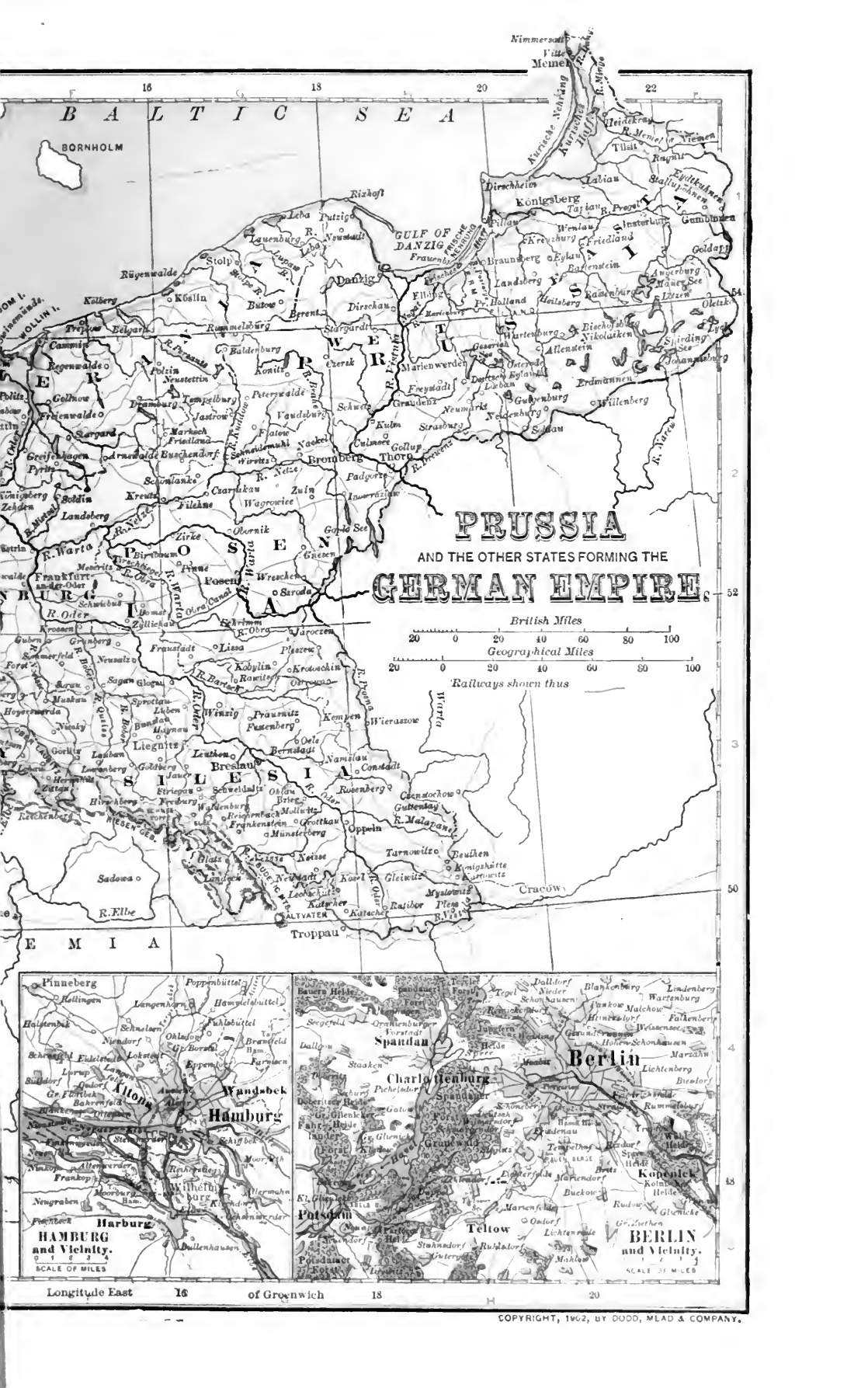

ing rather than an agricultural nation, the farmers of Prussia are in a fairly prosperous condition, owing to intensive cultivation of the land, the fostering care of every agricultural interest both by Imperial and royal legislation, and the use of excellent farm machinery. Among the later developments of Prussian agriculture is the association of neighboring farmers for the purpose of buying machinery run by electricity, alcohol, or other artificial motive power for plowing, threshing, grinding grain, and many other purposes. Prussia leads the world in the use of alcohol as steam-producing fuel, the alcohol being chiefly produced from its potato crop.

All the common agricultural products are raised in Prussia. The provinces of East and West Prussia, Posen, Pomerania, and Hanover are most important agricultural sections, not only of Prussia, but of Germany as well. Prussia produces more than three-fourths of the entire rye crop of Germany (the chief food of the peasantry and most important cereal in the Empire), in addition to 70 per cent. of the potato crop (a large amount of it turned into alcohol for fuel and illumination), 60 per cent. of the wheat crop, 65 per cent. of the oats crop, and over 80 per cent. of the beet crop. Rye and wheat are raised all over the kingdom; oats chiefly in East Prussia, Hanover, the Rhine Province, and Silesia; and barley chiefly in Silesia and Saxony. The greater part of Germany's beet crop is grown on the plains of Prussia from the Harz Mountains to Silesia. The vineyards of Prussia cover an area exceeding 45,000 acres and yielded in 1900 6,752,000 gallons of wine. Fruit culture, including all the fruits of the temperate zone, is highly developed, and the fruit trees in 1900 numbered 90,220,375.

The area under the principal crops in 1900 (in acres) and the yield (in metric tons) are shown in the following table:

	1900	
	Area	Yield
Rye.....	11,277,340	6,370,989
Oats.....	6,710,930	4,631,640
Wheat.....	2,999,860	2,390,578
Barley.....	2,196,731	1,649,982
Potatoes.....	5,477,095	27,564,406
Hay.....	7,992,873	10,934,739

Prussia is the leading German State in the number and quality of live stock. The breeding of horses is extensively carried on in the provinces of East and West Prussia and Hanover; while many cattle are bred along the North Sea and in Saxony, the region of the marshes, drained and otherwise improved, being particularly favorable for cattle-raising and the dairy industry. Pomerania is well known for its sheep. Goats are found in great numbers, especially in the eastern provinces. In 1900 the domestic animals included 2,913,003 horses, 4702 asses and mules, 10,865,296 cattle, 6,989,430 sheep, 10,954,002 swine, and 1,998,692 goats. The fact that the kingdom has now only about one-third as many sheep as in 1873 is chiefly due to two causes: the decline in the price of wool and the subordination in Germany of agriculture to manufacturing industries, hundreds of thousands having abandoned the farm for the factory, and pastures having been turned into fields to raise food for the growing industrial towns. The result is that Prussia

needs to import large quantities of wool for its factories. A large part of the cavalry horses in the German army come from Northeast Prussia, and the Prussian Government, through the stud farms which it maintains, about 20 in number, exerts great influence on the scientific breeding of horses.

About 23 per cent. of the area of Prussia is under forests. Only a little over one-half of the total forest area is in private hands, and private ownership is constantly declining. The remainder is held by the State and local governments, the State controlling about two-thirds of the area. The largest forests are in Brandenburg, Silesia, and the Rhine Province, while Hohenzollern and Schleswig-Holstein are almost entirely devoid of woods. Nearly one-third of the forest area is under coniferous trees, the remainder being under deciduous trees; the former predominate in the north. The Prussian Government derives a revenue of about \$20,000,000 a year from the forest industry. See GERMANY, paragraphs on *Agriculture*, *Stock-Breeding*, and *Forestry*.

MANUFACTURES. The increase from 1882 to 1895 in the number of persons employed in the Prussian manufacturing industries was over 33 per cent. The textile industries thrive in Rhenish Prussia, noted for its cotton spinning and weaving, and for its woolen and silk products, and Silesia, known both for its cotton and linen manufactures. Aachen (Aix-la-Chapelle) and its district are a great seat of the woolen manufacture, and Krefeld and Elberfeld are noted centres of the silk industry. Berlin and Rhenish Prussia and some of the largest cities in other sections of Prussia turn out most of the machinery and metal work. The iron and steel industry is on a vast scale, and is chiefly centred in the coal field of the Ruhr. Large amounts of the pig iron and steel made in that region are sent to machine shops in various parts of the country for conversion into a great variety of articles. The most famous iron and steel works are at Essen. Ship-building is a very important and growing industry in the cities of Kiel, Danzig, Stettin, and Elbing. Car and wagon works centre largely in the eastern cities of Breslau and Königsberg, besides Cologne, Düsseldorf, and Görtitz. Glass and porcelain ware and pottery are produced in Rhenish Prussia, Silesia, and Saxony; the same is true of paper. The chemical industry is especially important in the Rhine cities, and is also prominent in Berlin. See GERMANY, paragraph on *Manufactures*, and the articles on the provinces and leading cities.

	1882	1895
1. Mining and smelting.....	359,177	458,504
2. Quarries and potteries.....	216,931	314,258
3. Metal industry.....	285,112	383,932
4. Machine and instrument making.....	200,528	329,404
5. Chemical industry.....	38,722	66,661
6. Textile industry.....	428,543	441,885
7. Paper industry.....	48,856	72,250
8. Leather industry.....	68,354	86,692
9. Wood-working.....	253,925	322,989
10. Manufacture of food products (including beverages).....	393,105	586,353
11. Clothing industry.....	741,142	800,427
12. Building trades.....	331,338	596,690
13. Printing and publishing trades.....	35,970	67,539
14. Artistic trades.....	7,672	9,503
15. Manufacture of lighting material—soaps and fat.....	24,399	35,038
Total.....	3,433,774	4,572,125

Out of a total of 8,000,503 persons engaged in the manufacturing establishments of Germany in 1895, 4,572,125, or 57 per cent., were employed in Prussia. They were distributed among the foregoing industries (the figures of 1882 being also given for purposes of comparison).

TRANSPORTATION AND COMMUNICATION. One of the greatest factors in the industrial development of Prussia has been the excellence of its inland water routes and railroad lines, which supplement instead of rivaling one another. An enormous tonnage is carried on the great rivers, on their canalized tributaries, and on the canals, which connect the rivers, so that the waterways as well as the railroads gridiron Prussia, serving commerce between the east and west as well as between north and south. Steel lighters of large tonnage and small draught have replaced heavy wooden boats on the canals. The Government expends enormous sums in the improvement and maintenance of the waterways. In the thirteen years ending in 1903, the public treasury disbursed \$58,388,750 on the rivers, canals, and wagon roads, and new canal projects or river improvements are constantly under way. The Kaiser Wilhelm Canal saves two days of steam travel between Hamburg and the Baltic ports as compared with the old route around Jutland.

The Prussian railway system covers not only the entire territory of the kingdom, but also that of several minor German States, thus commanding the commerce of all Northern Germany. Since 1897, when the Prussian railway system was combined with that of Hesse, Prussia has effected an entrance into the southern territory of Germany. (See GERMANY, paragraph on *Railways*.) In 1902 there were 21,110 miles of railroad in operation in Prussia, of which the State owned or administered 19,440 miles. Government ownership and operation has proved a complete success from a financial and commercial point of view. The Government derives nearly one-fourth of its entire revenue from the profits of its railway operation, and is able by the manipulation of freight rates to come to the aid of industries in need of special encouragement.

Prussia is one of the six German States possessing a merchant marine. It ranks third, being exceeded by Hamburg and Bremen. Stettin, the largest Prussian port, is far behind. The Baltic ports are frozen over in winter, but that of Stettin is kept open by ice-breakers. It is the nearest port to Berlin, and one of the present canal projects is to connect them by a waterway. Danzig is a large outlet for the cereals of North-east Prussia. Other important seaports are Königsberg, Memel, and Altona. The merchant marine in 1900 comprised 531 steamers, of 193,411 tons net capacity, and 1543 sailing vessels, of 76,893 tons. Prussia carries on about one-third of the total German foreign trade.

COMMERCE. The commerce of Prussia is facilitated by her central position and by the network of river and canal navigation, which make her territories the connecting medium between several of the great European States, and give her a free outlet to the rest of the world. Yearly markets are held in about 2700 towns. See GERMANY, paragraph on *Commerce*.

BANKING. The banking system of Prussia does not differ from that of the rest of the German Empire. (See GERMANY, paragraph on *Banking*.)

The Imperial Bank acts as the fiscal agent of the kingdom. Prussia occupies a commanding position in the banking world of Germany, since Berlin is the most important financial centre of the country. The eleven great corporate banks of Berlin (not including private banks like Bleichröder, etc.) do almost as great a business as the Imperial Bank of Germany, with its 300 branches. In the closing year of the nineteenth century the combined volume of business done by the Berlin banks was about 155,000,000,000 marks (nearly \$39,000,000,000), as compared with 180,000,000,000 marks done by the Imperial Bank. The capital stock of the eleven banks of Berlin has increased about five-fold since their foundation, and the combined volume of business, estimated at about 155,000,000,000 marks (allowing 20,000,000,000 for the three banks not reporting), was about 138 times as large as their available working capital. The leading bank is the Deutsche Bank, with a capital stock of 150,000,000 marks. Each of the Berlin banks shows a larger capitalization than that of any national bank in the United States and compares very favorably with the banks of France. An important financial institution is the Prussian Maritime Association (*Seehandlung*), founded by Frederiek the Great in the middle of the eighteenth century. It was the chief financial support of the Prussian Government for more than a century, until the formation of the German Empire, and was intrusted with the investment of the enormous war contribution exacted from France. It is the prototype of the 'credit mobilier' institutions which found such favor during the nineteenth century in France and other countries. Its activity may be seen from the fact that with a capital stock of less than 39,000,000 marks it had assets exceeding 520,000,000 marks.

FINANCES. Prussia has a highly scientific and satisfactory revenue system. Taxation, though somewhat burdensome, is very equitably distributed. Direct taxes bring in nearly 10 per cent. of the revenue from all sources and 71 per cent. of the entire tax revenue. The principal direct tax is the progressive income tax. Persons deriving less than a fixed minimum income are exempt. Another important source of revenue in Prussia is the income obtained from Government domains and industrial enterprises, railways, mines, salt works, mills, etc. The net revenue derived from these sources exceeds 650,000,000 marks. The chief item of expenditure in the Prussian budget is the so-called working expense in connection with Government enterprises. The next item is the contribution to the Imperial funds, which every State is required to make to complete the revenue of the of the Empire. (See GERMANY, paragraph on *Finance*.) Next come the interest on the public debt, which absorbs nearly 10 per cent. of the ordinary expenditure; public instruction and worship, with 6 per cent.; justice; and finance. The other items of expenditure are all below 100,000,000 marks, and the war expenditure is insignificant, about \$30,000 in 1902, all the war expenditure being met directly from Imperial funds. The growth of the Prussian budget in the last quarter of the nineteenth century is shown by the following table (in millions of marks).

The public debt of Prussia has grown to enormous proportions. In 1867 it was 1,323,000,000 marks; in 1881, 1,995,000,000; in 1891, 5,205,

000,000; and in 1901, 6,603,000,000. A great part of the debt, however, has been incurred for productive enterprises, such as railways, mines, and domains, which have furnished their own means of liquidation. The service of the debt, including interest and amortization charges, amounted to nearly 273,000,000 marks in 1901, or about \$68,000,000.

	Revenue	Expenditure	Surplus
1875.....	971.6	812.6	159
1885.....	1,441.5	1,376.4	65.1
1895.....	2,260.6	2,116.9	143.7
1900.....	2,472.3	2,472.3

POPULATION. The population of the Kingdom in 1900 was 34,472,509, distributed among the provinces as follows:

PROVINCES	Area in sq. miles	Population, 1890	Population, 1900
East Prussia.....	14,282	1,958,663	1,996,626
West Prussia.....	9,854	1,433,681	1,563,658
Berlin.....	25	1,578,794	1,888,848
Brandenburg.....	15,381	2,541,783	3,108,554
Pomerania.....	11,628	1,520,889	1,634,832
Posen.....	11,184	1,751,642	1,887,275
Silesia.....	15,568	4,224,458	4,668,857
Saxony.....	9,750	2,580,010	2,832,616
Schleswig-Holstein.....	7,340	1,219,523	1,387,968
Hanover.....	14,869	2,278,361	2,590,939
Westphalia.....	7,803	2,428,661	3,187,777
Hesse-Nassau.....	6,000	1,664,426	1,897,981
Rhine Province.....	10,423	4,710,391	5,759,798
Hohenzollern.....	441	66,085	66,780
Total.....	134,548	29,957,367	34,472,509

The greatest increase of population was in the industrial provinces of Westphalia, the Rhine Province, Brandenburg, and Silesia, where the iron and textile works have multiplied. The effect of industrial development on the growth and distribution of the population may be also seen from the changes in the proportion of urban and rural population. In 1890, 51.5 per cent. lived in villages, and 48.5 per cent. in towns and cities of more than 2000 population. In 1900 the rural population comprised but 44.4 per cent. of the total. Berlin is the capital, ranking third in population among the cities of Europe. The seven largest cities after Berlin, with a population exceeding 200,000, are Breslau, Cologne, Frankfurt, Hanover, Magdeburg, Düsseldorf, and Stettin. See GERMANY, paragraph on *Population*.

For RELIGION, EDUCATION, CHARITIES, see the article GERMANY.

For ARMY and NAVY, see the articles ARMIES and NAVIES.

GOVERNMENT. The present Constitution of Prussia is a written instrument and one of the products of the revolutionary events of 1848. It was promulgated by the King in 1850 and has since been modified by various royal decrees. It prescribes a number of limitations in behalf of individual liberty upon the power of the Government. It may be amended by the King and the Legislature according to the ordinary processes of legislation, except that the resolution for amendment must be twice passed by the Chambers, an interval of three weeks intervening between the two votes.

The executive power is vested in the King, who attains his majority at eighteen, and whose crown is hereditary according to the principle of agnatic

lineal primogenial succession. He is irresponsible and exercises his powers through ministers, who must countersign all his official acts and who thereby assume responsibility for them. Their responsibility, however, is not to the Legislature, but to the King, who appoints and dismisses them without regard to the wishes of the Legislature. They are entitled to seats in either Chamber and may participate actively in the debates, but can vote only in the House in which they have a seat. They do not resign upon an adverse vote, for the parliamentary or cabinet system of government does not exist in Prussia. The number of ministers as well as their duties is regulated by the King. At present there are nine. None of them acts as Prime Minister with authority over the others, although the Minister of Foreign Affairs, as chairman of the Council of Ministers, is called the Minister president. Their responsibility is not collective, and each conducts his own department independently of the others. However, they meet occasionally as a *Staatsministerium* for the consideration of matters of general concern, for the discussion of proposed legislation, for the preparation of ordinances to meet temporary exigencies during the adjournment of the Legislature, etc.

The legislative power is vested in the King and a bicameral legislature (*Landtag*), the two Chambers having substantial equality of powers in legislation. The House of Peers (*Herrenhaus*) consists of three hereditary groups: (1) Adult princes of the royal blood; (2) princes of mediatized houses; (3) territorial nobles, and the following non-hereditary elements: (1) Life peers, appointed by the King from among certain wealthy and distinguished persons; (2) eight noblemen elected by certain Prussian landowners; (3) representatives of the universities, of evangelical bodies, and of certain cities; and (4) an unlimited number of worthies appointed by the King for any term he pleases. The total number of members at present is about 300, of whom about two-thirds are representatives of large land-owning classes. The House of Representatives (*Abgeordnetenhaus*) is composed of 433 members, elected for a term of five years by indirect vote. For the purpose of election the country is divided into districts, in each of which usually one member is chosen by the three-class system. Under this arrangement of each district the voters (all Prussians twenty-five years of age and qualified to vote in the municipal elections) are divided into three classes according to the amount of taxes they pay: the largest taxpayers, who together pay one-third of the taxes, constituting the first class; the next highest taxpayers, who together pay another third, forming the second class; and the remaining taxpayers forming the third class. Each class of voters then chooses an equal number of electors, who then assemble and choose the representative. Thus it is seen that the moneyed class have a most decided advantage. One elector is chosen from about 250 of the population and representatives are distributed on the basis of one for about 75,000 inhabitants. The qualifications for membership in the House of Representatives are the completion of the thirtieth year, the full enjoyment of civil rights, and the payment of all taxes assessed for the three years previous. The Parliament is regularly convoked by the King each year in November and in special session at such

other times as he may choose. It is also opened, prorogued, dissolved, and adjourned by the King, but cannot be adjourned for a longer period than thirty days or more than once during the session. Each House is the judge of the elections and qualifications of its own members and has full power over its organization, procedure, and discipline except that the sessions must be public. The members cannot be questioned outside of their respective Chambers for any speech delivered or vote cast therein, nor be arrested without the consent of the Chamber unless caught in the act of committing a crime or within twenty-four hours thereafter. The members of the House of Representatives receive as compensation about three dollars and a half a day. In legislation the powers of the two Chambers are equal, except that the budget and revenue bills must originate in the House of Representatives and cannot be amended by the Peers.

The organization, jurisdiction, and procedure of the judicial system, as in all the German States, is regulated by the Imperial Judicature Act of 1877. The territorial competence of the courts and the appointment and compensation of the judges, however, is a matter of State regulation. The Prussian Constitution requires that the judges shall be appointed by the King for life, and they can be removed, retired, or transferred to other districts only by resolution of the courts themselves. Their position is one of independence as over against the Administration. They are admitted to the judicial service only after the completion of a prescribed course of study and preparatory service and after passing two State examinations. The highest courts in Prussia are the *Oberlandesgerichte*, of which there are fifteen in number, the one at Berlin being known as the *Kammergericht*. The next lower grade of courts are the *Landesgerichte*, and at the bottom of the judicial hierarchy are the *Amtsgerichte* or magistrates' courts. For the trial of minor criminal offenses the magistrate associates with himself two laymen called *Schöffen*. For the trial of more serious offenses jury courts (*Schwurgerichte*) are constituted in connection with the *Landesgerichte*. They consist of a bench of three judges and twelve jurors, the latter being selected from a list of eligibles prepared before the beginning of each year. The Imperial Court at Leipzig serves as a final court of appeal from the State courts. (For a more detailed account of the judicial system, see GERMANY.) Besides the ordinary courts mentioned above there are a number of special courts (*besondere Gerichte*), which the individual States may or may not establish. Such are the industrial courts, the communal courts, agrarian courts, etc. Moreover, as a result of the so-called separation of justice from administration in Prussia in the early part of the nineteenth century, Prussia has a system of administrative courts charged with the adjudication of administrative controversies. As a result of the legislation of 1875 there are three grades of administrative tribunals, viz. the Superior Administrative Court (*Oberverwaltungsgericht*), the Circle Committee, and the District Committee. The first mentioned is composed of an equal number of judges and trained administrators appointed by the King for life, thus insuring them a position of greater independence than is the case with the judges of the French administrative

courts. This court has its seat at Berlin and is a tribunal of great influence and popularity. To settle conflicts of jurisdiction that arise between the judicial and administrative courts a 'competence conflict' tribunal is provided. This court has its seat at Berlin and consists of eleven members, six of whom are judges of the *Oberlandesgericht*.

The present system of local government in Prussia dates back to the year 1807, but has undergone numerous reforms, culminating in the noted *Kreisordnung* of Professor Gneist, which became law in 1872. As a result of this legislation the sphere of local autonomy was extended, a judicial control over the action of the administrative authorities was provided for, with a view of preventing abuses which had become quite frequent, and a large non-professional service, for the most part compulsory and unpaid, was introduced into the administration with a view of diminishing the influence of the bureaucracy, and at the same time of increasing the political capacity of the people, who were shut out from the civil service on account of its highly professional character and the consequent difficulty of gaining admission thereto. A distinctive principle of Prussian administration is the separation of local activities into two classes: those which are regarded as of general concern, such as the management of schools, police, and religious worship; and those of purely local concern, such as the management of highways, the care of local institutions, etc. For the administration of the first class the State is divided into administrative units, in each of which are to be found central officers under control of the Ministers at Berlin. For purely local administration there are local corporations with their own property and officials. The late reforms have in most cases made the boundaries of the central and local units conterminous and consolidated the central and local authorities in the same area.

For the purpose of administration, Prussia is divided into twelve provinces, not artificial, but historical units. These are subdivided into Government districts (*Regierungsbezirke*), from two to six in each, thirty-five in all. The districts are divided into circles (*Kreise*). Below the circle are the justice of the peace district (*Amtsbezirk*) and the commune (*Gemeinde*). In the province there are two sets of Government officials, one central and the other local. The chief central officer is the *Oberpräsident*, a purely professional official, somewhat like the French prefect, appointed and dismissed by the King and subject to the oversight and direction of the Ministers at Berlin. He exercises supervision over a number of subordinate officials, presides over various boards, and attends to the administration of those affairs which concern the province as a whole, such as relate to the police, religious worship, schools, public health, etc. Associated with the *Oberpräsident* in the administration of matters of central concern in the province is the provincial council (*Provinzialrat*), consisting of the *Oberpräsident* as Chairman, a professional life member appointed by the Minister of the Interior, and of five unsalaried lay members chosen by the Provincial Committee (a popular body) for a term of six years. The council exercises a certain control over the *Oberpräsident*; its consent is necessary to the validity of his ordinances; it hears appeals

from the decisions of certain lower organs, and performs a variety of miscellaneous duties.

The organs for the administration of matters of purely local concern in the province are the Provincial Diet (*Landtag*), the Provincial Committee, and the Director. The Landtag is the legislative assembly of the province and is composed of members elected for a term of six years by the Diets of the rural circles and by the municipal councils of the urban circles within the province. They are distributed among the circles of the province on the basis of population and one-third retire every third year. The Landtag is summoned in regular session by the Crown biennially, and oftener when necessity requires. Its duties relate to the organization and management of provincial institutions, the election of local officers, the voting of appropriations and taxes, and the enactment of by-laws on various subjects. The Provincial Committee is the local executive authority for the province and is composed of from seven to fourteen unsalaried members elected by the Landtag for a term of six years. Its chief duty is the enforcement of the measures of the Landtag, and the chief officer through whom it acts is the director, a salaried ministerial official elected by the Landtag and confirmed by the King. It will be seen from the above description of the provincial administration that a complete separation of the provincial and local functions of administration is observed.

The Government district, unlike the province, exists only for the administration of those affairs which are regarded as being of general concern, and it has, therefore, no organs for the administration of purely local matters. In each of these areas is a board consisting exclusively of professional administrators appointed by the King, collectively known as the government (*Regierung*) and having at its head an officer called the government president (*Regierungspräsident*). This official is in some respects the most important in the Prussian local administration. He may veto or set aside the resolutions of the government (*Regierung*), and is the real head of the local service. The duties of the 'government' fall chiefly within the domain of the Ministries of the Interior, of Agriculture, of Public Works, of Trade and Commerce, of War, and of Education and Worship, to all of whom they are responsible. Another organ of the Government district is the District Committee (*Bezirksausschuss*), composed of the government president, two professional members appointed by the King for life, and four laymen chosen by the Provincial Committee for a term of six years. The chief function of this predominantly lay authority is to exercise control over the action of the professional government president. Its consent is necessary for the validity of his police ordinances; it exercises supervision over subordinate officials, and acts as an administrative court for the district.

As to the circle (*Kreis*), there is found again, as in the province, the distinction between those affairs which are regarded as of general concern and those which are looked upon as of purely local interest. The matter is, however, somewhat simplified by intrusting to one set of organs the administration of both spheres, but when they act as central organs they are subject to strict central control. These are the Landrat, the Circle Committee (*Kreisausschuss*),

and the Circle Diet (*Kreistag*). The Landrat is the chief executive authority of the circle and the agent of the central administration. He corresponds somewhat to the Oberpräsident of the province and the government president of the district. When acting as agent of the central administration he is the subordinate of the latter official, but when acting as a purely local officer he is a subordinate of the Circle Committee. He is a highly trained professional administrator and is appointed by the King. The Circle Committee is composed of the Landrat and six non-professional members elected by the Circle Diet for a term of six years, and acceptance of the office is compulsory. As a central organ it exercises oversight over the justices of the peace; as a local organ it has supervisory authority over other officers of the circle. It is also the administrative court for the circle, and in this capacity hears appeals from the acts of inferior administrative officials. The Circle Diet is the representative assembly of the circle and is composed of members elected for a term of six years, one-half of whom retire every three years. They are distributed equally between the urban circles (cities with over 25,000 population) and the rural circles. The members assigned to the urban circles are elected by their municipal authorities. Those assigned to the rural circles are again divided between the greater landowners and the rural communes. The greater landowners form themselves into electoral colleges for the choice of their members, while the rural communes elect theirs in groups and also through electors. The Circle Diet elects the members of the Provincial Diet, votes the provincial taxes, contracts loans, enacts ordinances for the administration of various local affairs, and has power to create certain offices and establish local institutions.

The justice of the peace district (*Amtsbezirk*) consists of a group of rural communes with a population of about 1500 inhabitants. The justice (*Amtmann* or *Amtsvorsteher*) is appointed by the King upon the nomination of the Circle Diet for a term of six years, and the office is compulsory and unpaid. The duties of the justice include the control of the local police and the administration of the poor and health laws. The office is therefore one of the most important in the system.

As to the communes, there is found a distinction between those which are rural and those which are urban. The larger rural communes act through representative councils chosen by taxpayers, while the less populous manage their affairs through mass meetings of the voters. The chief executive officer in the commune is known as the *Schulze* or *Dorfrichter* and is elected for a term of six years by the communal council or mass meeting. Communal affairs include the regulation of pasturage, tillage, schools, churches, etc.

In the government of the cities of Prussia the deliberative organ is the council, chosen for a term of six years by the taxpayers according to the three-class arrangement already described in connection with the Prussian House of Representatives. Its powers are not specifically enumerated, but comprise the general administration of city affairs. It may, therefore, undertake whatever municipal enterprise it chooses. The chief executive authority in the

city is vested either in a burgomaster or a board elected by the council. The burgomaster is a professional officer, while the board is composed of both professional and lay members, the service of the latter being obligatory and unpaid. Where the board system prevails the burgomaster serves as chairman of the board. He is a high-salaried official with a tenure of at least twelve years, and occupies a position of great influence. In the city we find again the separation of those matters which are of central concern from those of purely local interest, but, as in the circle, the authorities for the administration of both spheres are consolidated. In the large cities, however, the central Government may, if it wishes, vest the control of the police in distinctively central organs, and this it has done quite generally. The executive board acts both as an organ for local administration and as an organ for central administration, and in the latter capacity it is subject to the supervision of the central Government at Berlin. By way of conclusion, it may be remarked that the general characteristics of Prussian local government are: first, the local authorities are for the most part organs of general rather than enumerated powers, but to counteract possible evil results they are subjected to central control; second, the administration is subject to judicial control as a means of protection to the individual; third, a large part of the administrative service is highly professional in character and can be entered only as a result of special study and training and after passing a State examination; fourth, to counteract the possible evils of the bureaucracy, a considerable lay element, whose services are generally obligatory and unpaid, has been introduced into the system.

ETHNOLOGY. The inhabitants of modern Prussia are, for the most part, German-speaking descendants of the old Teutonic tribes, mixed more or less with Celts in the west and southwest and with Slavs in the east. There are two important branches to be recognized which differ in customs and speech, and possibly in descent. These are the Low Germans and the High Germans, occupying, respectively, the low-lying plains to the north and the higher regions to the south.

In addition to the German-speaking population there are a large number of Slavs in the eastern part of the kingdom, a considerable body of Danes in Schleswig, a number of Lithuanians in the northeast, of Frisians in the northwest, and of Dutch in the west, and a few representatives of Celtic peoples (French and Walloons) in the west. Of the Slavs the most important are the Czechs, the Wends, and the Poles. The Czechs are found in Silesia, and the Wends in Brandenburg and Silesia. Akin to the Wends, but speaking a Polish dialect, are the Kassubs, or Kashubs, dwelling in the northwest part of the Province of West Prussia and in Pomerania. These form a small remnant of the old Slavic Pomeranians, who formerly occupied this region, but have been largely absorbed in the surrounding Teutonic element. The Poles, some three millions, form the largest body of Slavs in Prussia. They dwell in Posen, Silesia, and East and West Prussia. Related to the Poles are the Mazurians or Mazurs, who dwell in the southeastern portion of East Prussia, and still preserve their old cus-

oms and habits. The old Prussians, the original inhabitants of Prussia east of the Vistula, who preserved their independence until they were subdued by the Teutonic Knights in the thirteenth century, have died out or been absorbed, and their language is no longer spoken. The Jews number about 400,000, of whom about one-fourth dwell in Berlin.

HISTORY. The origins of Prussian history up to 1411 are sufficiently treated under BRANDENBURG (q.v.). In that year the Emperor Sigismund placed over the Mark of Brandenburg the thrifty Frederick, Burggrave of Nuremberg, who was invested four years later with the hereditary sovereignty of the mark and the accompanying dignities of margrave, prince elector, and Imperial arch-treasurer. This Frederick was the head of the House of Hohenzollern (q.v.) and with him began its steady rise to power. He was a capable administrator and brought order out of the existing chaos. The work was continued by his son, Frederick II. (1440-70). Frederick was succeeded by his brother, Albert Achilles (1470-86), who fell not at all behind his father and brother in ability. In the *Dispositio Achilica* of 1473 he ordained that the Franconian margraviates (Bayreuth and Ansbach) should be separated from Brandenburg. There now began those family arrangements by which lesser territories, reserved for younger sons or acquired by marriage, were to revert to the elder line in default of other heirs. John Cicero (1486-99) and Joachim I. Nestor (1499-1535) followed, without especially distinguishing themselves, but maintaining the gains of their house. The son of the latter, Joachim II. Hector (1535-71), adopted the reformed religion in 1539, thus bringing himself into sympathy with his people, who in common with all of North Germany were embracing Protestantism. He and his successors, John George (1571-98) and Joachim Frederick (1598-1608), were, however, too cautious to involve Brandenburg in the Reformation struggles. The important event in the reign of John Sigismund (1608-19) was the reversion of the Duchy of Prussia (the region about Königsberg) to the electoral branch in 1618.

In the early part of the thirteenth century, when hope of further achievements in Syria had declined, the crusading order of the Teutonic Knights (q.v.) turned to the task of conquering and Christianizing by the sword the heathen of the countries on the southern and eastern shores of the Baltic. Remorselessly but with tremendous energy they spread their conquests over Prussia, Pomerania, Courland, Livonia, and Estonia, establishing towns, colonizing, and enforcing conversion upon the conquered inhabitants. The Prussians (Borussians), a people closely akin to the Lithuanians, who inhabited the Baltic region between the Vistula and the Niemen (Memel), offered a fierce resistance, and their subjugation was not completed until after a long struggle in 1283. The Prussian nationality was gradually swallowed up in the tide of German colonization, and by the seventeenth century the Old Prussian language was extinct. Power and wealth brought a decline in the vigor of the Teutonic Order and Poland after its union with Lithuania in the fourteenth century (see POLAND) turned its strength against the Knights, against whom war was

waged until in 1466 the Peace of Thorn destroyed the independent sovereignty which the Order had erected. Western Prussia was annexed to the Polish kingdom and Eastern Prussia, much reduced, was retained by the Teutonic Knights as a fief of Poland. In 1511 Albert of the Ansbach branch of the Hohenzollern was elected grand master of the Teutonic Order under a pledge to refuse to do homage to Poland. Finding this impracticable and failing to find support from the members of the Order who were residing elsewhere, he regarded himself as absolved from his pledge, and with most of the Prussian members became Protestant, secularized the State over which he ruled, and received it from Poland as hereditary Duke of Prussia (1525). By agreement with the elder line, upon the failure of heirs in the line of Duke Albert the Duchy of Prussia in 1618 was added to the domains of the Brandenburg Hohenzollern. In the reign of John Sigismund also the beginnings were made of the dominion of Brandenburg in the region of the Rhine. In 1609 the ducal line of Jülich and Cleves became extinct, and in the succession contest which ensued Brandenburg was one of the claimants. In 1666 Cleves, Mark, and Ravensberg were definitively assigned to her.

During the Thirty Years' War (q.v.) Brandenburg was wasted by the contending armies, although the Elector George William (1619-40) temporized with both sides in a vain endeavor to follow the peaceable and thrifty policy of his predecessors. It was, therefore, a devastated and impoverished country to the sovereignty of which Frederick William I., "the Great Elector" (1640-88), succeeded. He was the first of the three creators of the greatness of modern Prussia. He saw the necessity of making Brandenburg a military State, because of its central and exposed position. He brought a small army into existence, was able to command a hearing in the Westphalian peace negotiations, and secured for Brandenburg by his shrewd diplomacy Farther Pomerania (the line of Slavic dukes of Pomerania having become extinct in 1637), the sees of Halberstadt, Minden, and Kammin, and the succession to the See of Magdeburg (1648). In 1656 he joined Charles Gustavus of Sweden in his onslaught upon Poland, but in 1657, with his customary shrewd regard for the interests of his house, he changed sides, and for his espousal of the Polish cause he obtained from Poland in the Treaty of Wehlau, in the same year, a renunciation of her suzerainty over the Duchy of Prussia. In 1675, when the Swedes invaded Brandenburg while Frederick William was campaigning against France on the Rhine, he returned, totally defeated them at Fehrbellin, and drove them out of Pomerania. Although Swedish Pomerania had to be given up in 1679, a new power had demonstrated its claim to be heard in the affairs of the Baltic. When Louis XIV. revoked the Edict of Nantes (q.v.), Frederick William replied by the Potsdam Decree, which made Brandenburg the hospitable asylum for persecuted Protestants and drew to it thousands of French Huguenots, who made most useful citizens. The Great Elector thus prepared the way, during his long reign, for the next great step in the development of his State under his son, Frederick III. (1688-1713). The Margraviate of Brandenburg was a vassal State of the Holy Roman Empire; the Duchy of Prussia had been

made an independent sovereignty, but its sovereignty, as a duke, occupied an inferior rank. When the Emperor, Leopold I., entered upon the struggle of the Spanish Succession he was anxious to secure the support of the German princes, and he consented, against the advice of some of his shrewdest counselors, to allow his vassal, the Elector of Brandenburg, to erect ducal Prussia, which was outside the Empire, into a kingdom (November 16, 1700). Frederick III. of Brandenburg placed the royal crown upon his head at Königsberg on January 18, 1701, and thus became King Frederick I. of Prussia. As such he was placed on a level with the other independent sovereigns of Europe, and from this time Brandenburg-Prussia had to be reckoned with as a European power.

The reign of Frederick I., aside from this most important achievement, was uneventful. At his death in 1713 he was succeeded by his son, Frederick William I. (1713-40), an eccentric monarch, who practiced the closest economies in administration, established the Prussian bureaucracy on a sound basis, and continued the military development of the country, raising the army to an effective strength of more than 80,000 men, the best disciplined troops in Europe. By the Treaty of Stockholm (1720) he acquired a great part of Swedish Pomerania, including Stettin. He fought no wars and turned over to his son, Frederick II., "the Great" (1740-86), an efficient military machine and a well-filled treasury. Hitherto the House of Hohenzollern had been steadily loyal to that of Austria. The inevitable rivalry of Prussia and Austria for supremacy in the Germanic body had not made itself apparent. Frederick William saw it just before his death. Frederick clearly understood it, and thereafter it formed the keynote of Prussian policy. Immediately after his accession Frederick made war upon Austria for the possession of Silesia and secured most of that extensive province. The first twenty-three years of his reign were occupied in a great measure by wars in which the well-husbanded resources of the country were taxed to the utmost. (See SUCCESSION WARS; SEVEN YEARS' WAR.) The second period was devoted to the restoration of the country, the establishment of its prosperity on a permanent basis by the cultivation of its material resources, and the thorough organization of its government in all departments. The government was a despotism, although a benevolent one, in accordance with the prevailing ideas of the eighteenth century. The rise of Prussia to the rank of a first-rate power, representing as she did the Germanic spirit, stimulated German thought and patriotism, and prepared the way for the new Germany. By the first partition of Poland the greater part of West Prussia was added to the kingdom, thereby filling the gap between Brandenburg and East Prussia. Frederick's nephew and successor, Frederick William II. (1786-97), took up arms against revolutionary France, and in the Treaty of Basel (1795) had to give up the Prussian territories west of the Rhine. He shared in the second and third partitions of Poland in 1793 and 1795. See POLAND.

Under Frederick William III. (1797-1840) Prussia passed through a period of humiliation and then of reorganization. Napoleon (q.v.) saw in the independent Germanic kingdom a menace to his plans and aimed to crush out its national

life. The attempt of the King to play the old Brandenburg part of a neutral when no power in Europe could be neutral only made the misfortunes of the country greater. In 1806, after the campaign of Jena, Prussia found herself prostrate at the feet of Napoleon. The Treaty of Tilsit (July, 1807) tore away about half of the kingdom—the territories west of the Elbe and the Polish territories acquired in 1793 and 1795. In this crisis the government, organized in a form fast becoming antiquated, had lost its efficiency and degenerated into a helpless bureaucracy under a vacillating king. Then came a great national awakening. Stein, Hardenberg, and Scharnhorst (q.v.) came into the government as ministers and completely reorganized the administration, civil and military, changing Prussia from a mere military monarchy to an armed and organized nation under a monarchical government. In 1809 the last remnants of serfdom, which had been in process of abolition since 1717, were done away with. Fichte began his patriotic propaganda. In 1813, allied with Russia and Austria, Prussia entered upon the War of Liberation, and she was able to take an active and effective part in the campaigns that brought about Napoleon's downfall. In 1815 the Congress of Vienna allowed Prussia (reinstated in most of her old German possessions) only the Province of Posen and the city of Danzig of her share of the second and third partitions of Poland, but in recompense awarded what was of much more value to her as a German State—large territories on the Rhine, half of Saxony, and what was left of Swedish Pomerania. From this time the history of Prussia and that of Germany are inseparable. It became the aim of Prussian statesmanship to unite Germany under Prussian leadership and oust Austria from her presidency of the new confederation. The Zollverein (q.v.), including all Germany except Austria, was a step in this direction; but the inherent jealousies of the German States prevented any further advance.

The years from 1840 to 1861, covering the reign of Frederick William IV. (q.v.), formed a critical period for Prussia. All Europe was stirring with the liberal and constitutional agitation which culminated in the revolutions of 1848. The King of Prussia possessed cultivated tastes, but he proved to be a bigoted adherent of the old order of caste and privilege. He granted a legislative assembly in 1847, but the basis of representation was provincial, not popular. The revolutionary movement was severely felt in Prussia, especially in the great student centres. In Berlin serious rioting culminated in a pitched battle between the populace and the troops on March 18-19, 1848, in the course of which more than 200 men fell in the defense of the barricades. The King yielded, consented to the formation of a national guard, and summoned a Liberal Ministry. On May 22d a constituent convention assembled in Berlin, but its character was so radical that the King, taking advantage of the reaction which had already set in at Vienna, transferred the convention from Berlin to Brandenburg, and on December 5th pronounced its dissolution, publishing at the same time a constitution, based on democratic principles. The old system of different estates was abandoned and a united bicameral

legislature established. In April, 1849, the King refused the Imperial crown offered him by the Frankfort Parliament, on the ground that it did not proceed from the action of the German princes. (See GERMANY.) Frederick William IV. thus destroyed the opportunity of bringing Prussia to the forefront in German affairs. In 1850 he showed, by convoking the Erfurt Parliament to consider anew plans for German unity, that his refusal was but half-hearted. At this time, however, Austria was in a better condition for action, and Schwarzenberg promptly brought about the dissolution of the Erfurt gathering. Prussia was on the verge of war with Austria over the situation in Hesse, when the timidity and vacillation of the Prussian Government again led to a drawing back, and at Olmütz (November 28-29, 1850) Count Manteuffel met Prince Schwarzenberg, acceded to all of Austria's demands, and for the time being destroyed the prestige which Prussia had enjoyed since the days of Frederick the Great. This vacillation ceased when the Crown Prince William became Regent in 1858. Upon the latter's accession to the throne in 1861 Bismarck was called into his councils and speedily became the dominant personality in the German world. He rejected altogether the temporizing and timid policy of his predecessors and made it evident that the regeneration of Germany must be accomplished through Prussian agency and by a policy of force. In 1864 Prussia and Austria engaged in a joint war with Denmark, which resulted in the liberation of Schleswig-Holstein from Danish rule. The differences between the rival powers relative to the disposition to be made of the duchies gave Bismarck his opportunity to force a war with Austria. (See GERMANY; SCHLESWIG-HOLSTEIN; AUSTRIA-HUNGARY.) The Seven Weeks' War (q.v.) followed, in which Prussia had an ally in Italy. By it Austria was forced out of the Germanic body, and Hanover, Hesse-Cassel, Nassau, and Frankfurt were annexed to Prussia, with which Schleswig and Holstein were at the same time incorporated. The North German Confederation was formed under Prussian leadership.

It now remained to bring the States of South Germany into the union. This result was brought about with the same certainty of action that had produced the struggle with Austria. The Franco-German War and the establishment of the German Empire followed. For this series of events, and the history of Prussia to the present time. See GERMANY; BISMARCK; WILLIAM I.; FREDERICK III.; WILLIAM II.; KULTURKAMPF; SOCIALISM; POLITICAL PARTIES (section on Germany, etc.

BIBLIOGRAPHY. Toppen, *Historisch-komparative Geographic von Preussen* (Gotha, 1858); Engel, *Land und Leute des preussischen Staates* (Berlin, 1863); Hillebrand, *La Prusse contemporaine et ses institutions* (Paris, 1867); Müller-Köpen, *Die Höhenbestimmungen der königlich preussischen Landesaufnahme* (Berlin, 1875-85); Weber, *Preussen vor 500 Jahren in kulturhistorischer, statistischer und militärischer Beziehung nebst Special-Geographie* (Danzig, 1878); Von Ronne, *Das Staatsrecht der preussischen Monarchie* (4th ed., Leipzig, 1881-84); Schulze-Gävernitz, *Das preussische Staatsrecht auf Grundlage des deutschen Staatsrechts* (Leipzig, 1888-90); Whitman, *Imperial Germany* (London, 1889); Grotefend, *Lehrbuch des preussischen*

Verwaltungsrechts (Leipzig, 1890-92); Neumann, *Geographie, Ortslexikon des Deutschen Reichs* (Leipzig, 1894); Pollard, *A Study of Municipal Government* (London, 1894); Goltz, *Die ländlichen Arbeiter und der preussische Staat* (Jena, 1893); Meyer, *Lehrbuch des deutschen Staatsrechts* (Leipzig, 1895); Lair, *L'impérialisme allemand* (Paris, 1902); Huber, *Deutschland als Industriestaat* (Stuttgart, 1900); Hue de Grais, *Der preussische Staat* (Berlin, 1903); *Preussische Jahrbücher* (Berlin, annually). For history, consult: Tuttle, *History of Prussia* (4 vols., Boston, 1884-96), a work of the highest scholarship, which the death of the author brought to a close with the year 1757; Ranke, *Memoirs of the House of Brandenburg and History of Prussia During the Seventeenth and Eighteenth Centuries* (trans., Gordon, 3 vols., London, 1849); Stenzel, *Geschichte des preussischen Staates* (5 vols., Gotha, 1831-54), to 1763, a standard work, with its continuation, Riemann, *Neuere Geschichte des preussischen Staates vom Hubertsburger Frieden bis zum Wiener Congress* (Gotha, 1882); Ebert, *Geschichte des preussischen Staates* (7 vols., Breslau, 1873), another work of standard value, coming up to 1871; Pierson, *Preussische Geschichte* (2 vols., Berlin, 1881), able, strongly pro-Prussian; Heimel, *Geschichte Preussens* (Königsberg, 1876). Droysen, *Geschichte der preussischen Politik* (Berlin, 1876), is a monumental work by one of Germany's foremost historians, but strongly partisan and only practicable for specialists, to whom its merits and defects will be sufficiently familiar. For a detailed bibliography, see Dahlmann-Waitz, *Quellenkunde der deutschen Geschichte* (6th ed., revised by Steindorff, Göttingen, 1894).

PRUSSIA, EAST. The northeasternmost province of Prussia, bounded by the Baltic Sea on the northwest, Russian Poland on the east and south, and the Province of West Prussia on the west (Map: Prussia, K 1). Area, excluding the Frisches and Kurisches Haff, 14,282 square miles. It forms a part of the southern coast plateau of the Baltic Sea, and its surface, largely flat, is interspersed with marshy tracts in the northeast and south, and with dunes along the coast. The southern part is remarkable for its numerous lakes, of which the largest are the Mauer, Spirding, and Löwentin. The chief rivers of the province are the Niemen (here called the Memel), the Pregel, and the Passarge. The larger rivers are navigable, and many of the lakes are connected by canals. The climate is raw. Agriculture is the principal occupation, and rye, oats, barley, wheat, and potatoes are grown. Stock-raising is very important, and the horses of East Prussia are among the best in Germany, horse-breeding being furthered by several large studs.

The forests belong mostly to the State, and are exploited extensively. The manufacturing industries are as yet slightly developed, and most of them are in connection with agriculture, such as brewing, distilling, and the manufacture of beet sugar. Iron is produced in limited quantities, and the manufacturing of textiles is carried on as a house industry. The transportation facilities of the province are very good, there being, besides the extensive system of natural and artificial waterways, 1,375 miles of railway, chiefly State lines. For administrative purposes

East Prussia is divided into the two districts of Königsberg and Gumbinnen, with Königsberg as the capital. The province is represented by 36 members in the Lower House and 24 in the Upper House of the Prussian Landtag, and returns 17 Deputies to the Reichstag. In 1900 the population was 1,996,626 (2,006,689 in 1895), including 1,698,465 Protestants. For history, see PRUSSIA.

PRUSSIA, WEST. A province of Prussia, bounded by the Baltic on the north, East Prussia on the east, Russian Poland and the Province of Posen on the south, and the provinces of Brandenburg and Pomerania on the west (Map: Prussia, J 1). Area, over 9800 square miles. The surface is mostly flat, and in some parts lies below the level of the sea. It is traversed from west to east by a range of hills which reaches its greatest height in the Turmberg, 1080 feet. The chief indentation on the coast is the Gulf of Danziger, which is separated from the sea by the long spit known as Hela Peninsula. The southwestern part of the Frisches Haff also belongs to West Prussia. The province is watered principally by the Vistula and its tributaries, and contains many small lakes. The climate is somewhat raw in the lower parts. Agriculture is the principal industry, and rye, potatoes, and oats are the chief products. Sugar beets and tobacco are produced on a very large scale, and stock-raising is also well developed, the province being noted for its fine horses. The manufacturing industries are as yet unimportant, and are confined entirely to the cities. The principal industries are ship-building, notably at Danzig and Elbing, and lumber manufacturing in many of the cities along the Vistula. Linen and other textiles are produced in the rural districts. The chief article of commerce is lumber, which is imported extensively from Russia to Thorn and Danzig. For purposes of administration the province is divided into the two districts of Danzig and Marienwerder, with Danzig as the capital. It is represented by 22 members in the Lower House and 13 in the Upper House of the Prussian Landtag, and returns 13 members to the Reichstag. The population of the province was 1,433,681 in 1890 and 1,563,459 in 1900. In 1895 the Roman Catholics numbered 758,168 and the Protestants 702,030.

PRUSSIC ACID. See HYDROCYANIC ACID.

PRUTH, прѹт. An important tributary of the lower course of the Danube. It rises in the Carpathian Mountains, on the boundary of Galicia and Hungary, flows through the southeastern part of Galicia, and then forms the boundary line between Bessarabia (Russia) and Rumania, joining the Danube near Galatz (Map: Balkan Peninsula, G 2). Its total length is over 500 miles. Its course is very swift and the river is used principally for floating timber, although it is navigable from Jassy downward for about 170 miles. In 1711 the army of Peter the Great was hemmed in on the bank of the Pruth, near Husi, by the Turks. They finally allowed the Czar to withdraw upon his consenting to give up Azov.

PRUTZ, прѹтс, HANS (1843-). A German historian, born at Jena, son of the following. He studied in Jena and in Berlin, where he established himself as Privat-docent in 1873. The results of an expedition into Syria, undertaken by order of the Government, in 1874, were embodied

in the work *Aus Phönicien* (1876). In 1877 he became professor at the University of Königsberg, and after having resigned his chair, owing to a disease of the eye, settled in Munich in 1902. His principal works include: *Heinrich der Löwe* (1865); *Kaiser Friedrich I.* (1871-74); *Kulturgeschichte der Kreuzzüge* (1883); *Staatengeschichte des Abendlandes im Mittelalter* (1885-87); *Entwicklung und Untergang des Tempelherren-Ordens* (1888); *Aus des grossen Kurfürsten letzten Jahren* (1897); and *Preussische Geschichte* (1899-1902), in which he placed himself in opposition to the delineation of Prussian history as inspired by patriotic tendencies.

PRUTZ, ROBERT (1816-72). A German poet and historian of literature. He was born at Stettin, and studied philology, philosophy, and history in Berlin, Breslau, and Halle. Prutz boldly advocated liberal ideas in science, religion, and politics, and incurred the dislike of the Government in consequence. In 1849, however, mainly as a result of the popularity of his free lectures, he was appointed professor of literature at the University of Halle, and soon had a large following of liberal-minded students, but was so harassed by the Government that he resigned in 1859, and retired to his native place, where he devoted himself entirely to literary pursuits. Besides several volumes of poems, notably *Aus der Heimat* (1858), *Aus goldenen Tagen* (1861), *Herbstrosen* (1865), *Stimmen der Liebe* (1868), he wrote a sparkling comedy, *Die politische Wochenstube* (1843), several dramas, and the novels *Das Engelen* (1851), *Der Musikantenturm* (1855), *Oberndorf* (1862), and others. His writings on literary subjects, which are more important, include: *Der Göttinger Dichterbund* (1841); *Geschichte des deutschen Theaters* (1847); *Geschichte des deutschen Journalismus* (1845); *Die deutsche Litteratur der Gegenwart* (1860) *Ludwig Holberg, sein Leben und seine Schriften* (1853); translations of Holberg's selected comedies (1868); and *Menschen und Bücher, biographische Beiträge zur deutschen Litteratur und Sittengeschichte des 18. Jahrhunderts* (1862). Consult Gottschall, in *Unsere Zeit* (Leipzig, 1872).

PRYDZ, PRUTS, ALVILDE (1850—). A Norwegian novelist. She was born near Frederikshald, in Southern Norway. In 1880 she gained some attention by the story *Agnar og Agnar* (1880). After the publication of *I Moll* (1885) she received a Government stipend and traveled in Denmark, Germany, Switzerland, and Italy. Mention should be made of *Undervejs* (1889); *Arnak* (1892); *Dröm* (1893); *Bellis* (1895); *Guvor Thorsdatter til Haero*, translated into German in 1897 (1895); *Sylvia* (1898); and sketches of travel in the form of fiction, *Blade* (1898).

PRYNNE, HESTER. The heroine of Hawthorne's *Scarlet Letter*, condemned for her sin to wear on her breast the badge which gives the title to the romance.

PRYNNE, WILLIAM (1600-69). An English political polemist and annalist. He was born near Bath, where he received his early education, afterwards proceeding to Oriel College, Oxford, where he took his bachelor's degree in 1621. He early became involved in ecclesiastical controversy, and speedily made himself heard as a champion of the Puritan party in various

pamphlets directed against Arminianism. In 1632 appeared his *Histrionastix, or a Scourge for Stageplayers*, an attack on the popular amusements of the period, which contained presumably veiled attacks on the King and Queen. He was imprisoned in the Tower, underwent prosecution in the Star Chamber, was sentenced to a fine of £5000, degradation from his degrees, and expulsion from Oxford and Lincoln's Inn, the loss of both his ears in the pillory, and to have his book burnt in public by the hangman. He was also condemned to perpetual imprisonment, and was reimprisoned in the Tower. Three years after, he found means to publish from his prison another pamphlet, in which he fiercely attacked the hierarchy, and was unsparing in his abuse of Laud and other bishops. For this he was again prosecuted, another fine of £5000 was imposed, he was again pilloried, losing such stumps of ears as the executioner had before spared, and was branded on both cheeks with the letters S.L.—seditious libeler—which he ingeniously interpreted as 'stigmata Laudis.'

He remained a close prisoner till in 1640—the Long Parliament then sitting—he was released by a warrant of the House of Commons, and was received in London with loud expressions of popular sympathy. Shortly afterwards he went to Parliament as member for Newport, Cornwall, and in 1647 was elected recorder of Bath. For some years he was actively and at times prominently engaged on the popular side in the proceedings of the House of Commons. In the extreme measures, however, leading to the deposition and death of the King, he declined all share; and being one of those whom Cromwell shortly after expelled from the House of Commons, he proceeded to assail him in print with an asperity equal to that with which he had before made war upon the bishops, in return being again subjected to several years' imprisonment. On Cromwell's death he returned to his place in Parliament, zealously interesting himself in the royal cause; after the Restoration, the office was bestowed on him of keeper of the records in the Tower, in the words of Charles II., "to keep busy Mr. Prynne quiet." His passion for pamphleteering, however, again involved him in difficulties with the House of Commons, from which, on a charge of seditious libel, he escaped expulsion only by confession of error and recantation. Henceforth he busied himself chiefly as a compiler of matter illustrative of constitutional and Parliamentary history. Of his works, which comprise nearly two hundred volumes, the most valuable are the *Calendar of Parliamentary Writs*, and his *Records*. He died at Lincoln's Inn, October 24, 1669.

PRYOR, PRY'OR, ROGER ATKINSON (1828—). An American journalist and lawyer. He was born near Petersburg, in Dinwiddie County, Va., graduated at Hampden-Sidney College in 1845, and at the University of Virginia in 1848, and studied law. He became editor of the *Southside Democrat* at Petersburg, and in 1854 he was called to Washington to edit the *Washington Union*, the principal organ of the Pierce Administration in the capital. In 1855 he was sent to Greece on a special diplomatic mission, and in 1856 he became editor of *The Richmond Enquirer*, one of the most influential papers in the South. In 1857 he established at Richmond

a paper called *The South*, in which his advocacy of extreme States-rights views brought him into national prominence. In 1858 he was elected to Congress, and was reelected in 1860, and brought upon himself considerable ridicule by challenging to a duel John F. Potter, a Republican Congressman from Wisconsin, and then refusing to meet him when Potter proposed that the duel be fought with bowie knives in a dark room. When Virginia seceded, he returned South, where he was elected to the Provisional Confederate Congress and the first regular Confederate Congress. Appointed colonel of a Virginia regiment, he participated in the campaigns about Richmond, distinguished himself in the battles of Williamsburg and Sharpsburg, and was brevetted brigadier-general, but resigned his commission in 1863 as a result of a quarrel with President Davis. He soon enlisted again as a private in Fitzhugh Lee's cavalry, and was captured and confined for some months in Fort Lafayette. Returning South on parole, he advised the South to submit. After the war he settled in New York, where he engaged in newspaper work, and studied law. Admitted to the bar, he rose rapidly to a prominent place in his profession, and in 1890 he was appointed by Governor Hill a judge of the Court of Common Pleas, in 1891 was elected to the same office for a fourteen-year term, and under the provisions of the new Constitution of 1894 was transferred as a justice to the reorganized Supreme Court. He retired from the bench on account of age in 1899.

PRYTANEUM (Lat., from Gk. *πρυτανείον*, *prytaneion*, from *πρύτανις*, *prytanis*, Lesbian *πρότανις*, *protanis*, presiding officer, from *πρό*, *pro*, before). A public building in various Greek cities, especially one in ancient Athens, where the State extended the rites of hospitality to foreigners and citizens of distinction.

PRZEMYSŁ, pshĕ'mĭzl. A fortified town in the Crownland of Galicia, Austria, situated on the San, 54 miles west of Lemberg (Map: Austria, H 2). It is the seat of a Roman Catholic and a Greek Orthodox bishop, and has a number of old churches and monasteries, a higher gymnasium, a seminary for teachers, etc. Its manufactures include machinery, spodium, liqueurs, floor, and naphtha. There is a considerable trade in wood, grain, leather, and linen. Population, in 1890, 35,209; in 1900, 46,349 including 8514 military.

PRZHEVALSKI, przhá-vál'y'ské, NIKOLAI MIKHAILOVITCH (1839-88). A Russian explorer, born of Polish parents at Kimbrovo, in the Government of Smolensk. He was educated at the Gymnasium of Smolensk, entered the military academy at Saint Petersburg, and from 1864 to 1866 lectured on history and geography in the Warsaw Cadet School. In 1867 he volunteered for service in Eastern Siberia, where he explored and botanized for two years in the valley of the Ussuri, publishing his *Notes on the Ussuri* on his return to Saint Petersburg. This book gave much valuable information on Northern Manchuria, and the Russian Geographical Society awarded him a medal for a paper written on the native population of that region. In 1870 he started on his first expedition to Central Asia, and traveled for three years in the west-central part of the Chinese Empire. The results of his explorations were published in

his *Travels in Mongolia*, which is the standard work on that part of the Empire. In 1876-77 he rediscovered the Lob-nor and traced the course of the great river Tarim, which enters that lake after draining the whole of Chinese Turkestan. He also reached the Altyn-Tagh range, which forms one of the northern barriers of Tibet. This great journey is recorded in his book *From Kulja Across the Tian-Shan to Lob-nor*. In his third expedition (1879-1880) he explored the sources of the Hoang-ho and a part of Eastern Tibet, and attempted to reach Lhasa from the north, but was unable to proceed farther than the region of the Kuku-nor, where he was deserted by his guide and suffered terrible hardships. His fourth journey (1883-85) extended from Kiakhta to the sources of the Hoang-ho, including the exploration of Northern Tibet. He crossed the Gobi waste, discovered the water parting between the upper courses of the Hoang and Yangtse rivers, and found the wild camel. Another attempt on this journey to reach Lhasa was unsuccessful. He was preparing for another journey into Tibet when he died of typhoid fever on the shores of Lake Issik-kul, at the town of Karakol, which, in 1893, was renamed Przhevalsk in his honor. He received the highest medals of the leading geographical and many other scientific societies, was pensioned by his Government, and was promoted to the rank of major-general. The Russian Imperial Academy of Science struck a special medal in his honor as the first explorer of the natural features of Central Asia.

PSALMANAZAR, sál'má-ná'zĕr, GEORGE (1679-1763). A celebrated impostor, born probably in Languedoc. He received a good education from the Jesuits, but was idle and pleasure-loving, spent his youth in wandering over a great part of Europe, as pilgrim, beggar, soldier, tutor, and servant, living for the most time in great want. At the age of twenty or thereabouts he began to masquerade as a Japanese convert from Formosa, assumed the name of Psalmanazar, was brought to England, and introduced to the Bishop of London by a certain Innes, chaplain of a regiment, whom he had met at Sluis. The Anglican Church rejoiced in the rescued heathen and sent him to Oxford to pursue his studies. Psalmanazar published a fabulous geography of Formosa, as well as a Formosan grammar and dialect specially invented by himself, and also an account of the Formosan religion and customs. About 1710, however, he seems to have repented of his continued fraud, confessed his guilt, and become truly religious. By acting as editor and compiler he made a comfortable living, and retained the esteem which he had gained under false pretenses. In 1764 appeared his memoirs under the title *Memoirs of * * ** *Commonly Known by the Name of George Psalmanazar*. These give no hint of his real name or birthplace.

PSALMODY (ML. *psalmodia*, from Gk. *ψαλμοδία*, a singing of psalms, from *ψαλμός*, *psalmos*, psalm, hymn, song, from *ψάλλειν*, *psallein*, to play on a stringed instrument + *ᾄδειν*, *adein*, *ældein*, *acidein*, to sing). In its widest sense, the singing of the Psalms of the Bible or other sacred songs in worship; often restricted, however, to the singing of metrical versions of the Psalms to short, simple airs. See HYMNOLOGY; HYMN-TUNES; WORSHIP.

PSALM OF LIFE, A. A well-known short poem by Henry W. Longfellow, published in the *Knickerbocker Magazine*, October, 1838.

PSALMS (from Gk. ψαλμός, *psalmos*, psalm, hymn, song), Book of. According to the Jewish canon, the first book of the third division of the Old Testament, known as *Kethûbim* or *Hajjio-grapha*; in the Christian canon the second book of the section. The arrangement of the latter was adopted from the Septuagint, which placed the books of Job, Psalms, and Proverbs in what was supposed to be the chronological order of their composition, under the influence of the tradition ascribing the first to Moses, the second to David, and the third to Solomon. The Hebrew title of the book is *Têhillim*, 'songs of praise;' the English psalms is from the Septuagint rendering of *Têhillim*, ψαλμοί. The Book of Psalms is properly a collection of hymns which became a manual of the temple service at Jerusalem in the post-exilic period. The collection consists of 150 compositions, divided in the Hebrew Bible like the Pentateuch into five books: (1) Psalms i.-xli.; (2) xlii.-lxxii.; (3) lxxiii.-lxxxix.; (4) xc.-cvi.; (5) cvii.-cl. The date of the final compilation, which, it must be borne in mind, is independent of the question of composition, is now brought down close to the beginning of the Christian Era; but long ere this time there existed collections of psalms, and abundant remains of such collections are found in the book which has been preserved to our time.

In reality, however, a threefold division, (1) i.-xli., (2) xlii.-lxxxix., (3) xc.-cl., would be more rational. Of these divisions, again, it is only the first, in which all psalms except the first two are ascribed to David (excluding the tenth, which is a continuation of the ninth, and the thirty-third, which the Septuagint ascribes also to David), that may be said to constitute a uniform group. The second division has as a distinguishing mark the use of Elohîm as the name of God instead of Yahweh in the main part of the division (xlii.-lxxxiii.). Taking up these Elohîm psalms, it is to be observed that they consist of (a) psalms ascribed to David, and (b) psalms ascribed to Levitical circles, viz. to Asaph or to sons of Korah. The Davidic psalms are li.-lxxi., placed between a single Asaphite psalm (l.) and the main Asaphite collection (lxxiii.-lxxxii.), while the Korahite collection is represented by xlii.-xlix. Lastly, lxxxiv.-lxxxix. appear to be an appendix of a miscellaneous character, attached to the division. The third division includes Books IV. and V., which have so many features in common as to give evidence of having once formed a single collection.

Of the three divisions, the first appears to be the oldest, and in the gradual formation of the Psalter, we may distinguish the following steps: (1) a Davidic collection, Book I.; (2) a second Davidic collection, li.-lxxii. (lxxii. being an addition); (3) a two-fold Levitical collection, (a) xlii.-xlix., (b) l., lxxiii.-lxxxiii.; (4) a combination of the second Davidic with the Levitical collections; (5) a supplement to this collection, lxxxiv.-lxxxix.; (6) a third collection, xc.-cl. The last step consisted in the combination of the three collections, to which the anonymous Psalms i. and ii. were prefixed; a division into five sections was then made in imitation of the

'Books of Moses,' each section provided with a doxology at the close. The purpose of the various collections is evident—to bring together religious hymns; the ascription of groups to members of the Levitical guilds may be regarded as sufficient evidence that the collections were to be used in the ritual. But while this may be admitted, it does not follow that all of the hymns included in the collections were composed for the temple ritual, nor do the considerations above set forth touch the core of the problem as to the date of composition of the hymns themselves.

The natural starting point for the investigation of this problem is the headings in the traditional Hebrew text and in the Greek translation. Although we are obliged to pass beyond the data furnished by these headings, they cannot be altogether set aside, even though their late origin admits no doubt. These headings appear to ascribe the authorship of 73 psalms to David; 49 are anonymous; and the remainder are divided among a variety of authors as follows: two are associated with Solomon, one with Moses, eleven with the sons of Korah, twelve with Asaph, one is attributed to Heman, one to Ethan. But the Hebrew preposition which is translated 'to' is an ambiguous particle, and it by no means follows that the expression a 'Psalm to David' means necessarily a psalm composed by David. It may mean that, but the same preposition would be used to convey the idea that the psalm was a 'Davidic' composition, that is to say, belonging to a class of compositions called for one reason or another after David. In such an instance as the psalms of 'the sons of Korah,' it is quite evident that the preposition 'to' cannot indicate authorship, since it is highly improbable that an entire family or guild should have composed any particular hymn. The same conclusion follows from the occurrence of several names at the head of a psalm, as e.g. xxxix. and lxii., which have the names David and Jeduthun attached, or cxxvii., which in the Septuagint bears the heading David and Jeremiah; or cxxviii., which has three names, David, Haggai, and Zechariah, attached to it in the Septuagint text. The assumption, therefore, is justified that when the headings were first attached to the psalms, it was not done exclusively with the purpose of indicating authorship, but also to specify the character of the collection to which they belong, and indeed this may very well have been the original meaning of the preposition in this connection. To be sure, only in the case of the series of psalms bearing the name 'sons of Korah' can we be certain that we actually have a collection by several authors, but it is plausible to assume that there was also a 'Davidic' collection designating not a series of hymns written by David, but for some reason called after him. It is natural that a later unscientific age which has created for itself a traditional David who differed largely from the historical one (see DAVID) should have seized upon the existence of a Davidic collection as a support for its traditions and converted David into the author of the 73 psalms bearing his name.

While, therefore, the headings are of genuine importance in a study of the growth of the psalm literature, we are thrown back upon internal evidence and the careful study of the style and of the religious views reflected as a final means of determining the date of composi-

tion of any particular hymn; and if these methods fail, the problem must be frankly declared insoluble. In this investigation it is further necessary to distinguish in the case of many of the psalms between older portions and modifications as well as additions introduced at a subsequent period in the process of editing, or to adapt them to the religious aspirations of a later age. The limitations of such an investigation must, however, be recognized. In many of the psalms the references to political or social conditions are of so general or vague a character that agreement among scholars as to the period to which a particular psalm belongs is hardly to be expected; nor is the style in all cases so pronounced as to be of service in settling the date of composition. As a consequence, a candid criticism will confess in many cases its inability to solve the problem and rest content with partial results.

Accepting the general order in the growth of the Psalter as above outlined, the most important question involved in a more detailed consideration of the composition of individual poems is whether any belong to the pre-exilic period. While some critics are disposed to limit the pre-exilic psalms to a very small number, others deny the pre-exilic origin of all. To the former it seems quite improbable that after the Exile psalm composition should have assumed such tremendous importance without any impulse from an earlier age. The example of Babylonia and Egypt, where hymns and psalms formed part of the ritual from a remote period, would have been sufficient to lead to the production of such compositions among the Hebrews after they had once established a large sanctuary in Jerusalem, and the religious views embodied in some, if not in many, of the psalms are sufficiently restricted to make them fit in with the conceptions held of Yahweh before the destruction of Jerusalem. Whether, however, one may go back as far as the days of David for the beginning of psalm composition is another question. While Delitzsch accepted 44 psalms as Davidic, Ewald reduced the number to 17 and Baethgen admits only 3, namely, the first, third, and fourth, and of these he feels certain only about the first. The number of psalms ascribed to the pre-exilic period by this critic is above thirty. On the other hand, Olshausen, Cheyne, and Duhm deny that there are any Davidic or pre-exilic psalms. Coming to the post-exilic period and including among these older psalms that have been worked over, the bulk is by some critics placed before the advent of Greek rule in Palestine. The psalms of the Persian period voice the hopes, struggles, and fears of the religious community in Jerusalem, and the frequent use of the first person in those psalms is perhaps not to be interpreted as representing the sentiments of the individual, but rather the community, and in some cases the people of Israel as a whole. The number of psalms that belong to the Greek period or the Maccabean age cannot be determined with certainty. Olshausen placed the bulk of the Psalter in the Maccabean age, and the most recent commentator, Duhm, assigns most of the psalms to the Maccabean and Hasmonean periods. Cheyne places 25 psalms in this later period. But others think that only six can be ascribed with certainty to the Maccabean period.

Finally, of the three large collections already indicated, it may be supposed that the first was made in the days of Ezra, the second toward the close of the Persian period, and the third in the Greek period; it should again be emphasized that these approximate dates for the collection do not directly affect the date of composition of the psalms included in each collection. If there are any pre-exilic psalms, they are likely to be found in the first collection.

In connection with the Psalms it seems appropriate to consider briefly the general subject of Hebrew poetry, of which the Psalms represent the most notable product. Of the three classes of poetic composition usually distinguished, the lyric, the epic, and the dramatic, only the first is, strictly speaking, represented in the Old Testament; it should, however, be borne in mind that the lyric poetry of the Hebrews embraces several subdivisions, among which *gnomic* poetry stands out so prominently that it may almost be designated as a special variety, and certain scholars think that the rudiments of dramatic composition are found, as in Canticles (q.v.), the Book of Job, and elsewhere. Before the period of conscious poetic composition as an art and a profession is reached we find among the Hebrews, as among other nations, what may be called folk-poetry. If the view be correct which regards Canticles as a collection of popular wedding songs, these represent one type of this poetry. Of laments for the dead, which constitute among all peoples the second most notable division of folk-poetry, the only specimens preserved in the Old Testament belong to the more advanced period, such as David's dirge over Saul and Jonathan (II. Sam. i. 17-27), which is a type of Hebrew poetry in its most polished form. But such songs as the "Song of the Well" (Numbers xxi. 17-18), the "Song of Lamech" (Gen. iv. 23-24), and the "Song of Deborah" (Judges v.) are illustrations of old folk-poetry which show at the same time its wide range. No doubt the Hebrews had numerous harvest and drinking songs, tribal war chants, and songs celebrating the exploits of tribal heroes, which are, it is to be feared, irretrievably lost, but the persistent tradition regarding the titles of at least two of such collections, one the "Book of the Wars of Yahweh," the other the "Book of the Upright," or, as the Septuagint has it, the "Book of Songs" (see JASHER, BOOK OF), is a proof of the popularity which these compositions continued to enjoy. Passing into the domain of artistic poetry, we have, besides the Psalms, the Book of Lamentations, a series of dirges over the destruction of Jerusalem, composed in the manner of the popular laments over the dead (see JEREMIAH, LAMENTATIONS OF), and the three great specimens of gnomic poetry, Proverbs, Job, and Ecclesiastes (qq.v.), in the Old Testament proper, to which the Book of Sirach or Ecclesiasticus (q.v.) is to be added.

Concerning the form of Hebrew poetry, difficult problems arise which have not yet found a satisfactory solution. The line and the verse are found, and a characteristic feature that has long been recognized is the parallelism of the verse members (*parallelismus membrorum*). That is, the thought is expressed in two clauses of approximately the same length, of which the second bears a definite relation to the first, either repeating the thought in different words

(synonymous parallelism, cf. Psalm i. 2), or presenting a thought in contrast to that of the first (antithetic parallelism, cf. Psalm i. 6), or corresponding in structure to the first, the parallelism being in the form rather than the thought (synthetic parallelism, cf. Psalm ii. 6). All these elements are found in Babylono-Assyrian poetic literature, and may be regarded as characteristic of ancient Semitic poetry in general. The combination of verses into strophes was, of course, a step that was bound to be taken, and the earliest and most common strophe was that of four lines, but all species of variation were introduced, and it is difficult to determine the character and number of these variations. A long controversy has been waged in regard to the question of Hebrew metre, and while at present there is a general disposition among scholars to recognize the existence of well-defined metrical forms in Hebrew poetry, there is no agreement as yet to the number or even nature of these forms. Four theories are at present contending for the mastery. The one represented chiefly by J. Ley (*Grundzüge des Rhythmus des Vers- und des Strophenbaus in der hebräischen Poesie*, Halle, 1875, and *Leitfaden der Metrik der hebräischen Poesie*, ib., 1887), rests on the counting of the word-accent, of which there is at least one in every word (barring enclitics), and in some words two. According to the theory, the number of unaccented syllables is not taken into account, and the metre depends solely upon the number of accented ones. A second theory advocated chiefly by G. Bickell (*Carmina Veteris Testamenti Metrica*, Innsbruck, 1882) is an application of the principles of Syriac metres to the poetry of the Old Testament, and recognizes the various metres by the number of 'rises' and 'falls' in all the syllables of each line. The fatal objection to the theory is that it involves constant changes in the Massoretic text to admit of being carried out, and while all scholars are agreed that the Massoretic text requires critical treatment, a hypothetical metrical theory does not form a satisfactory point of departure for a pruning process. Recently Grimme ("Abriss der biblisch-hebräischen Metrik," in the *Zeitschrift der deutschen morgenländischen Gesellschaft*, 1896, pp. 529-584, and 1897, pp. 683-712) has endeavored by a combination of the accent and the quantity theory to work out new principles which rest on the assumption that every syllable has, independent of the accent or in combination with it, a definite quantity. The value of the various quantities of all the syllables in a line plus the principal tone-syllable in a word forms the means of determining the kind of metre employed. While Grimme's theory is not open to the objection that applies to Bickell's, it assumes values for the vowel signs attached to the Hebrew words which vary radically from those hitherto accepted. His theory, therefore, stands or falls with the system of accents and vowels that he sets forth in his work, *Grundzüge der hebräischen Accent- und Vocalehre* (Freiburg, 1896).

The latest investigation of the subject, and one which may fairly be considered to mark a decided advance toward the solution of the problem, is represented by Eduard Sievers's "Studien zur hebräischen Metrik," of which the first part appeared in the *Abhandlungen der philologisch-historischen Classe der königlich sächsischen Gesellschaft der Wissenschaften*, vol. xx., 1

(Leipzig, 1901). Sievers, whose contributions to metrical studies in general lend to his utterances great authority, endeavors to take into account the 'unaccented' syllables as well as the 'accented' in his study of the form of Hebrew poetry. Recognizing, as his predecessors did, that the fundamental features of Hebrew poetry are the 'line' and 'verse,' he has drawn up on the basis of an original distinction between 'singing' and 'recitative' poetry a scheme of the variations in 'lines' and 'verses' (or 'rows' (*Keihen*) and 'periods' (*Perioden*), as he prefers to call them, to be detected in Hebrew poetry. The normal foot in Hebrew poetry consisting of three syllables (or their dissolution), there are to be distinguished 'simple' lines consisting of two, three, and four feet, with a preponderance of the 'two feet' line, but with further complications by the multiplication of this kind of a line to form a 'six feet' line. The combination of lines leads again to a variety of verses or 'periods,' and among these the most common again is the 'symmetrical' verse formed of the doubled form of the triple 'two-feet' line. In the course of his elaborate investigation, Sievers endeavors to take into account not only the quantity and accent of words, but also enclitics that have no 'tone' and words which by close combination with others have lost their 'tone.' It is perhaps too early to pronounce a verdict on Sievers's scheme, but it seems safe to predict that he has directed the study into new channels, and has tended to discourage theories that either give to Hebrew poetry an 'eccentric' status or that can only be carried out by violent distortions of the Massoretic text.

BIBLIOGRAPHY. Of commentaries, translations, etc., mention may be made of those by Olshausen (Leipzig, 1853); Hitzig (2d ed., Leipzig, 1863-65); Ewald (*Die Dichter des Alten Bundes*, 2d ed., Göttingen, 1865-67; Eng. trans., London, 1880); Graetz (Breslau, 1882-83); Cheyne (*The Book of Psalms*, London, 1884; *The Book of Psalms with Commentary*, London, 1888); Perowne (London, 1864; new ed. 1892); Nowack (Gotha, 1888); Kirkpatrick (*Cambridge Bible for Schools and Colleges*, Cambridge, 1891 sqq.); Baethgen (2d ed., Göttingen, 1897); Delitzsch (5th ed., Leipzig, 1894; Eng. trans., Edinburgh, 1887-89); Wellhausen (*The Polychrome Bible*, Leipzig, 1896; Eng. trans., New York, 1898); Duhm (Freiburg, 1899). Consult, also: Cheyne, *The Historical Origin and Religious Ideas of the Psalter* (Bampton Lectures for 1889, London, 1891); Loeb, *La littérature des pauvres dans la Bible* (Paris, 1892); Davidson, *The Praises of Israel* (London, 1893); Robertson, *The Poetry of the Psalms* (London, 1898); and the introductions to the Old Testament, and Old Testament theologies of Schultz, Kayser-Marti, Smend, and Dillman. For Hebrew poetry, besides the works already mentioned, consult: Lowth, *De Sacra Poesi Hebræorum* (Oxford, 1753; trans. by Gregory, 1847); D. H. Müller, *Strophenbau und Responion* (Vienna, 1899).

PSALTERY (OF. *psalteric*, from Lat. *psalterium*, from Gk. ψαλτήριον, stringed instrument, from ψάλλειν, *psallein*, to play on a stringed instrument). A sort of dulcimer (q.v.), played with the fingers instead of with hammers. It is of Greek origin, and is related to the Persian *santir* and the Arabic *kanun*. It was a prototype of the pantaleon (q.v.), and so one of the large

family out of which the pianoforte ultimately developed. It was especially important in this respect since, in the fourteenth century, a keyboard mechanism was attached to the horizontal psaltery, and this keyed psaltery became the direct parent of the spinet, harpsichord, and virginal (qq.v.). It was popular in the Middle Ages for its sweetness of tone and purity of intonation. The Hebrew *kinnor* is rendered psaltery in the Authorized Version of the Bible wherever it is used, except in a few passages in Isaiah and in Amos, where it is translated viol.

PSAMMETICHUS, sām-mēt'ī-kūs (Lat., from Gk. Ψαμμήτιχος, Egyptian *Pscmtek*). The name of three kings of Egypt of the Twenty-sixth or Saitic Dynasty. **PSAMMETICHUS I.** (B.C. 663-609), son of Necho, Prince of Memphis and Sais, succeeded his father in B.C. 663 as a vassal of Ashurbanipal, King of Assyria, but a few years later (perhaps about 660) he renounced his allegiance, and, subduing the petty rulers who divided the country, made himself master of all Egypt. He strengthened his title to the throne by marrying a daughter of Queen Amenerdas, and established his capital at Sais, in the Delta. His military success was due to the aid of Greek and Carian mercenaries furnished, it is said, by Gyges, King of Lydia, and he subsequently introduced considerable numbers of these troops into the Egyptian army. Psammetichus protected the country by establishing strong garrisons on the frontiers, and promoted commerce by encouraging foreigners to settle in the Delta. His flourishing reign was marked by a very extraordinary renaissance in art.—**PSAMMETICHUS II.** (B.C. 594-588) was the son of King Necho and the grandson of Psammetichus I. His name is found in the quarries at Silsileh, Wadi Hammāmāt, and Tūra, and during his reign building operations appear to have been carried on in many of the sanctuaries of Egypt.—**PSAMMETICHUS III.** (B.C. 526-525), the last King of this dynasty, was conquered by Cambyses in B.C. 525, and Egypt thus became a Persian province.

PSARA, psā'rā, or **IPSARA**. An island in the Ægean Sea belonging to Turkey and situated ten miles west of the northern end of Chios (Map: Balkan Peninsula, E 5). Area, 34 square miles. Previous to the Greek War of Independence it had a population of nearly 30,000 and considerable commerce. In 1824 it was captured by the Turks after a stubborn resistance, and since then it has declined, having now a population of only 4500, chiefly Greeks.

PSCHUTT, pshūt. A slang term which came into vogue in Paris about 1880 to designate the highest degree of the fashionable elegance, which had been known as *chic* (q.v.).

PSEUDEPIGRAPHIA. See **APOCRYPHA**; **APOCALYPTIC LITERATURE**.

PSEUDO-CLEMENTINES, sū'dō. See **CLEMENTINA**.

PSEUDO-DEMETRIUS. The name frequently given in Russian history to several pretenders to the throne during the early years of the seventeenth century. See **DEMETRIUS**.

PSEUDO-ISIDORIAN DECRETALS, or **FALSE DECRETALS**. A collection of canon law which was made, probably, about the middle of the ninth century. It purports to be the work of Saint Isidore of Seville (q.v.), to whom the

name Mercator is here given. The first part of this collection contains fifty of the Apostolic Canons and some sixty decretals, purporting to be of the popes from Clement I. (101) to Melchisedes (314), arranged in chronological order. The second part consists chiefly of a body of canons which can be traced to the *Hispana*, a collection made late in the seventh century. The third part consists of thirty-five supposed decretals. This collection continued to be regarded as of unquestioned authority until the fifteenth century, when Cardinal Nicholas of Cusa first expressed doubts of their authenticity. A similar adverse judgment was rendered by scholars of the Reformation, and has been confirmed by modern historical criticism. These false decretals are thought to have been compiled for the purpose of developing the powers of the episcopate in opposition to the rights of metropolitans and of provincial synods. The critical edition of this collection is by Hinschius, *Decretales Pseudo-Isidorianæ et Capitula Angilramni* (Leipzig, 1863). There is also a partial English translation in the *Ante-Nicene Fathers*, vol. viii.

PSEUDOLUS (Lat., the liar). A somewhat loosely constructed comedy of Plautus, performed in B.C. 191.

PSEUDOMORPH. See **CRYSTALLOGRAPHY**.

PSEUDONEUROPTERA (Neo-Lat. nom. pl., from Gk. ψευδής, *pseudēs*, false + νῆρον, *neuron*, nerve + πτερόν, *pteron*, wing). An order of insects including those groups of the older order Neuroptera of Linnaus in which the metamorphoses are incomplete. As an ordinal term it is not now in use. Erichson, who originally founded the group as a suborder, included in it the Termitidæ or white ants, the Psocidæ or book-lice, the Ephemeriidæ or May-flies, and the Libellulidæ or dragon-flies (qq.v.). These groups now form the orders Isoptera, Corrodentia, Ephemeriidæ, and Odonata. Sharp retains the term Pseudoneuroptera as a 'division' of the Neuroptera, and includes in it only the families Embiidæ, Termitidæ, and Psocidæ.

PSEUDONYM (Fr. *pseudonyme*, from Gk. ψευδώνυμος, *pseudonymos*, having a false name, from ψευδής, *pseudēs*, false + ὄνυμα, *onyma*, ὄνομα, *onoma*, name). A name assumed by an author for veiling his identity or for other reasons. A common equivalent is *pen-name*. *Nom de plume*, an expression often used in English speech and writing, is not employed by the French. For contemporary pseudonyms, consult *Who's Who*, published annually. The standard works are Halkett and Laing's *Dictionary of the Anonymous and Pseudonymous Literature of Great Britain* (4 vols., Edinburgh, 1882-88); Cushing's *Initials and Pseudonyms* (2 vols., New York; 1st series, 1885; 2d series, 1888); and Barbier, *Dictionnaire des ouvrages anonymes* (4 vols., Paris, 1872-79; supplement by Brunet, 1889). See **ANONYMOUS**.

PSEUDO-PHILO. See **APOCRYPHA**, section on *Old Testament*.

PSILOMELANE (from Gk. ψίλος, *psilos*, bare + μέλας, *melas*, black). A hydrous manganese manganate that is found massive, has a submetallic lustre, and is dark gray to black in color. It occurs in botryoidal and stalactitic forms in the Harz, in Thuringia, Hungary, England, and in the United States in Vermont, Virginia, and Arkansas. Psilomelane is the com-

monest of the manganese minerals, with the possible exception of pyrolusite.

PSITTACI (Lat., parrots). The order or suborder of birds to which belong the parrots, parakeets, love-birds, lorikeets, etc. (q.v.). The Psittaci are easily recognized by the powerful hooked bill, cored at the base, the fleshy tongue, and the zygodactyl feet. The wings and tail are variable. The furculum is weak, defective, or wanting; the lower larynx is peculiarly constructed with three pairs of muscles; after-shafts are present on the feathers; and the pterylosis is remarkably falconiform. Cæcum, gall-bladder, and sometimes the oil-gland are wanting. The greatest diversity is shown in the arrangement of the carotid arteries and ambiens muscle. The classification of the Psittaci has proved a puzzle, but there are probably at least two well-marked families, Psittacidae and Trichoglossidae, with perhaps seven sub-families.

PSKOV, pskóf. A government of Russia, bounded by the governments of Saint Petersburg and Novgorod on the north, Tver and Smolensk on the east, Vitebsk on the south and southwest, and Livonia on the west (Map: Russia, C 3). Area, 17,070 square miles. The southern part is somewhat hilly and undulating; the northern is low, marshy, and thickly wooded. The chief rivers are the Lovat, which flows into Lake Ilmen; the Velikaya, a tributary of Lake Pskov; and the Düna, which drains the southeastern part of the government. Pskov has a large number of lakes, of which Lake Pskov is the largest. The average annual temperature is about 41° F. Although the soil is mostly sandy and far from fertile, agriculture is the chief industry, and rye and oats are the principal crops. On the larger estates, as well as on the farms owned by colonists from the Baltic Provinces, modern agricultural methods are employed, and cereals are raised for export. Stock-raising is neglected. Flax is grown on a large scale and exported. Next to agriculture, lumbering is the most important industry.

The principal manufacturing industries are distilling, milling, and the production of lumber. The annual value of manufactures is over \$5,000,000. Population, in 1897, 1,136,540. The bulk of the population is composed of Great Russians. Capital, Pskov.

PSKOV. The capital of the government of the same name and one of the most ancient cities of Russia, situated on the rivers Velikaya and Pskova, 171 miles southwest of Saint Petersburg (Map: Russia, C 3). It is divided into two parts, the Great City with the Kremlin on the right bank of the Velikaya, and Zavelitchie on the opposite bank. The town is still partly surrounded by its ancient walls, and has retained some remains of the fortress. In the old cathedral in the Kremlin dating from the twelfth century are the tombs of the princes of Pskov, and the church in the Spaso-Mirozhski Monastery (twelfth century) contains well-preserved frescoes and mural paintings, and a treasury with many valuable antiquities. Noteworthy are also the Cathedral of Saints Peter and Paul with its ancient icons, the churches of the Old Ascension Convent, and the old palaces of the wealthy merchants. The modern town is uninteresting. The educational institutions of

Pskov comprise two gymnasia, a Realschule, a corps of cadets, a seminary for teachers, and one for priests. There is a considerable trade and some manufacturing. Population, in 1897, 30,400.

Pskov, ancient Pleskov, was in existence at the time of the coming of the Varangians to Russia. Threatened by the Lithuanians and the Germans, Pskov became a dependency of Novgorod, but, unlike other dependencies of that republic, it enjoyed more or less autonomy, and its inhabitants took part in the *vyetche* of Novgorod (q.v.). With the growth of its commerce Pskov became more and more independent, and finally began to elect its own princes, who, however, were still considered as representatives of Novgorod the Great. By the Treaty of Bolstov in 1348 Pskov attained complete independence.

As a republic Pskov did not differ essentially in its internal organization from Novgorod. Commercially it was of the utmost importance, lying on the way between Riga and Novgorod. In the fourteenth century it became a member of the Hanseatic League. The aggressive policy of the Princes of Moscow, however, soon put an end to the little republic. Pskov committed the fatal blunder of appealing to the Princes of Moscow in its struggles with Novgorod in the beginning of the fifteenth century, thereby giving them an opportunity to interfere in its internal affairs. The internal conflicts between the masses and the upper classes afforded Moscow an additional pretext for interference, and Pskov was soon compelled to accept princes appointed by Moscow. The position of Pskov was further weakened by the fall of Novgorod, and the republic was finally abolished in 1510 by Prince Vasili, its *vyetche* suppressed, its leading merchants exiled to Moscow, and replaced by settlers from that city. Since then the city has declined, and the only important event in its history is its long siege by the Poles under Stephen Báthory in 1581-82. Consult Nikitsty, *Umriss der innern Geschichte Pskors* (Petersburg, 1873).

PSKOV, LAKE. A lake in Russia. See PEIPUS.

PSORALEA, só-rá-lé-á (Neo-Lat., from Gk. *ψωραλεος*, *psóraleos*, scabby, from *ψώρα* *psóra*, itch, from *ψᾶν*, *psan*, to rub; so called from the dots sprinkled over the surface). A genus of plants of the natural order Leguminosæ, mostly natives of warm countries, with blue, purple, or white flowers, and generally abruptly pinnate leaves. *Psoralea esculenta*, the bread-root of North America, and prairie apple, *pomme blanche* and *pomme de prairie* of the Canadian boatmen, is a perennial herb about a foot high, with a carrot-like root, rich in starch and used as food, both boiled and raw. It abounds on the high plains from the Saskatchewan to Texas. *Psoralea hypogæa* and *Psoralea cuspidata* of the same region also have tuberous roots.

PSORIASIS, só-rí-á-sis (Neo-Lat., from Gk. *ψωρασις*, itch, from *ψωριᾶν*, *psóriān*, to have the itch, from *ψώρα*, *psóra*, itch), LEPRA, ALPHOS. A chronic skin disease characterized by inflammatory dry, red, roundish patches with adherent silvery scales. Between the patches the skin cracks and bleeds. It is distributed principally over the extensor sides of the extremities, especially about the elbows and knees and the scalp, as also the trunk, and finally the flexor sides of the limbs.

No part of the body is exempt but the mucous membranes. The disease frequently accompanies rheumatism. Its cause is still obscure. The treatment consists of the internal use of arsenic, iodide of potassium, thyroid extract, salicylates, quinine, and citrate of potash, together with the local use of alkaline baths, subacetate of lead, zinc oxide, mercurial ointments, thymol, betanaphthol, chrysarobin, etc. The waters at several spas, as Leviso, Bourboule, Royat, which contain arsenic, have a vogue in the treatment of psoriasis.

PSOVIE, or BIRZON. See GREYHOUND.

PSYCHE, sí'kè (Lat., from Gk. ψυχή, breath, life, soul, butterfly, from ψύχειν, *psychein*, to breathe). As a mythological character Psyche is a creation of the later Greek speculation, and in literature is scarcely known before the story in Apuleius (q.v.). Here Psyche appears as the youngest and most beautiful of three daughters of a king. She aroused the jealousy of Venus, who sent Cupid to inspire her with passion for the meanest of men. The god, however, loved her, and caused her removal to a fairy palace of delight, where he visited her in darkness, strictly forbidding her to see his face. Her jealous sisters persuaded her to disobey this injunction, but when she approached the sleeping god with a lighted lamp, his unexpected beauty caused her to start, a drop of oil fell on the god, who woke, and after rebuking her curiosity disappeared. Vainly Psyche sought him throughout the earth and finally came to the palace of Venus, who treated her as a slave, and laid upon her impossible tasks, which, however, the unseen aid of her lover enabled her to accomplish. Finally even Venus's wrath was appeased, Jove gave her immortality, and she was united to Cupid. In this form a common folk-tale has been adapted to the philosophy which taught the preëxistence of the soul in happiness, its hard service in the body, and final immortality in bliss. Though there is no other literary testimony to this myth, the works of art show that as early as the second century B.C. the love of Eros and Psyche had engaged the Greek artists. One aspect of this story is only found on works of art of the Roman Imperial period—the torture of Psyche by Eros. Sometimes we see him holding the butterfly over a torch; at other times he binds and scourges the maiden Psyche, or with a torch sings the butterfly's wings which spring from her shoulders; again, Psyche lies prostrate before him in entreaty. The earlier groups show the lovers embracing. In the Pompeian wall-paintings or on gems we also find Psyche or Psyche with Eros engaged in various human occupations or amusements. On the Roman sarcophagi of the second and third centuries of our era, the myth of Psyche is used with obvious reference to the life of the soul, and naturally the representations pass over into the early Christian symbolism. Consult: John's edition of Apuleius (Leipzig, 1856); an English version in Walter Pater's *Marius the Epicurean*; Conze, *De Psyche Imaginibus Quibusdam* (Berlin, 1855); Collignon, *Essai sur les monuments relatifs au mythes de Psyche* (Paris, 1877).

PSYCHIATRY (from Gk. ψυχή, *psychē*, breath, life, soul + *laipela*, *iatreia*, healing, from *laipéōv*, *iatreuein*, to heal, from *laipós*, *iatros*, physician). The science which treats of the

pathology, clinical conditions, progress, cause, and treatment of diseases affecting the mind. Whether diseases are within the domain of neurology or that of psychiatry is determined by a study of the symptoms and physical signs. Many diseases affecting the mind present marked physical changes, such as tremors, alteration in tendon reflexes, pupillary anomalies, etc., as well as perversions of conduct or of action, such as exaltation, prodigality, suspicion, abulia, etc. A physician who devotes himself to the study of psychiatry is termed a psychiatrist or alienist. See INSANITY.

PSYCHICAL RESEARCH (from *psychic*, from Gk. ψυχικός, *psychikos*, relating to the soul or mind, from ψυχή, *psychē*, breath, life, soul). The term 'psychical research' takes its meaning from the activities of the Society for Psychical Research (q.v.), founded in England in 1882. The original programme of the society proposed a systematic investigation of "that large group of debatable phenomena designated by such terms as mesmeric, psychical, and spiritualistic." The work of investigation of these 'residual phenomena' was intrusted to six committees, who were to inquire severally into "the nature and extent of any influence which may be exerted by one mind upon another apart from any generally recognized mode of perception;" into hypnotism, the so-called mesmeric trance, clairvoyance, and other allied phenomena; to undertake a revision of Reichenbach's researches with reference to discovering whether his 'sensitives' possessed "any power of perception beyond a highly exalted sensibility of the recognized sensory organs;" to investigate the reports of apparitions at the moment of death, and of houses reputed to be haunted; to inquire into the causes and general laws of the phenomena of spiritualism; and to collect material relative to the history of these subjects. It becomes apparent that the group of inquiries thus circumscribed does not constitute a subdivision of an established body of knowledge, but contemplates an extension or revised interpretation of physical and psychical modes of action.

The most extensive investigations of 'psychical research' have been concentrated upon the effort to establish or detect evidence for the transference of thought apart from the recognized channels of sense. The experimental evidence has been accumulated by arranging that one person, called the 'agent,' shall think intently of a definite mental (usually a visual) impression and attempt to transfer the impression to the mind of the 'percipient,' who is supposed to be endowed with peculiar powers of this type and who in turn tries to read and record the impression thus 'transferred.' Numbers, words, drawings of simple geometrical forms, sketches of familiar objects, colors, actions, simple calculations, or even sounds, tastes, and odors have been 'transferred' in this way. The process of 'transference' seems to be more effective when the percipient is in an hypnotic or trance-like condition. In such a state there is an increased sensitiveness to slight indications of sense (hyperæsthesia), which in turn suggests the functioning of an unusual degree of sensibility of the ordinary kind in cases of successful percipiency. The data needed to justify the assumption of a non-sensory mode of thought transference are most difficult to collect; first, because the ex-

treme delicacy of sensibility in a sensitive nervous system is itself responsible for much that passes for thought-transference; secondly, because the precautions necessary to eliminate such possibilities have not as a rule been taken in the seemingly successful experiments, and proper conditions frequently are difficult to secure; thirdly, because the usual methods of performing such experiments leave the way open for unconscious exaggeration and misinterpretation, as well as for the unconscious indication of hints to the percipient. The experimenters have taken into account all of these difficulties. Yet, in the opinion of many whose judgment is entitled to great weight, the accumulated evidence does not justify, even provisionally, the entertainment of a 'telepathic' hypothesis.

The telepathic hypothesis does not rest its case upon experimental evidence alone, however. It presents an enormously extensive body of witnesses to the telepathic sending of hallucinations or presentiments, many of them having direct personal significance to those concerned, and an unusual number of them being connected with the moment of death or danger to one of the persons involved in the hallucination. The proportion of the recorded cases that contain a verifiable coincidence of event and presentiment is, on the whole, small. An elaborate census of hallucinations has been gathered by the society, and sets forth the relatively large occurrence of such hallucinations among normal persons in apparent good health. The elimination of coincidence is a vital point. The doubtfulness of erities is increased by the consideration that an intense interest in presentiments may induce the habit of noticing and recording them, thus increasing their relative frequency and the opportunity for apparently unexplainable coincidence; further by the dominant tendency to note and be impressed by favorable instances and not to notice the vastly larger number of unfavorable ones. Other investigations of students in psychical research relate to the asserted manifestation of the spirits of the departed in the affairs of this earth, mainly through individuals known as 'mediums.' Here again the evidence falls into an experimental and an observational group. The experimental evidence is that of the physical phenomena of spiritualism, the moving of tables, appearance of forms, release of the medium from knots and bonds, reading of sealed messages, and so on. In this field so much fraud or sleight-of-hand has been discovered that the students in psychical research have as a rule recognized the weakness of such evidence. Yet some of the most eminent among them have been unwilling to consider the hypotheses of deception—conscious or unconscious—in certain cases, because of their personal faith in the honesty of the medium; and in such cases as that of Mrs. Piper, in which the subject in a trance state reveals to sitters knowledge of their private affairs apparently quite beyond the usual channels of information, the alternative is presented by the investigators that the information thus revealed is obtained by the cooperation of departed spirits, or is suggestive of the action of some such unknown force as telepathy.

In many respects the field of psychical research and of psychology is the same, though the methods and purpose of the investigators may be distinct. Hypnotism, subconscious activity,

alterations of personality, hysteria, mental automatism, and related topics find recognition in the records of both. A type of such inquiry is 'crystal-gazing,' that is, the alleged power to see in a crystal or other reflecting surface a visual projection of shifting scenes and images, which upon examination can be referred to experiences subconsciously assimilated. As illustrations of the exercise of the subconscious imagination, the record of such instances possesses a distinct value for psychology. In the minds of some observers of such phenomena they, like other experiences, suggest the working of supernormal mental processes, and cannot in many cases be interpreted upon the psychological principles just indicated. Equally deserving of mention are certain studies, pursued by persons interested in psychical research, that contribute to the psychology of deception. Such studies have shown how readily the reports of performances purporting to give evidence of supernormal powers are vitiated by the effects of observation, by prejudice, by lack of technical knowledge, by lapses of memory and the like.

To the credit of psychical research must be placed a revival of interest in many worthy problems of psychology; the rescue from oblivion of important illustrative material; the contribution of illuminating aids to the comprehension of the culture history of the human race; and the social service of setting forth the pernicious and illusory character of certain systems of belief that threatened at various times the mental health of communities. To its disadvantage must be recorded the fostering of what is to some persons an unwholesome interest in the occult.

BIBLIOGRAPHY. The most important publications are those of the English Society for Psychical Research, of which up to 1903 seventeen volumes have appeared. In 1884 there was formed an American Society for Psychical Research which published four volumes before it merged its existence with that of the parent society. The best single volume surveying the field is Podmore's *Studies in Psychical Research* (London, 1897). Podmore's work on *Modern Spiritualism* (2 vols., New York, 1902) gives much information upon that as well as kindred topics. Other works worthy of mention in an outline bibliography are Andrew Lang, *Cock-Lane and Common Sense* (London, 1894); Podmore, *Apparitions and Thought Transference* (ib., 1894); Gurney, Myers, and Podmore, *Phantasms of the Living* (ib., 1886); Mason, *Telepathy and the Subliminal Self* (ib., 1897). In Jastrow, *Faet and Fable in Psychology* (1900), will be found a critical survey of certain of the problems and positions of 'psychical research.'

PSYCHICAL RESEARCH, SOCIETY FOR. An association formed in London, England, early in 1882 (as the result of a conference convoked by Professor W. F. Barrett), for the purpose of making "an organized and systematic attempt to investigate that large group of debatable phenomena designated by such terms as mesmeric, psychical, and spiritualistic." Through the agency of committees the society has gathered and published a vast amount of material on the subjects involved, with many discussions thereon. (For a discussion of the results attained by the committees, see PSYCHICAL RESEARCH.) Among the

most notable investigations of the society have been those conducted by Richard Hodgson, J. H. Hyslop, and others on the 'trance medium,' Mrs. Leonora Piper, of Boston, Massachusetts. The society's most conspicuous work was the census of hallucinations, which it carried on from April, 1889, to May, 1892. The following question was asked: "Have you ever, when believing yourself to be completely awake, had a vivid impression of seeing or being touched by a living being or inanimate object, or of hearing a voice; which impression, so far as you could discover, was not due to any external physical cause?" To this question exactly 17,000 answers were received, and a report thereon of about 400 pages was issued, embracing tabulated results and explanatory and discussional matter. (*Proceedings*, vol. x.). Of the 17,000 answers 1684, or 9.9 per cent., were affirmative; of the 8372 answers of men 655, or 7.8 per cent., were affirmative; of the 8628 answers of women 1029, or 12 per cent., were affirmative. The committee announced that it could make from this report one important deduction: that between the death of a person and the simultaneous apparition of that person to another person, at a distant spot, there is some connection.

The society is governed by a council of 24 members, who elect the officers and the new members. Meetings are held about once a month and are reported in the *Proceedings*, published monthly. The first president was Henry Sidgwick, who served 1882-84 and also 1888-92. The first vice-presidents were Arthur James Balfour, W. F. Barrett, John R. Holland, Richard H. Hutton, Rev. W. Stainton Moses, Roden Noel, Balfour Stewart, and Hensleigh Wedgewood. Other presidents have been: Balfour Stewart, 1885-87; Arthur James Balfour, 1893; William James, 1894-95; Sir William Crookes, 1896-99; Frederic W. H. Myers, 1900; Sir Oliver J. Lodge, 1901-02. Other prominent members have been Edmund Gurney, Lord Rayleigh, Frank Podmore, and J. J. Thomson. An American branch, established in 1895, includes in its membership Josiah Royce, William Romaine Newbold, Richard Hodgson, and J. H. Hyslop. In 1902 the English society had about 900 members, and the American branch about 500.

PSYCHOLOGICAL APPARATUS. The apparatus employed in a well-equipped psychological laboratory falls into the following main divisions: (1) Physiological models of the sense organs and the brain; (2) demonstration apparatus, for use in the lecture room before a large audience; (3) drill apparatus, for class work with students in the laboratory; and (4) research apparatus for the investigation of new problems, generally built, in part at least, within the laboratory. To these four classes may be added (5) certain anthropometrical instruments (see ANTHROPOMETRY), such as those which measure the diameter of the pupil, or the force and steadiness of muscular action; (6) apparatus for the observation of the habits and faculties of the lower animals, such as a microscope, with special attachments for work on the protozoa; mazes of wire or wood, to test the formation of habits in reptiles or small mammals; aquaria; cages, whose fastenings are designed to test the intelligence of their occupants; and (7) simple instruments for use with chil-

dren or defective persons, designed to test sensation, perception, feeling, action, attention.

Psychological instruments proper, i.e. the pieces included in classes (3) and (4), may be divided again into two great groups, as qualitative and quantitative. The object of a qualitative instrument is to demonstrate a fact. Suppose, e.g. that we have a black box, with ground-glass front, containing a gas-lamp, and that there are two sets of grooves behind the glass, the front set for the insertion of a black wooden shutter, and the rear set for the insertion of a second glass, colored. We light the lamp, pull up the shutter, and let the observer stare at the colored glass, which he sees through the ground-glass front. After thirty seconds we drop the shutter, and the observer sees, on the dark gray of the ground glass, a 'negative after-image' of the original color. If the colored glass was green, he now sees a colored patch of deep purple. We have performed a qualitative experiment upon the visual after-image; we have demonstrated its existence, but we have not measured its duration, or its intensity and extent as compared with the intensity and extent of the green stimulus. Had our apparatus been so constructed that we could take these measurements, the experiment would have been quantitative.

The instruments designed for quantitative work are of two kinds: those which furnish a direct scale-reading, and those which show the course of a bodily or mental process, with all its variations, as a function of time elapsed. Instruments of the former type are familiar to every one. The mercury thermometer, e.g. is a physical instrument, which allows one to determine the temperature of a room by noting the point on the scale of degrees that has been reached by the head of the column of mercury. Instances from psychology would be the æsthesiometer, which tells us how many millimeters apart two points must be set down upon the skin, with a given intensity, if they are to be perceived separately as two, and not run together in a single blurred perception; the chronoscope, from the dials of which we can read off our reaction time in units of a thousandth of a second; and the protractor of the color wheel or color mixer, which tells us the number of degrees or half-degrees by which we have varied the composition of a parti-colored rotating disk. In all these cases we have a scale of conventional units, from which we can read our results. Instruments of the second type are those employed by the 'graphic method.' The essential feature of this method is that it furnishes a curve the abscissa of which are time units (seconds, or fifths or tenths of seconds), while the varying heights of the ordinates show the variations of the process under observation. The process may be bodily, as when we trace the curve of breathing, in order to see how it changes with change in our mental state; or it may be mental, as when we have recourse to the graphic method to record the fluctuations of attention (q.v.).

PSYCHOLOGICAL ACOUSTICS. The least noticeable intensity of auditory sensation is measured by some form of *acoumeter*. The stimulus is given by the dropping of a tiny hammer upon a steel bar, by the fall of a cork or pith ball upon a glass plate, etc. Either the sound is kept constant, and the observer notes the distance at

which it can be heard; or the distance is kept constant and the height of fall varied until a sound can just be sensed. Our discrimination of sound intensities is measured by the *sound pendulum*, or the *fall phonometer*. The principle of both instruments is the same—two sounds, of slightly different intensities, are produced by the dropping of a ball or pendulum-bob against a hard-wood block, and the observer is required to say at what point the difference becomes noticeable. The highest audible tone is determined either by means of a series of tiny tuning forks, or steel cylinders, or by means of *Galton's whistle*, a piston whistle of small bore actuated by a rubber bulb, whose length can be varied from that required for a shrill tone to a length that gives a sharp hissing noise, with no trace of tonal quality. The lowest audible tone is determined by a very large tuning fork, giving tones between the limits 16 and 25 vibrations in the second; by tuning forks of wire, loaded at the tips of the prongs; by a steel tongue, *Appunn's lamella*, which can be set in vibration between the limits 4 and 24 in the second; or by the production of deep difference tones. (See AUDITORY SENSATION.) Discrimination of tonal pitch and the phenomena of clang-tint and tonal fusion are studied by the aid of delicately graduated tuning forks; reeds, with their appropriate bellows tables; organ pipes; blown bottles; siren; sonometer; etc. For the study of rhythm, the ticks of a metronome are employed, or the puffs of tone from a tuning fork placed behind a rotating disk of cardboard, pierced at regular intervals. For the study of localization of sound, i.e. of the apparent distance and direction of a given source of sound, the *sound cage* is used. This consists of two graduated semicircles of wire, the one turning about a horizontal and the other about a vertical axis. The observer sits with his head at the centre of the semicircles, and attempts to localize the click of a telephone receiver, which is placed by the experimenter at some point upon the circumference of the sound sphere.

PSYCHOLOGICAL OPTICS. Psychology borrows from the oculists their various tests of the acuity of vision, and from the physicists their manifold photometrical devices. The phenomena of color mixture are studied by means of the *spectrophotometer*, or (more usually) by the rotated disks of the *color-mixer*. This consists essentially of an axle, vertical or horizontal, which is turned with extreme rapidity by hand, by clockwork, or by an electric motor. Disks of cardboard or paper, slit along one radius so that they may be fitted together to form a single compound disk, are clamped upon the near end of the axle, and the colors of the disks cancel or blend, according to their quality and saturation. Color-mixers may also be employed for experiments on our sensible discrimination of brightnesses (grays) and colors. The phenomena of indirect vision are brought out by the *perimeter* or *campimeter*. The former consists of a hollow hemisphere, upon the centre of which the eye to be examined is fixated. Wafers of various colors are brought into the hemispherical field, along the different meridians, and the observer reports what he thus (indirectly) sees. When the whole field has been explored, a map can be made of the three zones of retinal sensitivity. The campimeter does the same work as the perimeter, except that the field is plane and not

hemispherical. Of tests of color-blindness the simplest is, perhaps, the worsted test of Holmgren. Some hundred skeins of differently colored wools are brought together, and the subject is required to match, from the heap, certain skeins that are handed him by the experimenter. For the study of perception of space in the third dimension, the *stereoscope* and *psuedoscope* are indispensable. The latter is a converting stereoscope, i.e. a stereoscope whose lenses or prisms give us an illusion of inverted tridimensionality, hollows appearing in relief, and *vice versa*. This department of psychological inquiry is rich in research instruments, which expose threads, lines, or edges at different (and, of course, unknown) distances from the observing eye. There are also special instruments for the sudden brief exposure, on a dark field, of words or figures, which are to serve as the starting-point of a train of association; others for the serial exposure of words or colors, which are to be memorized; and yet others for the test and control of the visual imagination.

HAPTICS AND ORGANIC SENSATION. The first requirement in the field of cutaneous sensation is a set of *pressure, temperature, and pain points*. These are of wood, metal, or hair. Various means have been devised for regulating the intensity of pressure, the temperature of the applied point, etc. One instrument for this purpose is the *kinesimeter* of Hall and Donaldson, which passes pressure or temperature points over a selected area of the skin, at a constant rate and intensity. The least noticeable pressure is determined by a series of small and accurately graded *touch weights*, or by a series of hair points, the area and bending weight of which are known. Discrimination for pressure is measured by weights, laid upon the resting skin; discrimination for lifted weights (in which pressure co-operates with the articular and tendinous sensations), by cylindrical weights of hard rubber, filled with shot, which are lifted successively in pairs, and thus compared. Sensitivity to temperature and pain is determined by the application of *temperature cylinders* and of the *algometer* to a chosen portion of the skin. The algometer is a rod, usually covered at the exposed end with cloth or chamois leather, which works against a spiral spring; the amount of pressure which evokes pain is read from a scale laid along the spring. The *asthesiometer*, in simplest form, is a pair of ordinary drawing compasses, tipped at the ends with hard rubber. The object of the instrument is to show us how far apart two cutaneous pressures must lie, if we are to perceive them as separate; and, again, what separation of the compass points at one part of the skin gives a separation, in perception, equal to that of a given separation of the points at another part of the skin. The least amount of movement that can arouse an articular sensation is given by the *arm board*, a hinged board upon which the observer lays his hand and arm (bringing the elbow over the hinge), and which is then, very gradually, raised or lowered by the experimenter. Discrimination of kinesthetic sensations is tested by the finger-movement and the arm-movement apparatus of Cattell and Münsterberg. In both of these the finger is inserted in a car, which travels for a prescribed distance along a track; the observer then tries to reproduce the movement by memory. The static sense (sensation of dizziness) is studied by the *rota-*

PSYCHOLOGICAL APPARATUS

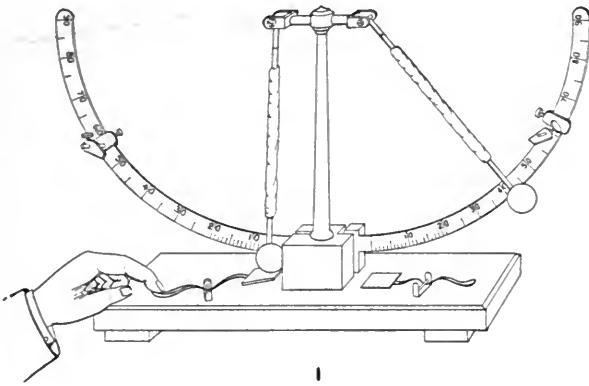

1

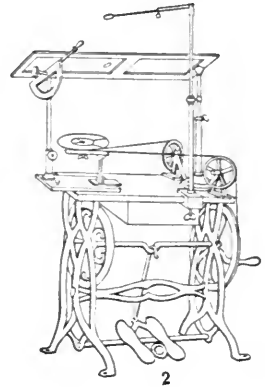

2

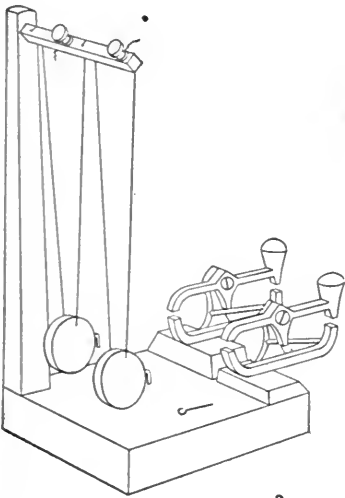

3

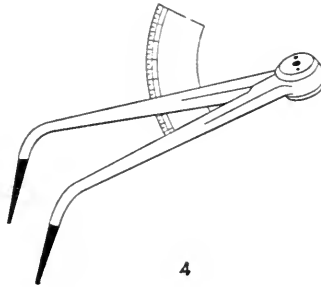

4

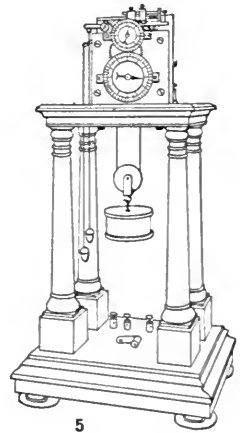

5

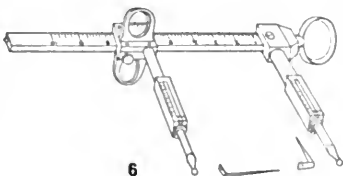

6

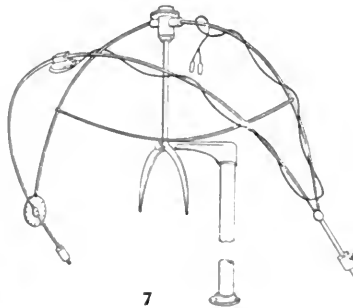

7

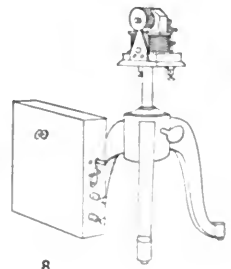

8

1. SOUND PENDULUM
2. COLOR MIXER AND CAMPIMETER
3. VERNIER CHRONOSCOPE
4. SIMPLE AESTHESIOMETER

5. HIPPI CHRONOSCOPE
6. GRIESBACH'S AESTHESIOMETER
7. SOUND CAGE
8. ELECTRIC MOTORS FOR COLOR MIXING.

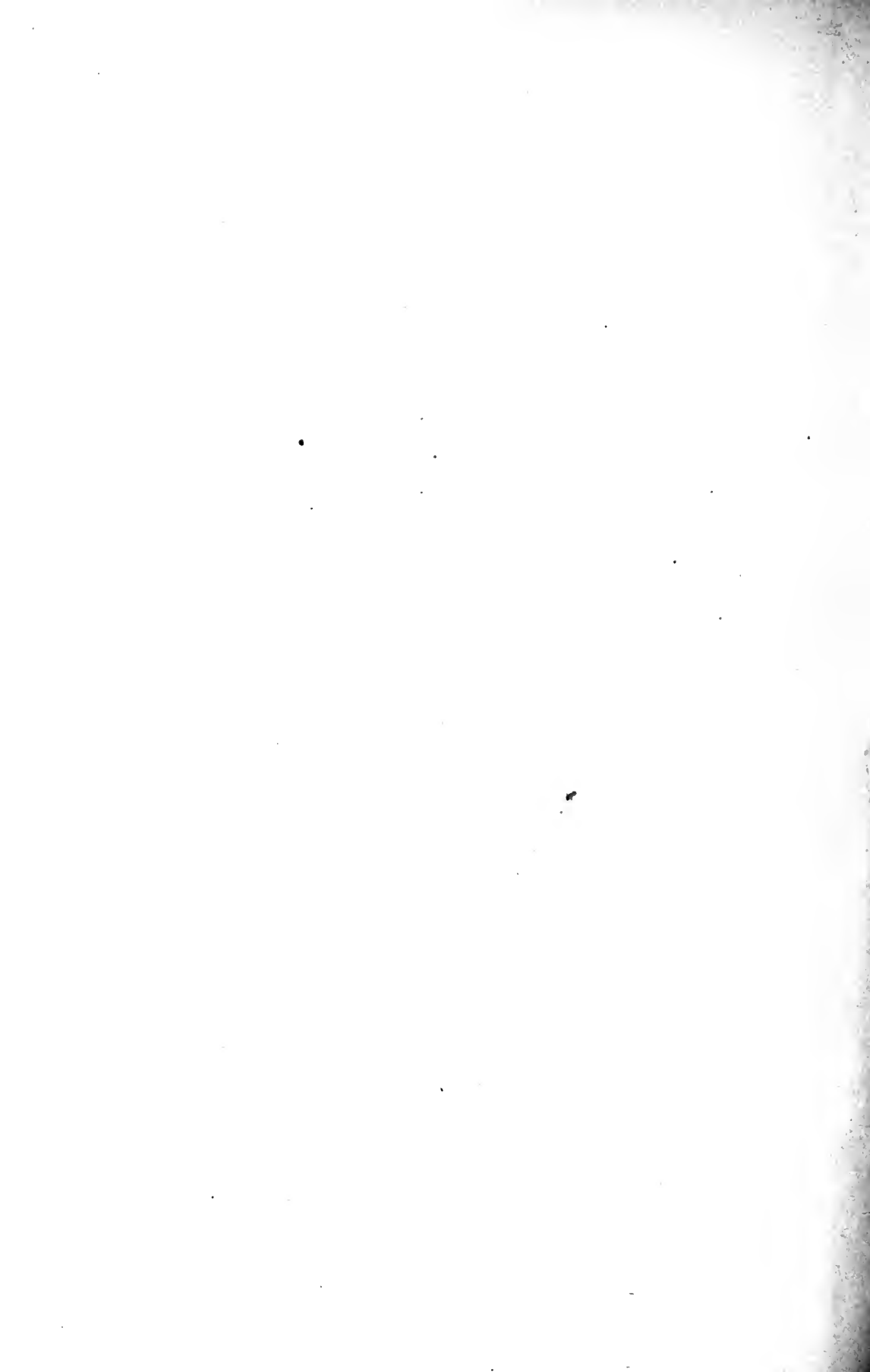

tion table, a flat bed or table upon which the observer is stretched, and which can be twirled round, in the horizontal plane, at constant rates. Perception of the movement and position of the whole body is investigated both by the rotation table, and by the *tilt-board*, a similar instrument, in which the table can be swung through approximately 180° in the vertical plane. The observer, strapped upon the table, estimates the extent and direction of movement, the true values of which can be read from a scale.

TASTE AND SMELL. For the study of gustatory sensation, we need very simple appliances: a magnifying glass or concave (enlarging) mirror, for bringing out clearly the separate papillae of the tongue; fine camel's-hair brushes, for the application of stimulus; and sets of solutions, of varying strength—sweet (sugar), salt, sour (tartaric acid), and bitter (hydrochlorate of quinine). For the study of olfactory sensation, on the other hand, we need a special (and in some of its forms highly complicated) instrument, the *olfactometer* of Zwaardemaker. In principle, the olfactometer consists of a glass tube, bent up at right angles to enter the observer's nostril, and passing through an odorless screen of wood or metal, which prevents the access of any foreign odor to the nose. Over the portion of the tube that projects behind the screen is slipped an 'olfactory cylinder'—a glass eased tube of some odorous matter, such as rose-wood or asafetida. When the cylinder is pushed hard against the screen, its outer edge is flush with the end of the glass inhaling tube, so that nothing of its substance can be smelled. If, however, it be pulled out, say for 1 centimeter, then the current of air which reaches the observer's nostril must pass over this 1 centimeter of exposed odorous surface before it enters the inhaling tube. If the cylinder be pulled out still farther, then the incoming air current must pass over a still greater odorous surface. We have, in this way, a means of quantitatively regulating the stimulus that we are applying to the sense organ.

AFFECTIVE PROCESSES. Under this heading, we must give a brief general account of the *graphic method*. The essentials of the method are three in number. We must have (1) a *recording surface*, on which the curve is to be traced. This generally takes the form of a brass drum, rotated by weight or motor or clockwork, and covered with a sheet of smoked white paper. It is called a *kymograph*. We must have (2) a *time line*, i.e. a tracing marked off into divisions which represent known time units. We may, e.g. attach a little strip of parchment to one of the prongs of an electrically driven tuning fork, and lay the tip of this strip tangentially against the revolving drum. As the drum moves and the fork vibrates, the movement of the strip will be drawn out into a sinuous curve, each wave of which represents the time unit of the vibrating prong. The curve shows white upon the drum surface, since the moving strip knocks off the soot at the point of contact. Finally, (3) we must have special apparatus which shall write upon the drum, above the time line, the course of the process under investigation. Such apparatus are actuated, for the most part, either by electricity or by air transmission. For example, in registering the course of breathing, we employ air transmission. We connect the stems of two

stretch a sheet of thin rubber over their two heads. If we press the elastic covering of either head, the covering of the other will, evidently, bulge outward. Let us, then, apply the first head to the observer's chest and hinge a light lever (which we apply to the drum surface) to the other. As the chest rises and falls in respiration, the lever on the second funnel-head will rise and fall correspondingly, and we have our curve traced upon the kymograph. The funnels are known as *Marcy's tambours*. In the *sphygmograph*, or pulse recorder, the free tambour is laid over the radial artery of the wrist, and the pulsations of the artery are reproduced upon the drum. In the *pneumograph*, or breathing recorder, this tambour is replaced by an elastic girdle, passed round the thorax: this opens into the connecting rubber tube, and the curve is traced as before. In the *plethysmograph*, or volume recorder, the tambour is replaced by a glass vessel containing air or water. The hand or arm is inserted in the vessel, which is then hermetically closed, save for the tube connection to the writing tambour. As the inclosed member changes in volume, the writing point rises and falls upon the kymograph surface. Lastly, in the *dynamograph*, or strength recorder, the free tambour is replaced by a heavy steel spring, which is gripped by the hand; as the pressure increases or relaxes, puffs of air are sent along the connecting tube to the writing lever, and the fluctuations of muscular strength are correctly registered. It is also necessary to record the involuntary movements of arm and hand. For this purpose we use the *automatograph*, a scientific modification of the once popular planchette. The course of fatigue may be followed by means of the *ergograph*, which records the work done in a continuous pull against a spring, or in the successive lifting of a constant weight.

ACTION. The simplest instrument for the performance of reaction experiments (see REACTION) is Sanford's *vernier chronoscope*. This consists of two pendulums, of slightly different lengths. The one is started by the opening of a key, simultaneously with the giving of the stimulus (the signal for movement); the other, by the opening of a second key, pressure upon the button of which constitutes the movement of reaction. The two pendulums swing together on the principle of the vernier; and the number of swings made, before coincidence is reached, gives the reaction time in fiftieths of a second. A more elaborate arrangement is that of the *Hipp chronoscope*. This is an electric clock, with a unit of a thousandth of a second. The clock is started by the giving of the reaction stimulus, and arrested by the reaction movement. The stimulus may be given by the swing of a pendulum, which sends a ray of light or exposes a patch of color to the observer's eye; by the fall of a hammer upon a metal block; by a pressure upon the skin. In every case, the instrument employed is in electrical connection with the chronoscope. The movement of reaction may be made by hand or foot, by voice, by lips, or eyelid. Whatever the form of 'reaction key' employed, it, too, is always in electric connection with the chronoscope. Once more, the time of reaction may be recorded directly, by time-markers, upon the surface of the chronograph, a kind of kymograph, provided with tuning-fork controls that give an exceedingly accurate time line.

ATTENTION. The fluctuations of attention are measured by very faint auditory or visual stimuli; e.g. by the ticking of a distant watch, the continuous fall of a little stream of sand, or the light gray rings on white ground produced by rotation on the color-mixer of a disk of white cardboard, on which is drawn a broken black radius. Distribution or distraction of attention is studied by the *complication pendulum*—an instrument which presents to the observer, at one and the same moment, impressions of sight, of sound, and of touch. The range of attention, i.e. the number of objects simultaneously apprehensible by a single attentive observation, is determined visually by the *tachistoscope*, and auditorily by the metronome. The tachistoscope consists, in essentials, of a screen carrying words, figures, or letters, which can be displayed for a fraction of a second by a shutter, like the instantaneous shutter of a photographic camera.

OTHER INSTRUMENTS. Apparatus employed in the study of the more complicated mental processes have, as a rule, the special form given them by individual investigators. There are several forms of *memory apparatus*, the essential feature of which is the serial exposure of words, letters, etc., to be memorized by the observer. In work upon recognition, it is usual to adopt some one of the pieces given under the headings *Psychological Acoustics* and *Psychological Optics*. Something has been done, in the study of imagination, by aid of the symmetrical figures formed by folding upon itself a piece of paper upon which an ink-blot has been made; recourse is also had to the suggestions aroused by printed sentences or paragraphs. Individual psychology has its own materials, of specially prepared proof-sheets or pages of printer's pi, letter-patterns upon ruled cards, etc., etc. Finally, it may be said that the apparatus described in the body of the article above are, in general, the simplest of their kind; many more elaborate instruments have been devised, as e.g. for the study of rhythm.

Every laboratory must possess a good stock of *general supplies*, for use with the above-mentioned special apparatus. We may refer, in particular, to chemical and photographic materials; electrical appliances—motors, cells, storage batteries, switches, keys, wires; mechanical supplies—tools, balances, materials for the construction and repair of simple instruments, standards, arms, clamps, etc., for the building up of complex apparatus; projection lantern, and wall charts.

In the light of the above discussion, the figures of the plates will be largely self-explanatory. The sound pendulum was first invented by Fechner; it is figured in the form given it by Wundt. The combined color-mixer and campimeter was devised by Hering. Figs. 2, 3, 4, 6, 7, 8 of this Plate are taken from Titchener's *Experimental Psychology*. The Appunn tonometer is a box containing reeds, differing by 4 complete vibrations; it is used for investigations of sensible discrimination, etc. The figure of Zwaardemaker's olfactometer shows the appliances used for the simultaneous record of the observer's breathing curve. The Deprez signal is a time-marker, replacing the tuning fork referred to in the text. Masson's disk is employed in experiments on the fluctuation of visual attention. Figs. 2, 4, 5, 9, 10 of this Plate are taken from Titchener's

Experimental Psychology; Fig. 7 is from Sanford's *Laboratory Course*.

Consult the authorities referred to under **LABORATORY**, and especially the catalogues of instrument-makers listed in Titchener, *Experimental Psychology* (New York, 1901). See **DURATION**; **ILLUSION**.

PSYCHOLOGICAL ASSOCIATION, AMERICAN. A learned society organized in New York, July 8, 1892, and having its headquarters at Columbia University. Its object is the advancement of psychology as a science, and it has a membership of one hundred and twenty-five. The society publishes an annual volume of *Proceedings*.

PSYCHOLOGY (from Gk. $\psi\upsilon\chi\eta$, *psychē*, breath, life, soul + $-\lambda\omicron\gamma\iota\alpha$, *-logia*, account, from $\lambda\acute{\epsilon}\gamma\omega$, *legein*, to say). Psychology may be defined as the science of mind. More exactly, it is the science of mind considered for the sake of mental facts and processes alone, and apart from their values or consequences. It is thus distinguished from the other mental sciences: from logic, which is concerned with the truth or error of reasoning processes; from epistemology, which is concerned with the validity of perception; from metaphysics, which deals with the consistency and reference of fundamental conceptions; and from ethics, which is concerned with ideas in relation to their influence upon conduct. Psychology is distinguished from all these, while at the same time it necessarily encroaches upon their territory in considering the mental facts with which they also deal, what distinguishes psychological science from the others being its point of view, which is primarily the observation and analysis of the immediate psychical phenomenon whatever its nature.

The most important works which appeared before the advent of modern philosophy, works which the modern psychologist cannot afford to neglect, are Aristotle's treatise *De Anima* with its appendices, the *Parva Naturalia*, and the *Summa Theologiae* of the scholastic philosopher Thomas Aquinas. For Aristotle's psychology, consult the works of Wallace (Cambridge, 1882) and Hammond (London, 1901). Carus, *Geschichte der Psychologie* (Leipzig, 1808), and Harms, *Geschichte der Psychologie* (Berlin, 1878), have written general histories of psychology, but both are very incomplete. The two volumes of Siebeck, *Geschichte der Psychologie* (Gotha, 1880, 1884), extend only to Thomas Aquinas. Dessoir has recently published the first part of a *Geschichte der neueren deutschen Psychologie* (2d ed., Berlin, 1897).

The principal stages in the development of modern psychology may be characterized as the speculative or deductive, the empirical or associationist, and the scientific or experimental. The first and third are preponderantly German, the second English. The first may be said to culminate in Hegel (consult Wallace, *Hegel's Philosophy of Mind*, Oxford, 1894), though it has continued in the 'purely introspective' works of the Herbartian school. The second contains the great names of English philosophy, from Thomas Hobbes down to John Stuart Mill and Alexander Bain. The cardinal defect of this psychology is its confusion of the logical or epistemological standpoint with the standpoint of psychology proper. It conceives of perception, e.g. as a sum or aggregate of least bits of knowledge, which it

PSYCHOLOGICAL APPARATUS

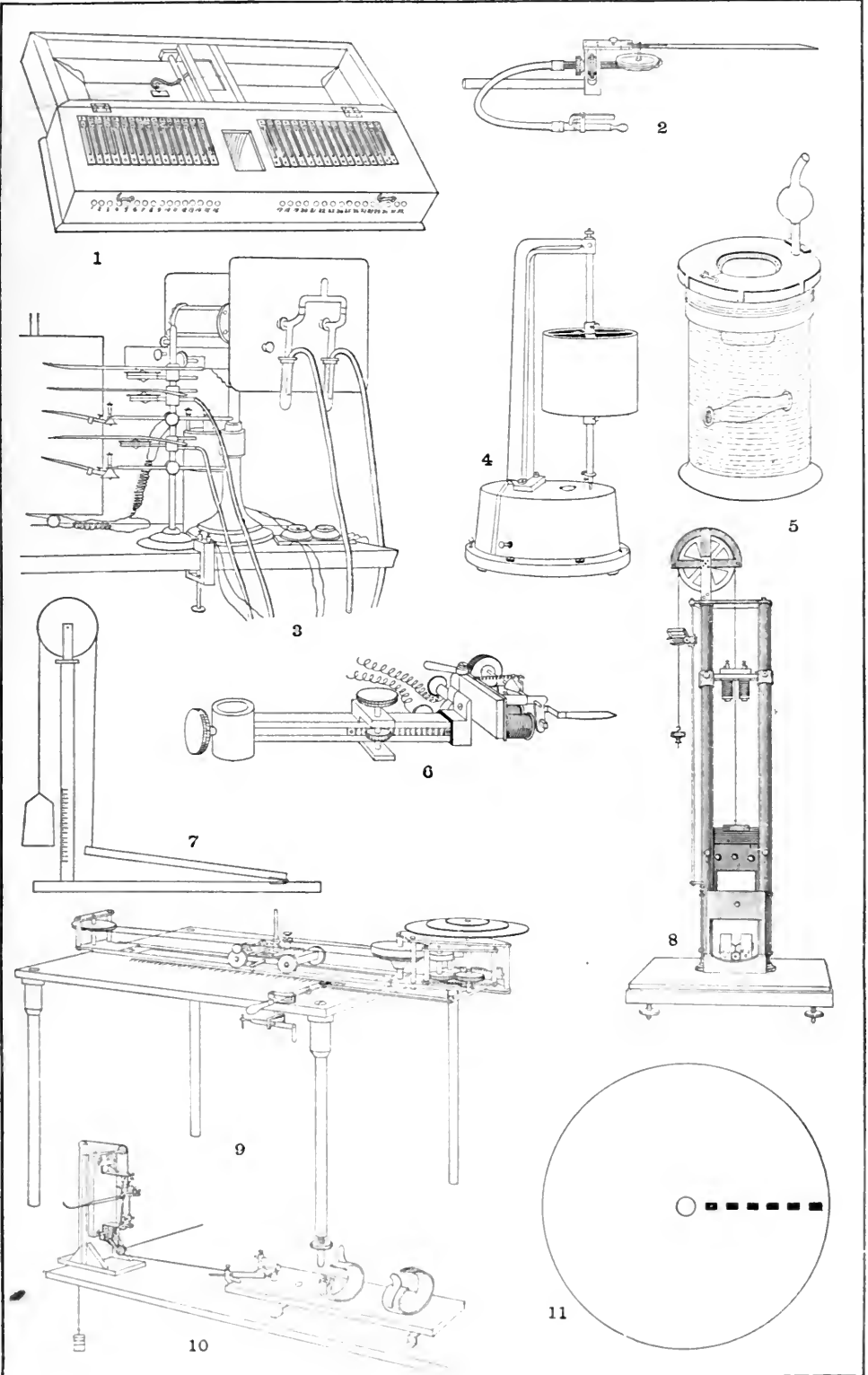

1. TONOMETER
 2. MAREY TAMBOUR, WRITING LEVER AND AIR-COCK
 3. ZWAARDEMAKER'S OLFACTOMETER
 4. SIMPLE CLOCK-WORK KYMOGRAPH
 5. FRANCOIS-FRANCK'S PLETHYSMOGRAPH

6. DEPREZ SIGNAL
 7. ARM BOARD
 8. DATTILL-WUNDT TACHISTOSCOPE
 9. KINESIMETER OF HALL AND DONALDSON
 10. MOSSO'S ERGOGRAPH

11. MASSON'S DISC

terms sensations; and it is fond of appealing to the naïve consciousness for confirmation of its analysis. The associationist position has been largely transcended, though the epistemological reference still remains prominent, in the later English and American works of J. Ward, W. James, and G. F. Stout. In spite of all deficiencies, the psychologies of the associationist school retain a high value on the level of descriptive analysis. The third or experimental stage of psychology was inaugurated in Germany by the work of R. H. Lotze, *Medizinische Psychologie* (Leipzig, 1852); G. T. Fechner, *Elemente der Psychophysik* (ib., 1860); and W. M. Wundt, *Grundzüge der physiologischen Psychologie* (ib., 1874). It should be added that France has made important contributions to modern psychology from the side of abnormal psychology (Pierre Janet, H. Bernheim, Th. Ribot, A. Binet); and that the work of the English nineteenth-century writers upon ethnopsychology (E. B. Tylor, J. Lubbock, H. Spencer) can hardly be overestimated. The influences that determined the course of psychological thought in America were, down to about 1880, almost entirely theological and educational; and the principal works upon mental philosophy (N. Porter, J. McCosh) belong to the Scotch school of natural realism. In recent years America has made very great advances in experimental psychology, in which she stands to-day second only to Germany. In the field of child psychology (G. S. Hall, J. M. Baldwin) America has left Germany (W. Preyer) far behind.

The special departments of psychology are very numerous, and their interrelations not always obvious. We have experimental and physiological psychology, race or folk or anthropological or ethnic psychology, comparative and genetic, animal and child psychology, social or collective psychology, individual or differential psychology, introspective psychology, abnormal psychology or mental pathology, philosophical and educational or applied psychology. Can we find any guiding principle that shall bring order into this chaos, and exhibit all the psychologies as parts or phases of a unitary whole?

We may rule out, first of all, those psychologies which are differentiated from the rest, not by diversity of subject-matter or of problem, but by emphasis of method. Experimental psychology, e.g. is merely psychology treated by the experimental method; and since there is, in principle, no mental process or complex of processes that is inaccessible to experiment, experimental psychology may be regarded, in principle, as coextensive with psychology. In other words, it is simply an historical accident, the result of the youthfulness of psychological experimentation and of the very natural concernment of the experimentalist with the processes that yield themselves most easily to experimental control, that there are some chapters of psychology, as psychology is written to-day, in which experiment is prominent, and others in which it plays little or no part. So, again, all psychology is introspective: either directly introspective (normal human psychology) or analogically introspective (infant and animal psychology); there is no special or peculiar introspective psychology. The phrase is sometimes used to designate a school of thinkers who will hear nothing of the dependence of mind upon the nervous system, but seek to elaborate a 'pure' psychology out of

nothing but the psyche itself—and are thereby compelled to have recourse to 'unconscious' mental processes, which are very far from being given in introspection. This use is, however, misleading: it is better to name the founder of the school, and to speak, e.g. of the Neo-Herbertians.

We may rule out, in the second place, those psychologies that transcend the sphere of mind, whether on the side of science or on that of philosophy. Physiological psychology, e.g. includes portions of physiology. The problem of physiological psychology is, "first, to examine those vital processes which lie midway between external and internal experience, and which therefore demand the application, at one and the same time, of the two methods of observation, the external and the internal; and, secondly, from the point of view which it has gained in its investigation of these processes, to survey the whole realm of vital phenomena, and thus mediate, so far as possible, a comprehensive theory of human existence" (Wundt, *Physiologische Psychologie*, i., 2). Philosophical psychology, or the philosophy of mind, deals with such questions as that of the nature of mind (whether there is a mind-substance, or whether the mental processes, as given, constitute mental reality: 'substantiality' vs. 'actuality'); of the ultimate elements of mental experience (intellectualism vs. voluntarism); and of the relation of mind to body, of psychical to physical (parallelism vs. interaction). We may mention: Rehnke, *Lehrbuch der allgemeinen Psychologie* (Hamburg and Leipzig, 1894); Ladd, *Philosophy of Mind* (New York, 1895); and Münsterberg, *Grundzüge der Psychologie*, i. (Leipzig, 1900). Lastly, applied psychology is called upon to furnish regulative principles to the art of education. Genetic psychology shows how the normal individual develops; applied psychology has to deduce from the genetic data an ideal plan or scheme of the evolution of personality, and then to show how this ideal may be most nearly attained in practice. In the discharge of both offices, it leaves the ground of scientific psychology.

There still remain the various subdivisions of psychology proper. We shall realize their interconnection and mutual relation most easily by taking an analogy. Mind, like the living body, is an organism: in this sense, psychology is the correlate of biology. Now biology falls into several part-sciences. The individual living organism is, under different aspects, the subject-matter of morphology, of physiology, and of embryology. Morphology treats of the structure of the organism, of its composition from cells and from cell-aggregates or tissues. Physiology treats of the organism as a group of functions—respiration, secretion, digestion. Embryology treats of the growth of the organism, structural and functional alike, following the changes of tissue and of function that mark the rise and fall of the vital processes. Further, biology deals with groups of organisms, with species. Over against morphology stands taxonomy, in which cells and tissues are replaced by organisms and their classes (species, genera, orders, etc.). Over against physiology stands bionomics, in which the function of organs within an individual organism is replaced by the function of species in the economy of their natural environment. And over against embryology stands paleontology, the science of the development of species. Once more: biology, as pathology, treats of the diseased or

defective organism, and so has its 'abnormal' side.

Let us apply this classification to psychology. We have, in the ordinary text-book of psychology, a morphology and a physiology of mind. Some authors lay more stress upon the analysis of structure (Külpe, Titchener), others upon the analysis of function (James, Stout, Ward): this is mainly a matter of the psychologist's training, of the direction (scientific or philosophical) from which he approaches the psychological problem. The important thing is to keep the two lines of inquiry distinct, not to hypostatize function, to invent separate structures that shall carry its separate phases, as is done, e.g. by a psychology that speaks of 'memories' and 'memory ideas' as qualitatively unique processes; and not to translate structure directly into function, as is done, e.g. by a psychology that makes sensation the primary source of knowledge. We have, again, in infant and child psychology, a mental embryology. Spinoza's classification of the emotions and Wundt's classification of the forms of association—to bring together instances from different periods of time—are essays in mental taxonomy. Social psychology and ethnopsychology, so far as they have gone, fall for the most part under the head of mental bionomics. Animal psychology, and such comparative psychological systems as those of Spencer and Romanes, are the counterparts of paleontology. We may bracket together the study of the child and animal minds, of the growth of the individual and racial mind, as genetic psychology. Mental pathology, the psychology of the abnormal, deals with such topics as the space ideas of the blind (study of defect or lack), dreaming and hypnosis (temporary mental derangement), and insanity (permanent mental derangement). Finally, individual psychology investigates the variations of normal mental function. The inquiry may be pursued in the interests of genetic psychology (Galton) or of mental physiology (Stern). The present quasi-independence of individual psychology is due to the fact that it has but recently attracted any widespread attention; psychologists have been concerned to discover mental uniformities rather than to examine mental differences. There can be no doubt that, in course of time, it will be absorbed into general psychology.

If now, in the light of the above classification, we attempt to lay out a complete psychological programme, we shall arrive at some such result as the following. The psychologist will prepare himself for his work by a study of the nervous system at its various developmental levels. Entering upon psychology proper, he will seek to determine, on the structural side of mind, the number and nature of the mental elements, the patterns upon which they are arranged in the complex processes, and the gradual growth in intricacy of these patterns as mental development proceeds; on the functional side, the nature of the root-functions of mentation, the mode of coöperation of these functions in the developed mind, and their gradual growth in complexity from the infant to the man. In his study of function, he will be keen to note differences, individual variations, as well as uniformities. He will, further, give some attention to the questions of classification and arrangement of the typical mental formations, keeping the genetic principle

well in view. He will endeavor to extend his knowledge of mental function beyond civilized humanity to the animals and the lower races of man, and to trace the psychological laws underlying the great products of the collective mind—language, custom, and myth. Here, too, his work will be informed by the genetic spirit. During his occupation with normal phenomena, he will not neglect the observation of the abnormal. Finally, he may attack the questions that lie on the border line between science and philosophy, the questions of the appearance of mind in the evolution of the universe, of the criterion of mentality in the lowest animals, of the ultimate nature of mind, of the relation of mind to body; or he may turn the results of his scientific inquiries to immediate practical account, embodying them in some psychologically grounded system of education. The programme is too large for any one man to cover; and the interests which it demands—philosophical, scientific, practical—would hardly appeal, in any case, to a single personality. But we can see, assisted by our biological analogy, that it is unitary and self-consistent.

BIBLIOGRAPHY. Special references will be found under the headings ANIMAL PSYCHOLOGY; CHILD PSYCHOLOGY; ETHNIC PSYCHOLOGY; EXPERIMENTAL PSYCHOLOGY; GENETIC PSYCHOLOGY; INDIVIDUAL PSYCHOLOGY; MENTAL PATHOLOGY; PSYCHOPHYSICS; SOCIAL PSYCHOLOGY. General introductions to psychology are: Baldwin, *Story of the Mind* (New York, 1898); Buell, *Essentials of Psychology* (Boston, 1898); Ladd, *Primer* (New York, 1894); and Titchener, *Primer* (New York, 1900). Useful works of text-book size are Baldwin, *Elements* (New York, 1893); Dewey, *Psychology* (New York, 1898); Höffding, *Outlines* (London, 1891); James, *Text-book* (New York, 1892); Ladd, *Outlines of Descriptive Psychology* (New York, 1898); Maher, *Psychology* (London, 1900); Mercier, *Sanity and Insanity* (London, 1890); Moll, *Hypnotism* (London, 1891); Morgan, *Introduction to Comparative Psychology* (London, 1894); Murray, *Handbook* (Boston, 1890); Ribot, *Psychology of the Emotions* (London, 1897), and other works; Scripture, *The New Psychology* (London, 1897); Külpe, *Outlines* (London, 1895); Ladd, *Elements* (London, 1889); Titchener, *Outline* (New York, 1899); Wundt, *Human and Animal Psychology* (trans., London, 1896); id., *Outlines* (trans., Leipzig, 1898); Ziehen, *Introduction to Physiological Psychology* (London, 1895). Larger treatises are Bain, *Senses and Intellect* (London, 1868); id., *Emotions and Will* (London, 1880); Baldwin, *Handbook* (New York, 1890-91); id., *Mental Development* (New York, 1895-97); Cornelius, *Psychologie* (Leipzig, 1897); Höfler, *Psychologie* (Vienna, 1897); James, *Principles* (New York, 1890); Jodl, *Lehrbuch* (Stuttgart, 1896); Ladd, *Elements of Physiological Psychology* (New York, 1889); id., *Psychology, Descriptive and Explanatory* (New York, 1894); Lipps, *Grundthat-sachen des Seelenlebens* (Bonn, 1883); Marshall, *Instinct and Reason* (New York, 1898); Morgan, *Animal Life and Intelligence* (London, 1891); id., *Habit and Instinct* (London, 1896); Romanes, *Mental Evolution* (London, 1888); Stout, *Analytic Psychology* (London, 1896); Sully, *Human Mind* (London, 1892); Volkmann, *Lehrbuch* (Köthen, 1884); Wundt, *Physiologische Psychologie* (Leipzig, 1893). It must be understood

that this list is merely selective, even for the quite recent period which it covers.

PSYCHOLOGY, ETHNIC, OR ETHNOPSCHOLOGY. A department of psychology as yet hardly susceptible of exact definition. We may describe it, provisionally, as the individual psychology of races, tribes, or peoples. While it seeks to analyze and depict the mental peculiarities of societies of communities, still it is not concerned, as is social psychology (q.v.), with the mental products of the common life of man; it seeks rather, by methods of statistical comparison and averaging, to construct the typical individual of the tribe or people under consideration, and thus to make clear his resemblances to and difference from the typical individual of the text-books of descriptive and experimental psychology. Ethnopsychology thus attempts the same problem in the sphere of racial types that ethology (in Mill's sense of the science of character) attempts in the sphere of the individual variations of human tendency and endowment (Wundt). It stands to the physical and physiological parts of ethnology (ethnogeography, anthropometry, etc.) as psychophysics stands to physiology. Ethnopsychology, as thus defined, forms, together with the histories of language, myth, and custom, the necessary propædæutic to social psychology. Under its province would fall, e.g. an investigation of the keenness of perception (sight, smell), or the æsthetic tastes, or the superstitious beliefs of the savage; a study of the relative parts played by reason and emotion in the Anglo-Saxon and the Latin minds; a comparison of the minds of the Oriental and of the Occidental: inquiries varying in scope from the cleanly formulated questions of normal psychology to the widest generalizations of which the science of mind is capable, but all aiming at a single end—the individual characterization of the mentality of a racial group. It must, however, be repeated that the term ethnopsychology has not hitherto found general acceptance, and that many authors discuss topics like those just mentioned under the headings of anthropology, ethnology, and sociology (qq.v.).

BIBLIOGRAPHY. For definition, Wundt, *Völkerpsychologie* (Leipzig, 1901); for comparison of hunter, nomad, and agriculturist, Wundt, *Ethics* (London, 1897); for a comparison of the Anglo-Saxon and French minds, Le Bon, *The Psychology of Peoples* (Eng. trans., London, 1898); for analysis of the love consciousness at different levels of mental development, Finck, *Primitive Love and Love Stories* (New York, 1899). Consult also: Tylor, *Anthropology* (New York, 1885); Spencer, *Sociology* (ib., 1885); id., *Essays* (ib., 1891).

PSYCHOLOGY, EXPERIMENTAL. A comprehensive term for those phases of mental science which are variously called 'the new psychology,' 'psychophysiology,' 'physiological psychology,' and 'psychophysics.' It may be defined as the exact science of mind (see **PSYCHOLOGY**), and as such is not a department of psychology, coordinate with other departments, but rather a psychology dominated by a certain method. Kant said, in his *Metaphysische Anfangsgründe der Naturwissenschaft*, that psychology could never be a science: (1) Because mental process has but one dimension (time), and where you have but one dimension you cannot apply mathematics to your subject-matter, i.e. cannot handle it

scientifically; (2) because no sane person would submit himself to your psychological experiments, even if you devised them; and (3) because the employment of psychological method, or introspection (q.v.), changes the objects upon which it is directed, and so precludes the possibility of uniform results. Kant was, however, blinded by his *a priori* assumptions; he shared with the great German philosophers since Leibnitz (q.v.) a hearty contempt for the 'lower faculty of knowledge' or sense-perception (see **FACULTY**); and he was unduly impressed by the worthlessness for science of the 'empirical' psychologies of his own day. Hence he could not see, as we do, that wherever in the past there had been scientific discussion of the facts and laws of perception, and of the physics and physiology of voluntary action, important contributions had been made to a future science of experimental psychology. Indeed, it is only in the latter half of the nineteenth century that the three Kantian objections have been finally answered, and that psychology has taken rank as a science among the sciences.

The argument that mathematics is inapplicable to mental processes was brilliantly met by Herbart (q.v.), who pointed out that our inner experience shows differences not only of duration, but also of intensity, and expressed the course of ideation, as a function of these two variables, in a series of mathematical formulæ. Herbart's 'mathematical psychology' is now out of date; the method that he, as a pioneer, followed has not stood the test of time. But his service to the cause of mental science is none the less real and enduring. The second and third objections have been overcome by the work of Fechner and Wundt (qq.v.), whose *Elemente der Psychophysik* (Leipzig, 1860) and *Grundzüge der physiologischen Psychologie* (4th ed., Leipzig, 1893) mark epochs in the development of the new psychology. No one could urge, after the publication of the *Psychophysik*, that psychological experimentation with human subjects was impossible. Fechner experimented, systematically and successfully, with himself and with others, upon a long list of special problems, and the methods which he prescribed are those employed to-day in psychophysical investigations. Wundt put the matter beyond the reach of controversy by his foundation of the first psychological laboratory (q.v.) at Leipzig in 1879. Wundt appears, further, to have been the first to use the phrase 'experimental psychology,' which occurs in his *Beiträge zur Theorie der Sinneswahrnehmung* (1862). His services both to psychology proper and to psychophysics can hardly be overestimated. We have to note here, in particular, his insistence that the psychological experiment consists simply in a carefully guided and rigidly controlled introspection, i.e. his refutation of Kant's third objection. A single instance must suffice. "The sensation," says Wundt, "contains in it no reference to the organs by whose external or internal stimulation it has been aroused; it tells us nothing of the character of its stimuli; it comes to us as a simple quality, giving no hint of any means whereby we might define that quality more nearly." In other words, the sensation is its bare qualitative self, devoid of all objective reference. When we remember that the sensation of the faculty psychology, as of the English empirical psychologists, has always been a

bit of sense-knowledge, a mental state of process that informs us of something in the outside world, we see what an advance in insight and scientific method is implied in Wundt's formulation.

The sources from which experimental psychology has drawn are manifold. It is especially indebted, for fact and for inspiration, to physics, astronomy, and the physiology of the organs of sense. The photometric investigations of Bouguer, Arago, and Masson contained hints of the constancy of the relative sensible discrimination for light intensities. The observed relation between the intensity of a star, as photometrically determined, and its apparent brightness or 'magnitude' was similarly significant. The 'error of observation' in physical measurements indicates, by its very name, the close connection of physics and psychology, and the need of the former to be supplemented by the latter. The 'personal equation' noticed by astronomers, as an inevitable source of error in their observations of stellar transits, formed the starting-point for the later elaborate researches into simple and compound reaction-times. On the other hand, a large number of professedly 'physiological' inquiries, inquiries carried out by physiologists with physiological interest, have been taken over bodily by experimental psychology. Physiology cannot deal, in strictness, with the doctrine of sensation and perception, but only with the mode of function of the sense-organs regarded as living structures. Where, however, psychological knowledge and method are in advance of physiological, the physiologist naturally seeks to fill out the gaps in his own science by making an excursion into the other. This custom has led, at times, to the mistaken belief that psychology is only a department of physiology; but, on the whole, the countervailing gain has been well worth a little misunderstanding. The inquiries of E. H. Weber into the cutaneous and muscular senses, and the spatial functions of eye and skin, have proved of fundamental importance to the science. (See WEBER'S LAW.) The studies of A. W. Volkmann on visual space perception, of H. von Helmholtz on vision and audition, of E. Hering on vision, and of S. Exner on the duration of mental processes, form some of the early links of a chain of physiological research which is still worthily continued; in the work, e.g. of H. Zwaardemaker on smell, and of A. Goldscheider on the cutaneous and muscular sensibilities. Until psychology has laboratories upon the scale of those devoted to physics and physiology, it must be in large measure dependent for exact investigations upon the representatives of these older disciplines; while, in any case, the labors of men trained in general scientific method cannot fail to be of high value in this particular field.

What, now, we may ask, are the provinces of mind which the new psychology has made peculiarly its own? In principle, there is no psychological problem that cannot be experimentally attacked. In actual fact, owing to the youth of the science, its lack of material means and of trained workers, and the extreme difficulty of its subject-matter, there are very many problems that still await the experimenter. If we are to attempt a catalogue of what has been accomplished, we must begin (1) with the fields of sensation and of sense-perception. The literature of these subjects: of vision, audition, and

the rest of the sense-qualities, of spatial and temporal perception (see DURATION; EXTENSION), and of qualitative perception (see FUSION), has already attained very considerable proportions. When Helmholtz published, in 1867, his great work on physiological optics, it seemed that he had exhausted the subject, that its difficulties were resolved, once and for all. But what was judged to be the end has proved to be only the beginning; the work of many men has accumulated and is still accumulating, bringing new facts and new questions. And as here, so elsewhere: experiment is taking us toward an exact doctrine of sensation and perception, whose complexity had, before its advent, been not so much as guessed at. (2) The psychology of attention (q.v.) may almost be termed a positive creation of the experimental method. It is strange and instructive to turn from a modern system of psychology, in which the doctrine of attention looms so large and important, to a German eighteenth-century work, or a volume of English associationism, where (except for a few scattered hints) we find no mention of it whatsoever. (3) The same thing may be said of the psychology of action. When F. C. Donders, in 1866, proposed to use the method of reaction for the measurement of mental acts like choice, discrimination, and judgment, he was building better than he knew; for the laboratory reaction, the exact type of a voluntary action, has been the chief aid toward a final analysis of the active consciousness. (4) H. Ebbinghaus's *Das Gedächtniss* (1884) brought the function of memory under experimental control, and has been followed by many monographs upon recognition and the various conditions of the reproductory consciousness. (5) Finally, the feelings are gradually submitting themselves to experimental treatment. Fechner himself laid the foundations of an exact science of experimental aesthetics (q.v.); and Mosso's researches into the bodily symptoms of affective processes have borne rich fruit. If we cannot say that experiment has given us a settled psychology of feeling, we can at least assert that the issues are more clearly marked and the problems more definitely formulated than ever before; and this means that it is only a matter of time until our questions are adequately answered.

There has been some dispute as to whether certain results of animal psychology (q.v.), of physiological experimentation on the brain cortex, of the treatment of brain disease, and of tests made upon hypnotized subjects (see HYPNOTISM) should be included under the phrase 'experimental psychology.' Such inclusion depends partly upon our definition of the word 'experiment;' experiments on animals and on hypnotic subjects are of a different order from those described above; and partly on the extensibility of the word 'psychology,' upon the point, i.e., whether all that furthers or contributes to a science is necessarily itself a part of the science. However, it is more important to note that psychology has gained or may gain from all these four sources than to find a single name for them. Consult: Titchener, *Experimental Psychology* (New York, 1901); Sanford, *Course in Experimental Psychology* (Boston, 1898).

PSYCHOMETRY (from Gk. *ψυχή*, *psychē*, breath, life, soul + *μέτρον*, *metron*, measure). A term used (1) for a supposed power, possessed

by certain 'sensitive' persons, of reading character from handwriting, or passing the fingers over the head of the subject, etc., etc. More recently, it has been used (2) as the equivalent of mental chronometry, to cover all experimental investigations into the temporal course of mental processes; but the usage is lapsing.

PSYCHOPATHOLOGY (from Gk. *ψυχή*, *psychē*, breath, life, soul + *πάθος*, *pathos*, disease + *-λογία*, *-logia*, account, from *λέγειν*, *legein*, to say). A synonym for mental pathology. The term is wider than psychiatry (q.v.), since it covers all study of the mental symptoms of disease, without special reference to therapeutics. It is narrower than abnormal psychology, since (at least in current usage) it deals only with serious mental derangement, and not with such comparatively normal abnormalities as dreaming and hypnosis.

PSYCHOPHYSICS (from Gk. *ψυχή*, *psychē*, breath, life, soul + *φυσικός*, *physikos*, physical, from *φύσις*, *physis*, nature, from *φύειν*, *phyein*, to produce; connected with Lat. *fui*, I was, Skt. *dhā*, to become, and ultimately with Eng. *be*). The science of the inter-relations of mind and body. The term was coined by Fechner to designate an exact science of the relations of dependence between the physical and psychical worlds. He discriminated an internal and an external psychophysics; in the former, sensation is considered in its direct relation to the brain and nervous system; in the latter, sensation is indirectly studied in its dependence upon external physical stimuli. No definition could be more general. We have to ascertain the facts and laws of mind, and the physiological facts and laws (of brain or of sense-organs) with which they are connected; we have to parallel the two series of events, noting how variation in the one is related to variation in the other; we have to express the functional interdependences exactly, i.e. in terms of measurement, of mathematical formulæ; and from our whole inquiry we shall attain a 'philosophical' standpoint, a theory of the general relation between the physical and psychical worlds.

Fechner is concerned, primarily, with the problem of mental measurement. And when we turn to the special portion of his *Elemente der Psychophysik*, we find that he is occupied, for the most part, with the relation between stimulus and sensation that is formulated in Weber's law (q.v.). In the quantitative expression of this relation he sees the one universal psychophysical uniformity. A regrettable result of this generalization is that the term psychophysics has been narrowed in meaning. Thus Münsterberg, finding his justification in historical usage, identifies it with the "question of the relation between stimulus and sensation;" and the *Century Dictionary* defines it as "the science of the relations between stimuli and the sensations which they evoke." Some writers go further still, and—in view of the fact that Weber's law has proved to be a law of sensation intensities—restrict psychophysics to the intensive relations between stimulus and sensation. Thus Baldwin states that "investigations in intensity constitute psychophysics." In the light of modern developments, however, we have a full right to hold to the general definition laid down by Fechner.

A word must be said in detail of the psycho-

physical measurement methods, the elaboration of which owes much to Fechner, and the understanding of which is an integral part of training in psychophysics. We cannot measure a mental process, sensation or other, as we can measure physical magnitudes; but we can measure function, sensitivity, and sensible discrimination; and we can measure the differences or distances that separate term from term within a sensation scale. There are two groups of methods by aid of which such measurements can be made. The first includes the *gradation* methods, the second the *error* methods. In the former, we approach the object of measurement by slow degrees, in order to arrive at a single accurate result; in the latter, we approach the object to a certain distance over and over again, and submit the whole number of results to mathematical treatment, in order to arrive at the required determination. The gradation methods imply, in general, a 'procedure with knowledge'; the observer knows the nature and the direction (increasing or decreasing) of the differences submitted to him for estimation; the error methods imply the 'procedure without knowledge'—the observer is left in ignorance of the conditions of the experiment. Typical of the latter class of methods is Vierordt's method of right and wrong cases. Two slightly different stimuli are laid before the observer, in a long series of experiments; and he must say, in each case, whether the sensation aroused by the second stimulus is greater (louder, brighter, longer) than, equal to, or less than the sensation aroused by the first. He does not know either the amount of difference or the order of presentation of the two impressions in the separate tests. From the distribution of the 'right,' 'wrong,' and 'equal' cases (right and wrong being determined by the objective relations of the stimuli), that stimulus difference is calculated which is able to evoke a just noticeable difference of sensation. Typical of the former class is Wundt's method of minimal changes. Two subjectively equal stimuli are taken, and the one gradually increased until it is just noticeably different from the standard. This point determined, the stronger stimulus is gradually decreased, until the point of subjective equality is reached. The differences from the standard found in these two determinations are averaged. The procedure is then repeated in the reverse direction; the one stimulus is decreased, to the point at which it is just noticeably less than the standard, and then increased again to subjective equality. The two differences are averaged as before. From the average of the two averages (the upper and lower difference limens), we obtain the value of the difference limen.

BIBLIOGRAPHY. Fechner, *Elemente der Psychophysik* (Leipzig, 1860); G. E. Müller, *Zur Grundlegung der Psychophysik* (Berlin, 1878); Münsterberg, *Beiträge zur experimentellen Psychologie* (Freiburg, 1890); Külpe, *Outlines of Psychology* (trans., London, 1895); *Archiv für Geschichte der Philosophie*, vol. vi. (Berlin, 1893); Wundt, *Physiologische Psychologie* (Leipzig, 1893); Sanford, *Course in Experimental Psychology* (Boston, 1898). See DISCRIMINATION, SENSIBLE; LIMEN.

PSYCHRÓMETER. See HYGROMETER.

PTAH, ptii. An Egyptian deity. See MEMPHIS.

PTARMIGAN (with inorganic initial *p*, from Gael. *tarmachan*, Ir. *tarmochan*, *tarmonach*, *ptarmigan*). A kind of grouse, differing from true grouse (q.v.) chiefly in having the tarsi and toes thickly clothed with short feathers. The species are natives of northern or greatly elevated regions. They are not polygamous like the true grouse, nor do the males strut with erected and expanded tail. Most of the species change color on the approach of winter, assuming at the fall molt a white or nearly white plumage, in place of the mottled reddish brown of summer. At this season also the shanks and feet acquire longer



SEASONAL CHANGE IN PTARMIGAN'S CLAWS.

s, summer condition: foot of willow ptarmigan, drawn June 10, just before the change to the short, summer claw; *w*, winter condition: the same, drawn October 18, showing full-feathered preparation for winter.

and denser feathering, and the short summer claws are shed and replaced by a growth of longer stronger claws of service in scratching away the snow to get at buried food, and the diversities of color have caused much confusion and difficulty concerning them. All are highly esteemed as food, and are valued as game-birds. Less often seen in Great Britain, but widespread, and numerous in Scandinavia and Northern Russia, whence great numbers are sent to market in winter, is a grayer species (*Lagopus mutus*). Two closely allied species, the 'rock' and the 'willow' ptarmigans, range throughout Arctic America, but do not extend southward to the United States. Along the summits of the Rocky Mountains is to be found another species (*Lagopus leucurus*) in which the tail remains white all the year round, and it is therefore called the white-tailed ptarmigan, or 'mountain quail.' All make their nests on the ground among the heather or thickets in which they pass their lives and find their food (buds, berries, leaves, and insects), and lay brown eggs very heavily blotched with brownish black. For bibliography, see GROUSE. See Plate of GROUSE, ETC.; and of EGGS of WATER AND GAME BIRDS.

PTERANODON, tēr-ān'ō-dēn (Neo-Lat., from Gk. πτερόν, *pteron*, feather, wing + ἀνόδους, *anodous*, toothless, from ἀν-, *an-*, negative prefix + ὀδούς, *odous*, tooth). A large fossil flying lizard, in fact the greatest known flying creature; found in the Cretaceous rocks of Kansas. See PTERODACTYL.

PTERASPIS, tēr-ās'pīs (Neo-Lat., from Gk. πτερόν, *pteron*, feather, wing + ἀσπίς, *aspis*, shield). One of the most primitive fossil fishes of the subclass Ostracodermi, found in the Silurian and Devonian rocks. The front part of the body was covered by dorsal and ventral shields which were made up of several heavy bony plates united by fusion of their joints. The orbits are small and are placed well forward at the very margin of the head shield. The general form of the body was shark-like, its length about four or five inches; the posterior portion was covered by small polygonal scales. See OSTRACODERMI.

PTERICHTHYS, tēr-ik'thīs (Neo-Lat., from Gk. πτερόν, *pteron*, feather, wing + ἰχθύς, *ichthys*,

fish). A genus of primitive fossil fishes of the subclass Ostracodermi, found in Devonian rocks in Great Britain and Germany. The body was from four to eight inches long, broad and high in front, with flattened ventral surface and short tapering tail. The anterior portion is inclosed in large turberculated bony plates which are firmly united to each other, those of the head shield being articulated by a hinge with those of the body shield. The orbits are placed near together on the forward slope of the head and are separated by a small plate which has on its under surface a pit for the pineal body. A cleft between the lower margin of the head shield and the front margin of the ventral body shield represents the mouth, and there have been found indistinct traces of bones that are supposed to represent the jaws. At the sides of the front of the body shield are attached two paddle-shaped jointed appendages made up of small closely fitted plates, which resemble the pectoral fins of the fishes. The tail portion, which is shorter than the armored portion of the trunk, is covered by small rounded or hexagonal scales, and has a small triangular dorsal fin and an upturned tip on the ventral side of which is a small caudal fin. A close ally of *Pterichthys* is *Bothriolepis*, found in the Upper Devonian of North America and Europe. See OSTRACODERMI.

PTERIDOPHYTES, tēr'id-ō-fīts (Neo-Lat. nom. pl., from Gk. πτερίς, *pteris*, fern + φυτόν, *phyton*, plant). The fern-plants, one of the four great divisions of the plant kingdom, next in order of rank to the highest group, the flowering or seed plants (spermatophytes). There are three great divisions of pteridophytes: (1) ferns (Filicales), (2) horsetails (Equisetales), and (3) club-mosses (Lycopodiales). The pteridophytes have a well-developed vascular system, which is entirely absent in the bryophytes, the next group

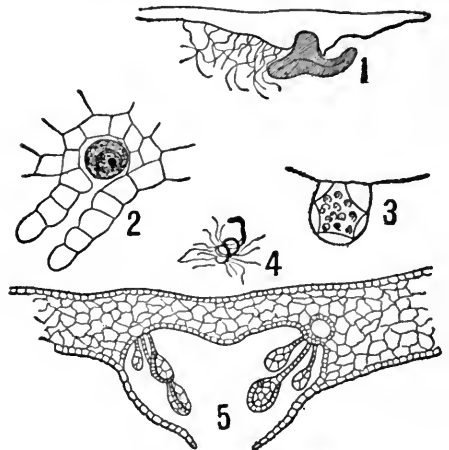
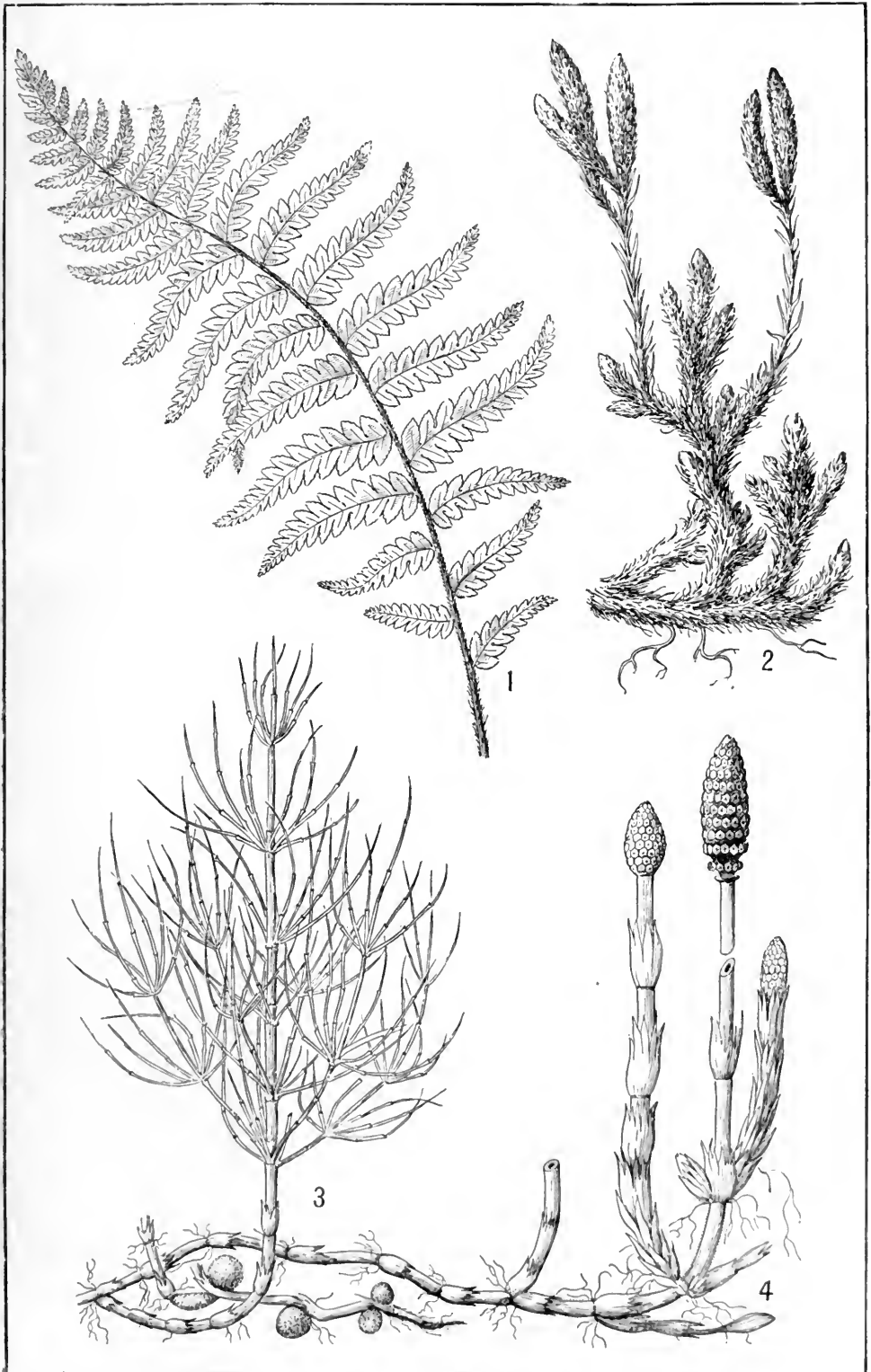

FIG. 1. STRUCTURE OF A FERN.

1, diagrammatic section showing young sporophyte (shaded) in relation to prothallium; 2, section of an archegonium; 3, section of an antheridium; 4, sperm; 5, section of two sori, showing sporangia and indusium.

below them. This system of conducting and strengthening tissues is correlated with the attainment of much greater size and larger foliage display by the fern plants than by the moss plants. It associates them with the seed plants (spermatophytes). Since plants below the seed

PTERIDOPHYTES



1. FERN 2. CLUB MOSS
3 and 4. HORSETAIL (*Equisetum*), showing sterile (3) and fertile (4) shoots.



plants are often called cryptogams, pteridophytes are often called vascular cryptogams. There is also a well-marked alternation of generations (q.v.), which may be illustrated by the life-history of a common fern. When a fern spore germinates it produces a green, flat, usually heart-shaped body (prothallium), so small that it escapes ordinary observation. This body bears the sex-organs (antheridia and archegonia, Figs. 1, 2, 3). It is therefore the sexual plant or gametophyte and is entirely independent. The egg produced and fertilized upon this prothallium (gametophyte) germinates and produces the conspicuous but sexless fern plant or sporophyte (Fig. 1), upon the under surface of the leaves of which

about 500 species and were formerly much more abundant and conspicuous, are characterized by their slender, trailing, branched stems, thickly covered by small foliage leaves, and by a strobilus consisting of sporophylls, each bearing a

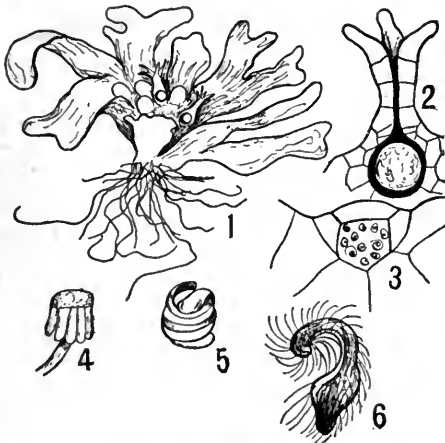

FIG. 2. STRUCTURE OF EUISETUM.

1, prothallium; 2, longitudinal section of an archegonium; 3, section of an antheridium; 4, a sporophyll with 5 sporangia visible; 5, a spore, showing elaters; 6, a sperm.

asexual spores are produced (Figs. 1, 5). When these fall to the ground and germinate they produce prothallia, and thus complete the cycle. Pteridophytes differ from bryophytes (q.v.) especially in that their gametophytes are leafless and inconspicuous, and the sporophytes are prominent, leafy, and nutritively independent of the gametophyte. Further, the sperms of pteridophytes are very large, spirally coiled, and bear numerous cilia for swimming (Figs. 1, 4).

The terms (Filicales) are the most prominent pteridophytes in the present flora, numbering about 4500 species, chiefly tropical. In habit they are mainly terrestrial, but some tropical forms are epiphytic (perching) and one aberrant group, the 'water ferns' float or are rooted in water. The peculiar characters are the horizontal subterranean stem, which sends to the surface comparatively few large leaves (fronds), dichotomously veined, usually compound, which bear on the under surface very numerous spore-cases (sporangia), and uncoil from the bud (circinate). The horsetails (Equisetales), which were formerly very abundant and included large trees, now comprise only about twenty-five small or straggling forms, well marked by their jointed and fluted stems, the absence of foliage leaves, and the terminal conical structure ('strobilus'), consisting of spore-bearing leaves (sporophylls, q.v.), each of which bears five to ten spore-cases (sporangia) on its lower surface (Fig. 2). The club-mosses (Lycopodiales), which comprise

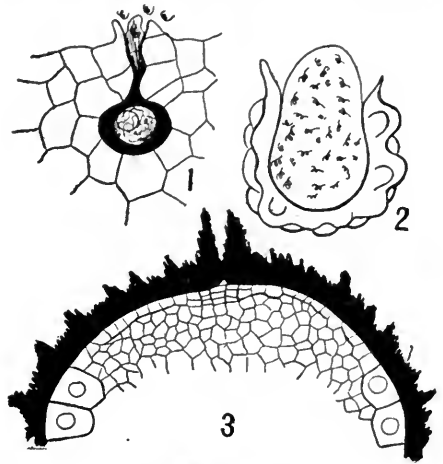

FIG. 3. SELAGINELLA.

1, archegonium with egg; 2, antheridium with sperms; 3, upper part of female gametophyte, with heavy megaspore wall.

single sporangium upon the upper side (Figs. 3 and 4). The most important feature of the group is that Selaginella, the largest genus, is heterosporous. See HETEROSPORY.

Probably the greatest interest to the botanist in connection with the pteridophytes lies in the hypothesis that seed-plants have been derived from them, to prove which has been the purpose of much inconclusive investigation. There is general consent that seed-plants have not come from

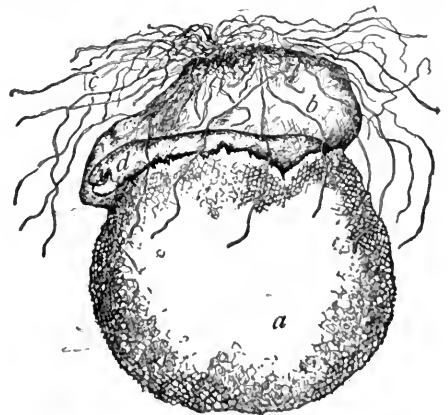

FIG. 4. SELAGINELLA.

a, megaspore; b, prothallium; c, rhizoids; d, embryo sporophyte.

the horsetails, but opinion is divided between the ferns and club-mosses as probable ancestral forms with the burden of testimony apparently in favor of the former, at least in some cases. For fuller details, see FERNS; EUISETUM; LYCOPODIALES.

Consult books cited under MORPHOLOGY, all of which treat more or less fully of this group. Also: Campbell, *Mosses and Ferns* (New York,

1895): Atkinson, *The Biology of Ferns* (New York, 1894). For works on classification, see under TAXONOMY.

PTERODACTYL, tēr'ō-dāk'til (Neo-Lat., from Gk. πτερόν, *pteron*, feather, wing + δάκτυλος, *daktylos*, finger). The common name for any one of the flying lizards, remains of which are found in the Mesozoic rocks. There are about twenty different genera of pterodactyls, all included in the order Pterosauria (wing-lizards),



1, *Dimorphodon macronyx*; 2, pteranodon, the toothless, bird-like type of jaws.

also called Ornithosauria (bird-lizards). All the members of this order show a remarkable adaptation of the lizard body to bird-like habits, though in structure they remain essentially reptilian. They cannot be considered as ancestral to the birds, for they constitute a wholly independent line of descent, probably derived from common dinosaurian ancestors, and they present



PTERODACTYLUS SPECTABILIS.

an instructive example of parallelism of evolution due to adoption by two separate races of similar modes of life. The pterodactyls have skeletons of light but firm construction with hollow bones. The earlier forms had strong, spreading teeth which gradually disappeared in successively later members of the group, and the loss of the teeth was accompanied by a corresponding increase in length and sharpness of the jaws until in the latest genera (*Pteranodon*, etc.) the jaws are dagger-like. The large eyes, surrounded by a ring of sclerotic plates, are placed well back and on the sides of the skull. The body

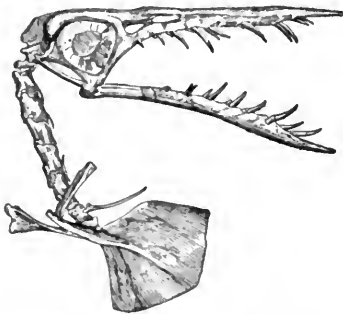

RHAMPHORHYNCHUS GEMMINGI (lithographic stone of Bavaria).

was short and rather stout, the limbs long and slender, and in the earlier forms there was a long slender tail. The wings resembled in general those of the bats rather than those of birds, for they consisted of thin but strong membranes

stretched along the sides of the body and supported by the fore and hind limbs and the tail. The structure of the fore limb is quite different, however, from that seen in bats and birds, and presents equally interesting modifications of the parts of the arm in the adaptation of the latter from a walking leg to a wing-like organ. The long bones are considerably lengthened, the first finger is sometimes represented by a sort of dew-claw, the second, third, and fourth fingers are small and slender and furnished with sharp-hooked claws, and the fifth, or 'little finger,' is greatly elongated and strengthened to form the framework along which the anterior edge of the wing membrane is attached. Impressions of these

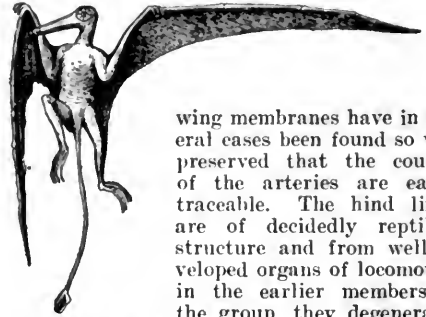

PTERODACTYL OF THE GENUS RHAMPHORHYNCHUS (restored).

wing membranes have in several cases been found so well preserved that the courses of the arteries are easily traceable. The hind limbs are of decidedly reptilian structure and from well-developed organs of locomotion in the earlier members of the group, they degenerated to weak clawed organs of prehension by which the later, more highly specialized, pterodactyls probably suspended themselves from points of rocks or from the limbs of trees after the manner of the modern bats.

The various genera range in size from less than 12 inches to about 20 feet in spread of wings. Some of them were evidently able to do little more than sail on leaping through the air, as does the flying squirrel, by means of the stretched membranes; while others were among the most powerful flying creatures that have ever lived. The principal genera are *Dimorphodon*, *Rhamphorhynchus*, *Pterodactylus*, and *Pteranodon*, or *Ornithostoma*.

BIBLIOGRAPHY. Von Zittel and Eastman, *Text-Book of Palæontology*, vol. ii. (New York and London, 1902); Woodward, *Outlines of Vertebrate Palæontology for Students of Zoology* (Cambridge, 1898); Seeley, *The Ornithosauria* (ib., 1890); id., *Dragons of the Air* (London, 1901); Zittel, "Die Flugsaurier aus dem Lithographischen Schiefer," *Palæontographica*, vol. xxix. (Berlin, 1882); Williston, "Winged Reptiles," *Popular Science Monthly*, vol. lx. (New York, 1902); Lucas, "The Greatest Flying Creature, the Great Pterodactyl, *Ornithostoma*," *Annual Report of the Smithsonian Institution* for 1901 (Washington, 1902).

PTEROPODA (Neo-Lat. nom. pl., from Gk. πτερόπους, *pteropous*, wing-footed, from πτερόν, *pteron*, feather, wing + πούς, *pous*, foot). An order of gastropod mollusks, agreeing in most of their features with the tectibranch forms like *Bulla*, etc. The head, eyes, and tentacles are usually wanting or vestigial, while on each side of the mouth are wing-like appendages, apparently a pair of greatly developed parapodia, giving the peculiar 'butterfly' appearance to these beautiful pelagic mollusks. The shell is conical or helix-like. The species are herma-

phroditic. *Limacina arctica* is of the size of, and looks like, a sweet-pea blossom, moving up and down in the water. It is common from Labrador to the polar regions. The largest form on the eastern coast of North America is the beautiful

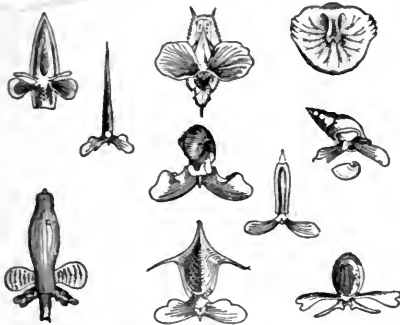

FORMS OF PTEROPODS.

Clione papilionacea, which has a head and lingual ribbon. It is an inch long, the body fleshy, with no shell, the wings being rather small. It is likely to occur in vast numbers and forms the food of whales and other large surface-feeders. (See OOZE.) The larvæ of the pteropods pass through a trochosphere stage, spherical with a ciliated crown, and afterwards assume a veliger form. (See MOLLUSCA.) The pteropods are, in some degree, a generalized type. They have a wide geographical distribution and a high antiquity. Consult authorities cited under GASTROPODA; and Von Zittel and Eastman, *Text-Book of Palæontology* (New York, 1900).

PTEROSAURIA, tēr'ō-sq'ri-á (Neo-Lat. nom. pl., from Gk. πτερόν, *pteron*, feather, wing + σαῦρος, *sauros*, lizard). An order of extinct bird-like reptiles, with hollow bones, well-formed joints, and with the fore limbs modified for use as wings. See PTERODACTYL.

PTERYLO'SIS (Neo-Lat., from *pteryla*, feather-tract, from Gk. πτερόν, *pteron*, feather, wing + ἕλη, *hylē*, wood). The method of growth of feathers in birds. The bodies of most birds

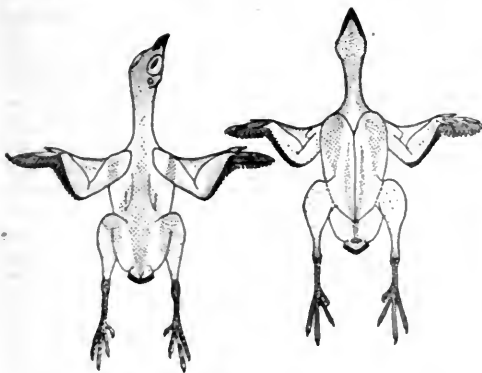

PTERYLOSIS.

Dorsal and ventral views of the body of a quail, showing feather tracts.

are not uniformly covered with feathers, such a condition being found only among the Ratitæ and the penguins. In all other birds the feathers are grouped in clearly defined areas or tracts

(pteryle) with bare spaces (apteria) between them. To this condition, which has high taxonomic value, Nitsch (Pterylographie Arum, Halle, 1840), gave the name 'pterylosis,' and to the aspect of the tracts 'pterylography.' These tracts are different in the various groups, both in extent and position; but in general it may be said that feather-growth is fairly continuous over the head and throat; along the sides of the neck; on the shoulders, wings, tail, and lower part of the thighs, occasionally extending to the toes; in a band of varying breadth and shape down the centre of the back; and in two bands down the lower side of the body, where the central line from the throat to the vent is invariably free. It is believed that pterylosis was not present in ancient birds, which primitively were feathered all over, but is an acquired trait conceived to be advantageous in economy of energy, and in making the feathers fit more snugly and lie better with reference to wind and rain. Consult a translation of Nitsch's work, edited by Sclater and published by the Ray Society, London, in 1867; also Gadov's article "Pterylosis" in Newton, *Dictionary of Birds* (New York, 1893-96).

PTINIDÆ. A family of small beetles. See DEATH-WATCH.

PTOLEMAIC (tōl'ē-mā'ik) **SYSTEM**. In astronomy, a planetary theory expounded by Ptolemy (q.v.). It was an attempt to reduce to a scientific form common and primitive notions concerning the motions of the heavenly bodies. The primary and fundamental doctrines of this system are that the earth is the centre of the universe, and that the heavenly bodies revolve round it in circles, and at a uniform rate. These notions, which are naturally suggested by the first general aspect of things, having, previous to any accurate observation, established themselves as unquestionable axioms, phenomena which were found, on closer examination, to be inconsistent with them, were explained by the introduction of additional hypotheses. In the Ptolemaic system, the earth, the most stable of the 'elements,' held the lowest place, and supported water, the second in order; above water was placed air, and then fire, ether being supposed to extend indefinitely above the others. In or beyond the ether element were certain zones or heavens, each heaven containing an immense crystalline spherical shell, the smallest inclosing the earth and its superincumbent elements, and the larger spheres inclosing the smaller. To each of those spheres was attached a heavenly body, which, by the revolution of the crystalline, was made to move round the earth. The first or innermost sphere was that of the moon, and after it in order came those of Mercury, Venus, the sun, Mars, Jupiter, Saturn, and the fixed stars, eight in all. To this system later astronomers added a ninth sphere, the motion of which should produce the precession (q.v.) of the equinoxes, and a tenth, to cause the alternation of day and night. This tenth sphere, or *primum mobile*, was supposed to revolve from east to west in 24 hours, and to carry the others along with it in its motion; but the Ptolemaic astronomers did not venture to explain how this was done, although since the axis of motion of the *primum mobile* was that of the equator, its extremities being the poles of the heavens, while that of the ninth sphere was the axis of the ecliptic, some explanation was certainly neces-

sary. As observations of the heavens increased in accuracy it was found that the heavenly motions were apparently not uniform, and this was explained as follows: The acceleration of the sun on one side, and retardation on the other side of his orbit, is only apparent, and results from the earth not being in the centre of his sphere, C (see Fig.), but at E, and consequently his mo-

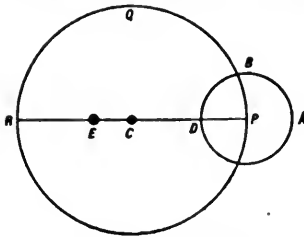

PTOLEMAIC SYSTEM.

tion appears to be slowest at P, and quickest at R. The alternate progression and regression of the planets was accounted for by supposing them to move, not directly with their crystallines, but in a small circle, whose centre was a fixed point in the crystalline, and which revolved on its axis as it was carried round with the latter; thus (Fig.) the planet was carried round the small circle ABD, as that circle was carried round PQR (now supposed to represent the planetary crystalline). The planet while in the outer portion of its small circle would thus have a forward, and in the inner portion a backward motion. The larger circle was called an *eccentric*, and the smaller an *epicycle* (q.v.). This theory of eccentrics and epicycles satisfied the early astronomers; but further investigation showed its incompleteness, and in later times it was found necessary to explain newly discovered discrepancies by heaping epicycle upon epicycle, till such a complication of the system had been produced as drew from Alfonso X. of Castile, to whom the Ptolemaic system was being explained, the remark that "if the Deity were now to reconstruct the world, he (Alfonso) could give him a few useful hints." As soon as astronomers came to understand and test the *Copernican system* the Ptolemaic system was discarded. See *COPERNICAN SYSTEM*; *GALILEO*.

PTOLEMAÏS, tōl'ē-mā'is. The Roman name of a seaport of Syria, now known as Acre (q.v.).

PTOLEMY, tōl'ē-mī (Lat. *Ptolemæus*, from Gk. Πτολεμαῖος, *Ptolemaios*). The name of sixteen kings of Egypt forming the Thirty-first or Macedonian Dynasty, which ruled from B.C. 323 to 30.

PTOLEMY I. (c.367-283 B.C.), surnamed *SOTER* ('the Preserver'), was a Macedonian, the reputed son of Lagus. He displayed marked ability as a soldier and was one of Alexander the Great's favorite generals in his Eastern campaigns. On the death of Alexander (B.C. 323) and the division of his possessions, Egypt and Libya fell to the share of Ptolemy and, while nominally only satrap of these provinces, he was from the first virtually an independent ruler. In B.C. 306 he became King in name as well as in fact. Under his able rule Egypt became a power of the first rank, Palestine and Southern Phœnicia, Cyprus, Libya, and Cyrene were included in her possessions, and Egyptian influence was paramount in the Mediterranean. The new capital, Alexandria,

soon became the foremost city of the world, both in commerce and in culture. The famous museum and library founded by Ptolemy I., and fostered by his successors, exerted a profound influence and attracted to Alexandria men of letters and of science from all parts of the Hellenistic world. The King himself was the author of a history of Alexander the Great, a work of which Arrian (about A.D. 134) made free use in the composition of his *Anabasis*. Ptolemy was a wise administrator and skillfully reconciled the opposing interests of his Greek and Egyptian subjects. In B.C. 285, after a most successful reign, he abdicated in favor of his son, Ptolemy II.

PTOLEMY II. (B.C. 308-247), surnamed *PHILADELPHUS*, the son of Ptolemy I. by Berenice, the grandniece of Antipater, was born on the island of Cos. He reigned from B.C. 285 to 247. He first married Arsinoë, the daughter of Lysimachus, King of Thrace, but eventually banished her, and, in compliance with ancient Egyptian custom, married his own sister, Arsinoë. Philadelphus undertook no great wars, and under his peaceful reign Egypt prospered greatly. The security afforded by her maritime supremacy, supported by a powerful fleet, stimulated her Mediterranean commerce to a lively activity, and a great trade developed on the Red Sea with Arabia and the Somali coast. This trade was encouraged by the establishment of new ports, by reopening the old route through the Wadi Hammamât to the Red Sea, and by planting a colony, called Ptolemais Epitheras, on the African coast near the site of the modern Suakin. A canal was also opened from the upper end of the Red Sea to the Nile. An important work, undertaken in the reign of Philadelphus, was the famous lighthouse erected on the island of Pharos, at the mouth of the harbor of Alexandria, by Sostratus the Cnidian. The Egyptian history of Manetho is reported to have been compiled at the suggestion of Philadelphus, and tradition alleges that the King caused the Hebrew scriptures to be translated into Greek by seventy (or seventy-two) elders sent from Jerusalem for the purpose. See *SEPTUAGINT*.

PTOLEMY III. (c.282-222 B.C.), surnamed *EUERGETÈS* ('the Benefactor'), was the son of Ptolemy II. by his first wife, Arsinoë, daughter of Lysimachus of Thrace. He succeeded his father in B.C. 247, and reigned until B.C. 222. He married Berenice, daughter of Magas, the stepson of Ptolemy I., who brought Cyrene as her dowry. In the beginning of his reign he made war upon Syria to avenge the murder of his sister Berenice, widow of Antiochus Theos. Ptolemy overran the Seleucid dominions as far as Babylon and Susa, but, after an absence of three years, he was called home by the news of domestic disturbances. He brought with him an immense booty, which included the images of the Egyptian gods carried away by Cambyses. It was the restoration of these images to their proper temples that gained for the King his title *Euergetes*, and furnished the motive for the decree passed in his honor by the Egyptian priesthood in B.C. 238. (See *DECREE OF CANOPUS*.) The result of the war placed Ptolemy in possession of all Cœle-Syria, together with Damascus and the port of Antioch, and gave him the control of the sea up to the Hellespont and the coasts of Thrace. He wisely made no attempt to hold the more distant Asiatic possessions of the Seleucid

Empire. Euergetes was a liberal patron of the arts and of literature, and added considerably to the collections of the Alexandrian Library. The splendid Temple of Edfu (q.v.) was planned and begun by him, and he also built at Karnak, Philæ, Esne, Canopus, and other places. In his reign Egypt reached the highest point of military glory, prosperity, and wealth.

PTOLEMY IV. (c.244-205 B.C.), surnamed **PHILOPATOR**, the son of Ptolemy III. by his wife Berenice, reigned from B.C. 222 to 205. He married his sister Arsinoë about B.C. 212. Philopator, who is said by Polybius to have been addicted to drunkenness and debauchery, was throughout his reign under the influence of unscrupulous favorites. The murder of his mother, Berenice, and of his brother Magas, shortly after his accession, was due to the machinations of his minister Sosibius, and later he fell under the influence of his mistress Agathoclea and her brother Agathocles, who caused the murder of his wife Arsinoë. In the early part of Philopator's reign Antiochus III. seized many of the Egyptian possessions in Syria, and in B.C. 218 defeated an Egyptian army sent against him. The following year Ptolemy took the field in person, and signally defeated Antiochus at Raphia. Although he allowed his defeated antagonist easy terms, he secured the quiet possession of the Syrian provinces for the rest of his life. Philopator, like most of his family, had strong literary tastes. He wrote a tragedy called *Adonis*, and built a temple to Homer at the King of poets. The beautiful Temple of Deir-el-Medneh is his work, and he also built at Assuan, Edfu, and other places.

PTOLEMY V. (B.C. 210-181), surnamed **EPHAPHANES** ('the Illustrious'), who reigned from B.C. 205 to 181, was only five years old when he succeeded his father, Philopator. Antiochus the Great of Syria and Philip V. of Macedonia took advantage of his minority to seize upon the foreign possessions of Egypt, and Antiochus actually made himself master of Cœle-Syria and Palestine, and threatened Egypt itself. Through the intervention of Rome, however, the war was stopped, and Antiochus betrothed his daughter Cleopatra to the young Ptolemy (B.C. 198). Epiphanes was declared of age in B.C. 196, and his coronation was celebrated with unusual splendor. It was on this occasion that the Egyptian priesthood published the decree which forms the inscription on the famous Rosetta Stone (q.v.). In 193 Epiphanes married Cleopatra, and the revenues of Cœle-Syria and Palestine were given as her dowry, but her father garrisoned these provinces with his own troops and they were practically lost to Egypt. In B.C. 181 Epiphanes was poisoned by some of his followers while he was making preparations for a war against Seleucus IV., the son and successor of Antiochus the Great, in order to recover Cœle-Syria.

PTOLEMY VI. (c.191-181 B.C.), surnamed **EUPATOR**, the eldest son of Epiphanes, seems to have reigned for a few months, at most, after his father's death, but nothing is known in regard to him.

PTOLEMY VII. (c.188-146 B.C.), surnamed **PHILOMETOR**, was the son of Epiphanes and his Syrian wife, Cleopatra, and reigned from B.C. 181 to 146. He was a mere child at the time of his accession, and his mother, a woman of remarkable ability, ruled the country during his mi-

nority. She died in B.C. 173, the year of her son's coronation, and a quarrel arose about her dowry. In the war which ensued, Antiochus IV. invaded Egypt, defeated the Egyptian forces near Pelusium, and had himself proclaimed King at Memphis. The young King was made prisoner, but his brother, afterwards Ptolemy IX., gathered an army, assumed the royal title, and successfully defended Alexandria. Antiochus retired to Syria, but soon invaded Egypt again, and would probably have made himself master of the country had not the Roman envoy, M. Popilius Lænas, ordered him back to his kingdom. The two Ptolemies ruled together until B.C. 163, when they quarrelled and Philometor was obliged to flee to Rome for protection. By arrangement, the government of Egypt proper was restored to him, and his brother was made King of Cyrene. In B.C. 146 Philometor was killed in battle against the Syrian usurper Alexander Balas.

PTOLEMY VIII. (c.148-146 B.C.), surnamed **EUPATOR II.** or **NEOS PHILOPATOR**, was the son of Ptolemy VII., and, although a child at his father's death, was proclaimed King by his mother. The claim was resisted by his uncle Ptolemy IX., who marched upon Alexandria with an army, but the dispute was settled by agreement. Ptolemy IX. obtained the throne and married his brother's widow, and the young King was murdered after a nominal reign of a few months.

PTOLEMY IX. (c.184-117 B.C.), surnamed **EUERGETES II.**, and nicknamed **Physcon** ('fat-paunch') is reported by Greek writers to have been a monster of cruelty and licentiousness, but the charges against him seem to have been exaggerated. His reign (B.C. 146-117) was, on the whole, able. His marriage with his brother's widow, Cleopatra, was a political necessity, and not long afterwards he married his niece, also named Cleopatra, daughter of Ptolemy VII. In B.C. 130 he was expelled from Egypt by a revolution headed by his wife, the elder Cleopatra, but two years later he returned to Alexandria and resumed the rule of the country. He exhibited great activity in repairing and restoring the temples of Egypt, and maintained the great Library of Alexandria in a worthy manner. He possessed some literary ability, and wrote a collection of memoirs in 24 books.

PTOLEMY X. (?-B.C. 81), surnamed **SOTER II.** or **LATHYRUS**, was the son of Ptolemy IX. He ruled jointly with his mother, Cleopatra, from B.C. 117 to 106, when he was driven from Egypt by a revolution and took up his abode in Cyprus. Cleopatra, to whose influence his expulsion was due, summoned her younger son, Ptolemy XI., to Egypt and appointed him co-regent. In the meantime Ptolemy X. made himself master of Cyprus and ruled there until recalled to Egypt in the year 88. The latter part of his reign was marked by a serious rebellion at Thebes which lasted for nearly three years and was put down with great difficulty. He died in B.C. 81. Soter II., before his accession to the throne, had married his sister, Cleopatra, but was forced by his mother to put her away and marry his younger sister, Selene.

PTOLEMY XI. (?-B.C. 88), surnamed **ALEXANDER I.**, was the brother of Ptolemy X., and was placed on the throne by his mother, Cleopatra, in B.C. 106, after the expulsion of her elder son. In B.C. 101, fearing that his mother was planning his death, he caused her to be murdered. In B.C. 88

he was driven from Egypt by a revolution, and was killed in an unsuccessful attack on Cyprus.

PTOLEMY XII. (c.105-80 B.C.), surnamed ALEXANDER II., was the son of Ptolemy XI. by an unknown mother. He was living at Rome at the time of the death of his uncle, Ptolemy X. The latter's daughter, Cleopatra-Berenice, widow of her uncle, Ptolemy XI., and stepmother of Alexander II., succeeded to her father's throne, and Sulla advised Alexander II. to marry his stepmother and thus make himself King of Egypt. The marriage was arranged, but when the King and his wife had reigned together for nineteen days, the Queen was murdered by her husband. This cruel deed so enraged the army that they rose against Alexander II. and put him to death. With him the legitimate line of the Ptolemies came to an end.

PTOLEMY XIII. (c.95-51 B.C.), surnamed NEOS DIONYSUS or AULETES ('the Piper'), was a natural son of Ptolemy X., Soter II., and after the death of Ptolemy XII. possessed himself of the throne without opposition. He reigned from B.C. 80 to 51. He was addicted to every kind of vice and debauchery. He was a skilled performer on the lute, and frequently competed for the prize in musical contests with professionals. He maintained friendly relations with Rome; when he died he left his kingdom to his daughter, Cleopatra, and his elder son, Ptolemy XIV., who was to marry his sister, and appointed the Roman people his executors.

PTOLEMY XIV. (c.61-47 B.C.), surnamed DIONYSUS, married his sister, the famous Cleopatra (q.v.), and ruled jointly with her from B.C. 51 to 48, when a dispute arose and the Queen was obliged to leave Egypt. In B.C. 47 Caesar sent troops to support her cause and Ptolemy was defeated. He was accidentally drowned while trying to escape.

PTOLEMY XV. (c.58-45 B.C.), the younger son of Auletes, became the nominal husband of his sister Cleopatra in B.C. 47, and was co-regent with her for two years, when she murdered him to make room for her son Cæsarion.

PTOLEMY XVI. (B.C. 47-30), called CÆSARION, was the son of Cleopatra by Julius Cæsar and was nominally co-regent with his mother from B.C. 45 until her death. After the battle of Actium Cleopatra endeavored to secure his safety by sending him out of the country, but he was betrayed to Octavius, who caused him to be put to death.

Consult: Strack, *Die Dynastie der Ptolemäer* (Berlin, 1897); Mahaffy, *The Empire of the Ptolemies* (London, 1895); *A History of Egypt Under the Ptolemaic Dynasty* (New York, 1899); Meyer, *Das Heerwesen der Ptolemäer und Römer in Ägypten* (Leipzig, 1900); Budge, *A History of Egypt* (New York, 1902). The last-named work contains a full bibliography of the subject. See also the section on *Ancient History* under EGYPT.

PTOLEMY (CLAUDIUS PTOLEMÆUS). An ancient astronomer and geographer. He was a native of Egypt, though it is uncertain whether he was born at Pelusium or at Ptolemais in the Thebaid. Nothing is known of his personal history, except that he flourished in Alexandria in A.D. 139 and there is probable evidence of his having been alive in A.D. 161. Ptolemy, both as an astronomer and geographer,

held supreme sway over the minds of almost all the scientific men from his own time down to the close of the Middle Ages; but, and in astronomy especially, he seems to have been not so much an independent investigator as a corrector and improver of the work of his predecessors. In astronomy he had the labors of Hipparchus to guide him; and, indeed, he scrupulously distinguishes between Hipparchus's labors and his own. To Ptolemy belongs the invention of a planetary theory, the discovery of the moon's evection (q.v.), and the singular distinction of being the sole existing authority on the subject of ancient astronomy. From this last-mentioned fact, the system of astronomy which he sets forth in the *Μεγάλη Σύνταξις τῆς Ἀστρονομίας* commonly known by the mediæval title *Almagest* (q.v.) received his name, and, as the *Ptolemaic system* (q.v.), obtained the homage of succeeding generations till the time of Copernicus.

The *Almagest* is divided into thirteen books, and the trigonometry of the Greeks is known almost entirely through this work of the second century. It shows that the Greeks were then confined to the sexagesimal system and used tables of whose chords instead of half-chords. Book i. contains all that can be regarded as pure theory. It contains a method for calculating chords; the fundamental theorem in rectilinear trigonometry, that the rectangle of the diagonals of an inscribed quadrilateral equals the sum of the rectangles of the pairs of opposite sides; and the principles of spherical geometry and trigonometry sufficient to construct a table of the sun's declination to each degree of longitude. The further mathematical work of the *Almagest* consists of applications of the geometry and trigonometry of Book i.

As a geographer, Ptolemy appears as the corrector and improver of the works of a predecessor, Marinus of Tyre, about whom, except from Ptolemy's writings, little is known. His *Γεωγραφικὴ Ἐπιπέγησις*, is divided into eight books, all of which, with the exception of the first, eighth, and a portion of the seventh, are nothing more than a catalogue of places, with their latitude and longitude (to 12ths of a degree), with a brief general description prefixed to each continent and country or tribe, and interspersed here and there with remarks of a miscellaneous character on any point of interest. The rest of the work contains details regarding his mode of noting the positions of places, by latitude (*μῆκος*) and longitude (*πλάτος*) with the calculation of the size of the sphere of the earth, and of the extent of surface then known. He also describes the mode adopted by him of projecting the surface of a hemisphere on a flat surface, and shows its superiority over the projections of Eratosthenes, Hipparchus, and Marinus. He constructed a series of twenty-six maps, together with a general map of the world, in illustration of his work.

The chief of his writings, besides those already mentioned, are: *Τετραβιβλος Σύνταξις*, with which is combined another work, called *Κάρπος* or *Centiloquium*, from its containing a hundred aphorisms, both works treating of astrological subjects, and held by some on this account to be of doubtful genuineness; *Φάσεις ἀπλανῶν ἀστέρων καὶ συναγωγὴ ἐπισημασειῶν*, a treatise on the phenomena of the fixed stars, or a species of almanac. The rest of his works are of inferior im-

portance, and consist of descriptions of various kinds of projections (q.v.), the theory of the musical scale, chronological and metaphysical treatises, and a summary of the hypotheses employed in his great work, the *Almagest*. Others of Ptolemy's works have been lost, and it is still a moot point whether or not they contained a treatise on optics, as a Latin version of what is said to have been an Arabic translation of Ptolemy's original treatise on that subject is still in existence.

The *Almagest* and the *Geography* were the standard text-books to succeeding ages, the first till the time of Copernicus, the second till the great maritime discoveries of the fifteenth century showed its deficiencies. They have passed through numerous editions, the best of which are, for the *Almagest* and most of Ptolemy's minor works, that by Hialma (Paris, 1813-16-19-20); and for the *Geography*, the Latin versions of 1482 and 1490, published at Rome, the *editio princeps* of the Greek text by Erasmus (Basel, 1533), and the Elzevir edition (Leyden, 1619). The catalogue of stars has been frequently reprinted separately, the last and best edition being that of Francis Baily, vol. xiii. of the *Memoirs of the Royal Astronomical Society* (London, 1843).

PTOMAINES, τῳμᾶνζ (from Gk. πτώμα, *ptōma*, corpse, from πίπτειν, *piptein*, to fall; connected with πέτεσθαι, *petesthai*, to fly, Lat. *petere*, to attack, seek, Skt. *pat*, to fly, fall). A name applied to a class of poisonous organic substances of animal origin, extremely similar in their chemical and physical properties and physiological action to the vegetable alkaloids. The similarity of the ptomaines and the alkaloids is important inasmuch as it throws doubt on the results of post-mortem analyses for the detection of vegetable poisons administered during life. Ptomaines are among the characteristic products of the putrefactive changes taking place in the body after death. It seems, however, that these poisons cannot be detected before the expiration of about two days after death. If therefore analysis should reveal the existence of poisonous matter before that time, the conclusion would be that it had been administered during life; but if the analytical tests should be applied after the lapse of two days, the results would be subject to serious doubt. The effects that often follow from using bad fish or canned meat are probably due to the action of ptomaines. There is also increasing evidence that the symptoms of many diseases are caused, not by the specific micro-organisms themselves, but by the ptomaines produced by them. Chemically the ptomaines are amines; that is to say, they contain one or more NH_2 groups attached to hydrocarbon radicles. Following are a few of the more important ptomaines known:

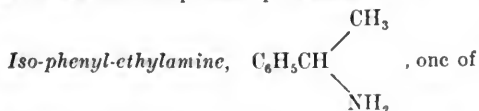

the products of the pancreatic putrefaction of gelatin, was isolated by Nencki in 1876.

Cadaverine, penta-methylene-diamine, $\text{NH}_2(\text{CH}_2)_5\text{NH}_2$, is found in corpses during the earlier stages of putrefactive decomposition; it is a liquid solidifying to a crystalline mass at low temperatures and forming crystalline compounds with acids and with certain salts.

Putrescine, tetra-methylene-diamine, NH_2

$(\text{CH}_2)_4\text{NH}_2$, is found in considerable quantities in putrid herrings and in corpses during the latter stages of putrefactive decomposition; it is, like cadaverin, a liquid crystallizing in the cold and combining with acids and certain salts to form crystalline compounds.

Choline, trimethyl-oxyethyl-ammonium hydroxide, $(\text{CH}_3)_3\text{N}(\text{OH})\text{CH}_2\text{CH}_2\text{OH}$, is found among the products of decomposition of pig's or ox bile; it is a thick, colorless liquid readily decomposing if mixed with water and heated; it acts as a strong base, forming deliquescent salts with acid, and also crystalline compounds with certain salts. It may be prepared from the yolk of eggs by decomposing the lecithin of the latter as follows: the yolk is carefully extracted with alcohol and ether, and the residue is boiled with caustic baryta; on precipitating the barium with carbonic acid and filtering, the solution is evaporated and the residue extracted with absolute alcohol, from which the choline is precipitated in the form of its platinum-chloride salt and the latter is decomposed with sulphureted hydrogen. Wurtz succeeded in preparing choline synthetically.

Neurine, trimethyl-vinyl-ammonium-hydroxide, $(\text{CH}_3)_3\text{N}(\text{OH})\text{CH}=\text{CH}_2$, is chemically similar to choline, from which it may be prepared; it is a highly poisonous liquid ptomaine, forming crystalline compounds with acids and with certain salts; it is a common product of the putrefaction of meat.

PTOSIS (Neo-Lat., from Gk. πτώσις, fall, from πίπτειν, *piptein*, to fall). A falling; a prolapse. Ptoxis is the term commonly used of a falling of the eyelid. (See EYE, DISEASES OF). Enterptosis is a prolapse of the intestines into a lower plane than normal, owing to laxity of the abdominal walls. Gastroptosis is a falling of the stomach, which occurs in cases of retention of food in that organ, whereby it is weighted heavily, and also in cases in which the walls of the viscus are weak.

PUBERTY (Lat. *pubertas*, from *puber*, *pubes*, mature). The period of life at which the generative organs of the male or female become capable of exercising the function of reproduction. The term is also applied to the changes in the special organs and the general system that accompany the onset of this period. Sexual maturity is reached earlier in warm climates. The age at which puberty commences in temperate zones is, in males, between sixteen and eighteen; in females, between fourteen and sixteen; but it cannot be reckoned by age alone, and is influenced by national or hereditary peculiarities and by some diseases. The changes noted in the male at puberty are a development of the larynx with the 'breaking' and deepening of the voice, a growth of hair about the face, pubes, and other parts of the body; the fuller development of the sexual apparatus, with secretion of the seminal and accessory fluids; and finally the appearance of sexual instincts and inclinations. In the female, physical and functional maturity are almost contemporaneous, and functional womanhood ceases suddenly at the menopause or climacteric. The change most characteristic of puberty in the female is the appearance of the menses, but besides this there are development of the breasts, ovaries, uterus, and external genital organs, and changes in the bony pelvis. In

both sexes there is a rapid increase in size and weight. This period is critical in the life of the individual. Hereditary diseases are apt to declare themselves at this time, and many mental and nervous disturbances take place.

PUBLICANI (Lat., tax-gatherers). In ancient Rome, the farmers of the public revenues (*rectigalia*). These revenues were put up to auction by the censors and were sold for a period of five years. They were derived chiefly from tolls, tithes, harbor-duties, *scriptura* (the tax paid for the use of public pasture-lands), mining and salt duties. As the State required the publicani to give security for the sum at which they had purchased the collecting of the taxes, and as this sum was usually much greater than the wealth of any single individual, companies were formed, the members of which were enabled to carry on conjointly undertakings far beyond the capabilities of the separate shareholders. Their contract with the Roman Government was made in the name of a single person, who was called *maniceps*, and who was held responsible for his *socii* to the State. Only Roman citizens were eligible as publicani. As in France before the Revolution, the farming of revenues resulted in great injustice and peculation, especially in outlying provinces; and the publicans were a bitterly hated class, as appears in numerous passages of the New Testament.

PUBLIC BATHS. See BATH-HOUSES, MUNICIPAL.

PUBLIC CALLINGS. Any trade or calling carried on by a private individual or private corporation which, because of its quasi public character, has certain privileges as well as legal obligations which do not attach to an ordinary private trade or calling. The business of common carriers and that of innkeepers are examples of public callings. The essential characteristics of public callings are that those engaged in them hold themselves out as engaged in the business of serving the public indiscriminately.

From the earliest time the common law held that the classes of business carried on by common carriers, innkeepers, truckmen, ferrymen, bakers, millers, and wharfingers were, or under proper conditions might be, public callings. And in later times the courts have held that the businesses of telegraph and telephone companies, elevator companies, and warehousemen were public callings. In general it may be said that all who engage in public callings must serve the public without discrimination for reasonable compensation, and with a high degree of care for the persons and property of those who engage their services. This rule, however, is subject to the limitation that the person claiming the public service must be a proper person to receive it. Those engaged in public callings in return for their obligation to serve all persons properly entitled to service have the compensating advantage that they either have a lien for their services or may claim payment or compensation in advance. They also have the right to make and enforce reasonable regulations governing the conduct of their business.

When a business is affected with a public interest, and thus becomes a public calling, it ceases to be *juris privati* only, and is subject, within reasonable limits, to the right of the State

to regulate it. See CARRIER, COMMON; INN-KEEPER; CONSTITUTIONAL LAW.

PUBLIC COMFORT STATIONS. These conveniences, often including lavatories and water-closets, are numerous in most of the larger European cities, but are entirely lacking, except in parks, in all but a very few American cities. In Europe a slight charge is usually made for their use, though in many cases they are absolutely free. Boston, New York, and San Francisco have entered upon the work of establishing public comfort stations. In Boston in 1902 the bath department had charge of twelve public water-closets in various parts of the city. The underground structure on the Common had an average daily attendance of 6000. In San Francisco a commodious public convenience was built in 1903, by the Merchants' Association and given to the city. In New York a committee previously appointed by the Mayor issued, in January, 1897, an exhaustive report on public baths and public comfort stations. The report recommended that public comfort stations should be built, and several have been established.

Consult chapter on "Public Baths and Water-Closets" in Baker, *Municipal Engineering and Sanitation* (New York, 1902). See also the report on *Public Baths and Public Comfort Stations* (New York, 1897), referred to in the text.

PUBLIC DOMAIN OF THE UNITED STATES. For a discussion of the surveys made upon the national domain, see SURVEYING. See also LANDS, PUBLIC.

PUBLIC FUND. The money in the hands of an officer of a government to be employed for governmental purposes. Public funds are raised by taxation in various forms, and the accumulation of public revenues from any source. A State treasurer may have the public money credited to different 'funds,' as the 'school fund,' etc., and usually has no authority to transfer money from a fund raised for a certain purpose to another fund to be employed for an entirely different purpose. See TAXATION; and the authorities there referred to.

PUBLIC LAW. That branch of the law which defines and protects the rights which subsist between State and subject, as distinguished from that which affects the rights that subsist between subject and subject. In public law the State, which defines and protects the right, is a party interested in or affected by the right, and may, therefore, uphold or extinguish it. The conception of public law, as opposed to private law, is due to the Roman law, in which the law of crime was included under the same head; and the civil law of the Continent of Europe retains the same classification.

The field of public law may be divided in accordance with the same distinctions which apply in the subdivision of private law; and the same distinctions may be made between substantive and adjective law, rights *in rem* and rights *in personam*, rights antecedent and remedial, and rights normal and abnormal. The connection and reciprocal relations of these parts of the public law to each other have not yet become well settled; and among modern civil law jurists they have been very differently and rather loosely treated.

The topics under which public law is most commonly treated are constitutional law, or that which defines the form of government; adminis-

trative law, or that branch which prescribes the manner in which the various political powers of the State shall be exercised within the Constitution; criminal law, or that branch which contains the rules affecting injuries to itself and disobedience to the rules laid down for the common welfare, and the penalties to be inflicted for violations of the same; and criminal procedure, also called adjective criminal law, or those rules of law affecting the bringing of criminals to justice. Besides these usual subdivisions of public law two other important divisions have been made comprising the quasi rights and quasi duties of the State as a juristic or artificial person against or in favor of natural persons, and the procedure relating to the State in this capacity, or the body of law prescribing the mode in which the State may sue and be sued. These rights of the State are irrespective of, and in addition to, those which belong to the right of eminent domain, and are those which govern it, as, for instance, a landed proprietor, the owner of personal property used in or about public buildings or of manufacturing establishments, a contractor in engineering operation, a banker issuing promissory notes, a legatee under a will, etc. Its rights and liabilities under many of these heads are different from those of individuals or other artificial persons, especially with reference to liabilities for injuries done by its servants, and as to the barring of its rights by prescription. The procedure provided for when the State is a party is not essentially the same for both the parties, as in private law; but is relatively abnormal, and takes different forms according to whether the suit is against the subject by the State, or vice versa.

For a discussion of the details of the various branches of public law see the titles CONSTITUTIONAL LAW; ADMINISTRATIVE LAW; LAW, CRIMINAL; PROCEDURE; PLEADING; COURTS; etc., and consult the authorities referred to under those titles.

PUBLICOLA, PUBLIUS VALERIUS (?-B.C. 503). A Roman consul, described by Livy and Plutarch as a magnanimous patriot. He bore a chief part in expelling the Tarquins. After the death of his colleague, Junius Brutus, having heard of the suspicions of the people that he was aiming at despotic power, he demolished in the night a palatial edifice which he had reared, and ordered that the fasces which were carried before him as the emblem of power should be lowered when he came before the people. By his efforts, stringent laws were enacted to protect the liberties of the citizens. It was decreed that persons convicted of crime should have the right of appeal from the consuls to the people, and that whoever attempted to be king might be slain by any man at any time. The surname of *Publicola* (or, in its older form, *Poplicola*), 'friend of the people,' was conferred upon him and his descendants. He was thrice elected consul.

PUBLIC POLICY. That principle of the law which holds that no person can lawfully do that which has a tendency to be injurious to the public or against the public good. The earliest trace of this principle in English law reports is found in a case decided in the second year of the reign of Henry V. (1414). A dyer had contracted not to use his art within a certain town for six months. He did exercise his art there within the time limit, and was sued for breach

of his contract. When the case came before the court, Mr. Justice Hull is reported to have been uncommonly angry at the plaintiff, and to have declared with an oath that had the plaintiff been present he should have gone to prison for daring to restrain the liberty of the defendant. He went upon the maxim that it was not good for the realm—that it was against public policy—for men to bind themselves not to exercise their trade. Two hundred years later Mr. Justice Anderson cited this decision in holding a similar contract void; declaring such a contract to be "against the law, against the liberty of the freeman, and against the commonwealth;" adding that defendant might as well bind himself not to go to church. About the same time, a contract by a land-owner that he would not sow his land for a certain period was adjudged void as "tending to the inconvenience and prejudice of the State." The principle announced in these early cases has never since been repudiated, although its application to particular contracts in *restraint of trade* (q.v.) has varied with changing business conditions and public opinion.

The wisdom of the principle has been doubted by eminent judges. One has said that "public policy is a very unruly horse, and when once you get astride it you never know where it will carry you." Another has said that "public policy does not admit of definition and is not easily explained." Still another has declared that public policy, which he defines to mean "the prevailing opinion from time to time of wise men," is "an excellent principle, no doubt, for legislators to adopt, but a most dangerous one for judges." A fourth has denounced the term as "vague, unsatisfactory, and calculated to lead to uncertainty and error when applied to the decision of legal rights. It is the province of the statesman and not the lawyer to discuss, and of the legislature to determine, what is best for the public good, and to provide for it by proper enactments. It is the province of the judge to expound the law only, not to speculate upon what is the best, in his opinion, for the advantage of the community." Notwithstanding these criticisms, the principle continues to hold an important place, especially in the law of contract (q.v.). It has not the broad sweep given to it by Lord Hardwicke and his contemporaries, a century and a half ago, when he remarked: "Political arguments, in the fullest sense of the word as they concern the government of the nation, must have great weight in the consideration of this court, and though there may be no bad faith in contracts as to other persons, yet if the rest of mankind are concerned as well as the parties, it may properly be said that it regards the public utility." The present view of the subject is well expressed in a modern English decision, as follows: "You have this paramount public policy to consider, that you are not lightly to interfere with the freedom of contract."

As already remarked, the earliest application of the principle was to contracts in restraint of trade. It was next applied in cases of champerty (q.v.) and to maintenance (q.v.). It is rarely invoked in the latter cases at present.

Another class of contracts to which the principle was early applied was that of wagers. Indeed, Sir Frederick Pollock has expressed the opinion that the doctrine of public policy, so far as regards its assertion in a general form in

modern times, arose from wagers being allowed actionable at common law. The validity of such contracts having been admitted, courts set to work to discourage them as much as possible by holding many of them to be against public policy.

Contracts promotive of immorality have always been deemed subversive of public utility and hence void. Agreements in restraint of marriage, wagers that one will not marry, and marriage brokerage contracts, or agreements to bring about the marriage of a particular person, have been held void because against sound public policy. This principle has been applied, also, in avoiding agreements for the sale of offices and for the assignment of officers' salaries, as tending to injure the public service; in avoiding agreements with an alien enemy as well as those which are hostile to a friendly country, such contracts having a tendency either to harm our country directly or to embroil us with other nations. Most frequently of all, perhaps, it is applied in avoiding contracts for the stiling of criminal prosecutions, or the perversion of justice in civil suits, or for services in lobbying with legislators, or improperly influencing administrative officers. Combinations between business houses or corporations entered into for the purpose of preventing honest competition, or the creation of monopolies, are void as against public policy. (See TRUST.) Consult: Pollock, *Principles of Contracts* (London, 1902); Anson, *Principles of the English Law of Contracts* (London, 1901); Greenwood, *Doctrine of Public Policy in the Law of Contracts* (Chicago, 1886).

PUBLIC SCHOOLS. A term usually applied in the United States to the institutions maintained at public expense for the formal education of children. The idea of organizing schools where rich and poor might obtain efficient free instruction did not take firm root in the minds of the people of the several States until the early part of the nineteenth century, although even the earliest settlers of the colonies were not unmindful of their duty with respect to the education of the young. In 1647 a law was passed in Massachusetts requiring every town of fifty householders to maintain a master to teach reading and writing, and every town of one hundred householders to maintain a grammar school, the wages of such master to be paid by parents whose children took advantage of the instruction. A somewhat similar law was passed in Connecticut in 1650. In most of the New England colonies education was considered a public responsibility. New York, on the contrary, owing to the wrangling between the Dutch and English, was rather late in recognizing the necessity for a public school system; comparatively little attention, in fact, having been paid to the subject before the close of the Revolution. The same is true of Pennsylvania, which depended mostly on private benefactions for the establishment of schools. New Jersey, on the other hand, passed a law in 1693 looking to the establishment of schools. In the South there were no school systems previous to the Revolution. What was done in the way of education was chiefly the result of private enterprise. The four decades following the Revolution form the transitional period. Local autonomy gradually gave way to centralization and State supervision, this process varying, of course, with local condi-

tions. The Federal Government was from the very beginning doing much by means of land grants and other aid to encourage the several States in the establishment of school systems, setting aside in 1785 and 1787 one thirty-sixth of all the public land in the several States for school purposes. In 1795, at the instance of Governor Clinton, a law was enacted in New York providing for local school supervision, and in 1812 the office of State superintendent of common schools was created, Gideon Hawley holding it until 1821, when the office was unfortunately abolished and the Secretary of State was nominally left to carry out the duties of superintending schools. It was not until 1854 that the office was revived. In Massachusetts the Board of Education was organized in 1837, and the various school organizations were united and correlated, the moving spirit in this work being Horace Mann (q.v.). The other States followed the example of New York and Massachusetts. Connecticut and Rhode Island found a leader in Henry Barnard. In this successful movement for public schools no little credit is to be assigned to the efforts of the various educational associations, particularly the National Educational Association.

The three main types of public schools in the United States are: (1) the city elementary and high schools; (2) the town union school, which includes a high school department; (3) the district school, so called from its usually being established in certain rural districts, and offering elementary instruction. As a rule, little attention is paid in these district schools to grading. The general tendency is growing now toward the establishment of public institutions for dependent children, truants, and incorrigibles, where, in connection with industrial training, the elementary branches are taught. In 1900 the attendance of the elementary schools was about 15,900,000, about 1,300,000 attending private schools. The term public schools is anomalously used in England to denote the several famous preparatory schools, as Eton, Harrow, and Rugby. For details of the various systems of public instruction in the United States and the principal European countries, see SCHOOLS; COMMON SCHOOLS; GRAMMAR SCHOOLS; EVENING SCHOOLS; EDUCATION; PRIMARY EDUCATION; NATIONAL EDUCATION, SYSTEMS OF.

PUBLIC WASH-HOUSES. See WASH-HOUSES, PUBLIC.

PUBLILIUS SYRUS. A Roman writer of mimes. He was a native of Syria. He was brought to Rome when a boy as a slave; but his master was kind, educated him, and finally gave him his freedom. He excelled in writing mimes, which were in great vogue at Rome in the latter times of the Republic. Julius Cæsar gave him the preference over all other mimographers. His works are lost, but some of his moral apothegms, which have been preserved by Seneca and other ancient writers, are remarkable for their laconic precision and justness of sense. These have been gathered under the title *Publili Syri Mimi Sententiæ*, and were published by Meyer (Leipzig, 1880) and Friedrich (Berlin, 1880).

PUBLIUS. The signature used by Hamilton, Jay, and Madison in their papers contributed to the *Federalist*. Papers 2-5 and 64 were written

by Jay; 10, 14, 18-20, 37-63 by Madison; and the remainder by Hamilton.

PUCCINIA, pük-sin't-á (Neo-Lat., named in honor of *Puccini*, an Italian anatomist). A genus of fungi, the best known species of which is probably *Puccinia graminis*, wheat rust, which passes part of its life upon the barberry (q.v.). See RUST.

PUCCOON' (from the North American Indian name). An American name for various plants or their colored juices. In the South it is applied to *Sanguinaria* (q.v.); in the Southwest to *Lithospermum hirtum* (hairy puceoon) and *Lithospermum canescens* (hoary puceoon or alkamet). Yellow puceoon (*Hyarastis Canadensis*) is also called Indian dye or turmeric, yellow or orange root, and golden seal.

PUCHTA, pook'tá, GEORG FRIEDRICH (1798-1846). A great German jurist who systematized the theories of the historical school of law. He was born at Kadolzburg, was educated at Erlangen, taught there (1820-28), was professor at Munich until 1835, then in Marburg, in Leipzig (1837-42), and for the last three years of his life in Berlin as successor of Savigny. A follower of Schelling in philosophy, and an intimate friend of that master, whom he had known in Munich, Puchta was a profound thinker and clear stylist. His more important works are: *Civilistische Abhandlungen* (1823); *Lehrbuch der Pandekten* (1838; 12th ed. 1877); *Einleitung in das Recht der Kirche* (1840); *Kursus der Institutionen* (1847-47; 9th ed. 1881); *Vorlesungen über das heutige römische Recht* (1847-48, edited by Rudorff; 6th ed. 1873-74).

PUCK. An elf who plays an important part in Shakespeare's *Midsummer Night's Dream*, and who is identified with Robin Goodfellow (q.v.).

PUCKLE, JAMES (1667?-1724). An English writer. He was born at Norwich and later settled in London as a notary public. He is remembered for *The Club, or a Dialogue Between Father and Son, in Vino Veritas* (1711). In 1723 a revised and enlarged version appeared under the title *The Club, or a Grey Cap for a Greenhead, in a Dialogue Between Father and Son*. It is a series of character sketches connected by the fiction of a club, called *The Noah's Ark*. The son describes the types met at the club, and his father comments upon them. The edition of 1723 was reprinted with illustrations by John Thurston (1817), with a preface added by S. W. Singer (1834); again at Glasgow in 1890; and with an introduction by Austin Dobson (London, 1900; New York, 1901).

PÜCKLER-MUSKAU, pük'lér-mus'kou, HERMANN LUDWIG HEINRICH, Prince (1785-1871). A German author, born in Muskau, Lusatia, and educated at Halle and Leipzig. He entered the army in 1803, served with much distinction, and in 1822, after his retirement, was made prince by the King of Prussia. He traveled much in England, where he developed his love for landscape gardening. Gardens on his own estate at Muskau and in Weimar were laid out after the plans described in his *Landschaftsgärtnerei* (1834). His books of travel, especially *The Travels of a German Prince in England* (tr. by Sarah Austin, 1832), *Tutti Frutti* (tr. by Spencer, 1834), and *Mehemet Ali and Egypt* (1848), made a strong impression on account of their brilliant style. His first work,

Briefe eines Verstorbenen (1830), a diary descriptive of manners and customs of the aristocracy of many lands, is still read.

PUCRAS (East Indian name), or KOKLASS. A pheasant of the Himalayan genus *Pucrasia*, recognizable by the long crests and still longer ear-tufts of the cocks. Their flight is swift and they are favorites with sportsmen.

PUDDLING. See IRON AND STEEL.

PUDICITIA, pü'di-sish't-á (Lat., modesty). The goddess of chastity and modesty, at first worshiped only by patrician Roman matrons, but later by plebeians as well. She corresponds to the Greek goddess *Aidos*.

PUDSEY, püd'zi. A woolen-manufacturing town in the West Riding of Yorkshire, England, three miles east of Bradford (Map: England, E 3). It was incorporated in 1899, and has shown much municipal activity and improvement. Population, in 1891, 13,400; in 1901, 14,900.

PUDU, pöö'döö (South American name). A very small white-tailed, stout-limbed deer of the Chilean Andes (*Puduha humilis*), which has antlers in the form of minute simple spikes, and has no upper canine teeth. It is restricted to the high mountains of Chile, where it is an object of sport. See Plate of FALLOW DEER, MUSK, ETC.

PUEBLA, pwá'blá. An inland State of Mexico, bounded by the State of Vera Cruz on the north and east, Oaxaca and Guerrero on the south, and by Morelos, Mexico, and Hidalgo on the west (Map: Mexico, K 8). Area, 12,204 square miles. The State includes one of the most elevated portions of Mexico. On the western frontier rise the volcanic peaks of Popocatepetl and Iztaccihuatl, and on the eastern boundary the great cone of Orizaba. The northern part is traversed by the Sierra Madre, and the extreme north slopes toward the low coast region. The central portion belongs to the Plateau of Anahuac (q.v.), while in the south deep valleys are the most prominent features. The chief river is the Apoyac, or upper course of the Mescala, which traverses the southern portion. The climate varies considerably according to the elevation, and the soil is generally fertile in the valleys, where sugar and cotton are cultivated. The more elevated regions are devoted chiefly to the raising of cereals. Grazing is carried on extensively in some parts of the State. The mineral deposits are believed to be considerable, but mining is as yet in a backward state, though some marble is quarried. The State is crossed by several railroad lines. Population, in 1895, 973,876; in 1900, 1,024,446, including a large number of civilized Indians. Capital, Puebla.

PUEBLA, or PUEBLA DE ZARAGOZA, formerly PUEBLA DE LOS ANGELES. The capital of the State of Puebla, Mexico, and the largest city of the Republic next to the national capital. It is situated on the Atoyac River, 60 miles southeast of Mexico City, at an elevation of 7200 feet above the sea, and between the bases of Mounts Malinche and Popocatepetl (Map: Mexico, K 8). It is a very pleasant and well-built city, regularly laid out with broad streets and spacious squares. The uniform slope of the ground gives it a good natural drainage, which is further reinforced by a good artificial system, so that it is a very healthful city. Among its many handsome buildings the most prominent is the cathedral, which rivals that of Mexico, and whose two fine towers

dominate the view of the city. Other notable buildings and institutions are the Palace of Justice, the Alhóndiga, a large and handsome building occupied by the State Legislature, the State College with a large library, the School of Medicine, the Palafoxiana Library containing over 100,000 volumes, the Academy of Fine Arts, and several theatres and hospitals. The city is an important commercial and industrial centre. It has several cotton and woolen mills, foundries, and glass factories, and is connected by rail with Mexico, Vera Cruz, Orizaba, and Oaxaca. Population, in 1895, of the city proper, 88,684.

Puebla was founded as a mission station in 1530 by Toribio de Benavente. In 1847, during the war with the United States, it was occupied for some time by the American forces. In 1862 it was attacked by the French army, which was repulsed by General Zaragoza, in whose honor the city received its present name. The French, however, captured it in the following year. Consult: Romero, *Geographical and Statistical Notes on Mexico* (London, 1898); Ramirez, *Informe sobre la captoración hecha en los terrenos de Tultic* (Mexico, 1883).

PUEBLO, pwéb'ló (Sp., village). A name first used by the Spaniards, and later adopted by the Americans, to designate the semi-civilized agricultural and sedentary Indians dwelling in adobe or stone-built communal houses in the arid region of the Southwestern United States, chiefly along the Rio Grande and its tributaries. The term 'village Indians' was used in distinction from the ruder wandering tribes, without reference to political or linguistic affiliations. The existing pueblos, or settlements, now number 27, besides the Mexicanized colonies of Isleta in Texas and Seneñ in Mexico, together with several sub-pueblos, representing in all four distinct stocks, with about twice as many languages and several additional dialects. With the exception of Zuñi, the seven Moki villages in Arizona and the two Pueblo colonies below El Paso, all the existing pueblos are within a limited area of north central New Mexico, but the hundreds of ruins, together with traditional and historical evidence, prove that the area of Pueblo culture formerly comprised the whole region from the Pecos to the middle Gila, and from central Colorado and Utah southward into Mexico. This does not mean that all of the ruins were occupied at the same time, but that at one time or another every part of the region in question was within the sphere of Pueblo culture. There seems to have been a gradual withdrawal from the northern and other more exposed sections and a concentration upon central points, due to the invasion of the savage Apache and Navaho. Some Pueblo tribes have distinct traditions of their former occupancy of particular ruins, frequently remote from their existing villages.

The recorded history of the Pueblos begins with their discovery by Father Marcos de Niza in 1539, followed up by the expedition of Coronado (q.v.) the following year. Later on the occupation and conquest of the country was begun in earnest. Within the next century missions were established in nearly every pueblo, and the whole country was mapped out into districts, held under close subjection by Spanish garrisons. The exactions of the commanders, the outrages of the soldiers, and the interference of the mis-

sionaries with the old-time pleasures and ceremonies of the Indians, bred discontent, and in 1680, under the leadership of Popé, a medicine man of the Tewa, there was a simultaneous rising of the Pueblos from the Pecos to the Hopi villages so sudden and complete in its surprise that priests, soldiers, and civilians were everywhere butchered, and the survivors after holding out for a time under Governor Otermin at Santa Fé fled to El Paso, leaving not a single Spaniard in New Mexico. A few of the Piro and Tigua tribes who adhered to the Spaniards followed them in their retreat, and were afterwards colonized respectively at Seneñ and Isleta, below El Paso. The people of Awátobi, one of the Hopi towns, who had refused to dismiss or butcher their missionaries, were massacred by their kindred of the other Hopi villages, and their town was destroyed. Taking care to make their preparation complete, the Spaniards gathered their forces together for another invasion of the country, and this time with such success that by 1692 the reconquest of the Pueblos was complete. The missions, however, were not reestablished, and most of the tribes relapsed into their primitive religion and ceremonial. Their history from that period until the Mexican War brought them under American jurisdiction is of little outside importance. By the treaty with Mexico they were declared American citizens on the same terms as their Mexican neighbors, but the new territorial administration refused to admit them to equal rights, and they continue to be treated as Indians under Government control according to the regular agency system. They are entirely self-supporting, however, and ask and receive little beyond schools and recognition of certain village and farming reservations.

Physically the Pueblo Indians are small in stature, but very strong, being able to walk or even run long distances, or climb steep or difficult mountain trails, under burdens that would tax the strongest white man. They are darker than the Plains Indians, with mild and friendly countenances, indicative of their disposition. They are not aggressive warriors, fighting usually only in self-defense, and preferring rather to avoid trouble with the wild Apache and Navaho by building their settlements upon the tops of high cliffs, to be ascended only by narrow and easily defended trails. Hence the name 'Cliff Dwellers' frequently applied to them and more particularly to the extinct inhabitants of the northern cañon ruins. Since the Government has interfered to restrain the predatory tribes, most of the Pueblos have come down upon the plain, but the Hopi of Arizona still have their villages upon mesas several hundred feet above the surrounding level. Their houses are solidly built communal structures of adobe or stone set in clay mortar, with square rooms and flat roofs, through which trap-doors with ladders give access to the interior, the outer walls being frequently without door or window as a precaution against attack. Rooms are added to the original structure as needed, and a whole village frequently forms one compact building, with stories in terrace style, one above another. An important feature of each pueblo is the *kiva* or underground chamber for the use of the various ceremonial societies.

Their dress is of buckskin or of cotton or woolen fabrics of their native weaving. In some

PUEBLO OF ZUNI INDIANS

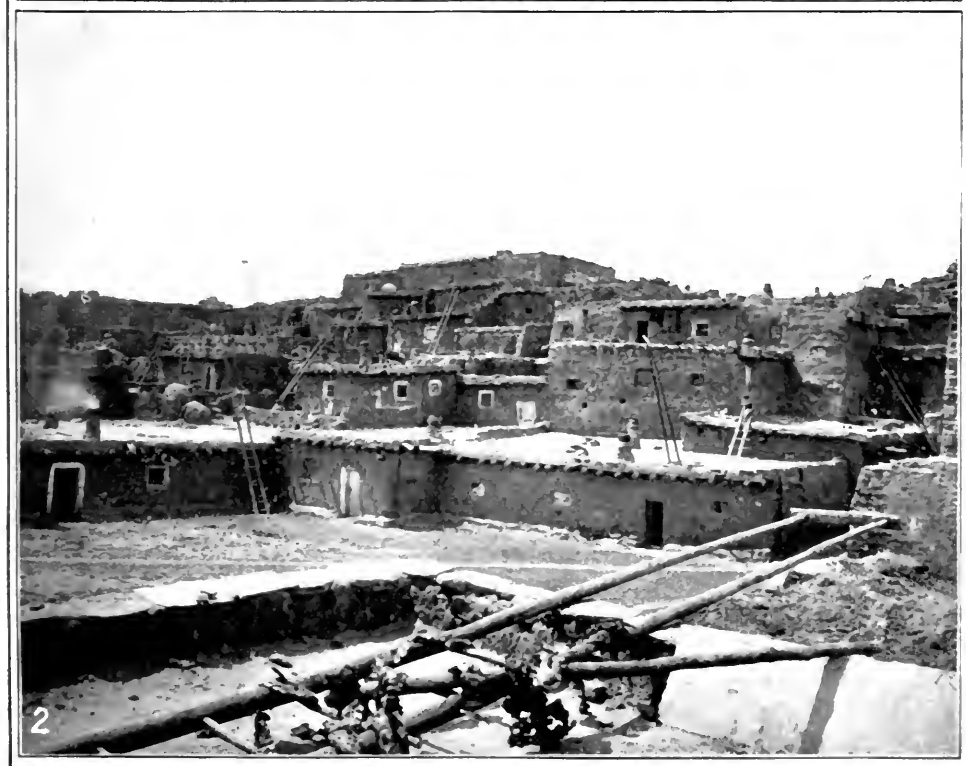

1. ZUNI PUEBLO FROM THE SOUTH

2. VIEW IN THE PUEBLO

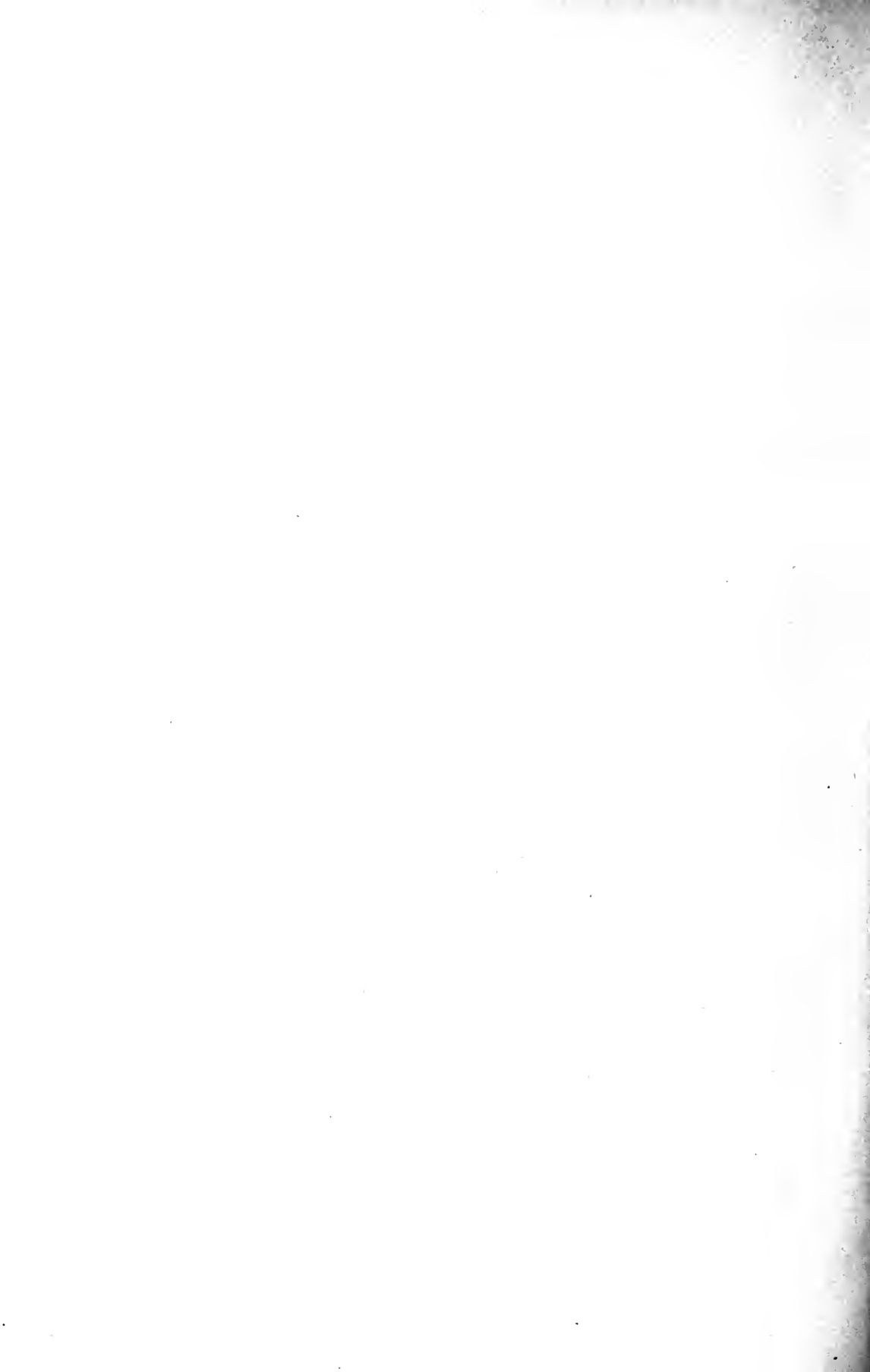

tribes, as the Hopi, the unmarried women are distinguished by a peculiar arrangement of the hair. They are all basket-makers, each pueblo having its own method or design. In variety of pattern and beauty of decoration they have developed the pottery art to a higher stage than was found anywhere else in the United States. Their men are also skillful wood-carvers, particularly in the shaping of ceremonial figurines. Their main dependence is agriculture, each pueblo cultivating its fields in common, usually by aid of irrigation from an adjoining stream, and producing corn and beans in many native varieties, with melons, squashes, and other vegetables, ehile, tobacco, as well as peaches, introduced by the early Franciscan missionaries. The grinding of the meal upon stone metates and the baking of the bread upon heated slabs of stone occupies a large share of the woman's indoor time, while pottery and the field occupy her attention outside. The men, besides their field work, do the weaving and carving, besides procuring the wood, which must generally be brought from long distances on the backs of burros. The intervals between crop seasons is given to a succession of elaborate and spectacular ceremonials, one of which, the snake dance (q.v.) of the Hopi, has achieved a national reputation. Most of these ceremonials are of a sacred character, being either invocations or thanksgiving for the rain and the crops, and each is in the keeping of a special secret society.

Family life is based upon the clan system, the number of clans being very large in proportion to the population, and the woman is the ruler of the household. The marriage ceremonial is elaborate, including feasting, processions, and dances, and only one wife is allowed. The government is by villages rather than by tribes, each pueblo having a peace chief or governor, assisted by councilors, together with a war chief.

The present number of the Pueblos is about 10,000. Excluding the seven Hopi (Moki) villages in Arizona, with 1840 souls, and the two Mexicanized pueblos of Isleta and Senecú below El Paso, the existing inhabited pueblos number 18, all in New Mexico, as follows: Acoma, 650; Cochiti, 300; Isleta, 1120; Jemez, 450; Laguna, with sub-pueblos of Pahuate, Paraje, Casa Blanca, and others, 1080; Nambe, 100; Picuris, 125; Sandia, 75; San Felipe, 550; San Ildefonso, 250; San Juan, 425; Santa Ana, 230; Santa Clara, 325; Santo Domingo, 1000; Sia, 125; Taos, 425; Tesuque, 100; Zuñi, 1540. They are classified by linguistic stocks as follows: Shoshonean: Mashongnivi, Shmopovi, Shupaulovi, Sichumovi, Oraibi, Walpi. Tahoan: Isleta (New Mexico), Isleta (Texas), Jemez, Nambe, Pecos (extinct), Picuris, Pojoaque (extinct), Sandia, San Ildefonso, San Juan, Santa Clara, Senecú (Chihuahua, Mexico), Taos, Tesuque, Tewa or Hano (with Hopi, Arizona). These are grouped under five cognate languages, viz.: *Tano* or *Tigua* (Isleta, New Mexico; Isleta, Texas; Sandia); *Taos* (Taos, Picuris); *Jemez* (Jemez, Pecos); *Tewa* or *Tegua* (Nambe, Pojoaque, San Juan, San Ildefonso, Santa Clara, Tesuque, Tewa or Hano); *Piro* (Senecú); *Keresan* (Acoma, Cochiti, Laguna, San Felipe, Santa Ana, Santo Domingo, Sia); *Zuñian* (Zuñi). See colored Plate of AMERICAN INDIANS, under INDIANS; also the accompanying plate showing a Zuñi Pueblo.

PUEBLO. The second largest city of Colorado, the county-seat of Pueblo County, and an important commercial and industrial centre, 120 miles south by east of Denver (Map: Colorado, E 2). Situated in a small basin near the eastern foot-hills of the Rocky Mountains and on both sides of the Arkansas River, at the junction of the Fontaine qui Bouille, Pueblo enjoys a natural location for a great railway and business centre. Its transportation facilities comprise the Denver and Rio Grande, the Atchison, Topeka and Santa Fe, the Missouri Pacific, the Chicago, Rock Island and Pacific, and the Colorado and Southern. The vicinity to the east is interested to a very large extent in stock-raising, and to a somewhat important degree in agriculture. Near the city are deposits of coal, limestone, and oil, and the tributary region includes very highly productive mineral districts. Pueblo is the great distributing and receiving point for this section of vast natural wealth. It has become known as the 'Pittsburg of the West,' being famous for its iron and steel, and smelting industries. There are in the city several smelters producing lead, silver, and gold, zinc, and copper; the immense plant of the Colorado Fuel and Iron Company, which manufactures various iron and steel products; foundries and machine shops, including railroad car shops; manufactories of fire-brick, glass, woollens, furniture, etc.; and large stock yards. According to the census of 1900, an aggregate capital of \$12,374,000 was invested in these industries, which had a production valued at \$30,795,000, the output of the lead smelting and refining works alone amounting to nearly \$20,000,000.

Pueblo has the McClellan Public Library, with more than 12,000 volumes; law libraries; the State Insane Asylum and several other charitable institutions; and the State Mineral Palace and Park. In the building last mentioned is a complete collection of the minerals of Colorado. The government, under a charter of 1887, is vested in a mayor, elected biennially, and a unicameral council, and in administrative officers. Fire department officials, the police judge, and city physician are elected by the council, which also confirms the mayor's nominations of police officials. The engineer, auditor, treasurer, and clerk are chosen by popular election. There are two systems of water-works, one of which is owned by the municipality. A few Mormons settled temporarily on the site of Pueblo in 1846, and about 1850 a trading post was established here, the inhabitants of which, however, were massacred by the Ute Indians in 1854. The present city was laid out in 1859 and was chartered in 1873. In 1887 Pueblo, South Pueblo, and Central Pueblo were consolidated. Population, in 1890, 24,558; in 1900, 28,157.

PUELICHE, pōō-ā'chā (eastern people). A people of Araucan stock roving over the pampas region of the Rio Negro, Southern Argentina. They are so called in distinction from the cognate Moluche, or 'western people,' in and west of the Andes. Those living in the foothills of the Andes are frequently also distinguished as Pehuenehe, 'pine forest people.' In language and general characteristics they differ but slightly from the others of the same stock, but are rather wilder than those of Chile, spending much of their time on horseback and seldom staying long in one place. They carry on a considerable

trade in cattle, salt, and tobacco with the tribes west of the mountains. They have large herds of cattle and horses, are expert with the bolas, and fond of gambling and music. They wear their hair flowing or gathered behind into a queue decked with silver beads, with a bright turban about the head, and a blanket wrapped about the waist and held in place by a belt. Physically they are of medium stature, broad-chested, and inclined to corpulency. They pluck out the beard and eyebrows, and the women paint their faces in red and black.

PUENTE DE CALDERON, pwān'tá dá kál'dá-rōn' (Sp., bridge of Calderon). A bridge over the Rio Grande de Santiago, about 30 miles from the city of Guadalajara, Mexico, noted as the scene of the defeat of the revolutionary forces under Hidalgo, about 80,000 poorly armed, by Calleja with 6000 well-equipped troops, January 17, 1811.

PUENTE GENIL, nā-nēl'. A town of Southern Spain in the Province of Cordova, situated 32 miles south of Cordova on the river Genil, which is here crossed by a stone bridge, and on the railroad to Malaga. It has a secondary college and a public library; it is surrounded by olive orchards, and its principal industry is the manufacture of olive oil. Population, in 1900, 12,959.

PUENTES (pwān'tás) **DAM**, FAILURE OF. See DAMS, paragraph *Failure of Dams*.

PUERPERAL FEVER (from Lat. *puerpera*, parturient woman, from *puer*, child + *parere*, to bear), **PUERPERAL SEPSIS**, **CHILDBED FEVER**. A fever appearing in puerperal women within a week after labor—usually from the third to the fifth day—attended with septic infection of the blood and acute inflammation of one or more of the reproductive organs or the loose cellular tissues connected with them, and often characterized by severe and widespread complications. This fever was long considered specific, and under the names childbed fever, lying-in fever, etc., was a fatal and frequent complication of the puerperium, particularly in lying-in hospitals. It is now known that the disease is due to infection from some microorganism introduced into the genital tract by contact with unclean hands, instruments, dressings, clothing, or bedding. The credit of pointing out the true origin of this disease is due to Dr. Oliver Wendell Holmes, who in 1843 promulgated the doctrine of extragenital infection. In 1847 Semmelweis proclaimed the same teachings in Europe. Since modern antiseptic midwifery has caused the hands, instruments, and the materials used in the lying-in room to be sterilized, puerperal fever has become a comparatively rare occurrence, while a better knowledge of its pathology and prompt treatment of its earliest symptoms make it a much less fatal and severe sequel of labor.

The complications that may arise in puerperal fever are both grave and numerous. Pericarditis, pleurisy, endocarditis, pneumonia, and inflammation of the joints may occur, and the liver, kidneys, bladder, or spleen may be secondarily infected. The disease is usually ushered in with violent and prolonged chills, followed by an irregular fever, uneasiness, nausea, extreme general depression, with a rapid, feeble pulse, and shallow respiration. The expression is anxious, the tongue heavily coated, and the urine scanty

and albuminous. Severe cases run a rapid course and often terminate fatally within a week.

The prevention of puerperal infection by the exercise of rigid cleanliness in every labor case, and particularly when instrumental interference is demanded, is now one of the most important duties of the obstetrician. (See ANTISEPTICS.) When, however, infection has taken place, on the appearance of the initial symptoms the genital tract should be irrigated at frequent intervals with from three to four quarts of some warm antiseptic solution. Mercuric chloride, creolin, carbolic acid, or plain normal salt solutions are those usually employed for this purpose. If this measure does not prove efficient in abating the fever in a short time, it is necessary to explore the uterine cavity and remove by means of the wire curette the decomposing material which is almost certain to be found there. Frequent douching with one of the solutions named above is continued until convalescence sets in. The general treatment is stimulating and supportive. An abundance of easily digestible liquid food, such as milk, beef tea, broths, and animal juices, must be given. Alcoholic stimulants may have to be given in large amounts with strychnine and other cardiac tonics. Fever is reduced preferably by cold sponging, and abdominal pain and swelling relieved by the application of the hot-water coil or hot-turpentine stupe. Complications must be met as they arise.

PUERPERAL INSANITY. A term applied to mental derangement occurring during the first six weeks of the puerperal state. During the great changes comprised in the onset of labor and the beginning of uterine involution, with the nerve drain, the rapid metabolism of tissue and the necessity for sudden adjustment to a new order of life, the risks of every woman are great; and the mother who is predisposed to mental derangement is in especial danger. The onset of an attack of puerperal insanity is frequently sudden, but more frequently preceded by nerve fag, insomnia, restlessness and garrulity, fickle fancy, unreasonable likes or dislikes, and perverted affection. Suspicion and obstinacy, violent hatred of husband or infant follow. Delusions and hallucinations of a terrifying kind occur, and there is constant excitement, perpetual talking in an incoherent way, impulsive action, often obscenity in speech and conduct, and often homicidal or suicidal impulse.

Puerperal insanity takes the form of mania in about one-half of the cases, of melancholia in about one-half. Moral shock has often a strong influence in the production of this insanity, for over 25 per cent. of the cases occur in mothers of illegitimate children. It is frequent in primiparæ. About one-half are violent or homicidal, about one-quarter of the cases are suicidal. Eighty per cent. of the cases recover.

The treatment must be directed toward the genital apparatus, the digestive tract, the capacity for sleep, and the necessity for hydrotherapy. Custodial care is, in the vast majority of the cases, necessary; for removal from familiar home surroundings is valuable. Consult Bevan Lewis, *Text-book of Mental Diseases* (London, 1889).

PUERTA DEL SOL, pwār'tá dēl sōl (Sp., Gate of the Sun). The chief square of Madrid, on the site of the former eastern gate of the

city. It is now in the centre of Madrid, the focus of the most important streets, and the favorite meeting-place of the populace.

PUERTO CABALLOS, pwār'tō kā-bā'yōs. A town of Honduras. See **PUERTO CORTÉS**.

PUERTO CABELLO, kā-nā'yō. A seaport of Venezuela, situated on the Golfo Triste, 55 miles west of Carácas, with which it is connected by rail (Map: Venezuela, D 1). It has a hot and unhealthy climate, but an excellent harbor protected by a chain of islands and fortified. It is the third in importance among the ports of the Republic. The shipping in 1900 amounted to 218,788 tons. The principal export is coffee, of which nearly 26,000,000 pounds were exported in 1900. Other exports are cacao, hides, and lumber. Population, about 15,000. In the eighteenth century Puerto Cabello was one of the most important towns of Venezuela, and a great trade centre. In 1743 it repulsed the attack of an English squadron. It was an important point during the English-German blockade of 1903.

PUERTO CORTÉS, kōr-tās', or **PUERTO CABALLOS**. A port of Honduras, situated on a bay of the Gulf of Honduras (Map: Central America, C 3). It is the best harbor on the north coast of the Republic, and is the terminus of a railroad connecting with the interior. It exports mahogany, cedar, vanilla, and hides. Population, 2000.

PUERTO DE SANTA MARIA, dā sän'tā má-rē'á, commonly known as **EL PUERTO**. A town of Spain, in the Province of Cadiz, situated on the Bay of Cadiz, at the mouth of the Guadalete, five miles northeast of Cadiz (Map: Spain, B 4). The town lies amid pleasant surroundings, and is well built, with a fine, large main street containing the houses of the rich wine-merchants. Many of the houses are lighted by electricity from a central power plant. There are several old convents, a well-equipped Jesuit college, a modern theatre, and a large bull ring. A characteristic feature of the town is the *bodegas*, or wine stores—large buildings with thick walls and narrow windows. El Puerto is the principal port for the exportation of sherry wines, since it is the nearest port to Jerez de la Frontera (q.v.), with which it is directly connected by rail. Other industries include the manufacture of brandies, starch, flour, soap, and glass. There are fisheries and exports of fish. Population, in 1887, 20,590; in 1900, 19,373.

PUERTO LA MAR, lá mār. A seaport of Chile. See **CONIJA**.

PUERTO MONTT, mōnt. The capital of the Province of Llanquihue (q.v.), Chile.

PUERTO PLATA, plä'tá. A port of the Republic of Santo Domingo, situated on the north coast of the island of Haiti (Map: West Indies, M 5). The town has a well-protected harbor and considerable export trade, chiefly in tobacco. It has steamship communication with the United States and Europe. Population, about 4000.

PUERTO PRINCESA, prēn-thá'sá. The capital of the Province of Moro Palawan, Philippine Islands, situated on the east coast of the island of Palawan, 80 miles southwest of Taytay (Map: Philippine Islands, C 10). It was formerly a Spanish penal colony, and has a capacious, land-

locked harbor with a lighthouse. Population, about 1500.

PUERTO PRÍNCIPE, prēn'thé-pá. A province of Cuba, occupying the east central portion of the island, and bounded on the north by the Atlantic Ocean, on the east by Santiago de Cuba, on the south by the Caribbean Sea, and on the west by Santa Clara (Map: Cuba, H 5). Its area is 10,500 square miles. It is the largest province of the Republic next to Santiago. The north coast is lined with a chain of large islands, and innumerable islets lie off the southern coast. The surface is an undulating plain with some detached groups of hills in the northern part. The most extensive forests of the island are found in this province, and lumbering, copper-mining, and cattle-raising are the chief industries. Agriculture is here less developed than in the other provinces, and sugar and tobacco plantations are chiefly confined to the district around the capital, Puerto Príncipe (q.v.). The province is by far the most thinly populated in the island, the population in 1899 having been only 88,234. Consult Torres Lasqueti, *Colección de datos históricos-geográficos y estadísticos de Puerto del Príncipe* (Havana, 1888).

PUERTO PRÍNCIPE. Capital of the Province of Puerto Príncipe, Cuba. It is situated in a broad, sandy, and elevated savanna region, 25 miles from the north and 45 miles from the south coast of the island (Map: Cuba, G 5). It is very antiquated in appearance, with narrow, winding streets and old houses built of brick and stone. The chief industries are connected with cattle-raising, for which the surrounding country is well adapted, and cattle products are the chief exports, though some sugar is also produced. The city is connected by rail with its port, Nuevitas, on the north coast, and it is a station on the Cuban main trunk railroad, completed in 1902, which connects it with Havana and Santiago. Population, in 1899, 25,102; of the municipal district, 53,140. Puerto Príncipe was an important military post during the Spanish régime, and was surrounded by an extensive system of trenches, stockades, and small forts. The surrounding country was the centre of insurgent operations during the revolution, and only 16 miles north of the city lies Cubitas, the capital of the revolutionary government from 1896 to 1898.

PUERTO REAL, rá-íl'. A town of Southwestern Spain, in the Province of Cadiz, situated at the head of the Bay of Cadiz, 5 miles east of the city of that name. It is a well-built modern town, founded in 1488 on the site of the old Roman *Portus Gaditanus*. It has a harbor with a steamship pier and a dry dock, and manufactures textiles, cements, and salt. Population, in 1900, 9683.

PUERTO RICO, rē'kō. See **PORTO RICO**.

PUFENDORF, pu'f'en-dōrf, SAMUEL, Baron (1632-94). A celebrated German publicist, born at Chemnitz, in Saxony. He began the study of theology at Leipzig, but speedily turned to the subject of public law, which he pursued at Jena till 1657. In 1658 he became tutor in the family of Coyet, Swedish Minister at Copenhagen, and in 1660 went with his patron to The Hague, where he published his *Elementa Jurisprudentiæ Universalis* (1660). This led to his being sum-

moned to the University of Heidelberg, where the chair of the law of nature and of nations was created for him. In 1667 he published, under the pseudonym of Severinus de Mozambano, *De Statu Imperii Germanici*, a merciless analysis of the anachronisms and absurdities of the Imperial Constitution. This work aroused great attention and brought the author much fame and many enemies. In 1670 Pufendorf followed a call to the Swedish University of Lund. There he wrote *De Jure Naturæ et Gentium* (1672) and *De Officio Hominis et Civis* (1673). In the former of these he makes an elaborate study of the origin of law, finding its threefold source in reason, the civil law, and revelation. He also did much to free the study of jurisprudence from the fantastic speculations of the theologians, and as a result was precipitated into bitter controversies with the representatives of the old order. In 1677 he became Councilor of State and royal historiographer to the King of Sweden. There followed a number of important works, *Einleitung zur Historie der vornehmsten Reiche und Staaten* (1682), *De Rebus Suecicis* (1686), and *De Rebus a Carolo Gustavo Gestis* (1688). In *De Habitu Christianæ Religionis ad Vitam Civilem* (1687) he upheld the right of the State as against the Church. He went to Berlin in 1686, summoned by the Great Elector, and after the latter's death in 1688 was made by his successor Privy Councilor. He died in Berlin October 26, 1694. The *De Rebus Gestis Friderici Wilhelmi Magni* and *De Rebus Gestis Friderici III.* appeared the year after his death. Consult: Treitschke, "Samuel von Pufendorf," in the *Pruussische Jahrbücher* (Berlin, 1875); Droysen, "Zur Kritik Pufendorfs," in *Abhandlungen zur neuen Geschichte* (Berlin, 1876).

PUFF. A bold and impudent literary humbug in Sheridan's farce *The Critic*, the author of *The Spanish Tragedy* rehearsed in the play, and "a professor of the art of puffing."

PUFF-ADDER. An African viper (*Bitis* or *Clotho arictans*), which takes its name from its habit of lifting its head when approached, and menacing the enemy by hissing loudly with a puffing sound. It is a typical viper, but has an unusually broad, triangular head, due to the excessive size of its poison sacs, and its bite is very dangerous. This shape, the large upturned nostrils, and cruel eyes give it an especially ugly appearance. It attains a length of four to five feet, and is often as thick as a man's arm. Its color is yellowish brown, checkered with reddish brown and white, making it very difficult to see as it lies on the ground. Its movements are generally slow, and its habits are those of vipers generally. This serpent is found all over Africa, except along the Mediterranean coast. Consult Hopley, *Snakes* (London, 1882). See Colored Plate of FOREIGN VENOMOUS SERPENTS.

PUFFBALLS. Globular fungi occurring on the surface of the ground, and producing internally innumerable minute spores, which usually escape through a definite opening at the top. See BASIDIOMYCETES; MUSHROOM.

PUFF-BIRD. A barbet, especially of the family Bucconidæ. These take their name from their habit of sitting motionless on a perch for hours at a time, with their feathers raised until the bird looks like a puffball. At the first alarm,

the feathers flatten instantly. See BARBET and Plate of TROGON, HOOPOE, ETC.

PUFFER. See GLOBEFISH, and Plate of PLECOGONATH FISHES.

PUFFIN (so called from its puffed-out beak). An auk of the genus *Fratercula*, characterized by the high, compressed form of the beak. The best known is the common one (*Fratercula arctica*) of the Arctic and north temperate regions generally, which migrates southward in winter as far as Spain and Long Island. It is a little larger than a pigeon; the forehead, crown, back of the head, a collar round the neck, the back, wings, and tail are black, the other parts of the plumage white. The puffin lays only a single egg in a burrow or some natural hole in a cliff-face, where great numbers congregate and behave like auks and guillemots (qq.v.). The eggs and young birds are sought after by fowlers for food. Other species are found in the Arctic and North Pacific oceans, coming to California in winter. Among the most notable are the crested puffin (*Lunda*

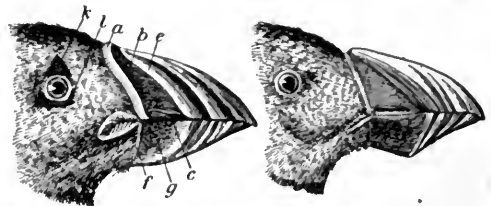

BEAK OF PUFFIN (*Fratercula Arctica*).

The left-hand figure shows the appearance of the beak of the male in the breeding season, at the close of which all the parts lettered are separately molted. The appearance of the beak in the non-breeding season (winter) is shown in the right-hand figure.

cirrhata), which has a long tuft of feathers on each side of the head, and the tufted puffin (*Fratercula corniculata*). This might more suitably be called 'horned' puffin, as each of its upper eyelids bears a slender, upright, acute horn (See Plate of AUKS, ALBATROSS, ETC.), which, however, is only an appendage of the male in the breeding season, and drops off at its close, just as the special coatings and appendages of the beak and eyes in some other puffins are acquired in the spring and molted in the fall.

PUG (variant of *puck*, from Ir. *puca*, Welsh *puca*, *pucci*, goblin, sprite). A small, smooth, short-nosed house-dog, introduced into England probably from Holland, to which country it seems to have come, according to general testimony, from the East Indies. The breed was well established in England by the year 1700, and continued so from the reign of William II. to George II. By the first quarter of the nineteenth century pugs had nearly or quite disappeared from Great Britain. The fawn variety was reintroduced from Holland, and now there are two recognized strains—the Fawn and the Black (the latter brought from China about 1875 by Lady Brassey). An inferior quality has long been bred in Italy and in France, where they were called 'carlins,' after a celebrated Harlequin. The pug is essentially a house-dog, and a very good one, and for that purpose a smaller dog than the standard allowed in competition (13 to 17 pounds) is the better. The general appearance is that of a large-headed, smooth-coated, black-faced, pug-nosed, bright little dog,

compact in form, with well-knit proportions and well-developed muscles. In color he is (in the ordinary variety) fawn all over, except on the muzzle or 'mask,' the ears, the moles on his cheeks, the 'thumb-mark' or 'diamond' on his forehead, and his back trace, which should all be as black as possible. His face is deeply wrinkled, and he carries his tail curled as tightly as possible over his hips. His coat must be short, smooth, soft, and glossy, neither hard nor woolly.

The 'black pug' differs only in color; he is entirely black.

PUG. A demon in human form in Ben Jonson's comedy *The Devil's an Ass*, a mischievous creature resembling Shakespeare's Puck.

PUGATCHEFF, по́уга-чѣф, YEMELYAN IVANOVITCH (c.1726-75). A leader of a great popular uprising in Russia, known as *Pugatchefshchikina*. He was a Cossack of the Don, and fought against the Prussians in the Seven Years' War, and in the campaign against Turkey in 1769. On his return he was arrested for helping his brother-in-law to escape across the Don. Fearing punishment, he ran away to the Cossacks of the Terek, where he heard persistent rumors that Peter III. was still alive. Strikingly resembling the murdered Czar in personal appearance, he pretended to be that sovereign, and declared his purpose of reasserting his right to the crown and of dethroning Catharine II. He issued a proclamation in the name of Peter III. in 1773, and in the same year the rebellion began. He attached to his cause the Raskolniks, whose religion he embraced, and won over several Finnish and Tatar tribes, and a large number of the peasantry. After the capture of many fortresses on the Ural and the Don, Orenburg among them, he marched against Moscow, but was sold by some of his companions for 100,000 rubles. After trial he was executed in Moscow. His insurrection is said to have cost 100,000 lives.

PUGET, пу'зһá', PIERRE (1622-94). A French sculptor, painter, and architect; born probably near Marseilles. At the age of fourteen he was apprenticed to a wood-carver named Roman, employed in the decoration of ships, and at about eighteen he went to Florence and soon after to Rome. His great natural ability attracted the attention of Pietro da Cortona, the famous painter and decorator, whose assistant he became. Bernini and Algardi were then in full career, and Puget was thus from the first subjected to the powerful influence of the Italian Decadence. Beginning with 1650, he appears to have devoted himself almost exclusively to painting pictures for the churches of Marseilles and other cities of Southern France. He was a painter of considerable ability. In style, of course, he followed the decadent Italian school, but he also was influenced by the work of Van Dyck. There is record of fifty-six pictures by him, nineteen of which are still in existence, including three portraits of himself.

His first important works in stone are the famous pair of male caryatids (1657) on the portal of the façade of the Hôtel de Ville at Toulon. In this work a familiar Italian motive is treated with supreme originality and power. In 1659 he went to Paris and made three fine figures for the Château of Vaudreuil, in Normandy. He attracted the attention of Fouquet, who en-

gaged him to assist in the decoration of his new château at Vaux-le-Vicomte. In 1660 he went to Genoa and made for Fouquet his celebrated statue of "L'Hercule gaulois," now in the Louvre. The next seven years in Genoa were the most successful of his entire career. For Francesco Sauli he made statues of Saint Ambrose and Saint Sebastian in the Church of Santa Maria di Carignano, the former being especially fine. He made also a statue of the "Conception" in the Albergo de' Poveri (1664), the great altar of the Church of the Theatines (finished 1670), and probably assisted J. B. Carlone in painting the dome of this church. After 1668 Puget seems to have divided his time between Marseilles, Toulon, and Genoa. He was continually employed by the French Government in the decoration of ships until the example of the English navy brought about the abandonment of such work. In Marseilles Puget played a large rôle in the projected reconstruction of the old city. Several important streets were laid out by him, and he is credited with a large number of buildings which show the influence of Genoese architecture. The reputation of Puget rests chiefly upon two powerful works which were executed during this period—the statue of Milo of Crotona and the great bas-relief of Alexander and Diogenes, both in the Louvre.

Consult: Léon Lagrange, *Pierre Puget, peinture, sculpteur, architecte*, the leading biography (Paris, 1868); Emeric-David, *Histoire de la sculpture française* (ib., 1872); Rioux-Maillon, "Pierre Puget décorateur," in *Revue des arts décoratifs*, vol. ii.

PUGET (pu'jět) SOUND. A large, irregular, and many-branched inlet, extending over 100 miles into the northwestern part of the State of Washington (Map: Washington, C 1). From the junction of the Straits of Georgia and Juan de Fuca, which separate Vancouver Island from the mainland, Puget Sound proper extends southward, and divides into two main branches, Hood's Canal in the west and the Admiralty Inlet in the east. The latter ends in a maze of branching fiords, on one of which stands Olympia, the State capital. The shores were originally covered with forests, but have been largely denuded by extensive lumbering. Still the mountains in the background make it one of the most picturesque bodies of water in the United States. The temperature of the Sound water is cool, coming as it does from melting snow, especially through the Fraser River. As a result the summer heat of the surrounding country is very much tempered. The depth ranges from 180 to 925 feet. The absence of shoals, the abundance of harbors, and the deep penetration into the country, peculiarly adapt it to commerce. Port Townsend, Seattle, and Tacoma are situated on its shores.

PUGHE, pū, WILLIAM OWEN (1759-1835). A Welsh antiquary. He was born in Wales, but at the age of seventeen went to London, where he studied Welsh literature. After assisting Owen Jones in editing Welsh poems, he was associated (1801-07) with him and with Edward Williams in publishing the *Myrryrian Archaeology of Wales*. Between 1793 and 1803 he published *The Welsh and English Dictionary*, containing 100,000 words (re'dited 1806, 1832, and 1857), which, though not trustworthy in matters of etymology, is very complete and has excellent

definitions. In addition, he edited the *Cambrian Register* and the Welsh magazine *Y Greal*, and translated into Welsh Milton's *Paradise Lost*, Bishop Heber's *Palestine*, and other English poems. His works had a considerable influence in awakening interest in Welsh literature.

PUGILISM (from Lat. *pugil*, boxer, from *pugnus*, fist; connected with Gk. *πύγμα*, *pygmē*, fist, OHG. *fūst*, Ger. *Faust*, AS. *fyst*, Eng. *fist*). Prize fighting. The practice of fighting for a prize with the fists has from earliest times been peculiarly an Anglo-Saxon sport, but in its professional aspect it is comparatively modern. Tom Figg, who was the champion of England in 1719, is said to have introduced professional pugilism into England. He was the owner of a theatre in London where contests with and without gloves were regularly held. During his lifetime the sport was so popular as to be under the direct patronage of royalty. After his death, however, there was a lull in the public interest until about 1735, when George Taylor declared himself the champion of England. From this time on prize fighting grew in popularity and was indulged in and patronized by all classes of society. The fights were conducted under the rules of the London prize ring, but gradually became so disreputable by their invariable brutality that national laws were enacted prohibiting prize fighting throughout the United Kingdom. With the founding of the Amateur Athletic Club in 1866, scientific boxing again came into vogue, and at the same time the Marquis of Queensberry's rules were recognized as the code under which boxing contests should be conducted. These rules, although known by the name of the Marquis of Queensberry, were really formulated by one of the founders of the Amateur Athletic Club, J. G. Chambers. The fashion of the period, however, which demanded the patronage of some prominent member of the nobility, led him to secure the use of that nobleman's name, because of his known interest in the sport. The underlying motive of the rules was to mark a distinction between professional and amateur, and thus to create an interest in glove fighting. Originally they provided for a series of contests for gentlemen amateurs, the prizes being challenge cups. There were to be three classes of contestants: 'heavy,' weighing more than 158 pounds; 'middle,' less than 158 pounds; and 'light-weights,' of 140 pounds and under. There were three judges, and each bout was to consist of three rounds, each one of which might be up to five minutes in duration, with one minute rest between the rounds, the contestants not responding to the call of time to be declared the loser. The ring was fixed at 24 feet. In the original rules there is no mention of a ten-second time limit, but, on the other hand, the idea seems to have been to permit the contestants to fight the full three rounds, permitting the one who had been knocked down any reasonable time to recover. The modern Queensberry rules contain the following clause under which all present-day glove contests are fought:

"Contest for Endurance.—To be a fair stand-up boxing match in a 24-foot ring, or as near that size as practicable; no wrestling or hugging allowed; the round to be of three minutes' duration and one minute time; if either man fall through weakness or otherwise he must get up unassisted; ten seconds to be allowed him to do

so; the other man meanwhile to retire to his corner, and when the fallen man is on his legs the round is to be resumed and continued until the three minutes have expired, and if one man fails to come to the scratch in the ten seconds allowed it shall be in the power of the referee to give his award in favor of the other man; a man hanging on the ropes in a helpless state with his toes off the ground shall be considered down; no seconds or any other person to be allowed in the ring during the rounds; should the contest be stopped by any unavoidable interference, the referee to name time and place for finishing the contest as soon as possible, so that the match must be won or lost, unless the backers of both men agree to draw the stakes. The gloves to be fair-sized boxing gloves of the best quality, and new; should a glove burst or come off it must be replaced to the referees' satisfaction. A man on one knee is considered down, and if struck is entitled to the stakes. No shoes or boots with spriggs allowed."

Modern prize fights and boxing contests are divided into six classes, the weights for which are as follows: Heavy, more than 158 pounds; middle, under 158 pounds; welter, under 142 pounds; light-weight, under 133 pounds; feather-weight, under 122 pounds; bantam-weight, under 115 pounds.

PUGIN, pū'jin, AUGUSTUS (1762-1832). An English architect and writer on architecture. He was born in Normandy, but during the French Revolution went to London, where he was educated at the Royal Academy. He is chiefly known by his works on mediæval architecture, and published (1821-23) *Specimens of Gothic Architecture*. In 1825, in conjunction with John Britton, he published *Architectural Illustrations of the Buildings of London*; and afterwards (1831) *Examples of Gothic Architecture, and Gothic Ornaments*; and, with Le Keux, in 1827, *Specimens of the Architectural Antiquities of Normandy*. In this, his best work, as also in his *Gothic Ornaments*, he was assisted by his son, A. N. W. Pugin.

PUGIN, AUGUSTUS NORTHMORE WELBY (1812-52). An English architect and designer. He was born in London, March 1, 1812, and was a pupil of his father, Augustus Pugin. Becoming a convert to Roman Catholicism, he designed a large number of churches for that denomination in England, including the Roman Catholic Cathedral in London. He is probably the most important of the architects connected with the revival of Gothic architecture in England during the nineteenth century, which he promoted as much by his books as by his buildings. Among his works are the following: *Contrasts, a Parallel Between the Noble Edifices of the Fourteenth and Fifteenth Centuries and the Present Day* (1836); *The Present State of Ecclesiastical Architecture in England* (1843); *True Principles of Pointed or Christian Architecture* (1841). His son, EDWIN WELBY PUGIN (1834-75), completed a number of his father's designs and buildings, besides others of his own.

PUGLIA, pōō'lyá, LA. The modern Italian form of the name of Apulia (q.v.), Italy.

PUG MILL. See CLAY.

PUGNO, pu'nyó', RAUL (1852—). A French pianist, born at Montrouge, near Paris. He received the rudiments of his musical education

from his father, a music teacher. At the age of six Raoul competed with a large class of boys for entrance into the Paris Conservatory and headed the list of successful competitors. He graduated, taking the first prize, and also first prize in harmony, in the counterpoint and fugue class of Ambroise Thomas. In 1896 he was appointed professor of piano at the Conservatory, and in 1897-98 he toured the United States with Ysaye, the famous violinist. He made a second concert tour in 1902. His compositions include an oratorio, *La résurrection de Lazare* (1879); the comic operas *Ninetta* (1882) and *Le Sosie* (1887); *Le retour d'Ulisse* (1889); operetta, *La petite Poucette* (1891); and many pianoforte pieces, vocal music, and chamber music.

PUGREE, or **PUGAREE** (Hind. *pagri*, turban). A long, light-weight, silk or muslin cloth wound round the head gear, or helmet, in tropical countries. As its origin indicates, it was first used by British soldiers serving in India, but is now part of the clothing equipment of all British soldiers serving abroad, and likewise of soldiers of all other nationalities serving in tropical climates.

PUISSET, pwê-zâ', or **PUDSEY**, HUGH DE (c.1125-95). An English Bishop of Durham and Earl of Northumberland, born in France, a nephew of King Stephen. He came to England in his teens, became archdeacon to his uncle, Henry of Blois, and in 1143, being appointed Treasurer of York, entered his long career in the ecclesiastical politics of the North. In it he was greatly assisted by Adelaide de Percy, long his mistress. In 1153, after a bitter struggle, Hugh became Bishop of Durham; but in temporal politics he took little part until 1174, when he attempted to join the rebellion against Henry II. With Richard's accession he came into new prominence because of his opposition to the King's nomination of Geoffrey for the Archiepiscopate of York, and because of his purchase of the Earldom of Northumberland. With Longchamps he had a long quarrel as to who should be chief justiciar and was finally worsted. Gradually he fell out with Richard also, and in 1194 found it good policy to surrender his earldom. His hope of repurchasing it was long baffled by his old enemy, Geoffrey, and by Hugh Bardulf, who received the earldom. PUISSET died on his way to negotiate with the King for his lost offices. He was a man of unusual ambition and ability. Durham and Northumberland made him one of the greatest princes of England. He built many castles and churches; he was a patron of Reginald of Durham, of Alan de Insulis, of Peter of Blois, and possibly of Roger of Hoveden; and it was under his orders that the *Boldon Buke* or 'Durham Domesday Book,' edited by Greenwell (1832), was drawn up.

PUISNE (pû'nê) **JUDGES** (OF. *puisne*, Fr. *puîné*, junior, from ML. *postnatus*, later-born, from Lat. *post*, after + *natus*, born, p.p. of *nasci*, to be born). Associate judges of the King's Bench Division of the High Court of Justice of England, and other divisions of the High Court in Great Britain, and associate judges in India and other British colonies. The term *puisne* was first employed, on the permanent establishment of the Court of Common Pleas at Westminster, to designate the associate judges as distinguished from the Chief Justice, who presided over the

court. Later the term was applied to the associate justices of the other courts, as the 'puisne judges of Queen's Bench Division' and 'puisne Barons of Exchequer.' At present in England the Lord Chief Justice presides over the King's Bench Division, and serving with him are fourteen puisne judges. In India puisne judges preside in the courts of various cities and districts. The term is not employed in the United States, the word 'associate' being applied to the various justices of a court to distinguish them from the Chief Justice. See COURT.

PUJOL, pu'zhôl', ALEXANDRE DENIS. See ABEL DE PUJOL.

PUKET, pōō'kêt', or TONKA. A Siamese port on Salang or Junk-seylon Island, off the west coast of the Malay Peninsula. It is noted principally for its tin mines, the annual production being estimated at more than 2000 tons. Population, about 20,000.

PULANGUI, pu-lân'gê, or RIO GRANDE DE MINDANAO. The largest river of the Philippine Archipelago. It rises near the north coast of Mindanao and flows southward through a beautiful, fertile, and populous valley as far as Lake Liguasan, whence it turns northwest, and empties into the Bay of Ilana, at Cotabato (Map: Philippine Islands, J 12). It is over 200 miles long, navigable 70 miles for vessels drawing 3½ feet.

PULASKI, pōō-lîs'kê (Pol. *Pulawski*, pōō-lîv'skê), CASIMIR (1748-79). A Polish soldier in the American Revolution. He was born in Podolia, Poland, the son of Count Joseph Pulawski, who had a leading share in the organization of the Confederation of Bar in 1768. Casimir, who had had some military experience with the Duke of Courland, joined enthusiastically in the movement to liberate his country, and fought heroically in the unequal struggle against the Russians. He was accused, unjustly it appears, of complicity in the plot to abduct King Stanislas Poniatowski from Warsaw (1771), and in consequence was outlawed and deprived of his estates. Escaping to Turkey, he passed thence to France, where he was induced by Franklin and the French Ministry to assist the Americans against England. He arrived in Philadelphia in 1777, served first as a volunteer, and then, for his gallantry at the battle of Brandywine, was appointed Chief of Dragoons with the rank of brigadier-general. In 1778, with the sanction of Congress, he organized an independent corps of cavalry and light infantry. With this body, called Pulaski's Legion, he was ordered to South Carolina. He reached Charleston on May 9, 1779, and soon afterwards led an unsuccessful sortie against the British, under Prevost, before the city. Later in the same year he commanded the French and American cavalry at the siege of Savannah, and during the attack of October 9th was mortally wounded, dying two days later on board the United States brig *Wasp*. Consult Sparks, "Life of Count Pulaski," in *Sparks's American Biography*.

PULCHERIA, pûl-kê'rî-â (c.399-453). A Byzantine empress and saint of the Greek Church. She was the oldest daughter of the Emperor Arcadius, and from early youth was noted for ability and piety. In 414 she became co-ruler with her brother, Theodosius, who was

content to leave the management of affairs in her hands. She governed wisely, was active in condemning the Nestorian and Eutychian heresies, and promoted virtue and piety. About 446 she withdrew from the Court, but after the death of Theodosius (450) she resumed the direction of the government. Early in life she took a vow of virginity, but now, having been absolved from her vow, for State reasons, she married the general Marcian. She corresponded with Cyril of Alexandria, Pope Leo the Great, and many bishops and priests, who all speak in the highest terms of her wisdom and devotion to the Church.

PULCI, pul'chè, LUCA (1431-70). An Italian poet, elder brother of Luigi Pulci. He wrote the *Pistole*, love letters in tercets; the *Driadeo d'Amore*, a mythological poem in octaves; and the *Ciriffo Calvaneo*, a chivalrous poem in octaves, which was continued by Luigi. There is some question as to whether Luca composed any part of the poem called the *Giostra*. (See **PULCI**, LUIGI.) Consult the *Pistole* in the edition of Florence, 1481; the *Driadeo* in Torraca's *Poemetti mitologici* (Leghorn, 1888); the *Ciriffo* in the edition of Florence, 1834.

PULCI, LUIGI (1432-84). An Italian poet, born at Florence of a family once wealthy and noted in the fifteenth century for its literary attainments. Both Cosimo and Piero de' Medici were his patrons and friends, and he was on terms of intimacy with Lorenzo the Magnificent. Pulci's chief work is the romantic, chivalrous poem called by him the *Morgante* when he published 23 cantos of it at Venice in 1482, and known as the *Morgante maggiore* since the appearance of the second and complete edition of it at Florence in 1483. The great value of the *Morgante* consists in the fact that it was the first artistic treatment in Italian of the chivalrous stories of Charlemagne and his peers so long before imported from France. It marks the first important step in the direction of the chivalric poem of Ariosto. There is little unity of action in Pulci's work. It takes its name from the giant Morgante, who is converted to Christianity and accompanies Orlando (Roland) on some of his expeditions, but Morgante is by no means the chief personage of the poem. Although the *Morgante* is in no sense a mock-heroic poem, it must be admitted that in its tone it often mingles the serious with the humorous, the heroic with the vulgar, the grave with the grotesque, and piety with irreverence, and all these were characteristic qualities of the Florentine democracy of Pulci's time. The first canto of his poem was translated into English octaves by Byron. Pulci's other poetical works comprise the *Confessions*, which has somewhat the air of a parody on the Scriptures; the *Beca di Dicomano*, a burlesque imitation of the *Nencia da Barberino* of Lorenzo the Magnificent; his revision of the *Ciriffo Calvaneo* of his brother Luca, and his continuation of the octaves on the *Giostra* of Lorenzo de' Medici ascribed to Luca; some *Strambotti*, some satirical and jocose sonnets, and other shorter lyrics. In prose he wrote the *Lettere a Lorenzo il Magnifico* (Lucca, 1886) and a novel. There are several editions of the *Morgante*: the *Confessione*, the *Beca*, and the sonnets may be found in the editions of Lucca, 1759.

Consult Volpi, "Luigi Pulci, studio biografico," in the *Giornale storico della letteratura italiana*, xxii., and the *Life* prefacing Bonghi's edition of the *Lettere*.

PULILAN, pul'è-làn. A town of Luzon, Philippines, in the Province of Bulacán, situated 5 miles north of Malolos (Map: Luzon, E 7). Population, in 1896, 10,058.

PULITZER, JOSEPH (1847—). An American journalist, born at Budapest, Hungary. He was privately educated, and emigrated to the United States in 1864. He served in 1864-65 in a Federal cavalry regiment, after hardships arrived in Saint Louis, was a reporter there for Carl Schurz's *Westliche Post*, a Republican journal, and later became managing editor of the paper, in which he also obtained a proprietary interest. In addition to his activity in journalism, he studied law, and, having been admitted to practice in Missouri, became somewhat prominent in local politics, and in 1869 was elected to the State Legislature. He was also a member of the Missouri constitutional convention of 1874. In 1876-77 he was Washington correspondent of the *New York Sun*, and in 1878 purchased the *Saint Louis Dispatch*, which, combined by him with the *Evening Post* (Saint Louis) as the *Post-Dispatch*, became an important journal of the West. The *New York World*, which he acquired in 1883 and with which his name became chiefly identified, attained under his direction a very large circulation. In 1884 he was elected to the Federal House of Representatives as a Democrat from the Ninth New York District, but not very long afterwards resigned to give his undivided attention to business affairs. He made several donations to educational and charitable causes, and in 1903 provided an endowment fund for a school of journalism at Columbia University.

PULKOVA, pul'kò-vá. A village in the Government of Saint Petersburg, Russia, situated on a high ridge, about 10 miles southwest of the capital (Map: Russia, D 3). It is noted as the site of the principal observatory of Russia.

PULKOVA OBSERVATORY. A Russian astronomical observatory, in latitude 59° 46' north and longitude 30° 20' east, founded by Emperor Nicholas I. for the special cultivation of sidereal astronomy. Its construction was begun in 1835 and completed in 1839 under the supervision of W. Struve (q.v.), who then became its director. Its chief instrument was a refractor of fifteen inches aperture, which was without a rival till 1870, when a twenty-four inch refractor was mounted at the Newall Observatory in Newcastle, England. This was followed by a twenty-six-inch refractor for the Naval Observatory (q.v.) in Washington. In September, 1879, a contract was made with the firm Alvan Clark & Sons of Cambridgeport, Mass., for the construction of a refractor of thirty inches aperture for the Pulkova Observatory. The instrument was delivered in 1884, but first used for observations in 1885. This instrument is now excelled by the refractors of Lick and Yerkes Observatories. The Pulkova Observatory has also a well-equipped astro-physical laboratory. Consult: *Zum 50-jährigen Bestehen der Nicolai-Hauptsternwarte* (Saint Petersburg, 1889); *Description de l'observatoire astrono-*

mique central de Poulkova (Saint Petersburg, 1845); *Publications de l'observatoire central Nicolas* (Saint Petersburg, 1893-1901).

PULLAN, RICHARD POPPLEWELL (1825-88). An English architect and archaeologist, born in Knaresborough, Yorkshire, and educated at Christ's Hospital. He studied architecture under Richard Lane in Manchester, early devoted himself to polychromy, and with Wyatt had charge of the decoration of the Byzantine and Gothic halls of the Crystal Palace (1851). In 1857 he was sent by the architectural department of the Foreign Office to examine the Halicarnassus mausoleum and to make excavations in Cnidus (q.v.); this work is described in *A History of the Discoveries at Halicarnassus, etc.* (London, 1862-63). Pullan was employed in 1862 in excavating the Temple of Bacchus at Teos, and that of Apollo Smintheus in the Troad; and in 1869 on the Temple of Athene Polias at Priene. He built several churches in Italy, and wrote *Byzantine Architecture* (1864), *Principal Ruins of Asia Minor* (1865), *Eastern Cities and Italian Towns* (1879), and *Lectures on Christian Architecture* (1879).

PULLET. One of the many provincial names for the British edible clam (*Mya truncata*). See CLAM, and accompanying Colored Plate.

PULLET, AUNT. A leading character in George Eliot's *Mill on the Floss*, the sister of Mrs. Tulliver, a selfish invalid, who domineers over her husband.

PULLEY (OF., Fr. *poulie*, probably from LGer. *pulen*, AS. *pullian*, Eng. *pull*). A circular wheel turning on a smooth axle through its centre, and with a grooved cut in its rim so that a cord can run around it. A 'fixed' pulley is one whose axle is fixed to some support; while a free pulley is not stationary, but is carried in the bight of the cord passing over it. A fixed pulley simply changes the direction of the force

cally upward; therefore if there is equilibrium $2F_1 \cos \theta = F_2$; and the mechanical advantage, $\frac{F_2}{F_1}$ is $2 \cos \theta$. In particular, if, as is usually the case, the two branches of the cord are parallel and vertical, $\theta = 0$, and $2F_1 = F_2$.

This same formula may be deduced by considering the system displaced slightly from equilibrium, using the principle of the conservation of energy.

Fixed and free pulleys may be combined in many ways, but the principle is evident. If a continuous cord passes over a free compound pulley—made up of several independent wheels—in such a manner that there are n supporting branches of the cord, the mechanical advantage is n .

Pulleys are also made in which two toothed wheels of different radii are clamped together, so that as one turns the other must also; and the cord is replaced by a chain whose links fit into the teeth. Such a pulley is called a 'differential' one. If one wheel has in its rim N teeth, and the other $N-1$ the 'mechanical advantage' is $2N$.

The principle of the action of pulleys was first given by Stevinus. See BLOCK; TACKLE.

PULLMAN. An industrial town now forming a part of the southernmost ward of Chicago. It was founded in 1880 by George M. Pullman, who established here the extensive shops of the Pullman Palace Car Company. The town was laid out along artistic and scientific lines, with handsome brick houses, wide streets, flower gardens, a fine school building, library, hotel, and theatre, and was under the sole control of the company. The idea of the promoter was to secure for his employees all the advantages which might accrue from congenial surroundings. The high rates charged for rent, water, and gas, however, caused dissatisfaction among the residents, and in 1889 they voted in favor of annexation to Chicago. Population, at that time, about 12,000. Consult Doty, *The Town of Pullman* (Pullman, 1893).

PULLMAN, GEORGE MORTIMER (1831-97). An American inventor, born in Chautauqua County, N. Y. He worked for a time as a cabinet-maker with an elder brother in Albion, N. Y., and in 1853 took a contract for moving buildings that obstructed the widening of the Erie Canal. Six years later he removed to Chicago, where he did business as a building contractor. In the same year that he reached Chicago he remodeled two old coaches into sleeping cars. Four years later he built the first new sleeping car, 'Pioneer,' upon lines of the now famous 'Pullman' cars. In 1867 he organized the Pullman Palace Car Company, and was its president until his death. In 1880 he founded for his employees the model town of Pullman (q.v.) and attempted to make the place an ideal home for his men. In 1887 he invented and put into execution the idea of vestibule trains. He was also connected with various other industrial undertakings, and was president of the company which put into operation the Manhattan Elevated Railroad of New York City.

PULMONATA (Neo-Lat. nom. pl., from Lat. *pulmo*, lung). An order of air-breathing gastropod mollusks having no gills, but the mantle-cavity modified into a respiratory sac or 'lung,'

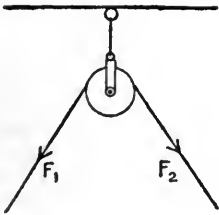

FIG. 1.

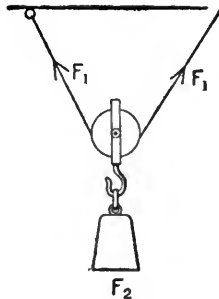

FIG. 2.

which the cord exerts. If in Fig. 1 F_1 and F_2 are two forces acting on a cord passing over a pulley, they will be equal if the system is in equilibrium.

If a free pulley carrying a weight is supported by a cord, as shown in Fig. 2, there are three forces acting on the pulley, a force F_2 vertically down equal to the weight of the pulley and the weight it carries, and two forces obliquely upward each equal to F_1 due to the two branches of the cord which passes over the pulley. If the branches of the cord make an angle θ with the vertical, $2F_1 \cos \theta$ is the total force acting verti-

with a contractile opening under the margin of the mantle. Those forms which live in the water are obliged to obtain their air supply at the surface. The heart has only one auricle and that usually lies in front of the ventricle. The nerve cords connecting pleural and visceral ganglia are not crossed. The Pulmonata are either land or fresh-water forms, except *Onchidium*. They are all hermaphroditic. The number of known species runs up into the thousands, and though they are found in all temperate regions, they abound especially in certain tropical islands, as Jamaica and the Hawaiian Islands. In America the order is represented by many species of land-snails, slugs, and pond-snails. Few species reach a large size, and most have rather plainly colored shells. See SNAIL.

PULPIT (from Lat. *pulpitum*, platform, rostrum). A piece of church furniture used for the delivery of sermons. In the first Christian ages, when the bishops were practically the only preachers, they delivered their addresses from the episcopal throne at the end of the apse; hence a pulpit is called *chaire* in French to this day. Then the ambo (q.v.) was sometimes used for this purpose, and later the jube or rood-loft between the choir and nave. By the eleventh or twelfth century small movable pulpits had been introduced, which could be brought out at the time of the sermon; and by degrees the modern pulpit, generally on one side of the nave, was evolved. There are some excellent mediæval examples in Italy, especially that by Benedetto da Majano in Santa Croce at Florence, two very fine ones by Nicola Pisano at Pisa and Siena, and another by his son Giovanni at Pistoja. The most ancient pulpits extant in France are supposed to be not earlier than the fifteenth century. Admirable examples of wood-carving are those of Saint Etienne du Mont and Saint Germain l'Auxerrois in Paris, and Sainte Gudule in Brussels. Another notable one was made for the Cathedral of Strassburg by Johann Hammerer at the end of the fifteenth century.

PULQUE, pul'kã (Sp., from Aztec *octli*). A favorite beverage of the Mexicans and of the inhabitants of Central America and some parts of South America. It is made from the juice of different species of agave (q.v.).

PULSATILLA. See ANEMONE; PASQUE FLOWER.

PULSE (Lat. *pulsus*, a beating, from *pellere*, to drive). The rhythmical expansion of the arteries due to the blood-waves caused by successive contractions of the heart. The arteries are elastic tubes and there is injected into them at each contraction of the heart ventricles from two to four ounces of blood. As a consequence, an already full but contracted artery becomes distended, lengthened, and uplifted, giving rise to the sensation in the examining finger which is called the pulse. The pulse-wave due to any given beat of the heart is not perceptible at the same moment in all the arteries of the body. The difference in time is proportioned to the distance of the arteries from the heart, and rarely amounts to more than $\frac{1}{4}$ or 1-6 of a second. The pulse is usually felt at the radial or thumb side of the wrist, the artery being near the surface at this point and easily compressed against the bone. It may, however, be perceived in many other situations, notably at the point where the

facial artery crosses the lower jaw, in the temporal artery above the ear, the carotid in the neck, the brachial in the arm, and the femoral just below the fold of the thigh.

The pulse rate varies greatly in health according to age, sex, temperament, exercise or rest, emotional states, temperature, time of day, posture, atmospheric pressure, and personal idiosyncrasy. Before birth the average number of pulsations per minute is 150; in the newly born, from 140 to 130; during the first year of life, 130 to 115; during the second year, 115 to 100; about the seventh year, 90 to 85; about the 14th year 85 to 80; in adult life, 80 to 70; in old age, 70 to 60; in decrepitude, 75 to 65. In the female and in persons of a sanguine temperament the pulse rate is more rapid by several beats in the minute than in males and individuals of a phlegmatic type. The rate is also higher after a meal and during exercise. The pulse is most frequent in the morning and becomes gradually slower as the day advances; it is more rapid in the standing than in the sitting or recumbent posture; high temperatures also accelerate it. During sleep the pulse is usually slower than in the waking state. Forty is not an uncommon rate, and instances have been known in which the pulsations were only 30 or more rarely 20 to the minute.

In disease the pulse presents wide variations in rate, regularity, volume, and tension, and is a valuable guide in diagnosis and in estimating the physical condition of the patient, and disturbances of its relation to respiration and temperature are always significant. Excessive slowness of the pulse (bradycardia) occurs in some diseases of the heart, in conditions of collapse, in meningitis, in cerebral tumors, and in jaundice. It is also observed in convalescence from acute fevers and is probably an expression of exhaustion. As a physiological phenomenon bradycardia occurs in the puerperal state, and in hunger. As a general rule in disease the pulse is more apt to be abnormally fast (tachycardia) than slow. Nearly every disturbance of health tends to quicken the pulse; rapid heart action is the constant accompaniment of acute inflammation, of fever in all forms, and of most heart diseases. When the intervals between successive beats of the heart are not of uniform length, the pulse is said to be irregular. A pulse *intermits* when a beat is dropped out of every four or more pulsations. Another form of irregularity is known as the *pulsus bigeminus* or *allarythmia*. In this the beats occur in successive pairs with an abnormally long interval between them. *Pulsus paradoxus* consists in the diminution or total disappearance of the pulse during inspiration and is a very rare occurrence.

The pulse is said to be *full* when the volume of the pulsation is greater than usual, and it is called *small* or *contracted* under the opposite condition. Fullness may depend on general plethora and on prolonged and forcible contractions of the left ventricle of the heart; a small pulse results from general deficiency of blood, from feeble action of the heart, congestion of the venous system, or exposure to cold. When very small it is termed thread-like.

The *tension* or *hardness* of the pulse is the property by which it resists compression. A hard pulse can scarcely be stopped by any degree of

pressure by the finger. Hardness is favored by a powerfully acting heart, a normal amount of blood, and contraction of the peripheral blood vessels, as for instance by cold. Softness of the pulse is favored by a feeble heart, by valvular imperfections interfering with the supply of blood to the arterial system, and by a free flow through the capillary area. A hard pulse is generally indicative of inflammation, and a soft or compressible pulse of general weakness.

The blood from the veins returns to the heart under normal conditions in a steady stream, the pulse being lost in the capillary area. Some pulsation, however, can often be seen in the larger veins near the heart, the jugular veins, for example, in many persons with a healthy circulation. The expansion of the vein is synchronous with dilatation of the ventricles, and collapse with contraction. Another kind of pulsation, in which this relation is reversed, takes place when the tricuspid valves guarding the veins become insufficient through disease. A wave of blood is sent back into the venous trunks, producing a visible pulsation. This phenomenon may also be produced by hypertrophy of the right auricle and aneurism of the aorta.

An instrument has been devised by which the variations of the pulse can be indicated upon paper attached to a revolving cylinder. See SPHYGMOGRAPHY; HEART, DISEASES OF THE; ARTERIES, paragraph *Diseases*.

PULSOMETER. See PUMPS AND PUMPING MACHINERY.

PULSZKY, pul'skê, FRANZ AUREL (1814-97). An Hungarian politician and author, born in Eperies. He studied law, and visited England, where he wrote in German and Hungarian *Aus dem Tagebuche eines in Grossbritannien reisenden Ungarn* (1837). In 1839, he entered the Diet as member from Sáros. In 1848 he became Under-Secretary of State in the Hungarian Ministry of Finance, and subsequently Minister of Commerce. After Kossuth went to England, Pulszky remained with him, and accompanied him on his journey through America, described in *White, Red, and Black* (1852) in English. He was condemned to death in *contumaciam* by the Austrian Government in 1852. After 1860 Pulszky resided in Italy. He fought under Garibaldi. In 1866 he was pardoned. After his return to Hungary he was elected to the Diet and became director of the National Museum at Pesth. His publications include: *Die Jakobiner in Ungarn* (1851), a romance; *Eletem és Korom* (1882), an autobiography; and *Die Kupferzeit in Ungarn* (1884).

PULTENEY, pult'nê, WILLIAM, Earl of Bath (1684-1764). An English political leader, born in London. He was educated at Westminster School and Christ Church, Oxford, and after traveling on the Continent, entered Parliament as a Whig in 1705. On the prosecution of Walpole in 1712, he defended him with great eloquence, and from 1714 to 1717 was his Secretary of War. In 1725, however, he joined the opposition, and became the bitter antagonist of his former friend, succeeding by the brilliancy of his speeches in depriving him of his place. Shortly after Walpole's fall in 1742 Pulteney was created Earl of Bath. On the resignation of the Pelham Ministry in 1746 he was made Premier, but, unable to form a Cabinet, he held

the office for only two days and then practically retired from public life. As a speaker, Pulteney was full of spirit and fire and showed much of the searching keenness of satire, the inexhaustible resources of ridicule and persiflage, which distinguished him as a writer. He joined Bolingbroke in establishing *The Craftsman* (1726), a political periodical, and he wrote many political pamphlets and verses, including the popular song *The Honest Jury, or Caleb Triumphant*.

PULTOWA, pul-tô'vá. A government and a city of Russia. See POLTAVA.

PULTUSK, pul'tusk. A town of Russian Poland, in the Government of Warsaw, situated on the Narev about 34 miles north of Warsaw (Map: Russia, B 4). It is a well-built town with an old castle, the former residence of the bishops of Plotzk. It is noted as the scene of an engagement between the Russians and the French in 1806. Population, in 1897, 15,900.

PUMA (Peruvian name), COUGAR, or MOUNTAIN LION. A large American cat (*Felis concolor*) originally native from the watershed of Hudson Bay to the Straits of Magellan, and still present except in the most civilized parts of the country. It is of slender build, with a rather small head and long limbs, and usually measures about 40 inches from the snout to the root of the tail, which usually is about 26 inches in length, and of nearly the same thickness throughout. Unlike the other great American cat, the jaguar (q.v.), which is densely spotted, the adult puma has no spots, except that the lips and the outer rim of the ear are black, there is a patch of white on each side of the muzzle, and the tip of the tail usually is blackish. The upper parts are uniform dull fox-red, appearing gray in certain lights, owing to the fact that each hair is fawn-gray, red only at the tip; the throat, belly, and inside of the legs are reddish-white. This unspotted, tawny coat led the earliest explorers on the Atlantic coast to regard the animal as a lion, and the name survives in the West. The early settlers in the States called it a panther (usually pronounced 'painter'). 'Congar' is derived from a Brazilian language, but involves an error. (See COUGAR.) 'Puma' was its native name in Peru. Considering that the species is distributed over so great a range of territory, its variations in form and color are surprisingly small.

In the Eastern United States it has been greatly dreaded as a fierce and treacherous beast, particularly dangerous because of its alleged habit of springing upon travelers from branches of trees or rocky ledges. When attacked it was courageous in resistance, and the killing of one was justly considered evidence of skill and courage. In the West, on the other hand, the mountain lion, although more numerous in the Rocky Mountains than the panther ever appears to have been in the East, has always been regarded as a shy and cowardly beast, little to be feared, except when cornered. The truth seems to be that this animal has less ferocity than any other of the great cats, and under ordinary circumstances is inclined to avoid rather than to attack men, and often seems to seek their company in a friendly way. This timidity and confidence aided the easy extinction of these animals throughout the eastern part of the country, but they are still

abundant in the Rocky Mountains, and westward, where the ranching industries supply them with abundant food in the young cattle and horses. The principal food of the puma in North America was deer, but it seized any smaller prey which came in its way. The mode of hunting was by lying in wait for or creeping within leaping distance of the victim and then springing upon it. In the case of sheep, to which in the South-western United States it is especially destructive, the puma rarely contents itself with taking a single one, which would satisfy its hunger, but, having once entered a fold or flock, it kills right and left, so that in many cases a hundred sheep have been killed out of a flock in one night by a single puma. Their silence when hunting or when attacked is a notable characteristic; yet on rare occasions, in winter nights, they make the woods resound with terrifying screams. The young are born in the early spring, and are usually two or three in number; and it is believed that under natural conditions most pairs breed only once in two years. The kittens at first are covered with black spots and stripes, and their tails are ringed. These markings disappear at the end of about six months, after which they become of the uniform color of their parents. Full size is not attained before the end of the second year, and during all this time they associate with the mother, while the father of the family seems to lead a solitary existence. Like other cats, their hunting is entirely at night.

BIBLIOGRAPHY. True, "The Puma," an illustrated monograph with full bibliography, in *Annual Report Smithsonian Institution* (Washington, 1889); Merriam, *Vertebrates of the Adirondacks* (New York, 1893); Porter, *Wild Beasts* (New York, 1894); Baillie-Grohman, *Fifteen Years . . . in the Hunting Grounds of Western America* (London, 1900); Alston, *Biologia Centrali-Americana* (London, 1879-82); Hudson, *The Naturalist in La Plata* (London, 1892). See Colored Plate of CAT FAMILY, accompanying article LION.

PUMBLECHOOK, pūm'b'l-ehōōk, Mr. Uncle to Joe Gargery in Dickens's *Great Expectations*, a fishy-eyed, pompous man, who bullied Pip when he was poor, but was most servile when he came into his money.

PUMELO. See GRAPEFRUIT.

PUMICE (from Lat. *pumex*; probably connected with *spuma*, foam). An effusive igneous rock, having a spongy or frothy texture, and composed largely or entirely of glass. It is frequently made up of parallel fibres or threads with intervening spaces to form a delicate structure. It is produced by the expansion of the occluded moisture of lavas when they reach the surface of the earth, and is most abundantly developed in lavas of rhyolitic composition (see RHYOLITE), since these are usually very viscous. It may, however, be exceptionally produced in connection with any effusive rock, and is hence classified in respect to its chemical composition into rhyolite pumice, trachyte pumice, and the like. Pumice is extensively used in the manufacture of tooth powder and other abrasive materials. Most of the commercial product is derived from the Lipari Islands.

PUMP. See PUMPS AND PUMPING MACHINERY.

PUMPHELLY, RAPHAEL (1837—). An American geologist, born in Owego, N. Y., and

educated in Hanover, Germany, and in the mining schools of Paris and Freiberg, from 1854 to 1860. After explorations in Corsica and in Arizona, he received in 1861 a commission from the Japanese Government to explore the mineral wealth of the island of Yesso. In February, 1863, under pressure of the anti-foreign party, the Shogun dismissed the foreign employees who were "spying out the land." Pumpelly then went to China, and, having been commissioned by the Chinese Government to report on the coal supply of the Empire, he made journeys through the central and northern provinces and into the Desert of Gobi. Upon the completion of this work in 1864, he spent a short time in Nagasaki, and then returned to Europe by way of Siberia. The Smithsonian Institution published a volume recording his geological researches in China, Mongolia, and Japan, and this was supplemented by a popular narrative of his travels and adventures entitled *Across America and Asia* (1870). Upon his return to the United States Pumpelly was appointed professor of mining in Harvard University, an office which he held from 1866 to 1873. During a short period he was the State geologist of Michigan and then of Missouri, and in 1879 he entered the service of the United States Geological Survey. In 1879-80, he conducted at Newport, R. I., an investigation for the National Board of Health on the filtering ability of various soils. In 1881 he organized an important trans-continental survey through the northwestern territories of the United States. In 1884 he again entered the United States Geological Survey. In 1903 he left this country for the purpose of making observations in the Trans-Caspian country under the auspices of the Carnegie Institution of Washington. His publications include: *Geological Researches in China, Mongolia, and Japan*, published by the Smithsonian Institution (1866); *Across America and Asia* (1870); *Geology of the Copper District of Michigan* (1875); *Iron Ores and Coal Fields in Missouri* (1873); "The Mining Industries of the United States," in vol. xv. of the *United States Census Report* (1886); and *Geology of the Green Mountains* (1894).

PUMPKIN (variant of *pumpion*, from OF. *pompom*, variant of *pepon*, from Lat. *pepo*, from Gk. *πέπων*, *pepōn*, kind of melon, ripe; connected with Skt. *pakva*, ripe, from *pac*, to cook; influenced by popular etymology with the Eng. diminutive termination *-kin*). The common name of several annual, vine-like, tendril-bearing herbs of the genus *Cucurbita*, family Cucurbitaceæ, natives of warm countries, cultivated for their fruits. The common field pumpkin (*Cucurbita Pepo*) is a coarse running, rough-leaved vine, often exceeding 20 feet in length. The fruit is gourd-like, oblong with flattened ends, yellow when ripe, and normally weighing from 15 to 40 pounds. The edible portion consists of a fleshy layer an inch or more thick beneath the rind. In America the pumpkin is extensively planted in corn-fields in occasional hills of corn. In its raw state the fruit is used as a cattle food, and, after having its hard outer rind and seeds removed, for making pies. The method of cultivation are the same as for squash (q.v.). See Plate of CUCUMBER ALLIES.

PUMPKIN INSECTS. See SQUASH INSECTS.

PUMPKINSEED. See SUNFISH.

PUMPS AND PUMPING MACHINERY

(Of., Fr. *pompe*, Ger. *Pumpe*, *Plumpe*, *Plumpfc*; possibly, though very doubtfully, connected with Lat. *plumbum*, lead). Devices used to move liquids and gases. The various kinds of pumps, without regard to their motive power, may be broadly classified as follows: (1) Bucket lifts, or water elevators, by means of which a balanced pole, or sweep, a windlass, or a wheel, lowers, raises, and empties one or more buckets or other receptacles. (2) Displacement pumps, acting on the principle that two bodies cannot occupy the same space at the same time. (3) Impellers, which by their own continuous motion in the water to be moved impart some of their velocity to water with which they come in contact. (4) Impulse pumps, which employ the force of a suddenly arrested large column of water to lift a smaller column to a greater elevation than the original source. See HYDRAULIC RAM.

BUCKET LIFTS, or WATER ELEVATORS. These are the simplest of the four classes of pumps named. They have been used from the remotest historical times and are still employed in varying forms the world over. The well sweep, or bucket and balanced pole, still frequently seen in certain rural sections of America, is much the same as the shadoof of Egypt and the paecottah of India. The single bucket or, in Oriental countries, the earthen pot, attached to a rope, wound around a windlass, is another very common water lift. A series of buckets mounted on an endless rope or chain, dipping into the water below, and running over and driven by a wheel above, is an improvement over either of the foregoing, giving a continuous stream of water. Primitive multiple bucket or pot lifts of this general character, driven by animal power acting through a rude combination of wheels and horizontal sweeps, are sometimes known as *Persian wheels*. Modern refinements of this device are called *chain pumps*. Sometimes the wheel carrying the buckets is placed in and driven by a running stream. Another form of water lift is the scoop wheel, composed of a series of curved blades, terminating in a hollow axle, into which they discharge the water scooped up by the revolution of the wheel. Where similarly arranged curved tubes take the place of the blades the device is called a *tympanum*. Of the various water lifts described the bucket and chain pumps are most extensively used, particularly where manual labor is costly.

DISPLACEMENT PUMPS. In their most common form they employ a piston to push water ahead of them in a cylinder which the piston tightly fits, or else a plunger which does not wholly fill the cylinder, instead of forcing all the water in the cylinder ahead of it, merely displaces a volume equal to that of the plunger itself. Instead of a piston, steam or air may be used to effect the displacement. Valves are an essential feature of displacement pumps, and may also be used on the outlet end of impeller or centrifugal and jet pumps, to prevent back pressure when the pumps are not running. In the simplest form, as in the ordinary suction lift pump, described below, valves are nothing more than pieces of leather or rubber, cut to the desired shape, and hinged at one edge or side. They lift for the passage of the water upward and close on the reverse stroke of the piston in order to prevent a reverse flow. In most large pumps

many small valves are employed, instead of one of sufficient size to accommodate the whole flow of water. This reduces the shock and jar due to the sudden opening and closing of the valves. The majority of such valves consist of an inlet, valve seat, disk, or valve proper, stem, cover plate, and spring, although the spring may be omitted. The disks are commonly made of vulcanized india-rubber, and the other parts of bronze. Ball and cone valves are also used, particularly on deep

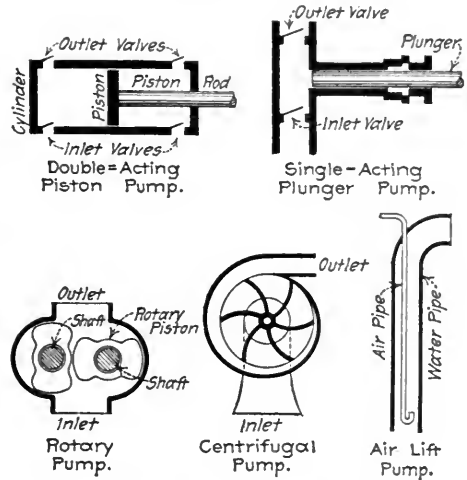

PUMPING MACHINERY—TYPES OF PUMPS.

well pumps. The Reidler valve, a German device used on some of the highest grades of American and foreign pumps, employs only one valve on each inlet or outlet, which is closed mechanically, instead of by the force of the liquid being pumped, and therefore has a positive and comparatively gentle motion, combined with a single large waterway of ample capacity. Valve stems control the lift of the valves and prevent displacement from their seats, while the springs are designed to take up slacks. When the only function of a valve is to prevent back pressure, or flow, a single check or flap valve may be used.

Displacement pumps are subdivided into many classes, of which the following are the most important: *Reciprocating pumps* have either pistons or plungers which move alternately back and forth or up and down, always in a straight line. Such pumps are single or double acting, according to whether the water is displaced on one or both parts of the stroke. They are also known as *direct-acting* when the motive power is applied in a direct line with the movement of the piston or plunger, and as of the *crank-and-fly-wheel* type, or the beam type, when either of these devices is employed to transmit the motion. The beam is similar to the walking-beam of some steamboats and is an essential feature of the old Cornish beam engine. (See STEAM ENGINES.) Pumps are known as *simple*, *duplex*, *triple*, etc., according as one, two, or more pistons or plungers are driven by a motive power unit. Beam pumps are rapidly diminishing in relative numbers. Crank-and-fly-wheel pumps are quite extensively used, particularly for high duties and for power pumps. Direct-acting pumps are very common. While large numbers of simple pumps are in use, duplex and triple, but more particularly du-

plex, are the rule, except for small sizes and special purposes. *Rotary pumps* have revolving instead of reciprocating pistons. Two pistons revolve on parallel axes. Their longitudinal surfaces are formed into a series of curves, so they mesh closely on the inside as they revolve, while their outer parts fit tightly against a curved pump chamber. *Screw pumps* displace water when revolved in a chamber with proper inlets and outlets. *Chain piston pumps* are a simple type, consisting of a series of pistons mounted on an endless chain. Both pistons and chain pass upward through a vertical cylinder, forcing water ahead of them, then descending again to repeat the process. The *Pulsometer* is a more elaborate apparatus, in which the pump and motive power are combined. The displacement is effected by means of steam, acting in two connecting chambers. On admitting steam into one of these the water is forced out gradually, but with the increasing wall area to which the steam is exposed with the expulsion of the water the steam is condensed, a vacuum is created, more water rushes in, and the steam is automatically turned into the other chamber, whereupon the process is repeated. Such pumps are very largely used by contractors and others for pumping dirty water, or even water containing mud and small stones, on account of their comparatively simple construction and great durability.

The work done by a pump, when the pump is placed above the level of the water to be raised, and at the same time below its final elevation, is frequently classified as suction-lift for the first part, and force-lift for raising the water above the pump level. Pumps may perform either suction or force lift alone, or the two combined, according to their location.

The accompanying diagram represents the ordinary suction pump. A is a cylinder, which is called the barrel; with it is connected at the bottom a pipe, B, which communicates with the water to be raised; and at its top is another pipe, C, which receives the water raised. In the barrel are placed two valves, D and E. D opens upward and is fixed in position at the bottom of the barrel; E also opens upward and is attached to and forms part of the piston F, which moves up and down the barrel when motive power is applied to the rod G. When the valve E is opened, water or air can pass through it to the upper side of the piston; but when shut, none can pass from one side of the piston to the other. The other valve, D, is similar to it in all respects. On moving the piston up the barrel, the valve E closes, owing to the atmosphere pressure above it; no air can pass from above it into the part of the barrel from which it is moving. The air contained in the lower part of the barrel becomes rarefied, by having to occupy a greater space, and exerts less pressure on the valve D at the bottom of the barrel than the air in suction pipe B below it. This valve is thus opened, and the air from the suction pipe enters the barrel; so that when the piston has arrived at the top, a volume of air equal to the contents of the barrel has passed from the suction pipe into the barrel. When the piston descends, it compresses the air in the barrel, which shuts the valve D; and when the density of the compressed air becomes greater than that of the atmosphere, the valve E in the piston is forced open, and the air in the barrel passes to the upper side of the piston. The next upward

stroke of the piston again draws a like quantity of air from the suction pipe into the barrel; and, as none of this air again enters the pipe, but is passed to the upper side of the piston by its downward stroke, the suction pipe is by degrees emptied of the air it contained. During this process, however, motion has taken place in the water at the foot of the suction pipe. The surface of the water at H is pressed upon by the weight of the atmosphere with a pressure of about 15 pounds on every square inch; and, by the laws of fluid pressure, if an equal pressure is not exerted on the surface of the water in the suction pipe, the water will rise in it, until the pressure on the surface, plus the weight of its fluid column, balances the pressure of the atmosphere on the surface H outside; so that, as the air in the suction pipe is rarefied, the water rises in it, until, when all the air is extracted from it, the water stands at the level of the valve D. By the next upward stroke of the piston, the barrel being emptied of air, the water follows the piston, and fills the barrel as it filled the suction pipe.

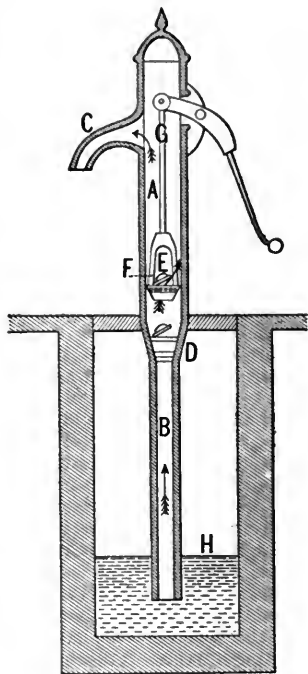

SINGLE SUCTION PUMP.

The pressure produced by the downward stroke shuts the valve D, and forces the water in the barrel through the valve E. The succeeding upward stroke carries this water into the pipe above, and again fills the barrel from the suction pipe. In like manner, every successive upward stroke discharges a body of water equal to the content of the barrel into the pipe above it, and the pump will draw water as long as the action of the piston is continued.

The ordinary forms of lift and force pumps are very similar to the suction-lift pump before described, with this exception, that the valve represented by E, instead of being fixed on the piston, is placed in the discharge pipe, the piston itself being solid. The water is drawn up into the barrel by suction in the manner just described in the suction pipe, and then the pressure of the piston in its downward stroke forces it through the outlet valve to any height that may be required.

In these pumps it will be observed that the water is forced into the ascending pipe or column only on the downward stroke; it will thus be discharged in a series of rushes or jerks. As it is a great object to procure a continuous discharge, both for its convenience, and for the saving of

the power wasted by the continual acceleration and retardation of the ascending column, various methods have been used for that purpose. The most common is the air chamber, which is an airtight receptacle fixed vertically on the discharge pipe; the water forced into the pipe by the down stroke compresses this air, which, acting as a spring, returns this force to the ascending column during the period of the up stroke, and so, by taking the blow of the entering water, and returning it gradually, equalizes the pressure, and renders the discharge uniform.

If in place of a piston, which fits the pump cylinder tightly, a plunger rod smaller than the cylinder be used, working in a water-tight packing or stuffing box and discharging through an outward opening valve at the other end, we have a simple force pump, which may at the same time be made very powerful. It will be understood that the pistons or plungers may work in either a horizontal or vertical direction, giving rise to the terms horizontal and vertical pumps, and that, as already mentioned under valves, most of the large displacement pumps have a number of small inlet and outlet valves, instead of one large one.

IMPELLER PUMPS include the centrifugal and the jet types. *Centrifugal pumps*, in their simplest form, consist of a series of vanes, or blades, mounted radially on an axis, and inclosed in a chamber. The centrifugal action of the revolving blades throws the water through the outlet pipe. The present accepted curved vanes tend to convert the machine into a screw pump, with displacement due to pressure. Centrifugal pumps are generally confined to raising water to comparatively small elevations, but they may be employed for higher lifts, although not so economically as some form of displacement pump. *Jet pumps* make use of a jet of steam or water, which, being delivered at high velocity through a small throat imparts some of its velocity to the water to be moved. The *air lift* has been classed by some as a displacement, and by others as a jet pump. It seems more correct to say that its action depends upon the formation of a column of water and air, which, because of its lesser specific gravity or weight, is overbalanced, or raised, by a column of water. Two tubes are employed, the smaller of which is centered within the larger. The small inner pipe conveys compressed air down into the volume of water to be lifted. The air and water together rise up through the outer and larger tube. This device is used oftentimes as a substitute for deep-well reciprocating piston pumps, which require the placing of a pump deep in the well and

connecting it by means of a long piston, or pump rods with some sort of motive power at the surface. Air-lift pumps are cheap in first construction, simple in operation, and have no wearing parts, but their fuel economy is low.

As steam lifts thousands of times more water than any other artificial agent, the term pumping engine, and even the word pump alone, is often employed to denote the combination of a pump and a steam engine in one machine; while when a pump is driven by detached motive power, even if that power be steam itself, the pump is termed a power pump—that is, one operated by independent power. There is a tendency to confine the term 'pumping engine' to more or less elaborate machines of large capacity, and to confine the use of the term 'steam pumps' to those of smaller capacity and simpler design, but there is no hard and fast line between the two. Other motive powers for pumps are electricity, gas, gasoline, and oil engines. With the exception of the steam pumping engine, the various motors employed to drive pumps will not be described further in this article, and most of the principles involved in the steam end of pumping engine will be explained under STEAM ENGINE.

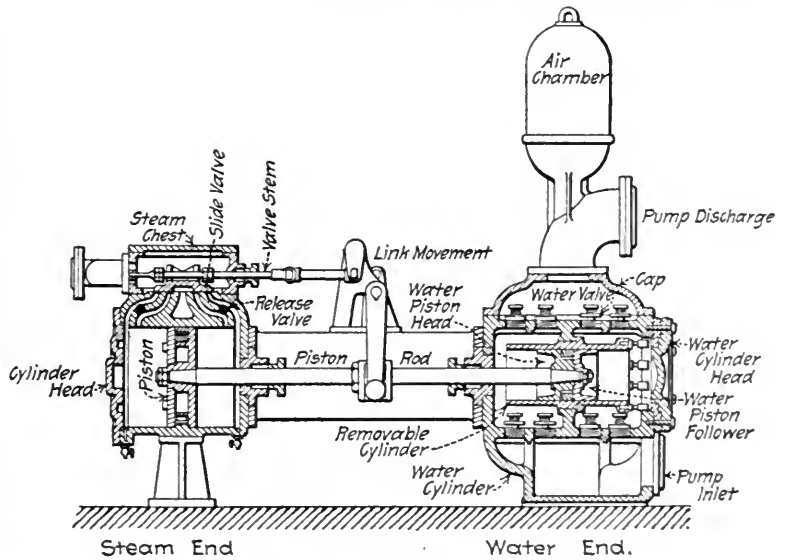

SECTION THROUGH SMITH-VAILE STEAM PUMP.

STEAM PUMPING ENGINES. The simplest of these machines consists of a single steam and a single water cylinder, with a common piston, but this type did not come into use until ponderous beam engines had been employed for scores of years. All steam pumping engines have pumps of the displacement type. The steam end of the pump may use the steam at its initial pressure through the whole length of the stroke, when it falls in the simple, high-pressure type. If now the steam, after having done all possible work in the first cylinder, is admitted to a second one, still further service may be secured and the machine becomes compound. A third, or even a fourth cylinder may be used, in which case the terms triple and quadruple expansion are employed. If it is desirable to obtain still higher degrees of expansion, cut-offs are employed, so the steam is shut off when the stroke of the pis-

ton is but partially completed. The balance of the stroke is due to the expansion of the steam in the cylinder and is a gradually decreasing pressure. (See STEAM ENGINE.) In the direct-acting pumps the piston speed is maintained through the whole stroke by means of a compensating device. One of the best known of these, the Worthington high-duty attachment, employs an accumulator for this purpose, consisting of an oscillating piston. During the first part of the stroke the forward end of the pump piston forces the oscillating piston against water pressure. When the steam is cut off this pressure is automatically released, and, through proper mechanism, is utilized during the completion of the stroke, while the steam is expanding. In place of this device another manufacturer employs a portion of the high pressure of one side of a duplex engine to aid the expanding steam on the other side. Where a fly-wheel is employed it

following figures from Turneure's *Water Supply*, based on the duty per 1000 pounds of steam: High duty, 168-100 millions; ordinary pumping engines, 100-75 millions; steam pumps, 40-10 millions; direct-acting deep-well pumps, 6-2 millions; vacuum pumps, 8-2 millions; jet-pumps, 4-1 million foot-pounds. Power pumps, with direct connecting engines, the pumps alone having an efficiency of 75 per cent., are ranked at 114 to 37 millions according to the type of engines. The air-lift pumps, with a pump efficiency of 25 per cent., are figured to give duties of 31,000,000 to 6,000,000 foot-pounds per 1000 pounds of steam, with various styles of air compressors. The theoretical efficiencies of the above three classes of pumping apparatus (i.e. pump and motive power combined) range from 20.6 per cent. for the high duty engines to 0.13 per cent. for the jet pumps, 14.7 per cent. for the triple-expansion condensing engines and power pumps, 4.8 per cent. for simple high-speed condensing engines and power pumps, and 4 to 0.77 per cent. for air-lift pumps.

HISTORICAL SKETCH. The earliest authentic record of a displacement pump, or of any improvement over the water lifts, seems to be a description of the force pump of Ctesibius of Alexandria, in Hero's *Spiritualia*. Two single-acting vertical pumps were operated alternately by a common beam, or brake, and the two discharge pipes were connected with an air chamber and the stream was then thrown from a movable nozzle. Hero also described another device for raising water, in which the expansive power of steam, acting in a closed vessel, was made to displace or lift water. In the fifteenth century there is evidence of the frequent use of hand pumps in wells, and, in fact, it seems that they may have been well known over a thousand years earlier, for a German translation of *Vegetius* (Erfurt, 1511) contains an illustration of a suction-lift pump, with a rectangular barrel. The original of this work was dedicated to Valentinian II. (A.D. 375-392). The substitution of a plunger for a piston, in the ordinary force pump, is credited to Sir Samuel Moreland, who obtained an English patent on the device in 1675. His plunger passed through a stuffing box on the upper end of the vertical pump cylinder, while a double-acting force pump, differing somewhat in principle from the one just suggested, was described by La Hire in 1716, in the *Memoirs of the French Academy*. The rotary piston pump dates from the sixteenth century, or earlier. Servièrre (born at Lyons in 1593) describes a number of rotary pumps, including a double interlocking piston pump. The rotary displacement pump has been but little used, and when now employed it is generally for such service as fire protection, where economy of operation is a comparatively minor consideration. See FIRE-ENGINE.

The invention of the centrifugal pump is ascribed to Lemour, who, in 1732, sent to the French Academy a description of a very elementary hand pump of this type. An inclined tube was joined to the lower end of the axle and the whole was revolved by a crank at the upper end of the axle. One of the earliest centrifugal pumps to come into practical use was constructed in Massachusetts, in 1818, and was known as the Massachusetts pump. It was like a fan blower, with four right-angled blades. From this

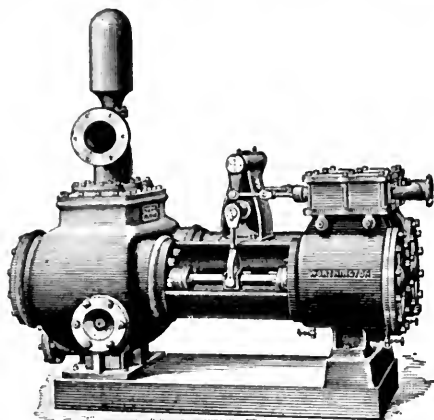

WORTHINGTON PLUNGER AND RING PATTERN PUMP.

affords all necessary compensation, exactly as in the steam engine. The Holly-Gaskill is the best-known type of a horizontal fly-wheel pumping engine and the Leavitt and Allis engines illustrate the vertical type. The object of these various devices is to secure greater economy in the use of fuel, to which end an increased first cost of construction, or capital outlay, is undergone. Such engines are classed as high duty.

The duty of a pumping engine was formerly expressed in millions of pounds of water lifted one foot high by the consumption of 100 pounds of coal. Since coal is variable in quality, there was substituted for it as a basis the work done by 1000 pounds of dry steam; and as a further refinement, the work done by 1,000,000 British thermal units (B.T.U.). The two last give results that are fairly comparable for ordinary conditions, but, whereas 1000 pounds of dry steam, in a high-grade pumping engine, have yielded about 150,000,000 foot-pounds, the duty of the same engine, based on 100 pounds of coal, was about 168,000,000 foot-pounds. On the coal basis the duty of pumping engines has increased, in round numbers, from 6,000,000 foot-pounds for the Newcomen atmospheric pumping engine of 1769 to 178,000,000 foot-pounds for the best crank-and-fly-wheel triple-expansion pump of the present day. The wide range of efficiency of various types of pumps now used is shown by the

PUMPING MACHINERY

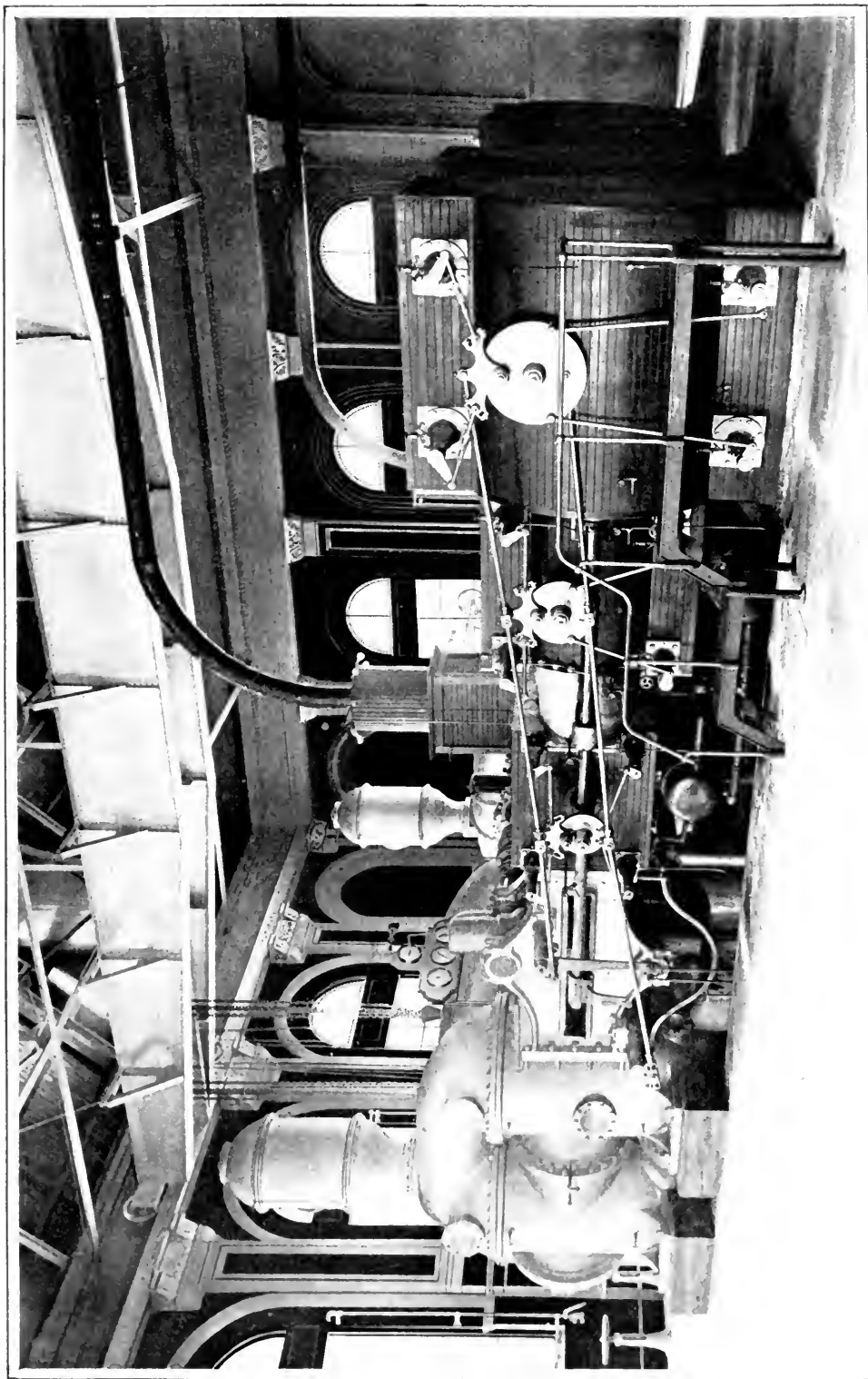

HIGH-DUTY WORTHINGTON TRIPLE-EXPANSION PUMPING ENGINES
Baltimore Water-Works High-Service Pumping Station
(Each Caselet of each section, 17,500,000 gallons.)

time to the middle of the century centrifugal pumps were brought out from time to time, including the Gwynn, Andrews, and Appold. The last was exhibited in England in 1851. It was a great improvement over all others up to that date and has been a basis for many of the most successful centrifugal pumps built since that time.

A crude form of water pressure pump was described by Fludd in 1618. A column of water was raised by means of a vertical piston, driven by the weight or pressure of a second and higher column. Valves were provided in the delivery tube, much as in the ordinary suction and force lift pump. An automatic three-way cock cut off and wasted the pressure water, whereupon the piston fell by its own weight. About 1739 Belidor introduced in some French mines what might be termed a single direct-acting horizontal water pressure engine, much like the simplest form of steam pump of the present day. When the pressure water, which in this case was also the water being pumped, had forced the corresponding piston to the end of the stroke, the water was automatically diverted beneath both pistons to the air chamber with which the pump was provided, and also to the other end of the pump. This reversed the stroke of both pistons, whereupon the operation was repeated.

The use of compressed air to raise water, the air itself also being compressed by a column of falling water, is described by Hero in his *Spiritualia*; this, while showing a knowledge of the principle, was merely a toy. In 1695 Denis Papin of Blois, France, utilized a waterfall to compress air and attempted to transmit the air about a mile to a mine and there drive a piston pump. The leakage and friction were so great that the attempt failed. Papin did not try to apply the air pressure directly to the water to be lifted, as described by Hero, but such an application was effected at a mine in Schemnitz, Hungary, in 1755, and continued in use for many years. In this case water was lifted from a shaft 104 feet beneath the surface by water from a spring 140 feet above the mouth of the shaft. The spring water compressed air in a strong copper cylinder at the mouth of the shaft, which, being piped to a second cylinder at the base of the shaft, forced the water up and out through another pipe. The valves connected with this apparatus were operated by hand. A number of patents for raising liquids by ejectors were granted in the United States between 1860 and 1870. At present, where compressed air is used to raise water the compression is effected by air compressors (q.v.). The air is applied in one of three ways: (1) Simple displacement; (2) as a substitute for steam in pumping engines; (3) in the air-lift pump. In all these three cases air is thus used because of its greater mechanical convenience under special conditions, or because of the readiness with which it may be conveyed through pipes at remote and inaccessible points. One of the principal examples of air displacement apparatus now in use is the *Shone ejector*. It was invented by I. Shone, of Wrexham, England, who brought it before the public in 1878. Although available for other purposes, it is chiefly used to lift sewage from relatively small isolated districts. The sewage is received in an air-tight chamber, provided with valves on both the inlet and outlet pipes. Compressed air from a central

station rushes in and displaces the sewage in the chamber. The falling sewage, when the chamber is empty, automatically shuts off the air supply. The Liernur system of removing house wastes, developed about the same time as the Shone, makes use of a vacuum instead of compressed air. By this means the wastes are, from time to time, sucked into central chambers, and from there to a single central station, where the air-exhausting pumps are located. (See SEWERAGE.) The vacuum principle, as used in vacuum pumps, is used for other purposes, but the efficiency of these machines is low and their general scope of application is otherwise limited.

The air-lift pump was suggested by Freiburg, in a pamphlet published in 1797; described in an English translation (1876) of lectures on mining by Callon; patented by Jos. P. Frizzell, of Boston, in 1880; and used in Berlin, Germany, about 1885. About the latter date, Professor Elmo G. Harris, of Rolla, Mo., developed an air lift. But the introduction of the device to practical use was largely due to Julius G. Pohle. This man, with a Mr. Hill, made various applications of air to raising water, beginning in 1886. In 1888 Pohle exhibited an air-lift pump at Alameda, Cal., and in 1892 he secured patents on it. In the following ten years the Pohle and various other air-lift pumps were adopted for raising water from deep wells at many municipal and private water-supply plants.

The development of the steam pumping engine was foreshadowed by the steam fountain of Hero; the improved steam fountain of the Italian Porta, described by him in 1601, in which a separate boiler was used; and the inventions of the Marquis of Worcester, who is supposed to have been the first to put this device in practical operation for raising water intermittently. He also used a separate boiler and displaced water intermittently from a closed vessel by steam pressure. In 1663 Worcester secured patents on an improvement of this device. A separate boiler supplied steam alternately to two vessels placed over the water to be lifted and connected thereto by means of pipes. The condensation of steam in the vessel created a vacuum, whereupon atmospheric pressure filled this chamber with water from below. Meanwhile steam displaced the water in the other vessel. This was a forerunner of the pulsometer pump, described above.

Next in order of importance among those to whom we are indebted for the pumping engine comes Thos. Savery, who in 1698 patented the first pumping engine used to drain the mines of Cornwall. In 1702 he published a pamphlet, *The Miners' Friend*, in which he described his device and its advantages. The water-raising features of this machine were essentially the same as those of Worcester, but Savery added a surface condenser and a second or feed-water boiler. In 1690 Denis Papin suggested steam as a substitute for gunpowder to move a piston. In 1705 Thomas Newcomen, John Calley, and Savery patented a pumping machine which combined a steam piston, outside condenser, balanced beam, pump rods, and a bucket piston pump. On applying the condensing jet a vacuum was created beneath the piston, whereupon atmospheric pressure forced the piston down and with its fall the steam end of the beam also fell, while the water end, with the pump rods and pump, was lifted. When steam was admitted beneath the piston, the

atmospheric pressure was balanced and the pump rods fell. It is claimed that Newcomen and Calley were under no obligations to Savery, but gave him an interest in this patent to avoid threatened legal complications. However this may be, the numerous engines of the sort subsequently built were known as Newcomen atmospheric engines. Smeaton made great improvements in the Newcomen engine, but it was James Watt who, during the second half of the eighteenth century, transformed the atmospheric into the steam engine. (See STEAM ENGINE.) Watt left the pump end of the mechanical device much as he found it. Toward the close of the eighteenth century the use of the steam engine had been confined almost wholly to the raising of water, and the most notable steam pumping engines thus far developed had been erected in the mines of Cornwall. From 1800 to 1840 various improvements in these machines were made and the term Cornish engine came into use. The pump end changed from the bucket piston lift to the plunger force pump. The ponderous beam still remained, and though in ordinary municipal water-supply practice the long and heavy pump rods were not required, the Cornish beam pumping engine was, at best, a cumbersome device.

In 1840 Henry R. Worthington, of New York, while experimenting on the application of steam to canal navigation, invented the direct-acting steam pump to feed his boilers. In 1841 this new type, the first practical application of steam in this way, was patented. In 1845 the manufacture of such pumps was begun in South Brooklyn, and in 1850 Mr. Worthington submitted a number of small low-lift valves for the single high-lift valve previously employed. In 1855 the first direct-acting Worthington pump for water-works service was put in use at Savannah, Ga. In 1857 an unsuccessful attempt was made to secure the adoption at Brooklyn of a new departure in pumping engines, namely, the duplex pump; but it was not till 1863 that the first duplex Worthington pump was erected. This was at Charlestown, Mass., and it had a capacity of 5,000,000 gallons a day. In 1884 the Worthington high-duty pump attachment, already described, was perfected by C. C. Worthington of the firm of H. R. Worthington. The original device was invented by J. D. Davis in 1879 and subsequently bought by the firm just named. The Worthington pumps are of the horizontal type, and the illustration shows a Worthington pumping machine installed at the Baltimore water-works high-service pumping station and delivering 17,500,000 gallons of water daily.

A high-duty pumping engine, designed by I. P. Morris of Philadelphia, was installed at Lowell, Mass., in 1873. It was a vertical compound, having the two steam cylinders under one end of the beam and the pump and fly-wheel under the other end. It had a daily capacity of 5,000,000 gallons and gave a duty of 93,000,000 foot-pounds per 100 pounds of coal. In the same year (1873) another type of high-duty pumping engine, after designs by E. D. Leavitt, Jr., of Cambridgeport, Mass., was tested at Lynn, Mass. It showed a duty of 104,000,000 foot-pounds per 100 pounds of coal. This was the first of a series of high-duty fly-wheel engines designed by Leavitt, which changed, later on, from the compound, or double, to the triple expansion type. One of these pumping engines, built for the Calu-

met and Hecla Mining Company, in Michigan, has a daily capacity of 60,000,000 gallons. For a high-lift and high-duty pump this is believed to be unsurpassed in size.

Another name connected with the development of pumping engines is that of George H. Corliss, of Providence, R. I. He erected a compound engine, with double-acting pump plungers, at Pawtucket, R. I., in 1878, which gave a duty of 127,000,000 foot-pounds per 100 pounds of coal. The pump end had annular bronze valve disks only 1-32 inch thick. The diameters of the valves are $2\frac{1}{4}$ inches, and the lift 1 inch. The aggregate area of the valves is equal to the area of the plungers. A type of fly-wheel pumping engine which has been very widely used in the United States is the Holly-Gaskill, invented by H. F. Gaskill, of Lockport, N. Y. The first of these was erected at Saratoga Springs, N. Y., in 1882. It had a capacity of 4,000,000 gallons a day and showed test duties ranging from 102,000,000 to 113,000,000 foot-pounds per 100 pounds of coal. It was a compound, horizontal, crank-and-fly-wheel engine with double-acting plunger pumps.

Another class of high-duty pumping engines is commonly known as the Allis, from the makers, and is frequently named from the chief engineer of the builders, Edwin Reynolds. The first pump of this type was built in 1886 for the city of Milwaukee, Wis. The three pumps and single-acting plunger, the engines are triple-expansion, and the cranks are placed on the axle at the angles of 120° with each other, in order to so vary the time of the stroke of each pump as to give a continuous flow of water. This pumping engine gave a test of 129,000,000 foot-pounds per 100 pounds of coal, which has been greatly exceeded by later Allis machines, one of which is shown on the accompanying plate.

MUNICIPAL PUMPING PLANTS. In 1582 a Dutchman named Peter Maurice erected a large pumping plant at London Bridge for the water supply of London. A current wheel drove 16 force pumps, each 17 inches in diameter and 30 inches long. By this means 216 gallons of water per minute, or 311,000 gallons a day, were raised to a cistern at an elevation of 120 feet, from which buildings near by were supplied through lead pipes.

The earliest pumping plant in America, or at least the earliest one on record as supplying water for municipal purposes, was built at Bethlehem, Pa., some time between 1754 and 1761. It is described as a five-inch lignum vitæ pump, and lifted water to a height of 70 feet, through bored hemlock logs. In 1761 three single-acting iron force pumps, of 4-inch bore and 18-inch stroke, driven by an undershot water-wheel, were substituted. Of other early American pumping plants, the Center Square and the Fairmouth works at Philadelphia, started in 1801 and 1815, respectively, are perhaps the most notable. It is stated that about 1760 a Newcomen atmospheric pumping engine was imported from England for use at copper mines near Belleville, N. J. What appears to have been the first steam pumping engine to be built in the United States was erected by the city of Philadelphia in 1800 and put in operation on January 27, 1801, at the Center Square Works. One of the pumps lifted water from the river level to a second

PUMPING MACHINERY

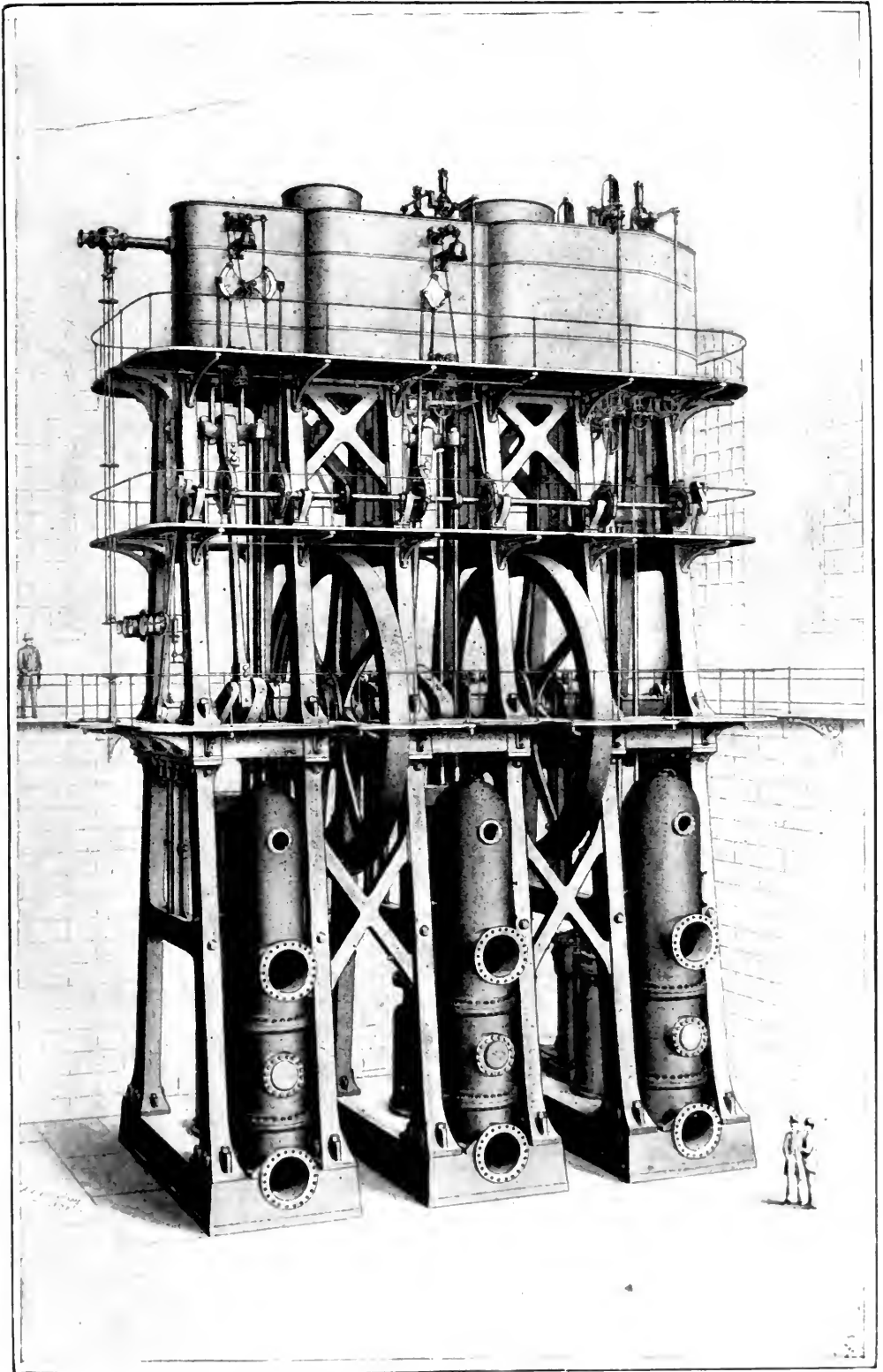

ALLIS VERTICAL TRIPLE-EXPANSION PUMPING ENGINE
ST. LOUIS WATER WORKS

pump about 50 feet higher, which in turn raised it another 50 feet. Both pumps were double-acting force pumps and the engines had wooden lever beams and fly-wheels. The pumps had a daily capacity of 3,000,000 gallons. The iron steam cylinder of at least one of these engines was cut in halves, united by copper, and secured externally by an iron band 18 inches wide. This cylinder was 36 inches in diameter.

A screw wheel pump of immense size and capacity, but of very low lift, was put in operation at Milwaukee, Wis., in 1889. It is used to force water through a brick-lined tunnel, 12 feet in diameter and 2500 feet long, to flush the Milwaukee River, which is badly polluted with sewage. The screw wheel is 13 feet in diameter. At 60 revolutions per minute it delivers 525,000,000 gallons a day against a head or lift of 4 feet. On a run of a number of months it gave a duty of 69,000,000 foot-pounds per 100 pounds of coal.

BIBLIOGRAPHY. Consult: Barr, *Hydraulic Machinery* (London and New York, 1897), technical, with chapters on pumps; Ewbank, *A Descriptive and Historical Account of Hydraulic and Other Machines for Raising Water, Ancient and Modern* (New York, 1876, new ed.), a curious and interesting account of the development of pumps of all sorts up to the early part of the nineteenth century; Hood, *New Tests of Certain Pumps and Water Lifts Used in Irrigation*, Water Supply and Irrigation Papers, United States Geological Survey, No. 14 (Washington, D. C., 1898); also chapters on pumps in general reference books cited under articles on IRRIGATION and WATER-WORKS. See AIR COMPRESSORS; ARCHIMEDES' SCREWS; DRAINAGE; HYDRAULIC RAM; and STEAM ENGINE.

PUÑACA, pōo-nyä'ká. A small goby or guavina (*Dormitator maculatus*), dark brown, with lighter bluish spots, and from one to two feet in length. It presents a great variety of forms. This and a number of closely allied fishes (see GUAVINA) are called 'sleepers' because

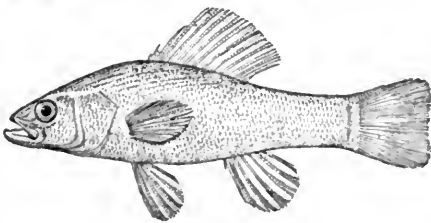

PUNACA.

of their burying themselves in the mud in order to pass unfavorable seasons in dormancy.

PUNCH (abbreviation of *Punchinello*, from Fr. *Polichinelle*, from It. *polcicello*, clown, buffoon, puppet, diminutive of *polcino*, *puleino*, child, young chicken, from *pullus*, young chicken, young of any animal). The chief personage in the popular comic drama of *Punch and Judy*, performed by means of puppets. See PUPPET.

The history of the play in which Punch figures is hardly less obscure than that of its designation. The invention of the piece is ascribed to an Italian comedian, Silvio Fiorello, about 1600, but it was later modified by Andrea Calcese, and very likely it is in substance much older. The personality of Punch has even been

traced back to the simpleton Maccus of the ancient Atellan farces, though with little other proof than its resemblance to a small bronze figure of the latter, discovered near Naples in 1727. The form of the play, as we know it, seems to be largely of French development, since our Punch is in several respects quite different from the character as he has survived in the vicinity of Naples. Having found its way to England in the seventeenth century, the exhibition became very popular there. Its popularity seems to have reached its height in the time of Queen Anne, and Addison has given in the *Spectator* a criticism of one of the performances. The scenes, as now given by strolling *Punch and Judy* shows, are much shortened from those originally performed, in which allusions to public events of the time were sometimes interpolated. The minor variations of the acted version are infinite. Jeremy Collier called Punch the Don Juan of the people. A similar character is said to exist in the puppet shows of India and elsewhere in the Orient. In Paris Punch, who is a great favorite of the children on afternoons in the Champs Elysées, is called *Guignol* (q.v.). This name properly belongs to a puppet character of Lyons, invented about the end of the eighteenth century, quite local and figuring in several mimic comedies. When brought to Paris, the title was applied to the original *Polichinelle*. Consult works cited under PUPPET; also Collier, *Punch and Judy*, with *Punch's Real History* (3d ed., London, 1844), illustrated by Cruikshank.

PUNCH. An important English weekly paper, devoted to humorous and satirical commentary on current events. It is doubtful if the whole story of its origin will ever be known, but the consensus of opinion seems to be in favor of crediting the original idea to Ebenezer Landells, a London wood engraver and draughtsman, and Henry Mayhew, a well-known wit and writer. The original idea was to reproduce in London the success of Philipon's *Charivari*, which already had an established position in Paris. Mayhew secured Mark Lemon as editor and a staff of writers, and the first issue was published on July 17, 1841. According to Lemon's manifesto, published in the first number, it was destined to fight for the abolition of the Fleet and Marshalsea prisons and of capital punishment, and to uphold the standard of national integrity and virtue. It succeeded with the first part of its programme, and while it has ceased its crusade against capital punishment, it has consistently attacked abuses of all kinds, as well as every form of sham gentility, vulgar ostentation, crazes and fads, foolish extremes of costume, and silly affectations of fashion whether in language or in habits. Throughout the world it is regarded as an exponent of English opinion scarcely inferior to the *London Times* itself. While it draws its materials as freely from the happenings of foreign politics as from the occurrences of English national life, it has nevertheless always judged external events from the English point of view, and home affairs from the highest moral standard.

At the time of its inception it was practically the only periodical which could be said truthfully to represent the attitude of the great mass of the British nation, absolutely free from party or governmental bias. Its humor, like its policy,

has been typically English—so much so that it has been frequently misunderstood by foreign critical opinion, with the result that its insularity has lost for it the best work of non-English contributors. An exception to this rule was the engagement of 'Artemus Ward.' The renowned French caricaturist Caran d'Ache has also drawn for it. A list of the Englishmen who have met weekly about the table on which most of them have carved their initials would include many of the best-known writers and artists. Among the former may be mentioned Douglas Jerrold, Thomas Hood, and Thackeray, who wrote for it until 1854; among the latter, Keene, Sambourne, Leech, Tenniel, Briton Rivière, du Maurier, Harry Furniss, and Phil May. Lemon was editor from the beginning until 1870; the later editors have been Shirley Brooks, 1870-74; Tom Taylor, 1874-80; and Sir F. C. Burnand, 1880—. Consult: Spielmann, *The History of Punch* (London, 1895); Mayhew, *A Jorum of Punch* (ib., 1895).

PUNCH (from ML. *punctuare, punctare*, to pierce, from Lat. *punctum, punctus*, point, from *pungere*, to pierce). A tool for cutting circular or other shaped pieces out of metal, wood, or other materials. The simplest form of this instrument consists of a piece of steel formed at one end into a hollow cylinder, the end of which is ground to a very sharp cutting edge. The other end of the punch is made strong and thick, to receive blows from a hammer, and to serve as a handle. When the instrument is in use, the cutting edge is applied to the surface which is to be perforated, and a blow sufficiently hard is struck on the end of the handle, when a circular piece of the material is cut out and left in the hollow part, which can be removed at the upper end of the cylinder. Punches are also made where a die or punch fits accurately into a corresponding hole through which the material is forced. See DIES AND DIE SINKING. For punching machines, see METAL-WORKING MACHINERY.

PUNCTUATION (ML. *punctuatio*, from *punctuare, punctare*, to pierce). In writing or printing, the use of certain marks called points, to separate sentences and parts of sentences. Its most important office is that of preventing ambiguity or obscurity. More inclusively, its object is to indicate correct grouping of the words, as an aid to quick perception of their relationships, and so of their meaning.

In Greek inscriptions and manuscripts generally, there is no attempt to separate the words, and in early times no system of punctuation was employed. It is true that in some archaic inscriptions columns of dots are occasionally found separating words, but they have no reference to the pauses, and cannot properly be called punctuation. However, even by the end of the fourth century B.C., readers found it convenient to indicate pauses by arbitrary signs, though the published copies of books seem to have known no division of words or use of diacritical signs. The development of an organized system of punctuation seems to have occurred at Alexandria. To judge from the papyri, the earliest mark is used to indicate a new paragraph. Here a slight space is left in the line (later a large initial is sometimes found), while below the line in which the pause occurs is drawn a short horizontal line (the so-called *παράγραφος, paragraphos*) which sometimes takes the form of a wedge. This

sign is used in the plays to indicate a change of speaker, and in the papyrus of Bacchylides to mark in the odes the strophe, antistrophe, and epode. Another method was the employment of a dot or small circle, and we are told that Aristarchus of Byzantium systematized this use, so that the point high above the line indicated a full stop, that low on the line a lesser pause, like a semicolon, and the point in the middle a comma. This system, however, though accepted by the grammarians, does not appear in the papyri, where the point is usually placed high, whatever its value.

In general it may be said that these and other diacritical signs seem to have been used chiefly in editions of the poets, whose dialectic and archaic forms presented greater difficulties to the ordinary reader. Other systems, some of great complexity, were employed by later grammarians and editors, but did not come into general use. The Greek manuscripts of later date show a system more like that now employed. About the ninth century the comma appears to denote the slight pause, while the high dot (·) indicates a colon or semicolon, and the full stop is denoted by a larger dot or double dot and a space. A little later the interrogation point (;) appears, though not very frequently. The Latin grammarians adopted the punctuation by dots from the Greeks, but seemingly modified the system slightly so as to give the middle dot the middle value, and the lower the smallest. The oldest manuscripts, however, show no punctuation at all, and the later uncials show great variety, and no recognized system. In the seventh century we find the equivalent to a comma, the semicolon with its modern value, and a full stop expressed by a more complex sign. In the Carolingian and later manuscripts the system is somewhat altered, and approaches more closely that in common use, as the comma is introduced, and an inverted semicolon to indicate a pause between comma and semicolon, while a sign of interrogation also appears. Quotation marks in various forms are found early in both Greek and Latin manuscripts.

All modern languages agree practically in the use of the same points, applied according to principles laid down by Aldus Manutius (1450-1515), but since his time, of course, extensively developed. Differences in detail between languages rest mainly on different methods of thought and construction, though some peculiarities are arbitrary. In Spanish a question or an exclamation has its especial mark at the beginning as well as at the end. French has a peculiar set of quotation marks, and German uses commas in normal position at the beginning and inverted commas at the close of a quotation. But the leading principles are universal. Punctuation in English is legitimately subject in many respects to personal choice, since many sentences, when not very long and of simple construction, are equally clear whether points are or are not freely used. Liberal insertion of points is called close punctuation, and omission of all but those absolutely necessary is known as open punctuation. The latter practice probably prevails at present in the best English usage, although the only statement that may be made with certainty in this respect is that usage is not uniform.

Differing methods of pointing have been called

rhetorical punctuation and *grammatical* punctuation, with the supposition that in the former case, for guidance in reading, each place of natural pause should be indicated by a distinctive point. It was probably this rhetorical or elocutionary consideration that led to the assignment of time values to the marks. The comma was said to indicate a pause long enough to count one, the semicolon two, the colon three, and the period four. But good reading or speaking does not justify this notion of counting, pauses being made where even a rhetorical punctuator would not indicate them, and the time of the pause being often shortened or lengthened in a way that cannot be recognized without the addition of other distinctive marks not yet invented. In any case the reader's individuality may ignore punctuation. Consequently, punctuation governed by purely grammatical circumstance seems likely to prevail increasingly, although it has not yet entirely superseded the other method. Another classification has been made, including, besides rhetorical and grammatical, *etymological* and *reference* punctuation; but, although the marks for the last two purposes are used in positions similar to those of real punctuation, their nature more nearly approaches that of diacritics.

The comma is used to mark the slightest actual turn or jointure in grammatical construction, and thus occurs much more frequently than any other point. Very often it is placed after a long nominative without an actual break in sense, but no one has ever prescribed an exact or even approximate length of the subject after which the comma is to be used.

The semicolon is used after a clause when the turn in sense is too distinct to use merely a comma, and not sufficient for a period; most frequently between clauses all or some of which contain commas. Often a semicolon is placed between what might be made separate sentences; this is done, as it is in this instance, because of a closer connection of sense than where the sentence form is used. Discriminative use of the semicolon is often considered a test of punctuation.

The colon is now generally confined to an introductory function, being comparatively seldom used as a mark of ordinary grammatical punctuation.

The period is used at the end of every sentence that is not a question or an exclamation, an interrogatory or exclamatory sentence being properly ended with its own appropriate mark.

The dash is used to denote a sudden change in the construction, a suspension of sense, an unexpected transition in the sentiment, a sudden interruption, or hesitation.

Marks of parenthesis are used to inclose a word, phrase, clause, or sentence inserted independently, as for explanation or any similar purpose. Square brackets inclose an insertion not merely disconnected, but having no effect on the meaning of the context, an editorial explanatory word or phrase, or an independent direction, as in dramatic composition. An apostrophe is the sign or part of a sign of the possessive; it takes the place of letters omitted in contracting a word; and it is used to mark the end of a quotation whose beginning is marked by inverted commas. The use of various other marks is commonly explained in treatises on punctuation, including

marks of reference, elision, emphasis, connection, and diacritics.

Some difference in punctuation is generally considered necessary according to differences in composition. Thus, a succession of short sentences may need very little pointing within any sentence, while even the same thoughts might be expressed by the use of one long, complex sentence that demands, for unmistakable division into parts not liable to confusion in reading, correspondingly complex punctuation. Accordingly, authors must determine this matter without strict reference to any formulated set of rules, as occasional demands for special pointing cannot all be comprehended in any system. As a rule, for instance, the frequent use of dashes has been stigmatized as a mark of ignorance; but, notwithstanding, it may be—but not often—truly artistic. Again, while it has been said that the colon has practically gone out of use as a purely grammatical point, it also may be used freely by a master hand with so good effect as to be beyond criticism. Among the fullest and most noted of the older treatises are: Brown, *Grammar of English Grammars* (1851 and many later editions); Wilson, *Treatise on Punctuation* (1850 and many later editions). Recent special works are: Bigelow, *Handbook of Punctuation* (Boston, 1885); Teall, *Punctuation* (New York, 1897).

PUN'DIT (from Skt. *paṇḍita*, learned). The name given to a Brahman who is versed in the Sanskrit language, and in the science, laws, and religion of the Hindus.

PUNICA FIDES, *pū'nī-kā fī'dēz* (Lat., Punic faith). A term used by the Romans to express treachery, in allusion to the popular conception of the Carthaginians.

PUNIC WARS. The name commonly given to the three great wars waged between Rome and Carthage; the first (B.C. 264-241) ended with the cession of the Carthaginian part of Sicily to Rome; the second (B.C. 218-201) resulted in the loss of Spain to Carthage, and the third (B.C. 149-146) in the destruction of Carthage. The Latin word *punicus*, or *panicus*, was the name given by the Romans to the Carthaginians, in allusion to their Phœnician descent. See **CARTHAGE**; **HAMILCAR**; **HANNIBAL**; **ROME**; **SCIPIO**.

PUNISHMENT (from *punish*, from OF. Fr. *punir*, from Lat. *punire*, *pœnire*, to punish, from *pœna*, punishment, expiation, pain, from Gk. *ποινή*, *poinë*, punishment; connected with Gk. *ἔλκεν*, *elkein*, Skt. *ci*, to avenge). Pain or suffering inflicted because of some misdeed. In criminal law the word punishment is used to designate the penalty inflicted by the State upon a person for committing a criminal offence. The earliest forms of punishment were those which carried with them the idea of vengeance and were inflicted with the desire to do harm to him who had previously done harm. More recently, however, the idea of retribution has made way for the theories of prevention and reformation. The former of these theories insists that the State shall inflict upon a criminal only such punishment as will keep him from further wrong-doing and deter others from criminal acts. The latter theory regards the reformation of the criminal as the only legitimate design of punishment and maintains that when this is accomplished further punishment should cease. None of these three theories—of retribution, preven-

tion, or reformation—holds absolute sway in our criminal codes. Generally there are traces of all three, although the tendency of recent development has been in the direction of reforming the criminal.

In the early history of society the infliction of punishment for crime was left in the hands of the person wronged, or his kin, clan, or tribe. The punishments inflicted were usually characterized by cruelty and were out of proportion to the offense committed. Indignities were frequently inflicted upon the body of a criminal after death. When, moreover, certain standards concerning the degree of offense came generally to be accepted, the punishment for the same offense varied according to the social rank of the injured party. In the course of time a system of fines was substituted for physical punishment. By the payment of a fine to the injured person or to his family, the offender was made free from liability to further punishment.

With the increasing complexity of society and the development of the idea of the State, the right to punish was taken away from the offended party and vested in the State. Crimes came to be considered as offenses against the State, the social order, and punishment is now regarded as an act of social defense calculated to establish the inviolability of the law and to deter those who may be criminally inclined from overstepping the limits of legally permissible conduct.

Punishment, in criminal law, possesses four characteristics. First, it represents, objectively, some pain or damage inflicted upon an offender. Whether the person punished conceives the punishment as a pain or damage does not matter. Secondly, punishment is imposed by government as the representative of legal order in society. Thirdly, it is determined and carried out as a consequence of judicial procedure and decision. Fourthly, it aims at some definite purpose, whether this purpose be the maintenance of order, retribution, or reformation. Punishments are of varying nature; they may involve encroachment upon the life or physical integrity, on the personal liberty, on the property, or on the rights and privileges of an offender. To the first of these classes belong capital punishment and such generally obsolete punishments as the cutting off of tongue or hands. In the second class we find deportation, imprisonment, and compulsory labor. The third class includes fines and the confiscation or destruction, by the State, of an offender's property. As punishments of the fourth class, the criminal is often deprived of political or civil rights belonging to citizenship, such as the electoral franchise, capacity to testify in courts of justice, or to hold office. Forms of punishment formerly in vogue, but now discarded among civilized nations generally, are mentioned under TORTURE.

Some of the qualities which 'ideal' punishments should possess, to correspond to modern ethical standards, are the following: (a) Morality. Punishments should not stunt or destroy the moral sense of the culprit or of those witnessing the punishment. (b) Equality. Punishments should represent a damage or pain of equal importance or intensity to different offenders committing the same crime. This condition is difficult to fulfill, for the imposition of different punishments for one and the same crime seems to be a violation of democratic principles, while

a fixed fine of say \$100 for a specific offense represents a much severer punishment for a poor man than for a man of wealth. (c) Personality. The evil effects of punishment should be confined to the offender alone, and not extend to innocent persons. (d) Elasticity. The punishment should be such that it can be varied to suit the various degrees of guilt. (e) Commensurability. The diverse punishments of the criminal code must be of such a kind that they may be compared with one another, and thus permit the judge to choose among several penalties that which corresponds in severity to the gravity of the offense. (f) Reparability. It should be possible in case of judicial error to repair the injury done to a person unjustly condemned.

Sometimes the laws prescribe a definite penalty for a specific offense, and the judge then has no choice. Usually, however, he is permitted to elect among several penalties which the law permits for a given misdemeanor; he may choose, for example, between "a fine of from \$1 to \$100 or imprisonment for a period not less than three days or more than three months." Theoretically the nature and method of punishment might be left entirely to the discretion of the judge; but this system is unknown in practice.

BIBLIOGRAPHY. Beccaria, *Crimes and Punishments*; Maine, *Ancient Law*; Proal, *Le crime et la peine* (Paris, 1892); Wines, *Punishment and Reformation* (New York, 1895). See PENOLOGY; CRIMINOLOGY; CAPITAL PUNISHMENT.

PUNJAB, pūn-jāb', or **PANJAB** (Hind., five rivers: the Jhelam, Chenab, Ravi, Sutlej, Beas). A northwestern province of British India (q.v.), bounded on the north by the Northwest Frontier Province and Kashmir, on the east by Tibet and the United Provinces of Agra, on the south by Rajputana and Sindh, and on the west by the Northwest Frontier Province (Map: India B 2). The last was in great part included in the Punjab until 1901, when it was constituted a separate province, thereby reducing the area of the Punjab to 133,741 square miles. Of this area 97,209 square miles are directly under British administration, the remaining 36,532 square miles being occupied by a number of feudatory native States, of which the largest is Bahawalpur. The extreme northern part of the province lies among the foothills and projecting spurs of the Himalayas, but the greater portion consists of an almost perfectly level plain sloping gently from an elevation of 1600 feet at the base of the mountains to less than 200 feet in the extreme southwest. This plain is traversed by the Indus (which flows on or near the western boundary), and its great tributaries, the Jhelam, Chenab, Ravi, and Ghara, or Sutlej (the chief affluent of which is the Beas), which all unite into the Panjnad before they enter the main stream near the southwestern boundary. The climate of the plains is excessively hot and dry in summer, the temperature sometimes rising to 120°. The winters are cool, with occasional frosts at night. The rainfall ranges from 36 inches in the north to only 4 inches in the south, being in the greater portion insufficient for the needs of agriculture. Healthy vegetation is accordingly confined to narrow lands along the river courses, and the great interfluvial tracts, known as *doabs*, are covered only with a scanty jungle of scrub, here and there affording pasturage.

As in all parts of India, most of the inhab-

itants are engaged in agriculture. The soil as a rule is highly fertile and only lacks an adequate water supply. In the south there is practically a barren desert. In the extreme north good crops are usually raised and without irrigation. There is a larger irrigated area in this province—9,375,000 acres—than in any of the other governmental divisions. This area has been greatly extended in recent years, owing to the large irrigating enterprises of the British Government, the Government canals supplying an area of 4,243,000 acres. An area almost equal to this amount is watered from wells, but reservoirs or 'tanks' are almost wholly wanting. In the south the canal system of irrigation prevails and the irrigated areas fringe the river courses. In the northern half of the country wells are common, and the cultivated area is not limited to the proximity of the rivers. The Punjab has become noted for its wheat crops. It produces more wheat than any other province. The wheat-growing area, however, has not increased for some time. Rice, on the contrary, receives much less attention than in most of the sections of the country, less than 500,000 acres being devoted to it. Large quantities of pulse, millet, and other food grains are grown, and sugar-cane, cotton, and oil seeds are also important products. The general desert conditions are of course a serious disadvantage to pastoral pursuits, yet this industry receives considerable attention, and the cattle for 1900 were estimated at 8,197,000 head, the buffaloes at 2,495,000, and sheep and goats at 9,901,000. The horses, mules, and donkeys together numbered less than 1,000,000. In the drier portions of the country camels are the most serviceable animals, and the province contains twice as many of them—271,000—as any British Indian Province. See INDIA.

Some manufacturing is engaged in, the Oriental domestic methods being most common. In 1899 there were 106 factories, employing 12,054 hands. Among the chief products are muslins and other cotton goods, manufactures of camel's hair, and glazed tiles and pottery. The potter's art especially has degenerated under foreign influence. The province now has railroad connection with the three principal trade centres of India—Calcutta, Bombay, and Karachi. The Indus River affords water transportation, but railway competition has reduced this to a minimum. The imports into the Punjab from other parts of India average about \$35,640,000 annually, the largest items being cotton goods (mostly European), sugar, rice, and iron. The exports average about \$29,160,000 annually, the principal articles being wheat, raw cotton, hides, grain and pulse, rape and mustard seed. Over 90 per cent. of the wheat passes through the port of Karachi.

The chief executive officer of the province is the Lieutenant-Governor, who is appointed by the Governor-General of India with the approval of the Crown. Since 1897 the province has had a legislative council of nine nominated members. There are 148 municipalities, in two-thirds of which the municipal committees are elected by the rate-payers. District boards have oversight of the rural regions, and most of the districts are divided into smaller divisions with local boards.

The population, in 1901, numbered 22,455,819 (of which, however, 2,125,480 have since been deducted as belonging to the Northwest Frontier Province). Between 1890 and 1900 there was

an increase of 7.13 per cent., as against an increase of 10.74 per cent. in the preceding decade. There were 202 inhabitants to the square mile, or considerably less than half the density of the Ganges Valley region. Since the Punjab lies at the northwest gateway of India, the numerous migrations and military expeditions from the west have passed through it, making it the scene of numerous conflicts. The result has been that in many respects it is different from the other portions of India. The Caucasian blood is more pronounced, as is also the military spirit. The Jats constitute a large part of the population. The Pathans have scattered settlements throughout the province, and the Beluchis have settlements on the Lower Indus. Over one-half of the people are Mohammedans—a larger per cent. than is found in other parts of India. The Pathans and the Beluchis nearly all hold to that faith. A large number of Jats are Hindus. The Sikhs (q.v.) are an offshoot from the Hindu Jats. The Christians numbered in 1901 only 53,587, of whom 30,839 are Europeans. The caste system, as adopted by the Indus Valley Jats, differs materially from the original system. The Sikhs have endeavored without success to abolish caste. As in other parts of India, most of the population lives in rural villages. Delhi, the largest city, had a population in 1901 of 208,300. Lahore, the capital, ranks second with 120,000, having decreased from 176,800 since 1891. In 1897 there were 8507 schools of all grades, with 265,922 pupils. The cost of maintaining these was divided between the provincial and the local units of government supplemented from fees and other sources. For the history of the Punjab, see SIKHS; and for the language, see PANJABI LANGUAGE AND LITERATURE.

BIBLIOGRAPHY. Griffin, *The Rajas of the Punjab* (2d ed., London, 1872); *Report on the Administration of the Punjab* (Lahore, 1863-1902); Cunningham, *Archæological Survey of India*, vol. xiv. (London, 1882); Medlicott, *Sketch of the Geology of the Punjab* (Calcutta, 1888); Gore, *Lights and Shades of Hill Life in the Afghan and Hindu Highlands of the Punjab* (London, 1895); Latif, *History of the Punjab from the Earliest Antiquity to the Present Time* (ib., 1896).

PUNKIE (of uncertain etymology). One of the biting midgets of the family Chironomidae and genus Ceratopogon. These flies are very minute, and one species (*Ceratopogon nocivum*) is the cause of considerable distress to hunters in the Maine woods, where it is called 'no-see-um.' Other species are found in both North and South America. The larvæ feed on decaying animal or vegetable matter.

PUNNAH, pūn'ā. A native State of India. See PANNA.

PUNO, pūn'ō. The southeasternmost department of Peru, bounded on the north by Cuzco, on the east and south by Bolivia, and on the west by Moquegua and Arequipa (Map: Peru, C 6). Area, about 40,000 square miles. The northern part of the department is occupied by the Carabaya Range of the eastern cordillera of the Andes, whose forest-covered slopes belong to the region of the Montaña, and give rise to the River Madre de Dios. The southern half belongs to the basin of Lake Titicaca, whose waters form the southeastern boundary of the department. The

greater part of the inhabitants, chiefly Aymara Indians, live in the lofty Titicaca basin, where the climate is cold and but little agriculture can be carried on. The chief occupation is cattle-raising, and very little is produced for export. Population, in 1896, 537,345. The capital is Puno (q.v.).

PUNO. The capital of the Department of Puno, Peru, 100 miles east of Arequipa, on the western shore of Lake Titicaca, and on a branch of the Mollendo-Cuzco Railway (Map: Peru, D 7). It is the centre of trade between Bolivia and the Peruvian coast. Population, about 5000.

PUN'SHON, WILLIAM MORLEY (1824-81). An English Wesleyan Methodist minister. He was born at Doncaster, Yorkshire, became a local preacher in the Methodist Church, entered the ministry in 1844, and was sent for a few months to the theological institution at Richmond. His first regular parish was Whitehaven (1845), and he held pastorates in Newcastle-on-Tyne, Sheffield, Leeds, London, and Bristol. In 1868 he was sent to Canada, where he was president of the Conference for five successive years, and was instrumental in building churches, strengthening Victoria University, and the enlargement of the denomination. In 1873 he returned to England. In 1875 he became secretary of the Wesleyan Methodist Missionary Society. His eloquence and power as a preacher placed him among the foremost clergymen of his day. He published volumes of addresses, lectures, and sermons and one volume of poems. Consult his *Life* by Macdonald (chapters xi.-xv. by Professor Reynar; London, 3d ed., 1888).

PUNT, pōont (Egyptian *Puēnt*). A country on the Red Sea, often mentioned in the hieroglyphic inscriptions, whence the Egyptians obtained incense, gold, ebony, ivory, leopard skins, ostrich feathers, and other commodities. The earliest recorded voyage to Punt was under King Assa of Dynasty 5, and King Se'ankh-ka-rē of Dynasty 11 sent an expedition which, crossing the desert from Koptos to the Red Sea, built a ship and sailed down the coast to Punt. Expeditions were also sent thither by Amenemhat II., Thothmes III., Rameses III., and other monarchs. Queen Hatshepsut (Hatasu), who sent a whole fleet to Punt, caused the details of the voyage to be depicted upon the walls of the Temple of Deir el-Bahri, with interesting representations of the inhabitants of the land and of their dwellings. The question as to whether Punt is to be sought on the Asiatic or the African side of the Red Sea has given rise to much discussion, but from the evidence of the Egyptian monuments it seems clear that it corresponded with the modern Abyssinian and Somali Coast. Consult: Dümichen, *Die Flotte einer ägyptischen Königin* (Leipzig, 1868); Müller, *Asien und Europa* (ib., 1893); Erman, *Life in Ancient Egypt* (London, 1894); Naville, *Deir el-Bahri*, Memoirs XII., XIII., XIV., and XIX. of the Egypt Exploration Fund (London, 1894 et seq.).

PUNT, pünt (AS. *punt*, from Lat. *ponto*, *punt*, *pontoon*, from *pons*, bridge). A heavy, oblong, flat-bottomed boat, propelled by a pole thrust against the bottom of a river or lake, and useful where stability and not speed is needed. It is a primitive form of boat, found in many countries, notably from ancient times on the waterways of Mexico. Punting has,

however, become a popular sport, especially in England, where the conditions of climate and the nature of the rivers are particularly favorable to it. The Thames Punting Club was revived in 1890, and holds championship and other races. This club differentiates punts from other partly similar boats by defining a punt as "a flat-bottomed craft without stem, keel, or stern-post, and with the width at each end at least one-half of the width of the widest part." Amateur punting championships have been held in England annually since 1886, and professional races since 1876. See *BOAT*.

PUNTA ARENAS, pōon'tá á-rá'nás. A port of Chile situated on the northwest shore of the Strait of Magellan (Map: Chile, C 14). The town has grown rapidly, and has broad streets, several fine buildings, and electric lighting. It is an indispensable port of call and coaling station for all steamers passing through the Strait, and has a growing trade in wool, skins, beef, and other cattle products. Population, in 1895, 3227; in 1900 (estimated), 6419.

PUNTARENAS, or PUNTA ARENAS. The principal seaport on the Pacific coast of Costa Rica, situated on the Gulf of Nicoya, 44 miles west of San José (Map: Central America, E 5). Its harbor is provided with an iron breakwater, but large vessels anchor outside. It is the western terminus of the transatlantic railroad from Port Limón. It has steamship communication with the United States. It exports coffee, rubber, tortoise-shell, and silver. Population, about 5000.

PUPA (Lat., doll, puppet). That stage in the life of an insect having perfect metamorphoses which intervenes between the larva and the adult. See *INSECT*; *METAMORPHOSIS*.

PUPIE'NUS (M. Clodius Pupienus Maximus). Joint Emperor of Rome with Balbinus for a few months in 238. They were elected by the Senate when the news came that the two Gordians had died in Africa, and both were before long assassinated by the soldiery.

PUP'IN, MICHAEL IDVORSKY (1858-). An American physicist and inventor, born at Idvor, Southern Hungary, of Serbian ancestry. He was educated at the village school of his native town and at a military school at Prague, and came to America in 1874. He entered Columbia College in 1879 and graduated in 1883. He then studied mathematics and physics at Cambridge University, England, and also at the University of Berlin, where in 1889 he received the degree of doctor of philosophy, holding while abroad the John Tyndall Fellowship of Columbia. Upon his return to America he was appointed instructor in mathematical physics at Columbia University, and in 1892 adjunct professor of mechanics. In 1901 he became professor of electro-mechanics. Professor Pupin's most important researches were in electrical resonance, electrical wave propagation, and theoretical and experimental consideration of the magnetization of iron. He became well known for his work on the propagation of electrical waves, as he was able to apply his researches in this field to long-distance telephony and multiplex telegraphy. By his use of non-uniform conductors in which wire coils possessing a certain amount of self-induction were placed at stated intervals along the conductor, he

was able to prevent the attenuation of the electrical waves so that a far greater amount of the original current could be received at the terminal of the telephone conductor or cable. This invention greatly extended the limits of long-distance telephony and made possible the use of the telephone with cables of considerable length. The rights were acquired by the Bell Telephone Company, in 1901, a year after the research had been described before the American Institute of Electrical Engineers, and was also bought by German telephone interests and given an extensive and successful trial.

PUPIP'ARA (Neo-Lat., from Lat. *pupa*, doll, puppet, *pupa* + *parere*, to bring forth). A so-called series of flies including those forms in which the female gives birth to full-grown larvæ which immediately transform to pupæ. The term is really erroneous and the group is not a natural one, the points of resemblance, as Müggenberg suggests, being probably the results of convergence. The series comprises four families, the Hippoboscidæ or bird-ticks (see TICK; FOREST-FLY), the Braulidæ or bee-lice, the Streblidæ, and the Nycteribiidæ or bat-ticks. (See TICK.) The flies of this group have very abnormal habits and live by sucking the blood of mammals, birds, and bees; in some cases they are wingless parasites. The family Braulidæ consists only of single species, *Braula cæca*, a minute insect which lives on bees. The adult is said to deposit a pupa in the cell of a bee by the side of a young bee larva. The queen bee is said to be especially affected by the adult Braulas. The series Pupipara corresponds with the group Eproboscidæ, which is ranked as a suborder of the Diptera.

PUPPER, pup'pēr, JOHANN. The correct name of the German Augustinian monk called Johannes von Goch (q.v.).

PUPPET (OF. *poupette*, doll, from Lat. *pupa*, doll, puppet). A small jointed figure, commonly of wood or cardboard, representing a character on the stage of a puppet theatre, and moved with strings, or iron rods, or otherwise by a concealed agent. For the dialogue in this mimic drama, the invisible operator varies his voice as he takes the different rôles. The more elaborately installed puppets are now commonly called marionettes, from the French term, *marionnettes*, a diminutive, perhaps through the form *mariolettes*, of Marie, and denoting originally little figures of the Virgin Mary. Of the simpler form of puppets, the familiar representatives are Punch and Judy. See PUNCH.

The origin of this form of entertainment is lost in antiquity. It was known to both Greeks and Romans. Figures with movable limbs have been found even in the tombs of ancient Egypt and of Etruria, though many of these were probably only dolls for children and afford little evidence of a puppet drama. Of this perhaps the earliest development was in India. It is significant that the Sanskrit equivalent for stage-manager, *sūtradhāra*, literally means thread-holder. In China puppet-shows are likewise known, and also an adaptation of them in which the movable figures cast their shadows upon a curtain, whence the name, *ombres chinoises*. See SHADOW-PLAY.

Puppet-shows have received perhaps their highest development among the Javanese, who may have derived the idea from India. The Javanese puppets are ordinarily about two feet high, and

of elaborate, usually grotesque formation. They are used for shadow-plays as well as for direct representation, and the dramas in which they are employed are of great elaboration—often of religious and ceremonial significance. In Java, also, women sometimes dress as puppets and act in shadow-plays, imitating the stiff posturing of their models. Although choruses may be given them, the dialogue remains with a separate speaker. This affords a living analogy to a similar stage in the development of Oriental drama, tradition of which is preserved in China. Among the Turks, too, and in Mohammedan countries generally, the puppet-show is a popular entertainment, in which, it is asserted, the marionette actors exhibit a style of immorality even more atrocious than does our own Punch. Puppet-shows were used in the Middle Ages by the Christian Church, among other dramatic means, such as miracle-plays. In England these religious puppet-plays were called *motions*. The earliest exhibitions of this kind consisted of representations of stories taken from the Old and New Testaments, or from the lives and legends of saints. Several men gained reputation in the eighteenth century as puppet exhibitors, among them Powell, Pinkethman, Yates, and Flockton. In Germany puppets are said to have been known as early as the twelfth century. Lessing and Goethe in their day thought the subject not unworthy of their serious artistic attention. A favorite piece in the German puppet theatres early in the nineteenth century was *Doktor Johannes Faust*, which was published at Frankfurt in 1846. In France the introduction of regular marionettes is commonly credited to Pierre Brioché, who had a puppet-show on the Pont Neuf at Paris, in the reign of Louis XIV., but there is reason to believe that they were really known there much earlier. They have been especially popular at Lyons, where the character of *Guignol* was invented, but naturally they are a familiar adjunct to fairs and other periodic festivities generally.

Of the marionette drama of Western Europe the real home, however, seems to be among the Italians. Puppet theatres have been known for centuries at Naples, Milan, and elsewhere, and in America the best-maintained marionette shows are among Italian immigrants. The dialogue in these mimic theatres is in its detail largely extemporized. The favorite themes are legends of the Court of Charlemagne. There is, moreover, a considerable literature for the marionette stage. Thus, besides what has already been mentioned, may be cited such German collections as Engel, *Deutsche Puppenkomödien* (Oldenburg, 1874-92), Kollmann, *Deutsche Puppenspiele* (Leipzig, 1891), and Mahlmann, *Marionettentheater* (Leipzig, 1806), and also some of the best-known pieces of Maeterlinck, to say nothing of his imitators. A distinction might, however, properly be drawn between plays actually for marionette performance and the so-called 'plays for marionettes,' which merely form a modern literary type subtly defined through the associations of the name. On the puppet theatre there are observations in *The Spectator* and *The Tatler*, and Addison wrote a Latin poem entitled *Machinæ Gesticulantes* (Anglice, *A Puppet-Show*). Consult on the history of the subject: Magnin, *Histoire des marionnettes* (2d ed., Paris, 1862); Pischel, *Die Heimat des Puppenspiels* (Halle, 1900); Maindron, *Marionnettes et guignols* (Paris, 1900).

PUQUINA, pōō-kē'nā. A people of very low grade of culture and intelligence formerly living upon certain islands in Lake Titicaca and the adjacent shores in Southern Peru. Their language constitutes a distinct stock, and is said to have been at one time one of the three general languages of Peru.

PURACÉ, pōō-rā-sā'. A volcano rising from the Central Cordillera in Colombia, 220 miles southwest of Bogotá and immediately east of the town of Popayán (Map: Colombia, B 3). Its present height is about 15,500 feet, but previous to 1849, when its top was blown off by an explosion, it was considerably higher. The crater is still active, emitting continuously large quantities of hot vapor.

PURĀṆA, pōō-rā'nā (Skt., ancient lore). The name of a class of late poetic Hindu works of mixed cosmogonic, epic, and didactic character. The word *purāna* occurs frequently in the prose texts of the Veda as a designation of the Veda's own cosmogonic and legendary lore; the name is also given to the great epic, the *Mahābhārata* (q.v.). But in its most distinctive sense the word refers to a class of writings which certainly do not date before the sixth century A.D., and some of which may be as late as A.D. 1500. The existing Puranas seem to be sectarian religious manuals for the people, written in the interest of either the worshippers of Vishnu (q.v.) or Siva (q.v.). Though the fundamental Hindu Triad, Brahma, Vishnu, and Siva, is recognized the Vishnuite Kurma-Purana does not hesitate to say: "Vishnu is the divinity of the gods, Siva of the devils;" to Brahma all alike refer only in a perfunctory fashion. According to ancient tradition, the ideal Purana is divided into five parts: (1) Primary creation, or cosmogony; (2) secondary creation, or the destruction and rebuilding of worlds; (3) genealogy of gods and patriarchs; (4) *Manvantaras*, the periods of reigns of Manu; (5) the history of the dynasties of kings. Though no extant Purana is so divided, yet the subject matter roughly follows that order. The entire type of composition is of secondary importance; it borrows its themes very largely from the epic literature, and represents religion, practices, and legends in an exaggerated, fantastic, often distorted fashion. The actual light which the Puranas shed upon the antiquity they profess to illumine is very small. The number of Puranas is said to be eighteen, in the following order: Brahma, Padma, Vishnu, Siva, Bhagavata, Naradiya, Markandeya, Agni, Bhavishya, Brahmavaivarta, Linga, Varaha, Skanda, Vamana, Kurma, Matsya, Garuda, Brahmanda. Some lists omit the Agni and replace it by the Vayu-Purana. Of these the second, third, fifth, sixth, tenth, seventeenth, and probably the first are Puranas of the Vishnu sect; the fourth, eighth, thirteenth, fifteenth, and sixteenth belong to the Siva sect. The others are not so well defined. A great many of the Puranas have been edited and published, or are in course of publication, especially in the collection of texts published in Calcutta under the name of *Bibliotheca Indica*. Of translations there are few; the most accessible specimen in English is the translation in five volumes of the Vishnu-Purana by Wilson, edited by Fitzedward Hall (London, 1864-70). The first nine books of the Bhagavata-Purana were translated into French by Burnouf (Paris, 1840-44).

PURBECK BEDS. The name given in England to a group of strata forming the upper member of the Oolite group of the Upper Jurassic, well developed in the Isle of Purbeck, south of Poole estuary, in Dorsetshire.

PURCELL, HENRY (c.1658-95). One of the most eminent of English musicians. He was born at Westminster, and was the son of Henry Purcell, one of the gentlemen of the chapel royal appointed at the Restoration. He lost his father at the age of six, and was indebted for his musical training to Cook, Humphreys, and the famous English church organist and composer, Dr. Blow. His compositions at a very early age showed evidence of talent. In 1680 he was chosen to succeed Dr. Christopher Gibbons as organist of Westminster Abbey, and in 1681 he was made organist of the chapel royal. He wrote numerous anthems and other compositions for the Church, which were eagerly sought after for the use of the various cathedrals, most of which have retained their place and popularity to the present day. Purcell's dramatic and chamber compositions are even more remarkable. Among the former may be mentioned his music to *The Tempest*, his songs in Dryden's *King Arthur*, his music to Howard's and Dryden's *Indian Queen*, to Urfe's *Don Quixote*, and his *Fairy Queen*, the manuscript of which, long lost, was found in 1901. A great many of his cantatas, odes, glees, catches, and rounds are yet in demand throughout England. In 1683 he composed 12 sonatas for two violins and a bass. Purcell studied the Italian masters deeply, and often made reference to his obligations to them. In originality and vigor, as well as harmony and variety of expression, he far surpassed both his predecessors and his contemporaries. His church music was collected and edited from the original manuscript by Vicent Novello, in a folio work which appeared in 1826-36, with a portrait and essay on his life and works. He was regarded as the father of what has since come to be recognized as English melody. He died of consumption in London, and was buried in Westminster Abbey.

PURCELL, JOHN BAPTIST (1800-83). A Roman Catholic clergyman. He was born at Mallow, Ireland, and came to the United States at the age of eighteen. He studied at Asbury College, Baltimore, at Mount Saint Mary's College, Emmitsburg, Md., at Paris and Issy, and was ordained at Paris in 1826. Returning to the United States, he became professor of moral philosophy at Mount Saint Mary's College, and eventually was elevated to the presidency. In 1833 he became Bishop of Cincinnati, in 1839 assistant at the Pontifical throne, and in 1850 Archbishop of Cincinnati. During his long pre-eminence he extended the effectiveness of the Church in his diocese and gained great personal popularity both within and without his own Church. Misfortune overtook his later years through unfortunate investments or the inadequate business management of funds intrusted to the keeping of his brother, the Rev. Edward Purcell. The Archbishop assumed responsibility for the failure, making an assignment of his personal and diocesan property for the benefit of the creditors.

PURCHAS, SAMUEL (c.1575-1626). An English clergyman and author. He was born at Thaxted, in Essex. Taking orders after his graduation from Saint John's College, Cambridge,

he became curate of Purleigh, in Essex, afterwards minister at Estwood, in Essex, and with an interim when he served George Abbot, Archbishop of Canterbury, as chaplain, finally became parson of Saint Martin's, near Ludgate. He is notable, after Hakluyt, as the writer and compiler of books of voyages; and having inherited many unpublished narratives, upon the death of the former, he resigned his living to engage in their publication. His works are: *Purchas, His Pilgrimage, or Relations of the World and the Religions Observed in All Ages* (1613), a work which assembles all accessible information gathered from the various voyagers concerning the inhabitants of the world and their religions; the writer's industry, as he declares in his dedicatory epistle, led him to consult 1200 authors; *Purchas, His Pilgrim. Microcosmus, or the History of Man. Relating the Wonders of His Generation, Vanities in His Degeneration, Necessity of His Regeneration* (1619); *Hakluytus Posthumus, or Purchas His Pilgrimes, Contayning a History of the World in Sea Voyages and Land-Travells by Englishmen, and Others* (4 vols., 1625). This work contains the matter left by Hakluyt, is now exceedingly rare, and much sought after. Its accuracy is not above criticism.

PURCHASE. A mechanical contrivance of pulleys and ropes for gaining power. See **BLOCK**; **TACKLE**.

PURCHASE. In its technical legal sense, the act by which a person acquires an estate in land in any way other than by inheritance, where the heir is substituted in place of his ancestor by operation of law. Consult the authorities referred to under **REAL PROPERTY**.

In a popular sense the word purchase denotes the act of buying any kind of property, the purchaser being called the *vendee* and the seller the *vendor*. See **SALES**.

PURCHASE SYSTEM. A former system of obtaining commissions in the British Army, abolished by royal warrant in July, 1871. The system did not exist in the Royal Artillery, Engineers, Marines, Nineteenth to Twenty-first regiments of cavalry, and the 101st to 109th regiments of foot. Regulations fixed the value of the different grades as follows:

Lieutenant-colonel.....	£4,500
Major.....	3,500
Captain.....	1,800
Lieutenant.....	700
Cornet or Ensign.....	450

In practice, much higher prices would often be paid, particularly in the Guards regiments. No rank above lieutenant-colonel could be purchased. In defense of the system it was argued that it tended to secure for the army men of wealth and high station, which had a corresponding effect on the standing and morale of the army. On the other hand, it was held that it barred out many desirable men, and confined army commissions to a privileged few.

PURCHAS JUDGMENT. A celebrated ecclesiastical judgment rendered by the judicial committee of the Privy Council in *Herbert vs. Purchas*, an appeal from the Canterbury Court of Arches brought in 1871. The defendant or respondent was charged with Popish practices in connection with public services conducted by him at Saint James's Chapel, Brighton, England. The principal offenses charged were the use of the

mixed chalice, of a cap or beretta, of 'holy water,' and of wafer-bread in the Eucharist, the wearing of certain vestments, and the turning of his back to the people at certain stages of the service. The decision of the court was adverse to Mr. Purchas on all points except that relating to the beretta. The judgment was rendered on an *ex parte* hearing, as the respondent was provided with funds to procure counsel only after the decision was pronounced; his petition for a rehearing of the case was refused, and the course of the court in so doing was the subject of much unfavorable comment. Mr. Purchas was compelled to pay the costs and admonished to discontinue the prohibited practices. He refused to comply, and in 1872 was suspended, and his property sequestered to pay the costs. He died in October, 1872.

PURDUE' UNIVERSITY. A coeducational State institution of higher learning at Lafayette, Ind., established in 1869, and named for John Purdue, an early benefactor. Its income is derived chiefly from the land grant of 1862 and from the Morrill and Hatch acts, and amounted in 1903 to \$219,611. The university is the Indiana Institute of Technology, designed to afford a good theoretical and practical education in mathematics, science, literature, and art. It embraces six schools: Mechanical Engineering, Civil Engineering, Electrical Engineering, Agriculture, Science, and Pharmacy. Students in each of the schools are required to spend an average of three hours a day in laboratory, shop, or field. It confers the degrees of bachelor of science and graduate in pharmacy in course, and the following degrees for advanced work: Master of science, mechanical, electrical, and civil engineer, and analytical chemist. The requirement for admission is an examination or a certificate from a commissioned school. In 1903 there were 1339 students and 99 instructors. The university has 90 acres of land in its campus and farm. Its endowment was \$340,000, its grounds and buildings were valued at \$558,000, and the total value of the college property was estimated at \$760,000. The library contained 11,611 volumes.

PURGATION. See **COMPURGATION**.

PURGATIVES (Lat. *purgativus*, cathartic, from *purgare*, to cleanse, from *purus*, pure + *agere*, to drive, to do). Medicines which, within a comparatively short time after administration, produce a more or less fluid evacuation of the bowels. These drugs act partly by stimulating the peristaltic motion (q.v.) of the intestine, whereby the contents of the bowel are hurried in their passage to the rectum, and partly by determining the passage of a large amount of fluid into the intestine from the blood vessels. Purgatives may be classified as follows: (1) *Laxatives* (q.v.). (2) *Simple purgatives*, including aloes, rhubarb, cascara sagrada, senna, and ox-gall. (3) *Drastic purgatives*, such as jalap, scammony, gamboge, croton oil, colocynth, elaterium, and calomel. Small doses of the drastic purgatives act as mild cathartics; when taken in large doses, they act as irritant poisons, and are employed when milder purgatives have proved inefficient, or when it is necessary to remove a large quantity of fluid from the system, as in dropsical affections. Certain of these drugs, as jalap, elaterium, and scammony, are called *hydragogue* cathartics, because of the large amount

of secretion they excite. (4) *Saline purgatives*. These also increase the secretion of intestinal fluid and hinder its reabsorption, so that a large amount of it accumulates in the bowel and excites gentle peristalsis and a free evacuation. The salines are largely used as habitual purgatives. They form the essential ingredient of most purgative mineral waters (q.v.). In this class are sulphate of magnesia, sulphate of soda, phosphate of soda, and the potassio-tartrate of soda either in simple solution or in the form of Seidlitz powder (q.v.). (5) *Cholagogic purgatives* are those which have a stimulating effect either on the secretion or flow of the bile, and produce green-colored or 'bilious' stools. Several of the drugs already mentioned possess this property. Among the cholagogues most frequently employed are podophyllin, calomel, mercury, and the phosphate and sulphate of soda. Consult Potter, *Materia Medica, Pharmacy, and Therapeutics* (New York, 1903).

PURGATORIO, *pōōr'gā-tō'rē-ō* (It., Purgatory). The second part of Dante's *Divina Commedia*. After leaving the Inferno, Dante, guided by Vergil, reaches the Mount of Purgatory in the Western Ocean. They ascend the steep approach to the gate of Purgatory, where Dante's forehead is marked by an angel with seven P's (standing for *Peccatum*—'sin'), one of which he loses on each of the seven terraces where the seven deadly sins are punished. When they reach the river bounding Purgatory, Vergil leaves Dante, and Beatrice approaches to lead him onward to Paradise.

PURGATORY (ML, *purgatorium*, from Lat. *purgatorius*, cleansing, from *purgare*, to cleanse). The name given, in the Roman Catholic and Oriental churches, to a place of purgation, in which, according to their doctrine, souls after death either are purified from venial sins or undergo the temporal punishment which, after the guilt of mortal sin has been remitted, still remains to be endured by the sinner. The ultimate eternal happiness of their souls is supposed to be secured; but they are detained for a time in a state of purgation, in order to be fitted to appear in the presence of God. See INTERMEDIATE STATE.

PURGSTALL, JOSEPH HAMMER-. See HAMMER-PURGSTALL.

PURIFICATION (Lat. *purificatio*, from *purificare*, to make pure, from *purus*, pure + *facere*, to make). In a biblical sense, the act through which an individual became fit to approach the deity, or regained his place in the community after having been excluded from it by some disability. Purification consisted chiefly in ablutions, but these were sometimes accompanied by special sacrifices as expiations. Priests and Levites were consecrated for the divine service by 'purification' (Lev. viii.), and certain religious acts could only be performed after ablutions. Generally no one was allowed to enter the temple or synagogue without washing or 'sanctifying' himself. In the post-exilic period washing was considered by some (as the Pharisees and Essenes) one of the chief duties of piety. Apart from the temple service, however, many other things required purification. (See UNCLEANNESS.) It is a mistake to assume that the origin of laws of purification is hygienic; they are merely phases of the general notions of

taboo (q.v.). The question of health naturally enters later, in the reflective age, but has no force in primitive times. Laws similar to the Jewish are found among Mohammedans, and with Hindus and Persians laws of purification are even more exacting.

PUR'IM. One of the later Jewish festivals, for which the Jewish Church accepts the Book of Esther as the historical basis. According to this book, the festival was instituted to commemorate the deliverance of the Jews of Persia from a massacre with which they were threatened in the days of Xerxes (B.C. 485-465) at the instigation of Haman, the King's prime minister. It is celebrated on the 14th and 15th of the month Adar and is preceded by a day of fasting as preparation. (Cf. Esther iv. 15-17.) Scholars who hold that the Book of Esther (q.v.) is largely or purely fictitious, think that it may have been written to justify and account for a fast and festival, the origin of which was lost in obscurity. What the earlier significance of fast and festival was is conjectural in the absence of definite data. They are thought to be of Babylonian origin. The occurrence in the spring suggests a solar festival, the fast representing the death of winter, while the festival marks the joyous return of spring. Thus interpreted Haman and Vashti symbolize the disappearance of the old year; Mordecai and Esther, hailed as King and Queen, are the new favorites who bring in fertility and renewal of vegetation. The feast of Purim corresponds in time with a festival, mentioned in the Books of the Maccabees, in celebration of a victory gained by Judas Maccabæus, on the 13th of Adar, B.C. 161, over Nicanor (I. Mac. vii. 49; II. Mac. xv. 36). This seems to have been earlier a festival in honor of the dead. See FESTIVALS.

The name Purim is explained in the Book of Esther as 'lots,' and the application of it to the festival as due to the fact that Haman cast lots to determine a day favorable for the extermination of the Jews (Esther iii. 7; ix. 26). This is probably merely a piece of folk-etymology and illustrates the obscurity as to the meaning of the name at the time of composition of the book. In Babylonian there is a word *puru*, one meaning of which seems to have been 'a round stone,' and then 'lot,' from the use of stones in divination. Possibly the Jewish author of the Book of Esther, living in Persia or Babylonia, had this word in mind, but it does not necessarily follow that *pūrim* is identical with *puru*. The problem may be solved if a festival be discovered among Babylonians or Persians bearing the name *pūrim*, or something sufficiently like it to account for the Jewish form.

As celebrated by Orthodox Jews, the Purim festival is a time of feasting and merry-making. It begins as soon as the stars appear on the evening of the 14th of Adar. Candles are lighted. Consult: Lagarde, *Purim, ein Beitrag zur Geschichte der Religion* (Göttingen, 1887); Erbt, *Die Purimsage in der Bibel* (Berlin, 1900); Frazer, *The Golden Bough*, vol. iii. (2d ed., London, 1900).

PURITAN, THE. A yacht designed by Edward F. Burgess, built for a syndicate by Lawley, and launched in South Boston, May 26, 1885. She combined the features of the centre-board sloop with the outside ballast of the Eng-

lish cutter. Her dimensions were: length over all, 93 feet; on water line, 81 feet 11 inches; beam, 22 feet 7 inches; draught, 8 feet 10 inches. After winning in the trial races, she defended the America's Cup in 1885 against the English yacht *Genesta*, winning in two races on September 14th and 16th.

PURITANS (from Lat. *puritas*, purity, from *purus*, pure). A party title, originally a nickname which came into use about 1564, to designate that section of the Church of England which desired a more thorough reformation of the Church than was effected under Elizabeth, as such reformation was understood by Continental Protestantism, especially of the Calvinistic school. From the beginning of the Reformation age there had been three parties in the Church of England: a Romanizing element which desired to continue the connection with the Pope, whom it regarded as the vicar of Christ; a Protestant party which desired the full modification of the Church of England, at least in doctrine, into conformity with Continental Protestantism; and an intermediate party that, for want of a better designation, may be called Anglican, which wished to see all foreign ecclesiastical authority rejected, disliked monasticism, and welcomed the use of English in the services of the Church, but did not desire such thorough-going modification of its doctrine or organization as the Protestant section sought. This Anglican party looked to the sovereign as the source of ecclesiastical government, and was that which was represented by Henry VIII. and Elizabeth. To the thinking of these energetic monarchs the desirable system of Church government for England was one in which the ruler should be supreme in ecclesiastical no less than in civil affairs. The political condition of England, also, at the beginning of the reign of Queen Elizabeth was such as largely to justify the compromising attitude of the Queen regarding doctrine and ceremony. A minority only of the population was heartily in sympathy with the Reformation. The great bulk of the clergy had been swept almost without question from the Roman obedience of Queen Mary's time into Elizabeth's Establishment; and the Queen's political policy, no less than her personal preferences, counseled her to make the ecclesiastical transition as easy as possible by retaining not a little of the ceremonies and vestments of the older worship and by insisting upon uniformity of ceremonial without very strenuous investigation into the belief or even the conduct of the ministry.

This compromise policy, however, was distasteful to the thoroughly Protestant party in the Church of England. Many of their leaders had fled to the Continent to escape the Marian persecution, and had there come into intimate association with Calvin and the Swiss reformers generally. It was natural, therefore, that the model into accordance with which they desired to modify the doctrine and worship of the English Church was that of Continental Calvinism. Yet at first few of the Puritan leaders desired anything more than the disuse of the vestments which seemed to them to symbolize too great a distinction between clergy and laity, and the abandonment of certain ceremonies which appeared to them to countenance what they deemed Roman sacramental misconceptions. Strongly conscious of the spiritual needs of England, they desired,

furthermore, the establishment everywhere of an earnest preaching ministry and of vigorous discipline. These aims conflicted, however, with the Queen's policy of inclusion, and she set herself vigorously to enforce conformity in ceremony by the aid of the bishops, who, under the Elizabethan policy, were regarded primarily as royal agents.

The result of this policy was a further evolution in Puritanism itself. While a great portion of the Puritans continued to represent the desires of the earlier period of the party which have just been described, a considerable section now went further and questioned the rightfulness of that form of Church government 'by law established' which prevented the reforms that they wished. The typical leader of this second stage of Puritanism was Thomas Cartwright (1535-1603). In his opinion the only biblical system of Church government was one essentially Presbyterian; and, while he was willing to tolerate the existence of an extremely modified episcopacy, he would introduce into each parish the disciplinary and elective features of Presbyterian government. From thence onward until the Restoration, a large portion of the Puritan party walked in Cartwright's footsteps, and sought the modification of the Church of England essentially along Presbyterian lines. A small wing of extreme Puritanism went yet further, and under the leadership of Robert Browne, Henry Barrowe (qq.v.), and others, insisted that the only proper organization of the Church was in separate self-governing congregations, and that it was the duty of Christian men to leave the Church of England and establish such congregations; hence this extreme radical wing of Puritanism was known as the 'Separatists.' These Separatists were vigorously opposed by the more moderate Puritans of Queen Elizabeth's time; but their spiritual sympathizers were to be the founders of Plymouth in New England, and their conception of Church government was ultimately to dominate the Puritan settlers of Massachusetts and Connecticut.

Throughout the reign of Elizabeth the repressive policy of the Government continued, but the Puritan party grew, and on the death of the Queen, in 1603, entertained strong hopes of favor from the new sovereign, James I. These hopes were disappointed, notably at the Hampton Court Conference (q.v.) in 1604. The Puritan party, however, continued to gain adherents throughout James's reign and that of his son Charles I. Under the latter repeated clashes occurred between the Puritans and the Anglican Court party; and when the Civil War broke out in 1642 as a result of the many points of difference between Charles and the Parliament, the Puritans identified themselves strongly with the latter, while the Anglicans cast in their lot with the former. In the struggle that followed, the Presbyterian wing of Puritanism was at first dominant, especially when reinforced by the military and political aid of the Scotch. Episcopacy was done away with, so far as an act of Parliament could abolish it. The acceptance of the 'Solemn League and Covenant' bound the English Parliament to practical Presbyterianism, and Parliament responded to the desire for a modification of the Church of England, always characteristic of Puritanism, by calling an 'Assembly of Divines,' which met at Westminster from July, 1643, onward, to

recommend alterations in doctrine and Church government. (See CREEDS AND CONFESSIONS.) The result of its sessions was the preparation of an essentially Presbyterian Directory for Worship and form of discipline, of a Confession of Faith, and of two Catechisms. This Westminster Confession was accepted by the 'General Assembly' of the Church of Scotland in 1647 as its doctrinal standard, and approved, with some modifications, though not completely given the sanction of law, by the English Parliament in 1648.

But, while the Westminster Assembly had been doing this work, the influence of anti-Presbyterian types of opposition to episcopacy had been growing in the army. The Presbyterian majority in Parliament and in the Westminster Assembly were as strongly insistent on uniformity and as opposed to toleration as the Anglican party had been. But the more radical religious thinkers represented in the army, who were grouped together under the general name of 'Independents,' demanded by their very variety of opinion a certain measure of toleration, and the course of the struggle made the army the dominant force, for the time being, in English political life. The result was that the Presbyterian system was never fully established in England, and the Westminster Confession of Faith never obtained more than a limited recognition there. The forces of Puritanism were divided and Presbyterian Puritanism found it impossible to establish the principles which it desired to make controlling. Under the protectorship of Cromwell to his death, in 1658, the army's principle of partial toleration was dominant, but Cromwell's government, though enlightened and forceful, rested ultimately on the sword, and did not, therefore, enjoy the confidence of a majority of the people of England as a permanent system. His death left no efficient successor, and the restoration of the monarchy and with it Anglicanism was inevitable. Attempts were made at adjustment by which the Presbyterian wing of Puritanism, at least, might be included in the Establishment, and men like Richard Baxter labored to this end, but without success. Puritanism, instead of being a party within the Church of England as it had thus far been, was driven outside that Church and made to assume the attitude of 'Dissent,' to the great spiritual loss of the English Establishment. In spite of the discussions of the previous twenty years, no considerable number of Englishmen had yet accepted the principle of toleration at the time of the Restoration, and the result was that the triumphant Anglican faction adopted a rigorously persecuting policy toward Puritanism. Under the Act of Uniformity (q.v.) all Puritans who would not wholly accept the Prayer Book were driven from their livings. Some two thousand ministers of Puritan sympathies are alleged to have been thus excluded. Episcopal ordination was now made obligatory; and by the 'Conventicle Act' of 1664, any assembly of five or more persons not of the same family, for worship, was forbidden, save in conformity with the Church of England. The 'Five-Mile Act' of 1665 forbade all in holy orders who would not take oath never to attempt any alteration in the government of Church or State to continue to live within five miles of where they had exercised their ministry or of any English borough.

Moved by the desire to favor Roman Catholi-

cism, and anxious to gain, if possible, the support of the Dissenters, James II. modified this repressive policy by issuing a Declaration of Indulgence in 1687; but a permanent legal status was not acquired by Puritan Dissent until after the revolution which put William and Mary on the throne. The Toleration Act of 1689 gave to the evangelical dissenting bodies a permanent and recognized, if limited, freedom of worship and an established legal position. At the time of the Toleration Act about two-thirds of the Puritan Dissenters appear to have been Presbyterian in polity and one-third Congregational or Baptist. The fire and enthusiasm of the movement had been largely spent, but it still continued a strong religious force, chiefly among the middle class of the population. During the course of the eighteenth century the Presbyterian wing of Puritanism became largely affected by Arian and Unitarian opinions, while the Congregational section was not so influenced to any marked extent. By the beginning of the nineteenth century the Congregational wing was the largest, and the spiritual life of Puritanism had been greatly reënforced by the effect of the Wesleyan movement. Its later history may be traced in the story of the religious bodies known as Presbyterian, Congregational, and Baptist.

Outside of England, the chief effect of the Puritan movement is to be seen in the planting of New England and the development of its characteristic religious faith and ecclesiastical polity. See CONGREGATIONALISM.

The literature of Puritanism is very extensive. The following volumes may be cited as of importance in connection with its story: Calamy, *Abridgment of Mr. Baxter's History of His Life and Times* (London, 1702; edited by Palmer as the *Non-Conformist Memorial*, London, 1775); Neal, *History of the Puritans* (London, 1732; annotated editions by Toulmin, Bath, 1793-97; by Choules, New York, 1844); Brook, *The Lives of the Puritans* (London, 1813); Price, *History of Protestant Non-Conformity in England* (London, 1838); Marsden, *History of the Early Puritans* (London, 1853); id., *History of the Later Puritans* (London, 1853); Hopkins, *The Puritans* (New York, 1859-61); Green, *History of the English People*, section "Puritan England" (London, 1874); Gardiner, *The First Two Stuarts and the Puritan Revolution* (London, 1876 and 1888); id., *History of England from the Accession of James I., etc.* (London, 1883 sqq.); Wakeman, *The Church and the Puritans* (London, 1887); Ellis, *The Puritan Age and Rule in the Colony of the Massachusetts Bay* (Boston, 1888); Campbell, *The Puritan in Holland, England, and America* (New York, 1892); Gregory, *Puritanism in the Old World and in the New* (London, 1896).

PURPLE COLORS. Painters in oil and water colors produce the different shades of purple by the admixture of red and blue. Dyers obtain this color from various sources, all of which are curious and interesting. From a very early period, purple has been one of the most highly prized of all colors, and came to be the symbol of imperial and royal power. Probably one great reason for this was the enormous cost of the only purple color known to the ancients, the Tyrian purple, which was obtained in minute quantities only from a Mediterranean species of

molluscous animal or shell-fish, the *Murex trunculus*, and perhaps also *Purpura lapillus*. The chief seat of the industry from most ancient times was Tyre, where it continued to flourish in Imperial Roman times. Tarentum, the modern Otranto, was the seat of one of the great murex fisheries of the Romans, and there they had a number of large dyeing establishments. With the decline of the Roman Empire the employment of this purple color ceased, and it was not until a Florentine of the name of Orchillini discovered the dyeing properties of the lichen now called orchella weed that a simple purple color was known in Europe. The discovery was kept secret in Italy for nearly a century, and that country supplied the rest of Europe with the prepared dye, which received the name of orchil or archil (q.v.). The color was very fugitive, and soon ceased to be used by itself; it, however, was found very useful in combination, and has a remarkable power of brightening up other colors. Many improvements have been lately made in archil dyeing, especially in fixing it. Its value, however, has been greatly lessened by the discovery of the beautiful series of purples yielded by coal-tar as results of the combination of one of its products called aniline with other bodies. Consult: Dedeken, *Ein Beitrag zur Purpurkunde* (Berlin, 1898); Faymonville, *Die Purpurfärberei des klassischen Altertums* (Heidelberg, 1900).

PURPLE-FACED MONKEY. A Ceylonese langur. See LANGUR; WANDEROO.

PURPLE FINCH. A beautiful, crimson-tinted finch of the Eastern United States and Canada. See FINCH; and Plate of FAMILIAR SPARROWS.

PURPLE GRACKLE, HERON, MARTIN, ETC. See GRACKLE, HERON, etc.

PURPLE ISLAND, THE. A long poem by Phineas Fletcher (1633), describing the human body allegorically as an island of which the bones are foundations; arteries, rivers; heart and organs, cities; intellect, the king, attacked by diseases and vices. This unwieldy and involved conception displays much anatomical knowledge, melodious verse, and impressive descriptions of vices and virtues.

PURPLE OF CASSIUS. See CASSIUS, PURPLE OF.

PURPLES. A nematode disease of wheat. See EARCOCKLES.

PURPLE SCALE. A name originating in Florida for *Mytilaspis citricola*, a scale insect

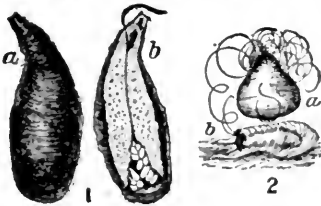

THE PURPLE SCALE.

1. Mature scale: a, upper surface; b, under surface; showing eggs. 2. A scale in formation: a, top view; b, side view.

which occurs exclusively upon citrus plants and swarms in the orange and lemon orchards of the

Southern United States, frequently causing great damage. It was introduced at one or two places in California about 1896, and is even more injurious in that State than in Florida when special efforts are not made to reduce its numbers. The species is probably of Chinese origin, and has now spread to most parts of the world where oranges and lemons are grown. It occurs upon the twigs and branches, but has a strong tendency to overrun the leaves and the fruit. It is apt to infest the lemon, citron, and those varieties of orange which have large oil cells in the skin of the fruit, such as the tangerine. The remedy most in use in Florida is the kerosene emulsion spray.

PURPLE-SHELL. A gastropod mollusk of the genera *Murex* and *Purpura*, whose secretions give a purple stain. Certain other mollusks, as *Janthina* and *Aplysia*, yield a violet-hued liquor, while others, as *Arca*, pour forth red blood. The discovery and use of this color are prehistoric and myths have arisen to explain them. Long before the beginning of the Christian era the gathering of the mollusks and application of the dye were practiced in factories all about the eastern part of the Mediterranean, several species of small *Murex* serving the purpose—principally *Murex trunculus*. The most famous place of production was near Tyre, whence the product came to be called Tyrian purple. It was limited in supply and costly, and from an early time—tradition says from the era of Romulus—was reserved wholly for the use of royalty in Church and State. Hence the terms and symbolism of this color as imperial, and the phrase *porphyro-genitus*—‘born to the purple.’ The color is still reserved in various ceremonial usages to officials of high rank. Accounts of the various tints are given by Pliny (Natural History, Vol. II., Book IX.) and by others. The most highly esteemed Tyrian hue was a deep blood-color, but full violet, heliotrope and intermediate shades were made by blending. Tarentum, in Southern Italy, also produced a famous red, and great heaps of broken shells in that neighborhood remained in 1789 to attest the importance of this ancient industry. The process was one of crushing the shell and macerating the animal. The juices were at first nearly colorless, but on exposure to the light and proper treatment the rich purple hue was developed. Sunlight seems to have been necessary.

Of the mollusks other than *Murex* which yield the dye, the most important is the nearly related *Purpura*, especially the ‘dog-whelk’ (*Purpura lapillus*), a shell the size of an almond or smaller, which abounds on both coasts of the North Atlantic, and which has been used from early times both in Great Britain and in New England as a source of an indelible violet ink for marking, ornamenting and even dyeing textile fabrics. The color appears to be confined to a ‘vein’ or gland near the head, which yields a drop of viscid liquid, which when first dropped upon the cloth, or used with a pen to draw letters or an ornamental design, is colorless, but as soon as it is exposed to the sun, changes rapidly from light to deep green, to blue and at last to a fine purplish red. ‘If the cloth be now washed with scalding water and soap, and laid again in the sun, the color changes to a beautiful crimson,’ which is permanent. This dye was extensively used in Ireland in the 15th century, for orna-

menting women's gowns in drawn designs; and many persons made their living by this art. Consult works on conchology and antiquities; especially Lovell, *Edible Mollusca of Great Britain* (2d. ed. London, 1884).

PURPLE WOOD, or **PURPLE HEART**. The plum-colored heart-wood of *Copaifera pubiflora* and *Copaifera bracteata*, of the natural order Leguminosæ, natives of British Guiana, where it is generally called Mariwayana. It is said that no other wood is so satisfactory for use in gun carriages and mortar beds, since it withstands the violent concussions remarkably well. Its great beauty and smooth grain should attract the attention of cabinet-makers.

PURPURA (Lat., from Gk. πορφύρα, *porphyra*, purple-fish, purple dye). The term applied to a diseased condition in which a number of hemorrhages occur under the skin, so as to produce blotches of a more or less purple color. These spots vary from one to four millimeters in diameter. When small they are termed petechiæ (q.v.); when large they are known as ecchymoses (q.v.). At first bright red in color, they become darker, and gradually fade to brownish stains. They do not fade on pressure. Purpura occurs as a secondary symptom in a large number of diseases, among them being scurvy, rheumatism, scarlatina, measles, smallpox, typhus fever, epidemic cerebro-spinal meningitis, the plague, leucocythæmia, Hodgkins' disease, cirrhosis of the liver, and Bright's disease. It is dependent on an altered state of the blood. Purpura may follow the use of certain drugs, and snake poison produces a rapid extravasation of blood. As a distinct disease purpura occurs mainly in two forms, the simple and the hemorrhagic. These, however, may be regarded as essentially the same, but of different degrees of severity. In its mildest form purpura appears simply as an eruption of purplish spots on the legs alone or scattered over the body, and attended with little constitutional disturbance. Recovery generally takes place in from ten to twenty days. In the hemorrhagic form the spots are larger and more numerous, and bleeding occurs from the mucous membranes. The nose, mouth, stomach and intestines, kidneys, female generative organs, and the bronchi may be the sources of blood. Severe anæmia ensues and great prostration is succeeded by death. There is often a rise in temperature. This form is usually met with in young and delicate individuals, particularly girls. There are instances of purpura hemorrhagica of great malignancy, which prove fatal within twenty-four hours. The treatment of the mild form is simply rest in bed, tonic medicines, and simple food. In the severe cases efforts are made to stop the hemorrhage by the administration of drugs which have the power of contracting the blood vessels, notably ergot and suprarenal extract. Symptomatic purpura depends for its treatment on the nature of the disease to which it is secondary.



PURPURA LAPILLUS.

shores of both coasts of the North Atlantic. It is carnivorous and is supposed to destroy young

barnacles. Other species of *Purpura* inhabit the southern coasts.

PURPURE. The name for purple, one of the tinctures in heraldry (q.v.).

PURPURIN (from Lat. *purpura*, purple) and **ANTHRAPURPURIN**. Two isomeric organic coloring substances similar to alizarin and obtained along with it from madder root. They are formed also in the artificial production of alizarin (q.v.).

PURSCH, or **PURSH**, FREDERICK TRAUOGOTT (?-1820). A German-American botanist. He was born in Grossenhain, Germany, and educated at Dresden. He emigrated to the United States in 1799, and occupied himself with botanical researches until 1811, when he went to England and there published his *Flora Americæ Septentrionalis* (2 vols., 1814), the most valuable work on the subject that had yet appeared. The following year he issued *Hortus Orloviensis*, and he died in Montreal while preparing a work upon the flora of Canada.

PURSE-CRAB, or **ROBBER-CRAB**. Names for the great East Indian cocoon crab (q.v.).

PURSLANE (OF. *porcelaine*, *pourcelaine*, from Lat. *porcilica*, *portulaca*, purslane), *Portulaca*. A genus of plants of the natural order Portulacaceæ, the best known species of which is



COMMON PURSLANE.

common purslane (*Portulaca oleracea*), which grows in cultivated and waste grounds on the seashore in almost all warm parts of the world, and is cultivated as a pot-herb. It is a short-lived annual, with spreading and rather procumbent stems, and obovate fleshy leaves, which, like the young shoots, are used in salads. The young and tender shoots are pickled in France like gherkins.

PURSUIVANT, pûr'swê-vant (OF., Fr. *poursuivant*, follower, from *poursuivre*, to follow, from Lat. *prosequi*, to follow, from *pro*, before + *sequi*, to follow; connected with Gk. *ἠεσθαί*, *hepesthai*, Skt. *sac*, to follow, and ultimately with Eng. *see*). The third and lowest order of heraldic offices. The office was instituted as a novitiate, or state of probation through which the offices of herald and king-at-arms were ordinarily to be attained. There are four pursuivants belonging to the English college of arms: *Rouge Croix*, the oldest, so named from the cross of Saint George; *Blue Mantle*, instituted either by Edward III. or Henry V., and named in allusion to the robes of the Order of the Garter, or perhaps to the color of the arms of France; *Rouge Dragon*, deriving his title from King Henry VII.'s dexter sup-

porter, a red dragon, assumed in allusion to his descent from Cadwaladyr; and *Portcullis*, named from a badge of the same monarch. There are three pursuivants in the heraldic establishment of Scotland (there were formerly six), known by the names of *Bute*, *Carrick*, and *Unicorn*—titles which, as well as those of the heralds, seem to have originated in the reign of James III. The Scottish pursuivants take precedence according to seniority in office. The Ulster King of Arms in Ireland has four, *Athlone* and *Saint Patrick I., II., and III.* In ancient times any great nobleman might institute his own pursuivant.

PURSY MINNOW. A minnow of the typical genus *Cyprinodon*, especially *Cyprinodon variegatus*, a chubby little fish, of which the male measures three inches, and the female two inches, and which abounds in all the brackish waters of the Atlantic coast south of Cape Cod. It is one of the most brightly colored of the minnows, and may be distinguished by the lustrous steel-blue of the head and forward part of the back (but this fades immediately after death), the dusky bar at the tip of the tail, and the coppery tint of the abdomen. See Plate of KILLIFISHES.

PURUÁNDIRO, p̄ōō'ān'dê-rō. A town of the State of Michoacán, Mexico, 43 miles northwest of the city of Morelia. It is the centre of an important local trade and has leather manufactures. Its municipal population, in 1895, was 7782.

PURU-PURUS, p̄ōō-rōō' p̄ōō-rōōs'. A tribe which formerly lived along the middle Purus, a southern affluent of the Amazon, in Western Brazil, and apparently constituting, with one or two other tribes of the same neighborhood, a distinct linguistic stock which Brinton calls the Arauan. The name refers to a peculiar skin disease with which they were nearly all afflicted, and manifested by white and brown blotches, possibly from their habit of sleeping naked upon the sand, without hammocks. They were savages of the lowest order, both sexes going perfectly naked. They were described by Spix and Martius in 1820 and by Castelnau and Wallace in 1847 and 1853, but the name is now extinct and the tribe seems to be represented by the modern *Pamari* or *Pammary*, i.e. 'eaters of the pama berry,' who live in the same region.

PURURAVAS, p̄ōō-rōō'rā-vās. A legendary king of ancient India, renowned for his kingly virtues and personal beauty, and still more famous on account of his love for the Apsaras, or celestial hetera Urvaśi. Seeing Pururavas, and seen by him, their mutual love was sealed on condition that he would never suffer two rams, which she always kept near her bedside, to be carried from her, and that she should never see him naked. The Gandharvas, choristers in Indra's heaven, and lovers of the Apsaras, being jealous of Pururavas, stole the rams during the night. At this Pururavas was enraged, and, trusting that Urvaśi would not see him, as it was dark, rose in pursuit of the robbers. At that moment, however, the Gandharvas caused a flash of lightning to irradiate the scene, and Urvaśi beheld the King. The compact was violated, and Urvaśi disappeared. Pururavas could find her nowhere. Like one insane, he wandered over the world until he saw her at Kurukshetra, sporting with four other Apsaras in a lotus-pool. Urvaśi, however, forbade him to approach until,

at the end of the year, she should be delivered of the son with whom she was pregnant by him; but after the child's birth she visited the King once each year. Urvaśi succeeded in propitiating the Gandharvas who had caused the separation, and eventually she and the King were enabled to pass to the sphere where Gandharvas and Apsaras dwell together. This legend is as old as the Rig-Veda. It forms the subject of the celebrated drama of Kalidasa, the *Vikramorvaśi*, where, however, Urvaśi's disappearance is ascribed to a fit of jealousy, during which she trespassed on the proscribed bonds of a divine hermitage. The myth of Pururavas and Urvaśi has been interpreted in various ways, as sun and dawn, or, perhaps the best explanation, as the thunder and the cloud which produces the fire of the lightning-flash. Consult: Geldner, *Vedische Studien*, vol. i. (Stuttgart, 1889); Maedonell, *Vedic Mythology* (Strassburg, 1897); Bloomfield, "The Myth of Pururavas, Urvaśi, and Āyu," in *Journal of the American Oriental Society*, vol. xx. (New Haven, 1899).

PURÚS, p̄ōō-rōōs'. A large tributary of the Amazon. It rises on the Montaña of Eastern Peru, flows in a general northeast direction through the northwestern corner of Bolivia and the Brazilian State of Amazonas, and empties into the Amazon through a large delta about 150 miles above the mouth of the Rio Negro (Map: Brazil, D 5). It is a sluggish and much winding stream flowing in its course of 1850 miles through the great forest plains. It is entirely unobstructed, and navigable for boats almost to its source; steamers ascend it 800 miles, and it has several large navigable tributaries. There are hardly any settlements along its banks, except a few stations for rubber-gatherers. The river was first explored to its source in 1864 by the English traveler Chandless.

PURUSHA, p̄ūr'ōō-shā (Skt. *puruṣa*, man). In Hindu philosophy, the efficient cause of the universe as contrasted with its material cause, Prakriti (q.v.). The term is also applied to the supreme god Brahma (q.v.).

PUR'VER, ANTHONY (1702-1777). The translator of the 'Quakers' Bible.' He was the son of a poor Hampshire farmer. Though apprenticed to a shoemaker, he found time to learn Hebrew by himself. After a brief period of school teaching, he went to London (about 1726), where he joined the Society of Friends. In 1758 he returned to Hampshire and there passed the rest of his life. His translation of the Bible, begun about 1733, was published in 1764. For the meaning of different passages, Purver depended upon divine inspiration instead of scholarship.

PURVES, p̄ūr'vēs, GEORGE TYBOUT (1852-1901). An American Presbyterian clergyman, born in Philadelphia, Pa. He graduated at the University of Pennsylvania in 1872, and at Princeton Theological Seminary in 1876, and held his first pastorate in Wayne, Pa., from 1877 until 1880. He was in charge of churches in Baltimore and Pittsburg until 1892, when he was appointed professor of New Testament literature and exegesis in Princeton Theological Seminary. In 1900 he became pastor of the Fifth Avenue Presbyterian Church in New York City, of which he was in charge at the time of his death. Dr. Purves was a preacher of unusual force and effectiveness. His publications include *Testi-*

mony of *Justin Martyr to Early Christianity* (1889) and *Faith and Life*, sermons (1902).

PURVEY, JOHN (c.1354-c.1427). A disciple of Wiclif, who revised the Wiclifite translation of the Bible. He was probably born at Lathbury, a village in Buckinghamshire, and very likely he may have been educated at Oxford. For some years he was Wiclif's parochial chaplain at Lutterworth. After the death of Wiclif (1384), Purvey seems to have settled for a time in Bristol. In 1387 he was forbidden to 'itinerate' in the diocese of Worcester, and in 1390 he was imprisoned for being a Wiclifite. Rather than suffer martyrdom, he recanted in 1401. He was given the vicarage of West Hythe, in Kent, but he resigned in two years (1403). His subsequent career cannot be followed. Wiclif and his associates completed their translation of the Bible in 1380. Made from the Vulgate, it abounded in Latinisms. Purvey, helped by other disciples of Wiclif, set about reducing this version to idiomatic English. The new translation was probably completed about 1388. Purvey also composed a work called *Ecclesie Regimen*, in which he assailed the corruptions of the Church. Consult *The Holy Bible in the Earliest English Versions*, edited by Forshall and Madden (4 vols., Oxford, 1850).

PURVEYANCE, ROYAL. In English law, the former right or prerogative of the Crown to demand supplies and services at the lowest price, to be fixed by appraisers, usually those chosen by the royal purveyors, or officers employed in procuring the royal supplies. This was one of the oldest of the royal prerogatives, and gave rise to endless abuses and complaints until it was finally abolished in 1660, when Charles II. was restored to the throne. Those upon whom the purveyors made a demand had no choice but to sell their goods or services, and usually received their inadequate pay in tallies which entitled the recipients to deduct the amount from future taxes, which latter fact was a hardship in itself. Little is known of the early history of the practice, but the abuses arising from it became so serious that the petitions and laws against it became very numerous as early as the 13th and 14th centuries, and the practice is prohibited to the royal bailiffs and constables in Magna Charta. Later legislation against these abuses occur in the ordinances of 1311 abolishing it, the law of 1322 repealing these ordinances, and the laws of 1362 limiting purveyance to the personal wants of the king and queen. Consult: Stubbs, *Constitutional History* (Oxford, 1878); Hallam, *Constitutional History* (1827).

PUS (Lat., white viscous matter from a sore). A well-known product of inflammation. It occurs as a thick yellow creamy fluid, differing from all other morbid exudations in containing a large number of corpuscles, having a soft and fatty feeling when rubbed between the fingers, a peculiar odor, usually an alkaline reaction, and a specific gravity of about 1.032. Like the blood, it consists of certain definite microscopic elements, and of an intercellular fluid or serum in which they swim. The microscopic elements are: (1) The pus-corpuscles, which, both in their microscopical and chemical relations, seem to be identical with the lymph-corpuscles, or colorless blood-cells; in diameter, they range from 0.004 to 0.005 of a line, and each corpuscle consists of a

cell-wall, which often appears granular, of viscid transparent contents, and of a nucleus which is adherent to the cell-wall, and which can be rendered much more apparent by the addition of acetic acid; (2) molecular granules; and (3) fat-globules. The serum of pus is perfectly clear, of a slightly yellow color, and coagulates on heating into a thick white mass.

The chemical constituents of pus are water (varying from 769 to 907 in 1000 parts), albumen (from 44 to 180), fats (from 9 to 25), extractive matter (from 19 to 29), and inorganic salts (from 6 to 13); in addition to which, mucin, pyin, glycin, urea, etc., are occasionally present. Of the inorganic or mineral constituents, the soluble salts are to the insoluble in the ratio of 8 to 1 and the chloride of sodium (the chief of the soluble salts) is three times as abundant as in the serum of the blood. See **INFLAMMATION**; **SUPPURATION**.

PUSAN, pōō-sān'. See **FUSAN**.

PUSEY, pū'zī, EDWARD BOUVERIE (1800-82). A distinguished English divine and leader of the Oxford Movement. He was born at Pusey House, in Berkshire, August 22, 1800. He was the second son of the Hon. Philip Bouverie, who changed his name to Pusey as a condition of his succession to the Pusey estate in 1789. He was educated at Eton and Christ Church, Oxford, where he obtained a first-class in classics in 1822 and won the university prize for a Latin essay in 1824. In the same year he was elected fellow of Oriel. About this time he spent two years in Germany, and his first published work was an admirable summary of the history of German theology since the Reformation. It appeared in 1828, and in the same year he was appointed to the regius professorship of Hebrew at Oxford, with the attached canonry of Christ Church, a position which he held until his death.

Owing to delays from sickness and other causes, he was not ordained to the diaconate until June 1, 1828, and his ordination to the priesthood followed in November of the same year in order that he might occupy his stall as canon. His life, though profoundly influential, was singularly uneventful. His habits were simple. He lived in his books, mingling but little in general society. He had few personal friends. His chief characteristics were accurate and extensive learning, an innate aptness for the study of languages, rigorous devotion, and dislike of luxurious living. He was deeply and unaffectedly religious, but not morose, and was bright and cheerful in the circle of his intimates.

His domestic life was one of suffering, saddened by successive losses of parents, brothers, wife, and daughter, and finally of his only son, Philip, his companion in scholarship and research, who was taken from him after many years of painful bodily affliction.

Pusey will always be remembered, as he was chiefly known, for his connection with the Oxford Movement. His sermon on the Rule of Faith in 1851 stemmed the tide of secessions to the Roman Catholic Church after the Gorham judgment. The revival of the practice of private confession in the English Church dates from his two sermons on "The Entire Absolution of the Penitent," in 1846. His teaching on the Real Presence in the Holy Communion became the accepted teaching of the Catholic school. He

was the theologian of the new movement. His great learning, enforced as it was by the strictness and purity of his life, gave it its vitality. His suspension for preaching his celebrated sermon on the Eucharist in 1843 only enhanced his influence.

His power of sustained work was remarkable and his painstaking diligence proverbial. His correspondence as a spiritual adviser alone was enormous. His life was one of continuous controversy. He was the editor-in-chief of the *Library of the Fathers*, and there was no important controversy in the Church of England from the time of the publication of his tract *On Baptism* in 1835 to his tilt with Farrar on everlasting punishment in 1879 in which he did not have a part.

His monument is the memorial building at Oxford which bears his name, enshrines his library, and perpetuates his teaching. The Pusey House with its staff of clergy, its daily worship, and devout life is a home of sacred learning and a rallying-point of Christian faith. Besides several volumes of sermons, his more important works were commentaries on Daniel (1864) and on the Minor Prophets (1860 sqq.); his discussions of the possibility of the reunion of Christendom generally known by their sub-title of *Eireneon*, in three parts (1865, 1869, 1870); and the eschatological treatise already alluded to, *What is of Faith as to Everlasting Punishment?* (1880). Consult an admirable biography begun by Canon Liddon and completed after his death by J. O. Johnston and R. J. Wilson (4 vols., London, 1893-96); a brief, more popular one by the author of the *Life of Charles Loider* (ib., 1898); also Grafton, *Pusey and the Church Revival* (Milwaukee, 1902); and many of the works referred to under OXFORD MOVEMENT.

PUSHAN, पुष्यशान (Skt. *Pūṣan*, prosperer, from *puṣ*, to cause to thrive). A deity of Vedic India. He is frequently mentioned in the Vedas (q.v.). He beholds all creatures, and has his home in heaven, where he rides in a golden car drawn by goats. He furthermore conducts the souls of the dead to the Pitris (q.v.), and is consequently a guardian of roads, and, by implication, a discoverer of what is hidden. In his character he is beneficent, protecting not only men, but beasts, and is therefore a deity of wealth, while as a god of fertility he is invoked in the wedding ritual, being himself the lover of his mother, or, according to other hymns, of his sister. He has a unique and somewhat grotesque quality in his toothlessness, in consequence of which his food is gruel. The data concerning him make reasonable the view that he is a pastoral deity representing the sun in its beneficent aspect. Consult: Muir, *Original Sanskrit Texts* (London, 1868-74); Perry, "Notes on the Vedic Deity Pūṣan," in *Classical Studies in Honour of Henry Drisler* (New York, 1894); Macdonell, *Vedic Mythology* (Strassburg, 1897).

PUSHKIN, пушкін, ALEXANDER SERGEYEVITICH (1799-1837). The greatest poet of Russia. He was born at Moscow of a noble family, inheriting African blood from a maternal ancestor. According to the fashion of the time, his education at home was purely French, and his knowledge of Russia was obtained from nursery tales, legends, and songs. In 1811 he entered the Imperial Lyceum at Tsarskoye Selo, where he soon

attracted general attention by his outspoken criticisms of everything and everybody, his neglect of study, his bold epigrams, and his poetic endowments. His first published poem bears the date of 1814, and at the public examination in 1815 he aroused the admiration of the veteran poet Derzhavin by his *Recollections of Tsarskoye Selo*. On graduating in 1817, Pushkin became a clerk in the Ministry of Foreign Affairs. He was now a well-known figure in Russian literature and was immediately accepted as a member of the literary society Arzamas, whose members were the shining lights of the day. His first important long poem, *Ruslan and Lyudmila* (1817-20), a bold combination of fancy and realism, attracted much attention. About this time, because of his objectionable political views, Pushkin was sent to Southern Russia with General Inzoff's colonizing bureau. The life in Bessarabia, the Crimea, the Caucasus, and Odessa was an important period for Pushkin; the variety and gorgeosity of the natural scenery, life among new people, the influence of Byron, with whose works he now became acquainted—all these are set forth in glowing colors in his works of this period. *The Prisoner of the Caucasus*, *The Fountain of Bakhthchisarai*, the first three cantos of *Yevgen Onegin* (Eugene Onegin), a novel in verse, and *The Gypsies* are all a direct product of his Byronism. In 1824 he was transferred to his mother's estate, Mikhaylofskoye (Government of Pskov). The two years spent in this remote corner of Russia were the most fruitful in his life. Cantos four to six of *Yevgen Onegin*, *The Brother Murderers*, and the drama *Boris Godunoff* were written in this exile. Pushkin freely admitted his indebtedness to Shakespeare, Karamzin, and the Chronicles, but the drama is entirely original in character. All the characters, as well as the masses and historical background, are Russian through and through and drawn with a marvelous fidelity to the epoch. In 1829 appeared his *Poltava* (finished in less than a month), depicting the struggle between Peter the Great and Charles XII. and the treachery of Mazeppa. In 1831 he produced the last two cantos of *Yevgen Onegin*. Written within a period embracing about nine years, this picture of society reflects various incidents of the poet's life during its composition.

In 1831 Pushkin was attached to the Foreign Ministry with a yearly salary of 5000 rubles to write a history of Peter the Great. In 1833 he received 20,000 rubles to print his *History of the Pugatcheff Insurrection*. During this period his works were chiefly in prose: the novels *The Captain's Daughter* (1836) and *Dubrovski* (published 1841), and the history, gave Russian prose its highest degree of perfection. He was killed in a duel with D'Anthès, adopted son of the Dutch Ambassador, whose association with Mme. Pushkin had caused much gossip.

Pushkin is the flowering of all that was best in Russian literature before him. He possessed an original intellect, reinforced by a quick intuition. His humor was gentle and his wit keen; his epigrams are among the best ever produced in any language. He had an extraordinary mastery of the technique of his art. A monument to him was erected at Moscow in 1880.

BIBLIOGRAPHY. The best among the numerous editions of his works is that by P. O. Morozoff, in seven volumes (Saint Petersburg, 1887). English translations: *Poems*, by Ivan Panin (2d ed.,

Boston, 1888); *Prose Tales*, by T. Keane (New York, 1896); *Translations from Pushkin*, in memory of the one hundredth anniversary of the poet's birthday, by C. E. Turner (Saint Petersburg, 1899); *Russian Romance*, by Mrs. J. B. Telfer (London, 1875). In German: *Gedichte*, two volumes, by Bodenstedt, in *Gesammelte Schriften*, vols. iv. and v. (1865-69). Consult Flach, *Un grand poëte russe* (Paris, 1894).

PUSH'TU. See AFGHAN.

PUSS IN BOOTS. The popular nursery tale of the clever cat, which secures a fortune and a princess for his master, a young miller, who passes under the name of the Marquis of Carabas. The story was told by Perrault as "Le Chat Botté," in his *Contes de Fées* (1697). He found it in Straparola's *Piacerele Notte*, translated in 1585, in which the hero is called "Constantine's Cat." A celebrated German version is Tieck's *Der gestiefelte Kater*.

PUSS-MOTH. A name in England of *Cerura vinula*, a notodontid moth common throughout Europe and Northern and Western Asia. It expands from 2 to 2.5 inches; the fore wings are white suffused with gray and with dull dark-gray transverse lines; the thorax is spotted with black. The larva feeds on poplar and willow and discharges an acrid fluid from an opening in the throat. At the end of the body the caterpillar has a pair of tubes in which are concealed two long flexible whips which may be rapidly thrust out and withdrawn (see Plate of BUTTERFLIES AND MOTHS, Fig. 14), and which are supposed to protect the larva from its natural enemies, as are also the terrifying attitudes which it assumes and the secretion which it ejects. When full grown it spins a solid and impervious cocoon.

PUSTULE, MALIGNANT. See MALIGNANT PUSTULE; ANTHRAX.

PUTEAUX, py'tô'. A town in the Department of Seine, France, 6¼ miles west of the centre of Paris by rail (Map: Paris and vicinity). It is situated northeast of and at the base of Mont Valérien, on the left bank of the Seine, opposite the Bois de Boulogne, with which it is connected by a bridge which crosses the Ile de Puteaux. It is a favorite residential suburb of Paris. It has dye and calico-printing works, manufactures of chemical products, and artillery works. Population, in 1901, 24,341.

PUTIGNANO, pō'té-nyä'nó. A town in the Province of Bari, Italy, 23 miles southeast of Bari (Map: Italy, M 7). The chief industry is weaving, and there is a trade in wine, oil, and fruit. Population (commune), in 1901, 13,969.

PUTLITZ, put'lits, GUSTAV HEINRICH GANS (von und zu) (1821-90). A German dramatist and novelist, born March 20, 1821, at Retzin, Brandenburg. He studied law in Berlin and Heidelberg. From 1846 to 1848 he was a functionary in the Government of Magdeburg, and thereafter he lived partly on his estate at Retzin, partly in Berlin. In 1863 he became director of the Court Theatre in Schwerin; from 1867 to 1868 he was Court marshal of the Prussian Crown Prince, after which he devoted himself to literature, dwelling in Berlin. Between 1873 and 1889 he managed the Court Theatre in Karlsruhe. Among his works are the poetic fairy stories *Was sich der Wald erzählt* (1850), *Walpurgis* (1869), and *Vergissmeinnicht* (1853); two plays

much read in American schools, *Badekuren* and *Das Herz vergessen*; and the dramas *Das Testament des Grossen Kurfürsten* (1858) and *Rolf Berndt* (1881). Consult *Gustav zu Putlitz, ein Lebensbild*, by his widow, *Elisabeth* (Berlin, 1894-95).

PUTNAM. A city and one of the county-seats of Windham County, Conn., 34 miles north of Norwich, and 28 miles west by north of Providence, R. I., on the Quinebaug River, and at the junction of the New York, New Haven and Hartford and the Norwich and Worcester railroads (Map: Connecticut, II 2). It has a public library and the Day Kimball Hospital. The Cargill Falls in the vicinity are of scenic interest. Putnam is situated in an agricultural region, but is interested chiefly in iron-working and in the manufacture of cotton and woolen goods, silks, boots and shoes. The government is vested in a mayor, elected biennially, and a unicameral council. Putnam was incorporated in 1855 and obtained its present city charter in 1895. Population, in 1900, 6667.

PUTNAM, FREDERIC WARD (1839-). An American anthropologist, born in Salem, Mass. In 1856 he was curator of ornithology in Essex Institute (Salem), and published a *List of the Birds of Essex County*; and in the same year he entered Lawrence Scientific School and took a special course under Louis Agassiz, to whom he was assistant until 1864. He was in charge of the Museum of Essex Institute from 1864 to 1867, then superintendent of the East India Marine Society, and afterwards director of the Peabody Academy of Sciences. He was instructor in the School of Natural History on Penikese Island in 1874, and in the same year was appointed assistant in the Kentucky Geological Survey. In 1875 he was made curator of the Peabody Museum of Archaeology and Ethnology of Harvard University, and was afterwards appointed Peabody professor of American archaeology and ethnology. He was chief of the Department of Ethnology of the World's Columbian Exposition and in 1894 he became curator of anthropology in the American Museum of Natural History of New York City. His researches in American Archaeology covered a wide field, including extensive explorations in Ohio, where he was instrumental in having the Great Serpent Mound preserved, and in New Jersey. He originated the *Naturalist's Directory* in 1865, and was one of the founders of the *American Naturalist* in 1867, and in 1898 he was president of the American Association for the Advancement of Science.

PUTNAM, GEORGE PALMER (1814-72). A grandnephew of Israel Putnam, and a New York publisher. He was born in Brunswick, Me., February 7, 1814. At fourteen he entered the bookstore of D. and J. Leavitt, New York. In 1840 he became partner in the house of Wiley & Putnam, of which he established a London branch in 1841. In 1848 he returned to New York and founded the publishing house which later became the firm of G. P. Putnam's Sons. Bookmaking interested him as an art from the beginning. In 1852, with the aid of George William Curtis, he established *Putnam's Magazine* (discontinued in 1857, revived 1860-70). In 1861 he organized the Loyal Publication Society, suspended his business for three years (1863-66)

to become United States Collector of Internal Revenue, and then refounded his publishing house in conjunction with his sons, George Haven and John Bishop. He was a founder of the Metropolitan Museum of Art, of which he was made honorary superintendent in 1872. He was also Chairman of the Committee on Art at the Vienna Universal Exposition. He died in New York City December 20, 1872. Putnam was the author, among other works, of: *Chronology, or an Introduction and Index to Universal History, Biography, and Useful Knowledge* (1833); *American Book Circular with Notes and Statistics* (1843); *American Facts, Notes and Statistics Relative to the Government of the United States* (1845); *The World's Progress—a Dictionary of Dates* (1850), and a supplement to this work (1861). His son, GEORGE HAVEN (1844—), was born in London and was educated in New York City, at the Sorbonne, and in Göttingen. He served in the Union Army during the Civil War, and rose to the rank of brevet major. Like his father, he took an ardent interest in copyright law, becoming secretary of the American Publishers' Copyright League in 1887. His publications include: *Authors and Publishers* (1882, with J. Bishop Putnam); *Question of Copyright* (1891); *The Artificial Mother* (1894); and *Books and Their Makers in the Middle Ages* (1896). To Mason and Lalor's *Political Encyclopædia* he contributed a valuable paper on "Literary Property."

PUTNAM, HERBERT (1861—). An American lawyer and librarian, born in New York City. He graduated at Harvard in 1883, studied for a time in the Columbia Law School, and in 1886 was admitted to the Minnesota bar. He was librarian of the Minneapolis Athenæum from 1884 to 1887, and of the Minneapolis Public Library from 1887 to 1891; practiced law in Boston from 1892 to 1895; and was librarian of the Boston Public Library from 1895 to 1899, when he became librarian of Congress. In 1898 he was president of the American Library Association.

PUTNAM, ISRAEL (1718-90). An American soldier, prominent in the French and Indian and the Revolutionary wars. He was born in Old Salem Village (now Danvers), Mass.; removed to Pomfret, Conn., in 1740, and became a farmer and wool-grower there. In the winter of 1742-43, according to tradition, he gave evidence of unusual coolness and intrepidity by entering a cave alone and, by the light of a torch, shooting a wolf which had taken refuge there. In August, 1755, during the French and Indian War, he was commissioned lieutenant by the Connecticut Legislature, later in the year became one of Rogers's Rangers, in March, 1756, became captain, saved Fort Edward from being destroyed by fire in the winter of 1757, and in March, 1758, became major. In August, 1758, he was captured near the present Whitehall, N. Y., in an engagement with a force of French and Indians under the partisan leader Marin, but after undergoing many hardships and narrowly escaping death, was exchanged, in November, through the influence of Col. Peter Schuyler, himself a prisoner. He served under Amherst in the Montreal expedition, went as acting colonel of the Connecticut regiment on the expedition to the West Indies, and participated in the attack on Morro Castle, Havana, July 30, 1762. In Pontiac's War he was a major

of Connecticut troops under Bradstreet. In 1765 he was an ardent opponent of the Stamp Act, and closely identified himself with the radical Whigs, becoming one of the leaders of the Sons of Liberty in Connecticut, and chairman of one of the committees of correspondence. In 1766 he was elected to the Connecticut Assembly. He opened a tavern at Brooklyn, Conn., in June, 1767. He was made a member of the so-called exploring committee of the Company of Military Adventurers organized by Gen. Phineas Lyman (q.v.) in 1772, and as such visited the Lower Mississippi Valley and West Florida, where land grants had been promised to the company.

In 1774 he was among those who sent material assistance to the Bostonians, who, through the operations of the Port Bill and their attitude thereto, were put in immediate need of the necessities of life. In April, 1775, tidings of the battle of Lexington reached him while he was plowing; he left his plow in the field and, mounting his horse, rode to Cambridge in one day, a distance of sixty-eight miles. Returning, he was made brigadier-general by the Legislature, organized and drilled a regiment, and in a week was on his way back with his men to Cambridge. In May of that year he led a battalion to Noddle's Island, burned a British schooner, captured a sloop, and killed and wounded many of the enemy. By his advice it was decided to fortify Bunker Hill, in the engagement at which place he is considered by many to have been the commanding officer, though others claim this honor for Prescott. In this engagement Putnam displayed great energy and bravery, though he does not seem to have been present in the main redoubt on Breed's Hill, where Prescott commanded. On the arrival of Washington at the camp to take command in July, 1775, he brought commissions from Congress for four major-generals, one of whom was Putnam. On the evacuation of Boston in the spring of 1776, Putnam was placed in command of New York. He held the chief command within the fortified lines during the battle of Long Island; was sent to Philadelphia to fortify that city in December, 1776; was afterwards stationed at Crosswick and Princeton; and in May, 1777, was ordered to take command in the Highlands of New York. In the summer of that year he was removed from his command in the Highlands on account of the surprise and loss of Forts Montgomery and Clinton, though he was acquitted of blame by a court of inquiry and restored to his command. In 1779, when stationed in Connecticut, Horse-neck, one of his outposts, guarded by 150 men and two cannon, was attacked by the British officer Tryon, with 1500 men. Putnam, being closely pursued while on his way with his men to a swamp, is said to have dashed down a steep hill and escaped. Riding to Stamford and collecting the militia, he formed a junction with his troops, pursued Tryon in his retreat, and took 50 prisoners. In the summer of 1779 he had command of the troops in the Highlands, and completed the fortifications at West Point. The army going into winter quarters, he returned home, and on starting out again for camp was stricken with paralysis, from which he never completely recovered. He died May 19, 1790. Consult Livingston, *Israel Putnam, Pioneer, Ranger, and Major-General* (New York, 1901).

PUTNAM, MARY TRAILL SPENCE (LOWELL) (1810-98). A poetess, translator, and essayist, daughter of Rev. Charles Lowell, sister of James Russell Lowell. She was born in Boston, Mass., December 10, 1810. She married, in 1832, Samuel R. Putnam, a Boston merchant. Besides numerous contributions to magazines, especially on Polish and Hungarian literature and history, she wrote two metrical dramas on slavery, *A Tragedy of Errors* (1862) and *A Tragedy of Success* (1862); a novel, *The Records of an Obscure Man* (1861); *A History of the Constitution of Hungary*, made timely by the visit of Kossuth (1850); *Memoir of William Lovell Putnam*, her son, killed at Ball's Bluff (1862); *Fifteen Days* (1866); *Memoir of Charles Lowell* (her father) (1885); and a translation from the Swedish of Fredrika Bremer's *The Neighbors*.

PUTNAM, RUFUS (1738-1824). An American soldier. He was born in Sutton, Mass.; was a millwright's apprentice there from 1754 to 1757; enlisted as a private soldier for service in the French and Indian War in 1757; and became an orderly sergeant in 1759 and an ensign in 1760. While an apprentice he studied diligently during his leisure hours, gaining a fair knowledge of mathematics and history, and after 1760 devoted himself to the study of surveying, in which he soon became markedly proficient. He entered the Continental Army as lieutenant-colonel in May, 1775, planned the defenses at Roxbury, and in August, 1776, was appointed chief engineer of the army with the rank of colonel. Preferring field service, however, he was placed in command of a Massachusetts regiment in November, and in 1777 served with great gallantry in the campaign against Burgoyne. In 1779 he aided his cousin, Israel Putnam, in completing the West Point fortifications, and in 1783 was made brigadier-general. He was a member for several terms of the Massachusetts Legislature, and during Shays's Rebellion was General Lincoln's aide. In 1786 he, with Gen. Benjamin Tupper, organized a company, composed of officers and soldiers of the Revolutionary War, to form a settlement in what is now Ohio. He was one of three directors appointed by this company (the Ohio Company) in 1787 to secure a tract of land from Congress, and, chiefly through his efforts, 1,500,000 acres were obtained at 66 2-3 cents per acre. This tract was located at the junction of the Ohio and Muskingum rivers, whither in 1788 Putnam led the first party of settlers, laying out Marietta (q.v.), the first organized settlement in the Northwest Territory. He was one of the judges of the United States Court in the Northwest Territory from 1790 to 1796, concluded an important treaty with the Indians at Vincennes, Ind., in 1792, was Surveyor-General of the United States from 1796 to 1803, and was a member of the Ohio constitutional convention in 1802. In 1812 he organized the first Bible society west of the Alleghanies. He died in 1824. His manuscript diary is in the New York Public Library, and an autobiography, written in 1812 and also in manuscript, is deposited in the college library, Marietta, Ohio. Consult *Journal of General Rufus Putnam, 1757-60* (Albany, 1886); also Cone, *Life of Rufus Putnam* (Cleveland, 1886).

PUTREFACTION. See FERMENTATION; PTOMAINES.

PUTRID FEVER. See TYPHUS.

PUTRID SEA. A lagoon on the coast of the Crimea. See SIVASII.

PUTS AND CALLS. See STOCK EXCHANGE.

PUTTENHAM, GEORGE (?-c.1590). The reputed author of a treatise entitled *The Arte of English Poesie, contrived into three bookes; the first of Poets and Poesie, the second of Proportion, the third of Ornament* (1589). The work has also been claimed for his elder brother, RICHARD PUTTENHEIM (c.1520-c.1601). It was issued anonymously. In his dedication to Lord Burghley, the publisher asserted that he had received the book without the name of the author. In his *Hypercritica* (1618), Edmund Bolton said that common fame ascribed the work to "one of the Queen's gentlemen pensioners, Puttenham." Internal evidence points to one of the brothers as the author; but whether George or Richard is uncertain. The book is the most solid of all the early treatises on poetry in English. Consult the reprint by Edward Arber (London, 1869).

PÜTTER, put'ter, JOHANN STEPHAN (1725-1807). An eminent German jurist, born at Iserlohn. He studied at Madgeburg, Halle, and Jena, and after 1747 was professor of law at the University of Göttingen. He exerted great influence on the law institutions of his time, and some of his works, which are written with care and originality, are still valuable. His principal work is *Historische Entwicklung der heutigen Staatsverfassung des Deutschen Reichs* (1786-99); and his other writings include *Vollständiges Handbuch der deutschen Reichshistorie* (1762-72) and *Elementa Juris Publici Germanici* (1754).

PUTTKAMER, put'ká-mêr, ROBERT VIKTOR VON (1828-1900). A Prussian statesman, born at Frankfurt-on-the-Oder. He studied in 1846-50 at Heidelberg, Geneva, and Berlin, entered the Government service in 1854, and became *Regierungspräsident* (president of an administrative district) at Gumbinnen in 1871, and at Metz in 1874. In 1873 he was elected to the Reichstag, where he was prominent as a strong Conservative, in 1877 became chief president of the Province of Silesia, and in 1879 Minister of Education and Public Worship. He took measures against the undenominational schools, and made concessions to the orthodox Evangelicals. In 1881 he was appointed Minister of the Interior and vice-president of the Ministry. His conservative administration, and particularly the methods employed by him in favoring the election of Government candidates, was attacked by the Radicals, notably in a speech by Eugen Richter, and disapproved by Frederick III. upon the latter's accession. He therefore resigned (1888), and held no other office until his appointment as chief president of Pomerania by William II. in 1891.

PUT YOURSELF IN HIS PLACE. A novel by Charles Reade (1870). It is a story of an English manufacturing town, in which Henry Little, a workman and inventor, is persecuted by the trades unions, jealous because he was better trained than his fellows. Squire Raby, Little's uncle, is a forcible character, and a pleasant love-story offsets the labor troubles.

PUVIS DE CHAVANNES, pu'vès' de shá-ván', PIERRE (1824-98). The leading mural painter of France in the nineteenth century. He was

the creator of modern mural painting, which he restored to its real function, that of decoration. Born at Lyons, December 14, 1824, the son of a distinguished engineer, he took the classical course in a lycée, and then studied in a technical school, preparatory to his father's profession. After deciding to become a painter he worked without profit under Henri Scheffer, Delacroix, and Couture, but studied to more effect the works of the early Florentines, especially those of Giotto in Italy, being, therefore, in the main self-taught. He first exhibited in the Salon of 1850, not 1859 as is commonly stated. His first decorative works, "War" and "Peace," exhibited in 1861, were received with disfavor by most critics, but met the approval of the more thoughtful, like Théophile Gautier. They were acquired by the Government for the Museum of Amiens, in which his early decorations can best be studied, such as "Work and Rest" (1863); "Ave, Picardia Matrix" (1865); "Ludus Pro Patria" (1880); "Young Picard Exercising with the Lance" (1882). After the time of the Universal Exposition of 1867, when he received the cross of the Legion of Honor (officer 1887, commander 1889), his position was secure. He was constantly employed upon Salon juries and artistic commissions, and the greater part of his time was taken by great series of paintings for French public buildings. Among the principal of these are two fine representations of Marseilles in ancient and modern times for the museum there; two historic scenes for the Hôtel de Ville, Poitiers (1874-75); the "Infancy of Saint Geneviève" (1876-77), in the Pantheon at Paris—a beautiful idyllic scene; a series of splendid decorations for the museum of his native town, Lyons, among which are "Sacred Grove, Dear to the Arts and Muses" (1884), "An Antique Vision" and "Christian Inspiration" (1886). In 1889 he decorated the great hemicycle of the Sorbonne with an allegory of the noble purposes of its foundation, entitled "Alma Mater."

Puvis de Chavannes was the moving spirit in the secession of the Société Nationale des Beaux-Arts from the Salon in 1890, and in the following year he succeeded Meissonier in the presidency, which he retained till his death. All his later works are remarkable for the tasteful use of modern costume in ideal representation. His decorations in the Hôtel de Ville, Paris, include "Hommage à Victor Hugo" (1894), in which the poet is represented as dedicating his lyre to the city, and two fine landscapes, "Summer" and "Winter." In 1896 he completed his decorations of the Boston Public Library, "The Muses Saluting the Spirit of Enlightenment" and eight fine panels of the "Arts" and "Sciences." His last monumental work was three other large paintings of the life of Saint Geneviève in the Pantheon. The last years of his life passed in quiet at Neuilly, but were saddened by the illness of his wife, the Princess Cantacuzene, and soon after her death the painter himself died, October 24, 1898. His large collection of admirable drawings and careful studies was left by his nephews to the Luxembourg Museum, the City of Paris, and the provincial museums possessing his works. Besides his monumental productions he painted a number of smaller works of which it is sufficient to mention "Girls on the Seashore" (1879); the "Poor Fisherman" (Luxembourg, 1881); "Le Doux Pays," which received the medal of honor in 1882. Of his portraits the most interesting

are those of himself at twenty-five and of his wife, exhibited in 1891.

PUY, pu-é', LE. The capital of the Department of Haute-Loire, France, 37 miles southwest of Saint-Etienne, at the junction of the Loire, Borne, and Dolezon valleys (Map: France, K 6). It is picturesquely situated on the steep southern slopes of Mont Anis, from the summit of which rises precipitously the huge basaltic mass called Rocher de Corneille, crowned by the colossal statue of Notre Dame de France, 52 feet high, on a pedestal 20 feet in height, made in 1860 from 213 Russian cannon captured at Sebastopol. The most notable building of Le Puy is the cathedral, situated in the highest part of the town and reached by a grand stairway of 136 steps. Other notable features are the prefecture, the palais de justice, the Crozatier Museum with a fine art collection, and the monumental Crozatier Fountain. Guipure and other lace, bells, and clocks are manufactured. Le Puy is the ancient *Podium*. It was the capital of the mediæval District of Velay. Population, in 1901, 20,507.

PUYALLUP, pù-ál'úp. A tribe of Washington Indians. They speak the same language as the Nisqually and joined with them in the Treaty of Medicine Creek in 1854. They formerly claimed the entire territory of Puyallup River and exercised a dominating influence among the neighboring tribes. They are now chiefly confined to a reservation in the vicinity of Tacoma. The number on the reservation in 1901 was 536, a decrease of 20 from the previous year.

PUY-DE-DÔME, pu-é' de dôm'. A south-central department of France, formerly a part of Auvergne (q.v.) (Map: France, J 6). Area, 3073 square miles. Plateau and mountain occupy three-fourths of the surface; plain and valley the rest. The volcanic peaks of the Auvergne Mountains, grand in their desolation, and presenting numerous extinct craters, render this region orographically one of the most interesting in France. The highest peak in the Mont Dore group has an elevation of 6187 feet. Puy-de-Dôme, 4086 feet, gives its name to the department. The principal river is the Allier (a tributary of the Loire), which from south to north traverses the fertile valley of Limagne. Rye, wheat, oats, apples, chestnuts, and grapes are cultivated. Coal is mined. There are numerous mineral springs. The mountain forests yield timber. Capital, Clermont-Ferrand. Population, in 1896, 555,078; in 1901, 544,194. Consult Joanne, *Géographie du département du Puy-de-Dôme* (Paris, 1876).

PUZZUOLANA, pùt'sò-ò-li'na, or **POZZUOLANA**. A volcanic rock which has hydraulic properties when ground and mixed with lime. It is named from its occurrence at Pozzuoli, near Naples. It is earthy in character, consisting of particles in a very loose state of aggregation, but its chemical composition may agree very closely with that of basalt (q.v.). This composition may run as follows: Silica, 52 to 60 per cent.; alumina, 9 to 21 per cent.; ferric oxide, 5 to 22 per cent.; lime, 2 to 10 per cent.; water, 0 to 12 per cent. Pozzuolana occurs in the vicinity of Naples and Rome. Trass is a volcanic ash of similar properties found in the Rhine district of Germany; and santorin earth is still another volcanic ash used as a cement, which is found on the island of Santorin in the Greek Archipelago. Trass is

much used in Holland in fresh water and marine engineering work. Similar volcanic ash is found in Central France. Artificial pozzuolanas may be made from slag, brick dust, or ashes. The use of pozzuolana as a hydraulic agent was known to the ancients. Consult: Heath, *A Manual of Lime and Cement* (London, 1893); Schoch, *Die moderne Aufbereitung und Wertung der Mörtel-Materialien* (Berlin, 1896). See CEMENT.

PYÆMIA (Neo-Lat., from Gk. πύον, *pyon*, pus + αἷμα, *haima*, blood). This term and that used to designate the closely allied condition, septicæmia, originated before the idea of bacteria as the etiological factor in the diseases was developed. They have become so fixed in medical nomenclature, however, that they are still retained. Before the discovery of bacteria as the exciting cause, it was the general belief that septicæmia was a condition caused by the presence in the blood of substances undergoing putrefaction, while pyæmia was due to the presence of pus itself in blood channels. In the light of our present bacteriological knowledge, we recognize septicæmia as a condition in which both bacteria and their toxins are scattered throughout the body by means of the vascular and lymph systems; while pyæmia represents a form of septicæmia in which, in addition to the general distribution of septic material throughout the body, this material containing bacteria becomes lodged at different points, thus setting up local foci of infection known as metastatic abscesses. These new abscesses usually occur along lines of easiest blood and lymph communication with the point or points previously infected. Thus in suppuration of the intestines the most common seat of metastasis is the liver, while from septic foci in bones, muscles, skin, etc., abscesses may develop in lungs, kidney, spleen, and other organs. After death from pyæmia there may be no visible changes, even the localized foci of infection being too small to be seen by the naked eye. The wound from which the infection originated may look inflamed or gangrenous. Extensive thrombi in the near-by veins are not uncommon.

Thrombosis may also occur in veins at a distance from the wound. In infections following amputation of the leg it is not uncommon to find the femoral vein filled with a purulent mass as high up as Poupert's ligament. As a result of the thrombosis, infarction or death of tissue from interference with its nutrition occurs. Metastatic abscesses may be found in the lungs, kidneys, liver, intestines; in fact, in any of the viscera. Those in the lungs are chiefly near the pleural surfaces and in the lower lobes. Serous effusion, often with much fibrin, may occur into the pleural and pericardial cavities. Local inflammation of joints, especially of the knee and shoulder, may occur. With the exception of those occurring in serous membranes, these inflammations are usually purulent in character and of the same general nature as the metastatic abscesses. Microscopical examination frequently shows congestion of the viscera, with acute degeneration of the parenchyma cells of the kidney, liver, spleen, etc. Chromatolysis of the cells of the brain and spinal cord occurs, also swelling of the lymph nodes with proliferation of their elements. An increase in the number of white blood cells is of almost constant occurrence. While other species of bacteria act as occasional excitants of pyæmia and septi-

cæmia, two species are so frequently associated with this condition that they have received the name of the pyogenic cocci. They are known as the staphylococcus and the streptococcus. The staphylococcus pyogenes aureus is the micro-organism most frequently associated with suppuration. It is a small round coccus averaging about one micron in diameter. It grows in groups somewhat resembling bunches of grapes, from which characteristic its name is derived. It is non-motile. It grows well on the ordinary culture media, such as beef broth, agar, gelatin, milk, and potato, at room temperature. On some of the media it develops a rich golden color, whence its name of aureus. It stains easily with aniline dyes, and does not decolorize with Gram's method. The staphylococcus pyogenes albus, so called from the whiteness of its colonies, is a less frequent and less violent inciter of suppuration than the staphylococcus pyogenes aureus. It may occur in association with the latter or alone. The staphylococcus epidermidis albus is a rather weak pyogenic coccus sometimes found in stitch abscesses.

The streptococcus pyogenes is also a common cause of suppuration and may occur either alone or in association with the staphylococci. Its effects are quite similar to those of the staphylococci. Upon culture media it grows somewhat more slowly than the staphylococci and differs from the latter in not fluidifying gelatin. Its colonies are apt to be of a grayish color. It is non-motile, and when seen under the microscope shows its tendency to form chains, whence its name.

While the above are the most common excitants of suppuration, other micro-organisms may act as causative factors. Thus the typhoid bacillus has been found in pure culture in acute suppurative inflammations of the middle ear, in osteomyelitis, in empyæma, and in localized peritonitis occurring during or after an attack of typhoid fever. The pneumococcus has been found alone in abscesses of the soft parts, in purulent cerebro-spinal meningitis, synovitis, pericarditis, and suppurative inflammation of the middle ear. The bacillus coli communis has been found in pure culture in abscess of the liver, in appendicitis, in acute peritonitis, in purulent inflammation of the gall bladder, and in other inflammatory conditions. Among the less common excitants of suppuration may be mentioned the gonococcus, the micrococcus tetragenus, the bacillus pyocyaneus, the bacillus of glanders, the diplococcus of cerebro-spinal meningitis, and the bacillus pyogenes fetidus.

PYAT, pyá, FÉLIX (1810-89). A French Communist and journalist. He was born at Vierzon, and trained for the law. After the failure of the Socialist call to arms in 1849, he escaped to Switzerland. Thence he went to Belgium and England as a member of the European Revolutionary Committee. The events of 1870 brought him back to France to take active part in the Commune. He was a prime mover in the overturning of the Vendôme Column, and on the collapse of the Commune escaped to London. In his absence he was condemned to death (1873), but he was pardoned (1880) and elected Deputy from Marseilles (1888). Pyat died at Saint Gratien, August 4, 1889. He contributed to many newspapers and edited several revolutionary journals. He wrote several very popular

Socialistic plays, of which *Mathilde*, *Diogène*, and *Le chiffonnier de Paris* are characteristic. His attempts in non-dramatic fiction are insignificant.

PYATIGORSK, pyá'tyé-górsk', or **PIATIGORSK**. A noted watering place in the Territory of Terek, Northern Caucasia, situated on the southern slope of the Mashuka and south of the Beshtau, 124 miles by rail northwest of Vladikavkaz (Map: Russia, F 6). There are about twenty sulphur springs ranging in temperature from about 84° to 117.5° and used both for bathing and drinking. Population, in 1897, 18,638.

ΠΥCNOΓON'IDA. See PANTOPODA.

PYDNA (Lat., from Gk. Πύδνα). A Greek settlement in ancient Macedonia, on the west coast of the Thermaic Gulf. It seems to have passed early into the power of the Macedonians, but appears from time to time as independent. In the fourth century B.C. it was a dependency of Athens, but was captured by Philip, who converted it into a strong fortress. Near it took place in B.C. 168 the great battle between the Romans, under Æmilius Paullus, and the Macedonian King, Perseus, in which the latter was defeated and the Macedonian Empire destroyed. Under the Romans the town seems steadily to have declined.

PYE, HENRY JAMES (1745-1813). An English poet laureate, eldest son of Henry Pye of Faringdon, in Berkshire. He was educated at Magdalen College, Oxford (M.A. 1766; D.C.L. 1772). He entered Parliament, but retired in 1790. In 1792 he was appointed police magistrate for Westminster. Beginning verse writing at an early age, he published several small volumes, and collected his poems in 1787 under the title *Poems on Various Occasions*. Though he was a tame versifier, he became laureate in 1790 through the favor of Pitt. The appointment met with ridicule. The annual ode, which appeared regularly, was long a merry incident among literary men. Pye's most ambitious poem was an epic in six books on Alfred (1801). He also translated Bürger's *Lenore* (1785), and wrote two novels and several plays. See LAUREATE, POET.

PYELITIS (Neo-Lat., from Gk. πύελος, *pyelos*, trough, pan, pelvis). Inflammation of the pelvis of the kidney. It may be caused by kidney-stones, inflammation extending from the bladder or stagnation of the urine. Severe pains in the loins accompany the disease. The urine contains a variable amount of pus and blood. The severe forms due to the presence of kidney-stones require surgical treatment (removal of the calculi). In lighter cases regulation of the diet and avoidance of all stimulating drinks will prove beneficial.

P'YENG-YANG, pyéng'án', or **P'YUNG-YANG**. A town of Korea. See P'ING-YANG.

PYGMA'LION (Lat., from Gk. Πυγμαλίων). A legendary king of the island of Cyprus, who, disgusted with the dissolute character of the women of his island, resolved never to marry. Enamored of a beautiful ivory statue which he had made, he requested Venus to give it life. His prayer was granted, and the vivified statue bore him a daughter, Paphos, who, according to some, became by Apollo mother of Cinyras, the founder of Paphos. Others told how Cinyras

married Metharme, daughter of Pygmalion. The love of Pygmalion for his statue is told by Ovid (*Metam.*, x. 243). According to another version, Pygmalion conceived a passion for the temple statue of Aphrodite herself.

PYGMIES (Lat. *Pygmaeus*, from Gk. Πυγμαίος, *Pygmaios*, pygmy, dwarf, of the length from the elbow to the knuckles, from πυγμή, *pygmé*, measure from the elbow to the knuckles, fist; connected with Lat. *pygnus*, fist). A dwarf negroid population of equatorial Africa across the continent from Uganda to the Gabon, including Akkas, or Tiki-Tiki, Afii, Wambutti, Batwa, and Obongo. They are under five feet in stature, brown in color, and are not to be confounded with the Bushmen. The present habitat of the pygmies is the inter-tropical forest zone, between six degrees north and south of the equator, where they exist in small groups, though formerly they had a more extensive range toward the north. Remains of Neolithic dwarfs have been found at the Schweizersbild Station in Switzerland, but they differ in cranial features from the African pygmies. Besides the African pygmies there are dwarf races in the Malay Peninsula (Pangan tribe), and in islands in Micronesia and Melanesia. In the Philippines are interesting pygmies (see ÆTA), who scarcely differ in appearance from those of Africa, but are somewhat taller. The pygmies have, as a rule, shapely bodies, and small hands and feet. They have woolly hair, dark skin, small oval eyes, high cheek bones, broad foreheads, and thick lips. The mean stature of some of the tribes is four feet three inches. They are retiring and live in the forests, usually under the protection of the taller tribes, whom they serve in various ways. They are expert hunters, and kill game by stealth with poisoned arrows. In character, so far as known, they show childish traits, are born mimics, and delight in songs and posture dances.

Consult: Quatrefages, *Les pygmées* (Paris, 1887); Flower, "The Pygmy Races of Men," *Journal of the Anthropological Institute*, vol. xviii. (London, 1888-89); Keane, *Man: Past and Present* (Cambridge, 1899); Johnston, *Uganda* (London, 1903).

PYGOP'ODES (Neo-Lat. nom. pl., from Gk. πυγή, *pygē*, rump + πούς, *pous*, foot). An order of birds, originally including the grebes, loons, auks, murrets, and puffins. This is now known to be an unnatural assemblage, and the use of the term has been abandoned in this sense. It is properly retained by some writers as the name of an order equivalent to 'Colymbiformes' of others, including only the loons and grebes.

PYLE, HOWARD (1853—). An American illustrator and author. He was born in Wilmington, Del., March 5, 1853, and studied art at a private school in Philadelphia. After practicing his profession in New York City from 1876 to 1879, he returned to Wilmington, where he has since resided. Pyle is one of the foremost American illustrators, being especially successful in juvenile work. A master of linear composition, he is bold and original in his sense of design, and equally efficient in pen-and-ink, wash drawings, and color compositions. His best subjects are taken from the colonial periods of New England and New Amsterdam, and from the life of adventurers

and seafaring men. He sometimes writes the text for his illustrations, being author and illustrator of the *Merry Adventures of Robin Hood* (1883); *Pepper and Salt* (1885); *The Rose of Paradise* (1887); *A Modern Aladdin*, and *Men of Iron* (1891); *Jack Ballister's Fortunes* (1894); *Twilight Land*; and *The Garden Behind the Moon*.

PYLUS, or PYLOS (Lat., from Gk. Πύλος). An ancient town of Messenia, in the Peloponnesus, on the promontory of Coryphasium at the northern entrance to the Bay of Pylos (Navarino). Strabo says that it was originally inland at the foot of Mount Ægaleum, and that Coryphasium was only settled by part of the population on the destruction of the old city. However this may be, after the conquest of Messenia by the Spartans, the place seems to have been abandoned, until in B.C. 425 it was occupied by the Athenian general Demosthenes, who fortified the high and precipitous promontory, and successfully repelled assaults of the Spartans by sea and land. The Athenian fleet, which arrived after the first assault, forced an entrance into the bay at both ends of the long island of Sphacteria, defeated the Spartan fleet, and blockaded 420 Spartans on the island, where they were subsequently forced to surrender to an Athenian force under Demosthenes and Cleon. The Athenians held Pylos for fifteen years, when it was recaptured by the Spartans, and again fell into obscurity, though after the restoration of the Messenians it became the port of the country. At the end of the thirteenth century it was fortified with a strong Venetian castle, and another was built at the southern entrance to the bay, near the town of Navarino, now called Pylos. The mediæval name is probably due to the settlement here in 1381 of Navarrese mercenaries, though some derive it from Avarino and trace it to an Avar settlement 800 years earlier. In the bay was fought, on October 20, 1827, the great naval battle of Navarino, in which the Turkish-Egyptian fleet was destroyed by the united English, French, and Russian fleets under Admiral Codrington.

PYM, JOHN (1584-1643). An English Parliamentary leader, born at Brymore, in Somersetshire. In 1599 he entered what is now Pembroke College, Oxford, but did not graduate, and in 1602 entered the Middle Temple, though he was never admitted to the bar. There is some doubt whether Pym sat in the Parliament of 1614, but in any case he was not prominent until the Parliament of 1621. He was a Puritan, and his interests during this period were chiefly religious, his first speeches in Parliament being directed against the Catholics. He became so obnoxious to the Court that he was imprisoned for three months in his home in London. In the first three Parliaments of Charles I. he was the leader in the impeachment of Montagu and Manwaring, two clergymen who had attacked Calvinistic doctrines and treated the Parliament with scant respect, and he was prominent in the impeachment of Buckingham. He was also prominent in the agitation which preceded the Petition of Right (q.v.). Nothing is heard of him in the intervals between Parliaments. During the eleven years of Charles's personal government he was intimately connected with various schemes for the settlement of the Connecticut Valley. In 1640, on the meeting of the

Short Parliament, Pym became its real leader, though no formal leadership was recognized in those days, and his influence over the Puritan party continued undiminished until his death. He opened the Short Parliament with a speech two hours in length, setting forth the grievances of the nation, and persuaded the Parliament to postpone the supplies until these grievances were redressed. On the opening of the Long Parliament, which met likewise in 1640, Pym was resolved to proceed to extremities. He introduced and conducted the impeachment of Strafford for high treason in attempting to subvert the Constitution, but he resisted in vain the dropping of the impeachment and the introduction of the bill of attainder, though it was due to his efforts that, notwithstanding the bill of attainder, Strafford was heard in his own defense. The Triennial Act (q.v.) was largely his measure. The adherence of the bishops to the cause of Charles I. led to the demand for their abolition, and Pym supported the 'Root and Branch' bill which was introduced for this purpose, though it was not his intention to introduce Presbyterianism.

He naturally took a prominent part in drawing up and passing the Grand Remonstrance (q.v.) in 1641, and he even proposed at this time to hold the King in check by making his ministers responsible to Parliament. On the unsatisfactory outcome of the campaigns in 1642 Pym favored and carried out, though reluctantly, the union with the Scots, with the unwelcome condition of the acceptance of the Covenant and the introduction of a Presbyterian form of Church government. Even before the meeting of the Long Parliament, Pym may have had communication with the Scots, and he was the leader of the five members whom Charles on January 4, 1642, attempted in vain to arrest in person on the floor of the House of Commons on the charge of treasonable conspiracy with that nation. He in turn suspected Charles of treasonable designs, and was ever on guard, in order to prevent the King from using force successfully against Parliament. Pym, like Hampden, favored a vigorous prosecution of the war, and, like Hampden, died soon after its beginning, December 8, 1643. Consult: Gardiner, *Great Civil War* (4 vols., London, 1893); Forster, *Statesmen of the Commonwealth of England* (5 vols., London, 1841-44); Goldwin Smith, *Three English Statesmen* (London, 1867).

PYNCHON, pin'chon, CLIFFORD. A broken-down elderly man in Hawthorne's *House of the Seven Gables*, imprisoned many years on a false charge of murder. His sister, Hepzibah, keeps a little shop in the ill-fated house, and both inherit Judge Pyncheon's property on his tragic death.

PYNCHON, JOHN (1621-1703). An American colonist, born in Springfield, Essex County, England. He was brought to Massachusetts when a child by his father, William Pynchon (q.v.). By inheritance and by purchase from the Indians, he obtained large tracts of land in the Connecticut Valley, on which he established Northampton, Hadley, and other towns. His diplomacy in treating with the Indians was of great service to the colony. He held many important public offices, including that of councillor under Sir Edmund Andros in 1688-89, and again under the new charter from 1693 until his death.

PYNCHON, THOMAS RUGGLES (1823—). An American clergyman and educator, born in New Haven, Conn. He graduated at Trinity College, Hartford, and in 1849 was ordained. His first charge was in Boston, and afterwards he had churches in Lenox and Stockbridge, Mass. (1849-54). He was Scoville professor of chemistry and natural sciences at Trinity from 1854 until 1877, and from 1874 until 1883 was president of that institution. In 1887 he took the chair of moral philosophy there.

PYNCHON, WILLIAM (1590-1662). An American colonist and theologian. He was born at Springfield, Essex. He emigrated to the colony of Massachusetts in 1630, and was treasurer of the colony in 1632-34. He was one of the first settlers of Springfield in 1636. On a visit to England in 1650 he published *The Meritorious Price of Our Redemption, Justification, etc., Clearing it from Some Common Errors*. The strongly anti-Calvinistic position of this work made it very unacceptable to the Puritan clergy, and on his return to Massachusetts he was condemned by the Legislature, which, on October 16, 1650, ordered his book to be burned the next day in Boston market 'after the lecture.' He was himself cited to appear before it. As the result of further study he retracted some of his opinions, but his position in America continued unsatisfactory, and in 1652 he returned to England and settled at Wraysburg, near Windsor. He replied to his principal critic, Rev. John Norton, in the second edition of his book (1655).

PYNE, PIN, JAMES KENDRICK (1852—). An English organist and composer. born in Bath, where his father was organist in the Abbey. The boy at eleven became organist of All Saints' Church, and in the next year was put under Dr. S. S. Wesley. In 1874 he was appointed organist in Chichester Cathedral. He spent a year as organist of Saint Mark's in Philadelphia, and upon his return to England was appointed to a like position in Manchester Cathedral. He acted as professor in the Manchester Royal College of Music in 1893, and in 1901 was lecturer on ecclesiastical music at Victoria University. He published vocal music and compositions for cathedral use, and for organ and piano. Of his songs the best known are those for the words of Edwin Waugh, the Lancashire poet.

PYNE, LOUISA FANNY (1832—). An English soprano singer. She was the daughter of G. Pyne, a celebrated vocalist, and was trained almost entirely by Sir George Smart. She made her first public appearance in 1842, and five years later was successfully received in Paris. Her debut in opera was in 1849 at Boulogne, when she appeared as Amina in *La Sonnambula*. From 1854 to 1857 she toured the United States, and was uniformly successful. Her greatest reputation was obtained as the prima donna of an English opera company, in which she was associated with Harrison at the Lyceum, Drury Lane, and Covent Garden theatres. In 1868 she was married to Frank Bodda, a barytone singer.

PYN'SON, RICHARD (?-1530). One of the early London printers, by birth a Norman. He undoubtedly learned his trade in Normandy, and not under Caxton, as has been often asserted. Some time before 1593 he began printing near Temple Bar, and about ten years later he moved to Fleet Street. Pynson issued some of the most

beautiful books published at that time in England. From his press proceeded more than three hundred books. Among the earliest were Chaucer's *Canterbury Tales* (1493); Parker's *Dialogue of Dives and Pauper* (1493); Terence (1496), the first classic printed in England; the *Morton Missal* (1500), representing his finest work. He became printer to Henry VIII., from whom he received a pension.

PYRA, πέρ'α, IMMANUEL JAKOB (1715-44). A German poet. He was born in Kottbus, studied theology at Halle, where he joined Lange's *Dichterbund*, and with Lange lived at Laublingen. The two poets published *Freundschaftliche Lieder* (1746), which, with their delight in friendship and their unrhymed verse, foretell Klopstock. Pyra boldly, and rather pedantically, attacked Gottsched in 1736 with *Erweis dass die Gottschedianische Sekte den Geschmack verderbe* (1743), and his premature death was partly due to the bitter personalities with which the attack was returned. Consult Waniek, *Immanuel Pyra* (Leipzig, 1882).

PYRAMID (Lat. *pyramis*, from Gk. *πυραμίς*, pyramid, from Egyptian *per-em-us*, coming out in breadth, denoting probably the ratio of the base to the height). A polyhedron (q.v.) one of whose faces (the base) is a polygon and whose lateral faces are triangles. Thus a pyramid is a prism (q.v.) whose upper base is zero. A pyramid is said to be *regular* when the base is a regular polygon and the vertex lies in the perpendicular to the base erected at its centre. The altitude is the perpendicular distance between the base and the vertex. The *slant height* of a regular pyramid is the altitude of any one of the triangles which make up its lateral faces. When a pyramid is cut by a plane, the portion containing the base is called a *truncated* pyramid; if the intersecting plane is parallel to the base, a *frustum*. The formula for the volume of a pyramid is $V = \frac{1}{3}bh$, and for the frustum $V = \frac{h}{3}(b + b' + \sqrt{bb'})$, where b and b' are the bases, and h is the altitude. Consult Holzmüller, *Elemente der Stereometrie* (Leipzig, 1900-02).

PYRAMID. A solid structure, usually of stone, having a square base and triangular sides meeting in an apex. True pyramids are found only in Middle Egypt, and date from the period between the Fourth and Twelfth dynasties, though a few may be somewhat older. Pyramidal buildings occur elsewhere, but they differ in important particulars. The pyramids of Mexico, for example, have flat tops and the sides form successive stages or steps. Those of Abydos and Meroë are merely imitations of pyramids on a small scale; they are really sepulchral chambers having the pyramidal form externally, and are usually provided with porticoes representing the funerary chapels of older tombs. The pyramids found at Cenchræ and at Rome are sporadic attempts to reproduce the Egyptian type.

With regard to the mode of construction of the pyramids of Egypt, two principal theories have been advanced. Lepsius, followed by Ebers, and more recently by Borchardt, believed that each king, on ascending the throne, began to build a pyramid as a tomb and monument for himself. This was usually laid out upon a comparatively small scale, so that if the builder

had but a short reign his tomb might be complete. As time passed, successive layers were added, and the size of the monument was thus proportioned to the length of the builder's reign. This theory is combated by Petrie (q.v.), who believes that each pyramid was begun and carried out upon a definite design of size and arrangement. The plan was occasionally altered, but in such cases the alteration was not gradual, but sudden. The outer casing of the pyramids was invariably of massive blocks of fine stone, well joined, and carefully polished. The interior of the mass varied at different periods. In the oldest pyramids it was formed, so far as is known, of courses of rough-hewn blocks laid with a little mortar. In later times the core was formed of brick and rubble inclosed between inner and outer walls of solid masonry, and under the Twelfth Dynasty the core is almost entirely of sun-dried bricks. Each pyramid contained a sepulchral chamber which was always low down, and was usually excavated in the rock underlying the structure. It was reached by a passage opening from the northern face of the pyramid and passing, in its course, through one or more lesser chambers. The external entrance was usually situated above the level of the sepulchral chamber, and the passage sloped downward at a moderate angle. Pyramids seem to have stood originally within walled inclosures, and traces of the walls are still to be found in many cases. To each pyramid was attached a temple in which the funerary worship of the deceased Pharaoh was conducted by priests who were supported by a regular endowment. Such temples are still to be seen at Ghizeh, and the priests of the various pyramids are frequently mentioned in the Egyptian inscriptions. Around the pyramid of each king are grouped the tombs (mastabas) of the nobles and high functionaries who had lived under his reign.

The pyramids that now exist in Egypt, some seventy-five in number, extend in groups from Abu Ro'ash on the north to Medum on the south. The group of Abu Ro'ash consists of three pyramids all ruined; the largest of them has lost its outer casing, and is now a shapeless mass of Nile mud inclosing a nucleus of massive stone. One of the others still contains a sepulchral chamber and the passage leading to it. Farther to the south lies the group of Ghizeh, by far the most important among the Egyptian pyramids. The largest of the group is the *Great Pyramid*, the tomb of Cheops (q.v.), the second King of the Fourth Dynasty. It was called by the Egyptians *Yechwet Chufu*, 'the glory of Chufu' (Cheops). Its present perpendicular height is 451 feet, but originally, including the nucleus of rock at the bottom and the apex which has disappeared, it measured 482 feet, or more than 50 feet higher than Saint Peter's at Rome. The sloping sides, which rise at an angle of $51^{\circ} 50'$, are now 568 feet in slant height and have a length of 750 feet at the base. The cubic contents amount to about 3,057,000 cubic yards, representing a weight of no less than 6,848,000 tons. According to Petrie's estimate, the pyramid contains about 2,300,000 blocks of stone averaging some 40 cubic feet in size. In its present condition this immense edifice covers a space of nearly thirteen acres. The material of which it is constructed consists of stone from the Mokattam and Tura hills on the opposite

side of the Nile. Traces of the road by which the stone was conveyed are still visible. The outer casing of this pyramid has long since disappeared, and the underlying courses of rough-hewn stone now form a series of steps. The entrance is in the north face of the pyramid at the height of about 48 feet from the ground. From it there was a narrow passage, 3 feet 4 inches high by 3 feet 11 inches wide, which, after descending into the interior at an angle of $26^{\circ} 41'$ for a distance of 293 feet, terminates in a horizontal corridor, 27 feet long, 3 feet high, and 2 feet wide, leading to a subterranean chamber hewn in the solid rock. This chamber is 46 feet long, 27 feet wide, and $10\frac{1}{2}$ feet high. Its floor lies $101\frac{1}{2}$ feet below the level upon which the pyramid is built, and a blind passage opens from its farther end. Some 60 feet from the external entrance a second passage branches off from the long descending passage and ascends at about an equal angle for a distance of 121 feet, when it enters the Great Hall. At this point a horizontal corridor leads from the ascending passage to the so-called Chamber of the Queens, which is 17 feet long, 18 feet 10 inches wide, and 20 feet high. The Great Hall, which continues the ascending passage, is 28 feet high and 155 feet long, but is very narrow, the width of the lower part being 3 feet 4 inches, and that of the upper part only 2 feet 7 inches. It terminates in a horizontal passage 122 feet long and 3 feet 8 inches high, expanding about the middle into an antechamber. At the end of the horizontal passage is the King's Chamber, the most remarkable of all the chambers in the pyramid. The northern and southern sides are each 17 feet in length, the eastern and western sides $34\frac{1}{2}$ feet, and the height is 19 feet. The floor is $139\frac{1}{2}$ feet above the plateau upon which the pyramid stands. The chamber is lined with finely polished granite slabs, and the ceiling is formed of nine great blocks of granite, each $18\frac{1}{2}$ feet long. Within the chamber is a mutilated stone sarcophagus, the lid of which has disappeared. In order to relieve the roof of the pressure of the superincumbent mass of masonry, five hollow chambers have been constructed above it. The first four have flat ceilings, while the last is roofed with blocks bearing obliquely against each other. Two air shafts (8×6 inches) run from the King's Chamber to the northern and southern faces of the pyramid. Near the Great Pyramid, on the east side, are three small pyramids built for members of Cheops's family; a few hundred yards to the southeast is the Sphinx (q.v.).

The *Second Pyramid*, situated about 200 yards southwest of the Great Pyramid, was erected by Chephren (q.v.), the successor of Cheops, and was called by the Egyptians *Wer-Chafré*, 'great is Chephren.' Its present perpendicular height is 450 feet (formerly 458 feet), while the sloping sides, measuring each $694\frac{1}{2}$ feet at the base, rise at an angle of $52^{\circ} 20'$ to the height of $566\frac{3}{4}$ feet. Part of the original casing still remains at the top. The fact that it stands upon a higher level than the pyramid of Cheops gives it the appearance of greater height. The rocky ridge upon which it is built rises somewhat toward the west and north, and a considerable part of it had to be cut away in order to secure a level surface. The leveled space around the base of the pyramid was paved with blocks of

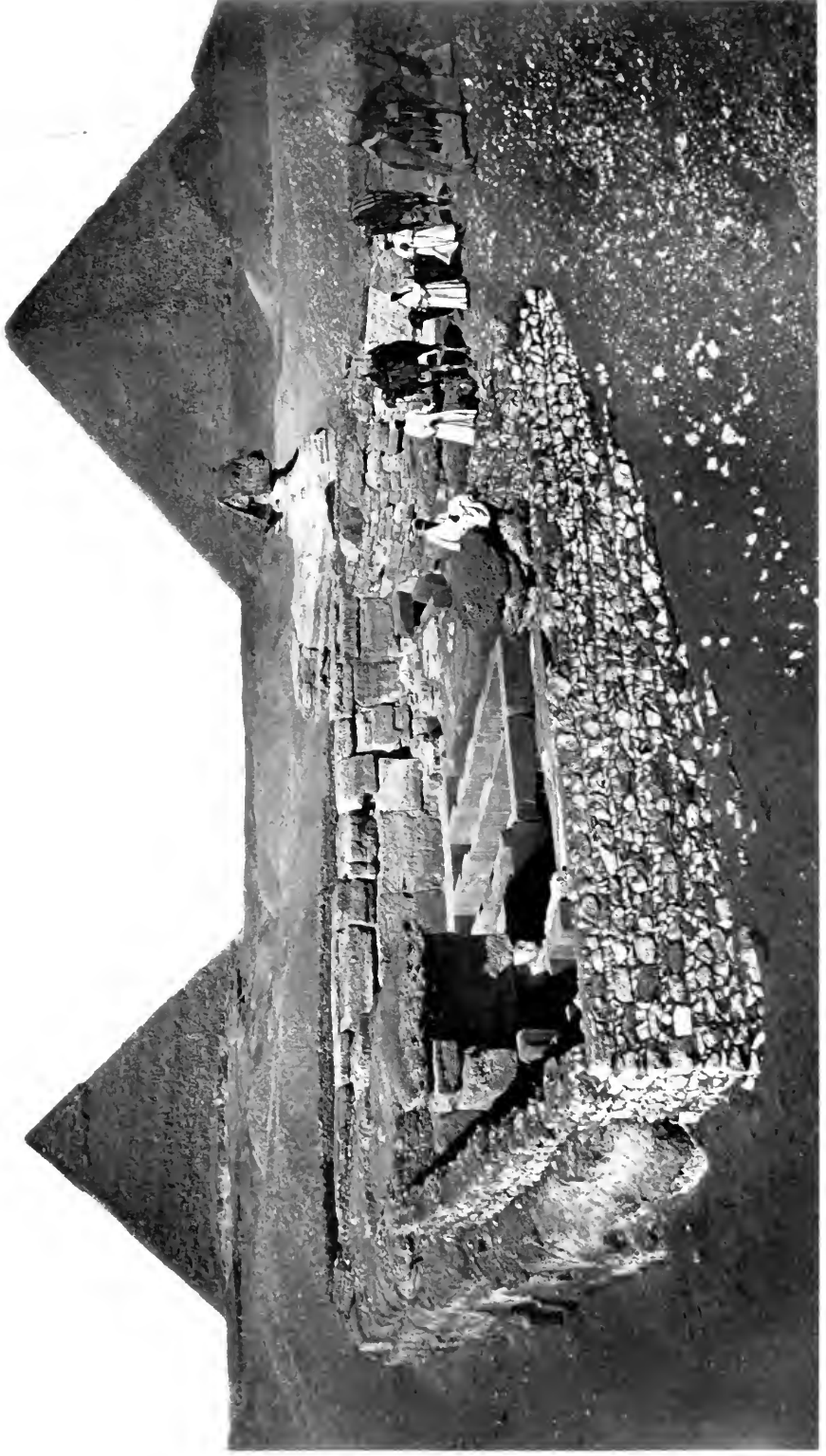

PYRAMIDS
PYRAMIDS OF CHEOPS AND CHEPHREN SPHINX AND TEMPLE OF CHEPHREN

limestone. Two passages, both on the north side, give access to the interior. One of these is in the pavement in front of the pyramid, the other is 38 feet above the surface of the ground. The upper passage descends at an angle of $25^{\circ} 55'$ to a depth of 105 feet, and leads through a horizontal corridor to the sepulchral chamber called, from its discoverer, Belzoni's Chamber. It is hewn in the rock and is $46\frac{1}{2}$ feet long, $16\frac{1}{3}$ feet wide, and $22\frac{1}{2}$ feet high. Belzoni, who opened the pyramid in 1818, found in this chamber a granite sarcophagus filled with rubbish. The lower passage, beginning in the pavement in front of the north face of the pyramid, first descends at an angle of $21^{\circ} 40'$, then runs horizontally for 59 feet, and then ascends, terminating in the horizontal corridor leading to Belzoni's Chamber; the total length of the passage is 97 feet. Near the middle of its horizontal portion a small chamber is introduced, and a descending passage, 22 feet long, leads to another chamber, 34 feet 3 inches long, 10 feet 4 inches wide, and 8 feet 5 inches high.

The *Third Pyramid*, called by the Egyptians *Neter-Menkauré*, 'Menkauré is divine,' was built by Menkauré, the successor of Chephren, and the Mycerinus of Herodotus. Its perpendicular height is 204 feet, and the sides, which slope at an angle of 51° , rise to the height of $262\frac{3}{4}$ feet. Each side measures $356\frac{1}{2}$ feet at the base. The lower part of the pyramid is cased with slabs of polished red granite. The entrance is about 13 feet above the ground on the north side. From it a passage slopes down at an angle of $26^{\circ} 2'$ for a distance of $104\frac{1}{2}$ feet, then, becoming nearly horizontal, passes through an antechamber 12 feet long, 10 feet wide, and 7 feet high, and finally enters a large chamber $44\frac{1}{2}$ feet long, $12\frac{1}{2}$ feet wide, and 13 feet high, in which were found the remains of a stone sarcophagus. From the floor of this chamber a shaft leads to the tomb chamber, which lies below. It is paved with fine granite blocks, and has an arched roof formed of blocks placed against each other at an angle, and hollowed out on the inside. In this chamber Colonel Vyse found the basalt sarcophagus of Mycerinus, but it was lost at sea in 1838 while being conveyed to England. In the chamber above were found a part of the wooden coffin of the King and some fragments of his mummy. To the south of this pyramid are three small pyramids, probably constructed for members of the family of Mycerinus.

South of Ghizeh are the pyramids of *Abusir*, the ancient Busiris, erected by kings of the Fifth Dynasty. The entrances of these pyramids are, as usual, on the north side, and in all of them the tomb chamber is reached by a passage at first slanting and afterwards horizontal. The northernmost of the three largest pyramids (originally fourteen in number) is that of Sahurê, the second King of the Fifth Dynasty. Its perpendicular height, originally $163\frac{1}{2}$ feet, is now only 118 feet. The central pyramid is that of Rê-en-woser, the sixth King of the same dynasty. The largest of the three, which has a perpendicular height of 165 feet (formerly 229 feet), has not yet been identified. The other pyramids of this group are mere heaps of ruins.

The burial field of Saqqâra contains a considerable number of pyramids. Of special interest is the so-called 'step pyramid,' the tomb

of Zoser, the second King of the Third Dynasty. It rises in six steps which are respectively 38, 36, $34\frac{1}{2}$, 32, 31, and $29\frac{1}{2}$ feet in height; the width of each step is from 6 to 7 feet. The perpendicular height is 197 feet. The interior of the pyramid contains a very numerous and complicated series of passages and chambers. According to Petrie, it is not a true pyramid at all, but a mastaba enlarged by successive additions into the pyramidal shape. The slope of the sides (about 75°) differs considerably from that of the true pyramids. Near it is the pyramid of Unas, the last King of the Fifth Dynasty, and in the vicinity are the pyramids of the Pharaohs Teta, Pepi I., Mer-en-rê, and Pepi II. of the Sixth Dynasty. These pyramids were opened in 1881, and the walls of their chambers were found to be covered with long religious texts.

South of Saqqâra are the pyramids of Dahshûr, which are in a simple and massive style much like those of Ghizeh. The group consists of two large and two smaller pyramids of stone, and two of mud bricks, the latter being usually known as the 'black pyramids.' The more northerly of the two brick pyramids, which formerly had a casing of stone, is the tomb of Usertesen III. of the Twelfth Dynasty. Its present height is 90 feet. To the southwest of it is a large stone pyramid 326 feet high and 702 feet in width. To the south and east are the remains of other pyramids, and still farther to the south is a pyramid of peculiar form, usually termed the 'blunted pyramid.' The lower portion slopes at an angle of $54^{\circ} 41'$, while the sides of the apex form an angle of $42^{\circ} 59'$. It is 321 feet in height and 620 feet square. The name of the builder is unknown, but it probably belongs to the oldest period of Egyptian history.

The next group of pyramids, south of Dahshûr, is the group of Lisht, of which the more southerly is the tomb of Usertesen I. of the Twelfth Dynasty. Still farther south is the pyramid of Medum (q.v.). To the west of Medum, on the edge of the Fayum, are the pyramids of Illahun and Ilawâra, the former the tomb of Usertesen II., the latter that of Amenemhat III. The pyramid of Illahun is built with a framework of stone filled up with mud bricks, while that of Ilawâra is built entirely of mud bricks, though it was doubtless originally cased over with fine stone.

Consult.: *Description de l'Égypte* (Paris, 1809-29); Lepsius, *Denkmäler* (Berlin, 1849-59); Perring, *Pyramids of Gizeh* (London, 1839-42); Vyse, *Operations Carried on at the Pyramids of Gizeh in 1837* (London, 1840-42); Smyth, *Life and Work at the Great Pyramid* (London, 1867); Petrie, *Pyramids and Temples of Gizeh* (London, 1883); *Hawâra* (London, 1889); *Kahun* (London, 1890); *Illahun* (London, 1891); *Medum* (London, 1892); Baedeker, *Ägypten* (4th ed., Leipzig, 1897).

PYRAMUS (Lat., from Gk. *πύραμος*) AND **THISBE**, *this'be* (Lat., from Gk. *Θισβή*). Two lovers whose tragical history is told by Ovid in the fourth book of his *Metamorphoses*. They were natives of Babylon and immediate neighbors. But though tenderly attached to each other, their parents would not consent to their marriage, and they were obliged to content themselves with stolen interviews through an opening in the wall between their gardens. On one occasion they

arranged to meet at the tomb of Ninus, where Thisbe, who was first at the trysting-spot, was startled by a lioness. She fled, leaving her veil behind, which the fierce animal tore and covered with blood. Soon after Pyramus appeared, and, seeing the bloody veil, believed his mistress had been murdered, whereupon he killed himself. Thisbe now returned, and, beholding her lover lying dead on the ground, put an end to her own life.

PYRARGYRITE (from Gk. πῦρ, *pyr*, fire + ἀργυρος, *argyros*, silver). A silver-antimony sulphide that crystallizes in the hexagonal system, has a metallic lustre, and is dark red or black in color. It occurs with arsenic, lead, and silver ores in the Harz, Saxony, Bohemia, Hungary, Spain, and Cornwall, England; also in Mexico and South America. In the United States it is found with silver ores in Colorado, New Mexico, Arizona, Utah, and Nevada, and when found in quantity is a valuable silver ore.

PYRENEES, pir'é-néz. A high mountain chain of Europe extending from the southeast corner of the Bay of Biscay to the Mediterranean. The Cantabrian Mountains of the north coast of Spain are a continuation of the Pyrenees, so that the entire mountain system extends from Cape Creus in the Mediterranean to Cape Toriñana on the northwest coast of Spain, a distance of 630 miles; but the name Pyrenees is applied only to that part of the system which forms the boundary between France and Spain, and which has an east and west extension of about 280 miles. The mountains, with an area of over 20,000 square miles, form the water parting between the rivers of France and Spain, and are an effective barrier between the two countries. Unlike the Alps, which have a number of passes practicable for wagon roads, the Pyrenees are a true sierra whose saw-like ridges are notched only a little below the level of the peaks, so that the few passes are not practicable for wagons. The highways that start as roads merge into mule paths and are valueless for commerce. The two railroads between France and Spain cross the low coastal strips at the extremities of the mountains, and are thus greatly deflected from direct routes, so that most of the commerce between the two countries is carried by sea. Thus while the Alps oppose no great obstacle to commerce, the Pyrenees are a barrier to it.

The Pyrenees were upheaved above the sea during the latter part of the Eocene epoch, when a large part of Europe was buried under the ocean. Granite forms the kernel of the mountain system, and is overlaid by masses of chalk and sandstone. The culmination of the mountains is only 11,168 feet above sea level; and, owing to the far extending southern slope which falls gently to the plain of Spain, the mean height of the mountain mass is only about 3500 feet.

Contrary to earlier opinion, the mountains do not form a continuous chain or two chains, as has often been asserted, between the Atlantic and the Mediterranean. The later investigations of the French Alpine Club modify this view. The surveys, especially on the Spanish side, seem to show that no continuous line forms the culminating portion of the Pyrenees, but that this backbone of the mountains is a series of broken chains which do not coincide with the water parting between France and Spain, but cross this divide obliquely. Some of these broken chains extend from northwest to southeast, and

others intersect them from southwest to northeast, so that by alternately digressing from one of these directions to the other the irregular crest of the Pyrenees acquires its general direction, which from the Atlantic to the Mediterranean is 9° south of due east.

The northern slopes of the Pyrenees are shorter and much steeper than those on the southern or Spanish side. Few mountain chains exhibit a more regular succession of increasing altitudes than the Pyrenees summits from the Atlantic to and through the Central or High Pyrenees. In the west near the ocean the summits are only 2000 to 3000 feet high. Farther east the peaks become more and more alpine till the Pic du Midi d'Ossau (9465 feet) is seen rising above all its western neighbors. The central regions of the mountains, extending about 150 miles, are next reached, and the Pic d'Enfer (10,109), Balaitous (10,318), Vignemale (10,820), Mont Perdu (10,994), Pic des Posets (11,047), and Maladetta, or the Pic d'Anethou (11,168), rapidly succeed one another, all in the region of the High Pyrenees. The mountains to the east of the culminating summits are abruptly reduced in elevation, and only two, Montcalm and Pic d'Estats, approach the height of the Central or High Pyrenees. The Eastern Pyrenees in their three high summits (Pic Carlitte, Puigmal, and Canigou) and the High Pyrenees rise into the region of permanent snow. The snow line is nearly 1000 feet higher than in the Alps, while the general level of the mountains is considerably lower. Most of the highest summits are on the boundary crest, but the culminating point of the Maladetta is in Spain. The extent of the snow fields and glaciers is therefore insignificant as compared with that of the Alps. The entire area of glaciers is estimated at 13 square miles, the largest glaciers being on the Maladetta (1760 acres) and on the Mont Perdu group (1472 acres). Under these circumstances the mountain climber gives much less attention to weather and snow conditions than in Switzerland. While the Pyrenees have great beauty and grandeur, they have not vied with the Alps as a field for climbers. This is partly explained by the fact that most tourists prefer mountains which may be easily reached from comfortable hotels with highly skilled and painstaking mountain guides. One of their most attractive spots, easily reached from several French resorts, is the Cirque de Gavarnie. Along the northern slope of the Pyrenees are a number of famous watering-places, including Bagnères-de-Bigorre and Bagnères-de-Luchon. The little Republic of Andorra (q.v.) lies among the Eastern Pyrenees on the southern slope. The two most famous passes of the Pyrenean range are the Col de Portus or Perthus (traversed by Hannibal), in the east, and the pass of Roneesvalles, in the west.

BIBLIOGRAPHY. Cenac-Moncaut, *Histoire des Pyrénées* (5 vols., Paris, 1853-55); Perret, *Les Pyrénées françaises* (Paris, 1881-84); Bois and Durier, *Les Hautes-Pyrénées* (Orleans, 1884); Baring-Gould, *In Troubadour Land* (New York, 1897); Hugo, *The Alps and Pyrenees* (London, 1898); Curzon, "Une bibliographie de l'alpinisme pyrénéen," in *Bibliographie Moderne*, vol. iv. (Paris, 1900).

PYRÉNÉES, pé'rá'ná', BASSES. A southwestern department of France. See BASSES-PYRÉNÉES.

PYRÉNÉES, HAUTES. A southwestern frontier department of France. See HAUTES-PYRÉNÉES.

PYRENEES, PEACE OF THE. A treaty of peace concluded between France and Spain, November 7, 1659, on an island in the Bidassoa River. It brought to an end the struggle between the two powers, which with intervals of peace had continued since the beginning of the sixteenth century, when Louis XII. of France and Ferdinand the Catholic entered into the contest for supremacy in Italy. Spain ceded to France most of Artois, and parts of Flanders, Hainault, and Luxemburg; in the south it surrendered Roussillon and a part of Cerdagne, thus making the Pyrenees the boundaries between the two countries. The Infanta Maria Theresa was promised in marriage to the young Louis XIV. (q.v.).

PYRÉNÉES-ORIENTALES, pé'rá'ná' zó'rè-án'tál'. A southern maritime department of France (q.v.), bounded on the east by the Mediterranean, and on the south by the Pyrenees (Map: France, J 9). Area, 1592 square miles. The department presents a series of three parallel valleys formed by spurs from the Pyrenees, which run east and west, and are watered by the Agly, the Tet (the principal river), and the Tech. The southwest corner is drained by the Sègre (Segura), a tributary of the Ebro. An extensive plain occupies all the north and east of the department. The climate is equable. The vegetable products include fine grain and some of the choicest fruits. Wines constitute the wealth of the district, and include the red wines of Roussillon and the white muscadel of Rivesaltes. The chief exports are wine, cocoons, live stock, and animal products, anchovies, etc. Capital, Perpignan (q.v.). Population, in 1896, 208,387; in 1901, 212,121. Consult Companyo, *Histoire naturelle du département des Pyrénées-Orientales* (Perpignan, 1862-64).

PYRÉNOID (from Gk. *πυρήν*, *pyrēn*, stone of a fruit + *εἶδος*, *eidos*, form). A differentiated portion of a chromoplast (q.v.) of proteid nature, which, since starch grains are usually formed around it, is sometimes called an amyllum body. It is regarded as a food reserve.

PYRETHRUM, pí'rēth-rím. See INSECT POWDER and Colored Plate of CHRYSANTHEMUMS.

PYR'GOS. A town of Greece, capital of the Nomarchy of Elis. It is situated near the west coast of the Morea, 40 miles southwest of Patras, in a fertile region producing great quantities of currants, grapes, and oranges (Map: Greece, C 4). These products are exported through the port of Katakolon, with which the town is connected by a short railroad. Railroads also run to Patras and to the ruins of Olympia. Population, in 1896, 12,708.

PYRHELIOMETER (from Gk. *πῦρ*, *pyr*, fire + *ἥλιος*, *hēlios*, sun + *μέτρον*, *metron*, measure). The name given by Pouillet to an instrument devised by him for the purpose of measuring the amount of heat received from the sun in a unit of time by a unit surface. This quantity is sometimes called the 'solar thermal constant,' and all apparatus expressly designed to measure the intensity of radiant heat may properly be called pyrheimeters; but, owing to the progress in our views with regard to the effects of solar radiation, it is not now generally recognized that

the latter may produce either thermal, optical, or chemical effects, according to the nature of the substance upon which it falls, so that the pyrheiliometer is really a special form of actinometer (q.v.) or radiometer. Pouillet's instrument, devised in 1837, "consists of a thermometer whose bulb is inclosed in a thin flat metallic box filled with water. The upper surface of the box carefully blackened is placed perpendicularly to the rays of the sun. The heating of the thermometer during five minutes' exposure to the solar action is noted, and also its cooling during five minutes when the sunlight is cut off by a screen. The elevation of temperature produced by the heat of the sun in five minutes, corrected for the effect of cooling or warming when the sun's rays are cut off, is to be divided by the mass of the water in the apparatus and the area of the surface; this gives the quantity of heat expressed in calories as received by a unit surface in a unit time." In 1885 Professor Knut Angstrom devised his differential pyrheiliometer, composed of two identical disks of copper, each carrying a thermo-electric junction and exposed alternately to the action of the sun, a galvanometer placed in the circuit of the two junctions measuring their difference of temperature; and in 1893 he brought out his compensating pyrheiliometer. "Two thin strips of blackened metal identical in every way are placed side by side. One of these is exposed to the rays of the sun, while the other is kept in the shade; the latter is warmed up by an electric current until its temperature is identical with that of the strip that is warmed by the sunshine. This exact equality is shown by the fact that at this moment no thermal electric current passes between the two strips. Therefore at this moment the thermal effect of the solar radiation per unit of time is equal to that of the electric current. The intensity of the latter can easily be measured, and from it is calculated the absolute intensity of the solar radiation. A complete observation consists in making each of the two blackened strips become successively the exposed and the unexposed calorimetric body." In 1893 Chwolson constructed a pyrheiliometer consisting essentially of two thin plates gilded on the back and blackened in front, alternately exposed to and shielded from sunshine, and whose differences of temperature can be measured many times in rapid succession by thermo-electric methods. Chwolson's apparatus has been adopted by the Russian meteorological service, while Angstrom's apparatus has commended itself to the Weather Bureau of the United States. Crova's mercury pyrheiliometer consists of a mercurial thermometer bulb carefully blackened and receiving the solar rays through a narrow aperture of known area. The bulb is alternately shaded and exposed several times in succession and the differences between the readings give the correct effect of the sunshine. When the bulb has been properly calibrated and its water equivalent is known, its changes of temperature can be converted into calories and the instrument becomes an absolute actinometer. The results of the best work that has been done with pyrheiliometers give for the value of the solar thermal constant at the mean distance of the earth from the sun 4.0 calories per minute per square centimeter, but in general all such figures are affected by our ignorance of the absorption by the earth's atmosphere. A

very complete review of pyrheiliometers is given in the report on radiation by Jules Violle, published in the report of the meeting at Saint Petersburg, 1899, of the International Meteorological Committee.

PYRIDINE, C_5H_5N . A powerful basic compound of carbon, hydrogen, and nitrogen. It is usually prepared on a commercial scale from coal-tar; it combines with the sulphuric acid used in purifying the coal-tar hydrocarbons, and when the acid is neutralized with soda, a mixture of pyridine and several other bases (notably quinoline) separates out in the free state; from this mixture pyridine is isolated by fractional distillation, and it may then be obtained pure by transforming it into one of its salts and purifying the latter by repeated crystallizations. Pure pyridine is a colorless liquid that boils at $115^\circ C.$ ($239^\circ F.$) and may be readily identified by its peculiar odor. The derivatives of pyridine include many of the alkaloids (q.v.); nicotine, for example, is closely allied to it, and when subjected to a process of oxidation yields nicotinic acid, $C_6H_7N_2COOH$, a compound evidently derived from pyridine by substituting a carboxyl group ($COOH$) for one of its hydrogen atoms. Another important derivative of pyridine is *piperidine*, $C_5H_{10}NH$, a colorless, powerfully basic liquid that boils at $106^\circ C.$ ($222.8^\circ F.$) and may be identified by its pepper-like odor. Piperidine may be obtained, on the one hand, from pyridine, by the action of nascent hydrogen; on the other hand, it may be prepared from the alkaloid piperine, a characteristic constituent of pepper, by the action of caustic potash. The chemical constitution of pyridine and of piperidine is represented, respectively, by the following graphic formulas:

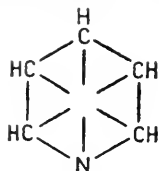

Pyridine.

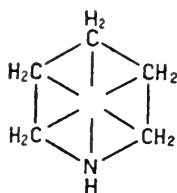

Piperidine.

PYRITE (Lat. *pyrites*, from Gk. *πυρρης*, flint, millstone, relating to fire, from *πῦρ*, *pyr.* fire). An iron disulphide (FeS_2) that crystallizes in the isometric system, has a metallic lustre, and is of a brass-yellow color. It is widely disseminated, occurring in rocks of all kinds and of all ages, sometimes in the form of grains disseminated throughout the mass of a rock or along the line of contact between basic eruptives and sedimentaries; as irregular and sporadic and concretionary masses in sedimentary rocks and modern sands and gravels; in the form of true fissure veins; and as interbedded, often lenticular masses, sometimes of immense size, lying conformably with the stratification of the inclosed rock. The origin of the mineral in the older crystalline rocks is frequently somewhat obscure, but in sedimentary rocks it is regarded as due to the precipitation of the included ferruginous matter by sulphureted and deoxidizing solutions produced by decomposing animal and vegetable matter. When found on the surface the mineral is often considerably altered by oxidation and hydration, forming limonite. Py-

rite is found in many localities, including Freiberg, Saxony; Píbram, Bohemia, Schemnitz, Hungary; Langban, Sweden; Kongsberg, Norway; Cornwall and Derbyshire, England; and Peru. In the United States numerous localities where large crystals occur are known in Maine, New Hampshire, Vermont, Connecticut, New York, Pennsylvania, Virginia, North Carolina, Colorado, and California. The amount produced in the United States in 1901 was 234,825 long tons, valued at \$1,024,449. The mineral finds its principal use in the manufacture of sulphuric acid and ferrous sulphate (green vitriol). Small quantities are used in the manufacture of vermilion paints, and some varieties are cut into squares, ovals, and other shapes for use as settings for rings, scarf pins, trinkets, etc. Owing to its yellow color, pyrite has been frequently called *fool's gold*, and many stories are told of the disappointment of miners, who, thinking they had found a fortune, were undeceived only when the mineral was submitted to experts.

The name *pyrites* is applied by Dana to a group of isometric sulphides and arsenides, including, besides that of iron, those of manganese, cobalt, nickel, etc.

PYRKER, pĕr'kĕr, JOHANN LADISLAUS, von Felső-Eör (1772-1847). An Austrian poet. He was born at Lángh, in Hungary, studied at Stuhlweissenburg, where he had for teachers Anyos and Virág, both classical scholars and poets in the vernacular, and, after many adventures, entered a Cistercian cloister at Lilienfeld. There he showed much executive ability and rose rapidly. He was made Archbishop of Erlau in 1827, and in this office did many good works. His poetry is ambitious epic for the most part, full of patriotism and piety. *Tunisia* (1819) told of the conquest of Tunis by Charles V.; *Rudolf von Habsburg* (1824) sang the glorious deeds of Rudolf of Hapsburg; and the *Perlen der heiligen Vorzeit* (1821), *Legenden der Heiligen* (1842), and *Bilder aus dem Leben Jesu und der Apostel* (1843) are biblical and ecclesiastical. But if his epic is flat in its attempts at Homeric simplicity, it cannot be denied that there is the true 'lyric cry' in his *Lieder der Sehnsucht nach den Alpen* (1845). Pyrker's collected works in three volumes appeared 1853-56. Consult: Sauer's critique in *Allgemeine Deutsche Biographie*, vol. xxvi., pp. 790-94).

PYRMONT, pĕr'mōnt. A small town in the the Principality of Waldeck, Western Germany, 15 miles northeast of Detmold. It is celebrated for its mineral springs, which were formerly among the most famous in Europe, and are still visited by over 18,000 patients annually. Permanent population, in 1900, 1483.

PYRMONT. A former principality of Germany, united with Waldeck (q.v.).

PYR-OLIG-NEOUS ACID. See ACETIC ACID.

PYR-OLU'SITE (from Gk. *πῦρ*, *pyr.* fire + *λοῦσις* *lousis*, bath, from *λόειν*, *loucin*, to wash). A mineral manganese dioxide that crystallizes in the orthorhombic system and has a metallic lustre and a dark iron-black or steel-gray color. Manganese oxides are believed to have been formed from the decomposition of preëxisting manganiferous silicate constituents of the older crystalline rocks and the subsequent decomposition of the oxides in secondary strata. Pyrolusite

is found in Thuringia, Moravia, Bohemia, and Transylvania; also in Australia and India, and abundantly in the United States in Vermont, Massachusetts, Connecticut, Virginia, Arkansas, and California. Pyrolusite is the common ore of manganese, and is extensively worked for that purpose, being used in the manufacture of alloys, such as ferromanganese and manganese bronze; as an oxidizing agent, as in the manufacture of chlorine and oxygen; and as a coloring material in the manufacture of glass, pottery, and paints.

PYROMANIA (Neo-Lat., from Gk. πῦρ, *pyr*, fire + μανία, *mania*, madness). A variety of periodic insanity, classed with the degenerative insanities, i.e. the insanities depending upon an hereditary or acquired constitutional condition. During certain periods the patient manifests an uncontrollable desire to commit arson, and feels relief and pleasurable sensation when watching flames. Between these attacks the patient is apparently sane, but in reality the interval is only sub-lucid. The patient is capable of attending to his affairs, perhaps, but is nervous or hysterical, and evinces morbid irritability. Attacks of pyromania are generally sudden, though sometimes preceded by brief depression. The impulse, or imperative conception, is strong and the patient obeys. The morbid impulse to incendiarism occurs not infrequently in epileptics and menstruating girls, rarely in pregnant and hysterical women, frequently in any lunatic with destructive tendencies. See **DIPSOMANIA**; **KLEPTOMANIA**; **INSANITY**.

PYROMETER (from Gk. πῦρ, *pyr*, fire + μέτρον, *metron*, measure). An instrument used for measuring high temperatures where the ordinary mercurial thermometer is not available, as mercury boils at 358° Centigrade. The first pyrometer was that invented by the Dutch physicist Musschenbroek, about 1725, and consisted of a metallic bar which expanded under the influence of heat. Wedgwood's pyrometer, which was devised about 1780, employed cylinders of fire-clay which were exposed to a high temperature and then allowed to cool. The degree of heat was ascertained by measuring the amount of contraction in length experienced by the clay. This method, however, was found unreliable, and the apparatus invented in 1821 by Daniell formed the first really serviceable pyrometer. Here the temperature was measured by the relative expansion of a bar of metal such as iron or platinum contained in a tube of black-lead earthenware. The metal rod was in contact with a lever which moved an indicator over a graduated scale. This instrument was subsequently improved by the substitution of graphite for the platinum rod, and could be used for the measurement of temperature as high as 1000° Centigrade. Numerous other pyrometers have been devised depending on the property possessed by metals expanding with an increase in temperature, but the most accurate instrument is the air thermometer (q.v.), which is the ultimate standard of reference in all high-temperature measurements. It is usually constructed with a bulb of porcelain or platinum containing either air or hydrogen, and the expansion of the gas under the influence of heat increases its pressure and raises the level of a column of mercury. As the pressure of a gas is proportional to its temperature, it follows that by determining the height of the mercury column supported by the air at

the different temperatures, a determination can be made with considerable accuracy, though there are numerous practical difficulties necessitating an experienced observer. A form of pyrometer much used is that invented by Dr. C. W. Siemens, in which the temperature is measured by the increase in the electrical resistance of platinum wire exposed to the heat. This wire is wound on a cylinder of refractory fire-clay inclosed in a shield of platinum wire, which can be determined easily and quickly with a galvanometer and resistance coils by the application of the Wheatstone bridge method. The platinum thermometer, now made in many forms, can be standardized by direct comparison with an air thermometer, and a reference table constructed enabling an observer to ascertain readily the temperature of a furnace or substance with a high degree of accuracy. The pyrometer which is considered the most useful for extremely high temperatures is that used by Le Chatelier, and may be taken as typical of those making use of the thermo-couple. This instrument consists essentially of two pieces of wire of but slightly different composition, which are inclosed in a long tube of porcelain or fire-clay. These wires are platinum and an alloy of 90 per cent. platinum and 10 per cent. of the rare metal rhodium, and the current produced at an increase in temperature is measured by a galvanometer. The instrument measures readily and accurately temperatures in the neighborhood of 1200° Centigrade. To Le Chatelier is also due a photometric method of determining high temperatures by measuring the intensity of the light emitted by a glowing metal. The spectroscope can also be used to measure high temperatures as well as the calorimeter, in which case the temperature of a given piece of metal whose specific heat is known is determined by noting the increase in temperature of a mass of water in which it is immediately placed upon removal from the furnace. This principle is employed in a number of instruments, but it does not afford especially accurate results, as the specific heat of metals is different at different temperatures. The thermo-couple and the platinum are on the whole the most useful forms of pyrometers, as they can be used over an extended range of temperature, from that of liquid air in hydrogen almost to the melting point of platinum, and readings can be made without undue difficulties either of manipulation or of calculation. Consult: Preston, *Theory of Heat* (New York, 1894); Barus, "Thermo-Electric Measurement of High Temperatures," *Bulletin 54 United States Geological Survey*; id., *Report on High Temperature Measurements, International Congress of Physicists* (Paris, 1901).

PYROMORPHITE (from Gk. πῦρ, *pyr*, fire + μορφή, *morphē*, form). A mineral lead phosphate and chloride that crystallizes in the hexagonal system, has a resinous lustre, and in color is of various shades of green, yellow, and brown. It occurs with lead ores, usually in veins. The principal localities where it is found are in Saxony, Bohemia, Nassau, Siberia, Derbyshire and Cumberland, England; and in the United States in Maine, Massachusetts, New York, Phenixville, Pa., and Davidson County, N. C.

PYROPE, πῦρ (from Gk. πυρρός, *pyrros*, sort of red bronze, fire-eyed, from πῦρ, *pyr*, fire + ὤψ, *ops*, eye). A name applied to the magne-

sium-aluminum garnet, commonly called 'the precious garnet.' (See GARNET.) It is usually deep red to black in color, and if it is also transparent, as it often is, it is valued as a gem. The principal localities where the gem varieties occur are different places in Bohemia, Saxony, and at Kimberley, South Africa; also at Elic, in Fife, Scotland, where they are popularly called 'Elic rubies.' This gem is often called *carbuncle* and *hyacinth* by lapidaries.

PYROPHORUS (Neo-Lat., from Gk. *πυροφόρος*, fire-bearing, from *πῦρ*, *pyr*, fire + *-φόρος*, *-phoros*, bearing, from *φέρειν*, *pherein*, to bear). Any solid substance which is capable of taking fire on exposure to the air at ordinary or but slightly elevated temperatures. This property is possessed chiefly by finely divided solid bodies, such as metallic iron reduced from the oxide by ignition in hydrogen. The spontaneous inflammability in such cases is explained by the capacity of the powders for rapidly condensing air within their pores, thereby causing a considerable rise of temperature, while at the same time they present a large surface to the action of oxygen. The substances possessing this property include numerous salts, such as lead citrate or tartrate, which after ignition in a glass tube until gaseous matter is no longer evolved, and then being left to cool, take fire instantly on being thrown out into the air. 'Homborg's pyrophorus' is obtained by heating alum with lampblack or similar carbonaceous matter.

PYROPHOSPHORIC ACID. See PHOSPHORIC ACID.

PYROPH'YLLITE (from Gk. *πῦρ*, *pyr*, fire + *φύλλον*, *phyllon*, leaf). A hydrous aluminum silicate that is believed to crystallize in the monoclinic system, although it is not usually found in distinct crystals. It has a pearly lustre, and in color ranges from white, through various shades of yellow, to green. It has a soapy or greasy feeling that suggests its similarity to various forms of tale, which it closely resembles. It occurs in some of the older rocks, and is found in the Urals, Sweden, Brazil, and in the United States in North Carolina, Georgia, and Arkansas. It is used for the manufacture of slate pencils, the variety employed for this purpose being known as 'pencil stone.' It is further used for making tailors' chalk ('French chalk'). The compact varieties, which are known as *agalmatolite*, or *pinite*, have been extensively used by the Chinese and Japanese in the manufacture of small images and objects of art.

PYRO'SIS (Neo-Lat., from Gk. *πύρωσις*, a burning, from *πυρῶν*, *pyroun*, to burn, from *πῦρ*, *pyr*, fire), or WATERBRASH. A symptom of certain forms of indigestion in which there occurs at intervals a regurgitation of a considerable quantity of a watery acrid or acid fluid, generally accompanied by a burning sensation in the epigastrium, frequently extending up behind the sternum to the throat. In common parlance the regurgitation is called 'waterbrash,' and the sensation 'heartburn.' See INDIGESTION; DYSPEPSIA.

PYROSO'MA. A compound, pelagic, luminous tunicate. See ASCIDIAN; LUMINOSITY OF ANIMALS.

PYROTECHNY, *pīr'ō-tēk'nī* (from Gk. *πῦρ*, *pyr*, fire + *τέχνη*, *technē*, art). The art of making fireworks. The origin of pyrotechny is un-

known, but the art was early practiced in the East and has attained to the highest degree of perfection among the Chinese and Japanese. Although inflammable compositions, known as Greek fire, were used in European warfare before gunpowder had become known among the Western nations, fireworks, as now denominated, became known to them about the middle of the fourteenth century, and we find record of their having been used as an accessory of public pageantry in 1588. The early development of fireworks in Europe was due to the Florentines, and the Italians long retained their supremacy in this field, since the popularity of pyrotechnic exhibitions was greatly increased during the eighteenth and the early part of the nineteenth century through the ingenuity of the famous Italians Ruggieri, father and son, who charmed Rome and Paris by their displays.

The prime materials employed in the manufacture of fireworks are gunpowder, or its constituents, charcoal, sulphur, and saltpetre, or other oxidizing salts; metals and metallic salts which on burning give rise to various shaped sparks, or a brilliant light, or which impart color to the flame; touch-paper and fuze or quick-match, by which the charges are ignited and inflamed; paper and wood from which to construct the cases and sticks; and resin, camphor, lycopodium, soaps, gum, lampblack, and similar bodies with which to modify the character of the reaction. In the use of gunpowder three effects are produced—heat, light, and sound. To produce reports, as with crackers, the gunpowder is used in the granulated condition and strongly confined in the rolled paper envelope which it is to rupture. When, on the other hand, the gunpowder is first reduced to dust and then compacted by pressure in a case, with an open end when burning, as in a rocket or a pinwheel, it may burn with the evolution of light and heat and the production of gases which cause the rocket to rise or the pinwheel to revolve, but without a report.

ROMAN CANDLES. In the Roman candle we have the stars or balls, made up of gunpowder ingredients mixed with color or light-giving materials compacted into hard masses by the aid of gum or shellac, resting on loosely confined layers of granulated gunpowder, interspersed between well-compacted masses of slow-burning composition, all enclosed in a stout paper or cardboard case. The stars are hollow and provided with a piece of quick-match by which they are ignited. The end of the case is primed with powder and capped with touch paper. When the latter is ignited the priming powder is inflamed and this sets fire to the composition, or 'dark fire' as it is technically called, which slowly burns with the production of flame and sparks until the star is reached, when the grained gunpowder upon which it rests is ignited, burns rapidly, and expels the star with a loud report. Great care must be exercised in loading the cases of Roman candles, since a smaller charge of powder is necessary to propel a star to a given height the deeper the star is inserted in the case, and it is desired that the stars shall all be thrust out with equal force so as to describe the same path.

ROCKETS consist of a cylindrical paper or

cardboard body, or *fusee*, filled with propelling composition, to the upper end of which is attached a shorter and wider paper tube called the *pot*, which contains the *garniture*, or material that produces the brilliant clusters of golden, ruby, emerald, or sapphire-like stars, or showers of golden or colored rain, or of fiery serpents, which appear when the rocket has risen to a great height. The pinched upper end of the *pot* is covered with a conical cap, which by cleaving the air assists the rocket in its flight, and the whole is attached to the end of a stick which guides the rocket in its flight. When a rocket is stuck into the ground; or better, the rocket is placed in an inclined wooden trough and the touch paper at the base of the fusee which communicates with the priming in the centre of the fusee is lighted. The garniture is ignited by the flame which flashes through a hole in the clay plug at the top of the fusee as the rocket reaches its greatest altitude.

PINWHEELS and other revolving pieces are constructed by coiling the paper case, when not too tightly filled with composition, about a flat wooden block or frame which in use is attached to a tree or board by a nail upon which it may freely revolve, the revolution being determined by the pressure of the gas evolved as the composition burns.

TOUCH PAPER consists of a thin, rather tough paper which has been sponged with a weak solution of saltpetre until saturated and then dried.

QUICK-MATCH consists of cotton wick which has been saturated with a weak solution of saltpetre, then coated with a thick paste of gunpowder and gum, spread evenly over it, and then dried.

COLORÉD FIRE. In producing light and color, there is added to the gunpowder composition steel filings for brilliant fire or cast-iron filings for Chinese fire. Copper filings give a greenish tint to flame; zinc filings a fine blue color; powdered magnesium a dazzling white light; amber, colophony, or common salt affords yellow fire. Lampblack produces a very red color with gunpowder, and a pink with nitre in excess, and it serves for making golden showers. Yellow sand or glistening mica communicates to fireworks golden radiations. Verdigris imparts a pale green; sulphate of copper and sal ammoniac a palm-tree green; barium salts a grass green; strontium salts crimson; calcium salts orange. Potassium picrate on burning produces a whistling sound and has recently been introduced for use in whistling bombs and rockets. Camphor yields a very white flame and aromatic fumes. Lycopodium burns with a rose color and a magnificent flame. The published recipes and formulas for the manufacture of the materials used in fireworks are very numerous, while each manufacturer has his special mixtures and methods of treatment. For example, *yellow stars* and *yellow showers* are made of nitre 16 parts, sulphur 10, charcoal 4, gunpowder 16, and lampblack 2, all being finely ground and intimately mixed. A deeper and richer golden color is produced by using 2 parts less of sulphur and of charcoal respectively and 4 parts more of gunpowder in the mixture. To produce stars either of the above mixtures is moistened with gum water, rolled into a sheet and cut into cubes which are then dried. For *red* mixture for colored fires potassium chlorate

29.7 parts, sulphur 17.2, charcoal 1.7, strontium nitrate 45.7, black antimony sulphide 5.7. For *green*, potassium chlorate 32.7 parts, sulphur 9.8, charcoal 5.2, barium nitrate 52.3. For *blue*, potassium chlorate 54.5 parts, charcoal 18.1, ammoniacal copper sulphate 27.4. For *white*, sulphur 20 parts, saltpetre 60, black antimony sulphide 5, flour gunpowder 15.

All fireworks mixtures and compositions should be handled with extreme care. All friction should be avoided, especially while the ingredients are being mixed. Compositions containing chlorates, and particularly chlorates and sulphur, are especially sensitive to friction and percussion, and furthermore are liable to explode spontaneously. The sensitiveness of such mixtures may be noted in the *toy torpedo* or *throw-down*, in which a very small amount of the mixture, mingled with gravel to give the device weight, are enveloped in tissue paper. Owing to frequent accidents to person and property, through explosions and fire, arising from the use of *firecrackers*, and especially the larger sizes known as *cannon crackers*, *giant crackers*, and *dynamite crackers*, a straw-board cracker containing a chamber filled with compressed air has recently been invented as a substitute. *Greck fire* (q.v.) is supposed by some to have been composed of asphaltum, nitre, and sulphur, by others to have had approximately the composition of gunpowder. A modern composition known by this name consists of a solution of phosphorus in carbon disulphide with or without sulphur, potassium chlorate, and mineral oil. Rockets, known as *Congre rockets*, carrying explosive shells and incendiary compositions in the pot, were used in the siege of Boulogne in 1806 and in the British war with the Burmese. *Bengal lights* are used as distress signals at sea, while *Roman candles*, or similar devices throwing colored stars, are used, with a telegraphic code, for over-water communication. In 1900 there were produced in the United States \$1,785,271 worth of fireworks, nearly one-half of the total amount being produced in the State of New York.

BIBLIOGRAPHY. The literature of pyrotechny contains the following works, whose scope is indicated by their titles: Babington, *Pyrotechnia, or a Discourse of Artificial Fireworks* (London, 1635); d'Orval, *Traité des feux d'artifice pour le spectacle et pour la guerre* (Bern, 1750); Ruggieri, *Pyrotechnie militaire* (Paris, 1812); Cutbush, *A System of Pyrotechny* (Philadelphia, 1825); Chertier, *Nouvelles recherches sur les feux d'artifice* (Paris, 1843); Tessier, *Chimie pyrotechnique* (Paris, 1859); Browne, *The Art of Pyrotechny* (London, 1879); Cesare Sonzogno, *Il pirotecnico moderno* (Milan, 1892). See EXPLOSIVES; GREEK FIRE; GUNPOWDER; SIGNALING AND TELEGRAPHY, MILITARY; SIGNALS, NAVAL.

PYR'OXENE (from Gk. πῦρ, *pyr*, fire + ξένος, *xenos*, guest), or AUGITE. A name applied to a group of mineral metasilicates, of which the mineral pyroxene is the type. The latter is a metasilicate of calcium and magnesium, often with iron, and sometimes with manganese, and zinc, that crystallizes in the monoclinic system, and is usually found in prismatic crystals, although sometimes granular, coarse or fine. According to its composition the species is divided by Dana into the following sub-species: *Diopside*,

called also malacolite, or alalite, a calcium-magnesium pyroxene, whose color varies from pure white and yellowish or grayish white to green; *hedenbergite*, a calcium-iron pyroxene of a black color; *schefferite*, a manganese pyroxene sometimes containing iron, of a brownish color; and *augite*, an aluminum pyroxene sometimes containing small quantities of the alkalis, of a black color. These varieties are common minerals, and are found in crystallized limestone and dolomite, and frequently in the older rocks. Pyroxene is an essential constituent of many igneous or eruptive rocks, and with labradorite or anorthite and magnetite it forms basalt. Certain varieties, as diopside, have been obtained as furnace products at iron works. Artificial crystals of diopside have been obtained by the action of silicon chloride on magnesia.

PYROXENITE (from Gk. πῦρ, *pyr*, fire + ξένος, *xenos*, guest). An igneous rock of ultrabasic composition free from feldspar, and chiefly composed of one or more varieties of pyroxene or amphibole, and sometimes magnetite or ilmenite. The average chemical composition of pyroxenite is: Silica, 53 per cent.; alumina, 4 per cent.; sesquioxide of iron, 2 per cent.; protoxide of iron, 7 per cent.; oxide of lime, 13 per cent.; magnesia, 21 per cent.; oxides of the alkalis, 1 per cent. Pyroxenites easily suffer alteration from weathering, the principal products being talc (soapstone) and serpentine. They are closely allied to the peridotites (q.v.).

PYROXYLIC SPIRIT. See METHYL ALCOHOL.

PYROXYLIN. A name for guncotton (q.v.).

PYRRHIC DANCE (Gk. ἡ Πυρρική, *hē Pyrrhikē*). The oldest and most famous of the ancient Greek war dances. As to its origin and name accounts varied, some attributing it to a Cretan or Spartan named Pyrrhichos, others to Pyrrhos, son of Achilles, others to the Dioscuri or Curetes. The Cretan name is said to have been πρῶτος, *prytis*. There can be little doubt that the dance originated among the Dorians of Crete or Laconia, and it was especially cultivated by the Spartans as valuable training for the soldier. It seems to have been presented by a chorus of armed youths, who divided into two bands and represented in pantomime attack and defense, including the feints and parries needed in individual contest. It was also danced as a solo, and sometimes by women, as is clear from Xenophon's account in the *Anabasis* and the testimony of the vases. At Athens it was cultivated by the Ephebi, and danced in the competitions of the Panathenæa. In later times a Bacchic element was introduced and we are told the adventures of Dionysus were depicted. In Rome it was very popular as a pantomimic spectacle. The time of the music is said to have been rapid, and in Greek metre two short syllables (~ ~) are known as a Pyrrhic foot. This, however, occurs rarely, and is always to be measured as containing three metrical units, the smallest number which can form a foot.

PYRRHIC VICTORY. A phrase denoting a success won at a ruinous cost, referring to the battle of Aesulum, in which Pyrrhus gained the victory over the Romans with such heavy losses that he is said to have exclaimed, "Another such victory, and Pyrrhus is destroyed."

PYRRHO, πῦρρῶ (Lat., from Gk. Πύρρων, *Pyrrhon* (c. 365-c.275 B.C.). A Greek philosopher born in Elis; the founder of the Skeptical School of philosophy. He was a painter in his youth, but later was attracted to philosophy by the works of Democritus and became the pupil of Bryson, a disciple of Stilpo. Afterwards he attached himself to Anaxarchus, and with him accompanied Alexander the Great on his expedition to the East, where, according to Diogenes Laertius, he became acquainted with the teachings of the Persian Magi and the Indian Gymnosophists. During much of his long life he lived in retirement. He was so highly esteemed by his fellow-citizens that they made him their chief priest and honored him with a statue after his death; the Athenians gave him the rights of citizenship. As Pyrrho left no writings, little is certainly known of his doctrine; the chief source of information is the work of his follower, Timon the Sillographer. The main principle of his teaching seems to have been that to attain the highest good, happiness, we must know the nature of things and the relation we should bear to them. But since we know things only as they seem to us, their real nature cannot be definitely apprehended, and hence objective knowledge is impossible of attainment. Therefore the correct attitude for the philosopher is complete suspense of judgment, and in this lies freedom from trouble and peace, which is man's chief good. Consult: Waddington, *Pyrrhon et le Pyrrhonisme* (Paris, 1877); Zeller, *Philosophie der Griechen*, vol. iii. (3d ed., Leipzig, 1880); Ueberweg, *History of Philosophy*, Eng. trans., vol. i. (New York, 1872); Erdmann, *History of Philosophy*, Eng. trans., vol. i. (New York, 1890).

PYRRHOTITE (from Gk. πυρρός, *pyrrhos*, reddish, from πῦρ, *pyr*, fire). A mineral iron sulphide, frequently containing nickel, that crystallizes in the hexagonal system, has a metallic lustre, and in color is bronze-yellow to copper-red. It occurs with magnetite and apatite, also with other sulphides in the older rocks, as well as sometimes in meteorites. This mineral is found in Norway, Sweden, Bohemia, the Harz, Saxony, England, and Brazil; while in the United States it is found in various parts of New England, New York, New Jersey, Pennsylvania, and in Tennessee.

PYRRHUS, πῦρρῦς (Lat., from Gk. Πυρρῦς) (c.318-272 B.C.). A King of Epirus, son of Æacides and Phthia, and a distant kinsman of Alexander the Great. According to one account he was a descendant of Neoptolemus (otherwise called Pyrrhus), son of Achilles. When Æacides was deposed by a faction of his people and driven from his kingdom, Pyrrhus, who was then but an infant two years of age, was rescued by some faithful attendants of the King and carried to Glaucias, King of a tribe of the Illyrians. By him he was restored to his kingdom when twelve years old, but in 302 was again driven out and took refuge with Demetrius Polioretetes. After serving in the battle of Ipsus, he went as a hostage for Demetrius to Egypt, where he married the stepdaughter of Ptolemy Soter. Thence returning to Epirus, he regained possession of his throne, and immediately directed his attention to the conquest of Macedonia. He obtained possession of the western part of that country, and, when his former friend Demetrius

became King joined a coalition with several others to drive him out. He was successful, and in B.C. 287 the kingdom was divided between Pyrrhus and Lysimachus. Pyrrhus reigned but a few months, however, and was then himself expelled in favor of Lysimachus.

In B.C. 281 the Tarentines, a Greek colony in lower Italy, then at war with the Romans, sent an embassy to Pyrrhus, in the name of all the Greek colonies in Italy, offering him the command of all their troops against their enemies. Taking up their cause, Pyrrhus in B.C. 280 arrived at Tarentum with 25,000 troops and 20 elephants. The first battle between Pyrrhus and the Romans, who were commanded by the consul, M. Valerius Laevinus, took place at the river Siris in Lucania. Only through the help of the elephants, whose strange appearance and gigantic size excited a sudden panic among the Romans, did Pyrrhus win the victory.

He now advanced into Central Italy, on his way toward Rome, but, finding the city well defended, he withdrew to Tarentum and wintered there. In the following year (B.C. 279) he was victorious at Asculum, in Apulia, but lost so heavily that, unable to follow up his victory, he withdrew to Tarentum. Having been invited by the Greeks of Sicily to assist them in their struggles with the Carthaginians and the Mamertines Pyrrhus effected a truce with Rome (B.C. 278) and crossed into Sicily. His first exploits in that island were both brilliant and successful, the Carthaginians being confined in Lilybæum and the Mamertines in Messana. Then the Sicilians began to murmur at the burdens put upon them and to treat with the enemy, and in B.C. 276 Pyrrhus left the island and returned to Tarentum. On his way he fought the Carthaginian fleet off Syracuse and the Mamertine army near Rhegium. In the following year (B.C. 275) he was completely defeated by Manius Curius Dentatus near Beneventum, and in B.C. 274 he returned to Epirus, leaving Milo with a garrison at Tarentum. In B.C. 273 he once more invaded Macedonia, over which Antigonus Gonatas was King, and established himself a second time as ruler of that country. In B.C. 272, at the request of Cleonymus, the rightful but excluded King of Sparta, he led a force into the Peloponnesus. He attacked Sparta, but was repulsed, and then withdrew to Argos, to assist Aristetas, one of the leading citizens of the place, in his rivalries with Aristippus. Here he met Antigonus of Macedonia, the champion of the opposite faction, and a fight took place in the streets of the city. Pyrrhus was thrown from his horse and stunned by a tile thrown from a house-top by the mother of the man whom he was about to kill, and was then killed by one of the soldiers of Antigonus. Consult the standard histories of Rome, and also Droysen, *Geschichte des Hellenismus* (2d ed., Gotha, 1877-78); Mahaffy, *Alexander's Empire* (New York, 1888).

PYRRUS (variant spelling of Lat. *pirus*, pear). A genus of trees and shrubs of the natural order Rosaceæ to which belong some of the most valuable fruits and ornamental trees and shrubs of temperate climates, having a five-celled fruit called a pome with a cartilaginous endocarp and two seeds in each cell. It includes species differing very much in appearance, in foliage, and in almost everything except the character of the

flower and fruit. Some botanists separate the apples (*Pyrus Malus*) as a distinct genus. See APPLE; PEAR; ROWAN TREE; BEAM TREE.

PYTHAGORAS (Lat., from Gk. Πυθαγόρας). A traditionally famous Greek philosopher and geometer, born at Samos, probably in the 49th Olympiad (B.C. 584-581). He was the son of Mnesarchus, and is said to have been the pupil of Pherecydes. He had become known in Ionia as a man of great learning when, perhaps driven from home by disgust at the tyranny of Polycrates about B.C. 530, he migrated to Magna Græcia and settled at Crotona. Here he founded an exclusive brotherhood among the aristocracy of the place. The fame of it spread abroad and attracted into its circle men and women not only from other neighboring colonies, but from all parts of South Italy. The original purpose of this brotherhood was probably not political, and yet the society became involved in the fierce struggles between the aristocracy and the democracy that were at this time raging in lower Italy; and when the popular party gained the upper hand, in its wild fury it turned upon the Pythagorean brothers and burned them in their meeting places. Only a few escaped. It is not certain whether Pythagoras himself perished in this outbreak, or whether he had previously died peacefully in Metapontum, whither he is said to have retired when the storm was gathering. Neither do we know the date of this event. Everything else pertaining to the biography of Pythagoras, found in the so-called *Lives* of Pythagoras composed by Iamblichus, Porphyry, and Diogenes Laertius, is probably mythical. He is said to have traveled from Persia to Gaul in search of wisdom, to have become initiated in Egypt into the venerable mysteries of that country, and there to have acquired mathematical lore and a belief in the transmigration of souls. Much of this may be true, but the accounts are conflicting and found in late and unreliable sources. He is even reported to have been the son of Hermes in a previous metempsychosis, and to have been permitted to bring with him into his earthly life the memory of all his past experiences. He is credited with all sorts of miraculous performances, such as appearing at two places at the same time, exhibiting to the assembled spectators at Olympia his thigh of gold, and taming wild beasts at a word of command. All this testifies to the wonder excited among his disciples by his superior knowledge and to the religious veneration in which he was held by them.

The exact character of his own personal teachings is a matter of dispute. His name is mentioned only three times in the whole Aristotelian corpus, and two of the three passages are of doubtful authenticity; in the third they are enlightened by the remark that Alcmæon flourished in the old age of Pythagoras. Both Plato and Aristotle speak frequently of Pythagoreans; they evidently knew nothing definite of the views actually promulgated by Pythagoras himself. The main reason for this ignorance is to be found in the fact that Pythagoras committed nothing to writing, and every disciple strove to gain credit for his own phase of Pythagoreanism by attributing it to the venerated master, whose *ipse dixit* carried so much weight. It is quite probable that the brotherhood founded by Pythagoras was not a philosophical coterie to which he gave learned

discourse on abstract mathematics and recondite philosophy. It was perhaps rather a religious cult in which primitive ideas of totemism and taboo were revived. We know that throughout Greece in his day there was a strong reaction against the newer national theology. The old clan and tribal deities had been long displaced by the Homeric gods, and yet these greater gods were not showing themselves able to save their devoted worshippers from the impending Persian peril. In the deep depression and gloom that settled over the Hellenic world in prospect of an Oriental invasion, it was small wonder that the older cults should be revived and eagerly cultivated in the hope that the local deities might be of service in preserving Greek civilization. This motive no doubt accounted for the rapid spread of the many Greek mysteries in the sixth century B.C.

It seems reasonable, in the light of all we know, to suppose that the early Pythagorean brotherhood was one of these mystic circles, founded with a view of purifying its members from some imaginary guilt, and accomplishing this end by the observance of taboo. Among the *akousmata*, or exoteric teachings of the later Pythagoreans, we find such prohibitions as these: not to sit on a quart measure; not to step across the beam of a balance; not to eat beans or the heart of animals; not to stir fire with iron; not to look in a mirror beside a light. Two very curious precepts enjoined the stirring of the ashes when a pot has been lifted from resting on them, so as to obliterate the marks it has made, and the smoothing of the bedclothes when one has risen from one's couch, so as to smooth out the impress of the body. All these punctilios point almost unmistakably to primitive magic. As Burnet remarks, we find in such practices, so senseless to the outsider, an explanation of the popular outburst against the society. The domination of such a religious order ruling the State must have been galling enough. "The 'rule of the saints' would be nothing to it; and we can still imagine and sympathize with the irritation felt by the plain man of those days at having all his legislation done for him by a set of incomprehensible pedants, who made a point of abstaining from beans, and would not let him beat his own dog, because they recognized in its howls the voice of a departed friend. This feeling would be aggravated by the private religious worship of the society. Greek democracies could never pardon the introduction of new gods. . . . This introduced, as it were, an unknown and incalculable element into the arrangements of the State, which might very likely be hostile to the democracy, and was in any case a standing menace to the mass of citizens, who had no means of propitiating the intruding divinity."

But although the main motive of the brotherhood was thus superstitious, there is no doubt that a certain philosophic doctrine was taught to the brethren by its learned founder. Like all the early Greek philosophies, it was probably cosmological; and it was likewise dualistic. "The two primary opposites, the Limited and the Unlimited, were brought together in a 'harmony' which could be numerically determined." (Burnet.) The Unlimited was space, the Limited were the definite forms in which space manifested itself. Space was not regarded as an abstract

entity; it was rather a material sensible thing, probably identified with air. Hence the universe was said to breathe. The unlimited air is in its essence dark; the principle of limitation is fire, the bright element which reveals definite spatial outlines. Such is the most plausible reconstruction of early Pythagoreanism as taught by its founder.

How much mathematics Pythagoras knew is likewise uncertain. To him without question is to be ascribed the first proof of the theorem known to the Egyptian 'rope-stretchers' concerning the right-angled triangle (see TRIANGLE), which they knew in the case of the triangle with sides 3, 4, 5, without giving a rigorous proof. Of other matters, what is to be ascribed to Pythagoras himself, and what to his pupils, it is difficult to decide. Therefore we generally speak of a mathematical truth as being due to the Pythagoreans, a treatment of whose discoveries, as far as known, is given in the article PYTHAGOREANISM.

Consult: Zeller, *Philosophie der Griechen* (5th ed., Leipzig, 1892; Eng. trans. of 4th ed., London, 1881); Ritter and Preller, *Historia Philosophiæ Græcæ* (7th ed., Gotha, 1888); Ueberweg, *History of Philosophy* (Eng. trans., New York, 1887); Windelband, *History of Ancient Philosophy* (Eng. trans. by Cushman, New York, 1899); Burnet, *Early Greek Philosophy* (London, 1892); Schroeder, *Pythagoras und die Inder* (Leipzig, 1884); Cantor, *Verlosungen über Geschichte der Mathematik* (ib., 1900); Gow, *Greek Mathematics* (Cambridge, 1884); Fink, *History of Mathematics* (Chicago, 1900); and for the later developments of Pythagoreanism, see that article.

PYTHAGORAS OF RHEGIUM. A famous Greek sculptor of the first half of the fifth century B.C. He is commonly called a Rhegian, but on a pedestal at Olympia bearing his signature he calls himself a Samian, and it is probable that he was one of the emigrants from Asia Minor to Magna Græcia about B.C. 496. He belongs to the period of transition from the archaic art to the great masters of the time of Phidias. He was especially celebrated for his statues of athletes and, we are told, first introduced 'symmetry and rhythm' into his works. This seems to refer to the careful adjustment of the harmony between the parts by a study of proportions and to the endeavor to secure graceful and flowing lines, removed from the stiffness and schematic treatment of the archaic school. He also was said to have been the first to render the hair, veins, and muscles in a natural manner. His importance was evidently great in the development of Greek art, but none of his works can be identified with certainty, though some gems may preserve reminiscences of his statue of the lame man, probably Philoctetes, who made the spectators feel the pain of his wound. The Choiseul-Gouffier Apollo has been thought by Waldstein to be a copy of his Olympian statue of the pugilist Euthymus of Locris, but the attribution has not been generally accepted. Consult the histories of Greek sculpture by Collignon and Gardner, and Waldstein, *Essays on the Art of Phidias* (London and New York, 1885).

PYTHAGOREANISM. The philosophical system advocated by the followers of Pythagoras. No point in Greek philosophy is more disputed than the proper interpretation of Pythagorean-

ism. According to Zeller's exposition "the Pythagorean system started from the proposition that all is, in its essence, number. From this results the doctrine of the primitive opposites; and consequently, the opposition of the odd and the even, the limited and the unlimited precede all others. The unity likewise of these opposites was sought in number alone, which was therefore defined more particularly as harmony. Many of our authorities, however, represent the matter differently. They assert that the entire system was founded on the opposition of unity and duality, which is then reduced to the opposition of spiritual and corporeal, of form and substance, of the Deity and matter, and is itself derived from the Deity as the original Unity. According to another theory, the starting point of the system was not the arithmetical conception of number and its constituents, but the geometrical conception of the limits of space and of unlimited space." A fourth opinion "bases the system not on the consideration of number, but on the distinction of the limited and unlimited."

This is not the place to canvass the arguments for and against each of these interpretations. The probability is that there was no one single consistent theory accepted by all Pythagoreans, but that each of these theories was held by some one or more of their number. The real question is not what Pythagoreans taught, but what was the earliest statement of philosophical problems given by accredited Pythagoreans. Even this question cannot be answered with assurance, as far as the fundamental principle of the system is concerned. Pythagoras himself probably gave no clear expression of philosophical opinion, because he was not so much interested in philosophical theory as in religious and moral reform. See PYTHAGORAS.

Philolaus, a contemporary of Socrates and Democritus, was probably the first distinctively philosophical Pythagorean, and although he committed his views to writing, unfortunately we have only fragments of his works, and even they are of doubtful authenticity. Nor is the witness of Plato and Aristotle to his teachings wholly unambiguous. Although the weight of Zeller's great name is given to the arithmetical interpretation of his views, it seems more satisfactory to regard Philolaus as having started from geometrical facts and the phenomena of sounds presented by the strings of the heptachord. If this hypothesis be correct Philolaus held an atomistic view of the constitution of the world. The ultimate units of reality were considered to be perceptible spatial points of material character. Two such points made a line, three made a surface, and four made a solid. By number he did not mean an abstraction, but the concrete quantum of such points. "The Pythagorean Unlimited is, in fact, the *res extensa*; it is an early attempt to conceive Space in a realistic way and not merely as the place of body. Being an early attempt, it was not very successful; and, if the Pythagoreans did not make the Unlimited a mere predicate of Air like Anaximenes, they fell into the opposite extreme of simply identifying it with Air and the Void. The Limit must, of course, be strictly correlative with the Unlimited. It will then be a spatial limit, and not an ideal one. The theory that things are numbers, then, comes simply to this, that things are built up of geometrical figures, that they are portions of

space limited in a variety of ways." (Burnet.) The smallest constituent parts of the earth were considered cubical, those of fire tetrahedral, those of water icosahedral, while those of "the fifth element which embraces all the others" were dodecahedral. But the Pythagoreans went further and gave quantitative values to things immaterial, which were thus construed in a material way. The soul was correlated in some way with the number six; reason, health, and light with seven; love, friendship, and prudence with eight. Such phantasy is the result of an attempt to reduce all reality to terms found satisfactory in explaining sensible reality. Along with this curious fiction went a mystical significance of numbers. The Pythagoreans were fond also of arranging things by opposites and finding ten such pairs. Thus one favorite classification gives us the following ten antitheses: (1) Limited and unlimited; (2) odd and even; (3) one and many; (4) right and left; (5) male and female; (6) rest and motion; (7) straight and crooked; (8) light and darkness; (9) good and evil; (10) square and rectangle.

The Pythagorean cosmology is interesting as it was a guess that came so near the truth concerning the solar system. Much of it was fanciful, but in spite of these vagaries we must recognize the fact that Pythagoreanism taught that the earth is a sphere revolving around a central fire, the centre of gravity of the universe, around which the stars likewise revolve, carried around by transparent shells. The central fire, however, was not the sun, but an invisible object, because toward it the farther side of the earth is always turned. The sun and stars shine by light reflected from this self-luminous centre. The heaven of the fixed stars, the sun, the moon, the five then known planets, and the earth made only nine objects; hence to fill out the perfect number of ten, a counter-earth was invented. Solar eclipses were due to the intervention of the earth between the central fire and the sun; lunar eclipses to the intervention of some heavenly body, sometimes the counter-sun, between the central fire and the moon. "When the earth is on the same side of the central fire as the sun, we have day; when it is on the other side, night." (Zeller.) "The distance of the spheres from the central fire was determined according to simple numerical relationships. Corresponding to this, they assumed that from the revolution of the spheres there resulted a melodious musical sound, the so-called harmony of the spheres." (Windelband.) Following Pythagoras, the Pythagoreans accepted the doctrine of metempsychosis, but the doctrine of the world soul, sometimes ascribed to the Pythagoreans, was probably not a part of their system.

The Pythagoreans laid much emphasis on music, as can be seen from their doctrine of the music of the spheres and from their insistence on the all-importance of harmony. But besides the discovery of the relation between the length of the strings of the lyre and the tones emitted, they did not contribute much to the theory of music.

While the Ionic school founded geometry, the main progress was due to the Pythagorean school in Italy. The Pythagoreans were the first to give the rigorous proofs now demanded and to use mathematics in a specialized meaning. To Pythagoras himself is due the first rigorous

proof of the proposition known by his name (Euclid I. 47; see TRIANGLE). The school was concerned chiefly with the questions 'how many' and 'how great,' i.e. with number and magnitude, and the Pythagorean geometry is mostly concerned with those relations of areas, volumes, and lines which admit of arithmetical expression. Geometry was to them a means for investigation in the theory of numbers. This is seen in the remarks concerning gnomon-numbers. Among the Pythagoreans a square out of which a corner was cut in the shape of a square was called a gnomon. The gnomon-number of the Pythagoreans is $2n + 1$, since the square on n can be made equal to the square on $n + 1$ by adding the square $1 \cdot 1$ and the two rectangles $1 \cdot n$, we then have $n^2 + 2n + 1 = (n + 1)^2$. Expressions like plane and solid numbers used for the contents of spatial magnitudes of two and three dimensions also serve to indicate the constant tendency to objectify mathematical thought by means of geometry. The knowledge of the Pythagoreans in the field of elementary series was quite comprehensive (see SERIES), and the three proportions, arithmetical, geometrical, and harmonical, were known to them. The so-called most perfect or musical proportions, e.g. $6 : 8 = 9 : 12$, was invented by the Babylonians and is said to have been first brought to Greece by Pythagoras. By improvement in definition, by systematization, and by the use of deduction, the study of geometry at the hands of the Pythagoreans was made a factor of liberal education.

PYTHAGOREAN PROPOSITION. See PYTHAGORAS; TRIANGLE.

PYTHÆAS (Lat., from Gk. Πυθαίας). A Greek navigator, born at Massilia (Marseilles) in the fourth century B.C. He is said to have sailed around the west coast of Europe, and through the English Channel to Thule, the most northern land known to the ancients, probably Mainland, the largest of the Shetland Islands. Nothing is accurately known about his life. He gave an account of his first voyage in his *Description of the Ocean*, in which he stated that he traveled through Britain, and that its circumference was over 40,000 stadia. In regard to the island of Thule, he said there was neither air, nor land, nor sea, but a composition of all of them, in which the whole universe was suspended. This substance, which could not be penetrated by land or sea, he had himself seen, and was told that it was "a connecting link of the universe." He puts Thule six days' sail from Britain. He says that the sun never sets during the summer solstice in Thule. On a second voyage he skirted the shore of Europe, from Cadiz to a river which he called Tanais. This may have been the Elbe, which he may have confused with the Don, the classical name of which was Tanais. He was also a mathematician and astronomer, and was the first to determine the meridian altitude of the sun at the summer solstice by the use of a gnomon. The fragments of his writings were collected and published by Arvedson at Upsala in 1824. Polybius and Strabo speak of him contemptuously, but modern geographers are more favorable in their judgment. It is supposed that he was sent out by the Massilians for the purpose of increasing their commercial connections.

PYTHIA (Lat., from Gk. Πυθία). The priestess of Apollo at Delphi. See DELPHI.

PYTHIAN GAMES (Lat. *Pythia*, from Gk. Πυθία). The second of the four great national festivals of the Greeks, held in the Crissæan Plain, near Delphi. Their origin was attributed to Apollo, in celebration of his destruction of the dragon Python. At first they were celebrated under the superintendence of the priests of Delphi every ninth year, i.e. once in each cycle, and consisted solely of a musical contest between singers to the cithara. After the first Sacred War, the character of the festival was changed, and the Amphictyons assumed charge. The first of the new series was held in B.C. 586, but it was not till the second celebration in B.C. 582 that the laurel wreath was given as a prize, and from this date the Pythian series was reckoned. They were from this time held in the summer of the third year of each Olympiad, probably in August, and seem usually to have occupied four days. The first day was occupied with the musical contests which always held the chief place. Among them the most important was the Pythian Nomos, a solo on the double flute, which represented the victory of Apollo over the dragon. On the second day came athletic games, much like those at Olympia (q.v.), and on the third the horse-racing. The latter contests were held in the Crissæan plain. On the fourth day seem to have come the festival procession and sacrifices. The musical contests were increased in later times; even poets and historians competed. Consult: Krause, *Die Pythien, Nemeen und Isthmien* (Leipzig, 1841); Mommsen, *Delphika* (ib., 1878); Schömann-Lipsius, *Griechische Altertümer*, vol. ii. (Berlin, 1902); Stengel, "Griechische Kultus-Altertümer," in Müller's *Handbuch der klassischen Altertumswissenschaft*, vol. v. (Munich, 1898).

PYTHIAN ODES. See PINDAR.

PYTHIAS. See DAMON AND PHINTIAS.

PYTHIAS, KNIGHTS OF. A fraternal and beneficial order founded in Washington, D. C., in 1864, by Justus H. Rathbone and five associates. Its objects are the practice of friendship, benevolence, and charity toward the members. It is asserted that the ritual, which is mainly Rathbone's work, is purely American. Its most binding obligation is complete and absolute secrecy. The first lodge instituted was Washington Lodge. A Grand Lodge for the District of Columbia was created on April 12th, and the work of creating subordinate lodges began with the institution of Franklin Lodge No. 2. In 1868 a new constitution was adopted at Washington under which was organized, as the central governing body, the Supreme Lodge Knights of Pythias of the World. The growth of the order was not rapid in the earlier years of its existence. In 1866 it had a membership of only about 380. In 1867 there were only 674 on the roll, but when the twentieth year was reached the membership had increased to more than 100,000, while in 1895 the membership was over 450,000, and at the end of 1902, 587,506.

The endowment or insurance branch was established in 1877. This branch is under the management of a president and board of officers, but is subject to the control of the Supreme Lodge. The members of this branch enjoy no greater privileges than other members outside of the insurance which they pay for. It had at the close of 1902 a total membership of nearly

60,000, representing an insurance of nearly \$102,500,000, and had disbursed up to that date \$18,105,000. The Uniform Rank is another division of the order. It is under the control of the Supreme Lodge also, but is directed by an officer whose title is major-general. The members of this grade are on the same plane with the other members, but only those members who have received the rank of Knight are eligible for membership. At the close of 1902 there were about 900 companies in the Uniformed Rank with a membership of nearly 45,000. Pythian Knighthood confers three ranks or degrees, viz.: the initiatory rank of 'page;' the armorial rank of 'esquire;' and the chivalrie rank of 'knight.' The motto of the order is: "Be generous, brave, and true."

The Order of Rathbone Sisters, organized in 1888, is made up of the mothers, wives, sisters, and daughters of Knights of Pythias, and such Knights as may desire to be associated with the organization. The membership in 1902 was about 50,000 sisters and 25,000 Knights.

PYTHON (Lat., from Gk. Πύθων, from Πυθῶ, *Pythō*, Πυθῶν, *Pythōn*, older name of Delphi and the surrounding region). In Greek mythology, a horrible serpent produced from the slime of

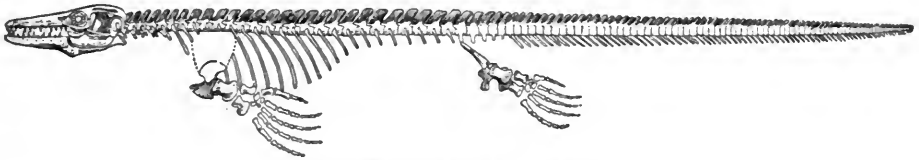

PLATECARPUS CORYPNEUS (restored).

Deucalion's flood. He lived in Paranasus and was slain by Apollo.

PYTHON. Any large snake of the subfamily Pythonidae of the family Boidae. The pythons differ from the boas (q.v.) in such anatomical particulars as the presence of certain supraorbital bones, and two rows of subcaudal scales. The best known species is the common 'adjiga' or 'rock-snake' (*Python molurus*) of Ceylon, India, and eastward to China, specimens of which have been seen 30 feet long. It is yellowish, with a series of large, reddish brown, dark-edged patches along the back, and another of smaller blotches on the sides. A snake 30 feet long could undoubtedly overcome a tiger, bear, or buffalo under favorable conditions, as has been related of these monsters. Another very large species of the Indo-China and Malayan region is *Python reticulatus*, more common eastward than the rock-snake, and marked in a lozenge pattern. Their habits are described at length in the (London) *Field* for 1894 and in the *Proceedings of the Zoological Society of London* for 1899, pages 631-634. Africa possesses several beautiful pythons, especially numerous on the equatorial west coast, where they are venerated by certain tribes and kept and tended in temples. All the pythons lend themselves easily to captivity and taming. These snakes lay a hundred or so eggs, which are regularly incubated by the female.

PYTHONOMORPHA (Neo-Lat. nom. pl. from *Python*, python + Gk. μορφή, *morphē*, form). A suborder of extinct marine reptiles of serpent-like appearance, found fossil in the Upper Cretaceous rocks of Europe, North and South

America, and New Zealand. The long vertebral column is made up of from 115 to 130 vertebrae, both pairs of limbs are modified into paddles for swimming; the long depressed skull is lizard-like, and the mandibles could be moved in a horizontal plane, thereby enabling them to swallow large prey. The jaws are provided with large conical teeth of formidable aspect. These animals were essentially sea serpents. The best specimens have been obtained from the chalk beds of Kansas. *Tylosaurus*, of which a finely preserved complete skeleton showing even the cartilages may be seen in the American Museum of Natural History in New York City, had a length of 30 feet. *Platy-carpus* is a similar, smaller animal with body from 10 to 15 feet long, abundant in the Cretaceous of the Western United States and France. *Clidastes* was one of the smallest members of the group with a body 6 to 12 feet long, and is from the Cretaceous of the United States. *Mosasaurus*, with its jaws armed with powerful teeth, was the largest of the group and attained a length of 40 feet. It is found in the Upper Cretaceous of Western Europe and of the United States.

BIBLIOGRAPHY. Von Zittel and Eastman, *Textbook of Palaeontology*, vol. ii. (London and New York, 1902); Williston, "On Mosasaurs,

etc.," *Kansas University Quarterly*, vol. ii. (Lawrence, 1893); also in *University Geological Survey of Kansas*, vol. iv. (Topeka, 1898); Williston and Case, "Kansas Mosasaurs," *Kansas University Quarterly*, vol. i. (Lawrence, 1892); Osborn, "A Complete Mosasaur Skeleton," *Memoirs of the American Museum of Natural History*, vol. i., part iv. (New York, 1899).

PYX, pike (Lat. *pyxis*, from Gk. πύξις, box, from πύξος, *pyxos*, box-tree, boxwood). The sacred vessel used in the Roman Catholic Church to contain the consecrated host. Anciently it was sometimes of the form of a dove, which was hung suspended over the altar. More commonly, however, it was, as its name implies, a simple box, generally of the precious metals, or, at least, of metal plated with gold or silver, sometimes of ivory, whose use, however, was forbidden in 1588. At present the pyx is commonly cup-shaped, with a close-fitting cover of the same material. The interior is ordered to be of gold, or at least plated with gold. The tabernacle from which the pyx hung over the altar received from it the name *eiborium*, which is now often applied to the pyx itself. A special class of pyx is that containing relics, which may be of silver or ivory.

PYXIE, PINE BARREN BEAUTY, FLOWERING MOSS (*Pyxidantha barbulate*). A small creeping shrub of the natural order Diapensiaceae. It is a common plant in New Jersey and North Carolina upon moist, sandy soil, and is esteemed for its pink buds and white, five-petaled blossoms, which appear in early spring. It is rarely cultivated, though the flowers are often sold in cities near where the plants grow wild.

Q



The seventeenth letter of the English alphabet. In Greek this letter was called *koppa*, and in Semitic *qoph*. It was early displaced in Greek by *kappa* (*k*), surviving only as a numeral sign for 90. The development of the character was

as follows:

Ϡ	Ϡ	Ϡ	Q
Phœnician.	Greek.	Early Latin.	Later Latin.

Soon after the Norman Conquest the letter was introduced into English from Norman French words in *q*. It replaced Anglo-Saxon *ow* in several Germanic words, as *queen*, from *cwēn*; *quick* from *cwīc*; *quoth* from *cwāþ*.

In sound the letter is the velar explosive. Since *q* in English is always followed by *u* plus a vowel, the usual phonetic value (*kw*) is that of the velar explosive labialized. This sound is formed simultaneously in two places, the soft palate (velum) and the lips.

Qu (pronounced *kw*) represents Indo-Germanic velar *g* in its labialized form *gʷ*. Indo-Germ. *gʷana*, 'woman'; Skt. *gṃā*, Bœotian Gk. *βᾰῶν*, AS. *cwēn*, Eng. *queen*; Skt. *jiv*, 'live,' Gk. *βίος*; AS. *cwīc* Eng. *quick*. Almost all the English words containing *qu* are of Latin or French origin, as *quadrangle*, *quart*, *etiquette*. In some words borrowed from the French the sound is that of a simple *k*, as *pique*, *coquette*. *Qu* does not occur medially except in such compounds as *inquire*, *requite*, *inquisition*.

As a mediæval Roman numeral Q = 500. In Latin Q. was the abbreviation for Quintus.

Q. C. stands for Queen's Counsel; Q. E. D. (Latin, *quod erat demonstrandum*) = which was to be proved; *qr.* = quarter or quire; *qt.* = *quart*; q.v. (Latin, *quod vide*) = which see.

QUACK'ENBOS, GEORGE PAYN (1826-81). An American educator, born in New York City. He graduated at Columbia in 1843, and studied law, but became a teacher in New York private schools. He edited the *Literary American* (1848-50), wrote a novel, translated Hauff's *Märchen* (1849), edited Spiers and Surenne's French dictionary (1852), and published many school books, including one on United States history (1854), one on rhetoric (1854), one on natural philosophy (1859), one on English grammar (1862), and one on ancient literature (1878).

QUA'COLTH. A North American Indian tribe. See KWAKIUTL.

QUA'DI. An ancient Germanic people of the Suevic race, inhabiting that part of Southeastern Germania (q.v.) which lay between the Gabreta Sylva, the Hercynian Forest, the Sarmatian Mountains, and the Ister or Danube. They were allies of the Marcomanni, their neighbors on the northwest. The Emperor Tiberius placed them under his protection, and made Vannius, one of his generals, King over them. During the reign of Marcus Aurelius the Quadi rose in alliance with the Marcomanni and other Germanic tribes. It was only after stubborn resistance that they were conquered in A.D. 174. Six years later Commodus, the successor of Marcus Aurelius, recognized their independence. Their subsequent history was uneventful, and nothing is known about them after the end of the fourth century.

QUADRANT (from Lat. *quadrans*, fourth part, from *quattuor*, four). In mathematics, one of the four equal parts into which a circle is divided by two perpendicular lines passing through the centre. (See TRIGONOMETRY.) In astronomy, the quadrant signifies an instrument similar in all respects to the sextant (q.v.) and formerly much used for the determination of angular measurements; it consisted of an arc of a circle equal to the fourth part of the whole circumference, graduated into degrees and parts of degrees. The quadrant employed by Ptolemy was of stone, with one polished side, on which the graduations were made. Tycho Brahe (1546-1601) used a similar quadrant, called by him the 'Quadrans muralis sive Tichonia,' at the observatory of Uranienborg. For an illustration of this quadrant, consult Brahe, *Astronomiæ Instauratæ Mechanica* (Wandsbek, 1598). Picard was the first who applied telescopic sights to this instrument. About this time the large mural quadrant (of 6 to 8 feet radius) began to be introduced into observatories. But these quadrants possessed various inherent defects, such as the impossibility of securing exactness of the whole arc, concentricity of the centre of motion with the centre of division, and perfect stability of the centre-work, which led to the use of the repeating circle, otherwise called the mural circle. See SEXTANT.

QUADRATIC EQUATION. See EQUATION.

QUADRATIC RESIDUES. See NUMBER.

QUADRATURE (Lat. *quadratura*, from *quadrare*, to square, from *quadra*, *quadrus*, square, from *quattuor*, four). In mathematics, the

process of determining the area of a surface. The term comes from the conception that we find a square whose area is equal to that of a given surface. The quadrature of the circle is one of the three great problems of antiquity, the others being the trisection of an angle (q.v.) and the duplication of the cube. (See CUBE.) These problems, like that of perpetual motion, have had their devotees in all ages since the advent of geometry and physics. The quadrature of the circle means the determination of the area of a circle of given radius, or the construction by the use of only the straight edge and the compasses of a square whose area is equal to that of the given circle. It was known to the Greek geometers that the area of a circle is half the rectangle whose sides are its radius and circumference respectively; so that the determination of the length of the circumference of a circle in terms of the radius, or the evaluation of π , is precisely the same problem as that of the quadrature of the circle. A brief outline of the history of attempts to evaluate the ratio π is given in the article CIRCLE.

The quadrature of curves can often be effected by means of another curve, a so-called 'quadratrix.' An important type of this curve is that probably invented by Hippias of Elis (c.400 B.C.), used both for quadrature and trisection, and called the quadratrix of Dinostratus. The curve, probably the most ancient of the transcendental ones, may be defined as the plane locus of the intersection of a straight line revolving uniformly about a point, and another straight line moving uniformly parallel to a given direction.

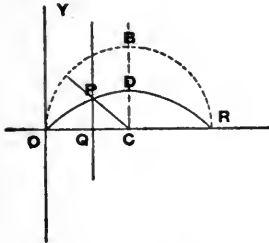

QUADRATRIX.

defined as the plane locus of the intersection of a straight line revolving uniformly about a point, and another straight line moving uniformly parallel to a given direction.

If in the figure $CO = r$ is the uniformly revolving radius, and PQ, the line moving parallel to OY, the locus of P, their intersection, or the curve OPR, is the quadratrix. Its rectangular equation is $y = (r-x) \tan \frac{\pi x}{2r}$; r is a mean proportional between the quadrant OB and the segment CD; and thus the circumference of a circle may be expressed in terms of the radius. Whence, if it were possible to construct D geometrically, the quadrature of the circle would be effected by elementary geometry, a condition which is always understood when it said that the quadrature of the circle cannot be effected. Another important form of the quadratrix is that of Tschirnhausen (1687). This curve may be defined as the locus of the point P, lying at the same time upon LQ parallel to BO, and upon MP parallel to OA (OAB being a quadrant of radius $OA = r$), where L moves over the quadrant and M moves over the radius r uniformly.

The equation of the curve is $y = r \sin \frac{\pi x}{2r}$. It has been used for the multisection of angles and the quadrature of curves.

Consult: Montucla, *Histoire des recherches sur la quadrature du cercle* (Paris, 1754); Newton, *Tractatus de Quadratura Curvarum* (Lon-

don, 1706); Klein, *Famous Problems of Elementary Geometry* (Göttingen, 1895; American ed., Boston, 1897); Schellbach, *Ueber mechanische Quadratur* (Berlin, 2d ed., 1884).

QUADRATURE. In astronomy, a planet is said to be in quadrature when there is a right angle at the earth between the direction of the planet and the direction of the sun.

QUADRINIUM UTILE. ū'ti-lè (Lat., useful four years). In Scotch law, the four years after majority during which a person is entitled to revoke or set aside any deed made to his prejudice during minority. This protection was also given by the Roman law to minors, to enable them to neutralize any unfair advantage that may have been taken of their inexperience during minority. See INFANT.

QUADRILATERAL (from Lat. *quadrilaterus*, four-sided, from *quattuor*, four + *latus*, side). A polygon (q.v.) of four sides. Among the remarkable properties of the quadrilateral are the following: The lines joining the mid-points of the successive sides form a parallelogram; the lines joining the mid-points of the opposite sides bisect each other. The bisectors of the four angles of a quadrilateral form another quadrilateral whose opposite angles are supplemental; a quadrilateral of the latter kind is inscribable in a circle. The sum of the squares on the four sides of a quadrilateral is equal to the sum of the square on the diagonals plus four times the square on the line joining their mid-points. A square can be constructed equal to any polygon, and hence equal to any quadrilateral, but the area of a quadrilateral cannot in general be expressed as an algebraic function of the sides.



ISOSCELES TRAPEZOID.

A *trapezium* is a quadrilateral no two of whose sides are parallel, and a *trapezoid* is a plane quadrilateral having two of its sides parallel. If the angles at the extremities of either parallel side are equal, the trapezoid is said to be isosceles. If the other two sides of the trapezoid are parallel, the figure becomes a parallelogram. See MENSURATION; PARALLELOGRAM.

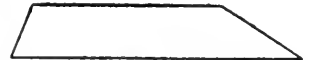

TRAPEZOID.

QUADRILATERAL. A common designation for the strong military line formed by the four fortresses of Mantua, Peschiera, Verona, and Legnago, which constituted a great bulwark for Austria in maintaining her dominion in Northern Italy in the nineteenth century. See ITALY; FORTIFICATION.

QUADRILLE, kwá-dril' (Fr., square). A dance of French origin, consisting of consecutive dance movements, generally five in number, danced by couples, or sets of couples, opposite to and at right angles to one another. The name is derived from the fact that the dancers are arranged into squares consisting each of four couples. The dance originated in the French ballets of the eighteenth century and was almost immediately adopted by society. Its modern form dates from the beginning of the nineteenth century. The names of the figures are: *Le pan-*

talon, l'été, la poule, la pastourelle, or la trenise, and la finale. The music accompanying these figures alternates between triple and duple time, 3-8, or 6-8, and 2-4. Musard was the most distinguished composer of quadrille music, and under his treatment it became for a time one of the art forms. In the American quadrille there are five figures: (1) *La promenade*, (2) *les moulinets*, (3) *les chevaux de bois*, (4) *la passe*, and (5) *la eorbeille*; but these all vary greatly at different times or places.

QUADRILLE. A game of cards which, as its name denotes, is played by four persons. The number of cards employed is forty, the tens, nines, and eights being discarded from the pack. The rank and order of the cards in each suit vary according as they are or are not trumps, and are different in the black and red suits. The ace of spades is always the highest trump, and is called *Spadille*; the ace of clubs or *Basto* is always the third highest trump; while the deuce of spades or clubs, or the seven of hearts or diamonds, known as *Manille*, is the second highest trump, according to the suit which is the trump, being always of the trump suit. When the black suits are not trumps, the black cards rank as in whist; and when they are trumps the order is the same with the exception as above mentioned of the deuce, which (in the trump suit only) becomes *Manille*, the deuce of the black suit which is not trumps retaining its position as the lowest card. The game is now practically obsolete, and has a value only to the student of late seventeenth and early eighteenth century customs and literature. It was complicated by a great number of conditions, making a complete description of it here impossible, but a good description of the game of *Ombre* or *L'hombre*, practically the same game as quadrille, except that it was arranged for three players, will be found in Pope's *Rape of the Lock*.

QUADRIVIUM (Lat., four branches of mathematics, place where four roads meet). The name given, in the language of the schools of the West, to the higher course of the mediæval studies, from its consisting of four branches, as the lower course, for an analogous reason, was called trivium (q.v.), or 'three roads.' The quadrivium consisted of arithmetic, music, geometry, and astronomy. These four studies compose the secondary part of the curriculum outlined by Plato in *The Republic*, and are described in the seventh book of that work. The history of this organization of human learning is briefly sketched in the article on **ARTS, SEVEN LIBERAL**, where references to the literature of the subject will be found.

QUADROON (from Sp. *cuarterón*, quadroom, fourth part, from *cuarto*, from Lat. *quartus*, fourth, from *quattuor*, four). The name given to a mixture of European and negro in which the relative proportion of blood is three-fourths white and one-fourth black. The first mixture is called mulatto, the second tierceeroon, the third quadroom, the fourth quindroon, etc. See **MISCEGENATION; MIXED RACES**.

QUADRUMANA (Neo-Lat. nom. pl., from Lat. *quattuor*, four + *manus*, hand). In the system of Cuvier, an order of Mammalia which contained the animals most nearly resembling man in their form and anatomical characters—viz. the monkey and lemur families. The name indicates that the extremities of all limbs are

hands, formed for grasping; in fact, the anterior limbs have in many monkeys less perfect hands than the hind ones, through the want or rudimentary character of the thumb. None of the Quadrumana are naturally adapted for an erect posture. The term is no longer used, as these animals are now classed with man in the order Primates (q.v.).

QUADRUPED (from Lat. *quadrupes*, quadrupes, four-footed, from *quattuor*, four + *pes*, foot). A term often employed as a synonym of 'mammal,' a use which is inaccurate, since some mammals, as man, have only two feet, properly speaking, and others, as the whales, none at all; while alligators, lizards, and turtles are all 'four-footed.' The term, therefore, has no exact zoological meaning.

QUADRUPLE ALLIANCE (Lat. *quadruplus*, fourfold, from *quattuor*, four + *-plus*, -fold). (1) A league formed by Great Britain, France, Austria, and the Netherlands against Spain in 1718, when the policy of that country under the guidance of the ambitious Alberoni (q.v.) threatened to destroy the laboriously established balance of power in Southern Europe.

(2) A league formed by Great Britain, Austria, Prussia, and Russia in 1840, for the purpose of checking the power of Mehemet Ali (q.v.), whose victory over the Turks at Nisib (1839) threatened the overthrow of the reigning Ottoman dynasty. Mehemet Ali was compelled to surrender Syria, which he had overrun, and to content himself with the hereditary rule over Egypt.

QUADRUPLET (from Lat. *quadruplare*, to make fourfold, from *quadruplus*, fourfold). In music, a rhythmical group of four notes, the time-value of which is equal to three or six of the regular rhythm. It is written thus:



QUÆSTOR, kwēs'tôr (Lat., investigator). The title of a class of Roman magistrates, reaching as far back, according to all accounts, as the period of the kings. The oldest quæstors were the *quæstores parricidii*, two in number, whose office was to conduct the prosecution of persons accused of murder, and to execute the sentence that might be pronounced. They ceased to exist as early as B.C. 366. A far more important though later magistracy was the *quæstores classici*, to whom was intrusted the charge of the public treasury. They appear to have derived the epithet of *classici* from their having been originally elected by the centuries. At first they were only two in number, but in B.C. 421 two more were added. As province after province was added to the Roman Republic, the number was increased, and in the time of Cæsar it was forty. On its first institution the quæstorship was open only to patricians; but after B.C. 421 plebeians also became eligible.

QUAGGA (Hottentot name). One of the wild horses of South Africa (*Equus quagga*), intermediate between the horse and zebra, and now extinct. In length of ears and character of the tail it resembled the horse, although it agreed with the asses in wanting the callosity in the inner side of the hind leg. It was rather smaller than the zebras, which it resembled in its reddish

brown color, and in having a dorsal stripe, and its head and fore quarters irregularly banded and marked with dark brown stripes, which became fainter until lost on the body. In some cases these transverse stripes reached back to the haunches, but they were always absent from all four legs, which were nearly white. The quagga originally wandered in great herds over the plains of South Africa, and its name was derived from its shrill, barking neigh, the last syllable of which was prolonged into a sort of scream. The flesh and hide were both of great value to the early settlers, and the animal was killed with ruthless waste by the Boers, as food for their slaves, and also because, by their curiosity and alertness, the quaggas interfered with hunting, alarming all other game in the neighborhood as soon as they discovered the hunter's presence. Thus by 1850 it was nearly exterminated. The quagga seemed easily susceptible to domestication and training, but few attempts seem ever to have been made in South Africa to utilize the animal. Consult Bryden, *Nature and Sport in South Africa* (London, 1897), and early writers on zoölogy and sport in South Africa. See EXTINCT ANIMALS; ZEBRA; and Plate of EQUIDÆ.

QUAGLIO, kwä'lyò. An Italian-German family of artists, originally from Laino, near Lake Como, and afterwards residents of Austria and Bavaria. The family produced several generations of painters, etchers, lithographers, and architects, all eminent in their respective branches. The earliest on record is GIULIO, born at Como, 1601, who painted, in the manner of Tintoretto, many frescoes and altar-pieces in Vienna, Salzburg, and Laibach and was ennobled by Emperor Leopold I.—GIUSEPPE (1747-1828), born at Laino, was noted for his scene paintings, and became Court architect at Munich (1801). He left four sons, all born in Munich and his pupils.—ANGELO (1778-1815), painter and architect, is remembered especially for his masterly drawings for Boissérée's publication on the Cathedral of Cologne. Of his easel pictures, an "Interior of Saint Peter's in Rome," and a "Gothic Church by Moonlight," are in the New Pinakothek.—DOMENICO (1787-1837), architectural and landscape painter, was the most illustrious member of the family. After practicing painting scenery with rare skill in Munich from 1808 to 1819, he studied under Mettenleiter and Karl Hess and traveled extensively in Germany, the Netherlands, France, and Italy to study and paint the most remarkable monuments of mediæval architecture. His numerous productions in that field bear witness to his thorough appreciation of the famous Dutch masters in architectural painting of the seventeenth century. Of the fourteen specimens in the New Pinakothek the "Interior of Saint Sebaldus at Nuremberg" (1816), "Villa Malta in Rome" (1830), the "Cathedral at Orvieto" (1831), and the "Views in Old Munich" are the most interesting. The National Gallery in Berlin contains the "Fish Market at Antwerp" (1830) and five others, and the Leipzig Museum the "Minster at Freiburg" (1821). Of other examples may be pointed out the cathedrals of Cologne, Strassburg, Rheims, and Rouen, and the picturesque views of Burg Eltz and the castles of Heidelberg and Hohen-schwangau. Intrusted with the reconstruction and entire decoration of the last-named, he died there before his task was completed. He also

left some rare etchings and published *Sammlung merkwürdiger Gebäude des Mittelalters in Deutschland* (1810), *Ansichten merkwürdiger Gebäude in München* (1811), and *Denkmäler der Baukunst des Mittelalters in Bayern* (1816).—LORENZ (1793-1869) was a genre painter of merry scenes from popular life, often combined with the grand surroundings of Alpine scenery, such as "Card Players in Tyrolese Inn" (1824, National Gallery, Berlin), "Target Practice in Tyrol" (Cassel Gallery).—SIMON (1795-1878), pupil also of his brother Angelo, early excelled as a scene painter, and was appointed Court theatre architect in 1815.—His son and pupil, ANGELO the Younger (1829-90), followed in his footsteps, as did also his grandson, EUGEN (1857—).

QUAHOG, kwä'häg. See CLAM.

QUAI D'ORSAY, kâ dôr'sâ'. The name of a portion of the left bank of the Seine at Paris, opposite the Place de la Concorde. From the fact that the Chamber of Deputies and other Government buildings front on it, its name is used to denote the French Government as Downing Street denotes the English. The buildings facing the Quai d'Orsay suffered severely during the bombardment of Paris in 1871, when the Palais d'Orsay, built in 1810, was destroyed.

QUAIL (OF. *quaille*, Fr. *caille*, from ML. *quaquila*, from MDutch *quakele*, *quackel*, quail, from *quacken*, Dutch *kwaeken*, to quack; onomatopoeic in origin). Originally and strictly, a small game bird of the Old World of the genus *Coturnix*, nearly allied to partridges, but having a more slender bill, a shorter tail, longer wings, no spur, and no red space above the eye. Quails never perch on trees, but always alight on the ground and far excel partridges in their power of flight. They are among the smallest of gallinaceous birds. The common quail (*Coturnix coturnix*, or *communis*) is found in most parts of the Old World, and in the Mediterranean region, where it is most familiar, is migratory. Species of quail are found in different parts of Asia, although no other is so abundant as the common quail, and none migrates as it does. The rain quail (*Coturnix Coromandelica*) is numerous in India. The Chinese quail (*Coturnix exalpathoria*), only about four inches long, is abundant in China, and is there kept for fighting the males, being very pugnacious. It is also said to be used for another singular purpose—the warming of the hands of its owner.

In America the word quail is used for all those small birds which have no feathers on the tarsus. In the United States only one species occurs east of the Mississippi, the well-known bob-white ('partridge' of the Southern States, 'quail' of the North), *Colinus Virginianus*, which occurs as far north as southern Maine and Minnesota. It is about 10 inches long. The upper parts are reddish-brown variegated with black, buff, and gray; the forehead and band on breast, black; the cheeks, throat, breast, and belly white, the latter barred with black; the sides chestnut, marked with black and white. The female has the forehead, cheeks, and throat buff. Bob-white is one of our most popular game birds and is in great demand for the table. It feeds on seeds, berries, and other vegetable matter. The nest is on the ground, and the eggs, 10 to 18 in number, are pure white. Its loud clear notes,

imitated in its name, are the three-syllabled 'ah bob white,' accented sharply on the last; but the first is not always plainly heard. It is one of the most characteristic and pleasing sounds of American rural scenes, for the bird is everywhere numerous, under protective laws. In the Western and Southwestern States are found several relatives (Odontophorinae), five of which differ markedly from *Colinus*, not only in their coloration, but in the presence of a noticeable crest. In the California quail (*Lophortyx Californica*) and Gambel's quail (*Lophortyx Gambelii*) the crest consists of six feathers, erect and recurved; in the mountain or painted quail (*Orcortyx pictus*) the crest is made of two long, drooping feathers; in the blue quail (*Callipepla squamata*) the crest is composed of numerous rather short, soft feathers, and the same is true of the remarkable Massena 'fool' quail of Arizona (*Cartotyx Montezumae*). All of these birds are exceptionally handsome, the prevailing tints being slaty-blue, olive-brown, chestnut or tawny, black and white. The head, especially in the male, is noticeably marked with black or brown and white. The mountain quail is the largest (a foot long), while the Massena quail is the smallest (only nine inches long). The eggs of *Lophortyx* and *Callipepla* are remarkable for being speckled. Consult authorities cited under PARTRIDGE; and see Plate of PARTRIDGES, ETC. See Colored Plate of GAME BIRDS, accompanying article GROUSE; and of EGGS of GAME and WATER BIRDS.

QUAIN, JONES (1796-1865). An English anatomist. A brother of Richard Quain, born in Mallow, Ireland. He received his medical education in Dublin and Paris. He was lecturer on anatomy and physiology in Aldersgate School of Medicine, in London, 1829-31; professor of the same branches, 1831-36. He was the author of *Quain's Elements of Anatomy* (1828; 10th ed. 1890), and of a translation of Martinet's *Pathology* (1835), and also published in 1858 a series of *Anatomical Plates*.

QUAIN, RICHARD (1800-87). An English anatomist and surgeon, born at Fermoy, Ireland. He studied medicine in London and Paris. He was appointed demonstrator in 1828, professor of anatomy in 1832 in the University of London; assistant surgeon in 1834 and surgeon in 1850 to the North London Hospital, from which he resigned in 1866. He was president of the Royal College of Surgeons in 1868, and served as surgeon extraordinary to the Queen. Among his works are: *Anatomy of the Arteries* (1845); *Diseases of the Rectum* (1854); *Observations on Medical Education* (1865); *Some Defects in General Education* (1870); *Clinical Lectures* (1884). Dying, he bequeathed nearly £75,000 to University College, London, for education in modern languages (especially English) and in natural science.

QUAIN, SIR RICHARD (1816-98). An English anatomist and physician, born in Mallow, Ireland, a cousin of Richard and Jones Quain. He became fellow in 1857 and vice-president in 1889 of the Royal College of Physicians, and was appointed physician extraordinary to Queen Victoria as well as Lumleian lecturer for 1872 and Harveian orator in 1885. Edinburgh conferred the degree of LL.D. upon Sir Richard in 1889, and the General Medical Council elected him its president in 1891, the same year in which he was

created a baronet. He published *Diseases of the Muscular Walls of the Heart* (1872), and *The Healing Art in Its Historic and Prophetic Aspects* (1885), and edited the *Dictionary of Medicine* (1882; 3d ed. 1902).

QUAKER CITY. A popular name of Philadelphia, Pa., in allusion to its early settlers.

QUAKER POET. A title given to John Greenleaf Whittier. It has also been used of Bernard Barton and John Scott.

QUAKERS. See FRIENDS.

QUAKING GRASS (*Briza*). A small genus of mostly European grasses, with loose panicles; drooping, generally broad, compressed spikelets, suspended by delicate stalks, and tremulous in the slightest wind. The panicles are often used in winter bouquets. *Briza media* is considered a valuable pasture grass for dry situations in Central Europe. It has become sparingly naturalized in the United States. *Briza maxima*, a larger species, and *Briza minor*, a smaller one, are similar in habit.

QUALITY. A term used in philosophy to designate one of the categories under which reality is supposed to be thought or in which it is described. In this sense it is particularly distinguished from quantity, the latter taking into account the amount or mass of given phenomena, while quality denotes distinctive character. Quality has, in modern philosophy, a psychological connotation, denoting characteristics of perception as much as of real things. It is thus the individual attribute of sensation, that which characterizes or individualizes one kind of sensation so that it cannot possibly be mistaken for any other kind—redness, nausea, hunger, triangularity, are examples of quality. In psychology quality is especially distinguished from intensity, duration, and, in the case of special perceptions, from extension, as an attribute of sensation, and it furnishes the only test for distinguishing kinds of sensations. Of course, in ordinary experience qualities come to us fused, such a thing as a pure quality being seldom, if ever, experienced. Things are made up of compositions of qualities, and these compositions, in a certain sense, may themselves be considered as qualities in that they form the qualitative texture of actual experience and are the basis for our discriminations of things. See CATEGORY.

QUAM'ASH (from the North American Indian name), or BISCUIT ROOT (*Camassia esculenta*). A North American bulbous plant of the natural order Liliaceae, nearly allied to hyacinth, abounding on the prairies. The roasted bulbs are agreeable and nutritious, and are much used by the Indians for food. The scapes, which are sheathed at their bases, are a foot or more tall and bear 10-40 blue or purple flowers. A smaller species, *Camassia Fraseri*, is found from Pennsylvania south and west. Other species, indigenous to the Pacific coast region, are sometimes cultivated in the East.

QUANA. A Comanche chief and the most influential leader among the three confederated tribes of Kiowa, Comanche, and Apache, in southwestern Oklahoma. He was born about 1845, and was a half-breed, the son of a captive white woman, who was married to a chief of the Kwahadi band. Upon the death of his father, Quana became chief. He was prominent in 1874, when

he led 700 warriors of the confederated tribes in a desperate attack upon the fort known as the Adobe Walls on the South Canadian River in the Texas Panhandle. In the subsequent encounters he took an active part until the final surrender a year later, being the last man to come in with his band. Recognizing the advent of a new order of things, he went down into Texas to learn something of the white man's ways, and returned to his tribe an apostle of civilization. In 1882 he began to advocate the leasing of the surplus pasture lands of the reservation, in which he finally succeeded, thus increasing the revenues of the tribes by more than \$100,000 yearly. In 1888 he was appointed a judge of the Indian court to try minor Indian offenses. In 1892 he was the first signer of the treaty by which the lands of the reservation were opened to settlement in 1901. He made many visits to Washington as a delegate for his people and traveled extensively in other parts of the country. After the Indians were made citizens by the opening of the reservation he filled one or two local offices under the county government.

QUANTICS. See FORMS; FUNCTION.

QUANTZ, kvänts, JOHANN JOACHIM (1697-1773). A German flautist, born at Oberscheden, Hanover. In 1716 he went to Dresden, where he joined the town orchestra under Heine. He was at first an oboist, but, after a thorough course of instruction under Buffardin, he exchanged the oboe for the flute. In 1728 he played before Frederick the Great (then Crown Prince) at Berlin, and so delighted him that he arranged for personal instruction on the flute. When Frederick ascended the throne, in 1740, the flautist was called to Berlin as chamber-musician and Court composer, which position he held till his death. His compositions include 6 flute sonatas with bass (1734), 6 duets for flutes (1759), choral melodies to 22 odes by Gellert (1760), and *Application pour la flûte traversière a deux clefs*. Quantz improved the flute by the addition of a second key and the sliding top for tuning the instrument.

QUAPAW, kwä'pä (from *Uga'pa*, downstream). A tribe of Siouan stock (q.v.) prominent formerly, under the name of Arkansas, as the allies of the French in the early days of the Louisiana colony. The Quapaw, Omaha, Ponca, Osage, and Kaw speak dialects of the same language, and according to their traditions, borne out by historical evidence, formerly lived as one people in the eastern part of the United States, but migrated westward and separated near the mouth of the Ohio, where the Quapaw turned southward, while the others continued west or north. Under the name of Capaha they are mentioned in the De Soto narrative of 1540; they were then located on the Mississippi apparently not far above Memphis. In 1818 they sold all of their claims in Arkansas, upper Louisiana, and on the east bank of the Mississippi, excepting a reservation extending from the Arkansas southward to the Saline River. They were then rapidly declining from whisky and wars with other tribes, but were still estimated at 1000. They drifted westward until the remnant, a few hundred, including mixed bloods, was finally gathered upon their small reservation in the northeastern corner of the Indian Territory. In their former aboriginal characteristics and customs they resembled the Osage, but seem to have been of

more warlike spirit and fixity of purpose. The few that remain appear to be prosperous and able to hold their own with their white neighbors.

QUARANTINE (It. *quarantina*, from ML. *quarantena*, period of forty days quarantine, number forty, Lent, from Lat. *quadraginta*, forty). Originally, the period of forty days during which a ship arriving in port and suspected of being infected with a contagious or malignant disease was forbidden to land freight or passengers. From the second half of the 14th century, the Italian republics established quarantine regulations, directed toward the East against the invasion of pestilence. In 1403 Venice instituted the first maritime quarantine, followed by Genoa in 1467. During the latter part of the eighteenth century Austria stretched a permanent cordon of troops across her eastern frontier, but even this failed to shut out the plague, which ravaged her provinces. The example of the Italian cities was early adopted by Marseilles and an efficient system of sanitary supervision was developed, finally passing under the control of the sanitary magistrates. Other European seaport cities enforced rules and regulations of varying effectiveness. In 1850 delegates from the principal States bordering the Mediterranean convened in Paris, and adopted a convention and code of international sanitary regulations, which was subsequently generally adopted by all powers and is enforced in their commercial relations with one another. These uniform regulations have relieved commerce from the restrictions which were imposed by the former conditions. Under its provisions a ship clearing is given a *clean bill* or a *foul bill* according as the port from which she sails is free or infected with a contagious disease, the plague, cholera, and yellow fever being especially guarded against. Ships entering port are at once put under quarantine, varying in length with the character of the contagion feared. For the plague, from 10 to 15 days is generally required; for yellow fever, 5 to 7 days; and for cholera, 5 days, including the term of the voyage. These periods may be modified somewhat according to the length of the voyage and the health prevailing during this time. Further regulations are laid down regarding the disinfecting and handling of merchandise in cargo. Special restrictions have also been adopted against the Oriental countries, Egypt, and Turkey, and for this purpose sanitary boards are maintained in Alexandria, Constantinople, and other frequented ports, with physicians located in different parts of the countries liable to epidemic diseases, whose duty it is to investigate and report to the local authorities and consular offices the condition of the general health.

In modern usage the term quarantine is also applied to the sanitary rules and regulations adopted within a State to restrict the spread of contagious diseases within its own boundaries. They are enacted by the State in the exercise of its sovereign right of police power (see POLICE POWER), and so absolute is this that even summary proceedings invading the rights of the individual or destroying valuable property are upheld as constitutional. Besides the Federal quarantine regulations providing for the protection of the United States in its intercourse with foreign nations, the various State jurisdictions have general statutes authorizing the organization of State

boards of health and similar local boards in cities, villages, and towns, prescribing how they shall be constituted and defining their powers and duties. This power is usually conferred upon municipal corporations by the charter granted by the legislature or by general statute, but in the absence of such express authority, it cannot be implied as incident to the ordinary powers of the corporation. Conflict between the United States and State authorities is provided for by the terms of the Federal statutes (U. S. Rev. Stats., §4792; Rev. Stats., U. S. Sup., 1874-91, p. 157, c. 66, §5) requiring customs, revenue, and other Federal officers to observe State health and quarantine laws. Reasonable charges for quarantine services may be imposed upon a vessel under State authority, and there can be no recovery from the State or municipality for losses resulting from the quarantining or disinfecting of premises infected with contagious disease, where the method employed was proper and the use made of the premises was a necessary one, for the courts are generally liberal in construing empowering statutes. Further, a municipality cannot be held liable for an act of its health officer in wrongfully confining in quarantine a citizen reasonably believed to be afflicted with a contagious disease, since the act done is governmental in its character; but the officer may become personally liable where he acted wrongfully or in excess of his duty. A carrier is protected from liability for non-delivery of goods or passengers where such act would be a violation of quarantine regulations.

The *widow's quarantine* was the term applied under the common law to her right to remain in the mansion house 40 days after her husband's death, during which time her dower should be admeasured and assigned. This right was guaranteed by section 7 of the Magna Charta (spelled "Carta" in the original document), and has been perpetuated with various modifications in the statutes of the several States. Consult the authorities referred to under DOMESTIC RELATIONS; REAL PROPERTY.

Consult: Parker and Worthington, *Public Health and Safety* (1892); Baker, *Laws Relating to Quarantine* (London, 1879); and the various statutes and regulations of the different State and municipal governments.

QUAREGNON, ká're-nyón'. A mining town of Belgium, in the Province of Hainault, situated four miles west of Mons. There are large and important coal mines and blast furnaces. Population, in 1890, 14,361; in 1900, 16,249.

QUARITCH, BERNARD (1819-99). An English bookseller, born at Worbis, in Prussian Saxony. He worked at the bookseller's trade in Nordhausen and Berlin and went to England in 1842. After serving in Bohn's publishing and bookselling shop and spending a year in Paris, he established himself in London as an English citizen in 1847. In 1860 he removed from Castle Street to larger quarters at 15 Piccadilly, his permanent stand. Throughout his life he had made a specialty of Oriental literature, and he printed grammars in the Turkish, Persian, and Arabic languages, besides making a collection of Oriental manuscripts. Probably the best-known books from his press were the first four editions of FitzGerald's Omar Khayyam. (See FITZGERALD, EDWARD.) He was represented at all the

book sales of importance in Europe and America, and thus acquired a great number of rare and costly works. The catalogues he issued from time to time are invaluable to bibliographers. His first complete indexed catalogue appeared in 1860; this was followed by others as he continued to add to his stock. The most noteworthy of these are the great catalogue of 2395 pages (1880), the *Biblioteca Xylographica, Typographica, et Palæographica: Catalogue of Block Books and of Early Productions of the Printing Press in All Countries, and a Supplement of Manuscripts* (1873), and the last he prepared, *General Catalogue of Old Books and Manuscripts* (1887-88, supplements 1894 and 1897). Quaritch was especially interested in rare manuscripts; Shakespeareana, early English literature, Americana, Bibles, and liturgies. He was one of the founders and first president (1878) of the celebrated club, the "Sette of Odd Volumes." Some of his lectures were printed for the "Sette" in 1883, 1885, 1886, 1887, 1889, 1890, 1891 and 1894. Consult: Wyman, B. Q., *A Biographical and Bibliographical Fragment* (London, 1880), and "Bernard Quaritch," in the *Atlantic Monthly* for June, 1900.

QUARRY, QUARRYING (OF. *quarriere*, Fr. *carrière*, from ML. *quadraria*, quarry, place where stones are squared, from Lat. *quadratus*, p.p. of *quadrare*, to square). The open excavation from which any useful stone is taken for building and engineering purposes is called a quarry; the operations required to obtain rock in useful form from a quarry is called quarrying. Quarrying processes are three in number, viz. by hand tools, by explosives, and by channeling and wedging. To understand the operations of the quarryman, it is necessary to bear in mind that all rocks belong to one or other of two great classes, namely, the stratified and the unstratified. The former are sedimentary rocks, occurring in parallel beds or strata, and consist chiefly, in so far as we are at present concerned, of sandstone and limestone. Unstratified or igneous rocks, which include greenstone or whinstone, granite, and porphyry, have no distinct bedding, that is, they do not lie in separate layers. Roofing-slate is a stratified rock, but it splits into thinner laminae in the direction of its *cleavage* than in the direction of its bedding, the former being often at right angles to the latter. Granite and other igneous rocks have also a natural jointage or cleavage, although they are not stratified. Advantage is taken of these peculiarities in quarrying the different rocks, but in the main the systems adopted do not greatly differ.

Hand tools alone may be successfully used for quarrying stone which exists in beds. The principal hand tools are the pick, the crowbar, the drill, hammer, wedge and plug, and feathers. With the drill and hand hammer a row of holes a few inches apart is drilled partly through the layer or stratum, perpendicular to its plane of stratification and along the line at which it is desired to break the stone. These holes are usually drilled from $\frac{3}{8}$ in. to $\frac{3}{4}$ in. in diameter. In each hole are placed a plug and two feathers. The plug is a narrow wedge with plane faces; the feathers are wedges flat on one side and rounded on the other. When a plug is placed between two feathers the three together will slip into a

cylindrical hole, and by driving the plug down between the feathers it exerts a splitting or cleaving force of great intensity. In quarrying, as first stated, each hole in a long row is filled with a plug and feathers; by striking each plug a sharp blow with a hammer, hitting them in succession, and by repeating the operation again and again, the combined splitting force of the plugs and feathers finally becomes great enough to rupture the rock. Generally the plugs and feathers are used only for effecting the larger subdivisions of the rock, the smaller pieces being split and broken by hammers and wedges. Sometimes this method of quarrying is called the plug and feather method.

Explosives are the means most commonly employed for detaching large blocks of stone in quarries, these blocks being afterwards split and broken into smaller stones by wedges or by the plug and feather method. In this method of quarrying the drill holes are put down to the depth to which it is required to break the rock and are then partly filled with some explosive, which is discharged by the usual methods of blasting (q.v.). The kind of explosive used depends upon the character of the result which is sought. In quarrying rock to be crushed into small fragments for road work, concrete making, etc., the object sought is a rather finely broken mass of stone, and here, because of its great shattering effect, some form of high explosive, as dynamite, is employed. When building stone of large size is to be quarried, weaker and slower acting explosives, as gunpowder, are employed. In each quarry the structure of the rock has to be carefully studied with the view of taking advantage of the cleavage planes and natural joints, and for each class of rocks there is a characteristic method employed. The drill holes are usually made by rock drills operated by power, though hand drills and churn drills are also used. The drill holes are driven vertically in a row some distance back of and parallel to the edge of the working face of the quarry, and are blasted simultaneously so as to force outward a rectangular mass of rock.

Channeling is the process of cutting long narrow channels in rock to free the sides of large blocks of stone. Channeling machines, or channelers, are made in a variety of forms, the most common of which is a vertical steam boiler mounted on wheels and provided with mechanism for self-pulsation, having on the same carriage with the boiler a steam cylinder which operates, like a percussion drill, a flat bar with a cutting edge. In operation the machine is run forward and back so as to carry the cutter back and forth along the line on which the channel cut is to be made. If the rock is in layers the channel cut is often not made the full depth of the layer, but is sunk deep enough to permit the insertion of wedges by which the rock is split, the cut or groove guiding the fracture. When the rock is not in layers it is often necessary to undercut the block as well as to cut a channel around it. This is done by drilling a series of holes along the bottom, the process being called gadding by quarrymen. Wedges inserted in the drill holes serve to separate or split the rock at the bottom. A special form of machine called a gadder is used for undercutting. It consists essentially of a rotary drill, generally a diamond drill, ar-

ranged to be operated horizontally and receiving motion from an engine taking steam from a vertical boiler, the whole being mounted on a carriage. The channeling and wedging process of quarrying is extensively used in quarrying marble, sandstone, limestone, and the other softer rocks, but is not a successful process for granite and other similarly hard stones. For a description of the methods and tools used in cutting quarry stone into suitable shapes for structural purposes, see *STONE CUTTING AND DRESSING*. For full details of quarrying processes and machinery, consult Merrill, *Stones for Building and Decoration* (New York, 1891), and *Report on the Quarry Industry*, vol. x., Tenth United States Census. See illustration under *MARBLE*; also *BUILDING STONE*; *DRILL*; *EXPLOSIVES*.

QUART. See *WEIGHTS AND MEASURES*.

QUARTAN FEVER. See *MALARIA AND MALARIAL FEVER*.

QUARTER. See *WEIGHTS AND MEASURES*.

QUARTER-CRACK. A form of sandcrack, a disease of the horse; specifically a vertical crack on the lateral part of the wall of the foot. When the crack is directly in front it is called a toe crack. Toe cracks are most common in the hind feet, while quarter-cracks nearly always affect the fore feet and similarly the inside quarter is more liable to the injury than the outside one, in that when in motion it is subject to a greater part of the weight of the horse. In the normal foot the coronet or, for authorities differ, the sensitive lamina, which cover the external surface of the pedal bone, secretes an adhesive material which binds firmly together the fibres of the wall of the hoof. When the secreting membrane is prevented from carrying out its functions the material secreted under such conditions loses its power, and the horn which it supplies becomes deficient in strength. Where this disease is of hereditary tendency the horn is so weak that it would seem to split, if subjected to a violent strain. Ordinarily, the various forms of sandcrack are caused by the much to be condemned system of using seated shoes and of paring the frog, an unnatural custom by which the entire weight of the animal is thrown on the crust of the foot, instead of being properly distributed between the wall, the frog, the outer portion of the sole, and the bars. Among other causes of perverted secretion may be mentioned the strain of fast work, and hard ground. Cracks or splits naturally occur in that part of the hoof which receives the greatest amount of strain, usually the inner quarter of the fore, and the toe of the hind foot, although it sometimes cracks at the toe of the fore foot, if the hoof is of a flat conformation. Cart and cab horses are especially liable to sandcrack. The usual treatment is: (1) To prevent movement between the edges of the crack; (2) to heal the exposed tissues should they be wounded or inflamed; and (3) to encourage the downward growth of sound horn from above the crack, for it is evident that as the edges of the crack cannot reunite the growing down of the crack is the only effective remedy. See *VACHETTE CLASP*. An authoritative and comprehensive treatment of this subject may be found in Hayes, *Veterinary Notes for Horse Owners* (London, 1897).

QUARTER-DAYS. Conventional dates on which, by custom or agreement, leases begin and

terminate and rent becomes payable in England. Rents are generally made payable by the express terms of the lease on the usual quarter-days. These are, in England and Ireland, Lady day, March 25; Midsummer day, June 24; Michaelmas day, September 29; and Christmas day, December 25. In Scotland there are two 'legal terms' in each year, and two 'conventional terms,' the latter being only adopted when expressly so agreed. The legal terms are Whitsunday, May 15, and Martinmas, November 11; and the conventional terms are Candlemas, February 2, and Lammas, August 1. The law of Scotland differs from that of England in this, that if nothing is said between the parties on letting houses and lands, these legal terms are impliedly included as part of the agreement, both as regards time of entry and payment of rent.

QUARTERING. In heraldry, the bearing of two or more coats on a shield divided by horizontal and perpendicular lines. See *HERALDRY*, section on *Marshaling of Arms*.

QUARTERMASTER. In the United States Army, a commissioned officer serving in the quartermaster's department at an army post or in a regiment; in which latter instance he is a regimental officer, usually of lieutenant's rank, detailed by the commanding officer to perform the duties of *regimental quartermaster*. He is assisted by the *regimental quartermaster-sergeant*, and is responsible for the proper assignment of quarters for officers, men, animals, and stores, and the superintendence and procurement of all regimental supplies. There is a *quartermaster-sergeant* to each company, battery, or troop. The Quartermaster's Department at Washington, D. C., is one of the most important bureaus of the War Department, and is charged with the duty of providing means of transportation of every character which may be needed in the movement of troops and material of war. It furnishes also all public animals employed in the service of the army, the forage consumed by them, wagons and all articles necessary for their use, except the equipment of cavalry and artillery. It furnishes clothing, camp and garrison equipage, barracks, storehouses, and other buildings; constructs and repairs roads, railways, bridges; builds and charts ships, boats, docks, and wharves needed for military purposes; and attends to all matters not expressly assigned to some other bureau. The Quartermaster's Department in 1902 consisted of 1 quartermaster-general, with rank of brigadier-general; 4 assistant quartermaster-generals, with the rank of colonel; 8 deputy quartermaster-generals, with the rank of lieutenant-colonel; 14 quartermasters, with the rank of major; and 31 assistant quartermasters, with the rank of captain (including 1 military store-keeper). Under the terms of the Army Act of 1901, vacancies in this and other staff departments which cannot be filled by promotion within the department will be filled by details of line officers.

In the British Army regimental quartermasters are usually non-commissioned or warrant officers of long service, who receive the commission of honorary lieutenant with their appointment of quartermaster. They combine subsistence with their regular quartermaster's duties, being responsible for the quantity of all food supplies required by the regiment or corps with which

they serve. There are no company or troop quartermaster-sergeants, color-sergeants (q.v.) of companies being responsible for that branch of work. There is also a quartermaster-general with a staff. See *ARMY ORGANIZATION*.

In the navy and merchant service a quartermaster is a petty officer who assists in the navigation of the ship. At sea he superintends the steering of the helmsman, looks out for the log, writes up the 'columns' in the log book, and has charge of the navigator's stores. He also keeps a lookout with his spy glass both in port and at sea, reporting such occurrences as are of interest to the commanding officer or officer of the deck.

QUARTER SESSIONS. In England, a court or meeting of justices of the peace, who assemble every quarter of the year, for judicial as well as miscellaneous business. It is an inferior court of record, having power to punish contempt of court, to adjourn cases, and summon juries for adjourned sittings. The meetings are fixed by statute to be held in the first full week after December 28th, March 31st, June 24th, and October 11th, respectively. The chief officer of the Court of Quarter Sessions is the clerk of the peace. The original jurisdiction of the Court of Quarter Sessions is largely confined to criminal business, but it has certain minor civil jurisdiction by virtue of statutes, and also appeals from certain courts of summary jurisdiction. Most of the administrative business formerly attended to by the Court of Quarter Sessions was transferred to the county councils in 1888. In Scotland there is also a court of quarter sessions of the peace, held four times a year at the county town. Consult: Pritchard, *Jurisdiction, Practice, and Procedure of the Quarter Sessions* (London, 1903); Archbold, *Practice of the Quarter Sessions* (London, 1898).

QUARTET (It. *quartetto*, from *quarto*, Lat. *quartus*, fourth, from *quattuor*, four). A concerted composition for four voices or instruments, in which all the parts are real, i.e. no one can be omitted without injuring the proper effect of the whole. As early as the fifteenth century four-part writing had been recognized as the kind most suitable for combining harmonic fullness and clearness with ease of execution. Since then it has been regarded as the groundwork of all composition. During the seventeenth century, however, the tendency was toward the employment of large masses in double and triple choruses (Schools of Rome and Venice. See *MUSIC, SCHOOLS OF COMPOSITION*.) But during the eighteenth century the development of the string quartet led to a return to four-part writing. In the nineteenth century Mendelssohn and Schumann did much to popularize the male quartet. One of the highest forms of modern music is that written for the string quartet, which consists of two violins, viola, and cello. Although this combination of instruments was established by Monteverde (q.v.) as the foundation of his orchestra, no music was written for it until a century and a half later, when Haydn recognized the possibilities of this group of instruments. Haydn is the father of the symphony. He took the sonata form and in 1755 wrote a miniature symphony for the string quartet. Although this first quartet is very crude, Haydn soon acquired mastery of the form. He wrote in all 83 quartets. Mozart, who greatly developed

the quartet, did not, like Haydn, regard it as a miniature symphony to express only miniature ideas. Some of the boldest effects in Mozart's works are found in his quartets. During the lifetime of Haydn and Mozart the quartet was assiduously cultivated by lesser composers, such as Gossec, Grétry, Sannmartini, Romberg, Ries, Onslow, and others. They were succeeded by the unrivaled master of the string quartet, Beethoven. The first violin no longer had the principal melody; he placed all four instruments on a footing of absolute independence. He wrote only 16 quartets, but in these monumental works all the possibilities of the form are exhausted. Schubert wrote 20 quartets which are scarcely inferior to those of his predecessor either in profound ideas or mastery of technical workmanship. While Beethoven occasionally allows one or two instruments to rest (producing a certain thinness of tone), Schubert keeps every instrument at work from beginning to end. Schumann wrote only three quartets (op. 41), but they can be ranked with those of Beethoven and Schubert. Spohr wrote 33 quartets and four double quartets. His quartets are more like those of Haydn and Mozart; the independence of the several instruments is sacrificed to the predominance of melody in the first violin. The same is true of Mendelssohn's quartets. The second violin and viola too frequently have only filling-up work, like tremolo, etc. Another master is Brahms, whose quartets are written entirely on the lines of his great predecessors. Some of the most important quartet organizations, with their original members are: The *Florentine*, Becker, Masi, Chiostrì, Hilpert; the *Hellmesberger*, Georg, Joseph, Joseph, Jr., and Ferdinand Hellmesberger; the *Schuppanzigh*, Schuppanzigh, Sina, Weiss, Kraft; the *Joachim*, Joachim, De Abna, Wirth, Hausmann; the *Kneisel*, Kneisel, Roth, Svecenski, Schroeder; the *Bohemian Quartet*, Hoffman, Suk, Nedbal, Wihom; the *Brodsky Quartet*, Brodsky, Becker, Sitt, Klengel.

QUARTIER LATIN, kár'tyá' lá'tán' (Fr., Latin quarter). The famous student section of Paris, a district south of the Seine, containing the Sorbonne, the Collège de France, the Institute, the Luxembourg, Panthéon, and various schools. The name *quartier* or *pays latin* was given to it because Latin was the language of mediæval scholasticism. The Latin quarter has always been the centre of youthful revolutionary ideas and a synonym for Bohemian life.

QUARTILE. See ASPECTS.

QUARTLEY, kwárt'li, ARTHUR (1839-86). An American marine painter, born of English parentage in Paris. He lived in London as a child, and came to the United States in 1851. He studied without instruction in Baltimore and New York City, and was elected a National Academician in 1886. His works include: "New York from North River;" "Afternoon in August—Coast of Maine" (1878); "Low Country on the North Shore of Long Island" (1881); and "Off the Isle of Shoals" (in the Union League Club, New York City).

QUARTODECIMAN. A name applied to the party in the early Christian Church which believed in celebrating Easter on the fourteenth day after the full moon, by analogy with the Jewish usage regarding the Passover. See EASTER; NICEÆ, COUNCIL OF.

QUARTZ (MIG. *quartz*, Ger. *Quarz*, rock crystal, quartz). A mineral composed of silica or silicon dioxide, crystallizing in the hexagonal system. It is very hard, scratching glass readily, and has a specific gravity of from 2.5 to 2.8, depending upon the amount of impurity present. When pure it is colorless and perfectly transparent, but it often has some shade of yellow, red, brown, green, blue, or black. By friction it becomes positively electrified. It is a very abundant and widely distributed mineral, largely composing the sands found on beaches and being also a constituent of most rocks. (See Rocks.) The mineral species includes two important groups: those that are crystallized and have a vitreous lustre, called 'pheno-crystalline,' and those that are massive and flint-like, called 'crypto-crystalline.'

The pheno-crystalline varieties of quartz include amethyst, asteriated or star quartz, aventurine, cairngorm, morion or smoky quartz, cat's-eye, citrine or false, Saxon, Scottish or Spanish topaz, ferruginous quartz, or rubasse, (sometimes called 'acona' or 'Mont Blanc ruby'), hyaline, milky or greasy quartz, rock crystal (including the Brazilian pebble, 'Lake George diamonds,' etc.), rose quartz, sagenite quartz, and sapphirine, or siderite. The crypto-crystalline varieties include agate ('banded' or 'eye agates,' 'fortification' or 'ruin agates,' dendritic agate, moss agate, agatized wood, etc.), basanite (lydian stone or touchstone), beekite, bloodstone or heliotrope, carnelian, chalcodony, chrysope, flint, hornstone, jasper, onyx, plasma, prase, sard, and sardonyx. In addition to the foregoing should be mentioned *quartz rock* or *quartzite* (q.v.), which is a sedimentary sandstone converted into a very hard compact rock by metamorphic action. Although it is distinctly granular, the grains seem to melt into each other, or to be enveloped in a homogeneous paste. Of similar nature are the different varieties of pseudomorphous quartz, such as the agatized wood and beekite previously mentioned.

The common variety of crystallized quartz is employed in the arts as an abrasive, principally in the manufacture of sandpaper. It is also crushed and used for polishing marble and as a filler for wood. For the latter purpose it is ground to an impalpable powder and combined with japans or oils to make a paste which is then applied to the surface of the wood. Quartz sands are of importance in the manufacture of glass, refractory brick, mortar, cements, etc. The occurrence of quartz in the form of veins is noteworthy from the fact that such veins are the sources of many of the valuable metals, including gold, silver, copper, and lead. (See ORE DEPOSITS.) Further information concerning the principal varieties of quartz will be found under their special names.

QUARTZITE (named from the mineral quartz, which is its principal constituent). A metamorphic rock composed essentially of quartz, and produced from the alteration of sandstone (q.v.). The process of alteration consists of the enlargement of the sand grains which compose the sandstone through accretion of silica in aqueous solution. This accretion of silica cements neighboring grains together by crystallizing around them, and forms as a result a dense vitreous rock which usually disposes little if any

evidence of its original nature. Exceptionally, however, the microscope reveals the original rounded surface of the sand grain in the centre of each mass of silica. Quartzites frequently contain small amounts of other minerals, especially feldspar and mica, and thus grade into other varieties of metamorphic rocks (q.v.).

QUARTZ VEIN. A term applied to a fissure filled with quartz. Such veins are usually formed by precipitation from solution, but may be of igneous origin. The quartz material of the vein when pure is crushed and used for glass manufacture, as a wood filler, for pottery and other purposes. At times the quartz carries gold or other metals and is valuable as an ore. See ORE DEPOSITS.

QUASI (Lat., as if, as it were) **CONTRACT.** This is a generic term in law, of modern origin, invented to denote all those obligations to pay money which do not arise from either true contract or tort. (See **CONTRACT.**) The distinction between true contracts and quasi contracts lies in the source of the two classes of obligations. All true contracts are founded upon intention, there being no true contract which does not result from the intention and meeting of the minds of the parties to it. Quasi contracts, on the other hand, do not depend upon the intention of the parties; but they are obligations to pay money imposed by law without reference to the intent or consent of the party whose legal duty it is to perform the obligation.

The term 'implied contract' as used in earlier classifications of contracts was applicable either to a real contract, that is one flowing from intent, which might be inferred from the acts of the parties, the term 'implied' being used as a mere term of evidence; or it might signify a so-called contract implied in law, which was not a true contract, but a quasi contract.

Quasi-contract obligations resemble torts in that both are obligations imposed by law; but, while in general the duty imposed by the law of tort is to forbear, a quasi-contract obligation imposes the duty of action, namely, the payment of a definite sum of money. A tort also is in general the violation of a right *in rem*, for which the wrongdoer must respond in damages; but the defendant who is liable in quasi contract has either not acted at all, as in case of one who is required to pay a tax or penalty, or if he has acted has done so with the consent and coöperation of the plaintiff, as one who has received money paid by mistake. There is a still further distinction between tort and quasi contract, which has some value, although not of universal application. While the liability of the tortfeasor is to pay damages for the injury which the plaintiff has suffered from his tortious act, the liability in quasi contracts is generally the restoration to the plaintiff of money or the money value of property which the defendant has secured at the plaintiff's expense and which upon legal or equitable grounds should be returned to him. Thus the remedy for negligent injury of the plaintiff's property is a tort action. The remedy for appropriation of the plaintiff's property by the defendant may be an action in quasi contract to recover the value of the property, or, as will appear, the plaintiff may seek his remedy in tort to recover damages for its conversion, the same act giving rise to an action

either in quasi contract or tort at the election of the plaintiff.

As will appear, also, many quasi-contract actions which are based on the plaintiff's right to compel the restitution of money or the money value of property rest upon purely equitable doctrines, although the remedy is pursued at law. The reason for this is historical. Inasmuch as the relief sought in a quasi-contract action was always a money judgment, and as by the extension of the use of *indebitatus assumpsit* the plaintiff using that form of action might show any state of facts entitling him to recover, the machinery of the law courts was, or rather became, perfectly adapted in preference to equitable doctrines when the only relief sought was the recovery of money.

The following is a classification of quasi-contractual obligations which has been followed to some extent, and which, although not free from criticism, is perhaps as satisfactory as any which has been suggested:

Quasi contracts may be said to be founded: (1) upon a record; (2) upon statutory or official or common-law duty; (3) upon the doctrine that no one shall be enriched at the expense of another.

(1) It is clear that record obligations or judgments are not true contracts, since they are imposed without the consent of the judgment debtor and properly form one distinct class of quasi contracts.

(2) The second class includes all obligations to pay money imposed by some positive rule of law, whether by statute or common law. It includes the obligation to pay penalties imposed by statute, the obligation of a sheriff to pay the proceeds of a levy to the judgment creditor, the obligation of an infant or lunatic to pay for necessities, the obligation of a husband to pay for necessities supplied to his wife—being examples of true quasi contract.

(3) The third class embraces all other recognized quasi contracts, and in all there is present the element of unjust enrichment of the defendant at the plaintiff's expense. It cannot be said, however, that unjust enrichment is a definite rule or principle of decision such that a plaintiff is entitled to recover in every case of unjust enrichment at his expense. The scope of this subdivision of quasi contracts will be best understood by referring briefly to more important groups of quasi contracts included within it.

MONEY PAID BY MISTAKE. It is a general rule that money paid or the value of property delivered to another under mistake of fact may be recovered in a quasi-contract action. If, however, the mistake is one of law, no recovery is allowed.

WAIVER OF TORT. As has already been said, there are certain circumstances under which one who has suffered injury by the tortious act of another may at his election sue either in tort or quasi contract. As the remedies are not concurrent, the election of the plaintiff to sue in *indebitatus assumpsit* or quasi contract is said to be a waiver of the tort. Strictly this is a misuse of terms. The plaintiff still relies on the tortious act of the defendant as the basis of recovery, but he will not then be allowed to resort to an action in tort. The basis of recovery upon theory of waiver of tort is restitution, the return to the plaintiff of the money value of

property taken from the plaintiff by the defendant's tortious act. Torts therefore give rise to quasi contracts only when the tortfeasor has by his wrongdoing enriched himself at the expense of the plaintiff. Thus, if the defendant's tort consists in merely the injury to or destruction of the plaintiff's property without direct benefit to the defendant, the sole remedy is in tort.

THE PLAINTIFF IN DEFAULT UNDER A CONTRACT. In general a plaintiff who is in default under a contract has no right either upon the contract or in quasi contract. If, however, performance by the plaintiff has become impossible and the contract is one which may be said to contemplate impossibility of performance so that the impossibility is an excuse for the plaintiff's non-performance, he may recover in quasi contract the value of the performance which he has already given under the contract. Thus in contracts for personal service, if one is unable to perform because of sickness or death, he or his estate is entitled to recover the reasonable value of services rendered, up to the time of the impossibility of performance. When the plaintiff is in default under a contract which the courts will not enforce because it is illegal, he may recover the actual value of his performance already rendered if the contract is *malum prohibitum* (q.v.) only, but in case of contracts *malum in se* the law leaves the parties to it without relief.

THE DEFENDANT IN DEFAULT UNDER A CONTRACT. When a defendant is in default under a contract because performance by him has become impossible, the plaintiff is entitled to recover in quasi contract for benefits conferred by him upon the defendant provided the defendant's failure to perform is total, or if partial only it may be apportioned to the excess of benefits given by the plaintiff; and this is permitted irrespective of the liability of the defendant to respond in damages for breach of contract. Thus freight money paid in advance may be recovered from the carrier if performance by him becomes impossible; or if one has paid in advance for the personal services of another who is unable to perform because of sickness or death, he may recover in quasi contract the proportion of the compensation remaining unearned. The same rule of recovery is applied whenever the defendant is willfully or inexcusably in default under his contract under such circumstances that he may be said to have abandoned the contract. In case the defendant is in default under a contract which is illegal, the plaintiff's right of recovery in quasi contract depends upon the character of the contract. If the contract is *malum in se* there can be no recovery in quasi contract. If it is *malum prohibitum* there can still be no recovery if the plaintiff is in equal wrong (*in pari delicto*) with the defendant. If, however, the plaintiff is not *in pari delicto*, he may recover the value of the performance which he has given to the defendant under his contract.

In general, whenever a defendant is in default under a contract which cannot be enforced because it does not comply with the statute of frauds, the plaintiff may recover the money value of the performance which he has given to the defendant under his contract. The measure of recovery, as in all other cases of quasi contract, is the value of the benefit conferred on the defend-

ant by the plaintiff, and not necessarily the contract price.

In all cases the basis of recovery is the duty of the defendant to restore to the plaintiff money or money value of property which he has received at the plaintiff's expense and which upon legal or equitable grounds he should return to the plaintiff. Consult Keener, *The Law of Quasi Contracts* (New York, 1893).

QUA'SIMO'DO, *Fr. pron. ká'zè'mò'dò'*. In Hugo's *Notre Dame de Paris*, the hunchback bell-ringer of Notre Dame, so named by Archdeacon Frollo, who found him on Quasimodo Sunday. His love for the gypsy Esmeralda led him to save her from punishment as a witch and to give her an asylum in the cathedral. When she was enticed away by Frollo and finally abandoned by him to death for witchcraft, Quasimodo threw Frollo from the cathedral battlements, and died in the cave where Esmeralda's body had been cast.

QUASSIA (Neo-Lat., from *Quassi Coissi*, name of a Surinam slave who used its bark as a remedy for fever). A genus of trees and shrubs of the natural order Simarubaceæ. *Quassia amara*, a native of tropical America, is a shrub 10 to 15 feet high, with racemes of bright-red flowers, and large pinnate leaves, with remarkably winged and pointed leafstalks. The wood, and particularly that of the root, is intensely



QUASSIA.

bitter, and was formerly used in medicine under the names of quassia-wood, bitterwood, etc. Cabinet work made of it is free from insect attacks. The wood of *Picraea excelsa* (see BITTERWOOD) is used as a substitute for quassia to increase the bitterness of beer, being cheaper than hops. Beer so made is said to become muddy and flat.

QUATERNARY PERIOD (Lat. *quaternarius*, consisting of four, from *quaterni*, four each, from *quattuor*, four). A term employed to characterize the Post-Tertiary strata. See PLEISTOCENE PERIOD.

QUATERNIONS (Lat. *quaternio*, group of four, from *quaterni*, four each). A branch of mathematics invented by Sir William Rowan Hamilton (q.v.) in the first half of the nineteenth century. It extends the idea of complex numbers (see COMPLEX NUMBER) to three-dimensional space, and besides being interesting as a

branch of pure mathematics, it finds numerous applications in physics. The first concept peculiar to the quaternion theory is that of *vector*. A line-segment AB has not only length, but

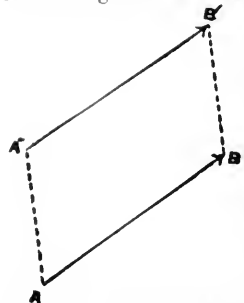

also direction, and two line-segments AB, A'B' are considered equal when they have the same absolute length and the same direction, e.g. in the parallelogram ABB'A', AB, A'B' are called *vectors* (Latin, *vectores*, carriers), because they are considered as 'carrying' the points A, A' to the points B, B', respectively.

It is therefore evident that a vector may be transported parallel to its original position without alteration in character, and hence that it may be considered as a symbol of translation. The sum of two vectors, AB and BC, is considered to be that vector which carries A to C, viz. AC. This does not mean that the absolute value of AB plus that

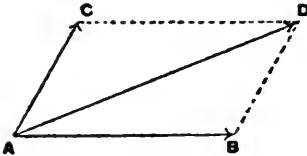
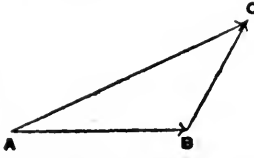

of BC equals that of AC, but that (direction being also considered) a force AB plus another

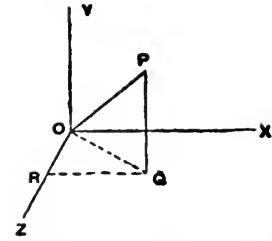

BC, or AB + AC in the figure, equals the force AD. It is therefore evident that, with this definition of addition, the sum of the sides of a triangle or of any other closed polygon, considered as vectors, is zero. Therefore, if we have three given

rectangular vectors, OX, OY, OZ, and OP, any other vector, OP, can be resolved into three vectors respectively, parallel to (hence equal to parts of) OX, OY, OZ. These are RQ, QP, OR; for OR + RQ = OQ, and OQ + QP = OP, as above explained. If, now, we lay off units on OX, OY, OZ, and designate them respectively by i_1, i_2, i_3 , or, as is more common in

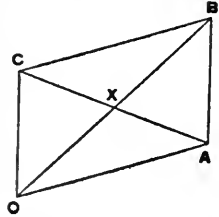

English works, by i, j, k , and designate OP by ρ , we shall have $\rho = xi + yj + zk$, the absolute length of ρ being $\sqrt{x^2 + y^2 + z^2}$. These geometric ideas are elementary, and had already been used by Möbius (q.v.) in his barycentric calculus before Hamilton invented quaternions. A few illustrations of their use will be of value. Let

OABC be a parallelogram, the diagonals intersecting at X: then

$$\begin{aligned} \text{OX} + \text{XA} &= \text{OA} = \text{CB} = \text{CX} + \text{XB}, \\ \therefore \text{OX} - \text{XB} &= \text{CX} - \text{XA}; \end{aligned}$$

but vectors cannot be equal unless parallel, and OXB intersects CXA; hence in the last equation

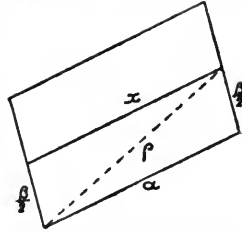

it is necessary that $\text{OX} - \text{XB} = 0 = \text{CX} - \text{XA}$, and hence that $\text{OX} = \text{XB}$ and $\text{CX} = \text{XA}$. It is thus proved that the diagonals of a parallelogram bisect each other. Suppose a, β are two adjacent sides of a parallelogram, and X a line

joining the mid-points of two opposite sides, then it is required to prove that x is parallel and equal to a . Drawing ρ it is seen that $\rho = \frac{\beta}{2} + x = a + \frac{\beta}{2}$, whence $x = a$, which (considering x and a as vectors) shows them to be equal and parallel.

Consider, now, what is meant by the ratio of two vectors OA and OB, or rather on how many distinct numbers this ratio depends. To change OA into OB requires in general, (1) a variation in length, or the application of a stretching factor; (2) a variation in direction, which requires three angles. Hence the required ratio depends upon four distinct numbers, whence the name *quaternion*. The term may be defined as a number that alters a directed line-segment in length and direction. The stretching factor is called the *tensor* and is indicated by prefixing T to a quaternion. The turning factor is called the *versor* and is indicated by prefixing U. A scalar is a quaternion whose product lies on the same line as the multiplicand, and hence is merely a positive or negative number. A *vector* is a quaternion that turns 90° , or $\frac{1}{2}\pi$. The symbol for tensor of a quaternion is Tq; for versor

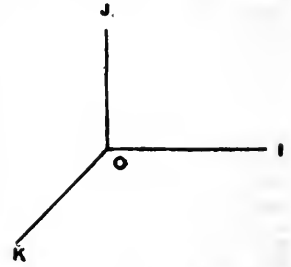

of a quaternion, Uq; for scalar, Sq; for vector, Vq. The *conjugate* of a quaternion q , written Kq, has the same tensor, plane, and angle, but the angle is reversed. Suppose I, J, K to be unit lengths on rectangular coördinates as in the figure. These are so situated that a positive (counterclockwise) rotation, through 90° , of J about I brings J to K; a similar rotation about K brings I to J; a similar rotation about J brings K to I. Call the operator that turns K into J, i ; i.e. $i = \frac{K}{J}$, or $iJ = K$. Similarly, let $j = \frac{I}{K}$, or $jK = I$; and $k = \frac{J}{I}$ or $kI = J$. It therefore follows that $-\frac{J}{K} = i, -\frac{I}{J} = j, -\frac{K}{I} = k$. Hence $-J = iK = i(iJ) = i^2J$, or $-1 = i^2$. Similarly $-1 = j^2$, and $-1 = k^2$. Also, since $iK = i(jI) = -jI$, and $iK = -J = -kI$, it follows that $-jI = -kI$, or that $ij = k$. Similarly $jk = i, ki = j$. A similar line of reasoning

shows that $ji = -k, kj = -i, ik = -j$, whence

$$\begin{aligned} ij &= -ji = k, \\ jk &= -kj = i, \\ ki &= -ik = j. \end{aligned}$$

These relations, together with the consequent equation $ijk = -1$ and the relation already mentioned, that $i^2 = j^2 = k^2 = -1$, form the basis of the quaternion theory. They show at once that in this theory multiplication is not commutative.

To illustrate the application of quaternions, let $a = xi + yj + zk$, and $\beta = x'i + y'j + z'k$. Then $a\beta = -(xx' + yy' + zz') + (yz' - zy')i + (zx' - xz')j + (xy' - yx')k$, and $\beta a = -(x'x + y'y + z'z) - (yz' - zy')i - (zx' - xz')j - (xy' - yx')k$. Hence $Sa\beta = S\beta a$ (i.e. the scalars are equal), $Va\beta = -V\beta a$ (i.e. the vectors are opposites), and $a\beta + \beta a = 2Sa\beta$. Now $(a + \beta)^2 = a^2 + a\beta + \beta a + \beta^2 = a^2 + 2\delta a\beta + \beta^2$, which is the ordinary trigonometric formula for $c^2 = a^2 - 2ab \cdot \cos C + b^2$. Also $V(a + \beta)(a - \beta) = Va^2 - Va\beta + V\beta a - V\beta^2 = -Va\beta + V\beta a$, because $Va^2 = -Va^2$

and hence is zero; and this equals $= 2Va\beta$. Taking the tensors of both sides of the equation $V(a + \beta) = -2Va\beta$, we have the theorem: The parallelogram whose sides are parallel and equal to the diagonals of a given parallelogram has twice the area of the latter. Furthermore $\delta(a + \beta)(a - \beta) = a^2 - \beta^2$, and vanishes only when $a^2 = \beta^2$, or $\tau a = \tau \beta$; whence the diagonals of a parallelogram are perpendicular to each other when and only when the sides are all equal. The chief application of quaternions, however, is in physical problems, and for these reference must be made to works upon the subject. It is evident that the complex number admits of still further generalization, to the form $a = a_1i_2 + a_2i_3 + a_3i_4 + \dots + a_{n-1}i_{n-1} + a_ni_n$. This theory has been developed by Weierstrass (*Göttinger Nachrichten*, 1884-86), Schwarz, Dedekind, Hölder, and others.

The leading works on quaternions and the related *Ausdehnungslehre* of Grassmann (q.v.) are the following: Grassmann, *Ausdehnungslehre* (1844); Hamilton, *Lectures on Quaternions* (Dublin, 1853); *Elements of Quaternions* (London, 1866; 2d ed. 1899); Taft, *Elementary Treatise on Quaternions* (Oxford, 1867); 2d ed. 1873; Hoüel, *Théorie des quaternions* (Paris, 1874); Laisant, *Méthode des quaternions* (Paris, 1881); McAulay, *Utility of Quaternions in Physics* (London, 1893).

QUATRIN, kwót'rân (Fr. *quatrain*, from *quatre*, from Lat. *quattuor*, four). A name given (originally by the French) to a little poem of four verses (lines) rhyming alternately, or even sometimes to four verses of a longer poem, such as a sonnet, if they contain a complete idea within themselves. Epigrams, epitaphs, proverbs, etc., are often expressed in quatrains.

QUATRE-BRAS, kâtr' brâ. A village in the Province of Brabant, Belgium, about 19 miles southeast of Brussels (Map: Belgium, C 4). It is situated at the intersection of the great roads from Brussels to Charleroi, and from Nivelles to Namur, whence its name. On June 16, 1815, two days before the battle of Waterloo, Quatre-Bras was the scene of a desperate and sanguinary battle between the British and their German allies under Wellington and the French under Ney, in which the former were victorious.

The severe defeat of Blücher the same day at Ligny rendered Wellington's hard-won victory almost valueless; and the British commander retired next morning through Jemappes to Waterloo in order to keep up his communication with the Prussian army. The Duke of Brunswick, commanding the German troops, was killed in this battle. See WATERLOO.

QUATREFAGES DE BRÉAU, kâ'tr'fâzh' de brâ'ô', JEAN LOUIS ARMAND DE (1810-92). A French naturalist, born at Berthezène (Gard). He was educated at Strassburg, where he obtained a doctorate in medicine in 1832, began practice at Toulouse, and established there the *Journal de médecine et de chirurgie de Toulouse*. From 1838 to 1840 he was professor of zoölogy in the faculty of sciences of the University of Toulouse, and from 1842 was at Paris, where he designed plates for the *Régne animal illustré*, wrote for the *Revue des Deux Mondes*, in 1850 was appointed professor of natural history at the Lycée Napoleon, Paris, and in 1855 professor of anthropology at the Musée d'Histoire Naturelle. He was elected to the Academy of Sciences in 1852. He was a noteworthy teacher, and became particularly known for his anthropological investigations and his studies of the invertebrates, especially the annelids. The doctrine of phleboterism, according to which the intestinal ramifications of a certain division of gastropods, known as Phleboterata, have a respiratory function, was first expounded by him. He published an extensive list of works, including: *Souvenirs d'un naturaliste* (1854); *Histoire naturelle des annelés marins* (1865); *La race prussienne* (1871), which involved him in a scientific controversy with Virchow; *Hommes fossiles et hommes sauvages* (1884); and *Introduction à l'étude des races humaines* (2 vols., 1887-89), considered his most important publication. For a complete list of his works, consult Malloizel, Godefroy, *Liste chronologique des travaux de M. Armand de Quatrefages de Bréau* (extrait du bulletin de la Société Naturelle d'Autun) (Autun, 1893).

QUATREFOIL (OF. *quatrefeuille*, from *quatre*, from Lat. *quattuor*, four + *feuille*, from Lat. *folium*, leaf). An heraldic bearing meant to represent a flower with four leaves. See HERALDRY.

QUATREMÈRE, kâ'tr'mâr', ETIENNE MARC (1782-1857). A learned French Orientalist, born in Paris. He studied at the College de France under the celebrated Arabist Silvestre de Sacy, and in 1807 was employed in the manuscript department of the Bibliothèque Impériale. In 1809 he became professor of Greek in the College of Rouen, and in 1815 was elected a member of the French Institute. In 1819 he was called to the chair of Hebrew in the Collège de France, and in 1838 was made professor of Persian in the school for modern Oriental languages. He died at Paris. Quatremère's earliest works were devoted to Egyptian subjects. In his *Recherches critiques et historiques sur la langue et la littérature de l'Égypte* (1808) he demonstrated that Coptic is the true representative of ancient Egyptian, but he later declined to accept the discoveries of Champollion, and would never admit that the Egyptian hieroglyphics could be read phonetically. His geographical and historical works are of very great value, especially

his *Mémoires géographiques et historiques sur l'Égypte* (1811); his *Histoire des sultans Mamelouks* (1837-45), translated from the Arabic of Makrizi; and his *Histoire des Mongols de la Perse* (1836), from the Persian of Rashid-Eddin. He was the author of many valuable articles in the *Journal Asiatique* and the *Journal des Savants*, and he edited the Arabic text of the *Prolegomena of Ibn-Khaldun* (1858). His *Mélanges d'histoire et de philologie* was published after his death by Barthélemy de Saint-Hilaire. Quatremère's library (45,000 volumes), his Arabic manuscripts, and his manuscript notes were purchased by the King of Bavaria; they are now in the royal library at Munich.

QUATREMÈRE DE QUINCY, kân'sé'. ANTOINE CHRYSOSTOME (1755-1849). A French archaeologist and politician, born in Paris. He was actively concerned in the events of the French Revolution, and occupied various political positions during the Republic, Consulate, and Empire. He became intendant of arts and public monuments in 1815, perpetual secretary of the Academy of Beaux-Arts in 1816, editor of that department in the *Journal des Savants*, and was Deputy in 1820-21. His chief works are: *Dictionnaire de l'architecture* (3 vols., 1786-1825); *Jupiter olympien, ou l'art de la sculpture antique* (1814); *Histoire de la vie et des ouvrages de Rafaël* (1824); *Monuments et ouvrages d'art antique restitués* (2 vols., 1826-28); *Histoire de la vie et des ouvrages des plus célèbres architectes*, etc. (1830); and *Canova et ses ouvrages* (1834).

QUATRE-VINGT-TREIZE, kâ'tr' vān trāz (Fr., ninety-three). The last novel of Victor Hugo (1874) and one of his best works. The action takes place principally in La Vendée in 1793, though a part of the book describes scenes in Paris and the Convention. It depicts, in a really epic spirit, the great conflict between the old régime and the new on their last battlefield in the west of France, and the clash of human passions aroused by this conflict.

QUAVER. In music, an eighth note. Its measure is equal to half a crotchet, one-fourth of a minim, or one-eighth of a semibreve. It is

represented thus:  ; or when two or

more are conjoined, thus: 

QUAY. A landing place or wharf for unloading vessels, often supplied with mechanical devices for the loading and discharging of cargoes. Quays usually are of masonry, though they may be constructed of wood or iron on piles, but in such cases the term wharf is generally applied. In Europe such structures have been more permanently constructed than in the United States, and often elaborate systems of railways connect the various docks with each other and with the principal railway systems. There are also steam, hydraulic, or electrical cranes to facilitate the handling of the cargoes, and in the best docks a vessel comes alongside of the quay and the cargo is removed directly to or from railway cars or warehouses. See DOCK; HARBOR.

QUAY, kwā, MATTHEW STANLEY (1833—). An American politician, born in Dillsburg, York County, Pa. He graduated at Jefferson College

in 1850, studied law, and was admitted to the bar in 1854. During the Civil War he was successively assistant commissary-general of the State, colonel of the 134th Pennsylvania Regiment, State military agent at Washington, and military secretary to the Governor. He was a member of the Legislature from 1865 to 1867; was Secretary of State for Pennsylvania from 1872 to 1878; was Recorder of Philadelphia from 1878 to 1879; was again Secretary of State from 1879 to 1882; was elected State Treasurer in 1885; and was chosen United States Senator in 1887. He was for years the most influential of the Republican politicians in Pennsylvania, and also took a very active part in national politics. In 1888 he was chairman of the Executive Committee of the Republican National Committee, and as such conducted the successful Presidential campaign of that year. He was re-elected to the Senate in 1893, but failed to succeed himself in 1899, because of a deadlock which lasted throughout the session of the Legislature. His failure was partly due to an accusation that he had been instrumental in the misapplying of public funds. After he had been acquitted he was appointed Senator *ad interim* by the Governor, but the Senate refused to recognize the appointment. He was, however, nominated to succeed himself by the Republican State Convention, and in 1901 was reelected for the term to expire in 1905. In 1902-03 he attracted attention by his championship of the admission of New Mexico, Oklahoma, and Arizona to Statehood, and by his opposition to the Panama Canal Treaty.

QUAYLE, kwā, WILLIAM ALFRED (1860—). An American Methodist clerical author and educator. He was born in Missouri soon after his people came to the United States from the Isle of Man; he graduated at Baker University, Baldwin, Kan., in 1885; and became adjunct professor of ancient languages, 1885; professor of the Greek language and literature, 1887-90; and president of the university, 1890-92. He entered the pastorate in the Saint Louis Conference on his resignation, and has since been pastor of large churches in Kansas City and Indianapolis. He is widely known as an eloquent lecturer. He has published: *The Poet's Poet and Other Essays* (1897); *A Hero and Some Other Folks* (1900); *The Blessed Life* (1901); *The Gentleman in Literature* (1887-92); *Hero: Jean Valjean* (1902); *In God's Out of Doors* (1902); *King Cromwell* (1902).

QUEBEC, kwè-bèk', formerly LOWER CANADA. One of the eastern provinces of the Dominion of Canada. Its greatest east and west measurement is nearly 1000 miles, that from north to south, 500 miles. It touches Hudson Bay on the northwest, its boundary extending thence slightly northeast to Hamilton Inlet on the Atlantic coast, a strip of Labrador separating Quebec from the open sea. The province borders for about 400 miles on the Gulf of Saint Lawrence. A long strip of its territory lies south of the Saint Lawrence River and borders three of the New England States and the northeast corner of New York. On the southwest the Ottawa River separates the province from Ontario. The remainder of the boundary on the side of Ontario is formed by a line running due south from the southern extremity of Hudson Bay to the Ottawa River.

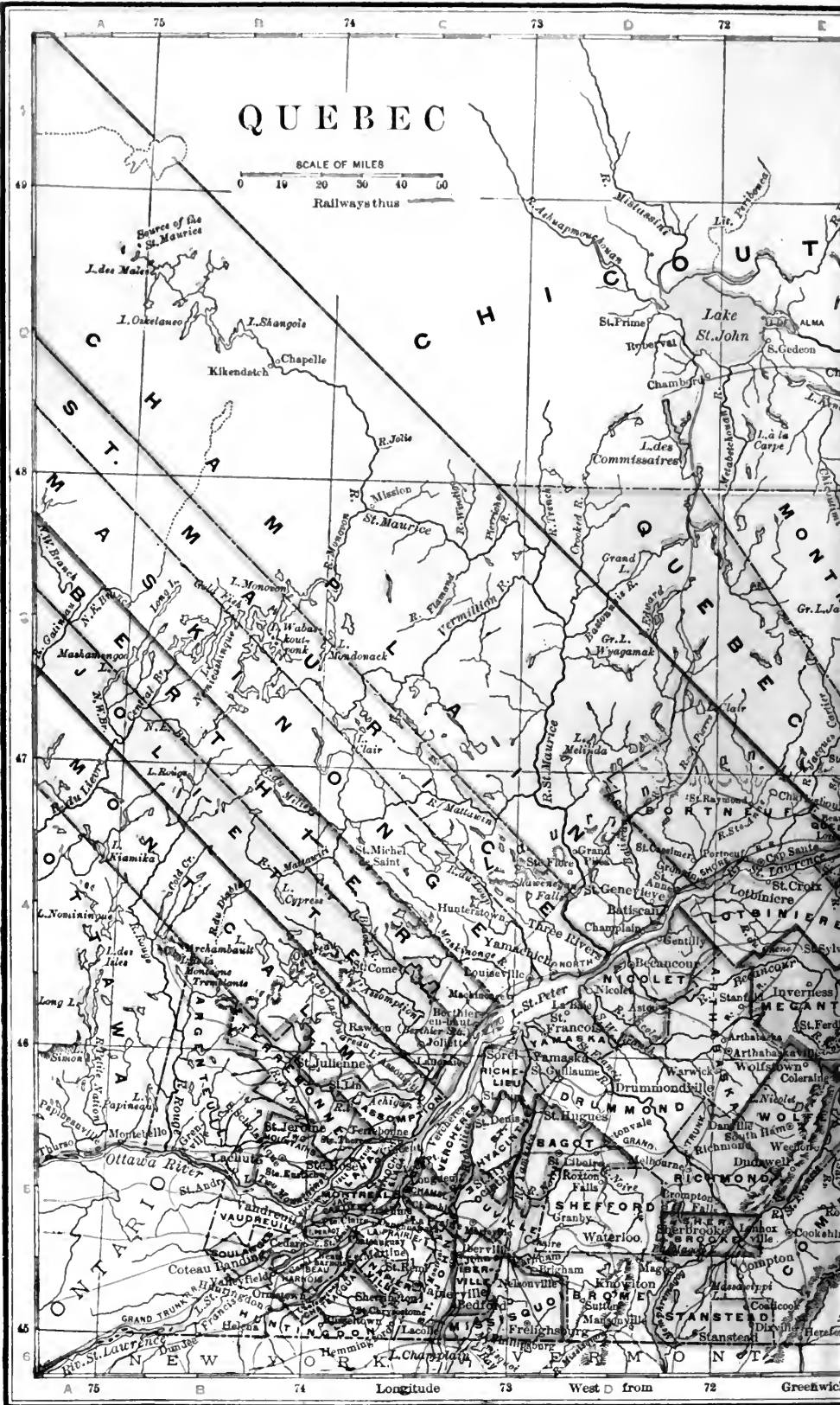

QUEBEC

SCALE OF MILES
0 10 20 30 40 50
Railways thus

Longitude 72 West D from Greenwich

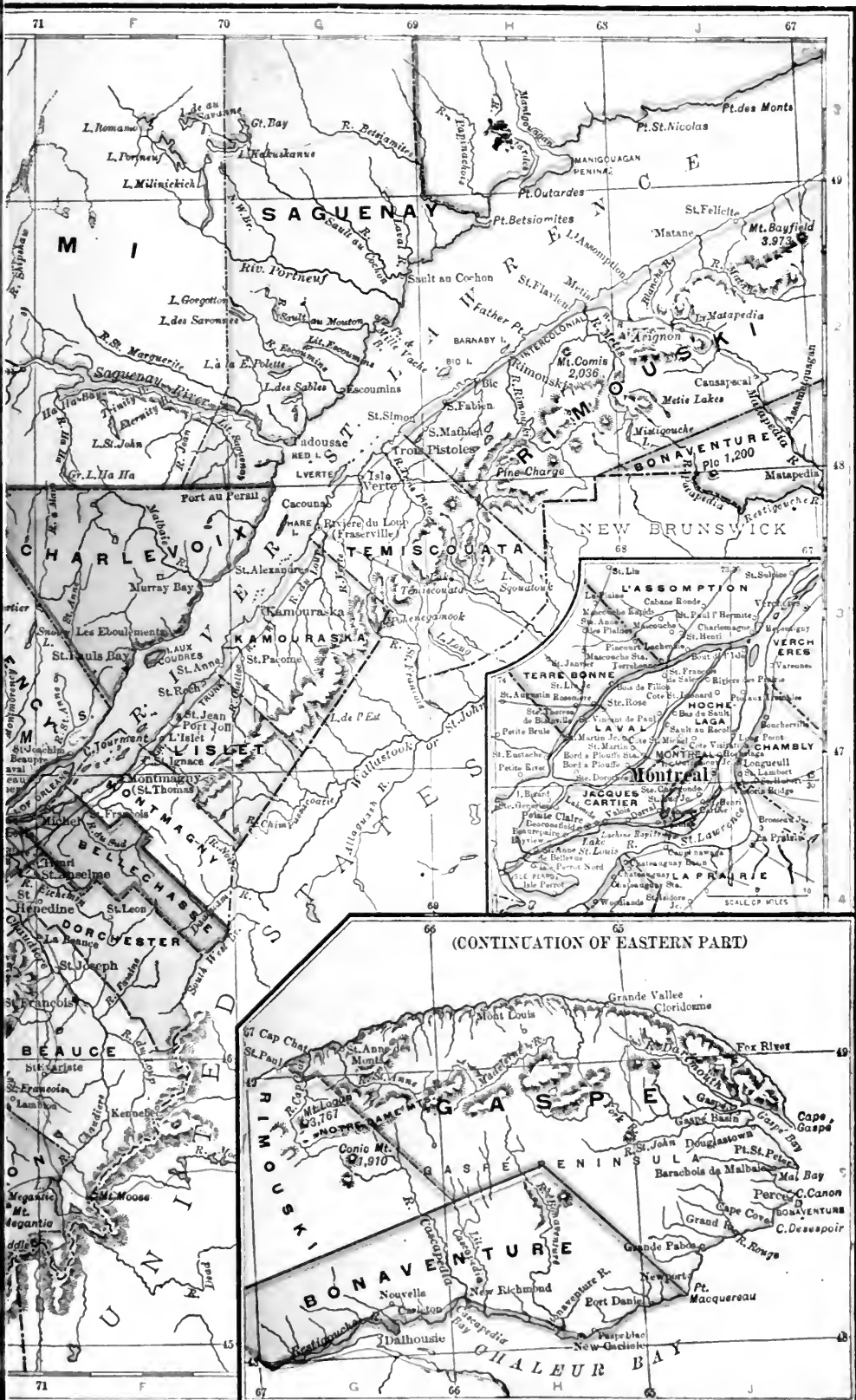

(CONTINUATION OF EASTERN PART)

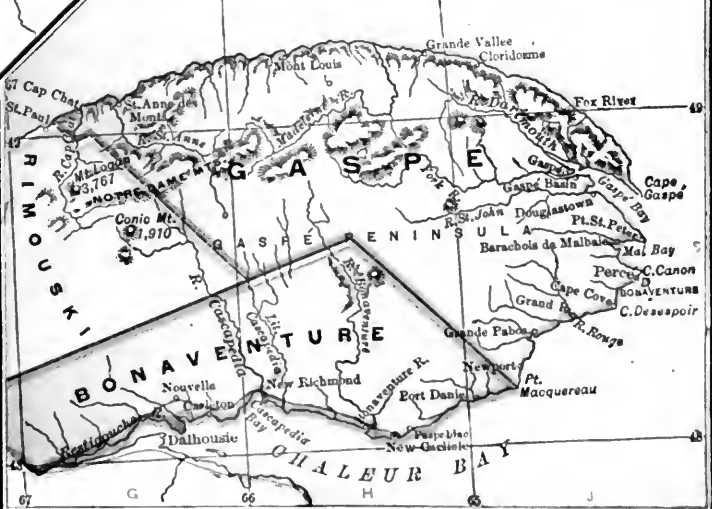

There are 344,450 square miles of land area and 2900 of water area, exclusive of the Gulf of Saint Lawrence and the territorial seas.

PHYSICAL CHARACTERISTICS. Physically and geologically, Quebec is divided into three parts. Almost all the vast region to the north of the Saint Lawrence is a portion of the so-called Laurentian Plateau, which belongs to the most ancient geological era (Archaean). This is a barren, rocky, undulating region, the hills oft-times standing out in great boldness, but nowhere reaching a high elevation. The highest portion—the Height of Land—constituting the watershed between the river systems, scarcely exceeds 1000 feet in the west, but becomes gradually higher to the eastward, averaging 1700 feet in the centre of the Labrador peninsula. The second division consists of the narrow strip of lowlands on either side of the Saint Lawrence west of Quebec. Here the general level rises but a few hundred feet above that of the sea, except where the later strata are pierced by rocks of igneous formation, which in a few instances rise quite high, Mount Royal at Montreal being the best known of these. To the eastward of these lowlands the strata have been violently upheaved, the line of dislocation running from Lake Champlain to Quebec, and thence following the estuary of the Saint Lawrence, the disturbed area occupying the greater portion of Quebec south of the Saint Lawrence, and constituting the third division. It is a part of the so-called Acadian region. This is simply the northern extremity of the great Appalachian mountain chain. This portion of Quebec is broken and hilly throughout, rising nearly 4000 feet in Sutton Mountain, in the Notre Dame range.

The greater portion of the province is drained by the Saint Lawrence River system. This river has been the all-important factor in the history and development of the province. The numerous southern tributaries are short, the northern tributaries longer, but, owing to the frequent falls and rapids along their courses, they are of little value to navigation. These features, together with the precipitous channels through which the streams flow, and the ruggedness of the adjacent highlands, combine to produce grand scenery which annually attracts thousands of tourists, the Saguenay River being the most frequented. The most important southern tributary is the Richelieu. It drains Lake Champlain. The region north of the Saint Lawrence has numerous water-covered areas which vary from swampy lands to lakes of considerable size—the Saint John and the Mistassini being the most important. The island of Anticosti, at the mouth of the Saint Lawrence, and the Magdalen group, north of Prince Edward Island, are the most important of the large number of islands which belong to the province.

CLIMATE. The winters in Quebec are long and cold; the summers warm, though not to excess. The mean annual temperature ranges from 45° at Montreal to 29° in southern Labrador. The annual precipitation in the Saint Lawrence valley is quite adequate for agricultural purposes. The air is in general remarkably dry and free from fog, and therefore extremely healthful and bracing, not even the extremes of the winter's cold being intolerable. The deep winter snows last from November to April (except in the farthest district south), and afford a necessary

protection for the vegetation against the winter's cold. They are especially welcomed by the lumberman, as he is thereby enabled to get his supply of logs to the banks of the streams.

MINERALOGY AND MINING. The province is favored with large mineral resources, but has not yet reaped any great benefit therefrom. Like Ontario, Quebec is unfortunate in not possessing coal. The tariff levied by the United States practically prohibits the exportation of ore into that country. The southeast portion of the province is most productive of mineral wealth, and has recently become noted for its asbestos mines, which yield practically all the asbestos marketed in the world. In 1900 the product exceeded \$700,000 in value, and averaged annually more than \$400,000 between 1890 and 1900. Iron is mined in the region east of the Richelieu River, and is found at various points along the north bank of the Saint Lawrence and farther west in the region of Ottawa. During recent years the annual output of iron ore has averaged about 20,000 tons. For a long time small quantities of gold have been taken from the gravels of the Chaudière River. Platinum also exists in these gold placers. The southeast townships abound in cupriferous pyrites, and considerable copper is mined, the product being used for the manufacture of sulphuric acid. Plumbago is found near Ottawa, and phosphate and mica exist to the northward. Lead is found farther west and north along the course of the Ottawa River. Some graphite and small quantities of gems of inferior quality have been placed upon the market. The limestone of the eastern counties has been liberally drawn upon for building purposes, but its greatest use and service have been in the production of lime, the output of which has reached \$400,000 for a single year. Granite is quarried in the counties adjacent to Vermont and New Hampshire, while just to the north of this section slate is quarried in considerable quantities. Peat is found in inexhaustible quantities, but has not yet come into use.

FISH AND FURS. Fishing is an important occupation. In common with the other provinces Quebec enjoys the benefits of the bounty given by the Dominion Government for engaging in sea fishing. Latterly the returns show that the number of men engaged in boat fishing has annually exceeded 7000. The vessel fishing is of small and decreasing importance. The annual catch approximates \$2,000,000 in value, the income from the cod fisheries constituting more than one-third of this amount. Herring, lobster, and salmon are next in importance. Quebec still furnishes the world's market with a valuable quota of furs, but in certain regions the fur-producing animals have become almost or quite extinct. Moose and deer in the south, and cariboo in the north, not to mention smaller varieties of game animals, are still abundant, but these, too, are rapidly being killed.

FORESTS. In the Ottawa and Saint Lawrence valleys and the highlands south of the Saint Lawrence there is a mixed forest such as is typical of the New England States to the south. Here are found maples, oak, beech, elm, and other hard woods, together with the red and the white pine, the cedar, spruce, birch, and other varieties of evergreens. The region south of the Saint Lawrence

still contains extensive valuable forest areas, as is the case with the Upper Ottawa region. In the highland region to the north the sub-Arctic species of flora prevail, and there are but few varieties, in marked distinction from the southern section. The best forest land lies south of the watershed, and though not equal in value to the forests of northern and central Ontario, is yet very valuable, and is to-day the great lumbering region of Quebec. The tamarack and the spruce occupy the wet boggy lands in the southern portion of this region, becoming common also on the drier lands farther north. The Banksian pine flourishes in the sandy and rocky soil, but is inclined to be scrubby as compared with the noble proportions it attains farther west. It is estimated that one-half the area of the province is still forest or woodland. Arctic flora is well represented along the gulf coast.

AGRICULTURE. Farming is the most important occupation, though cultivation is confined largely to the fertile river valleys. In the cultivated portions the soil is loamy and of great fertility. In the vast stretch of highland north of the Saint Lawrence it varies greatly in richness, much of the region being either swampy or rocky and barren, the barrenness increasing to the northward. The townships adjacent to Vermont resemble that State in physical characteristics, being better adapted to stock-raising than to farming. Formerly this section produced enormous crops of hay for shipment into the States, but more recently dairying has been given great prominence, and the products of the soil are consumed at home. The products of the dairy are now the farmers' greatest source of income. Oats, wheat, and buckwheat are the leading cereals. Potatoes, peas, turnips, and tobacco are each important. Parts of the province are noted for their superior apples and plums, while the hardy varieties of smaller fruits grow everywhere. Stock-raising receives great attention. Farming is not yet extensive on the interior lands north of the Saint Lawrence. South of the watershed the summers are sufficiently warm and the soil in many places is sufficiently fertile to guarantee an extensive agricultural development. This is especially true of the Lake Saint John and the Upper Ottawa regions.

BUSINESS INTERESTS. The navigable Saint Lawrence River has been the determining factor in the development of Quebec. The largest ocean steamers ascend the river as far as Montreal, 500 miles from its mouth. The shipping industry of this port has made it the metropolis of Canada. Here is collected almost the whole of the interior Canadian product which is destined for foreign shipment, to which are added also large quantities of food products from the Northern United States. The navigation of this stream has been greatly improved (as has been also that of its north and south tributaries, the Ottawa and the Richelieu) by the construction of canals at points where their courses are interrupted by rapids. For foreign shipments, see the article on CANADA. The principal export products of Quebec are lumber, beef, apples, and dairy products—butter and cheese.

The construction and maintenance of railroads have been aided by the Dominion, provincial, and municipal governments—the provincial aid

averaging \$15,000,000 annually. The mileage in 1900 was 3414—about half that of Ontario. Most of the lines are south of the Saint Lawrence. The only line running into the northern interior is the one from Quebec to Lake Saint John. Shipbuilding, which was formerly an important industry, has almost entirely ceased. Logs used to be shipped in the rough to British ports, but now numerous sawmills have been established, and the timber is sawed into lumber before shipment. The presence of tanning barks, notably the hemlock, has given rise to an extensive tanning industry. The spruce is being largely manufactured into wood pulp and its products. Boots and shoes are made at Montreal and Quebec. Cottons are also manufactured, and there is an increased trade in printed cotton goods. The manufacture of matches, potash, and other chemical products is of some importance. A number of the river rapids have been utilized in the generation of electrical light and power.

GOVERNMENT. A Lieutenant-Governor, appointed by the Governor-General of Canada, is at the head of the Provincial Government. He is assisted by a council of usually six, who are responsible to the legislative bodies—the Council, with 24 members, and the Assembly, with 74 members. The province sends 24 members to the Dominion House of Commons. For the year ending June 30, 1901, the principal sources of revenue were received from the sale of timber limits (\$1,471,004), Dominion subsidies (\$1,278,987), and liquor licenses (\$661,968), which with other revenues aggregated \$4,563,432. The total expenditure for the same year was \$4,516,258, of which the largest item was \$1,436,510 interest on the national debt.

FINANCES. The principal sources of revenue are the subsidy from the Dominion Government and income from the sale of forests. The total revenue in 1900-01 was \$4,563,432, and total expenditures \$4,516,251. The gross debt in 1902 was \$33,597,659, against which the treasury held assets of \$11,364,132, leaving a net debt of \$22,233,527.

POPULATION. The population of Quebec increased from 1,488,000 in 1891 to 1,621,000 in 1901. This was a much larger rate of increase than is found in any of the other eastern provinces, and was made in spite of a very heavy emigration into the New England States. The gain is accounted for by the unusually large birth rate, the average size of the families being 5.5. The Indians of the province number 10,700, most of whom are well advanced in civilization. Quebec was originally settled by the French, whose descendants still form a large majority of the population. Their race has remained practically intact: it is still French in language, manners, and temperament. This fact is of first importance when the government of the province is considered, and is the predominant factor in almost every phase of its social life. The Eastern Townships received a large number of loyalists from the American colonies during the Revolution.

CITIES. In 1901 the population of Montreal was 266,800; Quebec, the capital, 68,800; Saint Henri, 21,192; Hull, 13,900; and Sherbrooke, 11,700. Montreal is the largest city in the Dominion, and the large number of racial elements represented give it a cosmopolitan air. The population of Quebec is mostly French.

RELIGION. Quebec was first settled by French Catholics and was the centre of the great missionary activity of the Jesuits. The Catholic faith still continues strongly predominant, its adherents outnumbering the Protestants more than 6 to 1. They constitute two-thirds of the total Catholic population of the Dominion. Of the Protestants, the Episcopalians, Presbyterians, and Methodists are strongest.

EDUCATION. The educational system is unlike that of any other Canadian province. As in the case of the others, however, there is a 'Department of Public Instruction' with a superintendent at its head. But the administration is represented by two committees, Catholic and Protestant, having the care of the schools of the respective faiths, prescribing such religious instruction as they see fit, and receiving proportionate support from the public funds. All Catholic bishops are members of the Catholic committee. The individual schools are in the hands of local boards. There were, in 1900, 4980 Catholic schools and 966 Protestant. Each class of schools contains some pupils of the opposite faith, 80 in every 1000 in the Protestant schools being Catholics. The study of agriculture receives special attention. There are one dairy and four agricultural schools. The expense of the public schools averages about \$9 per enrolled pupil. About 11 per cent. of this is met by Government grants, the rest being raised by assessment of the people. The higher institutions of learning are provided by private or denominational enterprise. These are the Laval University (Catholic) at Quebec, with a branch at Montreal; Bishop's University (Anglican), at Lennoxville; and McGill University (non-denominational), at Montreal. The last institution in particular has a wide reputation.

HISTORY. (For the period preceding permanent settlement, see CANADA.) In 1608 Champlain laid the foundations of the colony of Quebec; and as a result of his twenty-seven years of activity in exploring the Saint Lawrence and the Great Lakes as far west as Huron, in cultivating the friendship of the Canadian Indians, and in curbing the power of the Iroquois, there were in Quebec at the time of his death, on Christmas Day, 1635, some 150 colonists, who derived a precarious existence largely from the fur trade. (See CHAMPLAIN, SAMUEL DE.) Champlain's efforts were supplemented in a degree by the work of the Recollet missionaries, who arrived in 1615, and the Jesuits, who came in 1625; but the pitiable condition of the colony for the next thirty years, during which period occurred the failure of the Hundred Associates under Richelieu, clearly proved that no true elements of colonial prosperity could be expected from the initiative of individual Frenchmen. During this period, in 1642, came the founding of Montreal and the laying of the foundation of those religious establishments that under Monseigneur de Laval, the first Roman Catholic Bishop of Canada, assumed the commanding position which they continued to hold while French domination lasted. When, in 1663, Canada was made a royal government, its French population amounted to only 2500, largely centred at Quebec, Montreal, and Three Rivers.

The coming of the Marquis de Tracy in 1665, followed by his successful campaigns against the Mohawks, two years later, was the signal for a

more rapid immigration. Under the *intendant* Talon (q.v.) the colony enjoyed a moderate degree of prosperity. The ablest Governor of this period, whose energy transformed Canada into the semblance of a colonial power, was the Count de Frontenac, whose two terms practically comprised the last three decades of the seventeenth century. Under him the Iroquois were led to respect the French power, while the area for the fur trade was greatly extended; and to accomplish this double purpose Fort Frontenac was established as an outpost on Lake Ontario. In 1690 an English expedition under Sir William Phipps was defeated before Quebec. The total immigration for the years 1663 to 1713, largely from the French provinces of Perche and Normandy, did not exceed 6000, and the population of the territory included within the present Province of Quebec at the latter date was less than 20,000; but Frontenac had made Canada a power to be feared by its English neighbors. The system of seigniorial tenure had built up the nucleus of an agricultural community on the banks of the Saint Lawrence, but the vast forests of the West still attracted the more vigorous spirits of the population and rendered settled conditions of social and political order almost impossible.

The religious Orders were often in sharp conflict with the Government officials, yet their influence on the life of the colony was generally helpful. The Jesuit College at Quebec, founded in 1635, antedated Harvard, and doubtless was largely responsible for the evidence of culture in the cities noted a century later by the traveler Charlevoix, and the Swedish botanist Kalm.

The memorable battle on the Plains of Abraham, September 13, 1759, resulting in the fall of Quebec, which was followed by that of Montreal in the next year, brought Canada under the dominion of England. At that time, of the 60,000 French in the Valley of the Saint Lawrence, 8000 were gathered at Quebec, 4000 at Montreal, and 1000 at Three Rivers, the total population of the three hardly equaling that of Boston. These three cities formed the centres of the judicial districts into which the English divided the colony, with a Superior Council at Quebec. During the eleven years preceding the Quebec Act of 1774, the small English minority petitioned for themselves a representative system, wholly unsuited to the French population, which would have placed all power in their hands. Though their action gave rise to a race antagonism, the evident policy of both the home Government and the local officials was to deal justly with their new subjects and thus secure their good will. This was shown by the liberal terms of the Quebec Act (q.v.). For this reason, largely, all attempts of emissaries from the Continental Congress to stir up the Canadians against England and the expedition of Montgomery and Arnold in 1775 alike failed of their object. Much of the credit of this result is due to the wise rule of Sir Guy Carleton, the Military Governor.

By the end of the Revolution at least 10,000 exiled loyalists had sought the valley of the Saint Lawrence and the region bordering upon the lakes beyond, and they now petitioned for a separate western district. By the terms of the Constitutional Act of 1791 their prayer was granted, but the period down to 1812 was marked by a

growing race hostility in Lower Canada, as Quebec was then called. During the second war between the United States and Great Britain the province suffered little; on the contrary, the general effect was a greater unity of sentiment among the two leading elements of its population, although up to 1836 the relations between the elective assembly and the royal governors were far from cordial. This fact, however, led but few French-Canadians of prominence to take part in the Rebellion of 1837-38, which resulted in the collapse of Papineau's scheme of 'La Nation Canadienne.' (See PAPINEAU, LOUIS JOSEPH.) In the latter year the population of Lower Canada approached 300,000, of whom one-fourth were of British origin, and this element largely controlled the industry of the province. Quebec and Montreal each boasted a population of 35,000.

Following the Rebellion, the two provinces were again united for general purposes by the Act of 1841, and a Parliament of two elective Houses constituted. As there was some opposition to the provision that all debates in this Parliament must be conducted in English, this was shortly repealed in favor of the French representatives from Quebec. By the Act of 1867 Quebec became a part of the Dominion of Canada, of which the course of her leaders has made her a conservative, though consistently loyal member, despite scattered attempts to stir up race feeling during the Riel Rebellion of 1885 (see RIEL, LOUIS) and the recent Boer War. See CANADA.

BIBLIOGRAPHY. Low, "Explorations and Surveys in the Interior of the Gaspé Peninsula," in *Canada Geological Survey Report of Progress* (Quebec, 1883); Coffin, "The Province of Quebec in the Early American Revolution," in *University of Wisconsin Bulletin*, vol. i., No. iii. (Madison, 1896); *Quebec Lands, Forests, and Fisheries* (Quebec, 1898).

QUEBEC. The capital of the Province of Quebec, and the oldest city in Canada, in latitude 46° 48' N., longitude 71° 12' W., 180 miles north-east of Montreal, 430 miles north-northeast of New York (Map: Quebec, E 4). Quebec is situated on a promontory called Cape Diamond, named from the prevalence of quartz, and formed by the confluence of the Saint Lawrence and Saint Charles rivers. Its picturesque position, and the fact that its historical sites have never been defaced and altered, make it one of the most romantic and interesting towns in North America. It resembles a mediæval European town rather than a city in the New World, and, owing to its impregnable aspect, has been termed the Gibraltar of America. Grouped on and below the rocky, precipitous bluff, with its low, irregular buildings and river craft at the base, it presents a quaint appearance. The city is divided into an upper and a lower town. Access to the former, perched high on the precipitous eminence, is obtained by several flights of narrow steps, an elevator, and a steep and winding street. The portion of the upper town near which lie the suburbs of Saint John and Saint Louis is surrounded by a massive wall, but several of the fortifications have been destroyed. Three gates have been removed, the two remaining being Saint Louis and Kent Gate. The summit of Cape Diamond is crowned by a citadel, covering forty

acres, at a height of 333 feet above the level of the river, dating in its present form from 1823, and garrisoned by Canadian militia. The upper town contains the principal residences, churches, buildings, public walks and gardens, and shops. One of its most interesting points is the Dufferin Terrace, a promenade, 1400 feet long and 200 feet above the river, opened in 1879 and affording a fine view. This was constructed on the site of the residence of the early French governors, the Château Saint Louis, destroyed by fire in 1834. In the Governor's garden, overlooking the Saint Lawrence River, stands a monument to the memory of Wolfe and Montcalm, and on the Saint Foye Road an iron pillar surmounted by a bronze statue commemorates the battle of Saint Foye, fought on that site.

Quebec's chief attractions are: the Parliament and departmental buildings; the court-house, custom-house, and city hall; the Masonic hall; the Basilica, formerly the cathedral, with specimens of several of the greatest painters; the Seminary of Quebec; the Laval University, deriving its name from the first Bishop of Quebec, and well equipped with a library, museum, a picture gallery, and scientific apparatus—the largest educational Roman Catholic institution in Canada; and the Ursuline Convent, where Montcalm is buried. Quebec has the Hôtel Dieu Convent and Hospital; Morrin College (Presbyterian), called after its founder and connected with McGill University of Montreal; and the Marine Hospital. There are many educational institutions, several public libraries, and a literary and historical society, founded at Morrin College in 1824, which possesses valuable records and historical manuscripts.

The lower town is the seat of commerce, and much rock has been cut to construct its narrow, irregular streets. Near it are the districts of Saint Roch and Saint Sauveur, containing many manufactories. The chief industry is the shipping of lumber brought in rafts and collected into coves which extend for six miles above the town. The principal manufactures and exports are leather, iron castings, boots, shoes, furs, grain, cattle, musical instruments, cutlery, machinery, nails, india-rubber goods, rope, and steel. Quebec early achieved a reputation for ship-building, and the *Royal William*, one of the first vessels to cross the Atlantic by means of steam alone, was built here in 1831. The rocks and wharves extend three miles from the mouth of the Saint Charles, where the spacious Louise Basin is inclosed by the Louise Embankment, which forms a fine river-front promenade.

Quebec is supplied with water from Lake Saint Charles, and is lighted by electricity, the power for which is obtained from Montmorency Falls, seven miles distant. Quebec sends three members to the Dominion House of Commons and three to the Provincial Legislature.

Interesting localities in the neighborhood include the Plains of Abraham, named after a pilot of the Saint Lawrence who owned this tract of land, and containing a monument to Wolfe in honor of the victory of 1759; Wolfe's Cove, where the British encamped; Près de Ville, where General Montgomery fell in 1775; Montmorency Falls, where Montcalm resisted Wolfe, noted for its beautiful scenery and cataract; Beauport and its asylum; Levis, with its three forts; Lorette (q.v.), with its falls, Indian church, and

Indian settlement; the Chaudière Falls; Saint Anne de Beaupré, a place of pilgrimage, whose church contains relics of Saint Anne, supposed to effect marvelous cures; Château Bigot, an historical house near Charlesburg; Cap Rouge; and Isle d'Orléans, where General Wolfe established his camp prior to the siege of Quebec.

An Indian town named Stadacona occupied part of the present site of Quebec in 1535 when Jacques Cartier explored the Saint Lawrence. An unsuccessful attempt at settlement was made by Sieur de Roberval in 1542-43. Its real founder was Champlain, who established a small trading post here in 1608, and gave it the name of Quebec. In 1629 Sir David Kirke captured the settlement, but it was restored to the French three years later. When the colony was made a royal government in 1663, Quebec became the capital. The English made two unsuccessful attempts to capture it in 1690 and 1711, and through the daring of General Wolfe in 1759 it finally fell into British possession, which has never been interrupted. A fruitless effort was made by the Americans to capture the city by assault on December 31, 1775, when General Montgomery was killed. For several years Quebec was the capital of United Canada, and the famous Confederation Debate took place in the old Parliament House in 1864. The growth and progress of Quebec have not been rapid. The population, in 1881, numbered 62,446; in 1891, 63,090; in 1901, 68,834, five-sixths being French, and Roman Catholics. Consult: Russell, *Quebec as It Was and as It Is* (Quebec, 1860); Parker, *Quebec, The Place and the People* (New York, 1903).

QUEBEC ACT. An act of the English Parliament passed in 1774 providing a government for the Province of Canada, which had been acquired by the Treaty of Paris of 1763. The three features of the act which have called forth the most extended discussion were: (1) the extension of the boundaries of the province so as to include all the territory northwest of the Ohio River and east of the Mississippi, thus confining the Atlantic colonies within the Alleghanies, in spite of their claims to the land to the west; (2) the substitution of the French civil law therein for English law; and (3) the withholding of representative English institutions, such as existed in the other English provinces. The act excited great indignation among English-speaking peoples both at home and especially in the thirteen English colonies. The reason assigned by the English for the extension of the boundaries was the necessity of annexing the Northwest Territory to some civil government in view of the almost anarchical conditions there prevailing; and having reached that conclusion, the Government decided that there were good reasons why it should be annexed to Canada. With regard to the substitution of the French legal system for the English, the Government claimed that on account of the predominance of the French element it was found impossible to put English law into practice except in commercial matters, and as the French customary law had, for the most part, continued undisturbed, the act of Parliament in question merely legalized the existing status. Finally, the English justified the withholding of representative institutions on the ground of the religious difficulties involved. In view of the Roman Catholic majority, it was deemed inex-

pedient to exclude Catholics from the assembly; on the other hand, it was thought unsafe to admit them, and as a consequence an appointed council took the place of a representative assembly. The act was regarded by the English colonists as a blow aimed directly at them, and was a factor in bringing on the Revolution.

For the American view of the spirit and purpose of the act, consult Baneroft, *History of the United States* (New York, 1883-85); for the English view, consult an article in the *Annual Report of the American Historical Association* for 1894 (Washington, 1895).

QUECHUA, kā'chwá. A tribe of South American Indians. See QUICHUA.

QUEDAH, kā'dá, or **KEDAH**. A tributary State of Siam on the west coast of the Malay Peninsula, north of Perak and of the British Province of Wellesley (Map: Siam, D 6). It formerly included the island of Penang and the territory of the Province of Wellesley. Area, 3600 square miles. Population (estimated), 30,000.

QUEDLINBURG, kvéd'lin-bōrk. A city in the Province of Saxony, Prussia, on the Bode, 34 miles southwest of Magdeburg (Map: Prussia, D 3). It preserves in part its ancient walls and towers, and on a rocky height is an old castle, the seat of the famous Abbey of Quedlinburg, founded early in the tenth century by Henry the Fowler, King of Germany, the first four abbesses of which were daughters of German emperors. The Abbey of Quedlinburg, with its district, constituted a State of the German Empire down to 1803. It became Protestant in 1539. The abbey church, restored in 1862, with its mediæval relics, is of great interest, and there are other noteworthy ecclesiastical remains, an ancient town-hall, and fine sculptural monuments, including statues of Klopstock and Karl Ritter, who were born here. Quedlinburg is the centre of the second largest seed-producing district in Germany, and manufactures machinery, aniline dyes, starch, cloth, and wire goods. There is a large annual cattle market. Quedlinburg was a member of the Hanseatic League. Population, in 1890, 20,761; in 1900, 23,378.

QUEEN ANNE'S BOUNTY. The fund formed by the liberality of Queen Anne to augment the poorer livings of the Church of England. The basis of the fund was the annates, or the first year's whole profits of a spiritual preferment. This tax, which at one time went to the Pope, was annexed to the Crown during the reign of Henry VIII. and received by his successors down to Queen Anne, who formed it into a trust fund for the benefit of the poorer clergy of the kingdom. During the year 1900 the administrators of the bounty augmented 96 livings, and made benefactions to the extent of £30,000 and grants to the extent of £16,930.

QUEEN ANNE'S WAR. The name commonly given to that part of the struggle known as the War of the Spanish Succession which was fought in America. In America the war began in the fall of 1702 by an unsuccessful expedition from South Carolina against the Spaniards in Saint Augustine. In the north the brunt of the war fell upon New England, for, in consideration of the fact that the Iroquois promised to remain

neutral, the French decided it would be wisest not to attack New York. At first the New England Indians also promised Governor Dudley that they would remain neutral, but in a few weeks they broke their promise, and, in conjunction with the French, ravaged the whole New England frontier. On March 1, 1704, a party of French and Indians under Hertel de Rouville captured the town of Deerfield, killed about 50 of the inhabitants, and carried 112 into captivity. In August, 1708, the town of Haverhill, on the Merrimac, suffered a like fate. The British colonists in 1704 and again in 1707 attempted, but without success, to capture Port Royal in Acadia. In 1709 a grand expedition against Canada was planned, but the non-arrival of an expected English fleet caused the plan to miscarry. In September of the following year six English vessels, with thirty from New England and four New England regiments, sailed from Boston, and after a short siege Port Royal was compelled to capitulate. In honor of the Queen the place was renamed Annapolis. Encouraged by this victory, the English again planned the conquest of Canada. One expedition was to march from Albany and attack Montreal; another and the more important, the nucleus of which consisted of fifteen English ships of war, forty transports, and seven battalions of Marlborough's veterans, was to operate against Quebec. The fleet, reinforced by many colonial vessels, sailed from Boston on July 30, 1711, but on the night of August 22d eight vessels and about a thousand men were lost upon the rocks of the Egg Islands in the Saint Lawrence. Discouraged by this event, the incompetent commander, Sir Hovenden Walker, gave up the attempt, and the whole campaign ended in a miserable failure. The remainder of the struggle was marked merely by border raids, and no important operations were undertaken by either side. In 1713 the War of the Spanish Succession was brought to a close by the Peace of Utrecht, but hostilities with the Indians continued for some time longer. So far as the terms of the treaty concerned North America, the French gave up the territory around Hudson Bay, and surrendered all claim to sovereignty over Newfoundland, although they retained the privilege of drying fish on the west coast. Acadia was also ceded to England, but the French were allowed to keep Cape Breton, with the right to fortify it. Consult: the *Massachusetts Historical Collections: the Massachusetts Historical Society Proceedings*; Church, *Entertaining Passages* (Boston, 1716); *The Redeemed Captive* (Boston, 1707; Northampton, 1853), by Rev. John Williams, one of the prisoners taken at Deerfield; Drake, *The Border Wars of New England* (New York, 1897); and Parkman, *A Half-Century of Conflict* (Boston, 1892; later ed. 1897).

QUEEN CHARLOTTE (shär'löt) **ISLANDS**. A group of islands off the coast of British Columbia, 130 miles northwest of Vancouver Island (Map: Canada, D 6). Area, 5100 square miles. They are mountainous, rising to a height of 5000 feet, except Graham Island, the largest and northernmost, which is chiefly a rolling plain. All of them are densely forested, and the climate is very humid. They are inhabited by the remnants of the Haida (q.v.) tribe, and a few white settlers, chiefly engaged in fishing.

QUEEN CHARLOTTE SOUND. The northern part of the channel separating Vancouver Island (q.v.) from the mainland.

QUEEN CITY, or **QUEEN OF THE WEST**. A popular name of Cincinnati, Ohio. Buffalo, New York, is called the *Queen City of the Lakes*; and Sydney, Australia, the *Queen City of the South*.

QUEEN CONCH. A local name in the West Indies for one of the large helmet shells (*Cassia cameo*) extensively used for cameo-cutting (see *CAMEO*), the under layer giving a deep claret-colored background to the white design carved in the superficial layers.

QUEEN-FISH, or **WHITE CROAKER**. A small sciaenid fish (*Sciriphus politus*) of the southern part of California, which is common on sandy shores, is about a foot in length, and is an excellent pan-fish. It is bluish above and bright silvery below, with the fins bright yellow.

QUEEN OF THE ADRIATIC. A name given to Venice on account of its situation and its early importance in the commerce of the East.

QUEEN OF THE ANTILLES. Cuba, so called because of its natural beauties and advantages.

QUEEN'S BENCH. See **KING'S BENCH**.

QUEENSBERRY, **WILLIAM DOUGLAS**, fourth Duke of (1724-1810). A British rake and sportsman, known as 'Old Q.' He was notorious for his shameless excesses. As Earl of March he was Vice-Admiral of Scotland from 1767 to 1776, and inherited the title of Duke, with a large fortune, in 1778. He is chiefly remembered through the poems written in his dishonor by Burns and Wordsworth. In Thackeray's *Virginians* he appears as the Earl of March.

QUEENSBERRY PLOT. A supposed Jacobite plot in Scotland in 1703, revealed, it was claimed, through the relations of the Duke of Queensberry with the notorious Lord Lovat (q.v.).

QUEENSBERRY, **JOHN SHOLTO DOUGLAS**, Marquis of (1844-1900). An English patron of sport. He succeeded his father as marquis in 1858, served in the army from 1859 to 1864, and was a representative peer for Scotland from 1872 to 1880. He became best known as a patron of sparring. He was one of the founders of the Amateur Athletic Club in 1860, and in 1867 took part in drawing up the rules bearing the name of 'Queensberry rules.' See **PUGILISM**.

QUEEN'S COLLEGE. A college at Cambridge, England. It was founded in 1448 by Queen Margaret of Anjou, consort of Henry VI., replacing a foundation called the College of Saint Bernard, established two years earlier by her husband. The new foundation was known as Queen's College of Saint Margaret and Saint Bernard, but was refounded by Elizabeth Woodville, consort of Edward IV., under its present name. The site was given by Richard Andrew of Cambridge, and the endowment chiefly gathered by the first master, Andrew Docket. Recently the college has had an enrollment of about eighty undergraduates and it presents to eight livings. The buildings, which preserve their early character, are among the most interesting in the university. The library contains about 30,000 volumes. Queens'

was the residence of Erasmus during his stay in Cambridge.

QUEEN'S COLLEGE. A college at Oxford, England. It was founded in 1340-41 by Robert de Eglesfield, chaplain to Philippa, Queen of Edward III., for a provost and twelve scholars, in imitation of Christ and the Apostles. Poverty was enjoined; the college was very ecclesiastical in its tone, the fellows being required to be in holy orders, and, as a charity, twelve poor boys were supported out of its revenues. The positions in the college were practically confined to the North Country, of which the founder was a native. Under the new statutes of 1882, the college has a provost, from fourteen to sixteen fellows, about twenty-five scholars, and two Bible clerks. There are actually, however, thirty-five scholars, and twenty exhibitioners, besides a number of honorary fellows and lecturers, and college officials. The buildings date from the late seventeenth century, the hall by Sir Christopher Wren and the library, with about 60,000 volumes, being especially noteworthy. Various quaint customs prevail in the college, particularly the ceremony of the boar's head at Christmas, and the New Year's custom of presenting each of the fellows with a needle, and admonishing him to thrift. Among the distinguished members of the college have been John Wielif (probably), Edward the Black Prince, Henry V., Addison, Wycherley, Jeremy Bentham, Mitford, and Jeffrey.

QUEEN'S COLLEGE. An institution of higher education, situated at Belfast, Ireland. It was founded in 1845 and constituted part of the Queen's University in Ireland until the passage of the University Education Act in 1879. In 1902 it had an attendance of 349, with a teaching staff of 22 professors, offering courses in the liberal arts, medicine and law. The library contained about 55,450 volumes.

QUEEN'S COLLEGE. An institution of higher education situated at Galway, Ireland. It was founded in 1845, together with the colleges at Cork and Belfast as a part of Queen's University, but became independent in 1850. It gives instruction in law, medicine, and the liberal arts.

QUEEN'S COLLEGE. An institution of higher education, situated at Cork, Ireland. It was founded in 1845, forming a part of Queen's University until 1879, together with Queen's College in Belfast and Queen's College in Galway. It offers courses in the liberal arts and medicine.

QUEEN'S COUNSEL. See KING'S COUNSEL.

QUEEN'S COUNTY. A southeastern inland county of Leinster, Ireland, bounded north by King's County, east by Kildare and Carlow, south by Kilkenny, and west by Tipperary and King's County (Map: Ireland, D 4). Area, 664 square miles. The Barrow is the chief river. On the northwestern border lie the Slieve Bloom Mountains, and the Dysart Hills occupy the southeast, the rest of the surface being flat or gently undulating. Dairy farming is the principal industry. Coarse linen and cotton cloths are manufactured in small quantities, and coal is mined. The capital is Maryborough. Population, in 1841, 154,000; in 1851, 111,700; in 1891, 63,855; in 1901, 57,225.

QUEENSLAND. A State of Australia, occupying the northeastern part of the continent. It is bounded on the north by the Gulf of Carpentaria and Torres Strait, on the east by the Pacific Ocean, on the south by New South Wales, and on the west by South Australia (Map: Australia, G 3). Its extreme length from north to south is 1260 miles, its extreme breadth 940 miles, and its area is estimated at 668,497 square miles, or nearly one-fifth of the area of the United States.

Queensland has a coastline of 2230 miles. Its eastern coast, from Point Danger to Cape York, the northern extremity of York Peninsula, is indented with numerous small bays, affording several good harbors, such as Moreton Bay, the harbor of Brisbane. This coast is lined, at a distance away of 20 to 150 miles, by an immense coral reef called the Great Barrier Reef, which is about 1000 miles long and incloses a broad sheet of quiet water filled with numerous islands. The Great Dividing Range, which runs along the entire eastern coast of the continent, here recedes farther from the sea than in the two southern States. But it sends out a number of spurs, and divides into parallel coast ranges, so that the whole eastern part of the State for 300 miles from the coast is rugged and mountainous, the ranges having an average elevation of 2000 to 3000 feet, with a maximum height of 5400 feet. The western half is an undulating plain traversed in its north central part by a western spur of the Great Divide. There are four principal drainage systems: first, the rivers flowing eastward to the Pacific Ocean, which, though short, are navigable tidal streams for considerable distances; second, those flowing through the plain southward to the Darling; third, those flowing north to the Gulf of Carpentaria; and fourth, those flowing westward and losing themselves in the great central plains of the continent. Queensland is better watered than any of the other States.

Though lying to a great extent within the tropics, Queensland enjoys a comparatively equable climate. The mean annual temperature in the southeastern part is 69°, and even in the arid western plains the temperature seldom rises above 95°. The rainfall is very unevenly distributed. On the east coast it ranges from 50 inches at Brisbane to 100 and even 150 inches farther north. It decreases very rapidly toward the interior, being generally less than 20 inches west of the mountains, and falling to 6 inches in the extreme west. The rainfall throughout the State is very uncertain.

The great western plains have a rich black soil, but are generally treeless, though covered with grass and shrubs. The valleys along the coast are filled with thick deposits of alluvial soil of great fertility, and here we find a luxuriant tropical forest growth. Though the predominant species are Australian types, such as Eucalyptus and Acacia, the flora of Queensland differs from that of the other States in having a large admixture of Indian, Malayan, and Polynesian types, notably among the cycads and palms. Here grow the screw-pines (*Pandanus*) and the Araucarias, while the coasts and tidal streams are lined with mangrove thickets. The fauna, on the other hand, is typically Australian.

The great western plains are Cretaceous, partly consisting of the series known as Desert sandstone. It incloses a large area of metamorphic rocks in the northwest, and disappears under the Tertiary strata fringing the shores of the Gulf of Carpentaria. The eastern mountain belt consists very largely of granites and igneous rocks, with extensive volcanic areas of more or less recent origin. The granite ranges are flanked by large areas of Paleozoic rocks, chiefly Devonian and Carboniferous. There are extensive coal beds in the State, both in the Carboniferous and in the Cretaceous strata of the west. Auriferous quartz veins are also scattered through the mountain region, and lodes of silver, copper, mercury, bismuth, antimony, tin, and cobalt are also found.

The mineral resources, especially its gold, have contributed much to the development of Queensland. The total gold production to the end of 1900 was £50,209,783. Since 1889 the annual output has not fallen below two million pounds in value. The highest figure reached, £2,871,700, was in 1900. The output of tin, formerly an important source of income, has been much reduced during recent years, the value having been estimated at £74,041 in 1900. The value of the copper output fluctuates greatly. In 1900 it was £23,040. The value of silver lead in the same year was £12,712, which was several times less than was common a decade earlier. The value of the coal output increased steadily from £24,573 in 1880 to £157,071 in 1890, and after a subsequent decrease, stood in 1900 at £173,705.

General agricultural interests are not yet extensively developed. The vast region west of the mountains is too arid to admit of successful farming. Along the coast, however, the rainfall and the soil favor the growth of a very great variety of products both temperate and tropical. The area under crops increased from 242,629 acres in 1891 to 457,397 in 1900-01, not including grass and fallow lands. The most extensively grown crop in the latter year was corn, to which 127,974 acres were devoted. Wheat is grown in the southeast, there being, in 1900-01, 42,497 acres. In the same year there were 42,497 acres in hay, 11,060 acres in Irish potatoes, and 3584 in sweet potatoes. By far the most important crop is sugar-cane, the area devoted to which increased from 50,922 acres in 1890 to 108,535 in 1900-01. The rich lands at the mouths of the numerous streams are well adapted to sugar culture. Formerly the plantation system prevailed, the labor being done by Kanakas brought into the country for this work. There has been much objection to the introduction of colored labor, and under Government aid a system is developing which it is thought will dispense with the necessity for such immigration. The Government aids a combination of small farmers to erect mills which are operated upon the coöperative plan. A great variety of fruits are successfully grown. In 1900 there were 2019 acres in grapevines. Bananas, pineapples, and oranges are extensively produced along the coast.

Queensland is still largely a pastoral country. Much of the region west of the mountains is adaptable to pastoral industries, though too dry for farming, and the sheep are mainly found in that part. The number of sheep increased from 6,935,967 in 1800 to 21,708,310 in 1892, but de-

creased since that year to 10,330,185 in 1900. This decrease was attributed to drought. In many places the drought of late has been effectually guarded against by the boring of Artesian wells, and occasionally by damming streams and other means. Queensland has more than twice as many cattle as any other Australian State. The number increased from 3,162,752 in 1880 to 7,012,997 in 1894, since which time it has decreased to 4,078,191 in 1900. The introduction of improved methods of caring for meat—freezing, preserving, etc.—makes possible larger shipments of meat products, and increases the profit accruing in stock-raising. Dairy farming is beginning to receive much attention, and many coöperative creameries have been established in the southern part of the country. In 1900 there were 456,788 horses and 122,187 hogs in the State.

Queensland has a variety of industries such as the manufacture of flour, sugar, butter and cheese, brewing and distilling, meat-packing, tanning, and the sawing of lumber. In 1899, 28,883 hands were employed in the various branches of manufacturing.

In the external trade the imports increased from £5,066,700 in 1890 to £7,184,112 in 1900, but decreased in the following year. The exports gained from £8,554,512 in 1890 to £11,942,858 in 1899, but declined in the two subsequent years. The most valuable items of export are gold, wool, frozen meat, sugar, hides and skins, preserved and salted meats, and tallow. The largest imports are textiles and clothing, metal and metal goods.

In December, 1901, there were 2801 miles of railroads, mostly in the hands of the Government. Up to that time the Government had expended £20,139,023 in the construction of them. Three lines—one in the south, one in the centre, and one farther north—extend westward into the interior, but there is no connecting line between these. The postal service and the telegraph lines are in the hands of the Government.

The Governor is appointed by the British Crown. He has an Executive Council of 9 members, 8 of whom hold portfolios. There is a Parliament of two Houses—the Legislative Council and the Legislative Assembly. The members of the former are nominated by the Crown for life, and in 1902 numbered 39. The 72 members of the popular House are elected for three years. There is universal male suffrage. After a residence of 6 months certain classes of property-holders are allowed to vote in any district in which their property is located. Queensland sends 9 members to the Australian House of Representatives.

The ownership of public utilities on the part of the State has incurred heavy debt and a large annual revenue and expenditure. The debt in 1900 was £35,898,414. In the fiscal year 1900-01 the revenue and receipts amounted to £4,327,345. Of this, £1,117,472 were collected from taxation, mainly customs, and duties on bank notes, probate and succession duties, and other stamp duties. The land revenue brought in £585,229, the largest item being 'pastoral occupation.' The income-earning public works, chiefly railways and tramways, had a gross income of £1,481,608. The working expense of the railways was £1,056,132. The largest item of expenditure—the charges upon the public debt—

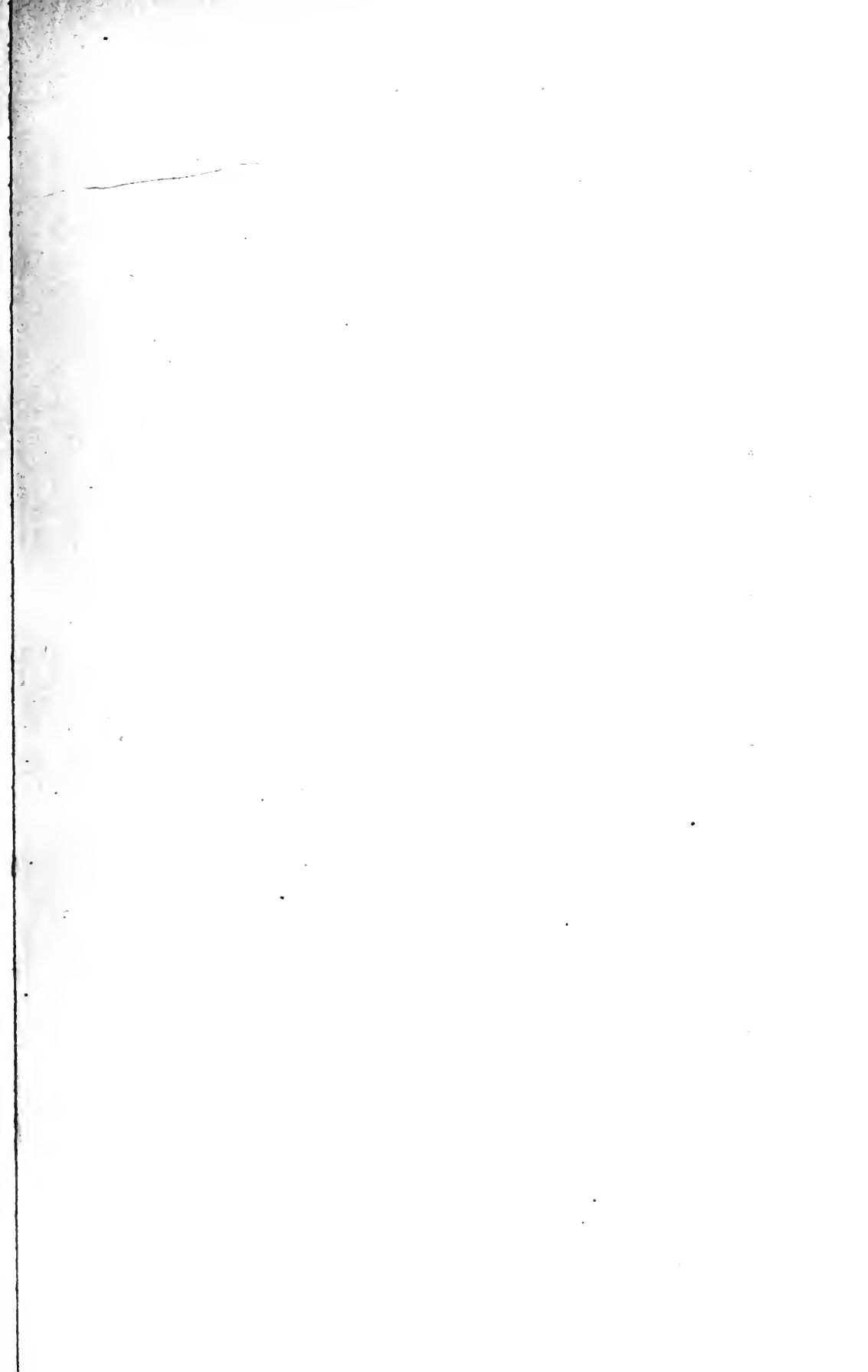

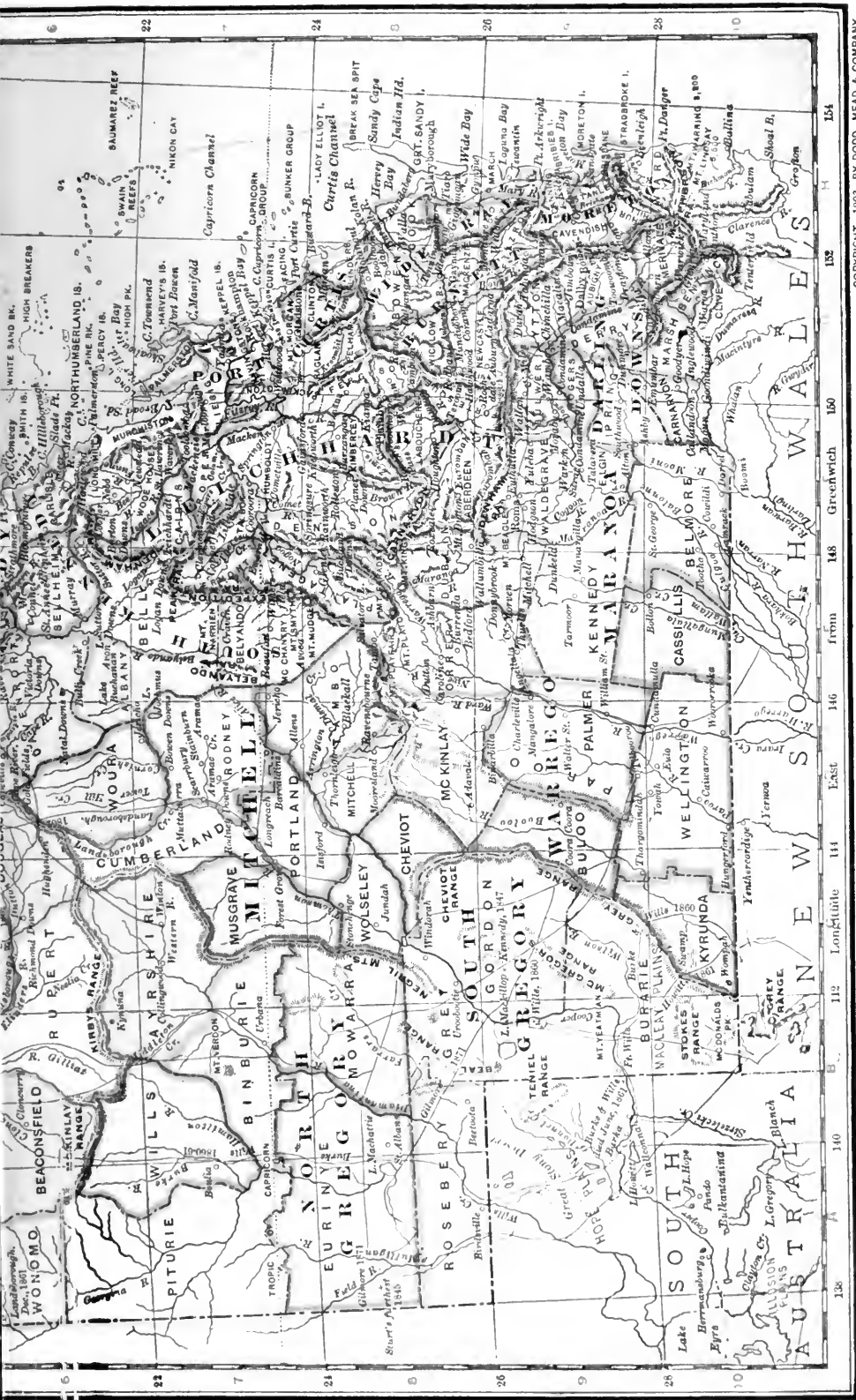

COPYRIGHT, 1903, BY DODD, MEAD & COMPANY.

130 132 134 136 138 140 142 144 146 148 150 152 154
East
Longitude

22 21 20 19 18 17 16 15 14 13 12 11 10
Latitude

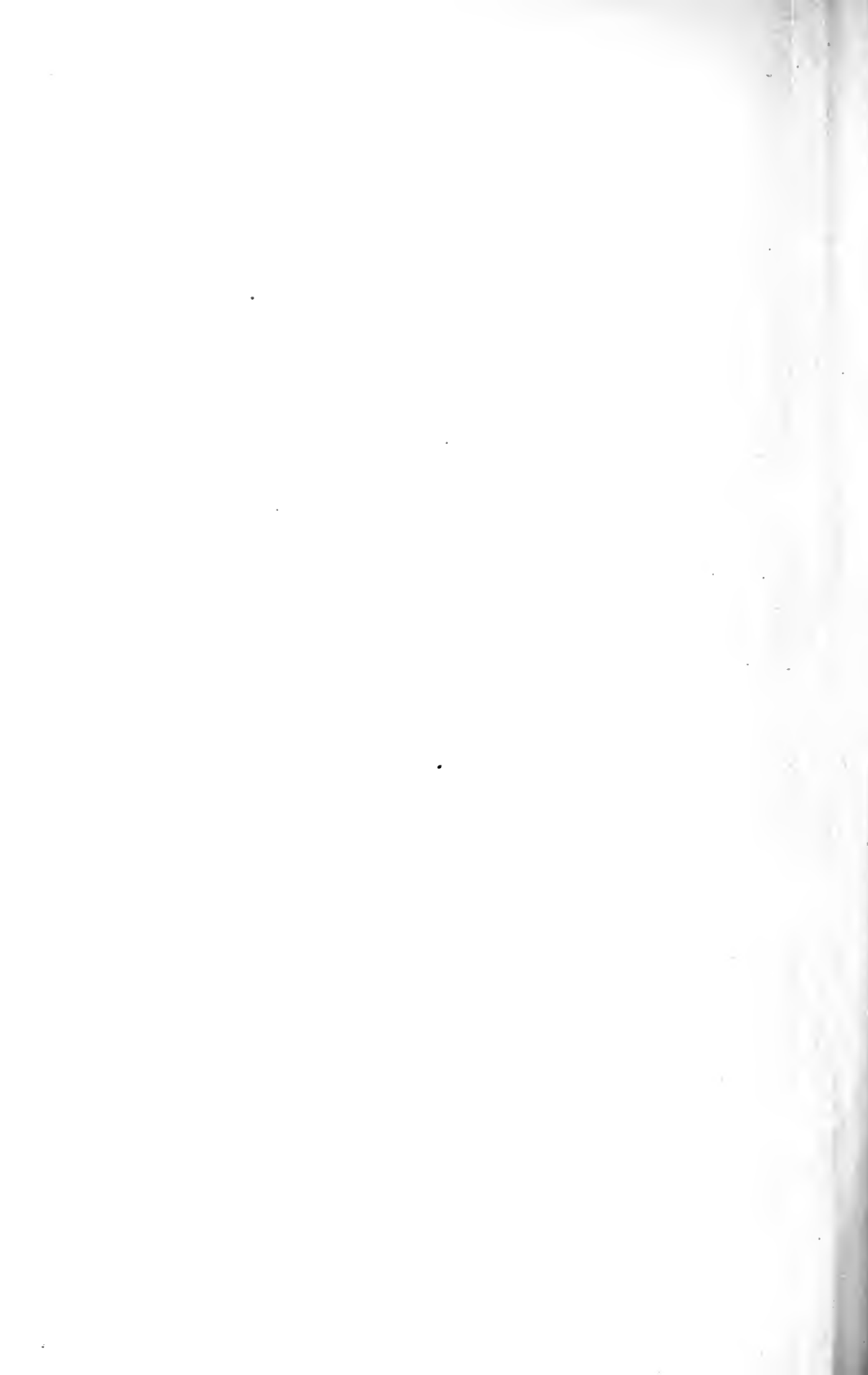

was £1,415,180. The total expenditure was £4,855,533.

The population increased from 28,056 in 1860 to 391,080 in 1890, and 503,266 in 1901. In the latter year there were 280,092 males and 223,174 females. The excess of immigration over emigration has become very small in recent years. The white inhabitants are mainly from the United Kingdom. The aborigines number 3862 males and 2808 females, not including those who live in camps. The population is confined largely to the coast region, and is most numerous in the south. Brisbane is the capital.

In 1901 there were 185,023 adherents of the Church of England; 120,663, of the Church of Rome; 57,615 Presbyterians; 29,791 Wesleyans; 25,505 Lutherans. The Mohammedans and Pagans numbered 19,124. There is no State Church. Education is compulsory between the ages of six and twelve years, but in some parts it is not enforced. Primary education is free and unsectarian. In 1901 it was estimated that 98 per cent. of the adult white population could read and write. The expenditure of the State for education in 1901 was £299,866.

With the early history of Queensland are associated the Spaniard Torres, whose name is perpetuated in the strait separating that land from New Guinea, and that of the explorer Cook, who, in 1770, coasted from Moreton Bay to Torres Strait and made a chart of the coast. The explorations of Lieutenant Flinders, in 1799, opened the way for the settlement of the Moreton Bay district, but his work seems to have been neglected, until Queensland was practically rediscovered by Oxley in 1823. In 1826 a penal settlement was established on Moreton Bay and the Brisbane River, but the convicts were soon removed and subsequent attempts to introduce a criminal population into the country failed before the strong opposition of the free inhabitants. The country was admirably adapted for grazing and drew a large immigration from the southern settlements, the population, in May, 1859, when Queensland was set off as a separate colony, being about 25,000, mostly squatters. Brisbane and Ipswich were the only towns of importance. A severe financial panic in 1866 was followed by the discovery of gold in the years 1867-72, the mining interests henceforth playing a prominent part in the shaping of public policy. The importation of coolies for work on the sugar plantations led to many conflicts in Parliament. The importation of Kanaka labor was forbidden in 1890, but was resumed two years later, owing to the alarming condition into which the sugar industry had fallen. The Labor Party exercised an important influence on affairs after 1890, though its power was not as fully developed as in the more southern colonies. In the winter of 1899 Queensland ratified the Constitution for the new Australian Commonwealth. See AUSTRALIAN FEDERATION.

BIBLIOGRAPHY. Daintree, *Queensland: Its Territory, Climate, and Prospects* (London, 1872); Dalrymple, *Narrative and Reports of the Queensland Northeast Coast Expedition* (Brisbane, 1874); Grant, *Bush Life in Queensland* (London, 1882); Bonwick, *Resources of Queensland* (ib., 1880); id., *Queensland; Its Resources and Institutions* (ib., 1887); Bicknell, *Travel and Adventure in Northern Queensland* (ib., 1895); Weedon, *Queensland Past and Present* (Brisbane,

1896-98); Roth, *Ethnological Studies Among the Northwest Central Queensland Aborigines*, contains bibliography (ib., 1897); Jack and Etheridge, *The Geology and Palaeontology of Queensland and New Guinea* (ib., 1892); *Year Book of Queensland* (ib., annually).

QUEEN'S METAL. A silver-like alloy resembling pewter. It is made by fusing tin, 9 parts, and antimony, bismuth, and lead, each 1 part; or tin 100 parts, antimony 8 parts, copper 4 parts, and bismuth 1 part. It has been largely used in the manufacture of teapots and similar articles for domestic use.

QUEEN'S (or KING'S) TOBACCO PIPE. The popular nickname of a peculiarly shaped kiln or furnace in the northeast corner of the tobacco warehouses belonging to the London docks, in which contraband goods, such as tobacco, cigars, tea, which had been smuggled, and books were burned. Damaged and worthless goods are still burned, but seized and unclaimed goods are now sold generally at the periodical 'customs sales,' or distributed among public institutions.

QUEENSTOWN, formerly COVE OF CORK. A seaport town on the south side of Great Island in Cork Harbor, Ireland, 18 miles east-southeast of Cork (Map: Ireland, C 5). It is important as the port of call of the American mail steamers. The town is built amphitheatrically in parallel streets on the sides of a steep acclivity. During the winter it is much frequented by invalids, owing to its mild and healthful climate. A fine Roman Catholic cathedral, 100 feet high, surmounted by a tower 230 feet high, is a conspicuous building. The famous yacht club, the Royal Cork, is the oldest in the world. The Cove of Cork became important during the Napoleonic wars as the port of embarkation for troops going on foreign service, and is now an admiral's station. In honor of Queen Victoria's visit in 1849 the name was changed to Queenstown. Population, in 1901, 7909.

QUEENSTOWN. A town and railway station, capital of the district of the same name, in Cape Colony, about 100 miles northwest of East London (Map: Cape Colony, L 7). It is the centre of a productive farming region situated in the valley of the Great Kei River. Population, over 4000.

QUEERUMMA'NIA. In Carey's burlesque *Chrononhotonthologos*, the name given to the country over which that King ruled.

QUEIROZ, kã'ê-rôsh', JOSÉ MARIA EÇA DE. See EÇA DE QUEIROZ.

QUELIMANE, k'ê'lê-mã'nã. A town of Portuguese East Africa. See QUILIMANE.

QUELLINUS, ARTUS (1609-68). A Dutch sculptor, born in Antwerp. He was the pupil of Duquesnoy in Rome. His principal works were the decoration of the façade of the new Town Hall in Amsterdam, begun in 1648, and the numerous statues he executed inside the building. His decorative groups are robust and imaginative, but the interior sculptures, such as the Caryatide, are more severe in treatment. There are other works by him in the Museum and the churches of Antwerp. His son, ARTUS, was also a sculptor, and assisted his father in several of his undertakings.

QUELPAERT, kwêl'pärt. The name by which the Korean island of Tamra is known to foreigners. It lies about 60 miles south of the mainland in latitude 33° 25' N. and longitude 126° 37' E. (Map: Korea, G 5). It is nearly oval in form, measures 40 by 20 miles, and is covered almost entirely with mountains, which end steeply on the coast, and culminate in Han-ra-san, or Mount Auckland, with a height of 6700 feet and visible far out at sea on account of its whiteness. On its summit are three extinct craters, within each of which is a lake of pure water, whence, according to local legend, issued the first three men of the world. Area, about 780 square miles. Population, about 80,000. The chief industries are agriculture, fishing, straw-plaiting, and the manufacture of the very fine split-bamboo hats which are peculiar to Korea. Quelpaert is also noted for its fine breed of cattle. Its chief town is Chyei Chyu, where the moksä, or governor, resides. The island was first surveyed and mapped by the officers of the British ship *Samarang* in 1843. Consult: Belcher, *Narrative of H. M. S. Samarang* (London, 1848); Hamel, "Narrative of Captivity in Korea," in *Griffith's Korea Without and Within* (New York, 1885).

QUENIULT, kwê'nî-ült' (properly *Kwi-naiult*). A small tribe of Salishan stock (q.v.), formerly claiming the territory upon the river of the same name on the Pacific coast of Washington, where they still hold a reservation. They first entered into Government relations in 1855. They are attached to the Puyallup agency, and in their general habit and present condition closely resemble the Puyallup (q.v.). They have greatly declined and number only 130. The Quaitso, a sub-tribe, number about 60 more.

QUENSTEDT, kwên'stêt, FRIEDRICH AUGUST (1809-89). A German mineralogist and geologist. He was born at Eisleben, studied at Berlin, and in 1837 became professor of geology and mineralogy at Tübingen. In geology Quenstedt made a special study of the sedimentary formations in Swabia, the basis of modern knowledge of the Jurassic system. His great contribution in mineralogy was in applying the analytic method to the study of crystalline systems. He published: *Methode der Kristallographie* (1840); *Handbuch der Mineralogie* (1854; 3d ed. 1877); and *Grundriss der bestimmenden und rechnenden Kristallographie* (1873).

QUENTAL, kân-täl', ANTHERO DE (1842-91). A Portuguese poet, born at Ponta-Delgada, on the island of San Miguel. He studied law at the University of Coimbra, and early began to write verse. As a poet he belongs to the Romanticists, and is perhaps the most individual of the 'Young Portuguese' school. He also wrote critical and philosophical articles, like his poetry, deeply pessimistic in tone. His works include a collection of sonnets (1863); *Beatriz* (1864); *Odes modernas* (1865), reprinted with additions (1875); *Primaveras romanticas* (1872); *Sonetos* (1881); *Os sonetos completos* (1886); and the critical and philosophical *Bom-sensoe e bom-gosto* (1865); *A dignidade das letras* (1865); *Considerações sobre a filosofia da historia litteraria portugueza* (1872); and *A poesia na actualidade* (1881). Consult Björkman, *Anthero de Quental* (Upsala, 1894).

QUENTEL, kwên'täl, HEINRICH (?-1501). A German printer, of Cologne. He was born in Strassburg, and about 1478, having married in Cologne, there established a press near the great Cathedral, whence the place-mark *prope summum* in his books. The earliest dated work from Quentel's press is *Fratrie Astecani Opus de Casibus Conscientia* (1479). But it seems probable that the earliest Low German version of the Scriptures, which is usually reckoned as printed about 1470, is from Quentel's types, and possibly from his press. The business for some time after Heinrich's death still bore his name, several books having the imprint *In Officina Pelicis Memorie Henrici Quentell*. His two sons carried it on until 1520, when Peter became sole owner. His chief publication was a map of the city of Cologne (1531).

QUENTIN DURWARD, kwên'tin dūr'wërd. A novel by Sir Walter Scott (1823). The scene is France in the time of Louis XI., where the hero goes to seek his fortune. Having gained the King's favor by saving him from a boar, Durward is sent to conduct two great ladies to the Bishop of Liège, and succeeds in spite of treachery on the part of Louis. The Bishop is murdered in an attack, but Durward and Isabella escape and are married. The treacherous and superstitious King is admirably portrayed.

QUÉRARD, ká'rär', JOSEPH MARIE (1791-1865). A French bibliographer, born in Rennes. He worked in a bookseller's shop in his native town as a youth, and went to Paris in 1822. The next two years he spent in the printing and bookselling business in Vienna, and then returned to Paris to begin the publication of *La France littéraire ou Dictionnaire bibliographique, etc.* (1827-42; 2 vols. of sup. 1854-64). This work is an invaluable bibliography of eighteenth-century French authors. *La littérature française contemporaine* (1842-57) is a continuation of it. Through Guizot, Quérard obtained a small pension which enabled him to continue his study and writing, and he was helped by the bibliographer Poltoratzky, but he died in poverty. Quérard's other works include: *Les auteurs déguisés de la littérature française au XIXe siècle* (1845); *Les supercherries littéraires dévoilées* . . . (1846-54); *Omissions et bévues* . . . (1848), and *Les écrivains pseudonymes, etc.* (1854-56). He also began a great *Encyclopédie du bibliothécaire*, and published *Le Quérard Archives d'histoire littéraire de biographie et de bibliographie françaises, etc.* (1855-56).

QUER/CETA'NUS. See DUCHESNE, ANDRÉ.

QUERCIA, kwär'chä, JACOPO DELLA. See JACOPO DELLA QUERCIA.

QUERO/CITRON (from Lat. *quercus*, oak + *citrus*, citron). The name both of a dyestuff and of the species of oak of which it is the bark. This oak (*Quercus tinctoria*), also called dyer's oak, is a native of North America—one of the noblest forest trees of the United States, found in New England, and as far south as Georgia, although there only at a considerable elevation. The wood is reddish, coarse-grained, and porous, but much esteemed for strength and durability, and is used in America for ship-building. The bark is used for tanning as well as for dyeing. It is the inner bark which is the quercitron

of dyers. It yields a yellow crystallizable substance, *quercitrin*, $C_{28}H_{38}O_{20} + 3H_2O$, which may be extracted by means of alcohol; the tannic acid, which is simultaneously taken up, must be precipitated by the addition of gelatin, after which the liquid will, on evaporation, yield crystals of quercitrin. On the addition of alum, its solution assumes a beautiful yellow color. When boiled with dilute acids, quercitrin breaks up into glucose and *quercetin*, $C_{24}H_{36}O_{11} + 3H_2O$ —a yellow crystalline substance, soluble in alkaline solutions, to which it communicates a golden-yellow color. It is brought into commerce under the name of *flavin*. The decomposition shows that quercitrin belongs to the glucosides, or compounds which, when broken up, yield sugar.

QUERCUS. The generic name for oak (q.v.).

QUERÉTARO, ká-rá'tá-rò. An inland State of Mexico, bounded by the State of San Luis Potosí on the north, Hidalgo and Mexico on the east, Michoacán on the south, and Guanajuato on the west (Map: Mexico, J 7). Area, 3,556 square miles. Querétaro belongs geographically to the Plateau of Anahuac (q.v.), is traversed by mountain ranges in the northern part, while in the south plains and valleys prevail. The State is watered by a number of small rivers, and the climate is temperate, with moderate frost and rainfall. The valleys are very fertile, and the chief agricultural products are cereals and sugar. The mineral wealth is considerable and mining is carried on to some extent. The most famous opal mines in Mexico are located here. There are also some manufactures of cotton and woolen goods. The province is traversed by the Mexican Central Railway. Population, in 1895, 224,848; in 1900, 228,489. Capital, Querétaro.

QUERÉTARO. The capital of the State of Querétaro, Mexico, situated on an elevated plateau 110 miles northwest of the City of Mexico, on the Mexican Central Railroad (Map: Mexico, J 7). It is a pleasant and well-built city, and has several fine avenues leading to the beautiful parks which surround it. There are two large squares, on one of which stands the city hall, and on the other the cathedral. Other notable buildings are the Government palace, built of basalt, the custom house, several fine churches and hospitals, the elegant and historic Iturbide Theatre, and the bull ring. There is a good water supply brought by an aqueduct of 74 arches and 80 feet high. The city is an important industrial centre, and contains some of the largest cotton mills in the country. Population, in 1895, 34,567.

Querétaro is one of the most historic cities of the Republic. It was here that the movement for independence began. It was the last place of refuge of Maximilian, and he and his two generals were executed here in 1867.

QUESADA, ká-sá'dá, GONZALO XIMENEZ DE. See XIMENEZ DE QUESADA.

QUESNAY, ká'ná', FRANÇOIS (1694-1774). A French economist, born at Méré. He first distinguished himself as a surgeon and physician. His *Observations sur les effets de la saignée* (1730), in which he successfully opposed the theories of bleeding of the leading contemporary authority, led to his selection as secretary of the Academy of Sur-

gery at Paris. Defective eyesight compelled him to abandon surgery for medicine. In 1749 he became physician to Madame de Pompadour, and he was appointed physician to the King in 1752. This position gave him leisure for philosophical and economic study, and in 1756 he published in the *Encyclopédie* articles on "Fermiers" and "Grains," in which he correctly analyzed the deficiencies of French agriculture, and advocated the adoption of capitalistic methods in farming and the abolition of the vexatious taxes and restrictions which were impoverishing French agriculture. In these articles Quesnay advanced the doctrine that the sole source of national wealth is the surplus of agriculture, the *produit net*. (See PHYSIOCRATS.) In 1758 he published his *Tableau économique*, a work which disappeared in the early nineteenth century, but was found in 1890, and reproduced in facsimile at London in 1894. Its purpose was to make intelligible at a glance the dependence of a nation's wealth upon the *produit net*. Quesnay published several minor economic works, which, however, added nothing to the doctrines of the *Tableau*. His chief influence upon economic thought was exercised through his disciples, who formed the sect afterwards known as the 'Physiocrats' (q.v.). Quesnay's works were collected and published in 1768 by Dupont de Nemours, under the title of *Physiocratie*. Consult: Higgs, *The Physiocrats* (London, 1897); Oncken, *Œuvres économiques et philosophiques de Quesnay* (Frankfort, 1888).

QUESNAY DE BEAUREPAIRE, de bô'r'-pâr', JULES (1838—). A French jurist and author, born at Saumur. He became especially conspicuous during the Boulanger and Dreyfus affairs, and was president of the courts of cassation before which Dreyfus was tried in 1889 and 1899. His publications, some of them under the pseudonym of Jules de Glouvet, include *Histoires du vieux temps* (1882); *Les forestier* (1880); *Le marinier* (1881); *Le berger* (1882); and *L'idéal* (1883).

QUESNEL, ká'nél'. PASQUIER (1634-1719). A French Jansenist theologian. He was born in Paris, July 14, 1634, and having been educated in the Sorbonne, entered the Congregation of the Oratory (q.v.) in 1657. At the age of twenty-eight he was appointed director of the Paris house of his congregation. It was for the use of the young men under his charge that he commenced the series of his afterwards celebrated *Réflexions morales* on the New Testament. Soon afterwards he published an edition of the works of Saint Leo (1675), much criticised by reason of its Gallicanism, and in 1676 put among the prohibited works by the Pope. His residence at Paris, however, was cut short by the disputes about Jansenism. Having refused to sign certain propositions, subscription to which was, by a decree of 1684, required of all members of the Oratory, Quesnel left the congregation and retired to Brussels, where he attached himself to the party of Arnauld, the Jansenists, in which he speedily rose to the first position of influence and authority. He continued his *Réflexions morales* while living there in concealment; and in 1693-94 they were published in a complete form, with the approval of Cardinal de Noailles, Bishop of Châlons, and ultimately Archbishop of Paris. The work, however, on examination, was

found to contain all the most obnoxious doctrines of Jansenius; and Quesnel, having been denounced to the authorities, was arrested by order of Philip V. and put into prison. He escaped to Amsterdam, where he died December 21, 1719. But his book was condemned, first by the decree of an assembly of the bishops of France, afterwards by a decision of Clement XI. in 1711, and finally by the celebrated bull *Unigenitus*. See JANSENISM.

QUETELET, kô'tlâ', LAMBERT ADOLPHE JACQUES (1796-1874). A Belgian statistician and astronomer, born at Ghent. He studied at the lycœum of his native city, where in 1814 he became professor of mathematics. In 1819 he was appointed to the same chair at the Brussels Athenæum; and in 1826 was chosen by William I. to superintend the construction of the royal observatory in the capital, of which he became director in 1828. In 1836 he was made professor of astronomy and geodesy at the Brussels Military School. His numerous and valuable writings include: *Astronomie élémentaire* (1826; 4th ed. 1848); *Recherches sur la population*, etc. (1827-32); *Sur l'homme et le développement de ses facultés ou essai de physique sociale* (1835); *Du système sociale et des lois qui le régissent* (1848); and *Physique* (1855). He also published numerous papers on meteorology, astronomy, terrestrial magnetism, etc., in the *Mémoires* and *Bulletins* of the Belgian Royal Academy.

QUETTA, kwët'tâ. The chief town of British Baluchistan, 104 miles north of Khelat. It is situated among high mountains in a position of great strategic importance, commanding the Khojok and Bolan passes (Map: India, A 2). There are extensive fortifications, with a strong garrison and an arsenal. The town is connected by rail with the railway system of India and is the centre of considerable trade. Quetta has grown rapidly since 1876, when a residency was established by Sir Robert Sandeman. Population, with cantonment, in 1891, 18,802; in 1901, 24,584.

QUETZAL (Nahuatl *quetzalli*, green feather). A celebrated trogon (*Pharomacrus mocinno*) of Central America, adopted as the national bird or symbol of Guatemala, because in ancient times it was regarded with veneration and its decorative feathers were reserved for chiefs of the native tribes. It inhabits the higher districts of Guatemala and Southern Mexico, and has the general habits of the trogons (q.v.). It clings to trees and scrambles about like a woodpecker, as its feet are ill-adapted to walking; and its utterance is described as two sibilant, plaintive notes, gradually swelling into a loud, discordant cry. Its upper plumage is brilliant, iridescent green, golden on the crested head and bluish on the soft tail-coverts, the two central ones of which are elongated to from 28 to 30 inches, or about four times the length of the true tail, the outer feathers of which are white barred with black. The wing-coverts are also enlarged into plumes draped over the upper parts of the wing, and all the under parts below the breast are blood-red. (See Plate of TROGON, HOOPOE, ETC.) This magnificent creature has the further value of having its colors 'fast,' that is, their brilliance does not fade after death, as is usual with such plumage; and this fact, together with the bird's beauty and

grace, have made it so desirable for millinery trimmings that the quetzal is now very rare. The female is less brilliant and lacks the long plumes covering the tail and wings of her mate.

QUETZALCOATL, kôts'âl-kô-ät'l. The traditional beneficent hero King of the Aztecs (q.v.) and the originator of their earliest culture. The meaning of the name is disputed, but the most probable interpretation seems to be 'the admirable twin,' although it may have reference to one adorned with the green plumes of the sacred quetzal (q.v.). In what seems to be the oldest form of the myth, he is represented as a god, one of four brothers born at the same time, sons of the supreme creator. Two of these play no further part in legend, while the other, the maleficent but powerful Tezcatlipoca, whose name seems to have the mystic significance of 'the smoking mirror,' remained to become the great evil-working rival of his brother, who finally, after a long series of creations and destructions, gave up the contest for a time and disappeared in a mysterious manner, but with a promise to return on some recurrence of his natal year, known in the Aztec calendar as *Ce Acatl*, the year of the 'one reed.' Four cycles of 676 years had passed, each terminating in widespread calamity and destruction by flood, fire, storm, or earthquake. The near approach of the fifth and final doom was to be foreshadowed by the return of Quetzalcoatl in some unknown future year of the *Ce Acatl*.

According to the more popular form of the tradition, Quetzalcoatl was an early king of mysterious and miraculous birth, the son of a virgin mother, who reigned at the ancient city of Tollan or Tula, about 40 miles north of the present City of Mexico. He was entirely unlike his people in appearance, being of fair skin, with a long white beard and flowing garments also of white and embroidered with the figure of the cross in red. He was mild and dignified in manner, took no wife, and founded convents of nuns devoted to the worship of the temple and vowed to chastity. He preached universal peace and brotherhood, and under his rule war became a thing unknown. He taught his subjects, known from their chief city as the Toltecs, the arts of agriculture, metal-working, and architecture, and devised for them the calendar. At last by the evil wiles of Tezcatlipoca he was deprived of all his dignities at one blow. He made no resistance, telling his people that it was only the necessary accomplishment of a predestined fate, and that he must leave them to go to the home of his father, Tlapallan, the 'Red Land' in the southeast, but that he would return to them in some far future year of *Ce Acatl*. He started on his long journey, halting twenty years at Cholula, where he taught all his mysteries to the people, who thus became the priests of the Aztec religion, and their city with its great temple pyramid the Mecca of the Aztec Empire. Arrived at the seashore, he sailed on a raft of twisting serpents out into the sunrise.

While this second version has been widely accepted as clouded history, disguised by poetic additions and lapse of time, and various writers have tried to identify the kingly teacher with Saint Thomas, Saint Brendan, or some other early Christian apostle, others have seen in it only another form of the universal myth of day

and night, in which Quetzalcoatl is the god of light and sunshine, his rival the god of night and darkness, Tula or Tollan a syncopation for *Tonatlan*, the 'Sun Place,' and Tlapallan, the 'Red Land,' the eastern horizon. This theory is probably true in the main, but does not preclude the possibility, which is quite in accord with Indian custom, that some early Aztec king bore the same name and in time became invested in popular tradition with the attributes of the god.

By one of the most extraordinary coincidences in history, the year 1519, in which Cortés landed, was the Mexican year of *Ce Acatl*. As the year drew near upon the calendar wheel, three blazing comets swept across the sky, the waters of the lake rose without apparent cause, and a strange light appeared in the east. Montezuma was troubled with presentiments for his empire, and sent for the priests, who gave him only the boding prophecy that some great calamity was at hand. When the news came to him that the white strangers had landed from the east he said, "This is Quetzalcoatl returned to Tula," and on his first interview with Cortés the Indian King addressed him as their lost ruler. See also AZTEC; MEXICO; NAHUATLAN STOCK; TOLTEC.

QUEUE ROUGE, kē rōōzh (Fr., red-tail). A name given in the French West Indies, and also in Jamaica, to a spider of the genus *Latrodectus*, which is very poisonous and occasionally causes the death of human beings. See KATIPO; MALMIGNATTE.

QUEVEDO Y VILLEGAS, kē-vā'pō è vè-lyá'-gás, FRANCISCO DE (1580-1645). A Spanish author. He was born in Madrid, studied at Alcalá de Henares, and became versed in theology, law, Hebrew, Greek, Arabic, and Latin, as well as in modern languages. Although a cripple and defective in eyesight, he figured in many duels, in one of which he mortally wounded a nobleman and had to flee the country in 1611. Soon, however, he was employed in connection with certain diplomatic missions, and when the Duke of Osuna was put at the head of the Administration at Naples, Quevedo was made Minister of Finance under him. Osuna fell in 1620 and Quevedo shared in his misfortunes, being imprisoned for a good part of the next three years. Later he held a nominal appointment as secretary to King Philip IV. In 1639, suspected of having written some satiric verses attacking the extravagance of the King and his Ministers, he was arrested and spirited off to the monastery of Saint Mark in Leon, where he was kept for four years. At the fall of Olivarez, the Prime Minister responsible for this last imprisonment, he was again set free, but his health was now undermined, and he died at Villanueva de los Infantes, September 8, 1645. A moralizing tone prevailed in his earlier prose works, but it is as a satirist that he best showed his powers, especially in the picaresque novel *Historia y vida del Buscón* (also called *El gran Tacaño*), published in 1626, and in his series of *Sueños* (Visions). The former work is excessively coarse, yet one of the most important of the Spanish romances of roguery. At the outset Quevedo was a sturdy opponent of the Gongoristic movement that did so much to vitiate Spanish style, but he yielded to the all-pervading power of Góngora's school and allowed bombast, obscurity, and strained conceit to enter into his own verse and prose. His verse shows no slight

influence of Italian poetry, but in general it is marked by a satiric spirit that goes directly back to Juvenal. His prose writings are to be found in the *Biblioteca de autores españoles*, vols. xxiii. and xlvi.: for his verse, see vol. lxix. Consult Mérimée, *Essai sur la vie et les œuvres de Quevedo* (Paris, 1886).

QUEZALTENANGO, ká-säl'tá-nán'gò. A city of Guatemala, capital of the department of the same name. It is situated on a plateau 7700 feet above sea level and 70 miles west of Guatemala city (Map: Central America, B 3). The town is built on the slopes of a steep ridge which divides it into two portions. There are several well-built public buildings situated on the principal plaza, such as the city hall and the penitentiary, the latter being a fine stone building. The town has a good water-supply and a healthful climate. It is the second city of the Republic in size and importance. It manufactures cotton and woolen fabrics, and has a considerable trade in agricultural products. Population, about 30,000. Quezaltenango was an ancient Indian city, and was settled by the Spaniards in 1524.

QUIANGAN, kē'áng-án', or **KIANGAN**. A head-hunting people in Quiangan Province, Luzon. See PHILIPPINE ISLANDS.

QUIA TIMET. A phrase used in law to designate certain remedies of an equitable nature to prevent anticipated injury. There were formerly six writs which could be sued out *quia timet* before actual injury had occurred, which were as expressed by Lord Coke: "First a man may have his writ or mesne before he be distrained. Second, a *warrantio chartæ*, before he is impleaded. Third, a *monstraverunt*, before any distress or vexation. Fourth, an *audita querela*, before any execution issued. Fifth, a *curia claudenda*, before any default of inclosure. Sixth, a *ne injuste vexes*, before any distress or molestation. These writs, which were formerly of much importance and use, are now obsolete; but the same end is attained by filing a bill *quia timet* in equity. Consult the authorities referred to under EQUITY; PLEADING.

QUIBDO, kēb'dó. A town of the Department of Cauca, Colombia, situated on the Atrato River, 30 miles from the Pacific coast and 90 miles southwest of Medellín (Map: Colombia, B 2). The town is built on piles and the houses are generally of poor construction. The surrounding district was formerly mined extensively for gold. Population, 7,000. Quibdo was the capital of the ancient Province of Choco.

QUIBERON, kē'b'rôn'. A small fishing town and sea-bathing resort in the Department of Morbihan, France, at the extremity of a long narrow peninsula forming the western horn of the Bay of Quiberon, 22 miles south-southeast of Lorient (Map: France, C 4). Population, in 1901, 3,299. Near the neck of the peninsula are the famous megalithic monuments of Carnac. In 1746, during the War of the Austrian Succession, an English force attempted a landing here, but was severely repulsed. In 1759 Admiral Hawke completely defeated a French fleet under Admiral Conflans in Quiberon Bay. A body of French emigrant royalists, under D'Hervilly and Puisaye, landed here from an English fleet in 1795, and endeavored to rouse the people of Brittany and La Vendée against the Convention, but were de-

feated and driven back to their ships by General Hoche, all the prisoners taken being shot by order of the Convention.

QUICHÉ, kè-chá', or **KICHÉ**. An ancient civilized nation of Mayan stock (q.v.) occupying Western Guatemala, with centres at Santa Cruz, Quiché, and Totonicapan, and speaking a dialectic form of the language spoken by the Cakchiquel (q.v.). Their chronicles are said to date back to the beginning of the eighth century. Their national culture hero was Xbalanque, who, like Quetzaleatl (q.v.), was born of a virgin mother, and whose deeds are recorded chiefly in their sacred book, the *Po'ol Vuh* (q.v.). Their culture was that common to most of the tribes of the Mayan stock. Their modern descendants still form a considerable part of the population of Central and Western Guatemala.

QUICHUA, kè-ehwá', **QUICHUA**, **QUECHUA**, or **KECHUA**. The founders and ruling tribe of the great aboriginal empire of Peru. According to Peruvian tradition their empire was established by Manco Capac, the youngest of the four sons of the great creator god Viracocha (q.v.), anthropomorphized as the Sun, who, coming from Paucartambo, 'the House of the Dawn,' journeyed southward to the valley where he gathered his people about him and built the city of Cuzco (q.v.), 'The Navel,' so called because it was destined to become the centre and capital of the empire. His successors, the chiefs of the Inca clan, popularly regarded as 'Children of the Sun,' extended their dominions by slow conquest in every direction, including tribes both cognate and alien, civilized and wild, until under the Inca Yupanqui, about the year 1460, it reached from the present Colombian frontier southward to about Santiago, Chile, and from the coast inland across and beyond the Andes. For centuries after the conquest of Peru by Pizarro (q.v.) the natives cherished the hope of a restoration of their empire, and as late as 1781 Condorcanqui, a descendant of the ancient ruling family, proclaimed himself the reincarnation of the lost Inca Tupac Amaru, gathered an immense Indian army, marched upon Cuzco, and for two years held at bay the whole power of Spain, until at last he was taken and condemned, with all his family, to torture and death. The descendants of the ancient stock still constitute the bulk of the population throughout Peru.

QUICHUAN STOCK. A linguistic group of which the Quichua (q.v.) are the most noted representatives, and including most of the ancient or existing tribes along the Pacific coast and in the Andes region of South America from about 2° N. on the southern border of Colombia, to about 32° S. in the neighborhood of Valparaiso, Chile. Within this general area, however, are the Yuna, Aymara, Puquina, and Atacameño, all of alien lineage, but confined to limited territorial districts. The boundaries of the linguistic stock nearly coincide with those of the ancient Peruvian Empire, but include also a few wild tribes, as the Malaba of Northern Ecuador, never brought under subjection to the Inca rule or civilization. So far as any linguistic evidence can show, the line of migration appears to have been from north to south. The Quito of Ecuador maintained an independent kingdom under nineteen successive

rulers, according to their own tradition, until finally subjugated by the Incas. In physical type all the tribes of this stock are of low stature, heavy build, and very strong. With the exception of the few wild border tribes, they were all sharers in the same general culture that prevailed throughout the ancient empire, although in some cases, as with the Quito, this appears to have been of indigenous growth before the consolidation of the empire. The colonizing policy of the Incas tended to reduce the various cognate languages to one dialectic standard, the Quichua proper, which is still the prevailing language of Peru and Ecuador outside of the large cities. The present number of persons belonging to the Quichuan stock is probably not far from three million. Consult: Tschudi, *Die Kechua-Sprache* (Vienna, 1853); id., *Organismus der Khetzu-Sprache* (Leipzig, 1884); Middendorf, *Die einheimischen Sprachen Perus* (6 vols., ib., 1890-92); Spilsbury, *Lingua indigenas de Sud-américa, el Quichua* (Buenos Ayres, 1898).

QUICK, JOHN (1748-1831). An English comic actor, born in Whitechapel, London. He went on the stage when he was fourteen. His most famous rôles were Tony Lumpkin in *She Stoops to Conquer* (1773) and Bob Acres in *The Rivals* (1775). He retired in 1798. Quick was short in stature, quaint and whimsical, excellent in original parts and in old comedies, too, and especially famous for his personation of old men. As the First Gravedigger, Dromio of Ephesus, Spado, and Launce, he was one of the best actors of his time.

QUICK, ROBERT HERBERT (1831-91). An English educator, born in London. He graduated at Cambridge in 1854 and was ordained the following year. Afterwards he was an assistant to Dr. Merriman at Cranley and assistant master at Harrow; and he was the first to lecture at Cambridge on the history of education (1881). His *Essays on Educational Reformers* (1868; 2d enlarged edition 1890) is a valuable work. He also wrote the article on Fröbel in the ninth edition of the *Encyclopædia Britannica*, and edited Locke's *Some Thoughts Concerning Education* (1880), and reprinted with notes Mulcaster's *Positions* (1888).

QUICK-FIRING GUNS. See RAPID-FIRE GUNS; MACHINE GUNS; ARTILLERY.

QUICKSAND. A loose sand into which solid bodies readily sink. Quicksands are composed of water-worn and rounded particles which under ordinary pressure do not pack together and when moistened behave like a fluid. Any heavy object placed upon the surface is quickly swallowed up, leaving no trace behind; thus at Pueblo, Colorado, in 1875 a locomotive and train sank out of sight after being derailed and could not be located, although probed for to a depth of 50 feet. In conducting mining and engineering operations it is sometimes necessary to freeze the quicksand by sinking pipes at intervals, which are then used for circulating brines or other liquids at low temperature.

QUICKSILVER. See MERCURY.

QUIDOR, JOHN (1800-81). An American figure painter, born in Gloucester County, N. J. In 1826 he removed to New York City, where he studied under Jarvis and Inman. Afterwards he lived for a time on a farm near Quincy, Ill.,

but returned to New York City in 1851, and there established himself in a studio on Pearl Street, as an artist and teacher. His most notable pupil was Charles Loring Elliott (q.v.). Quidor exhibited at the Academy and seems to have held a dignified position among his fellow artists, although much of his work was done for the panels of stage coaches and fire engines. He was a personal friend of Washington Irving, whose *Knickerbocker History of New York* gave him the subjects for the following paintings, all of which are in the Museum of the Brooklyn (N. Y.) Institute of Arts and Sciences: "Dancing on the Battery" (c.1860), "Rip Van Winkle Reaches the Gnomes in the Catskill Mountains" (1861), "Ichabod Crane Pursued by the Headless Horseman" (1862), "Peter Stuyvesant's Wall Street Gate" (1864), "Voyage of the Good Oloff Up the Hudson" (1866), and "The Voyage from Communipaw to Hell Gate" (1866). The most remarkable of these illustrations, "The Dance on the Battery," shows much imagination, a Monticelli-like handling of color, and a genius for composition. Quidor also painted religious subjects, such as "Jesus Blessing the Sick." His work was usually on a large scale.

QUIDS. In American political history, the name applied to a faction of the Republican Party, led by John Randolph (q.v.), which during the years 1805-11 opposed on many points the great majority of the party, led by Jefferson and Madison. Randolph's following in Congress at this time was never considerable. The faction contended against the enactment of the Embargo, and endeavored to prevent the nomination of Madison in 1808. The name 'Quid' is said by some to have been taken from the phrase *tertium quid*, applied to Randolph and his supporters in allusion to their being unidentified with either of the then dominant parties; by others it is said to have been given to the faction in allusion to its having been cast out from the Republican Party.

QUIETISM (Neo-Lat. *quietista*, from Lat. *quies*, quiet, rest). A name applied to the tenets of a somewhat numerous class of mystical sects, who, in different ages and from the earliest Christian times, have held that the most perfect state of the soul is one of quiet in which it ceases to reason, or to reflect either upon itself or upon God, and, in a word, to exercise any of its faculties, its sole function being passively to receive the infused heavenly light which, according to the view of the Quietists, accompanies this state of inactive contemplation. The earliest sects of this kind in Christian history are the Eucharites or Messalines of the fourth century, the Hesychasts among the Greek monks of Mount Athos in the sixth century, and in the West the followers of Scotus Erigena, who in the ninth century taught a form of theosophy with Quietistic tendencies. Besides these there are the Beghards in the twelfth century, the followers of Master Eckhart in the thirteenth and fourteenth centuries, the Brethren of the Free Spirit, and later the Illuminati in Spain.

Not all those called by the common name of Quietists at various times have held the same doctrine. Indeed, there has been a decided difference of opinion between different sects; and some sects called by other names have held Quiet-

ist doctrines. The Quakers, for instance, with so curiously opposite a name, hold the doctrine of infusion of divine light in quiet. The common tendency of the sects consists in making perfection here on earth depend on a state of uninterrupted contemplation during which the soul remains quiet or passive under the influence of God's spirit without forming the ordinary acts of faith, hope, love, etc., without desiring heaven nor fearing hell. Most of these doctrines are of a purely speculative character and involve but little of practical consequence, whether for good or for evil. But from the belief of the lofty and perfect nature of the purely passive state of contemplation there is but a step to the fatal principle in morals that in this sublime state of contemplation all external things become indifferent to the soul, which is thus absorbed in God; so complete is the self-absorption, so independent is the soul of corporeal sense, that the most criminal representations and movements of the sensitive part of the soul and even the external actions of the body fail to affect the contemplating soul or to impress it with their debasing influence. This led to gross immorality in writing at all times, and sometimes to immorality of act. See FÉNELON; HESYCHASTS; BRETHREN OF THE FREE SPIRIT; MOLINOS; MYSTICISM.

QUILIMANE, kē'lé-má'ná. A port in Portuguese East Africa, situated on the River Quilimane, about 6 miles inland (Map: Congo Free State, G 6). It lies in a low unhealthy region, but has a good harbor. Its commerce amounted in 1900 to nearly \$1,000,000. The population is estimated at 7000.

QUILL (LGer. *quiele*, *kiel*, MHG. *kil*, Ger. *Kiel*, quill). One of the large feathers of the wings and tails of birds, remiges and rectrices. (See FEATHER.) Their hollow tubes, properly cleared of all oily or fatty matter and dried, are used as receptacles for gold-dust and various purposes, but chiefly as writing pens, all of which were made from feathers until comparatively recently. Those plucked from geese were most generally used, but swan and turkey quills were not uncommon; and for very fine writing, and for pen-and-ink drawing, crow-quills were preferred to all others. At one time the collection and preparation of quills formed a very large and important branch of commerce; but the introduction of metallic pens has reduced it to very small limits, and few if any quill pens are made in the United States. The conventional representation of a pen as a 'quill pen,' and such words as 'quill-driver' and 'penknife,' are relics of the custom.

QUILLAYUTE, kil'lá-yoot'. A small tribe formerly occupying a portion of the coast southward from Cape Flattery, Washington, and now gathered upon a small reservation of one mile square near the village of their name, in the same vicinity. Together with the Hoh, on another small reservation about twenty miles farther down the coast, and the recently extinct Chemacum of Port Townsend on Puget Sound, they constitute a distinct linguistic group which has been designated the Chimakuan stock. They made their first treaty with the Government in 1855. Like the neighboring Makaw (q.v.), they are entirely seafaring. The three tribes live on fish. The women make baskets and curios for

sale, and some of the Indians sell a few head of cattle during the year. Consumption is always present among them and every year is the cause of several deaths. The Quillayute have a school, but no missionary work has ever been attempted among either them or the Hoh. In 1889 the two tribes numbered respectively 252 and 71. In 1901 they had decreased to 234 and 66.

QUILLBACK, See SKIMBACK.

QUILLER-COUCH, *kwēch*, ARTHUR THOMAS (1863—). An English author. He was born in Cornwall, November 21, 1863, and educated at Clifton and at Trinity College, Oxford, where he remained for two years as classical lecturer after taking his degree. Then he removed to London and devoted himself to literary work. He was one of the original staff of *The Speaker*, and retained his connection with it until 1899, though after 1891 he resided chiefly in his native county of Cornwall, whose scenery, traditions, and characters he has faithfully depicted in most of his books. These include: *Dead Man's Rock* (1887); *Troy Town* (1888); *The Splendid Spur* (1889); *The Delectable Duchy* (1893); *Wandering Heath* (1895); *Ia* (1896); *The Ship of Stars* (1899); *Old Fires and Profitable Ghosts* (1900); *The Adventures of Harry Rerel* (1903). In all of these a vivid and dramatic imagination, free from any touch of morbidity, is shown. This quality, together with his mastery of style, led to his being selected after Stevenson's death to complete the latter's unfinished novel *Saint Ives*. Quiller-Couch, who is widely known by his pseudonym of 'Q,' has also edited two excellent anthologies of English verse, and published some of his own, both serious and playful, as well as a volume of reviews under the title *Adventures in Criticism* (1896).

QUILLIAM, WILLIAM HENRY ABDULLAH (1856—). An English writer on Mohammedanism, born in Liverpool, and educated at the Liverpool Institute and at King William's College, Isle of Man. He became a solicitor in 1878, went to Morocco in 1884, and became a Mohammedan convert in the next year. Afterwards he traveled in Morocco, Turkey, and Persia, and in 1895 received the title Sheik-ul-Islam of the British Isles from the Ameer of Afghanistan. He wrote a few novels and *Faith of Islam* (1887), *Fanatics and Fanaticism* (1888), *Religion of the Sword* (1889), *Moscs, Christ, and Mohammed* (1897), and *Studies in Islam* (1898).

QUILLINAN, EDWARD (1791-1851). A British poet, born at Oporto, in Portugal. Educated at a Roman Catholic school in England, he returned to Portugal and took a position, against his inclination, in his father's counting-house. On the French invasion (1807) the family fled to England. Edward entered the army, and served for some time in the Peninsular War. Retiring from the army (1821), he settled in the Lake District near Wordsworth, whose daughter Dorothy he married. He died at Ambleside. Quillinan wrote a good deal of mediocre verse and one novel. His last years were given to a translation of the *Lusiad* of Camões, which was never completed. His wife, DOROTHY QUILLINAN (1804-1847), was author of a charming book of travel entitled *A Journal of a Few Months' Residence in Portugal and Glimpses of the South of Spain* (1847).

QUILLOTA, *kél-yō'tá*. A town in the Province of Valparaiso, Chile, situated in a pleasant plain on the Aconcagua River, 20 miles northeast of Valparaiso, and on the railroad between that city and Santiago (Map: Chile, C 10). It is the centre of a copper-mining district. Population, about 12,000.

QUILOA, *ké-ló'á*. A seaport town of German East Africa. See KILWA KIVINJE.

QUILP. A repulsive and malicious dwarf in Dickens's *Old Curiosity Shop*, who delighted in tormenting his pretty, timid little wife, Betsy. He called himself a ship-breaker, dealing in old iron and wood on Tower Hill, and at last drowned himself when about to be arrested for felony.

QUIL'TER, HARRY (1851—). An English artist and author, born at Lower Norwood, in Surrey, January 24, 1851. Educated at Trinity College, Cambridge, he subsequently studied art at Bruges and in Italy. In 1878 he was called to the bar at the Inner Temple. Between 1876 and 1888 he was on the staff of several London periodicals. He founded and conducted for two years (1888-90) the *Universal Review*. Among his published books are *Giotto* (1880), *Sententia Artis* (1886), *Preferences in Art, Life, and Literature* (1882), and *Is Marriage a Failure?* (1888). With his wife's help he brought out, at Christmas, 1898, an edition of Browning's *Pied Piper of Hamelin* with beautiful type and border designs.

QUIMPER, *kān'pār'* (Breton *kemper*, confluence). The capital of the Department of Finistère, France, picturesquely situated at the confluence of the Steir and the Odet, about 35 miles south-southeast of Brest (Map: France, B 3). The Cathedral of Saint Corentin, a stately and richly ornamented Gothic edifice commenced in 1424, is the principal building. The eleventh-century Church of Loemaria and the sixteenth-century Church of Saint Mathieu are interesting. The educational institutions include a lyceum, public library, and museum. Potteries, tan-yards, breweries, and paper factories are the chief industrial establishments, and a coasting trade and sardine-fishing are actively carried on. Quimper was the ancient capital of Cornouailles. Population, in 1901, 19,441.

QUIMPERLÉ, *kān'pār'lá'*. The capital of an arrondissement in the Department of Finistère, France, on the Laita, 12 miles northwest of Lorient (Map: France, C 4). Its chief buildings are the fourteenth-century Church of Saint Michel, and the Church of Sainte Croix, modeled after the Holy Sepulchre at Jerusalem. It has fisheries and carries on a coasting trade. Population, in 1901, 9036.

QUIN, JAMES (1693-1766). A celebrated actor of Irish descent, born in London. He made his first appearance on the stage about 1714 at Dublin as Abel in *The Committee*. Shortly after he proceeded to London, where he was engaged at Drury Lane, but for quite inferior parts. In 1716, however, the sudden illness of a leading actor led to Quin's being called on to sustain the character of Bajazet in *Tamerlane*. His success was marked. Next year he went to Lincoln's Inn Fields, where he remained as a principal actor for fourteen years. Among his best parts were Captain Macheath in the *Beggars' Opera*, Falstaff in the *Merry Wives of Windsor*, and Sir

John Brute in *The Provoked Wife*. In 1734-35 he returned to Drury Lane, and until the appearance of Garrick in 1741 he was, by universal consent, the first actor in England. In 1751 he withdrew from the stage as a regular actor and made his home at Bath, where he died. There is an unreliable *Life of Mr. James Quin, Comedian, With the History of the Stage from His Commencing Actor to His Retreat to Bath*, etc. (London, 1766; reprinted ib., 1887). Consult also Doran, *Annals of the Stage* (ed. Lowe, London, 1888); Cibber's *Apology* (ed. Belchambers, London, 1822); Davies, *Life of Garrick* (London, 1780).

QUINAULT, ké'nó', PHILIPPE (1635-88). A French librettist and dramatist, born in Paris, June 3, 1635. He wrote lyric tragedy, for which the music was furnished by Lulli. Quinault was precocious, his first play having been produced in 1653, and his earliest comedies are among his best: *Les rivaux*; *L'amant indiscret* (1654); *Le fantôme amoureux* (1659); *La mère coquette* (1665). His tragedies and tragi-comedies are slight. *Psyché*, the first of his lyric dramas (1671), was written in collaboration with Molière and Corneille. After this he devoted himself almost entirely to libretto-work, remarkable for its ingenious artistry. In this kind his masterpieces are *Amadis* (1684), *Roland* (1685), and, best of all, *Armide* (1686). In 1687 Lulli died and Quinault began to write on the *Destruction of Heresy*, a poem which he did not live to complete. His works were edited in 5 vols. (1739 and 1778); *Selected Works* (1824-42). Consult Fournel, *Les contemporains de Molière* (3 vols., Paris, 1863-75).

QUINCE (variant of obsolete Eng. *quine*, from OF. *coïn*, Fr. *coign*, quince, from Lat. *cydonium*, from Gk. *κυδώνιον*, *kydōnion*, quince, Cydonian, sc. *μήλον*, *mēlon*, apple, from *Κυδωνία*, *Kydōnía*, *Κυδωνίς*, *Kydōnis*, Cydonia, an ancient city of Crete); *Prunus Cydonia*. A shrub or small

than 2000 years, it has developed few varieties. It is chiefly employed as a preserve, for jellies, and for flavorings in other fruit preparations. Certain varieties, notably the Angiers, are extensively employed as a stock for dwarfing pears. The quince is propagated by cuttings or mound layers. It thrives best on strong, rententive, well-drained soil. The trees are set 15 feet apart each way, given clean culture, and headed in sufficiently to hold the leading branches in check and to thin the fruits, which, since they ripen late, should not be gathered until after early frosts. They must be as carefully handled as pears. The most extensive and profitable orchards in the United States are located in western New York. Consult Meech, *Quince Culture* (New York, 1896).

QUINCE CURCULIO. The larva of a weevil, as *Conotrachelus nenuphar*, which attacks the quince and related trees. Its habits and treatment are the same as specified under PEAR INSECTS.

QUINCE INSECTS. The quince is attacked by many of the insects which have the general habit of feeding upon rosaceous plants, and especially very many of those forms which are found upon pears and apples, although it is rather less susceptible than either of these fruits. The quince scale (*Aspidiotus cydonia*) is found upon the quince tree in the Southern United States. It is grayish in color, somewhat resembling the San José scale, but is more transparent and is very convex in form. The quince curculio (*Conotrachelus crategi*) is a species closely related to the plum curculio, although differing in general appearance. It is a broad-shouldered snout-beetle, larger than the plum curculio and having a longer snout. It is ash-gray in color, mottled with ochre and whitish, and with a dusky subtriangular spot at the base of the thorax above. It is indigenous to the United States, and appears in the month of June,

puncturing the young fruit, and making a cylindrical hole in which the egg is placed. The egg hatches in a few days, and the larva burrows in the fruit near the surface. It becomes full-grown in a month and falls to the ground, burying itself to a depth of from two to three inches, remaining there through the winter, and transforming to pupa early in May. The pupa stage is short, and the adult beetle emerges almost as soon as the fruit is set. The adult also feeds upon the quince, burying itself completely in the pulp of the fruit. It occasionally attacks the pear.

Among the caterpillars which feed upon quinces the bag-worm (q.v.) is perhaps the most destructive.

QUINCKE, GEORG HERMANN (1834-). A German physicist, born in Frankfort-on-the-Oder. He received the degree of doctor of philosophy in 1858 in the University of Berlin, after having studied at this university and also at Königsberg and Heidelberg. He became privat-docent at the



QUINCE.

crooked tree of the order Rosaceæ, closely related to the apple and pear, which it resembles in leaf, flower, and fruit, but with solitary terminal flowers on the present season's growth. Since the quince cannot be eaten raw, it has a restricted use, and although cultivated for more

University of Berlin in 1859, was appointed professor at the University of Würzburg in 1872, and was called to Heidelberg in 1875 as professor of physics. His doctor's dissertation was on the subject of the capillary constant of Mercury, and his investigations of all capillary phenomena are classical. He also did important work in the experimental study of the reflection of light, especially from metallic surfaces, and carried on prolonged researches on the subject of the influence of electric forces upon the constants of different forms of matter. His contributions to physics and other fields of science are numerous.

QUINCY. A city and the county-seat of Adams County, Ill., 265 miles southwest of Chicago; on the Mississippi River, here spanned by a splendid railway bridge, and on the Wabash, the Chicago, Burlington and Quincy, and the Quincy, Omaha and Kansas City railroads (Map: Illinois, A 4). It is regularly laid out on an elevated bluff. It is the seat of Saint Francis Solanus College (Roman Catholic), opened in 1860; and has a boys' industrial school (Methodist Episcopal), formerly known as Chaddock College, and Saint Mary's Institute (Roman Catholic), besides commercial schools. Other institutions comprise a Conservatory of Music, Saint Mary's and Blessing hospitals, and several homes for the aged and orphans. The public library contains more than 23,000 volumes. The fine buildings of the State Soldiers' and Sailors' Home, the Federal Government building, the court house, and the city hall are among the architectural features of the town. In the public park system of about 107 acres are South Park, Riverside, Washington, Madison, Indian Mounds, and Primrose parks.

Quincy is admirably equipped with transportation facilities for an industrial and commercial centre. It carries on an active trade, and its industries, according to the census of 1900, represented an aggregate capital of \$6,880,000, with a production valued at \$9,235,000. The more important establishments include stove foundries, machine shops, breweries, show-case works, manufactories of incubators, brick-making plants, carriage factories, lime works, clothing factories, flouring mills, a meat-packing establishment, governor and engine works, plow and hay-press works, canning factories, and manufactories of sawed lumber, egg cases, buttons, brass castings, wire fence, etc. The government is vested in a mayor, elected every two years, and a unicameral council, and in administrative officials, many of whom are named by the mayor. Quincy spends annually in maintenance and operation about \$275,000, the principal items of expense being: For schools, \$83,000; for interest on debt, \$49,000; for the fire department, \$28,000; for the police department, \$21,000; and for municipal lighting, \$20,000. Population, in 1890, 31,494; in 1900, 36,252. Settled in 1822 and laid out three years later, Quincy was incorporated as a town in 1834 and in 1839 was chartered as a city. Consult: Redmond, *History of Quincy* (Quincy, 1869).

QUINCY. A city, including within the municipal limits several villages, in Norfolk County, Mass., adjoining Boston on the south; on Quincy Bay, between the Neponset River on the north

and Fore River on the south; and on the New York, New Haven and Hartford Railroad (Map: Massachusetts, E 3). Its area is more than 16 square miles, 2,530 acres of which are in public parks, the most prominent being Merrymount and Faxon. Quincy has the Thomas Crane Public Library with 20,000 volumes, Adams Academy and Woodward Institute, the latter for girls, and a city hospital. There are many points of historic interest in this vicinity; and here was constructed in 1826-27 the first railroad in New England, built for carrying granite and operated by horses. Quincy is primarily a residential suburb of Boston, but has extensive granite quarrying and cutting interests, a large ship-building plant, and rivet and stud works. The government, under a revised charter of 1900, is vested in a mayor annually elected, and a unicameral council. The mayor controls appointments of the heads of all departments, excepting that of the school committee. Other administrative officers are elected by the council, or confirmed by that body upon nomination of the mayor. The school committee is chosen by popular vote. The water supply of Quincy is furnished through the system of the metropolitan district. Population, in 1890, 16,723; in 1900, 23,899.

Settled in 1625 as Mount Wollaston, Quincy is one of the oldest permanent settlements in Massachusetts. About 1629 Thomas Morton (q.v.) gained control and established his famous "New English Canaan," Merrymount. Becoming obnoxious to the Puritans at Boston because of his encouragement of Maypoles and other reprehensible 'idolls,' because of "his great licentiousness of life in all profaneness," he was captured by Miles Standish and shipped off to England. Until 1792, when it was incorporated under its present name in honor of John Quincy, the settlement formed part of Braintree. It was chartered as a city in 1888. It was the birthplace of John Hancock, John Adams, and John Quincy Adams, the two last being buried here under the old 'Stone Temple.' Consult: an address by Adams, *The Centennial Milestone* (Cambridge, 1892); Pattee, *A History of Old Braintree and Quincy* (Quincy, 1878); Hurd, *History of Norfolk County* (Philadelphia, 1884); Wilson, *Where American Independence Was Born* (Boston, 1902); and Adams, *Three Episodes of Massachusetts History* (Boston, 1892).

QUINCY, EDMUND (1808-77). An American author and reformer, prominent as an abolitionist during the anti-slavery struggle. He was born in Boston, and graduated at Harvard in 1827. After the killing of Elijah P. Lovejoy (q.v.) by a mob at Alton, Ill., in 1837, he became an ardent abolitionist of the radical or Garrisonian school, frequently spoke in public, was secretary, for some years, of the American Anti-Slavery Society coöperated with Garrison and Mrs. Chapman in issuing the *Non-Resistant*, a short-lived anti-slavery paper, and wrote many articles and pamphlets in favor of abolitionism. He wrote a novel, *Wensley, A Story Without a Moral* (1854); an excellent *Life of Josiah Quincy* (1867); and *The Haunted Adjutant and Other Stories* (published posthumously, 1885); and edited *Speeches Delivered in the Congress of the United States* (1874).

QUINCY, JOSIAH (1744-75). An American patriot, born in Boston, Mass., February 23, 1744.

He graduated at Harvard in 1763; read law with Oxenbridge Thacher, and was admitted to the bar, rising to a high rank in his profession. He denounced the Stamp Act through the press and at public meetings in Boston, and took strong ground against the exactions of Parliament. In 1770 he and John Adams conducted, in the face of an excited popular feeling, the defense of British soldiers implicated in the Boston massacre; and in the same year he prepared the address of the merchants of Boston on the non-importation agreement, and also wrote a number of essays for the *Boston Gazette*. Both in 1770 and in 1772 he drafted the instructions of the town of Boston to its representatives in the Legislature, and throughout 1771 and 1772 he was a frequent contributor to the *Gazette*, chiefly under the signatures 'Mentor' and 'Marchmont Nedham.' During all these years he maintained a large practice, though finally his health failed, and in 1773 he went to Charleston, S. C., taking advantage of his journey to enter into relations with the Patriot leaders in the Southern and Middle States, and to arrange for a system of communication between them and the leaders of the same party in Massachusetts. In May, 1774, appeared his *Observations on the Boston Port Bill*, which clearly indicated war as the only means of settling the disputes between Great Britain and the colonists, and intimated that independence must be the result. In September of the same year he went to England as the agent of the Patriot Party and there lived on friendly terms with Barré, the Earl of Shelburne, Priestley, and other friends of the colonies, and had interviews with Lords Dartmouth and North. He sailed for home in the spring of 1775, but died on the voyage, April 26th. His *Life* was written by his son Josiah (2d ed., Boston, 1874); and his *Reports of the Supreme Court of Massachusetts Bay, 1761-72*, edited by his great-grand-son, Samuel M. Quincy, appeared in 1865.

QUINCY, JOSIAH (1772-1864). An American lawyer, orator, and man of letters, son of Josiah Quincy (1744-75). He was born in Boston; graduated at Harvard in 1790; studied law, and took an active interest in politics as a leading member of the extreme wing of the Federalist Party in New England. He was a member of the State Senate in 1804, and in 1805 entered Congress, where he became distinguished as a ready, earnest, and fervent orator, in opposition to the policy of Jefferson and Madison. He was one of the earliest to denounce slavery in Congress, and declared in a notable speech of June 4, 1811, that the purchase of Louisiana was a sufficient cause for the dissolution of the Union. This was the first announcement on the floor of Congress of the doctrine of secession. He opposed the war with England with the same fervor. Disgusted with the triumph of the Republican Party and its advocacy of the War of 1812, he declined a reelection to Congress, and devoted his attention largely to scientific agriculture. He became, however, Speaker of the Massachusetts House of Representatives in 1821, a member of the Senate in the following year, and also judge of the municipal court of Boston. In 1823 he was elected mayor of Boston, his administration being signalized by many notable municipal reforms. In 1829 he accepted the presidency of Harvard College, which he held until 1845, intro-

ducing many improvements and reforms in the administration. Among his published works are a memoir of his father (1825); *History of Harvard University* (1840); *The Municipal History of the Town and City of Boston* (1852); and *Life of John Quincy Adams* (1858).

QUINCY, JOSIAH (1802-82). An American administrator, born in Boston, Massachusetts, son of Josiah Quincy (1772-1864). He graduated at Harvard in 1821, and was admitted to the bar. He became a member of the Boston city council in 1833, and was its president from 1834 to 1837. In 1842 he was president of the Massachusetts Senate, and from 1845 to 1849 was Mayor of Boston. By his efforts and during his mayoralty the Cohituate aqueduct was completed, the police force was reorganized, and a large tract of public marshland near the South Bay was filled in, graded, and sold. A volume of extracts from his diaries, *Figures of the Past*, was published in 1883.

QUINCY, JOSIAH (1859-). An American politician, son of the preceding, born in Quincy, Mass. He was admitted to the bar, but never practiced. He was a member of the Massachusetts Legislature for four years, and in 1893 served as Assistant Secretary of State for six months. From 1895 to 1899 he was Mayor of Boston.

QUINCY, KĀN'sĕ', QUATREMÈRE DE. See QUATREMÈRE DE QUINCY.

QUINET, kĕ'nĀ', EDGAR (1803-75). A French poet, publicist, and historian of literature, born at Bourg, February 17, 1803. He was educated for the army, but refusing a soldier's life, he published at twenty his justification in *Les tablettes du juif errant* (1823). His next work was a translation of Herder's *Ideen zur Philosophie der Geschichte der Menschheit* (1827), to which he prefixed an introduction that won him the friendship of Cousin and Michelet. After travel in Germany, Italy, and England, he was sent by the French Institute to Greece (1829) and wrote *La Grèce moderne* (1830). He now began to contribute political essays to the newly founded *Revue des Deux Mondes* and recurred to the legend of the Wandering Jew in *Ahasvérus* (1833). This was followed by the less successful poems, *Napoléon* (1835) and *Prométhée* (1838). His *Examen de la vie de Jésus* is a philosophy of religion as the substance of humanity and the apotheosis of personality in answer to Strauss's *Leben Jesu*. His *Génie des religions* (1842) brought him a call to the Collège de France, where he roused great enthusiasm by lectures on the Jesuits, Ultramontanism, and Christianity in relation to the French Revolution. At this period Quinet's partisanship began to bias his historical judgment. Michelet shared in his attack on the Jesuits, which was silenced by the Government in 1846. Quinet took an active part in the Revolution of 1848, sought to unmask Napoleon, and was banished (1852). At Brussels he wrote *Les esclaves* (1853) and *La révolution religieuse au XI^{ème} siècle* (1857). Removing to Vevytau, on the Lake of Geneva, he published *Merlin l'enchanteur* (1860), the autobiographical *Histoire de mes idées* (1860), and *Histoire de la campagne de 1815* (1862) and *La révolution* (1865), both tracing national disaster to a disregard of

righteousness. The fall of Napoleon III. brought him back to Paris. He was active during the siege and in the National Assemblies at Bordeaux and Versailles. During this period he wrote *La création* (1870), *La république* (1872), and *L'esprit nouveau* (1874). His *Mémoires d'exil* were published in 1870 and *Le livre de l'exilé* posthumously with two volumes of letters in 1877 and four others (1884-86). Quinet's complete works are in 26 vols. (Paris, 1877-79). Consult: Chassin, *Edgar Quinet: sa vie, ses œuvres* (Paris, 1859); *Edgar Quinet depuis l'exil*, by his wife (ib., 1889); Heath, *Edgar Quinet, His Early Life and Writings* (London, 1881); Dowden, *Studies in Literature* (ib., 1878); Montégut, *Mélanges critiques* (Paris, 1887).

QUINETTE DE ROCHEMONT, kě'nět' de rôsh'môn', EMILE THÉODORE, Baron (1838—). A French engineer, born in Soissons, and educated at the Ecole Polytechnique and at the Ecole des Ponts et Chaussées. He was appointed engineer-in-chief of the port of Havre in 1883, inspector-general of bridges and roads in the Ministry of Public Works in 1892, and the same year took the chair of maritime works at the Ecole des Ponts et Chaussées. His writings include *Mémoire sur le Clyde, Glasgow, Port Glasgow, et Greenock* (1869), *Notes sur les phares électriques de la Hère* (1870), and books on various European ports.

QUINIC ACID. See KINIC ACID.

QUINIDINE. See QUININE; ALKALOIDS.

QUININE, or **QUININA** (Neo-Lat. *quinina*, from Neo-Lat., Sp., Port., Quichua *quina*, quinine). A white amorphous or crystalline powder with a very bitter taste, alkaline, very faintly soluble in water, but soluble in alcohol, dilute acids, ether, or chloroform, and derived from the bark of *Cinchona calisaya*, *Cinchona rubra*, and other varieties of Peruvian bark. The symbol of quinine is $C_{20}H_{21}N_2O_2 + 3H_2O$. Its dose is from one to forty grains. There are five official salts of quinine. *Quinine sulphate* is the white, crystalline powder commonly called quinine, extremely and persistently bitter, faintly soluble in water (1 in 740 parts), moderately soluble in alcohol, soluble in weak acid. Its symbol is $(C_{20}H_{21}N_2O_2)_2 \cdot H_2SO_4 + 7H_2O$. Its dose is from one to forty grains. *Quinine bisulphate* occurs in clear, colorless crystals or needles, very bitter and with an acid reaction, soluble in water and alcohol. The symbol is $C_{20}H_{21}N_2O_2 \cdot H_2SO_4 + 7H_2O$. Dose, one to forty grains. *Quinine hydrobromate* occurs in colorless needles, bitter, soluble in fifty-four parts of water, freely in alcohol. Symbol, $C_{20}H_{21}N_2O_2 \cdot HBr + H_2O$. Dose, one to twenty grains. *Quinine hydrochlorate* occurs in white needles arranged in tufts, bitter, soluble in thirty-four parts of water, freely soluble in alcohol, and suitable for hypodermic use. Its symbol is $C_{20}H_{21}N_2O_2 \cdot HCl + 2H_2O$, and its dose is from one to ten or twenty grains. *Quinine valerianate* occurs in white pearly crystals with the characteristic repulsive odor of valerian, bitter, soluble in alcohol, and in one hundred parts of water. Its symbol is $C_{20}H_{21}N_2O_2 \cdot C_8H_{10}O_2 + H_2O$; its dose, one to three grains.

Among the unofficial salts of quinine are the carbamide hydrochlorate, the amorphous borate, and equinine (the ethyl carbonate).

Quinine is used in medicine as a bitter tonic,

an antiperiodic, and antipyretic. It has also antiseptic properties. It depresses the heart when given in large doses, and after long-continued use it affects the hearing unfavorably. It is excreted with the urine and occasionally produces renal and vesical irritation. Small doses produce hyperemia of the brain, with a feeling of exhilaration, while large doses cause cerebral congestion with vertigo, staggering, headache, deafness, delirium, and even coma, comprising the condition termed cinchonism.

The principal use of quinine is in malarial affections, in which it reduces the fever, increases the numbers of the white blood-corpuscles, prevents the acetification and decay of the blood, and poisons the plasmodia which cause the disease. In some cases it acts more advantageously when combined with capsicum or with arsenic, or with potassium nitrate. The custom of taking quinine frequently for catarrhal attacks or as a prophylactic is very harmful. Besides the injurious effects upon the hearing, which are positive and permanent, it seriously weakens the heart and renders the system so used to it that the drug becomes useless when required. See MALARIA AND MALARIAL FEVER; INTERMITTENT FEVER; AGUE.

QUINISEXT (from Lat. *quini*, five each + *scxtus*, sixth). The name given in Church history to a council which, being regarded as a sort of supplement of the fifth and sixth general councils, is called by a title which combines both. The fifth general council, held in 553, on the subject of the three chapters, enacted no canons of discipline. In like manner the sixth, held against the Monothelites in 680-81, was confined almost entirely to doctrinal decisions. In order to supply the want, a numerous body of bishops, 211 in number, assembled in 692, in a hall of the Imperial palace at Constantinople, called the Trullus, from which the council is sometimes known as the Trullan Synod. It was a purely Oriental council, and was not approved by the Western Church and the Pope. Its decrees are purely disciplinary, and it is chiefly important for its broad distinction between the legislation of the East and that of the West on the subject of clerical celibacy. The Quinisext Council, while prohibiting the marriage of any one who is in priest's orders, permits a married man to receive after marriage the order of subdeacon, deacon, or priest, but not of bishop (canon three). Against this the Roman pontiffs vigorously protested. Another peculiar canon of this synod (fifty-fifth) prohibits fasting on Saturday, even in Lent.

QUINNAT SALMON (North American Indian name). The principal and typical species (*Oncorhynchus tshawytscha*) of Pacific Coast salmon. (See SALMON.) It is found on both coasts of the North Pacific, southward as far as central California and Northern China, and is especially abundant in the Sacramento and Columbia rivers. Other names are 'king,' 'Chinook,' and 'tyee' salmon.

QUINOA (Quichua name), *Chenopodium Quinoa*. An annual plant, native of Chile and the high tablelands of Mexico, cultivated for its seeds, which as meal form the principal food of the people where it is indigenous. They are sometimes fed to poultry in France and Germany. On account of insect attacks, the plant has proved unsatisfactory at the California Experiment Sta-

tion. It is sometimes cultivated as a substitute for spinach.

QUINOLINE, or **LEUCOLINE**, C_9H_7N . An organic base to which many vegetable alkaloids are chemically more or less closely related. It may be obtained by the distillation of quinine, cinchonine, or similar substances, with caustic potash. It occurs, together with isoquinoline, a substance of the same molecular composition as quinoline, in coal-tar, and in bone-oil, and may be isolated in a somewhat impure state from the fraction distilled over between 236° and 243° C. It is now prepared on a large scale by a purely artificial method, known as Skraup's method. This consists in heating 120 parts of glycerin with 100 parts of strong sulphuric acid, 38 parts of aniline, and 24 parts of nitro-benzene, a somewhat violent reaction soon setting in. After the reaction has subsided, the mixture is kept boiling for several hours, then cooled, diluted with water, and subjected to distillation in a current of steam until the portion of the nitro-benzene that has remained untransformed, is completely removed. The quinoline remains fixed in combination with sulphuric acid, but on adding an excess of soda and again distilling in a current of steam, it passes over almost pure; after drying, it may be further purified by fractional distillation. Three chemical transformations probably take place, in successive order, in this process: First, the action of sulphuric acid on glycerin causes the formation of acrolein, $CH_2:CH.CHO$; next, acrolein combines with aniline, $C_6H_5.NH_2$, yielding acryl-aniline, $C_6H_5.N:CH.CH:CH_2$; finally, by the oxidizing action of nitro-benzene, acryl-aniline loses hydrogen and is converted into quinoline, C_9H_7N . Pure quinoline has a specific gravity 1.095 at 20° C. and boils at 239° C. It is scarcely soluble in water, but dissolves freely in alcohol and in ether. It is a tertiary aromatic base and combines with acids to form crystallizable salts. The peculiar odor of quinoline is characteristic. Quinoline is largely used in the arts, especially in the manufacture of aniline colors. In medicine it is used as an antiseptic and as a substitute for quinine; it has also been found of great value in diphtheria, a weak alcoholic solution of quinoline being applied to the diseased membranes.

The chemical constitution of quinoline is represented by the following graphic scheme:

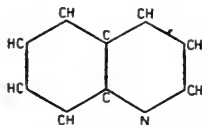

It may be seen that the molecule of quinoline is composed of two nuclei, the benzene nucleus and the pyridine nucleus. The substance *isoquinoline*, mentioned above, has a much similar constitution and its chemical properties are much the same as those of quinoline itself; its boiling-point is, however, 241° C., i.e. two degrees higher than that of quinoline; besides, at ordinary temperatures it is solid, its melting-point being about 22° C.

QUINONES (from Neo-Lat., Sp. Port., *Quicha quina*, quinine). An interesting group of carbon compounds belonging to the so-called aromatic series. Theoretically the quinones may be defined as benzene derivatives in whose molecules

two oxygen atoms are directly linked to the benzene nucleus. (See CARBON COMPOUNDS.) The simplest member of the group is the substance called *benzoquinone*, which may be readily prepared by the action of potassium bichromate and sulphuric acid on aniline; from the mixture obtained by this reaction, benzoquinone is extracted with ether: the ether is then distilled off, and the residue is purified by sublimation or by recrystallization. Benzoquinone has a peculiar, irritating odor; if pure it melts at 116° C.; its molecular formula is $C_6H_4O_2$, and its chemical constitution is represented by one of the following graphic formulas:

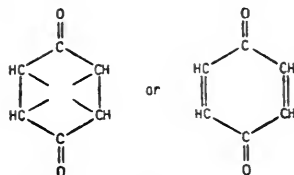

QUINQUARTICULAR CONTROVERSY.

See ARMINIANISM.

QUINQUENNIAL PRESCRIPTION (Lat. *quinquennialis*, from *quinquennis*, of five years, from *quinque*, five + *annus*, year). A period of five years allowed by the law of Scotland within which payment of sums on all bargains concerning movables, arrears of rent in some leases, multures, ministers' stipends, arrestments, must be enforced.

QUINSY (formerly also *quincy*, *squincy*, from OF. *squinancie*, *esquinance*. Fr. *esquinancie*, from Lat. *cynanche*, from Gk. *κυνάγχη*, *kynanche*, sort of sore throat, from *κύων*, *kýōn*, dog + *ἀγχειν*, *anchein*, to choke). An acute inflammation of the loose tissue surrounding the tonsil, terminating usually in suppuration. Quinsy is most prevalent between the ages of fifteen and forty, children and old persons seeming to be exempt. A rheumatic tendency predisposes to the disease. The exciting cause is sudden and unequal exposure of the body to cold or wet. The affection is usually confined to one tonsil, but both may be successive or simultaneously involved. One attack predisposes to others. The disease is ushered in with feelings of chilliness and exhaustion followed by a temperature of 102° or 103° F. These symptoms are accompanied by severe pain in the region of the tonsil. The latter becomes so swollen as to interfere with deglutition. The mouth can only be partly opened and with great pain, and the taking of food, except in liquid form, becomes impossible. The peritonsillar tissues become swollen and painful. The voice is muffled and indistinct, and sleep is almost impossible. Severe cases are marked by an intensity of all these symptoms, successive chills and sweats, delirium at night. Although the disease is acute and painful, it rarely proves fatal. Cases have occurred in which bursting of the abscess into the larynx during sleep produced instant death. The ordinary duration of suppurative tonsillitis is from five to eight days. At the end of this time the abscess bursts, all the symptoms disappear, and prompt recovery ensues. In its early stage the affection may often be cut short or aborted if prompt measures for relief are taken. These consist in rest, free purgation by a saline cathar-

tic, followed by a single large dose of quinine; in addition the application of warmth and the use of antiseptic anodyne and astringent gargles. If the tonsillitis is of rheumatic origin salicylate of soda may be given. When suppuration has become inevitable, hot turpentine stupes or poultices applied over the angle of the jaw will hasten the formation of pus. Even before the first indication of pointing the abscess should be freely incised and the pus evacuated. This procedure is attended with immediate relief. Chronically diseased tonsils should be removed to prevent future attacks.

QUINT, ALONZO HALL (1828-96). An American clergyman and army chaplain, born at Barnstead, N. H. He graduated at Dartmouth in 1846, and at the Andover Theological Seminary in 1852. From 1853 until 1863 he was pastor of the Central Congregational Church at Roxbury, Mass., and from 1855 to 1861 he was a member of the Massachusetts Board of Education. At the outbreak of the Civil War he became chaplain of the Second Massachusetts Volunteers and served with them until 1864. After the war he was pastor in turn of several Congregational churches. He was a vigorous and interesting writer, and published *Army Notes* (1864), and *The Records of the Second Massachusetts Regiment 1861-65* (1867); was editor of the *Congregational Quarterly* and the *Congregational Year-book*, and wrote frequently for religious periodicals. He was an organizer, and for many years was secretary of the National Council of Congregational Churches.

QUINTAIN (OF. *quintaine*, *cuintaine*, from ML. *quintana*, *quintain*, Lat. *quintana*, street in the camp between the fifth and sixth maniples, containing the market and place for exercise, from *quintanus*, fifth, from *quincus*, five), or **QUINTIN**. An instrument used in the ancient practice of tilting on horseback with the lance. It consisted of an upright post, surmounted by a crossbar turning on a pivot, which had at one end a flat board, at the other a bag of sand. The object of the tilter was to strike the board at such speed that the rider was past before the bag of sand, as it whirled round, could hit him on the back.

QUINTANA, KÉN-TI'NÁ, MANUEL JOSÉ (1772-1857). A Spanish author and statesman, born at Madrid. He studied at Salamanca, and became a lawyer in Madrid, where his house was a resort of the advanced Liberals of the time. Among his earliest productions were his patriotic "Odes," which gave him a place in the first rank of Spanish poets. On the outbreak of the War of Spanish Independence he made good use of his lyric gift to stimulate the patriotism of his countrymen. He also acted as secretary of the Cortes and regency, and distinguished himself as editor of the *Seminario Patriótico*, and as author of the manifestos of the insurrectionary juntas, and of most of the official statements of the Cortes. On the restoration of Ferdinand VII. in 1814. Quintana's liberalism caused his imprisonment for six years. Released in 1820, he was received in Madrid with acclamations, and was appointed President of Public Instruction in 1821. In 1833 he was made tutor of the Infanta Isabella and was created a Senator in 1835. He also held office as Director-General of Public Instruction up to

1851. He died at Madrid. Quintana held a high place as a poet, but his fame rests chiefly on his celebrated work *Vidas de Españoles célebres* (3 vols., 1807-34). He also wrote several tragedies, and edited a collection of Castilian poetry. His patriotic odes earned him the name of the "Spanish Tyrtaeus." The most complete edition of his works is that of Gonzales Rojas (Madrid, 1897-98). Consult: Menendez y Pelayo, *D. Manuel-José Quintana*, vol. iii. of the *España del siglo XIX* (Madrid, 1887); and Píneyro, *Manuel José Quintana* (Paris and Madrid, 1892).

QUINTET (It. *quintetto*, from *quinto*, Lat. *quintus*, fifth, from *quincus*, five). A musical composition for five voices, or for five instruments, all the parts of which are *real*. The instruments composing a quintet may be of various kinds, most frequently the regular string quartet with pianoforte. Quintets have also been written for two violins, two violas, cello (Bocherini); for two violins, viola, and two cellos (Schubert op. 163); for two violins, viola, cello, and double bass (Onslow); and for one violin, viola, cello, double-bass, and piano (Schubert, Trout-quintet, op. 114). Often wind instruments are also introduced, as the string quartet with clarinet (Mozart). Mozart has also written a quintet for wind-instruments only (oboe, clarinet, horn, bassoon) with piano. An effective quintet was written by B. O. Klein for voice (soprano), violin, cello, horn, and piano. The music written for a quintet is of the same character as that for a quartet (q.v.), although the form is more difficult.

QUINTILIAN (MARCUS FABIUS QUINTILIANUS) (c.35-c.97 A.D.). A Roman rhetorician, born at Calagurris (the modern Calahorra), in Spain. He attended in Rome the lectures of Domitius Afer, who died in 59. After this date, however, he revisited Spain, whence he returned in 68 to Rome, in the train of Galba, and began to practice as an advocate, in which capacity his reputation became considerable. He was more distinguished, however, as a teacher of elocution than as a practicing orator, and his instruction came to be the most eagerly sought after among all his contemporaries, while among his pupils he numbered Pliny the Younger and the two grand-nephews of Domitian. He was the first public teacher who benefited by the endowment of Vespasian and received a fixed salary from the Imperial exchequer, and as a mark of Imperial favor he was invested with the insignia and title of consul. His professional career as a teacher of eloquence, commencing probably with 69, extended over a period of 20 years, after which he retired into private life, and died probably about 97. The reputation of Quintilian in modern times is based on his great work entitled *De Institutione Oratoria Libri XII.*, a complete system of rhetoric, which he dedicates to his friend Marcellus Victorius, himself a Court favorite and orator of distinction. It was written after he had ceased to be a public teacher, and was the fruit of two years' labor. During its composition, however, he was still, in the lifetime of Domitian, acting as tutor to the grand-nephews of that Emperor. In the first book he discusses the preliminary training through which a youth must pass before he can begin those studies which are requisite for the orator. The second book treats of the first principles of

rhetoric, and contains an inquiry into the essential nature of the art. The subjects of the five following books are invention and arrangement; while those of the eighth, ninth, tenth, and eleventh are composition (embracing the proper use of figures of speech) and delivery. The last, and, in the author's view, the most important, book is devoted to the various requisites for the formation of a finished orator, such as his manners, his moral character, his mode of undertaking, preparing, and conducting causes, the style of eloquence most advantageous to adopt, the age at which pleading should be begun, and at which it should be left off, and other allied topics. The entire work is remarkable for its sound critical judgments, its purity of taste, and the perfect familiarity it exhibits with the literature of oratory. The condensed survey of Greek and Roman literature with which the tenth book commences has always been admired for its correctness and animation. The declamations, amounting to 164, which have been ascribed to him, are now believed to be spurious, as they evidently belong to different authors, and even different epochs. The *Dialogus de Oratoribus* of Tacitus was formerly ascribed to Quintilian. Early editions of Quintilian are those of Gronovius (Leyden, 1665); Burmann (Leyden, 1720); and of Spalding and Zumpt (Leipzig, 1798-1829, containing a lexicon). The best modern editions of the *Institutio Oratoria* are by Hahn (2 vols., Leipzig, 1868-69), Meister (2 vols., Prague, 1886-87), and Bonnell (2 vols., Leipzig, 1896). Book I. alone is edited by Fierville (Paris, 1890); and Book X. by Meister (Leipzig, 1887) and Peterson (Oxford, 1891). The last English translation is by Watson (London, 1856). The *Declamationes* are published by Ritter (Leipzig, 1884).

QUINTUPLET, or **QUINTOLE** (from Lat. *quintus*, fifth + *-plus*, -fold). In music, a group of five notes, formed of a note divided into five instead of its proper complement of four parts, the five notes having collectively the value usually expressed by four such notes. Thus, the five semiquavers of the following group are equivalent in value to a quarter note, or four sixteenth notes:



QUINTUS CURTIUS RU'FUS. A Roman historian. See **CURTIUS**, **QUINTUS**.

QUINTUS ICILI'US. A name given by Frederick the Great to Karl Theophilus Guichard (q.v.).

QUINTUS SMYRNÆ'US (or OF SMYRNA). A Greek epic poet, probably of the close of the fourth century A.D. He wrote in 14 books the *Posthomerica*, which completes the story of the *Iliad*, drawing his material from the cyclic poets, and patterning closely no doubt on the work of Arctinus and Lesches. Quintus is sometimes called 'Calaber,' from the circumstance that a manuscript of his work was discovered at Otranto in Calabria. His poem, which is stiff and frigid, is best edited by Kichly (1850) and Zimmermann (1891).

QUINZE JOYES DE MARIAGE, kânz zhwi de zâ'rè-âh', LES (Fr., The Fifteen Joys of Wedlock). A satire composed, in all likelihood, by Antoine de la Sale (q.v.), and written before 1461. It gets its title and its framework from a prayer then widely known—*Quinze Joies de*

Notre Dame. It is a kind of litany on household worries. Consult the edition by Henekenkamp (Halle, 1901).

QUIR'INAL (Lat. *Collis Quirinalis*). One of the seven hills on which ancient Rome stood. It lies due north of the Palatine, and its western slope looks down on the Campus Martius, which stretches from its base to the banks of the Tiber. It was not included in the early Septimontium, or city of the seven hills, but was part of the city of the four regions, and was of course included in the so-called Servian Wall. The most notable ancient structures on the Quirinal were the temples of Quirinus, Flora, and Salus (safety), and on the plateau from which both Quirinal and Viminal project, near the Colline gate, an ancient shrine of Fortuna. In Imperial times the great *thermæ* (or baths) of Diocletian and Constantine were built on the hill.

The residence of the King of Italy, since 1870, previously a summer residence of the popes, occupies a commanding situation on the Quirinal Hill. It was begun in 1574 by Pope Gregory XIII., and completed under Paul V. The palace is modern in its arrangements and decoration. It contains a large ceiling painting by Overbeek, commemorating the flight of Pius IX. in 1848, a cast of Thorwaldsen's Procession of Alexander the Great, and an Annunciation by Guido Reni.

QUIRINUS. In the early Roman religion, the name of the third great god, ranking next to Jove and Mars. Whatever the origin of the god, he seems to have been regarded as a parallel to Mars, representing rather the war god as in time of peace ready for the fray. The original prominence of Quirinus is shown by the fact that the third great flamen was devoted to his worship, which does not, however, seem to have been very exacting, as the flamen appears assisting at several other services unconnected with Quirinus. He was also honored originally by the Colline Salii, as was Mars by the Palatine. His old temple lay on the Quirinal Hill near the Porta Quirinalis. We hear of a new building in B.C. 293, and after its destruction by fire, of the erection by Augustus of a splendid structure, which was dedicated B.C. 16. Early in the first century B.C. the belief arose that Quirinus was the deified Romulus, a theory which was fostered by Caesar and Augustus, and led also to the association of an old goddess *Hora Quirini* with *Hersilia*, the wife of Romulus. The annual festival of Quirinus was on February 17th, the supposed date of the translation of Romulus to heaven.

QUIRITES, kwî-rî'têz (Lat. nom. pl., probably from Sabine *quiris*, spear). The collective name of the Romans in their civil relations, while in connection with foreign affairs they were known as *Romani*. Quirites seems to have been the original name of a Sabine tribe, and the Roman nation, made up of Latin and Sabine elements, was called by the name of either of its component parts. A distinction, however, gradually crept in as to the use of the term Quirites, and while always a title of honor as applied to the Roman citizens, and so used in all public speeches and addresses, in the army it became a term of reproach, implying that he to whom it was given was no true soldier, but fit only for a civilian.

QUIRK, GAMMON AND SNAP. A firm of unprincipled solicitors in Warren's *Ten Thou-*

sand a Year, who discover the flaw in the title by which Tittlebat Titmouse gets the property. They are finally convicted of conspiracy and imprisoned.

QUIROGA, kē-rō'gá, José (c.1687-1784). A Spanish Jesuit explorer and mathematician. He was born in Lugo (or Fabas), near Coruña, studied mathematics and navigation in a naval college, and went to South America as a Jesuit missionary. Philip V. sent him with Alvarez to explore the Patagonian coast (1745-46) and settle the boundary between the Spanish and Portuguese possessions. His later years were spent in Rome, and, after the suppression of the Order, in Bologna. Quiroga was an able mathematician and left many papers on mechanics, navigation, and travels. A *Descripción del río Paraguay* was published in Buenos Ayres in 1836; and his nephew Emmanuel Mendez edited his *Tratado del arte de navegar por círculo paralelo à la equinoccial* (1784) and *De Ratione Inveniendi Longitudinem in Mari*.

QUIROGA, JUAN FACUNDO (1790-1835). An Argentine politician and soldier, born in San Juan (La Rioja), and educated in Spain. Upon his return home he became the leader of a band of ruffians and by 1820 was practically independent ruler of a large part of Northeastern Argentina. He appointed the Governor of La Rioja, and in 1827, having entered politics as a Federalist, made Dorrego President. But Dorrego was captured and killed by Lavalle in 1828, and Quiroga himself was defeated by another antifederalist general, Paz, in 1830. Then the tide turned. Quiroga won several victories, and in 1834 became Governor of Buenos Ayres. But he quarreled with Rosas, and was assassinated near Córdoba, possibly at the instigation of his fellow Federalist leader.

QUI TAM ACTION (Lat., who so well). An action brought under the provisions of a statute permitting an informer against an offender to receive a portion of the penalty prescribed for the offense, and authorizing him to sue on behalf of himself and the Government to recover the same. In England these actions have been permitted since the earliest period of its legal history as an efficient means of enforcing the law as to minor offenses, such as a breach of duty of a public officer, where the penalty was a fine. Offenders liable for a statutory penalty early sought to evade the law by procuring a friend to bring the action, under a collusive agreement not to enforce the judgment. To remedy this the statute 4 Hen. VII., ch. 20, was enacted, providing that all such actions should be brought in the name of the King. This became the common law of the United States on our independence, and to-day, unless a statute expressly provides that the action shall be in the name of the informer, it must be in the name of the State, 'on relation of' (*ex rel.*) the informer. These actions are to be distinguished from the so-called 'popular actions' where the informer is entitled to the whole penalty. See PENALTY.

• **QUITCH**. See COUCH GRASS; AGROPYRON.

QUIT-CLAIM. A deed of conveyance, deriving its title and in large part its form from the ancient instrument of release, whose operative words were "remise, release, and forever quit-claim." Though this language continues to char-

acterize the quit-claim deed, it is in its operation, in many of the United States, much more than a deed of release, and is in fact the form of conveyance usually adopted to make a grant of lands, answering the purpose of either a release or grant. It is, indeed, the simplest form of transfer of a freehold. So far as the conveyance of the title is concerned it has all of the effect of the more usual warranty deed, the principal advantage of the latter being that it adds to the mere conveyance the personal obligation of the grantor to warrant and defend the title transferred. See DEED; GRANT; RELEASE; WARRANTY.

QUIT'MAN, JOHN ANTHONY (1799-1858). An American soldier, born at Rhinebeck, N. Y. He attended Hartwich Academy, Otsego County, N. Y., and in 1816 was appointed a tutor there. In 1818 he was appointed adjunct professor of English in Mount Airy College, Germantown, Pa. He determined to study law and went to Chillicothe, Ohio, in 1819. He was admitted to the bar in 1821 and removed at once to Natchez, Miss. In 1823 he was appointed brigade inspector of the State militia, and in 1827 was a member of the Legislature, where he drew up a new militia system. From 1828 to 1834 he was Chancellor of the State, but resigned and was elected to the State Senate, of which he was president and for a few months acted as Governor of the State. He led a company to the aid of Texas in 1836, but saw no active service. On his return in 1837 he was made brigadier-general of the State militia. At the outbreak of the Mexican War he was appointed brigadier-general of United States Volunteers, and was ordered to report to General Taylor at Camargo. At Monterey, under discretionary orders, he forced his way into the heart of the city with 500 men, for which act he was later presented with a sword by Congress. He was brevetted major-general on September 23, 1846. He was transferred to the army of General Scott, led the assault at Vera Cruz, and commanded the expedition against Alvarado. He was made major-general April 14, 1847, and was with General Worth in the capture of Puebla. He served with distinction at Chapultepec, carried the Belen Gate, and with the capture of the City of Mexico was made Governor by General Scott. He soon returned to the United States, was Presidential elector in 1848, and was elected Governor of Mississippi in 1849. While he was Governor, General Lopez wished him to head a filibustering expedition to capture Cuba. Though he declined, the negotiations became known, and he was indicted in the United States court. He resigned as Governor and was tried before the United States District Court for East Louisiana, but the jury disagreed. He was again nominated for Governor, but after a heated canvass withdrew because the Democrats of his State had accepted the Compromise of 1850. In 1854 he was again interested in an expedition against Cuba, and was arrested, but not tried. From 1855 to 1858 he was a member of Congress and served as chairman of the Military Committee. General Quitman was radical in his views of States' Rights and in 1851 openly advocated the establishment of a Southern Confederacy. Consult Claiborne, *Life and Correspondence of John A. Quitman* (2 vols., New York, 1860).

QUITO, kē'tō. The capital of Ecuador. It is situated 0° 14' south of the equator on a lofty

plateau 9300 feet above the sea (Map: Ecuador, B 4). The location is of almost unrivaled grandeur. The plateau is bounded on all sides by lofty mountains, from which rise in plain sight no less than eight snow-clad volcanoes, some of which are among the highest peaks of the Andes, and the city is built on the very foothills of one of them, Pichincha. The climate of Quito is proverbially healthful, mild and equable. The plan of the city is a perfect square, with outlying suburbs, but as it is built on very uneven ground the streets are steep and generally impassable for wagons. There are several plazas, the largest of which, the Plaza Mayor, has been rendered very handsome with flower gardens and a fountain. It is faced by the cathedral, the Government and municipal buildings, and the Archbishop's palace. Besides the cathedral there are numerous other churches and convents, some of which are in fine Renaissance style, and contrast strangely with the low, mean adobe houses which make up the bulk of the city. At the head of the educational system stands the university, in whose buildings are installed also a library, a museum, an astronomical observatory, and a polytechnic school. There are, besides, two seminaries, several other colleges, and a medical school attached to a large leper hospital. Quito is, on the whole, a quiet and rather dull city. Having very poor means of communication with the outside world, its trade has not been active. A railroad, however, is now under construction to Guayaquil, the chief port of the Republic, and other improvements, such as electric lighting, have been installed. The chief manufactures are saddles, shoes, woolen and cotton cloth, blankets, and carpets. The chief exports are hides and rubber. Population, about 80,000.

Quito is one of the oldest cities of South America. It was the capital of an ancient Indian nation before it was captured in 1470 by the Inca Tupac Yupanqui. It was the northern capital of the Incas until it was taken by the Spaniards in 1534. It has suffered repeatedly from severe earthquakes, notably in 1844, 1859, and 1887, and has also been ravaged by civil wars. Consult: Ternaux-Compans, *Histoire du royaume de Quito* (Paris, 1840); Herrera, *Apuntes para la historia de Quito* (Quito, 1874).

QUIT RENT. Originally, a fixed rent due from a freehold tenant to his feudal superior, so called because received in lieu of all other services. It was a common feature of socage tenure and came in course of time to designate any fixed rent due from a socage tenant. Quit rents were protected from abolition by the provisions of the Statute of Military Tenures. It is probable, however, that they have become entirely obsolete in the United States, excepting in Pennsylvania, where they survive to a limited extent, though there is no legal objection to their survival elsewhere in the States formerly subject to socage tenure. Quit rents still exist to a considerable extent in England, though they have largely been redeemed under the provisions of the Conveyancing Act of 1881. Wherever they exist, however (unless due to the Crown in England or to the State in America), they are of great antiquity, as they always involve a relation of dependent tenure such as could not arise in England after the Statute *Quia Emptores* (1290) nor in this country after the Revolution.

Consult the authorities referred to under **REAL PROPERTY**.

QUITTOR (connected with LGer. *kicater*, *kicader*, rottenness). A fistulous wound at the top of the horse's foot resulting from bruises, pricks, or neglected corns.

QUIX'OTE, *Sp. pron.*, kē-hō'tā, DOX. See **CERVANTES**.

QUODLIBET (Lat., what one pleases). A humorous combination of several melodies in use extensively during the sixteenth and seventeenth centuries. To-day it is a favorite amusement at a 'Commers' (a students' gathering) in Germany to continue the singing of a popular folk or drinking song until a certain word is reached, which happens to be the first word of another well-known song. The air is then broken off suddenly and the new air begun at that word, until another word again affords an opportunity to pass into a new air. Many collections of quodlibets have been published.

QUOITS (from OF. *coiter*, *coitier*, *quoitier*, to press, incite; probably from Lat. *coactare*, to constrain, frequentative of *coagere*, *cogere*, to urge, from *co*, together + *agere*, to lead). A game played on a green at each end of which, 18 yards apart, a mark is placed. At this mark the quoits, iron concave rings 8 inches in diameter (of which the rim is from one to two inches in breadth), are pitched, alternately by two players of opposite sides, and so in rotation by any number of pairs forming the opposing sides. The game is won by the side which, in a given number of pitches, gets the greatest number of quoits nearest the marks or pins. Each player at each turn has two quoits. The sport is very common in Europe, and in America it is the subject of a national contest for the Bell Quoit Medal. The rules laid down in 1869 require the heads of the pins to be one inch above the ground into which they are driven, 18 yards apart, and the player to deliver his quoit from his hand with his first step. They leave the weight of the quoit unlimited, but restrict its external diameter to 8 inches. No quoit counts unless fairly delivered on the clay, free from the outer rim, and no quoit on its back counts, unless it holds clay, or is knocked out by another quoit. No quoit rolling onto clay counts unless it has first struck another quoit or the pin. In counting, the two quoits nearest to the pin count one point each; a 'ringer,' that is a quoit which has been pitched so that the pin shows through the open centre of the quoit, counts two points.

QUORUM (Lat., of whom, abbreviation of the ML. phrase *quorum unum A. B. unum esse volumus*, of whom we wish A. B. to be one). A legal and parliamentary term denoting the number of members of a public or private assembly whose presence is necessary for the transaction of business. In the case of private corporations the quorum necessary to enable the directors to transact business legally is fixed by the charter. In the case of private organizations it is fixed by their constitution or by-laws. In the case of legislative assemblies and constituent bodies it is generally fixed by the constitution, but is sometimes left to the determination of the assemblies themselves. The quorum is usually fixed at a majority of the legal number of mem-

bers elected, although there are notable exceptions to this rule. In the Parliament of Great Britain the quorum is determined by each chamber for itself. In the House of Commons it is fixed at 40 members; in the House of Lords at three. In the German Empire the Constitution fixes the quorum of the Imperial Diet at a majority of the legal number of members. The Federal Council is left to fix its own quorum and the practice requires simply the presence of the chairman, the Lord Chancellor. In France the determination of the quorum in the case of the French Parliament is left to each Chamber separately. By a rule of procedure it is fixed at a majority of the legal number of members of each House. In the United States the Federal Constitution fixes the quorum of the Senate and the House of Representatives at a majority of the whole number of members elected to each House. Until the 51st Congress (1890) it was the practice in the House of Representatives, in ascertaining the presence of a quorum, not to count those present but not voting. This enabled the minority to obstruct the legislative procedure quite frequently and the practice became so annoying to the majority that Speaker Thomas B. Reed (q.v.) introduced the policy of counting, for the purpose of making a quorum, all members present and refusing to vote. His action created something of a furor in the House, and it was denounced by the opposition as arbitrary and revolutionary, but its continued use has commended itself to the members of Congress and bids fair to be a permanent feature of the rules of procedure irrespective of the political complexion of the House.

QUOTIDIAN FEVER. See **MALARIA AND MALARIAL FEVER.**

QUO WARRANTO (Lat., by what warrant). A legal action or proceeding brought to determine the right of an individual or corporation to a public office, franchise, or privilege, and to have a usurper removed by order of a court of competent jurisdiction. This remedy is said to have originated in the twelfth century in England, and was originally commenced by a writ of quo

warranto in the name of the Crown, and commanding the alleged usurper to show 'by what warrant' he claimed the right or privilege in question. The inquiry was made by a royal commission, and the person named in the writ was often deprived of the rights he claimed without judicial proceedings. To remedy this a statute was enacted in the reign of Edward I. requiring that such cases should be tried by the action of quo warranto. This was begun by an 'information in the nature of a quo warranto' being filed by a public prosecutor on behalf of the Crown. By a statute in the reign of Anne, private individuals were permitted, on obtaining leave from a court, to file these 'informations.'

In most of the United States such proceedings are brought in the name of the Attorney-General of the State in his official capacity, or in his name 'on relation of' a private individual. These proceedings can only be brought in the highest courts of original jurisdiction or appellate courts. In most States quo warranto proceedings may be brought against persons wrongfully claiming to occupy public offices; against the officers of private corporations where the latter assume unlawful privileges and powers; against the officers of public or municipal corporations, where franchises are unlawfully exercised by them; or against any person unlawfully claiming and exercising control over a public franchise or privilege such as a ferry franchise or banking privileges. The right of a foreign corporation to do business in a State may be questioned in this manner. Defeated candidates sometimes cause an investigation into the election returns and the rights of their successful opponents by quo warranto proceedings, but many States have provided special statutory proceedings for determining contested elections. A quo warranto proceeding can only be brought to try a right or eligibility to an office, and not to remove a lawful incumbent for official misconduct. The statutes of the various States should be consulted for the details of procedure. Consult also: High, *Treatise on Extraordinary Legal Remedies* (3d ed., Chicago, 1896); Spelling, *A Treatise on Extraordinary Relief* (2d ed., Boston, 1901).

R

R The eighteenth letter of the English alphabet. It is the Latin form of the Greek *rho*, which corresponded to the Semitic *rēsh*, meaning 'head,' the letter rudely representing a face in profile. The development of the form of the letter was as follows:

𐤓	𐤏 𐤏	𐤏	𐤏
Hebrew.	Phœnician.	Early Greek.	Early Latin.
<div style="text-align: center;">R</div> Later Latin.			

The tag was added to the *r* in Latin in order to distinguish it from the sign for *p* (q.v.) when that letter assumed its present form.

In phonetic value *r* may be either consonantal or vocalic, and in Sanskrit this distinction was denoted by different symbols. *R* is a consonant only when it immediately precedes a vowel, as *rill*, *rain*, *crack*. As a consonant it is a continuous spirant, voiced or voiceless, and is sounded by placing the tip of the tongue loosely against the sockets of the upper front teeth and causing it to vibrate with strong breath. Initial English *r* is pronounced thus in such words as *ring*, *ribbon*. The vibration, however, is very slight, and the sound produced is a comparatively smooth one. Before back vowels the tip of the tongue is turned upward and back against the palate, as in *rush*, *roar*. Both these *r*'s are untrilled. Trilled *r*, infrequently heard in English pronunciation, is produced by the vibrations of the uvula. After vowels *r* is often sounded as the obscure vowel *a* (= *a* in *sofa*), *care*, *hirc*, *four*. In some words *r* has become so weakened as to be silent or to result only in lengthening the preceding vowel, as in *far*, *world*, *fern*. *R* influences the preceding vowels, making them more open, as in *ail*, *air*; *old*, *ore*; *pool*, *poor*. Here the sounds are widened to coalesce with the open quality of the glide *r*. This glide sound lies between the consonant and vocalic values, as *ear* (glide), but *carache* (consonant). English *r* in *red* is the medium alveolar sound, but after *t* in *try*, and, to a less degree, after *d* in *dry*, the opening is so restricted that the sound is distinctly buzzed. *R* may be voiceless in combination with other voiceless letters, as *pride*, *bride*.

R represents an original Indo-Germanic *r*, as Skt. *rudhira*, Gk. *ῥυθρός*, Lat. *ruber*, Eng. *red*; Skt. *dvar*, Gk. *θύρα*, Lat. *fores*, Eng. *door*. It may also represent a Germanic *z* (Indo-Germanic

s), which became *r* by the operation of Verner's law (q.v.). It is closely related to *l* (q.v.), with which it frequently interchanges, as in Sanskrit *rabh* and *labh*, to seize, especially as a result of dissimilation, as Greek *κεφαλαγαί*, beside *κεφαλαργία*, 'headache,' Latin *turtur*, English *turtle dove*. The Greeks had two types of *r*, *ρ* (rough breathing) and *ῥ* (soft breathing). The Romans transliterated the former (*spiritus asper*) by *rh*, whence the *rh* in words from the Greek, through the Latin, as *rheumatism*, *rhetoric*. Words derived directly from the Greek, if recently acquired, usually disregard this Latin spelling, as *reometer*, *raphe*.

As a mediæval Roman numeral *R* = 80, *R̄* = 80,000. *R. A.* = Royal Academy, Royal Arch, Royal Artillery; *R. M.*, Royal Marines; *R. N.*, Royal Navy; *R. C.*, Roman Catholic.

In prescriptions *R* (*recipe*) = take.

RA, *rä*. An Egyptian deity. See *Rê*.

RAAB, *räb* (Hung. *Győr*). A royal free city, and the capital of the County of Raab, Hungary, 63 miles west by north of Budapest, at the confluence of the Raab (a river about 150 miles long) with an arm of the Danube (Map: Hungary, C 2). It has handsome new public buildings. The educational institutions include an Obergymnasium and a normal school for girls. The city manufactures spirits, chemicals, oil, agricultural implements, and brick. The horse market is famous. Raab was built on the ruins of the Roman Arrabona. It was taken by the Turks in 1594. Four years later they were driven out, and Raab was made a fortress of the first rank. Population, in 1890, 22,795; in 1900, 27,758.

RAAB, JOHANN LEONHARD (1825-99). A German line-engraver and etcher, born at Schwanningen, near Ansbach. He studied at Nuremberg under Karl Maier and Reindel, then at the Academy in Munich, where he was appointed professor of engraving in 1869, having in the meanwhile worked at Nuremberg. Besides Raphael's "Madonna Tempi" and "Madonna di Foligno," Titian's "Gipsy Madonna," and Veronese's "Marriage Feast at Cana," he engraved after Kaulbach, Lessing, Flügel, Vautier, Schwind, Piloty, and Ramberg, and in 1882-87 reproduced the principal works in the Old Pinakothek at Munich in fifty etchings, for which Reber wrote the text. His daughter, Doris (1851—), born at Nuremberg, also earned a reputation with engravings after Holbein, Rubens, Piloty, and Linden-

schmitt, and etchings after Rembrandt. Van Dyck, Albert Cuyp, Max, F. A. Kaulbach and Toby Rosenthal.

RAABE, rü'bc, HEDWIG (1844—). A German actress, born in Magdeburg. She began to appear upon the boards in childhood, and at fourteen became connected with the Thalia Theatre at Hamburg, then with Wallner's Theatre in Berlin, and in 1864-68 was engaged at the Imperial German Theatre in Saint Petersburg, whence she visited Germany annually on starring tours. Her great success on these occasions induced her to devote herself exclusively to this mode of professional life, in the course of which she also acted in the United States (1886-87). In 1871 she married Albert Niemann, the dramatic tenor. Although she did more than full justice to classical rôles, her forte lay in the representation of native parts and the youthful characters of modern French and German comedy.

RAABE, WILHELM (1831—). A German humoristic novelist. He was born at Eschershausen, Brunswick, September 8, 1831. He first became known as Jakob Corvinus, the surname being a Latinization of his own. He excels in minute delineation of eccentrics. Characteristic among some forty volumes are *Ein Frühling* (1857), *Der heilige Born* (1861), *Unsers Herrgotts Kanzlei* (1862, 4th ed. 1901), *Der Hungerpastor* (1864, 14th ed. 1902), *Abu Telfan, oder die Heimkehr vom Mondgebirge* (1867, 4th ed. 1901), *Der Schüdderump* (1870, 3d ed. 1901), and *Horracker* (1876).

RAB AND HIS FRIENDS. A touching short story of a dog by Doctor John Brown, published in his *Horæ Subsecivæ* in 1855.

RABA'NUS (OR IRABANUS) MAURUS (c.776-856). A great ecclesiastic and teacher of the ninth century. He was born at Mainz of noble family about 776. He began his education at Fulda at an early age, entered the Benedictine Order, and in 801 received deacon's orders. The following year he was sent to continue his studies at Tours, under Aluin, from whom he received his surname, Maurus, after Saint Maur, the disciple of Benedict. In 803 he became head of the school at Fulda, which flourished greatly under his direction. In 814 he was ordained priest; in 822 he was chosen Abbot of Fulda, and performed his duties with much ability till 842, when he resigned and withdrew to the cloister of Saint Peter to devote himself to literature. In 847 he became Archbishop of Mainz. He died at Winkel on the Rhine, February 4, 856. Rabanus took an active part in opposing Gottschalk (q.v.) and his theories about predestination, and also the doctrines of Paschasius Radbertus with regard to the Eucharist. His voluminous writings, upon most diverse subjects, include a Latin-German glossary on the Bible, a sort of encyclopædia, *De Universo Libri XXII*, commentaries on the books of the Old and New Testaments, and poems. They are reprinted in Migne, *Patrol. Lat.*, cvii-cviii. His writings on education have been edited in German by Freundgen (Paderborn, 1889); his *De Institutione Clericorum Libri III*, by Knoepfler (Munich, 1901). For his poems, consult Dümmler, *Poeta Latini Evi Carolini*, vol. ii. (Berlin, 1884), and for his life, Kunstmann (Mainz, 1841), Spengler (Regensburg, 1856), and Turnau (Munich, 1900).

RABAT, râ-lâ't', or NEW SALLEE (also REBAT, RIAT, ARRET, etc.). A seaport and fortified town of Morocco, situated at the mouth of the Bu Regreg opposite Sallee (Map: Africa, D 1). It has numerous European houses, an arsenal, and a high minaret of the old Hassan Mosque. The town is famous for its manufactures of carpets, mats, cloth, pottery, and Morocco leather. The port is not easily accessible, but there is some foreign trade in olive oil, wool, skins, and bones. Population, 25,000, with 100 Europeans.

RABBAH, râ'bâi, or RABATH BENE AMMON (Heb. *Rabbath bâ'ê* 'Ammôn, Rabbah of the Ammonites). The chief city of the Ammonites, known at the present time as Amman. It was east of the Jordan, about 25 miles northeast of the Dead Sea, in the valley of the Jabbok. It did not belong to the possessions of the Hebrews, and with the exception of notices in Deut. iii. 11 and Jer. xiii. 25, is not mentioned till the time of David. It was then attacked by the Israelites and after a long siege was captured by David and Joab (II. Sam. x.-xii.). Later, apparently, it was regained by the Ammonites (Amos i. 13-15; Jer. xlix. 2-3; Ezek. xxi. 20; xxv. 5). Ptolemy II., Philadelphus (B.C. 285-247), captured it, rebuilt it and called it Philadelphia, and for a long time it was a flourishing city. (See PHILADELPHIA.) There was another Rabbah or Rabbath in Moab, which was known to the Greeks and Romans, although not mentioned in the Bible; and still a third in the mountains of Judea (Jos. xv. 60).

RABBI (Heb., Aram. *rabbî*, my lord). An honorary title applied to Jewish teachers of the law, and, in general, to those versed in the law. In the days of Jesus the title had not yet acquired a strictly technical sense, and is properly to be interpreted in the New Testament as a courteous title indicative of respect. Rabboni, which is applied to Jesus in Mark x. 51 and John xx. 16, has the same force, but implies somewhat more of respect. In later times, in consequence of the dissolution of the temple cult, authority in religious matters fell into the hands of the scholars, and the title Rabbi acquired an official significance and became restricted to those authorized to decide ritualistic and legal questions. This usage arose in Palestine, apparently in the second century; in Babylonia the corresponding title was *Rab* or *Mar*. Through Palestinian influence the usage spread to other countries. Rabbi is still maintained, though not strictly, as the official designation of Jewish ministers; formerly it was applied to any scholar, whether engaged in the active ministry or not, and this is, in a measure, still the case in Eastern Europe. Consult: Dalman, *Die Worte Jesu* (Leipzig, 1898); Schürer, *History of the Jewish People*, vol. ii. (Eng. trans., Edinburgh, 1886-90).

RABBIT (connected with dialectic Fr. *rabotte*, O Dutch *robbe*, Dutch *rob*, rabbit, Ger. *Robbe*, seal). A European animal (*Lepus cuniculus*) of the same genus as the hare, but smaller, and with shorter and more equal limbs, which differs essentially from all hares in the fact that the young are born blind and almost hairless, and in its gregarious and fossorial habits. The ears of the wild rabbit are only about as long as the head, and show little black at the tips; the fur is grayish-brown, growing whitish on the under part; the tail rather large and conspicuous,

brown above, white beneath, and ordinarily held upright. The rabbit delights in sandy heaths, dry grounds, covered with scattered bushes, and similar situations, where it digs burrows in colonies called 'warrens.' It feeds mainly in the dusk of the morning and evening. It is monogamous, and wild pairs are said to remain attached during life, but in domestication it ceases to pair. The fertility of rabbits is proverbial. They begin to breed when six months old, and are capable of producing several litters of five to eight young in a year, so that in favorable circumstances they multiply with prodigious rapidity, and were they not killed off would inflict great injury upon crops, gardens, and orchards, especially by barking young trees. The flesh of the European rabbit is excellent food, and the hides and hair may be made useful. They do not become a pest, and in some places not suited to agriculture are raised as a commercial product. This species is a native of the Western countries on the Mediterranean Sea, whence it has spread north in Europe. Its introduction and spread in Australasia furnishes an extraordinary example of the effect which may follow naturalizing animals to a new country. About 1850 a gentleman living in New South Wales imported and turned loose three pairs of rabbits in that colony. They multiplied and flourished so rapidly that they quickly became a public plague. In New Zealand, indeed, where the rabbit obtained a foothold about 1875, it soon became a serious question whether farmers should not abandon some districts altogether. In order to combat the plague, weasels and mungoses were extensively introduced, but these made comparatively little impression upon the hordes of rabbits, while they attacked the poultry, which was almost the only article of farm produce the rabbits had left untouched. An attempt was made to introduce epidemics of parasitic disease among the rabbits, but this also failed. The only way to meet the pest has been to erect around every garden or farm a rabbit-proof wire fence.

An old English name for the rabbit is 'cony,' which has led to the application of this term in English versions of the Bible, and in common speech elsewhere, to quite different animals of small size and burrowing habits. In the United States the word is used interchangeably with hare—or, rather, replaces 'hare' in popular speech, all the American wild species being called rabbits, though none of them are truly of that species.

DOMESTIC RABBITS. There are ten well-established varieties of domesticated rabbits, the original stocks of which were derived from almost as many different countries. These are Angora, Belgian, Dutch, Himalayan, Lop, Siberian, Silver-tip, Polish, and Flemish. Their characteristics are as diverse as their origin. They vary in color through every grade, shade, and mixture, from pure white to all black; in coat from the closest fur to long silky hair; capable of being woven; in style of ears from the 'prick ear,' erect, small, and almost as stiff as metal, to the floppy, broad, soft-skinned ear of the lop, which hangs to the ground. The development of particular characteristics and markings, and their maintenance, are made possible by the animal's remarkable fecundity and adaptability. Their food is simple, a meal of whole oats in the early morning, a mid-day meal of greens and vegetables,

and an evening one of a mixture of cornmeal, bran, and oatmeal, kneaded in warm water, meets nearly all their requirements. They are good mothers, need no attention, and the less they are then disturbed, the better. The breeding-hutch necessarily requires an inner room, dark except for such light as goes through the little round door. In that box, or room, she will make her own nest, and when her young have acquired their sight and fur (about the eighteenth day), they will come peeping out of the door. They should be taken away, one or two a day, when two months old. They can then run together until the fourth month, when the sexes must be separated.

The 'lop-ear' is the oldest variety of the fancy rabbit, having been bred from the English wild rabbit and shown in England considerably over a century. Its most marked feature is the abnormal ears, each 11 to 12 inches in length and 6 in width. The ears fall gracefully from behind the inner corner of the eye, with the convex surface outward; toward the root the ear is narrow and thick, and becomes abruptly broader and proportionately thinner toward the tip. The body in this breed is rather low at the shoulder, and there is a dewlap. The color varies, but the markings should be uniform. A large lop weighs 11 pounds. This is the only variety which requires artificial heat for its full development, and, although the oldest breed, is so entirely artificial that it is maintained and perfected only by the utmost care.

The Belgian, although commonly called Belgian 'hare,' is a true rabbit. It is of large size (10 pounds), and lustrous sandy brown in color. Its body is longer in proportion to its weight than that of any other rabbit, and the hind legs are long, strong, and straight. The head is rather broad, tapering to the nose, the ear about five and a half inches long, thin and transparent, and the eye brown and bright. The flesh is excellent, and between 1895 and 1900 this rabbit was extensively introduced into the Western United States.

The Dutch rabbit, derived from Holland, is one of the smallest of the fancy breeds, not averaging above four pounds. Its hind quarters are solid black, or blue, or lemon, or, rarely, tortoiseshell, except the toes of the hind feet, which are white; its forebody and fore legs are white; it has a white nose and white blaze narrowing to a point on its face between the ears. Its ears, and the patch all round the eye and its side face, are the color of its hind quarters. The whole-color areas must be absolutely free from black or white hairs, and their borders clear and sharply defined. They are a very hardy race and excellent mothers. The Angora, a curious long-bodied rabbit, is a native of Asia Minor, and, like the Angora goat and cat, has a long silky coat, which is so long that it can be combed or clipped periodically, and the wool woven. The hair is all white in typical examples, though sometimes black or fawn, and of two lengths, the first woolly and short, the second long and hanging in semi-curles all over the body. When the wool is white the eye is pink; in other varieties it shades accordingly. They average about nine pounds in weight, and are hardy. The Siberian rabbit, mainly bred in France, and very prolific, is a cross between the Angora and the Himalayan, having the long, silky hair of the one and the dark points of the other. The Himalayan's

native home is Northern China and Tibet, and he is bred in Europe for the value of his skin. His limbs, nose, ears, and tail are black, and the rest of the body white. This black tipping has caused his skin, the coat of which is short and glossy, to be sometimes called 'moek ermine.' The eye is a singularly rich golden crimson, bright and fiery. These rabbits breed as a rule very true, are smart, neat, hardy, and docile. They vary in weight from four to six pounds. The Patagonian derives its name from its great size alone, since it is really little else than a wild rabbit, bred up to 12 to 16 pounds in weight. The same may be said of the 'Flemish giants,' some specimens of which weigh 18 pounds. They grow quickly and are profitable for market sale.

The 'silver-tip' is a fancy breed, characterized by upright ears, large prominent eyes, well-formed body, and a coat evenly silvered, with about 25 per cent. of light hairs. When first born the silver-grays are a slate-blue, and after about a month they look quite black, but at their first molt this changes to a real silvering or light color, which is perfected by the second molt, when they show the much-desired blue tint. The 'silver-browns' are bred from the silver-gray bucks, crossed with deep-colored Belgian does. The 'cream' or 'fawn' varieties result from other cross-breedings. They are medium-sized rabbits, seven pounds being the approved weight. The Pole is a delicate little all-white rabbit, often weighing only three pounds, which inhabits Poland in its wild state, but is distributed all through Switzerland and France, especially in Provence. The ears are short, upright, and soft, and the eyes are light red. See Plate of HARES AND PIKA.

Consult: Knight, *Book of the Rabbit* (London, 2d ed., colored plates, 1889); Morant, *Rabbit Farming* (London, 1890); Rayson, *Rabbits for Prizes and Profit* (London, 1872).

RABBIT BOT. The larva of one of the botflies (*Cuterebra cuniculi*) which is commonly found under the skin of rabbits, where it forms a large tumor. The adult insect is a large fly, almost as large as a bumblebee, and having some resemblance to that insect. The head is black and the thorax is covered with yellow-brown hair, the first segment of the abdomen with yellow hair, and the rest of the abdomen is blue-black. This insect occurs in Europe and in various parts of the United States. See BOT.

RABBIT-FISH (so called because the front teeth resemble the incisors of a rabbit). A rather large, coppery-brown fish (*Promethichthys prometheus*) of the Middle Atlantic, especially frequent about Madeira and the Bermudas. It is one of the escolars (q.v.), and is known to Bermudans as 'cat-fish,' but about Madeira is called 'coelho,' or 'conejo.' Although it cannot be caught except on the bottom at depths of from 100 to 400 fathoms, it is one of the commonest and cheapest market fishes in the islands mentioned.

This name is also given to the common 'burr-fish' of the Southern United States. See PORCUPINE-FISH.

RABELAIS, râ'b'-lâ', FRANÇOIS (c.1490-c.1553). A great French satirist and humorist, born at Chinon, in Touraine. Rabelais's life is surrounded by legend. Even the year of his birth and the occupation of his father are matters of doubt, like the year of his death and his burial

place. The year traditionally assigned to his birth is that of Luther (1483). Some recent biographers put it in 1495, though others, following De Thou, prefer 1490, a date which offers, perhaps, least intrinsic difficulty. His father is said by some to have been an innkeeper, or vintner, by others an apothecary. Tradition records that Rabelais went when he was nine years old to a convent school at Seuillé, near Chinon, and that he passed thence to a similar school at La Basnette, near Angers, where he seems to have made the acquaintance of the three Du Bellay brothers and of Geoffroy d'Estissac, afterwards Bishop of Maillezais. He probably passed either from Seuillé or La Basnette to the Monastery of Fontenay-le-Comte, a Franciscan house in Poitou, where he apparently was advanced to the priesthood; for we find his name on a legal document dated April 5, 1519, among those of some 12 prominent members of the monastery. He seems to have read and studied here after the omnivorous fashion of the Renaissance, certainly in French, Latin, and Greek, possibly in Hebrew and Arabic. His scholarship gained him the friendly patronage of the Bishop of Maillezais, of the distinguished scholar Budæus, and of some influential lawyers. With Budæus he and a monk, Pierre Amy, corresponded in Latin and Greek, and fragments of their letters indicate that the other monks took offense at their studies and annoyed them so much that they left the convent, and doubtless the Franciscan habit, and sought the protection of the Bishop of Maillezais, through whom, possibly by the intervention of Cardinal du Bellay, Rabelais obtained from Clement VII., about 1524, permission to go over to the more scholarly Benedictines. He entered the abbey at Maillezais and soon became the table companion of Bishop Geoffroy d'Estissac, at whose château he was a frequent guest for long periods. But he seems to have grown restless, to have abandoned the abbey, his Benedictine habit, and his patron, and to have gone as a secular priest possibly to Paris and probably to Lyons. On September 17, 1530, we have record of Rabelais's matriculation in the faculty of medicine at Montpellier. He took his baccalaureate degree December 1st of that year, and lectured in 1531 at Montpellier on the *Aphorisms* of Hippocrates and Galen's *Art of Medicine*. We have his own testimony (*Pantagruel*, iii. 34) that he took part in an academic comedy. In November, 1531, he was appointed physician at the Hôtel Dieu of Lyons, but he did not take his doctor's degree till 1537.

At Lyons he seems to have begun publication, dividing his attention between medicine and law. At the same time his humor was finding expression in popular almanacs. Of these he issued between 1532 and 1550 some 18. The underlying purpose appears to have been to mock the astrologers and their art. One of these, the *Prognostication Pantagrueline*, suggests in its title the name of his most famous work, *Pantagruel*, of which the present Book ii. appeared at least as early as 1533. He appears to have revamped also a local Touranian legend of the giant Gargantua, an elaboration of which afterwards served his as prelude to his masterpiece. This new *Gargantua* probably dates from 1534. Early in that year Rabelais accompanied Cardinal du Bellay to Rome, where he spent three months and gathered materials published

by Marliani in September, 1534, as a *Topographie de Rome*, preceded by a dedicatory letter from Rabelais to the Cardinal du Bellay in which he speaks of travels in Italy. He was in Rome again from July, 1535, to March, 1536, and lost his place in the Lyons hospital in consequence of his absence. He corresponded diligently during this second Italian sojourn with the Bishop of Maillezais on matters of horticulture, politics, and Roman gossip, but chiefly concerning his efforts to secure from the Pope an indulgence to resume the Benedictine dress and to practice medicine, excluding surgery. This indulgence was granted him by Paul III. on January 18, 1536, in view of his "zeal for religion, knowledge of literature, and probity of life and morals," grounds on which Rabelais dwells with much complacency. It was on this visit to Italy that Rabelais procured seeds of the melon artichoke and carnation which he was first to introduce to France and so to England. There seems reason to place at about this time the death of Théodoule Rabelais, "a child of two months," of whom François seems to have been the father. On his return from Italy Rabelais visited Paris and shared in a banquet in honor of the printer and humanist Dolet, who afterwards (1546) suffered death for his freethinking. On May 22, 1537, Rabelais took his doctorate at Montpellier and lectured there later in that year on Hippocrates. In 1540 he was granted a further indulgence by Paul III., passed a brief time with the canons of Saint-Maur-les-Fossés, but soon took up a wandering life again, for we find him in July, 1541, at Turin. A work by him on military art written in Latin about this time was translated into French by Massuau and published in 1542 as *Stratagèmes*. Neither original nor translation exists. His protector, Guillaume du Bellay, Seigneur de Langey and brother of the Cardinal du Bellay, dying in 1543, bequeathed him "fifty livres tournois a year until his heirs shall have provided him or caused him to receive preferment in the Church to the value of 300 livres tournois annually." On September 19, 1545, Francis I. granted Rabelais a permit for the third book (properly the second) of *Pantagruel*, showing that *Gargantua* was then accounted the first and the original *Pantagruel* the second book. Dolet's death in the next year seems to have frightened Rabelais. He took refuge at Metz, where in 1547 we find him employed as a physician by the city. In 1548 Cardinal du Bellay sent for him to come to Rome, where Rabelais wrote a description of the great fête organized by the Cardinal to celebrate the birth of Louis, Duke of Orleans. This was published in 1549 as *La sciomachie et festins faits à Rome*, etc. Soon after Du Bellay's return to France (January 18, 1550) Rabelais was nominated Curé of Meudon, and being assured of royal favor, he published the fourth book of his romance, taking the precaution, however, first to resign (January 9, 1552) his curacies at Meudon and Jambet. The book fell, however, under the censorship of the Parlement. The brief remainder of Rabelais's life is wholly obscure. He probably died in 1553 in Paris (others say Meudon). An early biographer, Colletet, says he was buried in the cemetery of Saint Paul's Parish, Paris. What purported to be a continuation of *Gargantua et Pantagruel* appeared in 1562 separately as *L'He Sonnante*, and in 1567 was incorporated with the

rest as a fifth book. A recension of this fifth book, differing considerably from the others and bearing the date 1549, was discovered in 1900. Some regard it as genuine. Others recall that about that time Rabelais obtained a royal injunction against spurious works issued in his name and think this may be one of them. Parts of it are worthy of him.

In *Gargantua* and *Pantagruel* frank fooling is mingled with keen social satire, political insight, and pedagogic wisdom, but the work is conspicuously lacking in continuity. It may be noted, however, that in the first book, *Gargantua*, will be found, together with the farcical adventures of that giant, the notable deeds of Friar John, and the founding of the Abbey of Thelema, and the quintessence of Rabelaisian social and pedagogical philosophy. The second had for its original descriptive title "Pantagruel, King of the Drunkards, Portrayed According to Life, with His Amazing Deeds and Feats of Prowess." The title of the third, fourth, and fifth books is "Of the Heroic Sayings and Doings of the Good (or Noble) Pantagruel." In both second and third books the central figure is Panurge, an original creation, accomplished, shrewd, but quite without moral character. His debate with himself and his counsel-taking with others as to whether he shall marry, in the third book, is perhaps the most famous passage of the romance. It is finally determined to consult the oracle of the *Dire Bottle*. The voyage in search of this furnishes occasion for the fourth and fifth books. The oracle is 'Trinq.' As nearly as may be Pantagruel is Rabelais. Most of his writing is pure fooling, though always the sport of a philosopher and a scholar, satirizing what he professed to believe, not because he was insincere, but because he saw an essential antinomy in all apprehension of truth—no uncommon attitude of mind during the Renaissance. In him antique reason is opposed to modern faith. He is not an innovator, but a restorer of enlightened paganism, first in that series of Pantagruelists that counts Descartes, Courier, Balzac, and Lemaitre. His very uncleanness of speech is the expression of a lusty animalism in revolt against mediæval asceticism, of a militant faith in nature and instinct, in whose sturdy humor and destructive satire it is to be found the spirit of eighteenth-century ethics and of modern realism. Rabelais does not directly attack the Christian, or even the Roman Catholic faith. He was a freethinker, who clung to the skirts of Catholic faith, a cautious heretic, and no Protestant, a stout defender of free thought in France. Rabelais's influence on the development of fiction was small, but Pantagruel, Panurge, and Friar John are imperishable creations.

The first annotated edition of Rabelais was by Le Duchat and Bernard de la Monnaye (1711). There are subsequent annotated editions by Esmanhart (Paris, 1823-26); Burgaud des Marets and Rathéry (Paris, 1857-58); A. de Montaignon and Louis Lacaud (ib., 1868-73); Marty-Laveaux (4 vols., ib., 1870-81), the best; Pierre Jannet (ib., 1873); Moland (ib., 1881); and Jouart (ib., 1885). There is a very remarkable English translation by Urquhart and Motteux (London 1653-94; often reprinted). Consult the bibliography appended to Marty-Laveaux's study of Rabelais; Petit de Julleville *Histoire de la*

langue et de la littérature française (Paris, 1896-98); and especially Stapfer, *Rabelais, sa personne, son génie, son œuvre* (ib., 1889); Gebhart, *Rabelais, la renaissance et la réforme* (ib., 1895); Henlhard, *Rabelais chirurgien* (ib., 1885); id., *Rabelais, ses voyages en Halle, son œil à Metz* (ib., 1891); and in English, Walter Besant, *Rabelais* (London, 1879); id., *Readings in Rabelais* (ib., 1881).

RABENER, rä'be-nēr, GOTTLIEB WILHELM (1714-71). A German satirist. He was born at Wachau, near Leipzig, went to school in Meissen with Gellert and Gärtner, and after finishing his studies in Leipzig, in 1741 entered the employ of the tax collector. He wrote for the popular periodicals of the day, and of these especially for the *Bremer Beiträge* and Schwabe's *Belustigungen*. These papers are mildly satiric, marked by clearness, purity, and force, yet marred somewhat by the frequent use of 'direct irony,' as Goethe said. They were published at Leipzig (1751-55); with his *Satirische Briefe*, his personal correspondence, and a biography, they were edited by Weisse (1777); other editions followed down to 1840.

RABENHORST, rä'ben-hörst, LUDWIG (1806-81). A German botanist, who contributed greatly to the systematic study of cryptogamous plants. He was born at Treuenbrietzen, Brandenburg, and after studying at Berlin bought a pharmacy at Luckau, where he lived and worked for ten years (1830-40). Then, to devote himself entirely to botany, he removed to Dresden, and afterwards to Meissen. Rabenhorst wrote: *Deutschlands Kryptogamenflora* (1844-53); *Kryptogamenflora von Sachsen, der Oberlausitz, Thüringen und Nordböhmen* (1863-70); *Flora Europæa Algarum Aquæ Dulcis et Submarinæ* (1864-68); and *Mycologia Europæa* (with Gonnemann, 1869-82), as well as some works on general botany. He founded in 1852 the journal *Heidwigia*.

RABIER, rä'byá', ELIE (1846--). A French philosopher and educator, born in Bergerac, and educated there, and in Paris at the Lycée Louis le Grand and at the Ecole Normale Supérieure. He taught philosophy in lycées at Montauban and Tours and in Paris, and then became inspector of secondary schools, a post in which he took a prominent part in educational reforms. He edited Descartes's *Discours de la méthode* (1877; 8th ed. 1899), and wrote an excellent series of text-books of philosophy, *Leçons de philosophie* (1884 sqq.).

RABIES. See HYDROPHOBIA.

RABSHAK'EH (Heb. *Rabshākēh*, Bab.-Ass. *rab-shākē*, chief of the captains). A word which occurs in the Old Testament (II. Kings xviii.-xix., and the parallel passages, Is. xxxvi.-xxxvii.) as the title of the officer sent by Sennacherib with Tartan and Rabsaris (likewise titles of high officials) to demand of Hezekiah the surrender of Jerusalem. The Rabshakeh is represented as delivering his message in Hebrew, in the presence of the people, and when requested to speak Aramaic—at the time the language of diplomatic interchange—so as not to alarm the people by the threats of the Assyrian King, insolently declines to do so. It follows from the choice of the Rabshakeh to convey the message of Sennacherib that he was a high dignitary in the Assyrian army, though not the highest, and

this view is confirmed both by the occurrence of the title in Assyrian historical texts and in legal documents and also in lists of officials (e.g. Rawlinson II., pl. 31, no. 5, 34a). Exactly what position the Rabshakeh occupied is not known, though it is probably not far wrong to regard him as a general staff officer. The old rendering 'chief cup-bearer' is certainly wrong and must be abandoned. Consult Schrader, *Cuneiform Inscriptions and the Old Testament* (Eng. trans., London, 1885-86).

RABUTIN, rá'bu'tán', ROGER, Comte de Bussy-. See BUSSY-RABUTIN.

RACALMUTO, rá'kál-mō'tó. A town in the Province of Girgenti, Sicily, situated on the crest of a hill, 12 miles by rail northeast of Girgenti (Map: Italy, H 10). It has a fourteenth-century castle. There are salt, sulphur, and quicksilver mines, and a trade in wine and oil. Population (commune), in 1901, 15,938.

RACAN, rá'kán', HONORAT DE BŪEIL, Marquis de (1589-1670). A French poet, born at La Roche Racan, Touraine. He was a page to Henry IV. and in that capacity met Malherbe, whose disciple he became. He served in the army for several years, and then retired to his estates. *Les Bergeries*, a dramatic pastoral, appeared in 1625. It is studied from nature and his best production. But he had not the sustained force to write a great work, and he had little education. This becomes apparent in *Les sept psaumes* (1631), *Odes sacrées tirées des psaumes de David* (1651), and *Dernières œuvres et Poésies chrétiennes* (1660), where his limited knowledge of Latin is evident.

RACCONIGI, rák'kō-nē'jé. A town in the Province of Cuneo, Italy, situated on the Maira, 21 miles by rail south of Turin. Its palace, surrounded by a park, was a country residence of Charles Albert. The town has a gymnasium, a technical school, and a large hospital. Silk fabrics, woolen cloths, and shoes are manufactured. Population (commune), in 1881, 9565; in 1901, 9009.

RACCOON (from American Indian *arathcone*, *arrathkune*, raccoon). A small American carnivore (*Procyon lotor*), closely related to the bears. The family (Procyonidae) is American, with the single exception of the Himalayan genus *Ælurus*. (See PANDA.) The raccoon is to be found all over the wooded parts of temperate North America, and most of Mexico, and a second species frequents tropical America. It is about the size of a cat, but more robust in appearance, because of its long fur and the semi-plantigrade feet. The general color is a grizzle, as the grayish hairs are tipped with black; but on the nose and cheeks there are black and white patches, which, with the erect ears, give the countenance a shrewd expression, well justified by the cunning and mischief-loving activity of the little beast. Although it spends much of its time on the ground in search of small animals, insects, and vegetable dainties, it climbs well and makes its home in the hollow of a tall tree, where it sleeps during the day, and hibernates in the colder parts of the country. In the late summer and early fall the raccoon shows a special fondness for ripening corn. At this season also, frogs, crayfish, and wild oysters form a large part of their fare. These they open and scoop out with great dex-

terity. The raccoon, indeed, is as clever with its paws as a monkey. A very singular practice of the raccoon is that of washing everything it eats before putting it into its mouth. Should there be no water at hand, the animal will go through the motions of washing it, rubbing the morsel between its hands until it considers it perfectly clean. It is indeed fond of water in every way, and is a good swimmer.

The hunting of raccoons, which usually is done with dogs, is one of the favorite American sports, especially in the Southern States. This chase is more a matter of sport than profit, although the fur of the raccoon has a considerable value, especially for the making of robes and drivers' overcoats. The hair also is extensively used in Europe, in the manufacture of hats. South America has a similar species of raccoon (*Procyon cancrivorus*), locally called the 'crab-eater,' which is found in all parts of that continent east of the Andes. It takes its name from its great fondness for the land-crabs which abound in South America, and upon which it mainly exists.

Consult: Audubon and Bachman, *Quadrupeds of North America* (New York, 1851); Merriam, *Mammals of the Adirondacks* (New York, 1893); Robinson, *In New England Fields and Woods* (Boston, 1896); Ingersoll, *Wild Neighbors* (New York, 1897); Stone and Cram, *American Animals* (New York, 1902). See Plate of MIXOR CARNIVORES.

RACCOON DOG. A small, short-eared wild dog (*Canis procyonoides*) of Japan and the Chinese coast, which has a curious resemblance in form and color to the raccoon. It haunts the banks of rivers and the seacoast, and feeds at night mainly on fish in winter, and on mice in summer. It lives in burrows, and is said to hibernate, but this assertion needs confirmation. It is not shy, is easily trapped, and its fur and flesh are highly esteemed, especially among the Japanese.

RACCOON OYSTER. See OYSTER.

RACCOON PERCH. The yellow perch. See PERCH.

RACE, CAPE. See CAPE RACE.

RACE-HORSE. See STEAMER DUCK.

RACHEL (Heb. *Rāḥēl*, ewe). A daughter of Laban, the favorite wife of Jacob (Gen. xxxix. 6 sqq., 30), mother of Joseph (ib. xxx. 22 sqq.) and Benjamin (ib. xxxv. 16 sqq.). Jacob served Laban seven years for her, and then, receiving Leah in her stead, was obliged to serve seven years more for Rachel. As Rachel was barren, she gave her husband Bilhah, a servant, for concubine, and thus became the putative mother of Dan and Naphtali (ib. xxx. 1-8). Through 'mandrakes' obtained from Reuben her womb was finally opened (ib. xxx. 14 sqq.). She died in Canaan after giving birth to Benjamin (ib. xxxv. 18). Her tomb is said to have been at Zelzah in the border of Benjamin not far from the sacred tree of Tabor, in the neighborhood of Bethel (I. Sam. x. 2), between Bethel and Migdol Eder, which, according to Micah iv. 8, seems to have been Jerusalem (Gen. xxxv. 16), not far from Ramah (Jer. xxxi. 15), and 'in the way to Ephrath which is Bethlehem' (Gen. xlviii. 7). There must have been a tomb of Rachel in Bethlehem to account for the reference of this pas-

sage to the massacre of infants in Matthew ii. 18. Whether the other passages all refer to the same place or to different tombs cannot easily be determined. Originally the totem of an important clan (Rachel-ewe), the divine ancestress may have been worshiped at more than one tomb, both within the territory of the tribes Joseph and Benjamin and at Bethlehem, which one seems to have belonged to Benjamin (*Bēnē Yamīn*—'Sons of the South'). The Rachel clan itself was probably absorbed in Joseph and Benjamin, though families in Dan and Naphtali may have claimed the same descent. There is a *Kubbet 'Abd el-'Azīz* north of Jerusalem also called *Kubbet Rachel* (tomb of Rachel); the structure at Bethlehem called *Kubbet Rachel* dates from the twelfth century A.D., but may be on the site of an earlier tomb.

RACHEL, *rā'shēl'*, MLE. (1821-58). A celebrated French tragic actress, whose real name was Elisabeth Rachel-Félix. She was born of Jewish parents at an inn in the Swiss village of Mumpf. Her father was a peddler. The family settled for a time at Lyons, where she and her elder sister Sarah used to sing in the streets and cafés. In 1830 they came to Paris. There her singing attracted the attention of Choron, an eminent teacher of music, and he took her as a pupil. Her voice after all proved not very promising, but her dramatic gifts were evident, and she began studying under Saint-Aulaire, the actor. Later she was a pupil in the Conservatoire. In 1837 she secured a position at the Gymnase and made a début which excited no great attention. A few critics, however, perceived her genius, among them Jules Janin, and Mlle. Mars (q.v.) likewise foresaw her future greatness. On June 12, 1838, she made her appearance upon the stage of the Comédie Française, as Camille in Corneille's tragedy of *Horace*. In this rôle and in a series of other impersonations from the classic repertory she achieved great success, and popular admiration of her performances grew to such enthusiasm that for years she was without a rival in the great tragic rôles of Corneille, Racine, and Voltaire. It was in Racine's *Phèdre* that the zenith of her artistic career was reached (1843). Another of her triumphs was in *Adrienne Lecouvreur*, which was written for her by Scribe and Legouvé, but in other modern rôles she was less fortunate. Her relations with her colleagues at the Théâtre Français were by no means always pleasant. Her caprices were without number. In her tours abroad she met with great success, especially in England in 1841 and later, and in Russia in 1852. Her health and popularity in Paris were both failing when in 1855, the year of Adelaide Ristori's first Parisian appearance, Rachel undertook a tour to America with her brother Raphael as manager. She was warmly greeted, though the returns were disappointing, and she soon went back to France in utter physical prostration. A visit to Egypt failed to restore her, and she died of consumption at Canet, near Toulon, January 3, 1858.

Of the details of her private life, which was not exemplary, little need be said. She was constant to her family and helped her sisters who went upon the stage. As an artist, within the limits prescribed by her genius, she was perhaps never equaled. "She does not act—she suffers,"

one said of her. Her *Phèdre* was a portrayal of human agony never to be forgotten.

Matthew Arnold's three sonnets upon her are well known. Consult the *Memoirs of Rachel*, by *Madame de B.*— (Eng. trans., New York, 1858), which are not, however, altogether reliable; Janin, *Rachel et la tragédie* (Paris, 1858); D'Heylli, *Rachel d'après sa correspondance* (Paris, 1882); Kennard, *Rachel* (Boston, 1888); De Mircourt, "Rachel," in *Les contemporains* (Paris, 1854).

RACHITIS, rà-kí'tis. See RICKETS.

RACINE, rà-sèn'. A city and the county-seat of Racine County, Wis., 23 miles south-southeast of Milwaukee and 62 miles north of Chicago, on Lake Michigan, at the mouth of the Root River, and on the Chicago and Northwestern and the Chicago, Milwaukee and Saint Paul railroads (Map: Wisconsin, F 6). It has a pleasant site, some 40 feet above the lake, and is regularly laid out. Among the institutions of the city are Saint Luke's Hospital and the Taylor Orphan Asylum, a public library with more than 7500 volumes, and several other libraries, two of which belong to Racine College (Protestant Episcopal) and Saint Catherine's Academy (Roman Catholic). The post-office, erected at a cost of \$100,000, is one of the finest edifices in the city. Racine possesses a good harbor, and is connected by steamship lines with other lake ports. Its trade is chiefly in farm produce and in the principal manufactured products. As an industrial centre, Racine ranks second among the foremost cities of the State, the output of its various manufactories in the census year 1900 having had an aggregate value of \$12,503,000, and the invested capital having amounted to \$16,753,000. The leading manufactures include agricultural implements, carriages and wagons, foundry and machine-shop products, boots and shoes, leather, trunks and valises, steel springs for cars and carriages, hardware, lumber products, etc. Settled in 1834, Racine was incorporated as a village in 1843, and in 1848 it obtained a city charter. The government, under a revised charter of 1891, is vested in a mayor, elected every two years, and a unicameral council. Of the administrative officers, the fire and police commissioners are appointed by the mayor, and the school board by the mayor with the consent of the council. Population, in 1890, 21,014; in 1900, 29,102.

RACINE, rà'sèn', JEAN (1639-99). The greatest of French tragic poets, born December 21, 1639, at La Ferté-Milon. He received his primary education in Beauvais, at a school affiliated with the Jansenists of Port-Royal; then he passed at fifteen to the more immediate direction of the Port-Royalist teachers at l'École des Granges, where he was taught by the noted Greek scholar Lancelot, and the Latinist Nicole, who was a distinguished moralist, and others skilled in the pedagogy of their time. They left indelible marks, not alone on Racine's mind, but on his character, for the great fact that dominates his whole life is his relation, intellectual and moral, to those solitaries of Port-Royal in whom persisted the Puritan element in the French Church. Sometimes an obedient, sometimes a revolting disciple, he was never indifferent to these influences of his youth. He died in

their fold, and his grave bore the inscription, 'Poet, Recluse of Port-Royal.'

At l'École des Granges and later at the Collège d'Harcourt Racine 'read and annotated all the ancient classics.' He learned by heart long passages from Greek romances and declaimed to astonished friends the choruses of Sophocles, who, with Euripides, remained his dramatic model. He acquired also a puritanic tenacity of mind, and uncompromising uprightness and a reasoned devotion. Yet he had brilliant social gifts, and on his graduation (1658) worldly attractions so prevailed on him that his kindred took alarm. They sent him into a kind of exile at Uzès in Languedoc, where he hoped for a benefice from his uncle, Vicar-General of the diocese. His faults, from a Jansenist point of view, appear to have been intimacy with La Fontaine, Chapelain, other men of letters, and some actors and actresses, and the directing of his talent to dramatic composition and to poems for the Court, especially *La nymphe de la Seine* on the marriage of Louis XIV.

Fifteen months in Languedoc brought Racine no benefice, but he completed his literary education. He read diligently the Greek, Latin, and Italian poets and historians, and the Church Fathers. He returned to Paris (1662) an accomplished scholar, dominated by social and poetic ambition. He was presented to the King, became a fashionable poet, and the intimate of Chapelle, Furetière, Molière, and, above all, of Boileau, who formed in the successful poet a new and fruitful theory of dramatic art. In 1664 he obtained a pension and he was a frequent recipient through life of 'gratifications' from the Court. His earliest play, *La Thébaïde*, on the strife of Eteocles and Polynices, was acted by Molière's company in 1664. His second play, *Alexandre le Grand*, was first performed December 4, 1665, by the comedians of the Palais Royal. December 18th they were astonished to find out that it was being given by a rival company at the Hôtel de Bourgogne. How this came about is unknown, but it ended in a complete breach between Molière and Racine, the latter of whom seems to have been in the wrong, and who presently showed himself as an unfriendly rival to Corneille, and as an unseemly satirist of his old teachers, the Port-Royalists, in a reply to Nicole's *Lettres visionnaires* on the evils of the stage. He wrote also a second reply which Boileau saved him from printing, telling him that it might be a credit to his wit, but was surely none to his heart. He later repented deeply this most discreditable incident in his life. But his irritation at the attitude of his kinsfolk at Port-Royal made his thought more tragically sombre, and while the poet in him was wrestling with the Puritan he wrote *Andromaque* (1667), the first of his seven great plays.

Of Racine's life from 1667 to 1677 we know very little. He lived in close intimacy with at least one actress and produced his only comedy, *Les plaideurs* (1668), and the tragedies *Britannicus* (1669), *Bérénice* (1670), *Bajazet* (1672), *Mithridate* (1673), *Iphigénie* (1674), and *Phèdre* (1677). This last was opposed by a cabal who supported a rival and worthless *Phèdre* by Pradon. Nettled at this or because of a moral dissatisfaction with the result of his theory of dramatic art, Racine withdrew from the stage, made his peace with Port-Royal, and married a worthy woman with more money than culture, and more

good nature than either. Racine's domestic life was happy. He had seven children and a sufficient income from sinecure offices and from the post of royal historiographer, which he shared with Boileau. This involved the duty of accompanying the King to his various 'sieges,' but what Racine wrote was accidentally burned. In 1685 he pronounced in the Academy, of which he had been a member since 1673, a fine eulogy on Corneille, and in 1689 made a kind of return to the stage with *Esther*, written to be acted by the girls at Madame de Maintenon's school at Saint-Cyr. It was a biblical dramatic poem and very successful. *Athalie*, a similar and greater piece (1691), was much less successful. Neither was publicly produced in Racine's lifetime. In his last years he grew ever more devout, wrote four *Cantiques spirituels* and an *Histoire abrégée de Port-Royal*. For this or some other reason he lost Court favor. Tradition says it was for preparing a memoir on the miseries of the people. In March, 1698, he sought to clear himself of complicity in the Jansenist 'heresy' in a long letter to Madame de Maintenon.

A careful examination of Racine's life and letters reveals a puzzling duality, a serious soul and a mobile mind. He was not merely religious; he was credulous and superstitious. He was more than loyal to the King; he was his toy. He was vain, irritable, timid, easily influenced by those he loved or feared. He was gentle and lovable, but the kind of moral goodness that he had was wholly consistent with moral weakness. His mind was keen, supple, strong, with good power of psychic analysis, remarkable delicacy of sentiment, and an exquisite though narrow sense of literary art. The best of him is in his work, a rare combination of wit and feeling, energy and poise, imagination and self-restraint, eloquence and repose.

The production of *Andromaque* makes November 17, 1667, one of the great dates in the history of the French stage. It marked a new conception of the tragedian's art. For Corneille's heroic tragedy is at that moment contrasted with Racine's tragedy of love. Corneille stands for the triumph of will, Racine for the inevitableness of destiny and of passion. This conditions his dramatic form. Since he deals with the universals of human nature, he chooses a conventional environment, whatever least distracts attention and least binds the development and play of passion. With comedy it is different. He puts the scene of *Les plaideurs* in the Paris of his day.

The dominance of passion over will is accepted more readily in women than in men, and Racine's great characters are nearly all women. This is preëminently true of *Phèdre*, *Andromaque*, and *Iphigénie*, his three most popular tragedies. It is true, too, though in a different way, of *Athalie* and *Esther*.

Racine's plays are simple. Each is a problem which the dramatist solves in a way often more consistent with logic than with psychology. Thus the dramatic element is enhanced, for Racine touches only such features in his characters as shall make them stand out clearly and do nothing to hinder the development of his plot. Every person behaves with the utmost decorum; not one of them says anything inelegant or unrefined; there are no visible bloody deeds, no roughness even, and no jesting nor comedy. Herein Racine's men and women constitute an ideal or

rather an unreal society; perhaps it were better to say a society from which such features as did not fit Racine's aesthetic theories are absent. Again, Racine took all his tragic themes from ancient history or legend, but his tragedies are nevertheless of the seventeenth century. Frenchmen in French apparel are called Nero and Achilles. *Iphigénie* is French to the core. Indeed, little remains of the old heroes and heroines, villains, and saints, save their names and the thread of historic tradition. Racine's tragedies teem with anachronisms, but these anachronisms are precisely what quickens the Racinian characters and makes them national or racial. They are not restorations, but vivid adaptations.

Racine's tragedies and his *Plaideurs* are written wholly in Alexandrine verse. In *Athalie* and *Esther* other measures are employed in the choruses. His vocabulary is limited. There are very few allusions to visible nature, to hills, rivers, plants, animals, etc. The whole interest, in a word, is centred in man, and mostly in the aristocracy. The mob, the lowly folk, even middle class people are conspicuously absent. Racine is therefore the poet of the high-born. He has never appealed to the French nation as a whole, but rather to the most cultivated and fastidious classes, who find in him a precise and poetic interpretation of the loftier, more general sides of life.

BIBLIOGRAPHY. Of many editions of Racine the best is Mesnard's (7 vols., Paris, 1863-73). That by Girodet (3 vols., ib., 1801-05) is remarkable for its typography. That of Anatole France is also noteworthy (5 vols., ib., 1874). The first edition is dated 1675-76; the last revision by Racine, 1697. There is an English translation (metrical) by Boswell, in Bohn's Library (London, 1889-91). *Andromaque* was adapted as *The Distressed Mother* by Ambrose Philips in 1712. *Phèdre* was acted in London in English in 1707. For Racine's life we have *Mémoires*, edited by his son Louis (Lausanne, 1747). Consult the popular biographies by Larroumet in *Les grands écrivains français* (Paris, 1898); Deschanel (Paris, 1884); Monceaux ((Paris, 1892); also Stendhal, *Racine et Shakespeare* (ib., 1882); Blaze de Bury, *Racine and the French Classical Drama* (London, 1845); Sainte-Beuve, *Port-Royal*, vol. vi. (4th ed., Paris, 1878); Roy, *Racine; sa vie intime* (ib., 1871), Stapfer, *Racine et Victor Hugo* (ib., 1887); Robert, *La poésie de Racine* (ib., 1890); Deltour, *Les ennemis de Racine* (ib., 1892); De Grouchy, *Documents inédits relatifs à Jean Racine* (ib., 1892); Delfour, *La Bible dans Racine* (ib., 1893). Brunetière, *Études critiques de la littérature française*, vol. i. (Paris, 1880); id., *Histoire et littérature*, vol. ii. (ib., 1884); id., *Les époques du théâtre français* (ib., 1892); and Lemaitre, *Impressions de théâtre*, vols. i., ii., iv. (Paris, 1888 et seq.), contain useful criticism of Racine's dramatic art. The English series of Foreign Classics has a study by Trollope, *Corneille and Racine* (Edinburgh, 1881).

RACK (Goth. *uf-rackjan*, OHG., Ger. *recken*, to stretch; connected with Lat. *regere*, to stretch, rule, Gk. *ὀρέγειν*, *oregein*, Lith. *rūtyti*, Skt. *arj*, to stretch). An obsolete instrument of torture, formerly used for extracting confessions from criminals and suspected persons. It consisted of a large oblong frame of wood, with four beams, slightly raised from the ground, on which the suf-

ferer was stretched and bound. Cords were attached to his ankles and wrists, and gradually strained by means of a lever and pulleys, till—unless the prisoner confessed and was released—dislocation of the limbs ensued. The rack was in use among the Romans in the first and second centuries, and many of the early Christians underwent its tortures. Coke mentions its introduction into the Tower of London by the Duke of Exeter, Constable of the Tower, in 1447, when it came to be called the 'Duke of Exeter's daughter;' its use is mentioned by Hollinshed in 1647, and it became common in the time of Henry VIII. as an implement of torture for prisoners confined in the Tower. The infliction of the punishment of the rack took place during the reign of the Tudor sovereigns by warrant of council, or under the sign manual. In 1628 it was proposed in the Privy Council to put Felton, the murderer of the Duke of Buckingham, to the rack, in order that he might confess as to his accomplices, but the judges resisted the proceeding, as contrary to the law of England. In various European countries the rack was frequently used both by the civil authorities in cases of traitors and conspirators, and by members of the Inquisition to extort a recantation of heresy.

RACK. A liquor. See **ARRACK**.

RACKETS. See **RACQUETS**.

RACKET-TAIL. A name for certain humming-birds (q.v.) two or more of whose tail-feathers are greatly elongated, bare of webs toward their tips, and then suddenly broadly webbed, suggesting the shape of a tennis racket. Several species of extraordinary brilliance inhabit the Andean region, of which the species (*Steganura Underwoodi*) illustrated on the Plate of **HUMMING-BIRDS** is a characteristic example. The name 'puff-leg' is sometimes given to these hummers on account of the mass of loose white feathers about their tarsal joints. Similar tail-feathers occur in other species, as the magnificent *Loddigeria mirabilis* of Northern Peru.

RACK RENT. A rent that is equivalent to the full net annual value of the real property out of which it issues, or approximately so. By statute in England to-day, rack rent is defined to be "not less than two-thirds of the full net annual value of the lands out of which it arises." Rack rent in the ancient sense has probably never been exacted in the United States. See **RENT**.

RACOVIAN CATECHISM. A catechism first printed at Rakow, or Racovia, Poland, in 1605. It was based on the writings of Socinus (q.v.) and presented his doctrines. An English translation was published in London in 1818.

RACQUETS, or RACKETS (Fr. *raquette*, from OF. *rachete, rachette, rasquette, rasquette*, from Sp. *raqueta, raquet*, battledore, from Ar. *rāḥat*, palm of the hand). A modern legitimate descendant of the old game of tennis (q.v.). It is probably of British origin and arose about the beginning of the nineteenth century, being at that time played chiefly in the English debtors' prisons by men who were tennis players, but in their incarceration had to make shift with a less elaborate court. It began as an open-court game, the ball being batted against a single wall so as to rebound within a marked space upon the ground. Other walls were added as the game

developed, and it is now mostly played within a closed court surrounded by four walls and covered with a high roof. The game in America is substantially the same as in Europe, excepting that the courts are somewhat slower and sometimes a trifle smaller, and the balls slightly softer. The game is played by two, or by four, divided into pairs, on a covered court having an asphalted or stone-paved floor space of about 60 feet long by 30 wide (or 80 by 40, for double matches), surrounded by plain plastered walls about 40 feet high at one end and both sides. The other end wall is usually utilized as a gallery for onlookers. On the front wall, on one line, 'the service line' is drawn across eight feet from the floor. Two feet two inches, from the floor on the same wall a board is placed flat across it called 'the play-line or board.' The floor is divided by lines into five spaces, two of which are called 'service boxes.' At the start one player, called the 'hand in,' stands in the service box, and the other, the 'hand out,' in one of the spaces.

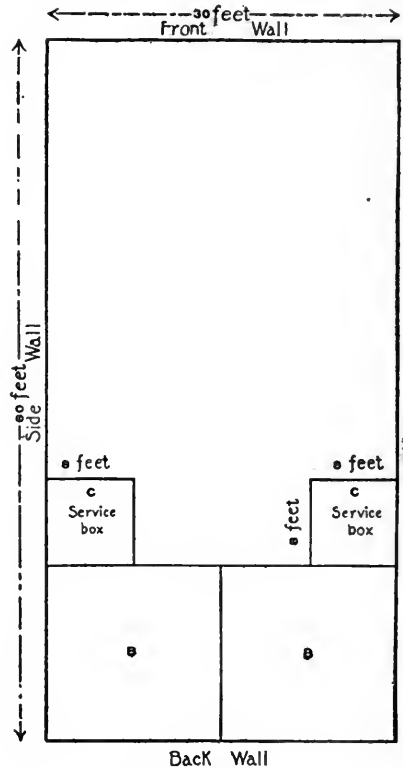

PLAN OF RACQUET COURT.

The 'hand in' drops a ball and strikes it so that, without touching either of the side walls, it strikes the front wall, above the service line on the opposite of the centre to that from which he strikes, and rebounds into space. If these conditions are not conformed to, the 'hand out' is not obliged to take the service. If the 'hand in' fails to accomplish the stroke in two attempts, or hits the service board, or roof, or gallery, he loses his service. His opponent is on the watch to hit the ball before it has touched the ground twice, back to the front wall, above the board, and he is at liberty to strike it so that it first

hits the side walls, with penalty. Then the 'hand in' endeavors to return the stroke in the same manner, and thus the game proceeds until a failure to return the ball above the 'service board' counts against the player who fails. The game is fifteen points, scored according to the rules. In the double game each of the opponents serves in turn.

RADAUTZ, rä'douts. A town of Bukowina, Austria, 32 miles south of Czernowitz. Its manufactures include machinery, paper, leather, and wagons. An Imperial stud, with about 1500 horses, is located here. Population, in 1900, 14,343.

RADBERTUS, PASCHASIUS. A Benedictine monk. See PASCHASIUS RADBERTUS.

RAD'CLIFFE. A cotton-manufacturing and coal-mining town in Lancashire, England, on the Irwell, two miles southwest of Bury (Map: England, D 3). It owns a market and maintains water and gas works. Population, in 1901, 25,350.

RADCLIFFE, ANN (1764-1823). An English romancer, born in London, July 9, 1764. Her maiden name was Ward. In her twenty-third year she married William Radcliffe, a student of the law, afterwards editor and proprietor of the *English Chronicle*. The group of romances by which she became famous comprise: *The Castles of Athlin and Dunbayne* (1789); *A Sicilian Romance* (1790, several times published in Italian); *The Romance of the Forest* (1791, translated into French and Italian and dramatized); *The Mysteries of Udolpho* (1794, translated into French by Chastanay); and *The Italian, or the Confessional of the Black Penitents*, badly dramatized by John Boaden, and put on at the Haymarket as the *Italian Monk*, and translated by the Abbé Morellet (1797). After 1797 Mrs. Radcliffe lived in retirement, and there were false rumors that she had gone insane over the horrors conjured up in *Udolpho*. After her death, February 7, 1823, appeared an historical romance, *Gaston de Blondville* (1826). Of interest also is *A Journey Through Holland and Germany* (1795). Mrs. Radcliffe was an exceedingly popular romancer. For *Udolpho* she received £500, and for *The Italian*, £800—unprecedented sums before the advent of *Waverley*. They were also translated into French. Mrs. Radcliffe gave vogue to the so-called Gothic romance founded by Horace Walpole, the motive of which is to awaken wonder and awe at mysteries, to be finally explained away. Having a real passion for deep woods, mountains, storm, and sea, she was able to add a new interest to fiction. Consult the brief memoir prefixed to *Gaston de Blondville* (1826); Scott's introduction to her romances in Ballantyne's *Novelists Library* (London, 1824); Beers, *English Romanticism* (New York, 1898); and see NOVEL.

RADCLIFFE, CHARLES BLAND (1822-89). An English physician, born at Brigg, Lincolnshire, the brother of John Netten Radcliffe (1826-84), the epidemiologist. He studied under a practicing physician at Wortley, and afterwards in Leeds, in Paris, and at the London University, where he graduated in 1851. He was appointed physician to the Westminster Hospital in 1857, and in 1863 was made physician to the National Hospital for the Paralyzed and

Epileptic. He was Gulstonian lecturer in 1860, and Croonian lecturer in 1873, to the Royal College of Physicians of London. His works include: *Proteus, or the Law of Nature* (1850); *The Philosophy of Vital Motion* (1851); *Epilepsy and Other Affections of the Nervous System, etc.* (1854); *Dynamics of Nerve and Muscle* (1871); and *Vital Motion as a Mode of Physical Motion* (1876). With Ranking he edited Ranking's *Abstract of the Medical Sciences* (1845 to 1873).

RADCLIFFE, or RADCLYFFE, JAMES. See DERWENTWATER, third Earl of.

RADCLIFFE, JOHN (1650-1714). A celebrated English physician, and the founder of the Radcliffe Library at Oxford. Born at Wakefield, in Yorkshire, and instructed in Greek and Latin at the grammar school of his native town, at the age of fifteen he was sent to University College, Oxford. In 1672 he took his degree of M.A., applied himself to the study of medicine, and having taken his degree of M.B. in 1675, began to practice as a licentiate at Oxford. He immediately made himself conspicuous by the originality of his ideas. In less than two years his skill had made him famous. In 1682 he took the degree of M.D. In 1684 Radcliffe removed to London, where in less than a year he became the most popular physician of his time. In 1686 the Princess Anne of Denmark made him her physician. After the Revolution he was sent for by King William frequently, and the example of the sovereign was followed by most of the nobility and influential persons about the Court.

In 1694 he was called upon to attend Queen Mary when attacked by the smallpox, in her last illness, as Dr. Radcliffe predicted, before seeing her, merely upon reading the prescriptions of the other physicians in attendance before he was sent for. Being himself ill, he was unable to attend Queen Anne during her last illness, and her death preceded his by a few months. In 1713 he was elected M.P. for Buckingham. Dr. Radcliffe died at Carshalton, and was buried at Oxford in Saint Mary's Church with much ceremony. He died possessed of considerable property, the whole of which he bequeathed to public uses. Thus, to University College he left his estate in Yorkshire, in trust, for the endowment of two traveling fellowships, and the purchase of perpetual advowsons, together with £5000 for the enlargement of the college buildings. He left £40,000 for the erection of a public library in Oxford, since known as the Radcliffe Library, which he endowed with £150 per annum for a librarian, and £100 per annum for the purchase of books. The Radcliffe Observatory at Oxford was erected through his munificence. He also bequeathed a legacy to Saint Bartholomew's Hospital, London.

RADCLIFFE COLLEGE. An institution for the higher education of women at Cambridge, Mass., founded in 1879 by the Society for the Collegiate Instruction of Women. It had no official relations with Harvard University, although popularly known as the Harvard Annex, until 1894, when by act of the General Court of Massachusetts its name was changed to Radcliffe College in honor of Anne Radcliffe, the first woman to give a money endowment to Harvard. It had in 1903 a faculty of 92, almost all of whom were instructors in Harvard University,

and 429 students. The requirements for admission and for the degrees of bachelor of arts and master of arts are identical with those of Harvard College, and the courses of instruction are for the most part the same. In addition, much of the advanced instruction of the university is open to Radcliffe students. The institution had in 1903 a working library of 18,750 volumes and 1100 pamphlets; buildings and grounds valued at \$490,000; and an income of \$93,130. Sixteen scholarships, each sufficient to meet the tuition fee of \$200, are awarded annually.

RADDE, rä'd'de, GUSTAV FERDINAND RICHARD (1831—). A German-Russian naturalist and traveler, born at Danzig. After accompanying the Russian expedition to Southeast Siberia (1855-60) and going with Von Baer on his scientific trip through Southern Russia (1862), he founded at Tiflis the Museum of the Caucasus, of which he became director. In this capacity he traveled through Upper Armenia (1871), Northern Persia (1879), Daghestan (1885 and 1894), Khorasan (1886), and along the eastern coast of the Black Sea (1890). Among his works are: *Reisen im Süden von Ostsibirien* (1862-64); *Vier Vorträge über den Kaukasus* (1874); *Die Chevresuren und ihr Land* (1878); in Russian a description of his voyage with the grand dukes Alexander and Sergeis Mikhailovitch (1892); *Das Ostufer des Pontus* (1894); and *Die Sammlungen des kaukasischen Museums* (1900 et seq.).

RADEBERG, rä'de-bërk. A town in the Kingdom of Saxony, Germany, situated about ten miles northeast of Dresden (Map: Germany, E 3). It has glass works, paper mills, and manufactures of nails, safes, furniture, etc. Population, in 1900, 12,918.

RADECKE, rä'dë-ke, ROBERT (1830—). A German composer. He was born in Dittmannsdorf, in Silesia, and received his musical training in the Conservatory of Leipzig. In 1853 he became musical director of the Court Theatre of that city. He removed to Berlin soon after, played second violin in Laub's quartet, and gave many successful concerts. He was made royal Kapellmeister in 1871, and in 1891 succeeded Haupt as director of the Royal Institute for Church Music. An artist of ability on pianoforte, organ, and violin, Radecke is best known for his compositions, which include two orchestral overtures, *König Johann* and *Am Strande*; the operetta *Die Mönkgüter* (1824); and, above all, for his many songs.

RADEGUN'DIS, SAINT (519-87). The patron saint of Poitiers, in France. She was the daughter of Berthar, a prince of Thuringia. Having been carried as a prisoner to the country of the Franks in the twelfth year of her age by Clotaire I., King of the district whose capital was Soissons, she was educated in the Christian religion, and when she reached a mature age was induced, reluctantly, to become the wife of Clotaire. Her own wish having been to become a nun, her married life was in great measure given up to works of charity and religion. In 544, her husband having murdered her brother, she fled from the palace and retired to the monastery at Noyon. Afterwards she founded a monastery at Poitiers, in which she lived as a simple sister, but which she endowed richly, not only with money and

lands, but also with relics and other sacred objects. It was on the occasion of the translation to her church at Poitiers of a relic of the holy cross that the poet Vexantius Fortunatus composed the celebrated hymn *Vexilla Regis Prodeunt*.

RADETZKY, rä-dëts'kë, JOSEPH WENZEL, Count (1766-1858). An Austrian field-marshal, born in Trzebnitz, Bohemia. In 1784 he became a cadet in an Hungarian cavalry regiment. His first campaign was against the Turks in 1788-89. He fought in the wars of the French Revolution and the Napoleonic wars, attaining the rank of major-general in 1805 and lieutenant-field-marshal in 1809. In that year he fought bravely at Aspern and Wagram. After the conclusion of peace he became chief of the quartermaster-general's staff and took a leading part in the reorganization of the Austrian Army. In 1813-14 and 1815 he was chief of staff of Triure Schwarzenberg. He distinguished himself at Kulm, and was wounded at the battle of Leipzig. In 1831 he commanded in Italy, and in 1836 he became field-marshal. On the outbreak of the insurrection in Lombardy in 1848 Radetzky was driven from Milan after five days of desperate fighting and fell back on Verona. His position was for a time precarious, but having received reinforcements he was enabled to assume the offensive, and inflicted a crushing defeat on the Sardinian King Charles Albert at Custoza, July 25, 1848. A six months' armistice was agreed to, and war was not resumed by the Piedmontese till March, 1849. Radetzky was this time better prepared, and at once invaded Piedmont. He totally routed the enemy at Novara, March 23, 1849. Peace was concluded with Sardinia, and Radetzky besieged Venice, which surrendered after a long siege (August 23d). He was then appointed Governor-General of Lombardy and Venetia, and ruled with absolute authority till his retirement in February, 1857. He died at Milan. There are biographies of Radetzky by Kroner (Vienna, 1891) and Schönhals (Stuttgart, 1858). Consult, also: Troubetzkoi, *Campagnes du comte Radetzky dans le nord de l'Italie en 1848 et 1849* (Leipzig, 1860); Kunz, *Die Feldzüge des Feldmarschalls Radetzky in Oberitalien* (Berlin, 1890).

RADFORD, Mrs. ERNEST (maiden name DOLLY MAITLAND) (1858—). An English writer of verse, born December 3, 1858. In 1891 she won attention with a volume of beautiful lyrics, entitled *A Light Load*. She next published *Songs for Somebody* (1893); *Songs and Verses* (1895); *One Way of Love, an Idyl* (1898); and *Poet's Larder and Other Stories* (1900).

RADFORD, WILLIAM (1808-90). An American naval officer, born at Fincastle, Botetourt County, Va. He entered the navy in 1825, and rose through successive grades to the rank of rear-admiral, which he attained in 1866. He distinguished himself at Mazatlan in 1847 during the Mexican War, and commanded the *Cumberland* in 1861, but was on court-martial duty at Old Point Comfort when that vessel was sunk by the *Merrimac*. He served in both attacks on Fort Fisher in 1864-65, was in command of the *New Ironsides* under Admiral Porter, and in 1869-70 commanded the European squadron. In 1871 he was retired from the service.

RADIANT. See CIRCLE.

RADIANT STAR, ORDER OF THE. An order of Zanzibar, founded by Sultan Bargash ben Said in 1875. It has two classes, of which the first is given only to sovereigns, the second forming an order of merit with four divisions. The decoration is a red cross with five arms edged with white on a green wreath. The circular medallion bears the Sultan's name. The cross is suspended by a wreath from a red ribbon edged with white.

RADIATA (Lat. nom. pl., having rays). The lowest of Cuvier's four great divisions of the animal kingdom. It derived its name from the organs of sense and motion being disposed as rays round a centre, and included (1) the Echinodermata, (2) the Entozoa (or intestinal worms), (3) the Aculephæ (or sea-nettles), (4) the Polyphi, and (5) the Infusoria. See CLASSIFICATION OF ANIMALS.

RADIATION (Lat. *radiatio*, a shining, from *radiare*, to shine, from *radius*, ray). The name given to the quantity of energy carried by ether-waves or sometimes simply the waves themselves. Since wave-motion involves both the vibration and the displacement of the medium carrying the waves, there is always both kinetic and potential energy associated with the advance of a train of waves. A source which is emitting trains of waves is losing energy, and a body which absorbs them gains energy.

Ether-waves may be divided into two classes: irregular pulses, analogous to the disturbances produced in the surface of a pond by dropping into it at irregular intervals a number of stones; and regular trains of waves, analogous to the aerial waves produced by a vibrating tuning fork. It is believed that the radiation called 'Röntgen rays,' or 'X-rays' (q.v.), is of the nature of the former; while the waves emitted by a flame, the sun, etc., are of the latter kind. They should have quite distinct properties, from theoretical considerations. Irregular pulses, if very abrupt, should not be refracted, diffracted, or polarized; their 'rays' should pass in straight lines. Regular periodic trains of waves should obey the ordinary laws of light (q.v.).

Periodic trains of ether-waves are emitted by all portions of matter, owing to the vibrations of the 'atoms;' they are also produced by electric oscillations. The lengths of these waves can be measured by suitable means—by diffraction gratings (q.v.) and by calculation, in the case of those due to the latter cause. Those waves produced by ordinary matter, which have been actually observed, vary in length from 0.000015 cm. to 0.006 cm.; and waves produced by electrical oscillations have been obtained whose lengths were as small as 0.4 cm., although in general they are much longer. When these waves are incident upon portions of matter, they may be partially reflected if the body is large compared with the wave-length; they may be transmitted or pass around it; or they may produce vibrations in the body by resonance, and so be absorbed themselves. Thus long ether-waves produced by electrical oscillations may produce electric oscillations in suitable electrical conductors. (See ELECTRICITY; WIRELESS TELEGRAPHY.)

The shorter ether-waves emitted by material bodies in their natural condition may be absorbed by other material bodies. In this process of absorption the amplitude of the waves dies down, and their energy is gained by the body which absorbs them. This absorbed energy is spent in various ways, depending upon the length of the absorbed waves and the nature of the absorbing body. To measure the energy carried by any train of waves it is necessary to have the absorbing body such that it absorbs all the energy—that is, neither reflects nor transmits the waves—and consumes it in producing rise of temperature. In the case of extremely short waves, chemical action may be produced; the limits of wave-length so far as now known which will do this are from about 0.00007 cm. to 0.000015 cm. Waves whose wave-lengths lie between about 0.00007 cm. and 0.000035 cm. affect the sense of sight of most human beings. In fluorescent bodies the energy due to absorption is spent in emitting other ether-waves.

The radiation from any body is as a rule characteristic of its temperature and the nature of its surface principally; there are, however, many cases when this is not true. Such exceptions are fluorescing and phosphorescing bodies, gases through which an electrical discharge is taking place, bodies such as the salts used in a Welsbach mantle, which are rendered luminescent at quite low temperatures. *The following statements do not apply to these exceptional cases.* Since absorption is due to resonance, it is natural to expect some connection between the radiation emitted from a body and its absorptive properties. It was shown, first by Balfour Stewart and later by Kirchhoff, that the 'emissive power' of any body is identical with its 'absorptive power' at the same temperature. The absorptive power of a body for a train of waves of a definite wave-number is defined as being the fraction of the incident radiation of that wave-number which the body absorbs. A body which absorbs all waves absolutely is called a 'black body.' The emissive power of a body for a train of waves of a definite wave-number is defined as the ratio of the energy radiated by 1 sq. cm. of the surface of the body in the form of waves of the specified wave-number to that emitted by 1 sq. cm. of a 'black body' under the same conditions of temperature and in the same form. This law can be expressed in symbols: let E be the energy emitted by 1 sq. cm. of a 'black body' at a given temperature in the form of waves of a definite wave-number; let a be the absorptive power of any body for waves of this kind; then e , the energy emitted by 1 sq. cm. of this body for these waves, is given by the formula $e = aE$.

Balfour Stewart's law asserts the identity of the emissive and absorptive powers of a body at any one temperature in all respects, wave-number and polarization. This principle is the basis of spectrum analysis. See SPECTROSCOPY.

It is important, therefore, for theoretical reasons to realize as nearly as possible a 'black body' and to study its radiation at different temperatures. This has been done within recent years, notably by Paschen and by Lummer and Pringsheim. It can be shown that the radiation

inside a hollow solid, whose walls are at a uniform temperature, is identical with that which a 'black body' at that temperature would emit (with certain simple limitations); and so, if a narrow slit is made in the walls of this hollow solid, the radiation which escapes can be studied. To absorb and measure the radiation, it is necessary to coat with some 'black' substance a sensitive thermometer or instrument for measuring changes in temperature; for this purpose a bolometer or radio-micrometer or radiometer is covered with lampblack, which is almost 'black' for most waves. In this way the radiation of a 'black' body characteristic of definite temperatures has been studied; and it is possible to express the results in various formulae. One of these is called Stefan's law; it states that the total radiation of a 'black body' whose surface is S sq. em., and whose absolute temperature is T (i.e. $273 + t^{\circ}$ C), can be expressed as proportional to ST^4 . Other laws connect the temperature and the radiation of definite wave-lengths. As the temperature is increased, so is the radiation. If two bodies at different temperatures are put together, the one at the higher temperature emits more energy than it absorbs, while the reverse is true of the other body. In the end their temperature should become equal.

For a full discussion of the radiation of a 'black body,' reference should be made to the papers by Lummer and Wien, *Reports of International Congress of Physics*, vol. ii. (Paris, 1900), and to recent articles by Paschen in *Annalen der Physik*. The original memoirs by Kirchhoff, Stewart, and others are given in Braue, "Radiation and Absorption," *Scientific Memoir Series*, vol. xv. (New York, 1901). See HEAT AND LIGHT.

RADIATION OF HEAT. See HEAT.

RADICAL AXIS. See CIRCLE.

RADICALISM (from *radical*, from Lat. *radicalis*, relating to a root, radical, from *radix*, root; connected with Gk. *ῥάδιξ*, *rhadíx*, root, *ῥάδαμος*, *rhadamnos*, branch, Goth. *waúrts*, root, OHG. *wurz*, Ger. *Wurz*, AS. *wyr*t, Eng. *wort*, weed). In modern history generally, the temper of mind which is most opposed to the conservative, and aims at constant and progressive reform of political institutions. The word was first used of a political party in England about 1819 though a Radical Party, marked off by clear distinctions from the Whigs, may be said to have originated in 1769 with the first concerted movement to reform and control Parliament by pressure from without. Oddly enough, the efforts of the first Radicals were directed not against the Crown or the House of Lords, but against the House of Commons. Radicalism in its origin was a middle-class movement; its active men were a limited class of voters who conceived that their rights were being infringed. Their first popular leader was Wilkes.

A second period extends from 1789 to 1831. The mighty influence of the French Revolution brought up a new class of Jacobinical Radicals. Under Thomas Paine and Godwin, significant changes took place in their attitude. The Crown and the House of Lords were attacked; complaints of oppressive taxation were heard; and the leaders of the school were most of them men who rejected religious creeds. The first quar-

ter of the nineteenth century was a discouraging time for the Radicals, but they were not disheartened. This period witnessed the rise of the most profound and systematic philosophy of radicalism that had yet been formulated. The scientific or philosophical Radicals now came forward, with Bentham and James Mill, with Ricardo and Grote and Joseph Hume. They gained a powerful organ when in 1824 they founded the *Westminster Review*. But there were also practical reformers, and the party was beginning to be recognized as having a definite existence. The working classes now began to take a greater part in the movement, and the first hints of modern socialism were given by Spence and Owen.

The third period opens with the definite agitation for reform of Parliamentary representation, which is part of general English history. While the Radicals lent their support to the movement for the passage of the Reform Bill, they regarded its results with disappointment, and tended to become more and more sharply dissociated from the Whigs who had passed it. The hope of further enfranchisement of the people seemed slight; and the feeling of despair thus engendered gave rise to one of the most important phases in the history of English radicalism, the Chartist movement. (See CHARTISM.) The Anti-Corn Law agitation, though the work of Radicals, especially of their two brilliant leaders, Cobden and Bright, was not an essential part of their campaign. Yet the Manchester school of politicians may be called the dominant type of Radicals from say 1840 to 1885, the connecting link between those of the beginning and end of the century. Though from a despised and persecuted sect, the Radicals, especially under the strong leadership of Chamberlain, succeeded in becoming the controlling force in the Liberal Party, their triumph is not so complete as it appears, and many of the reforms to which strict theoretical Radicals have all along been committed seem as far as ever from accomplishment.

On the Continent there is a strong tide of Radicalism. France has had a strong Radical Party, under one name or another, ever since the outbreak of the Revolution. Its tenets are those of the party wherever it is found—the widest possible liberty for the individual. In addition the French Radicals have been the most persistent opponents of monarchy, and to their efforts the success of the revolutions of 1830 and 1848 may be attributed. To-day they are a strong party. In Germany the rise of the Radicals is of a comparatively recent date. The Socialists, both in Germany and France, must be considered as closely allied to the Radicals. Consult: *The Radical Programme* (London, 1885); Lowell, *Parties and Governments of Continental Europe*, 2d vol. (Boston, 1897); Kent, *The English Radicals* (London, 1899). See POLITICAL PARTIES.

RADICLE, or RADICAL (in chemistry). See CARBON COMPOUNDS.

RADIOACTIVITY. The name given to the property which uranium, thorium, and other bodies to be described presently have of sending out certain radiations spontaneously. Immediately after the discovery of X-rays by Professor Röntgen in 1895 many physicists began investigations in order to see whether phosphorescent bodies in general would not emit rays of the

same character. Among these was Prof. H. Becquerel of Paris. He, in the first months of 1896, made the great discovery that the salts of uranium emitted spontaneously certain radiations which would affect a photographic plate. He also found that these radiations would, like X-rays, discharge electrified bodies, produce phosphorescence, and traverse many bodies which were opaque to ordinary light. The name 'Becquerel rays' was given to these radiations. They were investigated immediately with the greatest care by many others, particularly by E. Rutherford, who was then a student in the laboratory of J. J. Thomson, Cambridge, England; and their properties will be described below. In the search for other substances which would emit radiations similar to those described above, it was discovered, almost simultaneously, by Professor Schmidt and Madame Curie of Paris, in the year 1898, that the salts of thorium emitted rays similar to those of uranium. M. and Mme. Curie began a prolonged investigation of all metals and metalloids, the rare earths, and a great number of rocks and minerals, in the hope of discovering other radioactive bodies, and were rewarded by discovering that pitchblende, which is a mineral containing the oxide of uranium and other substances, was much more active than pure metallic uranium. By a series of chemical separations, they were able to isolate two substances, 'radium' and 'polonium,' which were most intensely radioactive, in some cases several thousand times more so than uranium.

Radium is undoubtedly an element with a definite atomic weight and is found to accompany the barium which is separated from pitchblende. It is not yet proved that polonium is an element, but it is a substance which accompanies the bismuth separated from the pitchblende and is similar to it in its chemical properties. The discovery of these substances was made in 1898; and in 1899 another radioactive substance was discovered by M. Debiere which he called 'actinium,' and which accompanies certain bodies of the iron group contained in pitchblende and seems to be connected with thorium. It has been shown by recent investigators that almost all substances in nature are to a greater or less extent radioactive. Among these may be mentioned the leaves of plants, freshly fallen rain or snow, etc.; and the hypothesis has been advanced that this radioactivity is due to certain radiations emitted by the sun itself and which are connected with the appearance of the aurora borealis and the other phenomena of atmospheric electricity. In the spring of 1903 it was discovered by Prof. J. J. Thomson that the water obtained from deep wells contained a radioactive gas; and beyond a doubt other substances will be found which possess this power of radioactivity.

The properties of the radiations which are obtained from radioactive bodies may be grouped under various heads: chemical, electrical, fluorescent, and physiological. Among the chemical properties it may be sufficient to mention the photographic action of the rays and their power to color glass and porcelain, and in certain cases to produce ozone. The electrical properties of the radiations are the most interesting, as they have led to several most important advances in the theories of matter and electricity. These will be discussed more fully in what follows; but, in

brief, the most obvious electrical effect of the radiations is to make a gas through which they pass a conductor for electricity. In regard to the fluorescent properties nothing need be said except to state that a great number of substances fluoresce under their action. The most important physiological actions so far studied are their power to produce luminosity in the human eye, to cause the same kind of peculiar burn of the skin as do X-rays, and in certain cases to paralyze the nerve centres. It is extremely probable that these radiations have the same therapeutic properties as do X-rays in such diseases as cancer, lupus, etc.

As stated above, these radiations possess the power of penetrating and passing through many substances which are opaque to ordinary light; but it was soon discovered that there were differences in this power which could only be explained by assuming that the radiations were complex in their nature, being made up of two groups, one very easily absorbed, the other extremely penetrating. The attempt was made to see whether either of these groups of radiations could be reflected, refracted, diffracted, or polarized, but it was found that they possessed none of these properties. It was discovered, however, that although in this last respect the radiations were similar to X-rays, they differed from them in being deviated by a magnetic field. This proves that the radiations from radioactive bodies are not disturbances in the ether similar to X-rays or light, but are electrified particles of matter moving at a rapid rate. It was discovered by several observers that the penetrating rays were easily deflected by a magnetic field, and in such a direction as to prove that they were carriers of negative electrical charges. It has been shown that an electrically charged body, if in rapid motion, is equivalent to an electric current, and since an electric current, if free to move in an electric field, is acted upon mechanically by the field, therefore an electrified particle in motion will have the direction of its path changed if subjected to a strong magnetic field, and the direction of the deflection will depend upon whether the particle is charged positively or negatively. It may be shown that there is a mathematical connection between the mass of the moving particle, its electrical charge, its velocity, the strength of the magnetic field, and the amount of the deflection produced.

For obvious reasons, a charged particle in motion will have its direction also changed if it is made to pass through an intense transverse electrical field. It was not, however, until 1902 that it was proved, by Rutherford, that the easily absorbed, non-penetrating radiations were deflected also by a magnetic field, but in such a direction as to prove that they were positively electrified bodies. Thus the former rays are like the cathode rays in an ordinary vacuum tube; the latter, like the so-called canal rays. By means of experiments which need not be described here, it has been shown that although the electrical charges carried by the two kinds of radiations are equal and, so far as is known, identical with the charge carried by a hydrogen ion in ordinary electrolysis, nevertheless, their masses are quite different. The mass of a particle of the α radiations, as the non-penetrating rays are called, is comparable with that of a hydrogen atom; while the mass of a particle of the β radiations,

as the penetrating rays are called, is approximately one-thousandth as great. The velocities with which these particles are emitted are extremely great, but vary within wide limits with the substance emitting them and its condition. The velocity may be as great in certain cases as 2×10^{10} cms. per second, which is approximately as great as the velocity of light. It is interesting to note that Prof. J. J. Thomson has shown from the observations of Kaufmann that the total mass of the β radiations may be accounted for as due to the motion of the charge; because, as explained in the article on MATTER, an electrified particle in motion has a mass greater than that which it would have if it were not charged, and therefore electricity, by itself, in motion has the properties of matter, so far as inertia is concerned.

A most remarkable discovery was made by Rutherford in his investigation of the properties of thorium. He found that there was given off spontaneously by the salts of thorium an emanation which could be blown from one vessel into another, which was radioactive itself, and which had the power of producing radioactivity in the walls of the vessel with which it came in contact. Similar emanations are given off by radium, but so far have not been discovered with uranium or polonium. Rutherford has shown that the emanation has the properties of an inert gas of a comparatively high atomic weight; it can be condensed at the temperature of liquid air and again vaporized; it can diffuse through porous partitions, and it can be occluded. The emanation as it leaves the body which produces it has no electrical properties, but it soon emits β radiations, and therefore becomes positively charged itself. If, therefore, there are any negatively electrified bodies in the neighborhood, the particles of the emanation will settle upon them; and it has been observed, as stated above, that these bodies now become radioactive. Certain chemical changes go on, and there is produced a condition, or better, a substance, which has been called 'excited activity.' This in turn is radioactive; and the radiations or emanations from it produce a secondary excited activity in neighboring bodies. In the case of radium this secondary excited activity produces a tertiary activity; and it is not known where the process stops. Observations made during the summer of 1903 show that in these cases, after these slow changes, a gas appears which beyond a doubt is helium. This, then, is the end-product.

The method by which the radiations from radioactive bodies produce their effects is not yet established, although many facts are now clear. It has been shown that the α radiations produce almost the entire action of the radiation, as might be expected from the fact that, although moving so rapidly and having so large a mass, they are so easily absorbed. The process of making a gas a conductor for electricity, or of 'ionizing' it, as it is called, consists in breaking up its electrically neutral molecules into electrified parts, or 'ions,' which are therefore acted upon by an electric field. This process of dissociation of the gas is brought about in some manner by the motion through the gas and absorption by it of the rapidly moving α and β radiations. The various other actions of the rays, namely, the chemical, physiological,

and other ones, can be accounted for roughly from obvious mechanical principles.

The explanation of the cause of the emission of these radiations by the various radioactive substances is also not yet clear, although a great step has been made in advance by Rutherford and Soddy of McGill University. They have shown that if to a salt of thorium (thorium nitrate, for instance) ammonia be added, a precipitate is formed; and, if this be separated from the solution by filtration, the resulting filtrate, called thorium X, is found to be extremely radioactive, while, on the other hand, the precipitate is at first but slightly radioactive. The thorium X, which can be separated from the filtrate by evaporating the ammonia, is found to lose its radioactivity with time, and to set free the emanation simultaneously; while the precipitate referred to above, which is at first radioactive to only a slight degree, rapidly increases in activity. It is found further that, as the precipitate gains in activity, chemical changes go on of such a nature that, if it be now dissolved in ammonia, it will be seen that thorium X has been formed in the process. This means that starting with the almost inactive thorium, owing to the chemical changes thorium X is formed in it as a definite substance, which may later be separated from it, and that coincident with these chemical changes the α and β radiations are emitted. In short, the radioactivity of thorium, and of the other substances also, is maintained by the continued production of new kinds of matter which have well-defined chemical properties enabling them to be separated from the original substance, and which possess temporary activity. In a similar manner the thorium emanation is formed from the thorium X, and the thorium excited activity from the thorium emanation, etc. The final product, as stated above, and as was first conjectured by Rutherford, is the gas known as helium.

It has been shown that the changes just described do not take place simultaneously, but in the order given, and that the radioactivity of each of the compounds, for instance, thorium X, is connected not with the change in which it was produced, but with that by which the next substance is produced from it. It follows from this that a body which is radioactive must of necessity be undergoing change; and, therefore, it is not possible for any of the new forms of radioactive matter, for instance, thorium X, the emanations, etc., to be identical with any of the known elements. They remain in existence unchanged for but a short time, and the decay of their radioactivity is an indication of their diminishing quantity.

As has been described above, there is a definite series of changes by which thorium produces thorium X, thorium X produces thorium emanation, and so on. This same series of steps holds to a certain extent with the other radiations so far as studied, although the series is in no other case so complete. Radium has been shown to produce a radium emanation, and this to produce an excited activity, and so on; the small amount of radium so far available for investigation has made it impossible to learn whether there is an intermediate product, radium X, between radium and its emanation. Uranium has been shown to produce uranium

X; but an emanation from it has not yet been discovered. Both kinds of radiation, the α and β , are not present to the same extent in all the transformations which occur in these various cases; and in some only the α radiations have been detected and in others only the β radiations. It seems probable, however, that the production of the α radiations goes on quite independently of the β radiations, which is a secondary phenomenon, the α radiations playing by far the most important part in the changes which take place in radioactive matter.

One of the most important questions connected with radioactivity is that of the origin of the energy which is manifested by the expulsion of these rapidly moving particles. The amounts of this energy have been measured approximately, and various theories have been advanced based upon obvious assumptions in regard to the nature of the atom and the motion in it of its parts, which are to a certain degree satisfactory. The atom is thought to consist of a definite space within which are moving many thousand particles negatively charged, and which are identical with the β radiations. If the atom is unstable, it is not difficult to see that some of these particles might be from time to time thrown off, and a consistent theory of matter along these lines has been devised by Professor J. J. Thomson. One of the most interesting evidences of the intense energy furnished by these radioactive bodies is the fact that M. Curie has shown that in certain experiments radium sets free in a continuous manner energy in such a form as to maintain itself at a temperature higher than that of the surrounding bodies, and of such an amount that one gram of radium would raise the temperature of one hundred grams of water one degree Centigrade in an hour. A noteworthy fact is that the radioactive substances uranium, thorium, and radium are of very high atomic weights, standing at the end of their groups of elements in the Periodic Table; and that therefore they may mark a condition in which matter is on the verge of instability under present conditions of pressure and temperature.

For the more detailed statements in regard to the properties of radioactive bodies, reference should be made to articles by Rutherford in the *Philosophical Magazine*, and to a popular article, "Some Recent Advances in Radioactivity," by Professor Soddy, in the *Contemporary Review*, May, 1903.

RADIA/LA/RIA (Neo-Lat. nom. pl., from Lat. *radiolus*, diminutive of *radius*, ray). A group of minute marine animals forming an order of rhizopodous Protozoa (q.v.). About 85 families, including many thousand species, are known, most of them microscopic. They live in the surface water of the ocean and their shells, after death, sink to the bottom and form siliceous deposits, known as radiolarian ooze. (See OOZE.) They are distinguished from all other Protozoa by their complex and generally very beautiful shells, which are composed of silicon, except in a few cases where either the material is a horny substance called 'acanthin,' or the shell is entirely wanting. The radiolarians are further distinguished by the presence of a peculiar, membranous, inner capsule. This is either spherical

and perforated by numerous small openings or it is ovoid with a single large opening. Within it is some clear transparent cytoplasm and the nucleus, while outside is a layer of protoplasm which is covered by a gelatinous envelope, known as the calymna. The skeleton or shell consists of one or more fenestrated spheres: when more than one are present they are concentric. They are connected with each other by radiating rods and spicules which are usually continued outside the outermost sphere as projecting spines, and may be continued inwardly to meet within the centre of the capsule. The variety of form and arrangement is very great and is the cause of the beauty of these animals under the microscope. The pseudopodia are usually very flexible and anastomose freely, but in some cases they are stiff and not inclined to fuse. Contractile vacuoles are not present, but in most radiolarians are very small yellowish spheres, supposed to be parasitic algae; it is possible that these are concerned with the process of excretion. Reproduction takes place either by fission or by spore formation. In the latter case both macrospores and microspores are formed, and it is supposed that one of each must fuse together to give rise to a new individual. Radiolarians play an important part in the economy of the ocean, furnishing food for countless hosts of minute crustaceans and other animals, which in turn supply the fishes. All recent investigations into the biology of the ocean give an important place to this order.

FOSSIL FORMS. Radiolaria are abundant in a fossil state; they have been found in rocks of most of the geological systems, and in many cases they have formed siliceous rocks of considerable thickness. These latter, described from Brittany, England, and New South Wales, recall the radiolarian ooze of the modern ocean bottom. They are among the oldest known organisms, for they are found in quartzites interbedded with Pre-Cambrian gneiss in Brittany. They occur in abundance in phosphate nodules in the lower Cambrian of New Brunswick, Canada, and in Cambrian rocks of other regions. Cherts and jaspers of Ordovician, Silurian, Devonian, and Carboniferous age in Europe, Asia, and Australia have been found to contain them, often in abundance. The Mesozoic and Tertiary flint-bearing deposits, like the chalk of Europe and America, yield them, and the polishing earths known as 'Barbadoes earth' and 'tripoli' owe their abrasive powers to them.

Consult: Haeckel, *Die Radiolarien* (Berlin, 1862-88); id., *Report on the Radiolaria* (*Challenger Reports*, London, 1887); Von Zittel and Eastman, *Text-book of Palaeontology*, vol. i. (New York and London, 1900); Rust, "Beiträge zur Kenntnis der Fossilien Radiolarien," in *Palaeontographica*, vols. xxxi., xxxiv., xxxviii. (Jena, 1885-94).

RADIOLITES, rā'di-ō-lit'ēz (Neo-Lat. nom. pl., from Lat. *radiolus*, little ray). A very peculiar fossil pelecypod of Cretaceous age, allied to Rudistes. See RUDISTÆ.

RADIOMETER (from Lat. *radius*, ray + Gk. μέτρον, *metron*, measure). An instrument invented by Crookes and improved by Pringsheim and E. F. Nichols. It consists essentially of a framework carrying one or more mica vanes supported and free to turn around an axis in an inclosed space from which prac-

tically all the air has been exhausted; one face of each vane is coated with lampblack, while the other is polished. In the radiometer of Crookes there are four such vanes carried on a little framework, not unlike a windmill with four arms; and this being pivoted can revolve around an axis. In the form as used by Nichols



CROOKES RADIOMETER

there are several modifications, the most important of which is that the mica vane can no longer revolve freely, but can simply turn through a small angle. In a space so exhausted as that around the mica vanes, the particles of the gas are few in number comparatively, and their mean free path may be over a centimeter. If, now, ether-waves fall upon the polished surface of the mica, they are reflected and have no action, but if they fall upon the blackened surface they are absorbed, and the temperature of this surface is raised. As the particles

of the gas now impinge on this heated surface they rebound with an increased velocity, and therefore produce an increased reaction against the surface, pushing it backward. If a Crookes radiometer be exposed to a match, or even the hand if sufficiently close, the mica vanes are set revolving at a high speed. If the gas around the vanes was at ordinary pressures, the molecules would be so close that any increased velocity of the rebounding particles would be transmitted almost instantly throughout the whole gas and so be felt on the polished side as well. Thus there would be no resultant force on the vanes.

In the form of instrument used by Nichols it becomes one of the most sensitive thermometers known, and it can measure most accurately the energy of the ether-waves which its vane absorbs.

RADIO-MICROMETER. This is an instrument invented by Vernon Boys to measure the energy carried by ether-waves. It is a combination of a thermopile and a galvanometer with fixed magnets and movable coils. A loop of wire is suspended between the opposite poles of a horseshoe magnet, with its plane parallel to the line joining the poles; the two ends of this loop are prolonged out of the magnetic field and joined by a wire of a different conductor. Only the junction of the two different metals is coated with lampblack (if the waves in question are due to ordinary thermal radiations), and exposed to the radiation, the other junction being shielded. The radiation being absorbed by the lampblack produces a rise of temperature; this causes a thermo-electric current; and thus the loop of wire is turned through an angle which may be measured by ordinary means. If the instrument is to be used for measuring the radiation of waves produced by electrical oscillations, a slightly different plan is adopted at the thermal junction. Consult Preston, *Theory of Heat* (New York, 1894).

RADIOPHONE (from Lat. *radius*, ray + Gk. *φωνή*, *phōnē*, voice, sound). An apparatus for the production of sound by the action of light

upon a selenium cell in circuit with a telephone. Alexander Graham Bell and Sumner Taintor in 1880 discovered that if a rapidly intermitting beam of concentrated sunlight was allowed to fall upon a selenium cell (see **SELENIUM**), the variations in the resistance of the cell would produce variations in the current which, flowing through a telephone in circuit with the cell and a battery, would cause a sound to be emitted corresponding to the original sound which caused vibrations in the beam of light.

RADISH (OF., Fr. *radis*, from Prov. *raditz*, It. *radice*, radish, root, from Lat. *radix*, root). A garden vegetable, *Raphanus sativus*, of the natural order Cruciferae, probably a native of Asia, cultivated in temperate regions for its fleshy roots, which are eaten raw. The plant attains a height of about three feet and bears white or lilac-colored blossoms on a branched flower stalk. There are two main types of radishes. The summer varieties are annuals and the winter perennials. Both types produce turnip or carrot-shaped white or red roots with intermediate forms. Many winter kinds are black. The flesh of all sorts is white. Under favorable conditions the summer varieties, which are most used for forcing, may produce edible roots in three weeks or even less. They are commonly grown between the rows of slower growing crops like lettuce or beets. In beds the seeds are grown in rows about eight inches apart with one or two seeds to the inch. Radishes grow best on a rich sandy loam soil. They are planted for a succession about every ten days throughout the summer. Winter radishes are sown in July or in early August. They are usually larger than summer sorts and have much firmer flesh. They are stored over winter like turnips. Another species of radish (*Raphanus caudatus*) is cultivated as an esculent in Japan, where it is native. The sea-radish (*Raphanus maritimus*) has roots of great pungency. Horseradish (q.v.) is a near relative. See **PLATES OF FLOWERS** and **VEGETABLES**.

RADISH INSECTS. The insects which affect the radish plant in the United States are for the most part the same species which are found on cabbage and turnips. One important insect enemy of the plant is the cabbage-maggot, or radish-maggot (*Phorbia brassicae*), which infests the roots of many oleraceous plants. The maggots puncture the fleshy root of the radish and make channels through it in every direction, safely beyond the reach of any insecticide application. The best remedy consists in proper methods of fertilizing, and a combination of nitrate of soda, ground rock, and muriate of potash is recommended. This fertilizer should be applied soon after the plants are up and when the leaves are about an inch long, at the rate of 500 pounds to the acre, and before or during a rain. If the application be made at this time it seems to reach the maggots just when they are hatching. The adult flies, which are small brown creatures, rather smaller than the house-fly, lay their white and slender eggs in little masses on the surface of the ground near the infested plants. The maggots soon hatch, and the injurious work begins. The species is closely allied to the onion maggot. See **CABBAGE INSECTS**; **ONION INSECTS**.

RADISHTCHEFF, rá-dish'chëf, ALEXANDER NIKOLAEVICH (1749-1802). A Russian author and reformer, born in Moscow of an excellent

family, and after several years as a page, educated with eleven other young Russians at Leipzig University. There he spent four years, in which he was more deeply influenced by French philosophy and the Encyclopædists than by any part of his university curriculum. He returned to Russia in 1771, received a post in the customs administration, and, although he moved in the best society, intellectually, of Petersburg and knew Voroncoff and Kryloff, made little stir until 1790. Then, under the influence of his liberal convictions patterning after Abbé Raynal's *History of the Indies*, with its philanthropic sentiment, and after Sterne's *Sentimental Journey*, he wrote his famous *Journey from Saint Petersburg to Moscow*, which, with all its humor and excessive sentimentality, is a terribly vivid picture of Russian serfdom and contains a frank programme of emancipation, all the more bold for its appearance in the midst of a period of reaction. Catharine sent the author to Ilimsk, in the Government of Irkutsk. He returned to Russia in 1796 under Paul. Nicholas made him a member of the legislative commission in 1801. But recognition came too late; his exile had made him melancholy and half insane, and he committed suicide.

RADIUM (Neo-Lat., from Lat. *radius*, ray). A radioactive substance first obtained from pitchblende by M. and Mme. Curie and M. Bémont in 1888. Radium is considered to be an element and has many interesting properties which are described under *Radioactivity* (q.v.). It maintains its own temperature 1.5° C. above its surroundings, and according to Professor Curie emits heat radiations without combustion or chemical change and without any appreciable decrease in its energy. Its spectrum has been examined by Demarçay and new and characteristic lines obtained which apparently demonstrate that it is an element. The atomic weight is stated at 225, and although it is believed to be a metal, it has been produced as yet only as a chloride or bromide. Radium is forty times as active as uranium, and its discovery and peculiar characteristics have given rise to many interesting physical speculations. It is enormously expensive to prepare, and in 1903 it was said that to produce a kilo of a chemically pure preparation of radium would cost \$6,000,000, and that this quantity would require about 5000 tons of uranium residue at an expense of handling of about \$2000 per ton. See **RADIOACTIVITY**; **OLONIUM**; **URANIUM**.

RADIUS (Lat., rod, staff, spoke, semidiameter, ray). A straight line from the centre to any point on the circumference of a circle (q.v.).

RADIUS OF CURVATURE. See **CURVE**.

RADIUS-VECTOR (Neo-Lat., semidiameter-carrier). The linear coordinate in a system of polar coordinates. See **COORDINATES**.

RADIX (Lat., root). In mathematics, the base of a scale of notation or a system of powers. See **LOGARITHMS**; **SCALES OF NOTATION**.

RADLOFF, rä'tlöf, WILHELM (1837—). A German-Russian traveler and philologist. He was born in Berlin, studied there, at Halle, and at Jena, and in 1858 became instructor at Barnaul in Western Siberia, a position which he held until 1870. After acting (1871-84) as departmental inspector of

Mohammedan schools in Kazan, Radloff was appointed curator of the Asiatic Museum in Saint Petersburg. In 1886 he traveled in the Crimea and in 1887 in Lithuania for research in local dialects. His publications include: *Proben der Volkslitteratur der türkischen Stämme Südsibiriens* (1866-96); *Versuch eines Wörterbuchs der Türkdialekte* (1888 sqq.); *Das Schamanentum und sein Kultus* (1885), two great works in Russian on "Siberian Antiquities" (1888) and the ethnology of the Siberian Turkish peoples (1888); and *Atlas der Altertümer der Mongolei* (1892 sqq.).

RADNORSHIRE. A southern inland county of Wales, Great Britain, bounded on the north by Montgomeryshire and Shropshire, and on the south and southeast by Brecknockshire and Herefordshire (Map: Wales, C 4). Area, 471 square miles. Groups of mountains, of which Radnor forest (2163 feet high) is the loftiest, cover the greater part of the country. The southeastern district is flat, with a gradual slope toward the east. Of the rivers, the chief of which flow southward, the principal is the Wye, which forms the greater part of the southern boundary. The county formerly comprised large tracts of bog and moor land, which are in course of being gradually reclaimed and cultivated. In the east and southeast districts excellent wheat, barley, oats, and potatoes are grown. Capital, Radnor. Population, in 1891, 21,791; in 1901, 23,300.

RADOM, rä'dóm. A government of Russian Poland. Area, 4470 square miles. It is somewhat hilly in the south and level in the north. In the latter part are found also considerable stretches of marshland. The principal river is the Vistula, which forms a considerable part of the boundary. The climate is damp and unhealthy in the marshy districts. Agriculture is the principal industry. Cereals are raised for export. There are a large number of iron works. Population, in 1897, 820,363. Capital, Radom.

RADOM. The capital of the Government of Radom, in Russian Poland, situated on the Mleczna, about 60 miles south of Warsaw (Map: Russia, B 4). It is a well-built town, and has manufactures of machinery and leather. Population, in 1897, 28,750. Radom was the scene of a number of diets in the history of Poland. It was allotted to Austria at the third partition of Poland, and became part of the new Kingdom of Poland in 1815.

RADOWITZ, rä'dô-vits, JOSEPH MARIA VON (1797-1853). A Prussian general and statesman, born at Blankenburg, Brunswick, the son of a nobleman of Hungarian descent. He entered the army in 1812, and was wounded at the battle of Leipzig. He became a teacher in the military school at Cassel and entered the Prussian service in 1823. In 1830 he became chief of the general staff of artillery. In 1836 Radowitz was sent as Prussian military commissioner plenipotentiary to the German Diet at Frankfurt. In 1842 he was named ambassador extraordinary and minister plenipotentiary at the courts of Karlsruhe, Darmstadt, and Nassau; and in 1845 he was raised to the rank of major-general. He exercised a marked influence over Frederick William IV. His lively interest in the contemporary politics of Germany is shown in his writ-

ings, *Gespräche aus der Gegenwart über Staat und Kirche* (1846), and *Deutschland und Friedrich Wilhelm II.* (1848). In the Frankfort Parliament Radowitz was the leader of the ultra-conservatives, but he subsequently modified his views and favored a constitutional monarchy and a united Germany under Prussian leadership. In September, 1850, he became Prussian Minister of Foreign Affairs, but resigned in November on the failure of his anti-Austrian policy, and retired to Erfurt, where he wrote his *Neue Gespräche aus der Gegenwart* (1851). He died at Berlin. Consult Frensdorff, *Joseph von Radowitz* (Leipzig, 1850). His collected works in five volumes were published in Berlin (1852-53).

RADULESCU, ră'dool-les'koo, JOAN HELIADE. See HELIADE-RADULESCU.

RADZIWILL, răd'zė-vil. An old Lithuanian-Polish family, descended from NICHOLAS I. (1366-1446), Palatine of Vilna, who was equally distinguished as warrior and statesman. The most distinguished modern member of the family was MICHAEL JEROME (GERON) (1778-1850). He served as lieutenant in the war of independence under Kosciuszko until 1794, joined Napoleon on his march into Russia (1812), and was made by him brigadier-general. During the Revolution of 1830-31 he was for a short time general-in-chief of the Polish army and after its defeat was transported into Central Russia and detained there until 1836, when he retired to Dresden.

RAE, ră, JOHN (1813-93). An English Arctic explorer, born near Stromers, in the Orkney Islands. He studied medicine at Edinburgh, and in 1833 became resident surgeon at one of the stations of the Hudson's Bay Company, where the greater part of his time was devoted to scientific study. In 1846-47 he made his first Arctic journey, and explored 700 miles of the coast of Committee Bay. In the following year he joined the Government land expedition to search for Sir John Franklin. In 1850 Rae was again sent out by the Government in quest of the lost explorer. During the year consumed by this expedition the party traveled 5380 miles, covering much territory in Wollaston Land and Victoria Land, concerning which nothing had been known, and mapped out 700 miles of new coast line. In 1853 he set out with another party, under the auspices of the Hudson's Bay Company, with the object of completing the survey of the coast line. In Repulse Bay he obtained definite news of Franklin's fate, and upon returning to civilization with the news, found that his party had earned the reward of £10,000 offered for the first accredited information of the lost explorer. In 1858, 1860, and 1864 he took a prominent part in various expeditions in the northern part of the American continent. His activity and endurance bordered upon the marvelous, and he is said to have walked 20,000 miles in the course of his various journeys and explorations. The later years of his life were passed in London, where he held various offices in corporations and institutions concerned with colonial matters. Rae published, in 1850, *Narrative of an Expedition to the Shores of the Arctic Sea in 1846 and 1847*. An account of his work is given in Richardson, *Polar Regions* (London, 1861). Consult, also, the same author's *Arctic Expeditions* (ib., 1852-53).

RAE, JOHN (1845—). An English economist, born in Wick, Scotland, and educated at the

University of Edinburgh. He wrote for English periodicals, made an especial study of the history of economics and of modern economic tendencies, and published *Contemporary Socialism*, a valuable study (1884; 3d ed. 1901); *Eight Hours for Work* (1894); and *Life of Adam Smith* (1895).

RAEBURN, ră'börn, Sir HENRY (1756-1823). A Scottish portrait painter. He was born at Stockbridge, near Edinburgh, March 4, 1756, and at the age of fifteen was apprenticed to a goldsmith at Edinburgh, painting water-color miniatures during his leisure hours. From David Martin, a local portrait painter, he received some inspiration, and learned to adopt a broader treatment in miniatures. Encouraged by his success in this branch of art, he began to fit himself for portrait painting by copying portraits in oil. After contracting a fortunate marriage in 1778, he was enabled to study abroad, to which he was urged by Reynolds, whom he met on a visit to London. After studying for two years at Rome, he returned to Edinburgh, and soon attained great popularity. He was elected president of the Society of Artists in Scotland in 1812, and Royal Academician in 1815. On a visit of George IV. to Edinburgh in 1822 he was knighted, and the following year was appointed the King's limner for Scotland. He died at Edinburgh, July 8, 1823. Raeburn occupies a position in Scottish art similar to that of Reynolds (q.v.) in English. His portraits are strikingly realistic and intense, and are painted in full light. His work has been compared to that of Frans Hals and Velazquez, whom he resembles in this regard and in his facile brush work. The most notable Scotchmen were among his sitters, such as Robertson, Hume, Boswell, Christopher North, Jeffrey, Dugald Stewart, Braxfield, John Erskine, and Sir Walter Scott. There are good examples of his work in the Edinburgh National Gallery, in the National Portrait Gallery, London, and in the Louvre. Consult Andrew William Raeburn, *Life of Sir Henry Raeburn* (London, 1894).

RAFF, răf, JOACHIM (1822-82). A German composer, born at Laehen, Switzerland. He first engaged in scientific studies, but studied music under Mendelssohn, and in 1850 followed Liszt to Weimar. He published *Die Wagnerfrage* (1854), in which he advocated Wagner's theories. In 1856 he went to Wiesbaden, where he gave all his time to composition until 1877, when he was called to the new Conservatory of Music at Frankfort-on-the-Main. Raff was a prolific writer, his compositions numbering over two hundred, including notable examples of nearly every musical form. He was possessed, however, of a facility of invention which poverty frequently drove him to employ to the detriment of his reputation; hence the uneven character of his work. His best work proves him a master of technic, and a composer of high rank. Among his eleven great symphonies are *Im Walde* and *Lenore*, which are universally esteemed. He wrote the operas *König Alfred* and *Dame Kobold*, and many charming songs. He died at Frankfort-on-the-Main.

RAFFAELINO DEL GARBO, răf'fă-ěl-ě'no děl găr'bó (1466-1524). A Florentine painter of the Early Renaissance. He was born in Florence, and studied under Filippino Lippi, whom he

assisted in his work for the Chapel of Minerva at Rome. In his earlier period he was a promising follower of his master, but he was not sufficiently gifted to adopt the High Renaissance, and finally degenerated into a mere craftsman. His chief works are an "Altar-piece" in the gallery of Santa Maria Nuova, Florence (1500); the "Coronation of the Virgin," Louvre; the "Resurrection," Florentine Academy; a "Madonna," Church of Santo Spirito (1505); and two pictures of the "Virgin Enthroned" and "Madonna and Child," in the Berlin Museum. A notable portrait of a "Young Man" is in the Layard Gallery at Venice.

RAFFAELLI, rá'fá'lé', JEAN FRANÇOIS (1850-). A French painter, sculptor, and etcher, born in Paris. He began his career as a singer, then studied art under Gérôme, and first exhibited in 1870. But he did not fully reveal himself until an exhibition of his works held in 1884, for which he wrote a catalogue, *Etude des mouvements de l'art moderne et du beau caractéristique*. Though powerfully influenced by the impressionist movement and by the purely naturalistic school, he was like Degas rather an independent in his own methods. He is especially a student of character, and in his early works deals mostly with low life in the suburbs of Paris, often in winter. The backgrounds are long straight roads, bordered by slender trees, and the typical suburban buildings beneath a melancholy lowering sky. An example of this style is "The Old Convalescents" (1892, Luxembourg). Afterwards his range became wider, and his later works are more happily conceived. Spring takes the place of winter in delicate luminous landscapes, and he paints such pictures as the series of views of Notre Dame, the "White Horse;" the charming portrait of his daughter Germaine (1896); "Young Girl Regarding Herself in a Mirror" (1897); "Portrait of Mlle. Marie Louise" (1898); and "Young Girl with the Cornflower." Other pictures by him are "At Gonon's Foundry" (Lyons Museum); "Old Ragpicker" (Nantes Museum); and the portrait of "Edmond de Goncourt" (Nancy Museum). His medium is generally oil or pastel, and he is the inventor of a new method of using solid oil tubes in painting, which has so far proved successful. His work as a sculptor includes bas-reliefs, portraits, and character studies in plaster and bronze. His drawings were published in the *Revue Illustrée*, and as *Types de Paris*, and he is also an etcher of ability. In 1889 he received a gold medal at the Universal Exposition and the Legion of Honor.

RAFFAELINO, rá'fá-él-lé'nò. The name commonly applied to the Italian painter Raffaello dal Colle (q.v.).

RAFFAELLO, rá'fá-él'lò. See RAPHAEL.

RAFFET, rá'fá', AUGUSTE (1804-60). A French lithographer, born in Paris. He was a pupil of Cabanel, then of Charlet, and afterwards he studied under Gros. His first drawings deal with the army of the Revolution and the First Empire. Each one of these pieces has Napoleon for the central figure, and of these "His grognait et le suivait toujours" and the "Re traite du bataillon sacré" are the best. In 1850 he began his superb series on the siege of Rome. In these the draughtsmanship is remarkable. His

imaginative subjects include "Revue nocturne," "Némésis," and "Patriotes de tous les pays, prenez garde à vous," all strong and effectual pieces. His series of 100 lithographs, called *Voyage dans la Russie méridionale et la Crimée* (1833-49), show his talent in still another direction. He was also a skillful portraitist. Consult: Bry. *Raffet, sa vie et ses œuvres* (Paris, 1874); and Curtis, *Some Masters in Lithography* (New York, 1897).

RAFFIA. See JUPATI PALM.

RAFFLES, rá'f'f'z, THOMAS (1788-1863). An English Congregationalist. He was born in London, was educated at Homerton College (1805-09), and preached in Liverpool with conspicuous success from 1812 to 1862. The cause of education of Nonconformist ministers was much indebted to him, and he wrote several hymns, which have been much used. Consult his biography by his son (London, 1864).

RAFFLES, Sir THOMAS STAMFORD (1781-1826). A British colonial administrator, born at sea off the island of Jamaica, on board the ship commanded by his father. At the age of fourteen he got employment in the East India House as an extra clerk. He soon attracted attention, and in 1805 received an assistant secretaryship in Penang, mastered the Malay language on the voyage out, and in 1807 became secretary and registrar of the Recorder's Court. He visited Malacca and studied its resources and proceeded to Calcutta in 1810, where he came to the notice of Lord Minto, the Governor-General, through his contributions to the Asiatic Society. He accompanied Lord Minto in the following year to Java, which, having been taken from the Dutch, became a British possession under Raffles as Lieutenant-Governor, and for five years he administered the affairs of the island with marked vigor, wisdom, and success. He abolished forced labor, regulated taxation, and remodeled the administration of justice, while retaining the Dutch colonial laws. On the restoration of the island to the Dutch in 1816 he returned to England and published his great work on the *History of Java* in 1817. He was knighted, and by request visited Holland to advise with the King in regard to the policy to be pursued in Java. In 1818 he became Governor of Benakulen in Sumatra, reorganized the colony, abolished slavery, established schools, and explored the interior on foot in company with Dr. Joseph Arnold, discovering, among other things, the great fungus, measuring three feet across and weighing fifteen pounds, which is known by their names, *Rafflesia Arnoldi*. Compelled by ill health to return home, he set sail in 1824, but the ship having caught fire, he lost everything, including his great natural history collection, his manuscripts, drawings, and notes, valued at \$100,000. He reached Plymouth later in the same year, and died suddenly near London. His portrait is in the National Portrait Gallery, London. See his *Memoir* by Lady Raffles, his second wife (London, 1830).

RAFFLESIA. A genus of 8 or 10 species of plants of the small parasitic natural order Rafflesiaceæ, the visible parts of which consist merely of a flower. The species attack *Cissus*, making their appearance at first as hemispherical swellings of the bark of the root, and, after the bark has broken, rising in the form of a cabbage

head while the perianth is covered with imbricated bracts, which are more or less recurved after it has opened. The vegetative part which ramifies in the tissues of the host resembles the mycelium of a fungus. After the flower has expanded, it diffuses a carrion-like smell, which induces flies to deposit their eggs. The largest and first discovered species, *Rafflesia Arnoldi*, was discovered in 1818 in Sumatra by Dr. Arnold, and was sent to Robert Brown by Sir Thomas Stamford Raffles, the British Governor in Sumatra, in honor of whom the genus was named. Its flower measures fully three feet in diameter, is capable of containing almost two gallons of fluid, sometimes weighs fifteen pounds, and is the largest of all known flowers. Other smaller flowered species have been found in the Malay Archipelago and the Philippine Islands.

RAFIN, rá'fán', CATHARINE JOSÉPHINE. The real name of the French actress commonly called Catharine Joséphine Duchesnois (q.v.).

RAFINESQUE, rá'fê-nêsk', CONSTANTINE SMALTZ (1784-1842). An American botanist, of French-German descent, born at Galatz, Constantinople. On his first visit to the United States in 1802 he spent three years in Pennsylvania and Delaware collecting botanical specimens. Afterwards he went to Sicily and was there ten years, during which time he continued to study botany and wrote several scientific works in Italian. He was shipwrecked off the coast of Long Island in 1815, on his way to New York, and lost his collection of manuscripts and books. In 1818 he became professor of botany at Transylvania University, Lexington, Ky. Ultimately he settled in Philadelphia. Though a man of wide learning, his works are marred by his tendency to multiply species and by frequent inaccuracies. They include: *Ichthyologia Ohioensis* (1820); *Annals of Kentucky* (1824); *Atlantic Journal and Friend of Knowledge* (8 numbers, 1832-33); *Medical Flora of the United States* (1828-30); and *The Complete Writings of S. C. Rafinesque on Recent and Fossil Conchology* (1864, edited by Binney and Tryon). Consult Gray, "Botanical Writings of Rafinesque" (*Silliman's Journal*, 1841).

RAFVN, ráfvn, CARL CHRISTIAN (1795-1864). A Danish critic and archaeologist. He was born at Brabeholteberg, in the island of Funen, and educated at the University of Copenhagen, of which he was appointed sub-librarian in 1821. In 1825 he founded the 'Society of Northern Antiquities,' as secretary of which he edited and published many ancient Scandinavian manuscripts, occupying about seventy volumes. Among his numerous important works are a Danish translation of Norse Mythic and Romantic Sagas (3 vols., 2d ed., 1829-30); an edition of Ragnar Lodbrog's death-song, under the title of *Krakumál, seu Epicædium Ragnaris Lodbroci, Regis Danie* (1826); a complete collection of the Norse sagas entitled *Fornaldar-Sögur Nordlanda* (1829-30); and the *Færeyinga-Saga* (1823). His most widely known work was his *Antiquitates Americanae* (1837), followed up by him and Finn Magnussen in their *Historical Monuments of Greenland* (1838-45). Another important work in which Rafn collaborated was the great collection of historical sagas representing events that took place out of Iceland, and entitled *Fornmanna Sögur* (1828 sqq.). He also had a great share in

drawing up and editing the Icelandic manuscripts relating to the history of Russia and other Eastern countries, of which three volumes appeared at Copenhagen in 1850-55, under the title of *Antiquités russes et orientales*.

RAGATZ, rá'gáts, or **RAGAZ**. A tourist resort in the Canton of Saint Gall, Switzerland, 11 miles northwest of Chur. It is attractively situated at the mouth of the Tamina Gorge above the confluence of the turbulent Tamina with the Rhine, and commands a fine view of the Rhine Valley. Its chief features are the Kursaal and gardens, the mineral springs and baths, and Bad Pfifers (q.v.). There is a monument to Schelling in the cemetery. Ragatz attracts annually an average of 50,000 visitors. Permanent population, in 1900, 1862.

RAGGED ROBIN. See LYCHNIS.

RAGGED SCHOOLS. Schools maintained by private philanthropy in various English cities. It is not certainly known who first suggested them, but credit for a successful experiment is due to a poor shoemaker, John Pounds, of Portsmouth, who for twenty years prior to his death, in 1839, gathered poor children about him and taught them as he worked. In 1838 London had a Ragged Sunday School, which later became a free day school. The school at Field Lane was opened in 1843. The first free boarding school was started by Sheriff Watson in Aberdeen in 1841. In 1845 Dr. Robertson opened a similar school in the Vennel, Edinburgh. In 1847 Dr. Guthrie published his well-known *Plea for the Ragged Schools*, which had great influence. The movement spread and in a few years ragged schools were to be found in most of the cities. The further development of the English school system, particularly under the acts of 1870 and 1872, which introduced compulsory school attendance in England and Scotland, merged many of the ragged schools into the public schools. After 1851 the ragged schools received small grants from the general funds and a capitation grant of £2 10s. was allowed by the Privy Council from 1856 to 1859. Consult Cornwallis, *Philosophy of the Ragged Schools* (London, 1851).

RAGGEE (from Hind. rági), *Eleusine coracana*. An Indian grain. See ELEUSINE.

RAGHUVAMŚA, rúgh'vō-vān'sá (Skt., family of Raghu). The title of a celebrated Sanskrit poem by Kalidasa (q.v.). In nineteen cantos it describes the life of Rama (see RAMAYANA) and his forefathers and descendants. The work is one of considerable beauty, especially in its similes, and is characterized by rapidity of movement and poetic charm. The text of the Raghuvamsa has been edited repeatedly. The most important editions are those of Stenzler with a Latin translation (London, 1832), by Pandit with the best native commentary on the poem, that of Malinatha (Bombay, 1869-74), and also by Parab (ib., 1893), by Jvalaprasad with an English translation (ib., 1895), and an English translation by Johnstone (London, 1902).

RAG'LAN, Lord FITZROY JAMES HENRY SOMERSET, first Baron (1788-1855). An English field-marshal, the eighth son of the fifth Duke of Beaufort. He entered the army in 1804 and went to the Peninsula in 1808 as aide-de-camp of Sir Arthur Wellesley (later the Duke of Wellington), whose military secretary he became three

years afterwards. He took part in all the great actions of the Peninsular campaign and gained special distinction at the storming of Badajoz (1812). In 1815 he served under the Duke of Wellington in Belgium, and lost his right arm at Waterloo. From 1815 to 1818 he was secretary of the British Embassy at Paris. He was member of Parliament for Truro in 1818-20 and 1826-29. When Wellington was appointed master of the ordnance in 1819, he again chose Somerset as his secretary; and three years afterwards Somerset accompanied his chief to the Congress of Verona. In 1827 the Duke was appointed commander-in-chief of the British Army and called Somerset to the Horse Guards as his military secretary. This office he held till the death of Wellington in 1852. He was then made master-general of the ordnance, and in October was called to the House of Peers as Baron Raglan of Raglan in Monmouthshire. In 1854 he was appointed, with the rank of general, commander of the English forces despatched to operate against Russia. See CRIMEAN WAR.

RAGNARÖK, rägnä-räk'. In Scandinavian mythology, the end of the world, and the fall of the gods before the combined demon hosts of the world. The word *ragnarök* really means 'judgment of the gods,' but it has been conceived sophistically to mean 'twilight of the gods,' and as the *Götterdämmerung* has formed the basis of the Wagnerian music-drama *Der Ring des Nibelungen*. The fundamental conception of the *ragnarök* is the end of the Golden Age, brought about by the conflict of the two types of Norse gods, known respectively as Æsir and Vanir, and by the Æsir's violation of their oaths. The chief source of these conceptions is the poem of the Elder Edda, called the *Völuspá*, a mixture of heathen and Christian conceptions. The battle between the gods and demons is ushered in with the appearance of the divine war maidens, the Walkyries. Balder, the beautiful god, is dead, through Loki's malignant treachery, and his fate seals the doom of the other gods. The giant watchman Eggther strikes his harp, and in each of the three worlds, that of the giants, the Æsir, and Hel, a cock crows calling the warriors to the battle. The hell-bound Garmé bays aloud; the wolf Fenrir tears his chain. On the earth men are engaged in bloodshed and incest. Floods rise everywhere. The old world tree, the ash Yggdrasil, sways to its roots. Then the god Heimdaler sounds his horn, calling the gods to the fray. In mighty array the demon hosts come marching against the gods from the east, north, and south. Odin engages in combat with Fenrir; Freyr with Surtr; Thor with the serpent Midgard; all the three gods fall in the struggle. The demons are masters of the battle-field. The sun grows black, the earth sinks into the sea, the stars fall from heaven. Vapor and fire rage, the high flame licks the sky. The world and the gods are gone. But from out of the flood rises a new earth which unsown grows grain, and the Æsir come again. Consult Chanépie de la Saussaye, *The Religion of the Teutons* (Boston, 1902).

RAGOZIN, rä-gō-zén, ZÉNAÏDE ALEXÉIEVNA (1835—). A Russian-American author, born in Russia, where she was educated. After several years spent in travel, she emigrated to the United States in 1874. Among her published works are: *The Story of Chaldea* (1886); *The Story of Assyria* (1887); *The Story of Media*,

Babylon, and Persia (1888); *The Story of Vedic India* (1895); all in the "Story of the Nations" series; and five volumes of biography in "Tales of the Heroic Age" series. She translated from the French Anatole Leroy Beaulieu's *The Empire of the Tsars and the Russians*.

RAGTIME. The popular title given to the humorous dance or vocal music of negro origin and characteristics, which has had great vogue since the early nineties of the last century. Theoretically, the music of such compositions is an excessive exaggeration of syncopation. The general lack of instruments other than of percussion, among the different African races, of necessity inclined them to punctuate their melodies with strongly marked pulses or accents. Crude emotional effects are gained by increased noise and abrupt syncopation. The very exaggeration of ragtime proved its strongest appeal to the general public. See NEGRO MELODIES.

RAGUENEAU, rägnó', PAUL (1605-80). A French missionary and explorer, born in Paris, France. He became a Jesuit priest, and in 1636 was sent as a missionary to Canada, where for a time he labored among the Hurons. In 1640 he went among the hostile Iroquois in an unsuccessful attempt to secure the release of some French prisoners. Ten years later, as Father Superior, he was active in gathering the remnant of the Hurons who had escaped the massacres by the Iroquois. In 1657 with another priest and a few lay companions he visited the Onondaga tribe of Iroquois; while among them a plot was formed to murder him, and he escaped with great difficulty. In 1666 he returned to France, where he labored as the agent for the missions in New France. His writings give a good picture of the conditions under which the Jesuits of New France labored, and one of his *Relacions* (that for 1648) contains the first mention of Niagara Falls. He wrote *Vie de la Mère Saint Augustine, religieuse hospitalière de Québec en la Nouvelle France* (Paris, 1672). *Relation de ce qui s'est passé de plus remarquables es missions des Pères de la Compagnie en la Nouvelle France* during the years 1645-52 and 1656-57 (7 vols., Paris, 1647-57), and other works. Consult *The Jesuit Relations and Allied Documents*, edited by Reuben Gold Thwaites (73 vols., Cleveland, Ohio, 1896-1901). Consult, also, Parkman, *The Jesuits of North America* (Boston, 1867, later ed., 1897).

RAGUET, rä-gä', CONDY (1784-1842). An American merchant and political economist. He was born in Philadelphia, studied at the University of Pennsylvania, and having shipped in 1804 as supercargo to Santo Domingo, published upon his return a *Short Account of the Present State of Affairs in St. Domingo*. In 1805 a second voyage resulted in *A Circumstantial Account of the Massacre in St. Domingo*. He took part in the War of 1812, was admitted to the bar in 1820, and from 1822 to 1827 was United States consul at Rio Janeiro. When subsequently made *chargé d'affaires*, he negotiated a treaty with Brazil. He was an exponent of free trade, and wrote on that subject *The Principles of Free Trade* (1835). His other works include *An Inquiry into the Causes of the Present State of the Circulating Medium in the United States* (1815) and *On Currency and Banking* (1839).

RAGULY. A term applied to an irregular line employed in heraldry (q.v.).

RAGUSA, rá-góó'zá (Slav. *Dubrovnik*). A historic town and fortified seaport in the Crown-land of Dalmatia, Austria, situated at the foot of San Sergio, 50 miles south-southeast of Mostar (Map: Austria, F 5). It is a walled city with many towers and intersected by the Corso, once an arm of the sea, and now containing the most interesting features of the town, including the Palazzo Rettorale (fourteenth and fifteenth centuries), the former residence of the rectors of the Republic, the old mint, the custom house, and the cathedral completed in 1713. Among other buildings may be mentioned the Palazzo Comunale, the museum, and the theatre. The harbor is small and unprotected and most of the heavier vessels anchor at Gravosa, about four miles from the town. The chief products are oil, silk, leather, and liqueurs. There is some transit trade with Herzegovina. Population, in 1900, 13,174.

Ragusa is believed to have been founded about the middle of the seventh century, by refugees from Ragusa Vecchia or Old Ragusa (the ancient *Epidaurus*), probably destroyed by the Slavs. Although successively subject to Constantinople, Venice, Hungary, Servia, and Bosnia, Ragusa enjoyed a considerable degree of autonomy and repeatedly fought against every encroachment on its independence. At the close of the Middle Ages it became tributary to Turkey, and under Turkish overlordship rose to the position of one of the principal centres of commerce in Southern Europe. Its territory embraced over 500 square miles. Its institutions were aristocratic. The severe earthquakes during the sixteenth century, and especially that of 1667, when the town lost one-fifth of its inhabitants, put an end to the prosperity of the little Republic. Seized by Napoleon in 1806, it was deprived of its independence in 1808 and awarded to Austria by the Congress of Vienna in 1814. From the fifteenth to the eighteenth century Ragusa was a great seat of South Slavic literature. The most famous of the Ragusan poets was Gundulić (q.v.), who died in 1638. Consult Jackson, *Dalmatia*, vol. ii. (Oxford, 1887).

RAGUSA. A city in the Province of Syracuse, Sicily, situated on a steep ridge, on the right bank of the Ragusa, 15 miles from the sea, and 32 miles by rail west-southwest of Syracuse (Map: Italy, J 11). Around the town ancient tombs have been dug out. The city has a Gothic church, a gymnasium, and a technical school. There are manufactures of silk, cotton, woollens, and furniture, and a trade in wine, oil, cattle, and cheese. Population (commune, including Ragusa Inferiore), in 1881, 30,721; in 1901, 31,922.

RAGUSA, DUKE OF. See MARMONT.

RAHBEK, rá'bék, KNUD LYNE (1760-1830). A Danish poet and author, born in Copenhagen. He was educated at the University of Copenhagen and was appointed professor of aesthetics there in 1790. From 1785 to 1809 he directed the *Minerva*, a literary periodical of great influence, and he also edited *Den Danske Tilskuer* (*The Danish Spectator*) in 1791-1808, and in 1815-22. His own works include numerous editions of the Scandinavian poets, particularly Holberg; the critical *Ludwig Holberg som Lytstspildigter*

(1815-17); *Danske Loesebog* (1700); and, with Nyerup, *Bidrag til den danske Ditekunsts Historie* (1800-28).

RAHL, räl, KARL (1812-65). An Austrian historical and portrait painter, born in Vienna, son of the engraver Karl Heinrich Rahl (1779-1843). First instructed by his father, he entered the Vienna Academy in 1827, won a prize in 1831 with "David in the Cave of Adullam," went to Munich and Stuttgart, where he found a sympathetic adviser in Eberhard Wächter, and after his return to Vienna (1834) painted "Kriemhild Declaring Hagen Siegfried's Murderer" (1835, Vienna Museum). In 1836 he went to Venice where he copied Titian and thence proceeded to Rome, where he lived in congenial intercourse with Koch, Thorwaldsen, Riepenhausen, and Genelli and cultivated an eclecticism which borrowed color and technique from the Venetians and composition from Raphael and Michelangelo. From this Roman sojourn date "Hagen and Volker at Kriemhild's Door" (1836), "Confederation on the Rütli, 1307," and "Charles of Anjou Finding Manfred's Body" (1838, Vienna Museum). He returned to Vienna in 1838, but by the end of 1839 was again in Rome, where he remained until 1847. The works executed in Rome during that period include a huge altar-piece with thirty figures "Saint Joseph of Calasanza" (1841, Piarist Church, Vienna); "Persecution of Christians in the Catacombs of Rome" (1844, Kunsthalle, Hamburg; replica, 1849, National Gallery, Berlin); and "Entry of Manfred into Lucera" (1846, Vienna Museum), besides several genre scenes and various portraits. The year 1848 found him as corrector at the Vienna Academy, which was, however, closed during the revolutionary disturbances, when Rahl took up his abode in Munich, until appointed to a temporary professorship at the Vienna Academy, in 1850. He resigned after one term and opened a private school of painting, which was at once attended by twenty-five of his pupils and many more thereafter. For years underrated and slighted by those in authority, he won at last deserved recognition in 1856 through the patronage of Baron Sina, the Greek banker, who secured his services for the decoration of the Greek church in Vienna, the composition of a grand frieze, representing the "Development of the Sciences in Greece" (1860) for the University of Athens, and whose palace in Vienna he adorned in 1861 with four superb easel paintings of "Episodes from the heroic Age of Greece" and the "Four Elements." The façade of the Heinrichshof he decorated in 1862 with twelve allegorical figures of "The Arts of Peace," and the staircase of the Arsenal in 1863 with the allegories of "War and Strategy," "Fame and Honor," "Courage and Wisdom," and "Unity and Power," having shortly before been appointed professor at the academy. Among more than 400 portraits which he is said to have painted are those of many contemporary celebrities in art, literature, and science. Many admirable designs for future decorative work remained unfinished at his death. Consult: Hotter, *Karl Rahl* (Vienna, 1863); George-Mayer, *Erinnerungen an Karl Rahl* (ib., 1882); Reber, *Geschichte der neueren deutschen Kunst*, ii. (Leipzig, 1884); Bodenstein, in *Allgemeine deutsche Biographie*, xxvii. (ib., 1888); and Pecht, *Deutsche Künst-*

ler des neunzehnten Jahrhunderts, iv. (Nördlingen, 1885).

RAHN, rän, JOHANN RUDOLF (1841—). A Swiss art-historian, born at Zurich. After studying at the universities of Zurich, Bonn, and Berlin and investigating in Italy the art-monuments of the early Christian Era, he established himself as privat-docent in his native city, where he was appointed professor at the university in 1877, and at the Polytechnicum in 1883. His principal works include: *Geschichte der bildenden Künste in der Schweiz von den ältesten Zeiten bis zum Schluss des Mittelalters* (1876); *Kunst- und Wanderstudien aus der Schweiz* (1883); *Schweizer Städte im Mittelalter* (1889); *Die mittelalterlichen Kunstdenkmäler des Kantons Tessin* (1893); and similar treatises on other cantons. In 1879 he became editor of the *Anzeiger für schweizerische Altertumskunde*.

RAHU, rä'hoō (Skt. *Rahu*, the seizer, from *rabh*, Gk. *λαμβάνειν*, *lambainein*, to seize). In Indian mythology, the son of Vipracitti and Simhika, and the demon who is the cause of the eclipses of sun and moon. At the churning of the milk-ocean, Rahu, one of the Daityas or demons, came unnoticed among the gods and obtained a portion of the ambrosia thus produced. His head was cut off by Vishnu; but the nectar had reached his throat and consequently his head had already become immortal. Out of hatred for the sun and moon, who had informed on him, he now pursues them with implacable hatred, seizing them at intervals, and thus causing their eclipses. According to a later form of the legend both the head and the tail of the demon called Ketu ascended to heaven, and there still produce the eclipses of sun and moon either by swallowing them or by making them unclean by his approach. Rahu was accordingly reckoned among the planets which, on account of their wanderings, are regarded as of evil omen. In modern India he is the godling of two low-caste tribes, the Dusadhs and Dhangars, in the eastern districts of the Northwest Provinces, where he is propitiated by the rite of passing through a fire kindled in his honor. Rahu is a post-Vedic demon, his Vedic predecessor as the fiend who eclipses the sun being Svarbanu. In Hindu astronomy Rahu is the moon's ascending, and Ketu is its descending node.

RAHWAY, rä'wā. A city in Union County, New Jersey, 20 miles southwest of New York City; on the Rahway River, and on the Pennsylvania Railroad (Map: New Jersey, D 2.) An attractive suburban city, Rahway is well laid out, and has many handsome residences of business men of the greater cities in the vicinity. There is a public library with 15,000 volumes. As an industrial centre, Rahway is of considerable importance, its establishments including an extensive printing house and manufactories of steel castings, chemicals, felt goods, music boxes, carriages, electrical supplies, lace curtains, and shirts. Population, in 1890, 7105; in 1900, 7935.

RAIBOLINI, ri'bó-le'né, FRANCESCO. See FRANCIA.

RAIFFEISEN, ri'f'zen, FRIEDRICH WILHELM (1818-88). A German economist, founder of the German agrarian loan funds, born at Hamm an der Sieg. In 1835 he entered the army, but was compelled to abandon that profession because of

an affection of the eyes, and entered the civil service. The agricultural crisis of 1846-47, which Raiffeisen believed to be due to the difficulty with which the small landowner secured credit, led him to establish in Heddesdorf and Weyerbusch mutual credit associations, through which the small farmer might obtain loans at a low rate of interest, thereby escaping his former dependence upon usurers. Raiffeisen carried on an extensive propaganda for his idea, organizing numerous mutual credit associations, until in 1866 his health was so shattered by overwork that he was compelled to retire from public service. After he had partially recovered, he founded in 1878 the *Landwirtschaftliches Genossenschaftsblatt*, published at Neuwied. Before his death the agricultural loan associations had become numerous and had proved of the greatest value to the small farmers. Raiffeisen wrote: *Instruktion zur Geschäft und Buchführung der Darlehnskassenvereine* (1869); *Die Darlehnskassenvereine* (1887); *Kurze Anleitung zur Gründung von Darlehnskassenvereinen* (1888).

RAIKES, räks, ROBERT (1735-1811). The founder of Sunday schools. He was born at Gloucester, England, September 14, 1735; succeeded his father as printer and proprietor of the *Gloucester Journal* (1757) and so continued till 1802. He is first heard of in connection with volunteer jail visitation (1768), and called public attention to the pitiable condition of the prisoners. In July, 1780, he opened in Gloucester his first school on Sunday for the instruction of children. Consult his *Life* by Gregory (London, 1877); also Harris, *Robert Raikes, the Man and his Work* (Bristol, 1899). See SUNDAY SCHOOLS.

RAIL (OF. *raale*, *rasle*, Fr. *râle*, rail, rattling in the throat, from OF. *raller*, Fr. *râler*, to rattle in the throat, from MDutch *ratelen*, Ger. *rasseln*, to rattle; connected with Gk. *κραδαίνειν*, *kra-dainein*, to swing; so called from its cry). A bird of the subfamily Rallinae, especially of the genus *Rallus*, related to the coots and gallinules, and more remotely to the cranes. Rails have a slender bill, usually longer than the head, the body of a very compressed form, wings of moderate length, a short tail, long and strong legs, and long toes. The only European species is the common or water rail (*Rallus aquaticus*), which dwells in marshes and the reedy margins of lakes and rivers. It is generally a bird of passage, breeding in the north, and migrating southward on the approach of winter. The bird is about 11½ inches long. The sexes are similar in plumage, olive brown, marked with black above; bluish ash color beneath, with white transverse markings on the belly. The water rail feeds on worms, mollusks, and soft vegetable substances. It is in high esteem for the table.

In the United States six or seven species are known. The Virginia rail (*Rallus Virginianus*) is numerous in many parts of the Eastern States, but not often seen, because of its great shyness. It is rather smaller than the water rail of Europe, but much resembles it in appearance, haunts, and habits, which are those of the rails in general. (See Colored Plate of GAME BIRDS accompanying article GROUSE and also Colored Plate of EGGS OF GAME AND WATER BIRDS.) The king-rail, or fresh-water marsh-hen (*Rallus elegans*) is a much larger bird, inhabiting marshes throughout the Eastern United States, while the clapper-rail,

or salt-water marsh-hen (*Rallus crepitans*), is extremely abundant in the salt-water marshes of the Atlantic Coast. Each of these is about 15 inches long, and both are shot in great numbers for the table, while their eggs are also regarded as a delicacy. The mangrove-hen (*Rallus longirostris*) is a similar species of the West Indies; and a close ally (*Rallus obsoletus*) belongs to California. All these species are much alike in the compressed shape of the body, long bill, and large feet. The prevailing colors are olive, gray, fuscous, cinnamon-brown, black, and white; the sides and under parts are handsomely barred. The name 'rail' is often given to certain American coots, and is universally extended to those rail-like birds of the genus *Porzana* which inhabit drier lands, and in England are called crakes (q.v.). The most abundant and best known of these is the sora, or Carolina rail (*Porzana Carolina*), which is a favorite object of sport, with dogs, in the Southern States. Two other species, the yellow and the black rails, occur in Eastern North America. The latter is rare and remarkable for its diminutive size, dark color, and seclusive habits.

The rails form a highly generalized family, with a numerous fossil ancestry going back to the Eocene. They are distributed throughout the world, and many peculiar forms are or were inhabitants of the East Indian and South Sea islands. Many of these were restricted to one group or even to a single island, and had lost the use of their wings long before they became known to ornithologists; they were thus defenseless and several species have become extinct. Prominent examples are the genus *Notornis* of the New Zealand region, and the strange little wingless rail of Tristan d'Acunha. Consult: Evans, *Birds* (London, 1900); Newton, *Dictionary of Birds* (New York, 1896); and for the American species general works, especially Job, *Among the Water Fowl* (New York, 1902). See FLIGHTLESS BIRDS; EXTINCT ANIMALS; WEKA; and Plate of RAILS, ETC.

RAILROADS. See RAILWAYS.

RAILROAD TELEGRAPHERS, ORDER OF. See RAILWAY BROTHERHOODS.

RAILROAD WORM. A popular name in New England for the apple-maggot, the larva of a trypetid fly (*Trypeta pomonella*), given because it spread along the lines of the railroads. It is a native of the Northern United States and Canada, extending south along the Appalachian Mountains. The larva is a footless maggot, which lives in the pulp of the apple and tunnels it with winding channels, making here and there discolored excavations about the size of a pea. When ready to transform, the maggot leaves the apple, falls to the ground, and beneath the surface enters the pupal state, in which condition it remains until the middle of the following summer, when the perfect fly escapes. The fly is shining black with a rust-red head and legs, and whitish wings with dusky bands. The eggs are inserted into the flesh of the apple and frequently fruit is attacked which has previously been perforated by the codling moth. Thin-skinned summer and fall apples are preferred by it to the winter varieties.

RAILWAY BEETLE. A curious beetle of the family Malacodermidæ and probably of the

tribe Phengodini, the female of which is worm-like or larviform, and which is said to give out a strong red light from the two extremities and a green light from numerous points along the sides of the body, giving it the appearance of a miniature railway train. These beetles occur not infrequently in parts of South America, and the name originated apparently in Paraguay. In the United States very rare representatives of the genera Phengodes and Zarhipis have similar larviform luminous females. Compare LUMINOSITY OF ANIMALS.

RAILWAY BROTHERHOODS. Organizations of railway employees for the protection of their interests and the advancement of their condition in so far as dependent on themselves. The first five organizations described below are commonly referred to in the trade-union world as 'the great railroad brotherhoods'; and they are clearly distinguished from the other trades-unions of the country by unusual conservatism, a highly perfected form of government, and the great emphasis which they place upon the character of their members. While the railway brotherhoods are on an exceptionally friendly footing with the railway managers and have secured written contracts with most of the railroads fixing wages and other conditions of employment, they regard themselves as preëminently protective associations, and each maintains a large protective or strike fund. They also differ from the ordinary American union in the importance which they attach to the feature of mutual insurance. Affiliated with each of the brotherhoods is a Ladies' Auxiliary Society, who together maintain, with assistance from the brotherhoods themselves, a joint home for aged and disabled railroad employees at Highland, Illinois.

The railway brotherhoods are very similar in organization and government. The supreme powers are vested in a biennial national convention. The most striking feature which these brotherhoods have in common, however, is their system of legislative and adjustment boards. (1) The legislative board constitutes the lobby of the railway laborers. Whenever a majority of the divisions of any State or Province so desire, their representatives assemble at the State or Provincial capital and effect a general organization, usually selecting one or two delegates—the chairman and secretary-treasurer—as a permanent legislative committee. A plan has now been devised by which the chairmen of the legislative boards of the several organizations may combine in a Railroad Brotherhoods' Legislative Board, and such boards now exist in several States. (2) The boards of adjustment, also known as protective boards, are charged with the investigation of grievances and the collective bargaining concerning wages and other conditions of employment. In general, each division or local union elects a local grievance committee or board of adjustment; and the chairmen of the local boards on each system of railways constitute a general board of adjustment for that system. Where two or more separate systems are controlled by a single syndicate, the Locomotive Engineers provide for a still higher board or executive committee of adjustment, covering all the roads included in the syndicate. The adjustment system makes it extremely difficult to declare a strike.

RAILS, GALLINULES, AND JACANA

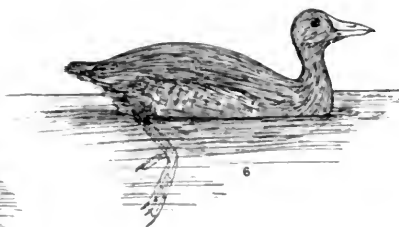
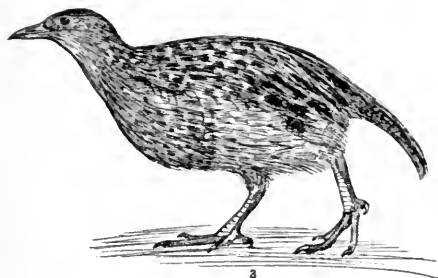
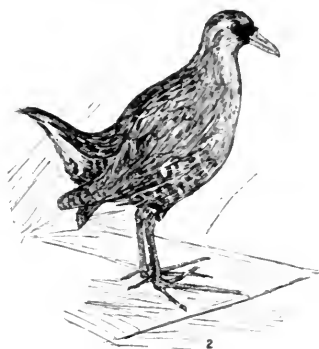
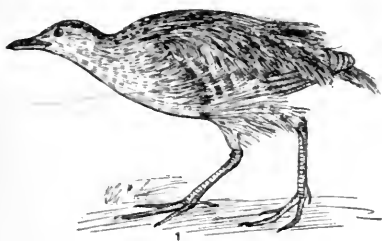

1. CORN CRAKE (*Crex crex*)
2. SORA or CAROLINA RAIL (*Porzana Carolina*).
3. WEKA or FLIGHTLESS RAIL (*Ocydromus australis*).

4. PURPLE GALLINULE (*Porzana Martinica*).
5. JACANA (*Jacana jacana*).
6. AMERICAN COOT (*Fulica Americana*).

The local grievance committee, the general board of adjustment, and the chief executive officer must all attempt to settle the grievance by peaceable negotiations with the railroad officials before a proposal to strike may be considered, and then, in most of the brotherhoods, it must be indorsed by the chief executive, the board of adjustment, and two-thirds of the members who will be involved.

With the exception of the Telegraphers and the International Association of Car Workers, the railroad organizations are not affiliated with the American Federation of Labor, and, notwithstanding the essential similarity of their interests, the frequent attempts to create a general federation of railway employees have signally failed. The United Order of Railway Employees was formed in 1889, but was dissolved in 1891. In 1893 the American Railway Union was organized with the object of bringing all railway employees under a single jurisdiction, but it received its death blow in the Chicago strike of 1894. In 1895 another alliance was formed, in accordance with what is known as the Cedar Rapids plan, between the five railway brotherhoods. This loose alliance was superseded in April, 1898, by a more centralized Federation of American Railway Employees, which in turn was dissolved February 1, 1900, leaving the Cedar Rapids agreement still in force. This agreement provides for united action among the five brotherhoods in settling grievances and conducting strikes.

(1) *The Grand International Brotherhood of Locomotive Engineers*, the oldest and most powerful of the railway unions, was organized August 17, 1863, as the Brotherhood of the Foot-board, and reorganized under the present name one year later. Between the biennial national conventions the supreme powers are centred largely in the grand chief engineer, who is elected by the convention for a term of four years, and receives a salary of \$5000 a year. The brotherhood lays unusual emphasis upon charity and mutual insurance. The local subdivisions in almost every case pay sick and out-of-work benefits; while the international division maintains a charity fund for the payment of pensions to the needy widows and children of deceased members, the expenditures for which average about \$42,000 a year. The insurance system of the brotherhood is conducted by an auxiliary company—*The Locomotive Engineers' Mutual Life and Accident Insurance Association*—which was incorporated under the laws of Ohio, March 3, 1894. From its first organization in 1867 to January, 1903, the insurance department paid out \$12,000,000 at an average cost of about \$16.55 a year per \$1000 of insurance. The mortuary fund at that time contained \$109,309 and the contingent or strike fund more than \$100,000. There were 596 subdivisions in the brotherhood with 42,000 members, of whom about 33,000 belonged to the insurance association. The official journal is the *Brotherhood of Locomotive Engineers' Journal*, published monthly at the headquarters in Cleveland, Ohio.

(2) *The Order of Railway Conductors of America* was organized July 6, 1868, as the Conductors' Brotherhood, adopted the present title in 1878, and in 1890 abandoned the non-protective policy which it had followed for a number of years and under which members were pledged not to participate in any strike. Between the bien-

nial conventions the principal powers are exercised by a salaried grand chief conductor and a board of three trustees. The mutual benefit department is separately conducted and is controlled largely by three insurance commissioners, from whose decisions an appeal lies to a board of directors. Policies of from \$1000 to \$3000 are issued at an average cost per year of about \$16 per \$1000 of insurance. The order is noted for its conservative methods and its elaborate machinery for conciliation and collective bargaining. It maintains, however, a protective fund of \$100,000, and striking members are paid \$50 a month for a period not exceeding three months. Reports covering the biennial period ending December 31, 1902, show 424 divisions, 27,899 members, 24,488 members of the insurance department, and the payment during this period of 604 insurance claims amounting to \$1,206,000. The official journal is *The Railway Conductor*, published monthly at the headquarters in Cedar Rapids, Iowa.

(3) *The Brotherhood of Locomotive Firemen* was organized December 1, 1873, and operated as a fraternal organization until 1877, when it adopted trade-union tactics, absorbed the existing lodges of the aggressive International Firemen's Union and Protective Association, became involved in the railroad strikes of 1877, lost its funds and a large part of its membership, and by 1878 seemed bankrupt and in a hopeless condition. In 1880, however, the strike policy was abandoned and the national officers were changed, with the result that since that year the brotherhood has grown from about 3000 members to 45,112 at the beginning of 1903. The government of the Brotherhood of Firemen does not differ materially from that of the engineers and conductors. Each member is assessed 50 cents quarterly for a protective fund, assessments ceasing when \$250,000 have been accumulated. Members on strike are paid \$25 a month for a period not to exceed three months. The brotherhood maintains a useful and successful employment bureau. The official organ is the *Locomotive Firemen's Magazine*, published monthly at Peoria, Illinois.

(4) *The Brotherhood of Railway Trainmen* was organized September 23, 1883, as the Brotherhood of Railroad Brakemen, and adopted its present name in 1890. It admits conductors, baggage-men, brakemen, flagmen, yard-masters, assistant yard-masters, yard conductors, foremen, and switchmen. In structure and government the brotherhood is about identical with that of the Locomotive Firemen. Active members are assessed \$1 a year for the protective fund until it reaches \$300,000. Members participating in an authorized strike receive \$35 a month during its continuance. Reports covering the biennial period ending December 31, 1902, show 646 subordinate lodges, 54,963 members, 52,591 members of the beneficiary department, and the payment during the two years of 1556 insurance claims amounting to \$1,670,790. The official organ is the *Railroad Trainmen's Journal*, published monthly at the headquarters in Cleveland, Ohio.

(5) *The Order of Railroad Telegraphers* was organized June 9, 1886, and admits telegraphers, linemen, levermen, in connection with the telegraph department and electro-pneumatic or mechanical interlockers. The telegraphers elect no legislative boards; the representation of the local

divisions in the biennial convention varies in accordance with their membership, and the power of the chief executive is somewhat more curtailed than in the other brotherhoods. The mutual benefit department, which was not established until 1898, is governed by an insurance committee as in the Order of Railway Conductors. The protective fund is fixed at \$50,000, for the establishment of which members are taxed \$1 a year. No fixed amount of strike pay is guaranteed. Up to 1902 the order was regarded as the weakest of the large brotherhoods, but from January, 1902, to April, 1903, over 18,000 new members were initiated, making the total membership about 30,000. The official journal is *The Railroad Telegrapher*, published monthly at the headquarters in Saint Louis, Mo.

Among the minor railroad labor organizations the three immediately following closely resemble the great brotherhoods in their conservative policy, emphasis upon mutual insurance, and general form of government.

(6) *The International Brotherhood of Maintenance of Way Employees* was organized as the Brotherhood of Railway Trackmen of America August 15, 1887, operated as a fraternal society until 1898, and adopted its present name in January, 1903. At the latter date the brotherhood comprehended 294 divisions with about 10,000 members. Its official journal is *The Advance Advocate*, published monthly at the headquarters in Saint Louis, Mo.

(7) *The Switchmen's Union of North America*, the successor of the once powerful Switchmen's Mutual Aid Association founded in 1881, was organized in 1897. Its growth and power have been seriously hampered by the Brotherhood of Railroad Trainmen, which also admits switchmen, but at present it seems thriving. In January, 1903, the membership was 14,000. The official journal is the *Journal of the Switchmen's Union*, published monthly at Buffalo, N. Y.

(8) *The Brotherhood of Railway Carmen of America* was organized in December, 1900, and includes all men engaged in building, inspecting, repairing, oiling, and cleaning railway cars in the United States, Canada, and Mexico. This organization has always been weak, and in the last few years has barely maintained an existence.

(9) *The National Railway Clerks' Association of North America* was organized in 1901, and in April, 1903, had 4000 members, organized into 35 local divisions. The *Official Journal of the N. R. C. A.* is issued monthly from the headquarters in Akron, Ohio.

The two organizations immediately following are affiliated with the American Federation of Labor and bear no peculiar resemblance to the other railway brotherhoods.

(10) *The Amalgamated Association of Street Railway Employees* was organized September 15, 1892, and admits any competent street railway employee of good moral character, except managers, superintendents, and foremen. No protective fund is maintained, but a benefit of \$75 is paid upon death or total disability. The official journal is the *Motorman and Conductor*, published monthly at Detroit, Mich.

(11) *The International Association of Car Workers* was organized May 22, 1901, from local lodges affiliated with the American Federation of Labor, and admits all men employed in the

construction and maintenance of passenger, freight, and electric cars. In May, 1903, there were 135 local lodges with a membership of 20,000. The official journal is *The Car Worker*, published monthly at Buffalo, N. Y.

(12) *The United Brotherhood of Railway Employees* was organized in January, 1901, and its membership, which is growing rapidly, is practically confined to Canada and the States west of the Mississippi River. The constitution of the brotherhood is exceedingly complex, and makes provision for local and general benefit departments and boards of adjustment similar to those in the older brotherhoods; but it is strongly opposed to the narrow trade or class organization of the older brotherhoods, and aims to unite in a single industrial organization all classes of railway employees, particularly the lower grades. The brotherhood is affiliated with the American Labor Union, the most prominent exponent in America of the alliance between organized labor and socialism.

RAILWAY CARMEN OF AMERICA, BROTHERHOOD OF. See RAILWAY BROTHERHOODS.

RAILWAY CLERKS' ASSOCIATION OF NORTH AMERICA, NATIONAL. See RAILWAY BROTHERHOODS.

RAILWAY CONDUCTORS OF AMERICA, BROTHERHOOD OF. See RAILWAY BROTHERHOODS.

RAILWAY EMPLOYEES, UNITED BROTHERHOOD OF. See RAILWAY BROTHERHOODS.

RAILWAYS, LAW AFFECTING. See CARRIER, COMMON; NEGLIGENCE; CORPORATION.

RAILWAYS, or RAILROADS. Roads upon which lines of rails are laid to facilitate the movement of vehicles for the carriage of freight and passengers. When employed without qualification the term railway or railroad is generally understood to indicate a road consisting of two parallel lines of rails or of multiples of such units upon which cars are hauled by locomotive steam engines. With the adoption of electric power in place of steam on considerable sections of railway line, steam locomotion has become a less distinctive characteristic of railways than was formerly the case, and the term when unqualified has a less definite meaning than formerly, yet ordinarily a steam railway is understood when the term railway is used by itself. Railways employing other form of motive power are similarly defined as electric railways, cable railways, compressed-air railways, etc., and railways serving especial purposes or distinguished by peculiar characteristics of construction are defined as elevated railways, logging railways, plantation railways, street railways, ship railways, rack railways, etc. A railway may consist of a single line of track with two lines of rails, when it is known as a single-track railway, or it may consist of two, three, or four lines of track, when it is known, respectively, as a double track, three-track, or four-track railway. In a few instances railways have been constructed with a track consisting of a single line of rail. Such roads are known as bicycle railways, mono-rail railways, or by other special names. More frequently railway lines are constructed with tracks consisting of three lines of rails. Rack railways have this form of track, as also do rail-

ways designated to carry both standard-gauge and narrow-gauge cars.

EARLY HISTORY. The development of the steam railway is ordinarily dated from the opening to traffic of the Stockton and Darlington Railway, in England, in 1825. The railway, however, had a history long before this date. Indeed, the Stockton and Darlington Railway, and its immediate successor, the Liverpool and Manchester Railway, were comparatively perfect developments of the art of railway transportation. To understand fully the growth of the steam railway it is, therefore, important to review its early history. This may be roughly divided into two phases, namely, the development of railway track and the evolution of railway motive power. To prevent confusion, each of these lines of growth will be considered separately so far as is practicable, but it will be understood that they progressed simultaneously.

Early in the sixteenth century rails of timber were laid at the collieries near Newcastle-on-Tyne, England, over which by means of bulky carts provided with rollers one horse could draw four or five tons of coal. The first notable improvement of this crude railway consisted in securing these wooden rails by pegs to cross-ties placed two or three feet apart, and in fastening on top of the rails proper, which were about six inches square, strips of hard wood which could be removed when worn and replaced with new strips without disturbing the remainder of the structure. In the year 1735 flat iron bars were substituted to some extent for this upper strip of wood, and in 1767 cast-iron bars were generally substituted for the entire wooden rail. At first these bars were flat and about 4 inches wide, 1¾ inches thick, and 4 or 5 feet long, with holes for the spikes, but after a few years they were made with a ridge along the outside edge to prevent the wheels from leaving the track. Subsequently, the flange was transferred to the inside edge of the rail. In 1789 William Jessup introduced a new form of cast-iron rail in which the depth was greater than the width, which led to the name of edge rail being given to it. These rails were cast with a head 1¾ inches wide carried by a thin web deeper at the middle of the rail than at the ends. At first these rails were bolted or pinned directly to the ties, but soon afterwards they were arranged to be supported by cast-iron pedestals or chairs spiked to the ties and having a slot at the top in which the web of the rail was set and secured by a wedge. The rails were made without flanges and instead flanges were placed on the wheels. Owing to the short lengths in which these rails had to be cast, the joints were numerous, a very important objection in railway track, and besides this the material was too brittle to carry safely heavy loads at high speed. The development of the iron industry partly remedied these faults about 1820 by furnishing malleable or wrought iron from which tough rails could be rolled up to lengths of 15 feet. At the end of the first quarter of the nineteenth century, therefore, the standard railway track is found to have consisted of wrought-iron edge rails about 15 feet long, fastened by keys into cast-iron chairs, which were in turn bolted down to stone blocks or wooden sills, spaced about three feet apart. The gauge of the track, that is the distance apart of the rails measured between the inner edge of their heads, was 4 feet 8½ inches, which ulti-

mately became the standard gauge of railway track in England and America. It will be observed that the essential characteristics of the modern steam railway track had been established by 1825, and that it only remained for future knowledge and experience to develop and perfect these features.

The great advance of the wrought-iron edge rail over previous forms of rails gave the first strong impetus to the development of a means of motive power for railways which would be superior to haulage by horses. The possibility of using steam locomotives at once suggested itself. Steam carriages for operation on common roads had been constructed long previous to 1825. (See **AUTOMOBILE**; **LOCOMOTIVE**.) As early as 1804 Richard Trevithick had built a locomotive engine, which at its first trial upon the Merthyr and Tydvil Railway, in Wales, had hauled wagons containing ten tons of coal at the rate of five miles per hour. In 1812 locomotives were used by Blenkinsop to haul coal between the Middleton collieries and Leeds, and also by Blackett at Wylam. None of these locomotives were satisfactory. In 1814 George Stephenson built his first engine and put it in operation on the Killingworth Railway, where it hauled a load of 35 tons at the rate of four miles per hour on a grade of 1 in 450. Stephenson continued to build locomotives, each of them an improvement over its predecessor, and had them working regularly on the Killingworth Railway, although they did not supersede the work of horses. The next step in advance in the use of the locomotive was made on the historic Stockton and Darlington Railway, the construction of which marked the advent of a new era in railway transportation. Before passing from the early history of railways to this new era it will be interesting to summarize briefly the status of railway transportation at the time. In 1825 the existing railways of Great Britain were 28 in number, ranging in length from 4 to 35 miles, and amounting in the aggregate to about 400 miles. These roads were used almost exclusively for the transportation of mineral products. With the few exceptions previously noted, the universal motive power employed was haulage by horses.

PERIOD OF DEVELOPMENT. The Stockton and Darlington Railway, 25 miles long, was opened for traffic in 1825, the line having been constructed under the direction of George Stephenson, as chief engineer. Considering Stephenson's previous work with steam locomotives on the Killingworth Railway, it was not surprising that he should attempt to use similar motive power on the new line. His success in the attempt was considerable. On the opening of the road the Stephenson engine hauled a train composed of 22 wagons filled with passengers and 12 wagons loaded with coal, making an aggregate weight of about 90 tons, at an average speed of five miles per hour and a maximum speed of 12 miles per hour. Notwithstanding the flattering showing made by the locomotive engine in this trial trip, that form of motive power was employed only to a small extent in the immediate future operation of the railway. It could not compete in economy with haulage by horses, and for some time all passengers and mixed freight were so hauled, the locomotive being used only to handle a portion of the coal traffic. The important rôle played by the Stockton and Darlington Railway,

therefore, consisted less in any advance in the mechanical features of railway transportation than in establishing the possibility of the railway as a common carrier of passengers and freight. Railway transportation in the modern meaning of the term began, thus, with the Stockton and Darlington Railway.

The success of the Stockton and Darlington Railway revived another railway enterprise which was destined to accomplish more in some respects for railway engineering than did the earlier road. This enterprise was the project for a railway line between Liverpool and Manchester, a distance of 30 miles. Construction was begun upon the road in 1826, with George Stephenson as chief engineer. Considerable difference of opinion existed as to the best method of operating the road when completed. Stationary engines had many advocates, including some of the most noted engineers of the day; others were in favor of horse power aided by stationary engines at the steep inclines, but few had any faith in locomotives, and Stephenson stood practically alone in openly advocating their use. His persistent earnestness, however, influenced the board of directors to offer a prize of £500 for the best locomotive engine which in a certain day should be produced on the railway and perform certain specified duties in the most satisfactory manner. The date of the test was October 1, 1829, and on this date four locomotives appeared to compete. One of these was the *Rocket*, built by Stephenson, and another was the *Novelty*, built by the Swedish engineer John Ericsson, afterwards famous as the designer of the iron-clad *Monitor*. The trials of these locomotives lasted until October 14th, when the prize was awarded to Stephenson's locomotive, the *Rocket*, which undoubtedly ranks as the first high-speed locomotive of the modern type. (See LOCOMOTIVE for description.) The success of the *Rocket* determined the motive power for the Liverpool and Manchester Railway, and incidentally for railways throughout the world. On September 15, 1830, the Liverpool and Manchester Railway was opened for traffic and on December 4th of the same year the locomotive *Planet* hauled the first load of freight, consisting of 18 wagon loads of cotton, 200 barrels of flour, 63 sacks of oatmeal, and 34 sacks of malt, from Liverpool to Manchester in two hours and thirty-nine minutes. As the model railway of its time the track construction of the Liverpool and Manchester Railway deserves some mention. Upon the graded surface was placed a layer of broken stone two feet deep. Stone blocks two feet square were set three feet apart and upon them and upon the wooden cross-ties used on embankments were fastened cast-iron chairs in which the rails were secured by wedges. The rails were of wrought iron 15 feet long and were rolled with the web deeper at the middle than at the ends. They weighed 35 pounds per lineal yard. The locomotive used has already been mentioned. The passenger cars resembled closely the familiar stage coach, while the freight cars consisted simply of a platform about 10 feet long, with sides from 4 inches to 10 inches high, mounted on four wheels.

In addition to establishing the practicability of the steam railway as a means of transportation for passengers and freight, the Liverpool and Manchester Railway proved the commercial value

of such thoroughfares so satisfactorily that projects for railway lines sprang up all over the world. In Great Britain in 1840, ten years after the opening of the Liverpool and Manchester Railway, there were 1331 miles of railway. These figures had increased to 6635 miles in 1850, to 10,410 miles in 1860, to 15,310 miles in 1870, to 17,935 miles in 1880, to 20,873 miles in 1890, and to 21,855 in 1890. Chronologically Austria-Hungary of the European countries ranks second to Great Britain in the construction of railways. The Austrian railway from Budweis to Lintz, 80 miles, was begun in 1825 and 40 miles were completed in 1828; it was operated by horse-power. In France the first railway, from Saint Etienne to Andrézieux, 13 miles, was also completed in 1828. The first steam railway in Germany, that between Nuremberg and Fürth, 4½ miles, was opened in 1835. To trace the development of the railway systems of these and other foreign countries in detail would exceed the limits of this article, and it must be sufficient to state the year in which the first important railway line was opened for traffic in each, as follows: Belgium, 1835; Germany, 1837; Russia, 1838; Netherlands, 1839; Italy, 1839; Switzerland, 1844; Denmark 1844; Canada, 1847; Spain, 1848; Mexico, 1850; Sweden, 1851; Peru, 1851; Chile, 1852; India, 1853; Norway, 1853; Brazil, 1854; Portugal, 1854; Australia, 1855; Egypt, 1856; Turkey, 1860; Paraguay, 1863; Argentine Republic, 1864; Venezuela, 1866; Uruguay, 1869; Greece, 1869; Colombia, 1880. The articles relating to these countries give further details concerning the history of railway development in them and the latest available statistics of mileage are presented in the accompanying Table I. It will be observed from these figures that nearly one-half the total railway mileage of the world is credited to the United States, and for that reason the history of the development of the railways of the United States has been allotted a paragraph by itself.

Common report has it that the first railway line in the United States was a short stretch of track laid by Silas Whitney on Beacon Street, in Boston, Mass., in 1807; the first line of which there is undisputable record was one three-quarters of a mile long constructed by Thomas Deiper at his stone quarry in Delaware County, Pa., in 1809. This was followed by several tram roads of similar character, the most important of which was one from Quincy to Newport, Mass., three miles long, and one at Mauch Chunk, Pa., nine miles long, both built in 1827. These roads had a track consisting of an iron strap on wooden rails, supported by stone blocks or wooden sills, and were operated by horses. The first attempt made in the United States to use locomotive engines, otherwise than for mere experiment, was made on the railway from Carbondale to Honesdale, Pa., 16 miles, built by the Delaware and Hudson Canal Company. Under instructions from this company its chief engineer, Horatio Allen, had ordered the building of these locomotives in England, and one of them, called the *Stourbridge Lion*, was placed upon the road in August, 1829, by Mr. Allen, who personally ran the engine during its first trip. In 1830 construction was begun on the South Carolina Railroad, with Mr. Allen as chief engineer, and upon his recommendation and by his advice the road was designed and built to be operated by steam loco-

motives. This was the first railway in America built with the purpose from the beginning of using steam locomotives, and the engine ordered

TABLE I.—SHOWING THE RAILWAY MILEAGE OF EACH COUNTRY OF THE WORLD IN 1898

COUNTRY	Length of Railroad, Miles
All of Germany.....	30,777
Austria-Hungary (including Bosnia, etc.).....	21,805
Great Britain and Ireland.....	21,529
France.....	25,898
Russia (including Finland).....	26,414
Italy.....	9,759
Belgium.....	3,781
Netherlands (including Luxemburg).....	1,965
Switzerland.....	2,303
Spain.....	8,103
Portugal.....	1,467
Denmark.....	1,618
Norway.....	1,230
Sweden.....	6,359
Servia.....	354
Rumania.....	1,895
Greece.....	501
European Turkey and Bulgaria.....	1,585
Malta, Jersey, Man.....	68
Total, Europe.....	167,510
United States.....	186,245
British North America.....	16,867
Newfoundland.....	592
Mexico.....	8,498
Central America (Guatemala, Honduras, Nicaragua, Costa Rica, and Salvador).....	701
Total, North America.....	212,903
United States of Colombia.....	346
Cuba.....	1,133
Venezuela.....	633
Santo Domingo.....	177
Brazil.....	8,718
Argentina.....	9,822
Paraguay.....	157
Uruguay.....	1,118
Chile.....	2,662
Peru.....	1,035
Bolivia.....	621
Ecuador.....	186
British Guiana.....	22
Jamaica, Barbadoes, Trinidad, Martinique, Porto Rico.....	563
Total, South America and West Indies.....	27,133
British India.....	21,973
Ceylon.....	297
Asia Minor and Syria.....	1,558
Russia (Transcasian Dist.).....	1,568
Siberia.....	2,573
Persia.....	34
Dutch East Indies.....	1,293
Japan.....	2,948
Portuguese India.....	51
Malay States (Borneo, Celebes, etc.).....	188
China.....	401
Siam.....	167
Cochin-China, Pondicherry, Malacca, and Tonquin.....	238
Total, Asia and Malay Archipelago.....	33,289
Egypt.....	2,085
Algeria and Tunis.....	2,704
Cape Colony.....	2,348
Natal.....	459
South African Republic (now Transvaal Colony).....	774
Orange Free State (now Orange River Colony).....	832
Mauritius, Réunion, Senegal, Angola, Mozambique, Congo.....	2,011
Total, Africa.....	11,214
Australasia.....	14,490
Recapitulation:	
Europe.....	167,510
North America.....	212,903
South America.....	27,133
Asia.....	33,289
Africa.....	11,214
Australasia.....	14,490
Total, 1898.....	466,539
Total, 1897.....	454,730
Total increase, 1897 to 1898.....	11,809

from the West Point Foundry and put in operation in 1830 was the first locomotive engine built and used for regular railway service in the United States. This engine was called the *Best Friend*. (See LOCOMOTIVE.) The second locomotive for the South Carolina Rail-

TABLE II.—SHOWING THE TERMINAL POINTS OF THE FIRST RAILWAY OR SECTION OF RAILWAY BUILT IN EACH STATE OF THE UNITED STATES (From Poor's Manual of Railroads, 1900)

STATES	Terminal of first section opened		Length, miles	Year opened
	From	To		
New England:				
Me.....	Bangor.....	Oldtown.....	11.00	1836
N. H.....	Nashua.....	Mass. State line.....	5.25	1838
Vt.....	White River.....	Bethel.....	25.00	1848
Mass.....	Boston.....	Lowell.....	26.76	1835
R. I.....	Providence.....	Stonington, Conn.....	50.00	1837
Conn.....	Hartford.....	New Haven.....	36.25	1839
Middle:				
N. Y.....	Albany.....	Schenectady.....	16.00	1831
N. J.....	Bordentown.....	Hightstown.....	14.00	1832
Pa.....	Port Carbon.....	Tuscarora.....	9.23	1830
Del.....	Newcastle.....	Frenchtown.....	16.19	1832
Md.....	Baltimore.....	Ellicott's Mills.....	15.00	1830
D. C.....	Washington.....	Md. state line.....	4.00	1835
Central Northern				
Ohio.....	Sandusky.....	Green Spring.....	22.50	1838
Mich.....	Toledo, Ohio.....	Adrian, Mich.....	33.00	1836
Ind.....	Madison.....	Vernon.....	22.00	1842
Ill.....	Jacksonville.....	Meredosia.....	24.00	1839
Wis.....	Milwaukee.....	Waukesha.....	21.50	1851
South Atlantic:				
Va.....	Richmond.....	Chesterfield Mines.....	12.00	1831
W. Va.....	Harpers Ferry.....	Winchester, Va.....	32.00	1836
N. C.....	Petersburg, Va.....	Blakely, N. C.....	63.00	1833
S. C.....	Charleston.....	West.....	7.00	1830
Ge.....	Savannah.....	West.....	9.00	1837
Fla.....	Saint Joseph.....	Lake Wales.....	8.00	1836
Gulf and Mississippi Valley:				
Ala.....	Tuscumbia.....	Decatur.....	45.50	1834
Miss.....	Vicksburg.....	Jackson.....	14.00	1841
Tenn.....	Nashville.....	Murfreesborough.....	30.00	1851
Ky.....	Lexington.....	Frankfort.....	29.00	1835
La.....	New Orleans.....	Lk. Pontchartrain.....	5.00	1831
South-western:				
Mo.....	Saint Louis.....	West.....	6.00	1852
Ark.....	Memphis.....	West.....	5.00	1857
Texas.....	Harrisburg.....	Richmond.....	32.00	1854
Kan.....	Kansas City.....	Lawrence.....	40.00	1864
Colo.....	Sheridan, Kan.....	Kit Carson.....	87.00	1870
New Mex.....	Colo. state line.....	South.....	8.30	1878
Ind. Ter.....	Seneca.....	Vinita.....	35.50	1870
Okla.....	Ark. City, Kan.....	Ponca.....	25.00	1886
North-western:				
Iowa.....	Davenport.....	Muscatine.....	39.00	1855
Minn.....	Saint Paul.....	Saint Anthony.....	10.00	1862
Neb.....	Omaha.....	West.....	40.00	1864
N. Dak.....	Fargo.....	Bismarck.....	136.50	1873
S. Dak.....	Big Sioux R.....	Yankton.....	60.00	1873
Wyo.....	Denver, Colo.....	Cheyenne.....	106.00	1870
Mont.....	Ogden, Utah.....	Blackfoot.....	160.00	1869
Pacific:				
Cal.....	Sacramento.....	Folsom.....	22.50	1856
Wash.....	Lower Cascade.....	Upper Cascade.....	6.00	1862
Oregon.....	Portland.....	Albany.....	80.00	1870
Nevada.....	Truckee, Cal.....	Reno.....	35.00	1868
Arizona.....	Yuma.....	Adonde.....	30.00	1879
Utah.....	Evanston, Wyo.....	Echo.....	36.00	1869
Idaho.....	Brigham, Utah.....	Franklin.....	61.00	1874

road was built and put in operation in 1831. The Baltimore and Ohio Railroad, commenced in 1828 and completed from Baltimore to Ellicott's Mills, Md., 15 miles, in 1830, came next in the

use of steam locomotives. Indeed, in 1830 a small engine was built by Peter Cooper and made experimental trips on this road, but the first locomotive to be put in actual operation was installed in 1831. In 1831 the *De Witt Clinton*, a locomotive built by the West Point Foundry, was put into service on the Hudson and Mohawk

TABLE III.—SHOWING THE NUMBER OF MILES OF RAILWAY CONSTRUCTED AND IN OPERATION BY DECADES, IN THE UNITED STATES, FROM 1830 TO 1900 INCLUSIVE

YEAR	Miles in Operation
1830.....	23
1840.....	2,818
1850.....	9,021
1860.....	30,626
1870.....	52,922
1880.....	93,262
1890.....	166,654
1900.....	194,321

Railroad. The next railway to mark a step in the development of the railway system of the United States was the Camden and Amboy Railroad, begun in 1831 and completed from Bordentown to South Amboy, N. J., 34 miles, in 1832. The president of this road, Col. Robert L. Stevens, conceived the idea that an all-iron rail would be preferable to the iron-strapped wooden rails

TABLE IV.—SHOWING MILEAGE OF VARIOUS CLASSES OF RAILWAY IN THE UNITED STATES ON JUNE 30, 1900

CLASS OF TRACK	Miles
Single track.....	192,556
Second track.....	12,151
Third track.....	1,094
Fourth track.....	829
Yard track and sidings.....	52,153
Total track.....	258,784

TABLE V.—SHOWING NUMBER OF EACH CLASS OF RAILWAY CARS IN OPERATION IN THE UNITED STATES ON JUNE 30, 1900

CLASS OF SERVICE	Number
Passenger.....	34,713
Freight.....	1,365,531
Company's.....	50,594
Total.....	1,450,838

employed on all previous American roads. There was no rolling mill in America capable of rolling such rails, however, and Mr. Stevens went to England to secure them. His request of the English ironmasters was for a rail having a head similar to that then in use upon the principal British roads, but with a wide flat base to the web, which he proposed to secure to the supporting blocks or sills by hook-headed spikes. Considerable difficulty was experienced in getting this request fulfilled, but in May, 1831, the first 500 rails, 15 feet long and weighing 36 pounds per yard, reached Philadelphia, and were placed in the track, thus recording the first use of the flanged T-rail, which has since become universal in America and is extensively employed abroad. It is important to note here that the flanged T-rail was reinvented in England in 1836 by Mr. Charles B. Vignoles, and that rails of this form are known abroad as Vignoles rails. Mr. Stevens also invented the fish plates and the hook-headed spike.

RAILWAY SURVEYS. The surveying operations requisite to and preceding the construction of a railway are in general a reconnaissance, a preliminary survey, and a locating survey or location. The reconnaissance is a general and somewhat hasty examination of the country through which the proposed road is to pass for the pur-

pose of noting its more prominent features and acquiring a general knowledge of its topography with reference to the selection of a suitable route. A preliminary survey consists of an instrumental examination of the country along the several available routes for the purpose of obtaining such details of distances, elevations, and topography as may be necessary to prepare a map and profile of each, make an approximate estimate of the cost of the road, and furnish the data from which definitely to locate the line. The locating survey consists specifically in establishing the centre line of the road on the ground in the position which it is finally to occupy. Defined more broadly, the location consists first in choosing the best route from the several which are available, and second in selecting for the chosen route the best combination of grades and curves. In determining the best combination of grades and curves for the route chosen the engineer has to take into account both the cost of construction and the cost of operation. On one hand he has the annual interest upon the original cost, and on the other the annual expense of operating the road. But the best combination of grades and curves is that which will render the sum of these two a minimum. To select the best line from several available lines, the engineer determines the most economical combinations of grades and curves for each one, calculates the interest on the entire cost of constructing the line with this combination and also the annual expense of operating the line, and takes the sum of the two amounts. That route is best in respect to which this sum is the least. In this last statement it is assumed that so far as their ability to command traffic is concerned all of the available routes are on a parity. This is not always the case. Sometimes one route is superior to any of the others in its ability to command traffic while being inferior in its ability to present the most economical combination of grades and curves. In such a case it often becomes the duty of the engineer to select the more expensive route for the sake of securing the greater amount of available traffic. It is plain upon very little thought that to answer each of these broad general questions a multitude of minor factors have to be carefully integrated, and that altogether the location of a railway is a task which, if it be well performed, calls for skill, experience, and good judgment on the part of the engineer. Beyond the statement of this fact it is impossible to proceed within the limits of the space available in this article, but the reader who wishes to study the problem of railway location in detail will find it presented at great length in Wellington, *Economic Theory of Railway Location* (New York, 1900).

When the engineer has chosen his route and has selected a combination of grades and curves for this route his next task is to establish its centre line on the ground with all the grades and curves properly indicated. In plan the centre line consists of a combination of straight lines or tangents and of curves. The curves may be simple curves, that is, plain circular curves; or compound, that is, consisting of two or more circular arcs of different radii; or reverse curves, that is, two simple curves so joined as to form a curve like a flat letter S. Curves are further designated by their degrees of curvature. The degree of a curve is determined by the angle at

the centre subtended by a chord 100 feet long. For example, if on any curve a chord 100 feet long subtends an angle of 5° at the centre, that curve is known as a five-degree curve. In profile the centre line is composed of a combination of level or horizontal lines and of inclined lines or grades ascending or descending from the horizontal. Grades are designated either by stating the number of feet of rise or fall in a horizontal length of line of 100 feet or of one mile. For example, a grade having a rise of one foot in a horizontal length of line of 100 feet is known as a 1 per cent. grade. The same grade defined in terms of feet rise per mile of length would be known as a grade of 52.8 feet per mile. When two grade lines meet or when a grade line and a level meet the junction is marked by an angle more or less abrupt. This angle is always replaced by a vertical curve which is convex upward at a summit and concave at a valley.

ROADBED CONSTRUCTION. The first task in the building of a railway is the construction of the roadbed or permanent way. In its broadest meaning the permanent way of a railway comprises all structure upon which track is laid, but the term is often given a more limited application which excludes culverts, trestles, viaducts, bridges, etc.; the broader application of the term will be chosen here. The actual work of construction of the roadbed of a railway begins with the clearing of the right of way. This right of way is a strip of land usually 100 feet wide, or 50 feet each side of the centre line of the road, and the clearing from it of all obstructions is obviously necessary before the work of actual construction can be begun. The amount of clearing required varies according to the natural conditions; on an open prairie section it is merely nominal, but in thickly wooded country, where trees have to be felled and their stumps pulled up, it forms quite an item in the expense of construction. As soon as the right of way is cleared, the work of excavation and embankment construction is begun. In locating the road the engineer has settled upon certain stretches and grades which are right lines and which define the top surface of the roadbed. The lines of these levels and grades in some places cut the natural surface of the ground and in other places they lie above the ground surface so that the roadbed has to be filled in. So far as he can do so without sacrificing more important things, the engineer endeavors to make the adjacent cuts and fills balance each other; that is, he tries to arrange the grades so that the material excavated from the cuts will be sufficient in quantity to construct the adjacent fills or embankments. When this desirable end cannot be accomplished the extra earth necessary for the embankments is secured by excavating pits called burrow pits at points convenient to the embankment to be built. Sometimes also it is preferable to take the material from burrow pits even where the amount of cuttings is more than enough to form the fills, since it is less expensive to do this than to haul the material excavated from the cuts to the points where it is required for embankment construction. A cut is simply a trench whose bottom is at the plane of the grade line and somewhat wider than the required roadbed, and whose sides slope upward and away from the track to the ground surface at greater or less angles, determined by the slope at which

the material will stand without sliding. The natural slope of different materials runs from a nearly vertical plane in firm rock to planes as flat as one foot rise in a horizontal distance of four feet, or technically defined, a slope of one on four. Slopes of 1 on $1\frac{1}{2}$ or 1 on 2 are perhaps the most common. Evidently the width of the cut at its top will depend upon its depth and the slope of the sides; it may easily reach 100 feet. When it exceeds this width it becomes necessary for the engineer to figure upon the desirability of sustaining the sides of the cut by retaining walls (see **RETAINING WALL**), or perhaps to consider the substitution of a tunnel for an open cut. Cuts are always made with a bottom width enough wider than the roadbed to allow a ditch to be built at each side to carry away the water from rain or melted snow which runs down or seeps through the side slopes.

The excavation of cuts is accomplished by any of the ordinary means of earth and rock excavation. For earth excavation the steam shovel (q.v.) is the tool most commonly employed. A fill may be described as the reverse of a cut; in fact, were it possible to take out a cut in a single solid piece and to deposit this piece on the ground bottom side up, it would serve as a fill. The manner of constructing a fill is to deposit the material from cuts and burrow pits along the line until an embankment is formed whose top is at grade and somewhat wider than the required roadbed and whose sides slope downward and outward at angles depending upon the natural shape of the material. Care is taken to make the embankments solid, since they must carry heavy trains, and to construct them so that the water falling on them will drain away as soon as possible. Usually there is not much attempt to use selected material, except for the upper section on top of which the track ballast will come. Fills, and, more particularly, deep fills, are often constructed by building a rough timber trestle onto which the material cars are run and their contents dumped until the trestle is entirely buried in an embankment of earth. Often also a trestle is at first built to carry the trains with the intention of filling it in afterwards. This hastens the construction and cheapens the first cost of the road, thus allowing the owners to begin operations and to earn money while the final embankment awaits some convenient time for its construction. The method of constructing embankments by filling in trestles is often resorted to in order to carry the roadbed across morasses of swampy ground.

It often happens that the problem of carrying an embankment across a morass is one of the most difficult which falls to the lot of the railway engineer. Where streams have to be crossed it is necessary to provide openings in the embankment for their passage. For small streams these openings are provided by means of culverts (see **CULVERT**) and in the case of large streams bridges are built. (See **BRIDGE**.) Bridges or viaducts are also employed to carry the road across gorges and deep valleys. Where the contrary condition exists and the engineer is called upon to carry his line over ridges or mountains where an open cut is not possible, because of its size and cost, and a direct climb is not practicable, because of the steep grades, he either resorts to the construction of a tunnel or of a switchback. The conditions which call for a

tunnel and the methods of constructing such works are discussed in the article on TUNNELS.

A *switchback* is a line which zigzags back and forth along the side of a mountain and thus gradually climbs to the summit level at which a direct crossing is possible. These structures are expensive to operate, because of their length and steep grades, and railway managers usually substitute tunnels for them as soon as the finances of the road and the amount of its traffic will warrant so costly an undertaking. Another method of overcoming steep mountain grades is to use a rack railway or a cable incline railway, and these special forms of road are described in succeeding paragraphs.

TRACK CONSTRUCTION. The width of the roadbed at the top is from 26 to 32 feet for double track and from 14 to 18 feet for single track on embankment. In cuts the width of roadbed exclusive of ditches is from 23 to 33 feet for double track and from 18 to 22 feet for single track. The surface of the roadbed at subgrade is almost invariably crowned at the middle so as to drain off water to the sides. On the top of this crowned surface is constructed the track. This consists of the ballast, the ties, the rails, and their accessories. Ballast is used for four principal purposes: (1) to distribute the load over the roadbed; (2) to form a support for the ties; (3) to provide efficient drainage under and

other woods. White oak is considered the best wood for railway ties, and ties of this wood have a life of about eight years. Ties are generally from 7 to 10 inches wide, 6 inches thick, and 8 to 9 feet long, and they are spaced from 18 inches to 2 feet apart in the track. An immense amount of timber is consumed annually for railway ties, as a brief estimate will demonstrate. Assuming that 2500 ties per mile of track are employed on the average, then the 250,000 miles of railway track in the United States require 625,000,000 ties. The annual consumption is about 76,000,000 ties for renewals and 14,000,000 ties for new construction, a total of 90,000,000 ties or nearly 300,000,000 cubic feet of timber. In view of these figures, it is not surprising that railway managers are finding greater difficulty each year in securing ties, and that they should be resorting to measures which will cut down the consumption.

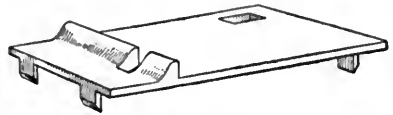

TIE PLATE.

One of these measures is to plant trees, but the one most commonly sought is to treat the ties used by some of the various methods for preventing or rather for delaying the natural decay. Another resort for prolonging the life of ties is to use *tie plates*, which are plates of iron inserted between the top of the tie and the bottom of the rail so as to distribute the load over a larger area and thus reduce the tendency of the rail to cut into the top of the tie. By many engineers

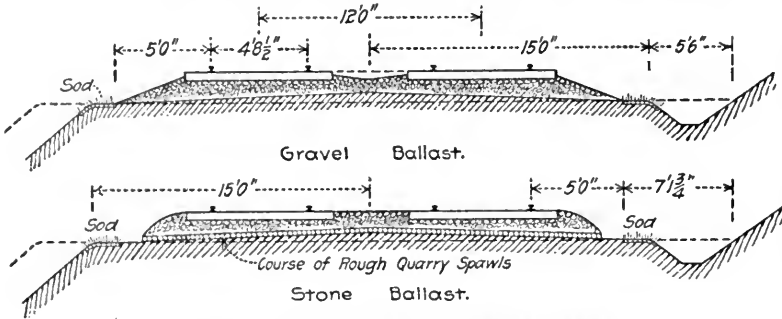

TYPICAL SECTIONS OF RAILWAY ROADBED AND TRACKS.

around the ties; and (4) to allow of surfacing and arranging the track without disturbing the roadbed. At this point it is a matter of some interest to note that the term ballast originated in England when gravel ballast was taken from ships for building tramroads. The materials most generally used for ballast are broken stone, furnace slag, burnt clay, gravel, sand, cinders, and earth, but other materials, as shells and chert, are often used locally. These materials rank in merit about in the order named, but the gravel is the material most used in America and after this comes broken stone. The ballast is usually level with the tops of the ties and about one foot thick, and it is usually shouldered out beyond their ends.

Ties, or *cross-ties*, as they are often termed, are the transverse wooden sections to which the rails are attached. As stated above, they are imbedded in the ballast. Wood is the almost universal material for ties in the United States, but in other countries metal ties are quite extensively employed. About 55 per cent. of all the ties in the United States are of oak and 22 per cent. are of pine. The remaining 33 per cent. is divided between cedar, chestnut, hemlock, cypress, and

it is thought that the ultimate solution of the problem will be the substitution of metal ties. An endless number of forms of metal ties have been tried, but only a few of them have proved successful, although these successful forms have given excellent results in many instances. In Europe, India, Africa, South America, and Mexico, metal ties are extensively used.

Rails are now universally made of steel and are of the flanged T-section invented by Col. R. L.

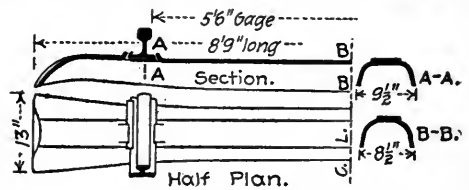

STEEL CROSS-TIE.

Stevens in 1830. This statement is wholly true of American practice and is generally true of foreign practice. Practically the only exception to the flanged T-section is the so-called bull-headed rail used in England. This rail has the

familiar flanged base of the American rail replaced by another head, the object of this design being to enable the rail to be reversed when one head has become worn. These bull-headed rails cannot of course be spiked to the ties, and they therefore require cast-iron chairs for their support. Formerly in America nearly every road used a form of rail peculiar to itself, which differed somewhat in minor dimensions and details from the rails employed by other

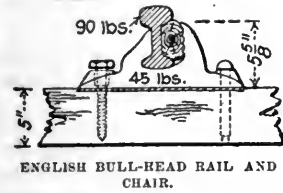

roads. Recently, however, practice has settled down to the use of a very few standard sections. In America the so-called Am. Soc. C. E. section recommended in 1893 by a special committee appointed by the American Society of Civil Engineers (q.v.) is the one which is most generally used; in Europe the section invented by Mr. Sandberg is chiefly employed. The ordinary length of rails is 30 feet, but rails 33 feet, 45 feet, and 60 feet long are used to some extent. The weight of rails per linear yard varies from 65 pounds, which is the least weight economical for ordinary service, to 100 pounds, which is the heaviest rail actually in use in the United States. Generally for ordinary traffic on roads with easy curves and moderate grades a 70-pound or 75-pound rail is used; for heavy and fast traffic and for sharp curves and steep grades the weights used run from 80 pounds to 85 pounds, 90 pounds, 95 pounds, and 100 pounds. An 80-pound rail of the Am. Soc. C. E. section is 7 3/8 inches high, with a head 2 1/2 inches wide and 1 1/2 inches deep, a web 35/64 inches thick and 5 inches

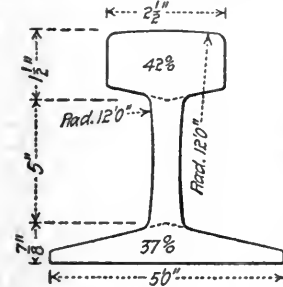

STANDARD AM. SOC. C. E. 80-LB. RAIL.

deep, and a base 5 inches wide. Of the total weight, 42 per cent. is in the head, 21 per cent. in the web, and 37 per cent. in the base.

Until 1855 all rails were made of wrought iron, but in that year steel rails were rolled in England, and were laid in track. Steel rails were rolled experimentally in the United States in 1865 and in 1867 they were being rolled to supply orders from the railways. The substitution of steel for iron for railway rails was one of the benefits wrought by the invention of the Bessemer process of steel-making. (See IRON AND STEEL.) The Bessemer process was introduced and developed in America largely through the efforts of A. L. Holley (q.v.). It has been claimed with substantial justness that no other invention did so much to encourage the development of the heavy-traffic, high-speed American railway as did this epoch-making discovery of Bessemer. In America and England rails are now generally spaced 4 feet 8 1/2 inches apart, this spacing being known as the standard gauge. Various other gauges are employed in other countries, the meter gauge, 39.37 inches, being common in

South American countries and Japan, a 5 foot 6 inch gauge being used in India, and a 5 foot 3 inch gauge being used in Ireland. A narrower gauge than the meter gauge has been employed on some railways. The Great Western Railway in England was originally constructed with a 7 foot gauge, and it was not until 1892 that it was converted to a standard-gauge road. A 6-foot gauge was introduced on the Erie Railway and retained long after the standard gauge had become general in the United States. As

time passes, however, the 4 foot 8 1/2 inch gauge is becoming more common all over the world. The method of fastening rails to the ties varies. In America hook-headed spikes are almost universally used; the bull-headed rail used in England is wedged into cast-iron chairs which are bolted to the ties; in Europe considerable use is made of bolts; and when steel ties are employed various forms of clamping devices tightened by means of bolts or wedges are used. To allow for expansion, rails are usually laid with a little space between the ends of succeeding rails. The space allowed varies on different roads and with the temperature at the time the rail is laid, but it is seldom more than three-eighths of an inch for the coldest weather and from this distance it gradually decreases to nothing at the maximum prevailing heat for the climate which the road has to endure.

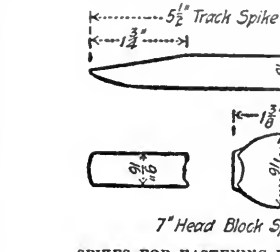

SPIKES FOR FASTENING RAIL TO CROSS-TIE.

The ends of succeeding rails are clamped together by various devices going under the general name of rail joints. The simplest form of rail joint is the fish plate, and the most common form is the angle bar. (See FISH PLATE.) The joint remains the weakest point of the rail despite all the efforts which have been made to remedy this

weakness. It may be noted in passing that these efforts are responsible for the numerous forms of patented rail joints which are on the market, several of which have met with substantial success. Rail joints are defined as *suspended* when the opening between the rail ends comes over the space between the adjacent ties, and as *supported* joints when this opening comes over the

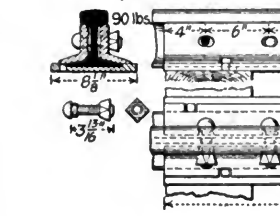

ANGLE-BAR RAIL JOINT.

weakness. It may be noted in passing that these efforts are responsible for the numerous forms of patented rail joints which are on the market, several of which have met with substantial success. Rail joints are defined as *suspended* when the opening between the rail ends comes over the space between the adjacent ties, and as *supported* joints when this opening comes over the

centre of a tie. Suspended joints are by far the most common in the United States. Rails are said to be laid with *square* joints when the joints of the two lines of rails are opposite each other, and they are said to be laid with *broken* joints

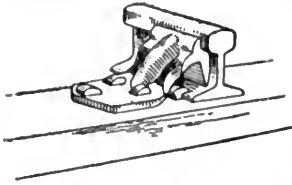

RAIL BRACE FOR HOLDING RAILS ON CURVES.

when the joints in one line of rails come opposite the centre portion of the rails in the other line. Broken joints are the more common in the United States. On curves the gauge of the rails is usually slightly increased, with the idea of preventing the flanges of the car wheels from

and on sharp curves braces of stamped or cast steel or iron are spiked to the tie and brace against the side of the rail. These braces are called rail braces. In many places rails develop a tendency to creep or travel along the track, due to the various forces acting upon them. The direction of this creeping may be either up or down grade, with or against the traffic, and to prevent it check plates or creeper plates are sometimes employed, which are bolted to the rail and spiked to the tie. Special forms of track construction are required at switches.

The switch is a device by which a train is directed from one track to another. An essential part of a switch is a frog. (See FROG.) On bridges and trestles the track construction also varies somewhat from that on embankments and in cuts. Sometimes the floors of bridges are made solid and carry ballast on which the ties and rails are supported in the usual manner, but more commonly the ties are laid on the

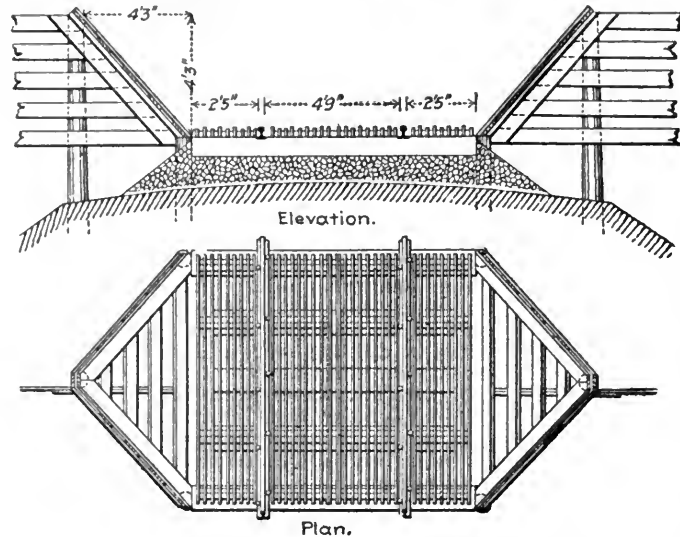

CATTLE GUARD WITH METAL SURFACE.

binding when rounding curves, and the outer rail of the curve is elevated above the level of the inner rail to counteract the tendency of the running cars through centrifugal force to continue in a straight line when passing a curve.

bridge stringers and carry the rails without any ballast. An essential part of railway track on bridges is a wooden or metal rail laid parallel to each of the track rails and a little distance away from them. The object of the guard rails is to restrain the free movement of derailed cars and prevent them from running off the bridge. In thickly settled districts the railway right of way is usually fenced in with fences of timber or wire, or, where a nice appearance is particularly desired, with hedges and walls of stone bearing ornamental iron railings. At grade crossings of highways and in a few other places at which cattle are liable to stray onto the track cattle guards are employed. These are of two kinds, known as *pit guards* and *surface guards*. A pit guard, as its name implies, is a wide deep pit underneath the rails which cattle will shun for obvious reasons. A surface guard is made up of sharp edged or toothed slats of wood or metal which depend for their efficiency upon the fact that in treading upon them the animal

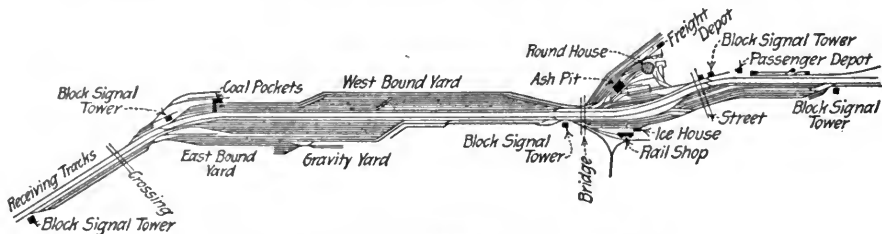

PLAN OF FREIGHT YARD ON ERIE R.R., PORT JERVIS, N. Y.

The amount of this elevation is greater the sharper the curve is. This same centrifugal force of the car tends to push the outer rails of curves in an outward direction or away from the inner rail, and to prevent this the outside rails on flat curves have a double set of outside spikes,

hurts its feet and withdraws from the attempted crossing.

Sidings and yards are special developments of the track system for special purposes. Sidings are provided to enable trains to pass on single-track roads and to relieve traffic on double track.

Yards are aggregations of tracks at terminals and other points which are provided for the storage and handling of cars which accumulate at those points. Various arrangements of yard tracks are employed, each arrangement being adopted to serve certain purposes and to meet certain conditions of traffic and of form and area of yard space. At the ends of stub tracks a bumping post (q.v.) is a necessary structure to prevent the cars from running off the end of the track. Another essential structure is a turntable for turning locomotives and sometimes cars. Track scales are an important item in railway-yard equipment. They resemble very closely the familiar platform scale used for weighing hay, coal, etc., in wagons, but are much larger and stronger so as to accommodate heavily loaded cars. To facilitate the handling of locomotives ash pits are provided into which the engines may dump their grates when necessary, and also water tanks, as are shown in the illustration. Station platforms are also usually classed as a part of the track construction.

So far reference has been made only to track construction, but track maintenance is quite as important an item. The work of maintaining the track of railways in good order costs in America all the way from \$500 to \$1500 per mile, and is from 8 to 20 per cent. of the total operating expenses. The number of employees engaged in track work by American railways averages about 150 per 100 miles of line.

BUILDINGS. Railway operations require the use of buildings in vast numbers. Of these passenger stations and freight depots are among the most important because of their number and cost. Passenger stations vary in size and character from small combination depots used at local stations of minor importance to large terminal stations of masonry and steel, and often of almost monumental magnificence. A combination depot is one in which both the freight and the passenger business is carried on under one roof. For the freight business a freight room is required, with platform space along a wagon road for transferring freight to and from wagons; and also the necessary facilities for handling freight to and from cars in freight trains or cars standing at the depot. The passenger business is served by the introduction of waiting rooms. Generally the structure is a one-story frame building sheathed with boards and roofed with shingles. Flag stations are stations of minor importance at which only a limited number of trains stop, usually upon being signaled by flag. The buildings at such stations range in importance from a single roofed platform to a combination depot.

Where the volume of traffic is sufficient the freight and passenger buildings are separated. Passenger stations in these cases may be divided into local stations and terminal stations. The distinction between the two is that in terminal side stations the tracks, or a number of them at least, terminate at the station, while in large first-class local passenger stations the tracks pass by the buildings. Local stations vary greatly in size, character, and cost, many of them in large towns and cities being elaborate stone and steel structures, but the largest of them seldom equal in size the largest terminal stations. Terminal passenger stations are those erected

for the accommodation of the passenger service at large passenger terminals of railways. Frequently several railways entering a town unite and use conjointly a so-called 'union depot.' It follows, therefore, that terminal passenger stations are located in large cities and towns, or at ferry terminals or at important junction points of several railways. These stations possess all the accommodations provided for large local stations, but in more capacious and luxurious forms

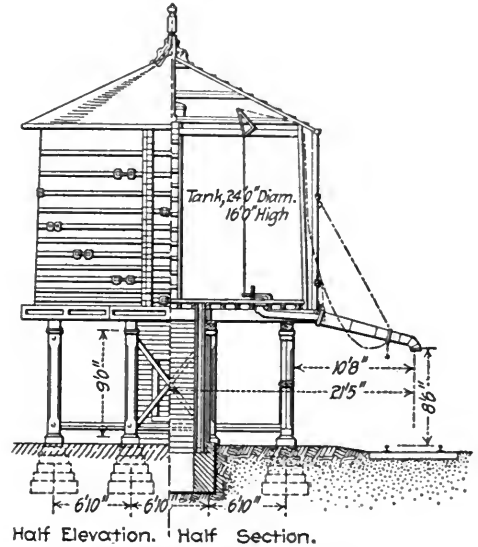

Half Elevation. Half Section.

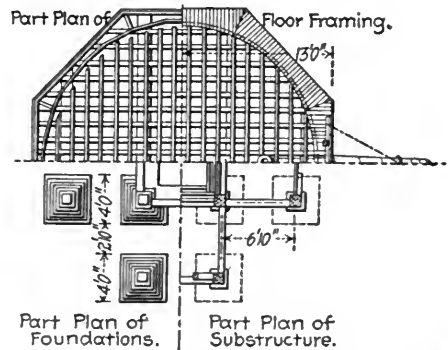

Part Plan of Foundations. Part Plan of Substructure.

RAILWAY WATER TANK FOR SUPPLYING LOCOMOTIVES.

and in addition many others, such as hotels, bars, cab, and carriage stands, parlors and reception rooms, rooms for gatemen, porters, police, watchmen, doctor's office, etc. Terminal stations are denominated side stations when the building is situated at one side of the tracks and head stations when the building extends across the dead ends of the tracks. Usually the tracks enter the station in pairs with a platform between each pair of tracks. These tracks and platforms are commonly roofed over in terminal stations. Train-shed roofs are sometimes made up of large steel arches spanning the tracks without intermediate supports, and sometimes they consist of two or more spans of steel roof trusses carried by side walls and intermediate columns.

Except at combination depots and flag stations special buildings are provided for handling the

freight traffic. Freight houses are of two kinds, commonly defined as terminal freight houses and local freight houses. The former are large separate buildings at important terminals, and the latter are usually small structures at intermediate stations along the line. Local freight houses are usually single-story frame structures having high platforms on one or all sides. If the tracks are only on one side of the building it is designated a side freight house, but if there are tracks on both sides it is designated as an island freight house. Terminal freight houses differ from local freight houses in their greater size, in their more substantial construction of brick and steel, and in their arrangement for handling incoming freight, outgoing freight, different classes of freight, etc., in separate departments, and in having the storage space separate from the spaces devoted to the handling of transient freight. Terminal stations located on the water front must also have provisions for transshipping freight to and from vessels. Railway shops are located at one or more places on a railway at which locomotives and cars are repaired and built, and where all the manufacturing work of the railway is done. Such shops resemble large manufacturing establishments elsewhere in their construction, arrangement, equipment with wood and metal working machines, etc., suitable for the work to be performed. Among the various other railway buildings are: Roundhouses for the shelter, cleaning, and minor repairing of locomotives between trips; car sheds and car-cleaning yards, for the shelter and cleaning of cars between trips; ice houses, for storing the ice used in passenger and dining cars and for refrigerator cars; sand houses, for drying, cleaning, and storing the sand supplied to locomotives; oil-storage houses, for storing the lubricating and lamp oil; coaling stations, for storing and delivering coal to locomotives; watchmen's shanties; section-houses; snow sheds and protection sheds for landslides; dwelling houses for employees, and sleeping quarters, reading rooms and club houses for employees. Some notion of the enormous expenditure in buildings required by railways is furnished by the statement of the Interstate Commerce Commission that for the year ending June 30, 1900, the cost of repairs and renewals of buildings on the railways of the United States was \$22,770,906, or about 2½ per cent. of the total operating expenses.

CARS. Railway cars of so many varieties are now in use that a description of the different kinds would be beyond the scope of this article. The list would include upward of 40 distinct patterns of cars, each of which is adapted to a special use. The early passenger cars differed but little from stage coaches, and the first step in the evolution of the modern car was made by joining several of these coach bodies into a single car. In the United States bogie trucks were next placed under each end of the cars, permitting them to be made of much greater length, after which the compartments were discarded for the present continuous car bodies, although in England and in most of the countries of Continental Europe the compartment system has been retained, each car being divided into three or four independent sections. Most of the improvements following these changes have been in the direc-

tion of additional safety devices and luxuries. The first attempt to furnish sleeping cars was on the Cumberland Valley Railroad in 1836. A compartment car of four sections was used, each section containing a lower, middle, and upper berth, but this, as well as a few other experiments in providing sleeping accommodations, was too crude to prove attractive. In 1864 the first Pullman sleeping car was introduced, and some time afterwards was put into service on the Chicago and Alton road. This car, called the *Pioneer*, was a foot wider and two and a half feet higher than any in use at that time, and before it could run over the line several bridges and all the station platforms had to be altered. Parlor cars and dining cars soon followed, and in 1886 the vestibuled cars completed the list of luxuries in railway travel. The car-building industry in this country is a vast one, as is well indicated by the fact that in 1900 a total of 124,106 cars were built, not including those built by the railway companies at their own shops. The total number of cars in service in the United States on June 30, 1900, was 1,450,838, of which 1,365,531 were freight cars.

A notable increase in the size and capacity of cars has signalized recent car construction. In 1875 the normal capacity of freight cars in the United States was from 20,000 pounds to 25,000 pounds. In 1885 this normal capacity had grown to 40,000 pounds and 50,000 pounds, and in that year cars of 60,000 pounds capacity had begun to be built. Few cars of less than 60,000 pounds capacity are now used for general freight service, and there is a decided tendency to increase the capacity to 70,000 pounds and 80,000 pounds. For special coal and ore traffic steel cars of 100,000 pounds and 110,000 pounds capacity are quite generally used. The steel car is a decidedly modern innovation and one which has been received in America with much favor. The principal advantages argued in favor of steel cars of 50 to 60 tons capacity are their great capacity in proportion to their weight and their superior strength and durability over modern cars. In addition to all-steel cars, cars with steel under frames and wooden superstructure are considerably used.

In Europe the passenger cars used are generally smaller and of lighter construction than those in America, but during recent years the tendency has been to employ cars of larger size than formerly, although such great dimensions as are common in America have not yet been attained. The smaller cars are from 26 to 34 feet long and are usually mounted on six wheels; the larger cars reach a length of nearly 60 feet and are mounted on trucks after the American fashion. The smaller American passenger cars are usually 50 feet long, while the large sleeping and dining cars frequently have a length of 80 feet or even 90 feet. European freight cars are veritable pygmies as compared with those used for the same service in America, they being from 12 feet to 18 feet long, mounted on four wheels and having a capacity of from 5½ to 9 tons.

SAFETY APPLIANCES. Safety appliances for railways have been of growing importance in proportion to the increase of the weight and speed of trains; at the same time, very few of these appliances are used solely with a view to safety, most of them having some

mechanical function to fulfill apart from the promotion of safety. Signals are one of the most important items of this class, and serve to keep the trains a certain distance apart, as well as to inform the engine runners of the condition of the tracks at switches, crossings, etc. The semaphore is the standard signal in both the United States and England. These are arranged to give three indications, according to the positions and colors of their blades in the daytime and the colors of their lanterns at night. The semaphore consists of a vertical post, to which a blade about two feet in length is pivoted near one of its ends, so as to hang either vertical at right angles to the post or midway between these positions. The short end of this blade behind the pivot carries a disk of colored glass, either red or green, which falls in front of a lantern when the blade is moved. For a clear track the blade hangs at an angle of about 30 degrees from the post and the lantern shows white. For danger a red blade stands horizontal, showing a red light, and for caution a green blade and a green light are shown. The signals and switches are worked from the same station by means of levers, which are provided with interlocking devices, so that only the proper signal corresponding to the position of the switch can be given. The interlocking system is a very ingenious arrangement, by means of which the movements of a number of levers are interdependent, so that it is mechanically impossible for the signalman to move them except in their prearranged order. In approaching a switch there are two signals, the farther one indicating caution, and the home signal danger, if the switch is not locked in position so that the line is clear. The switch lever is the only one which can be moved, and its movement releases the lever of the caution signal. Moving the latter locks the switch lever and releases the danger-signal lever, which, being thrown, locks the caution-signal lever and indicates that the way is clear. The levers can only be moved now in the reverse order, so that in throwing the switch the signals show danger first. In cases where the signals are too far from the signal tower to be seen and a break in the connection occurs, the signal falls by gravity to the danger position. This system of interlocking is capable of broad expansion, as one lever may be made to lock any one or more of the assembled levers in a signal tower.

In a refinement of the above system the manual labor of throwing the levers is replaced by the use of compressed air. The valves which control the various signals and switches are operated by electricity and controlled by small switches, which interlock in the same way as the levers described. A model of the track and signals is placed over the switchboard, and any changes made are reproduced on the model. As with the interlocking system, a signal could not be given which would lead to an accident; such could only occur by the failure to see or obey the signals. In case of fogs, a torpedo is frequently placed on the track, which makes a loud report when the wheels of a locomotive pass over it. In connection with the interlocking system, the detector-bar for switches is important, its function being to prevent the throwing of a switch while a train is passing over it. This is accomplished by means of a bar placed parallel to the rail, and which is moved by the same mechanism

which locks the switch. The movement of this bar raises it above the level of the rail, so the switch cannot be unlocked as long as there are any wheels on the rail which prevent the detector-bar from being raised. Another railway safety appliance is the system of signals which is used to maintain a minimum distance between the trains on the same track. The block system is used for this to some extent in the United States, and is almost general in England. See BLOCK SIGNAL SYSTEMS.

Brakes are the most essential safety devices for railway trains, and certain general principles are now recognized as necessary, which are to be found in almost all brake mechanism in use all over the world. They must be quick-acting, must be applied to every pair of wheels in a train, and must be applied simultaneously and controlled from a single point, generally at the locomotive. Air brakes, vacuum brakes, and several electrically controlled brakes fulfill these conditions, the Westinghouse automatic air brake, however, being the standard in this as well as most other countries. See AIR BRAKE.

In addition to the signaling and braking appliances mentioned, a number of minor devices of great value in promoting safety have been introduced. Automatic couplers are important

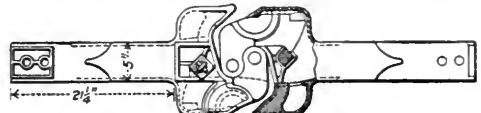

AUTOMATIC CAR COUPLER.

among these, and they are now demanded by law in the United States. A standard form has been adopted by the Master Car-Builders' Association, to which the various manufacturing companies comply, so that any of the different makes will work together. Their use is now general on all cars.

Grade crossings of highways at important points are gradually being abolished, as the percentage of people killed at these points is much greater than that of passenger fatalities. One device used at grade crossings is the well-known arm gate, operated by a flagman, or by compressed air, when several gates near together are used. Another method for crossings where the travel is infrequent is to provide an electric bell at the signal post, which is put in operation by the car wheels, and continues to ring for several minutes before the passing of a train. A considerable number of other appliances are in general use for promoting safety on railways, which would require too much space to describe.

RAILWAY MANAGEMENT. Railway management in the United States is primarily under the control of the directors of the railway companies, who are elected by the stockholders. A president is the chief executive officer of a railway, and the other officers are generally one or more vice-presidents, a treasurer and secretary, and a general manager. The treasurer has charge of all moneys collected and disbursed, and is responsible directly to the president, who is assisted in certain duties by the vice-president. The duties of the general manager extend to every department of the service, all of which are under his control. A superintendent is at the head of each department, who is responsible for every detail

of the work in every division and subdivision of his department, and each sub-department is in turn under the control of a single head, and so on down to the end of the scale. In this way the lines of responsibility of each employee, from the car-cleaner up to the president, are clearly defined. The heads of the principal departments directly in charge of the general manager are the superintendent of roadway, the superintendent of machinery, and the superintendent of transportation. The controller, the traffic manager, and the car accountant are also classed in the same rank. The subdivisions of these departments are too numerous to trace in detail. The superintendent of roadway is responsible for the maintenance of all the construction work of the railway, including the track, trestles, bridges, buildings, etc., each of which departments is assigned to supervisors, whose work covers a certain allotted territory. Each supervisor divides his territory into sections which are in charge of a resident section master, who employs a section gang. Track walkers from these gangs patrol their entire section several times a day and report any needed repairs, which are attended to by the section men. The superintendent of machinery attends to the provision and maintenance of all the rolling stock. The locomotives are in charge of a master mechanic, who keeps a record of the performance of each of them, and the cars are under the care of a master car-builder, who attends to the manufacture, repairing, and inspection of all the company's cars. The superintendent of transportation is in charge of the movements of all the trains on the road and all employees connected with the train service, including telegraphic operators, train dispatchers, conductors, etc. In addition to arranging the regular time schedule, he provides for the extra trains ordered by the traffic manager. A graphical representation of the regular trains is used, from which the relative positions of the trains on the road at any time during the day can be seen at once if the runs are made on time. From this diagram the opportunities for sending out extra trains are determined, and any chances of collisions become apparent and can be guarded against.

The traffic manager's department is divided into two principal branches—the passenger traffic and the freight traffic—each in charge of a general agent. In this department the rates and tolls are made, and the advertising, soliciting of business, etc., carried on. The duties of the car accountant are keeping a record of all cars on the road, which is made up from the conductors' reports, and notifying the owners of the number and movements of other companies' cars on his road. This is made necessary from the custom of sending through freight cars over different roads without unloading, and in this way they are often scattered widely over the country. There are two other departments, less intimately connected with the management of the roads than those mentioned above. These are the purchasing and the legal departments. The controller's department, where the accounts and statistics are kept, completes the general outline of the organization of a railway.

RAILWAY TRAFFIC. Passenger service on steam railways was inaugurated on October 10, 1825, on the Stockton and Darlington road with a passenger car called the *Experiment*, which car-

ried inside and outside about 25 passengers. The distance run was 12 miles, and the fare was one shilling, each passenger being allowed 14 pounds of baggage. In America by the end of the year 1831 there were several railways in operation or in course of construction, but for fifteen or twenty years the railway travel was extremely uncomfortable, although it was a vast improvement over the stage coaches previously used. The car ceilings were low and without ventilation, the stoves at either end of the cars had no effect on the temperature at the middle seats, and in the absence of spark arresters the cars were filled with cinders. Tallow candles were used at this period, which contributed more to the odor than to the illumination of the cars, and the roughness of the track and jolting of the train made conversation almost impossible. The flat rails used at first were the cause of numerous accidents. Their ends were cut at an angle to form lap joints, and the pointed ends were occasionally caught by the wheels and driven up through the car floor, impaling the passengers sitting directly over them. Through tickets were unknown, and at the end of each short, independent railway, into which the long routes were at first divided, the passenger was obliged to purchase a new ticket, change cars, and transfer his own baggage. These conditions prevailed generally on American railways, as well as on all others, for a number of years, and it was not until 1860 and after that the most important railway improvements were adopted. Automatic brakes and automatic couplers, as well as spring buffers, were the most noticeable of the early improvements introduced. These devices overcame the jerking and jarring of the cars both when in motion and when starting and stopping. The bell-cord passing through the cars and communicating with the engineer, or with the air-brake mechanism, is a safety device peculiar to this country, and is still generally omitted in Europe for fear that false signals may be given.

The use of sleeping cars and parlor cars introduced an element of comfort in railway travel which was of great importance in this country, on account of the distances traversed. The buffet car was afterwards provided to avoid delays at meal stations. This was merely a modified sleeping car with a kitchen at one end and portable tables, which could be fixed in each section. Dining cars, introduced shortly afterwards, led to the development of vested trains, as, in order to reach the dining car, the rule forbidding passengers to cross the platforms when the cars were in motion was then broken at the invitation of the railway companies. Vestibuled express trains are now in general use, on which sleepers, parlor cars, a dining car, a smoking saloon, library, bath-room, barber shop, and writing-room are provided. The checking of baggage is regarded in this country as one of the most indispensable features of railway travel, as by this system through checks over any number of connecting railways may be issued, so that baggage is transferred from the passenger's residence to any specified address in the country without devolving any responsibility upon the owner. This system operates so perfectly that the loss of baggage is almost unknown, and its detention is of rare occurrence. The usual allowance of 100 pounds of baggage per passenger is merely nominal on most roads, as charges are

rarely made except where the excess is several times the specified weight. In connection with through checks, coupon tickets are issued for trips covering several different roads, which are sold by either of the companies whose lines are traversed. This requires an agreement between the different roads for the mutual accounting for the tickets sold. The average rate per mile for railroad fares in the United States is approximately the same as in Europe, and to make a comparison the different classes of travel must be considered. In Europe the rates of fare are graded into three classes—first, second, and third. The first-class travel is very small, and the fares are comparatively high; by far the largest proportion of travel is on the third class. In the United States the first class comprises most of the railroad travel, the second and third classed together amounting to only 1 per cent. of the whole.

The speed of passenger trains is being steadily increased, and recent years have shown some remarkable records of train speeds both in America and abroad. A more important development than these occasional record runs, however, has been the increase in the average speed of trains. Many railways to-day maintain a schedule speed of 50 miles per hour in their express train service, and in some instances regular trains average 60 miles per hour. Where an average speed of 60 miles an hour is demanded by the time-table, the speed during a part of the run often reaches 75 and even 85 miles per hour. Much higher speeds than this have been exceptionally attained for short distances. As the result of these developments the schedule time between important cities has been greatly reduced. In the United States between four and five thousand passengers are killed and injured each year by railway accidents. These figures seem large until the enormous number of passengers carried safely to one injured is calculated. According to the report of the Interstate Commerce Commission, 2,316,648 passengers were carried safely in 1900 to one passenger killed, and 139,740 passengers were carried safely to one injured. In England in 1900 the proportion was one passenger killed in 8,461,309, and one injured in 470,848. On the Continent of Europe in many cases an even better record is maintained.

The railways of Europe are largely under Government control, growing out of the policy of subsidizing them, or in some cases of building the lines outright, or of guaranteeing a monopoly of traffic by the State. In France most of the railways are either owned entirely or to a very large extent by the Government, and are held by the companies operating them on leases. In this way almost all the railways in the country will ultimately revert to the possession of the Government. Railway service in England is in some respects different from that of any other country, and its evolution from stage-coach travel is still suggested by its nomenclature. The cars are called carriages, the engineers drivers, and the conductors guards. The absence of grade crossings and sharp curves and the substantial character of the construction work make the English roadbeds superior to most others. Safety in travel is greatly promoted by these conditions, but in other respects the passenger service is, from an American standpoint, much inferior to

that in this country, although vast improvements have taken place both in England and on the Continent within recent years.

Freight service constitutes the greater part of the business of most railways, and is the most important source of their income. Of the entire revenue of the railways, about 70 per cent. is derived from freight traffic, 25 per cent. from passenger service, and 5 per cent. from mail and other minor services. The movement of freight by the early railways was very slow and much more expensive than it is now, largely owing to the transfers made between the cars of different companies, each of which used its own rolling stock exclusively. With the increase of freight traffic the custom has grown to allow freight cars to run from the point of shipment over any number of railways to their destination without transfer, and the greater part of the freight business in the United States is now done in this way. The cars of each company become considerably scattered over the lines of other companies, and every road does more or less business with other companies' cars, for which a mileage is paid to the owners of the cars. The through freight service of the country is very much improved by avoiding transfers, but at the same time keeping account of the whereabouts of its cars and reducing its mileage balance by as little use as possible of foreign cars are often troublesome problems for a railway. The car accountant's department keeps records of the movement of cars, which are made up from the reports of the train conductors and from agents placed at each railway junction. These records are quite complete, and are of additional use in checking the reports of foreign roads and adjusting the mileage charges. Cars are supposed to be promptly returned to their home roads with loads in that direction only, but it happens frequently that when short of cars freight agents will use any car at hand, without regard to its home direction. From this practice it sometimes results that a car will not reach home for months or even over a year from the time it left its own road. At the receiving station freight is loaded into the cars, as far as possible allowing to certain cars goods marked to the same destination. The number and destination of each car is given to the dispatcher, who makes up the trains from these memoranda. The conductor takes the memoranda of each car, called running slips, and these slips are transferred from road to road with the car until it reaches its destination. At each railway junction a record of the cars in every train is made. For through freight several fast freight lines have been organized under a separate management to operate between certain points over several roads. Some of these are simply formed by the cooperation of several roads, each of which assigns a certain number of cars to the line, which is placed in control of a general manager. Other fast freight lines are independent of the railways, which simply charge mileage for the cars carried over their lines.

A number of special classes of freight require special cars for their transportation, and these are sometimes owned by the shippers or by fast freight lines, as well as by the railway companies. Live-stock cars for cattle, refrigerator cars for dressed meat and other provisions, heater cars for fruit, etc., are in extensive use,

as well as many other special cars adapted to the needs of perishable freight. An hourly record is kept of the movements of the latter cars from the time they leave the consignor until they are delivered to the consignee. For every freight car moved a way bill is issued, which gives the number and owner of the car, a description of its contents, with the weight and address of every package, the names of the consignors and consignees, the starting-point and destination, charges, and every detail in regard to routes and the proportions of charges due the different carriers. Duplicates of these way bills go to the auditor's department, and from these the whole record of the freight business is made, and they are afterwards put on file for reference in case of claims. The average freight charges in this country are the cheapest in the world, yet the question of rates is the most troublesome one with which railway companies have to contend. The relative rates between different roads and different points rather than the actual charges for freight involve problems which railroad pools, traffic associations, and legislators have not been as yet entirely successful in solving. The subject is too broad to be discussed here, but two of the most important troubles in fixing rates lie in the discriminations in favor of large shippers and the reduction of through rates below those of intermediate points. Both of these practices, while apparently unfair to the public, are to some extent reasonable, as the same discrimination between large and small consumers is seen in the wholesale and retail prices in all businesses, and on some through lines, especially those in competition with water routes, the traffic must either be secured by special reduced rates between such points or be lost to the railways. Competition between railways is apparently less desirable than it is in the case of other kinds of trade, as the localities where it exists are alone benefited, and the business at other places is threatened. Railways serving a certain territory find it necessary to cooperate in fixing joint rates, and the concessions in charges which are mutually agreed upon between competing lines practically effect the same division of the traffic between them which was secured by the railway pools.

In making the rates, all articles of commerce are divided into several classes, and a certain standard rate per hundred pounds of each class is fixed between two important points, as New York and Chicago. Every other city reached by the same line is figured at its agreed proportion of the standard rates. For example: From New York to Pittsburg would be figured at 60 per cent. of the standard rate between New York and Chicago, and any change in the standard would affect all other places proportionately.

Mail service is a very important department of most railways from a public standpoint, although one which yields a comparatively small revenue to the railways in proportion to the service demanded. The present system of railway mail service was not suggested until 1862, and was not put into effect on a comprehensive scale until two years later, under the superintendence of Col. G. B. Armstrong. It was not, however, until about 1875 that special fast mail trains on which mail was sorted and distributed along the routes were put in operation. Special cars are provided for this service, which are fit-

ted up with tables, pouches, and racks, and a 'mail catcher,' which picks up mail pouches from posts at stations where the train does not stop.

In 1900-1901 there were 9182 clerks employed in railway mail service in the United States, working in crews on 783,358 miles of railway. This number includes the clerks employed on steamboat lines (33,970 miles in length) and electric and cable cars. Considerable of the mail carried by the railways is charged at freight rates, according to its weight, and the largest proportional earnings from this source are made by the railway companies which carry too little mail to warrant running high speed trains without extra remuneration. Considering the requirements of the mail service, which are met by the railway companies, the advantage of this traffic as a source of profit to them is doubtful. The time in transit for mail from New York to San Francisco, Cal., a distance of 3250 miles, is indicated by the Official Postal Guide as 106 hours; from New York to Chicago, 900 miles, 23 hours; New York to Buffalo, 410 miles, 9½ hours, and New York to Albany, 142 miles, 3½ hours.

RAILWAY CAPITALIZATION. Much of the financial difficulty under which a good many American railways have labored has been the direct outgrowth of speculation, in which the properties have frequently been practically wrecked merely to effect deals in the stock market, and roads which have been the subject of these operations are generally overcapitalized or mortgaged to such an extent that the earnings which would be sufficient to provide reasonable dividends on the actual value of the property are frequently too small to pay the interest on its bonds. The amount of railway stock which has been issued without consideration of money or value is unquestionably very large, although no approximation to the real sum is possible of being estimated. Occasionally such stock is issued pro rata to the stockholders of a very profitable road to make the rate of dividends less prominent, which might otherwise invite restrictive legislation. More frequently the object of issuing watered stock is to keep the control of the railway by means of the apparent investment it represents, or to balance some difference in cases of reorganization. The bonds represent very closely the amount of the debt actually paid in. The stockholders, as owners of the road, have the entire control of the property, and the bondholders have no voice in the management so long as their interest is paid. This condition, corresponding to that of the owners and mortgagees of real estate, is entirely reasonable as long as the actual investments in stock and bonds maintain normal proportions, for the reason that the stockholders assume all the risk, while the bondholders are practically secured. In some cases, however, the amount of money supplied by the stockholders is merely nominal, and the road is bonded for all or more than its value. This can only occur where the stock is most all 'water,' and its result is to put the management of the road in hands of parties having but little financial or other interest in it except for the opportunity it affords for speculating with the money of the bondholders. The abuses which have grown out of railway transactions under such circumstances constitute shameful chapters

in the history of a number of roads, such as the Erie, Wabash, Union Pacific, and others.

What are known as the Erie wars in 1868 illustrated the worst evils of this class. Two or three operators bought within a few weeks options on a large amount of Erie stock for the sum of \$72,000, and obtained possession of sufficient proxies to elect one of their own representatives as president of the road. After thus obtaining control of the property, the railway was charged at once with the \$72,000 spent in acquiring it, and the speculators then commenced selling the stock for a fall. This was eagerly purchased by the Erie's rivals, the owners of the New York Central road, and, instead of a fall, the price of Erie stock rose from 68 to about 80. As this threatened to ruin the Erie operators, they issued \$5,000,000 worth of fraudulent stock, which was sold at 80, and on its discovery the speculators for a fall realized an enormous profit in addition to the \$4,000,000 proceeds from the sale of fraudulent stock. In the legal proceedings which followed large sums of money were spent in buying up elections, legislatures, and judges, all of which were charged to the Erie road, and at the end of two or three years, when the ring lost its control, the indebtedness of the Erie had been increased by about \$65,000,000, which prevented its stock from paying a dividend for twenty years.

A certain amount of hostile feeling has always existed between the public and the railways, which fortunately is diminishing with the better understanding of the questions in dispute. Practically the whole difference hinged on the matter of rates, and both sides have been at fault in treating this subject. The railways have at times made very unjust discriminations between different persons and different localities, and, on the other hand, the public in attempting to correct these abuses have passed laws which have been equally unjust to the railways. The problem of rates is an exceedingly difficult one to legislate upon, as no fixed rule can be justly applied in every case as to the proportional charges for different distances. A large proportion of the transportation of this country falls within the jurisdiction of the Interstate Commerce Law, which in respect to rates leaves considerable discretionary power in the hands of the Commission. See INTERSTATE COMMERCE ACT.

ELEVATED RAILWAYS. Elevated railways is the name given to railways which run along a line of streets on girders supported on iron pillars erected on the street surface. The first elevated railway was a short line built in New York City in 1867, but the successful operation of such lines did not take place until 1872, when the New York Elevated Railroad Company began running trains on a line from Battery Park along Greenwich Street and Ninth Avenue to Thirtieth Street. From this time on the growth of the elevated railway system of New York was rapid, and succeeding years saw lines built in Brooklyn, Chicago, and Boston. Liverpool, Berlin, and Paris are among the foreign cities which possess elevated railway lines. The modern construction of elevated railways in America consists of steel pillars or columns erected along each curb line about 60 feet apart. The tops of these columns are connected across the street by plate girders (see BRIDGES), and these girders carry others generally one

under each track rail, reaching from one pair of columns to the next longitudinally of the street. The railway track is laid on these longitudinal girders, and consists of cross-ties with rails spiked to them in the usual manner. The stations are carried on elevated platforms level with the railway, and access and egress is had by means of stairways and elevators. On the Barmen-Elberfeld Railway, operated by electricity, the cars are suspended from the elevated structure. The principal elevated railway in Berlin is a viaduct of masonry, presenting fine architectural features.

MOUNTAIN RAILWAYS. The term mountain railway is applied to lines whose grades are too steep to be operated by locomotives, depending upon adhesion only for their drawing power, and which, therefore, necessitate the use of some special system of securing greater traction power. Several such systems are employed. The two principal ones are the Fell system, with a central, elevated, double-headed rail laid sideways, which is gripped by horizontal wheels on each side, which greatly augment the adhesion, and the system with central racks in which vertical cog-wheels work, whereby the adhesion of the ordinary driving wheels is greatly assisted in drawing a train up the incline, and the descent of the train is kept under control. This latter system embraces the Riggenbach, Abt, and other systems. In tourist lines ascending the steep sides of mountains for the sake of the views, a cog-wheel working in a central track is generally used as the sole means of propulsion up the inclines. Lastly, where the ascent is steep, straight, and fairly short, a cable is employed for hauling up the vehicles, resembling in principle the inclines worked by ropes in mines, a system which has also occasionally been adopted for the steep inclines on ordinary railways.

The central-rail system was first adopted for crossing the Mont Cenis Pass by a railway laid mainly along the road between Saint-Michel and Susa, a distance of 48 miles, having a gauge of 3 feet $7\frac{3}{8}$ inches and surmounting a difference of level of 5300 feet between Susa and the summit, with a total variation in level between its termini of about 9900 feet. The ruling gradient was 1 in 12, the average gradient about 1 in 17, and the central rail, raised $7\frac{1}{2}$ inches above the ordinary rail-level, was laid along all gradients exceeding 1 in 25; while the minimum radius

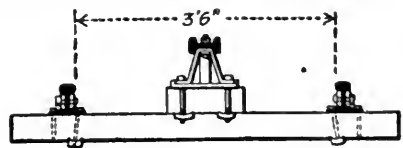

CENTRAL-RAIL SYSTEM FOR MOUNTAIN RAILWAYS.

for the curves was 2 chains. The greatest train load carried over the Mont Cenis Fell Railway was 36 tons, and the heaviest locomotives employed on it weighed 26 tons. In this system the grip of the horizontal wheel on the central rail not merely secures sufficient adhesion to mount steep inclines, but also serves as a very effective brake in the descent, and keeps the locomotive firmly on the line in going around sharp curves.

The Rimutaka incline, on the Wellington and Featherstone Railway in New Zealand, with a

gradient of 1 in 15 for $2\frac{1}{2}$ miles, and a total rise of 869 feet, opened about 1879, having a gauge, like the rest of the railway, of 3 feet 6 inches, and curves of 5 chains radius, was laid with a central rail, and the traffic on the incline has been worked continuously by a locomotive with horizontal wheels gripping the central rail. Each engine, weighing about 36 tons, can draw a maximum train load of 70 tons up the incline; and in order to avoid an undue strain on the draw-bars, the three engines employed for taking up a heavy train are so distributed between the carriages as to enable each to draw its own load. The system has proved safe and satisfactory, and well adapted for running around sharp curves; while the saving in cost of construction by adopting the incline on this particular railway, instead of a more circuitous course, to obtain flatter gradients, readily surmounted by ordinary locomotives, was estimated at £100,000.

A solid central rack was introduced for the first time in 1847 on an incline of the Madison and Indianapolis Railway near Madison, Ind. It was $1\frac{1}{3}$ miles long, with gradients of 1 in $16\frac{1}{2}$ to 1 in 17. The rack railway, however, which was the precursor of the numerous Swiss mountain railways for tourists, was the line, three miles in length, constructed up to the top of Mount Washington in New Hampshire in 1866-69, rising altogether to a height of 3600 feet, with ruling gradient of 1 in 3. The rack in this case was formed in lengths of 10 feet, with two parallel angle-irons, 4 inches apart, connected by a series of round wrought-iron bars constituting the teeth of the rack, which resembles a ladder laid on the ground. The locomotives, provided with a central cog-wheel working in the ladder-rack, push the vehicles up the mountain at a rate of about three miles an hour. The first rack railway carried out in Europe up a mountain slope was the Vitznau-Rigi Railway, constructed from Vitznau, on the Lake of Lucerne, to the summit of the Rigi in 1869-73, rising 4472 feet in its course of $4\frac{1}{3}$ miles, with a ruling gradient of 1 in 4 for about a third of its length, and never less than 1 in 6, except at the stations. The locomotive on these mountain lines is always placed below the carriages, so as to push them up the inclines and control their descent, the speed of the trains on the Rigi line being limited to between three and four miles an hour.

The driving cog-wheel and the other cog-wheels fitted to the locomotive and carriages are furnished with powerful brakes, which, when applied, keep the cogs firmly engaged in the rack, so as to arrest the descent of the train; and an air brake acting on the piston of the locomotive serves to regulate the downward speed. Strong hooks attached under the locomotive and carriages encircle the top flange of each side-piece of the rack, and thus secure the train from leaving the rails or being blown over by the wind.

A steel rack rail with teeth on each side, in which horizontal cog-wheels work, was adopted for surmounting the exceptionally steep inclines of the Pilatus Railway, averaging 1 in 2.8, and attaining 1 in 2.08 in some places, preliminary trials having proved that the ladder-rack was unsuitable for such gradients. This railway opened in 1889, starts from Alpnach on the Lake of Lucerne, and rises 5363 feet in its length of

$2\frac{3}{4}$ miles. The driving cog-wheels are actuated by spur gearing, and the two pairs of cog-wheels are controlled by hand brakes, which suffice to regulate the descent of the train or to stop it if necessary. An air brake acting on the pistons of the locomotive furnishes additional control of the train on its descending journey; and if at any time the speed in descending becomes more than three miles an hour, a reserve automatic brake comes into action.

Another form of rack consists in cutting the edge of a flat steel bar, so as to provide a uniform row of teeth on its upper side, and the strength of the rack can be increased for steeper gradients by increasing the thickness or the number of the bars. The rack is thus formed by a series of solid bars, with teeth shaped to the most convenient form for the working of the cog-wheel in them. This simple form of rack, consisting of successive lengths of single bars joined at their ends and laid in the centre of the track, has been employed on the flatter gradients of several rack railways, where the Abt system of two or more such bars, laid so that their teeth are not in line across the track, is resorted to on the steeper parts of the lines.

The Sant' Ellero-Saltino Railway, the first purely rack railway built in Italy, was constructed in 1892. This railway rises 2765 feet in a length of five miles, and it is laid to meter gauge, with a ruling gradient of 1 to 4.55. The rack on gradients not exceeding 1 in $8\frac{1}{2}$, consists of two steel angle bars riveted together, 4 to 6 feet long, with teeth formed in them; but for steeper gradients up to the maximum of 1 in 4.55, two flat steel bars are introduced between the angle bars, increasing the thickness of the teeth and the rigidity of the rack, which latter can be still further augmented by introducing a distance piece between the angle bars, so as to form two or three parallel racks with a small interval between them, in which the cog-wheel works with a widened bearing. This Telfener rack is simpler in construction and cheaper than the Riggenbach and Abt racks; but it does not possess the special advantage of the Abt rack, of thoroughly engaging two or three successive teeth of the cog-wheel at the same time. The speed of the trains ranges from $5\frac{1}{2}$ to $4\frac{1}{2}$ miles an hour, according to the gradients, and averages 5 miles an hour.

A more complicated form of single rack, resembling a flat-bottomed rail in its low portion, and widened out considerably for the teeth at

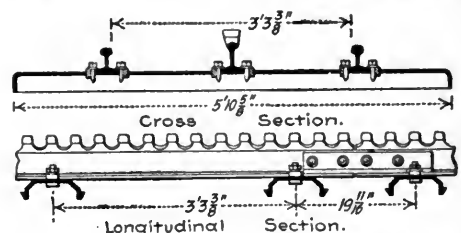

TRACK CONSTRUCTION OF STRUB RACK RAILWAY.

the top, called the Strub system, after its designer, has been recently introduced on the Jungfrau Railway, which is laid to the meter gauge, and was opened in 1899, the motive power being electricity generated by waterfalls on the mountain. This line rises 6657 feet in a length

of 7.3-5 miles, with gradients ranging from 1 in 14½ up to 1 in 5; and the upper 6.1-5 miles are to be in tunnel, while the final ascent to the summit is to be effected by a vertical lift of 241 feet. The central rack rails, 11½ feet long, are joined together at their ends by fish-plates, like ordinary flat-bottomed rails. A brake is provided, which encircles and grips the widened-out head of the rack.

The Abt system consists essentially of two or three steel rack bars, from 11-16 inch to 1 13-16 inches thick, and 2 to 4½ inches deep, placed nearly two inches apart, and so arranged that the teeth are not opposite each other, but as it were break joints, causing the cog-wheels to engage in a tooth in front on one rack before leaving the tooth behind on the adjacent rack, which renders the motion smoother, and increases the security of the trains in descending, besides proportioning the strength of the rack to the steepness of the gradient by the addition of one or two bars. The Generoso railway in Italy and the Rothorn railway in Switzerland, 5.2-3 miles and 4.4-5 miles long, rising 4326 feet and 5515 feet, with ruling gradients of 1 in 4.55 and 1 in 5, and constructed in 1889-90 and 1891, respectively, are laid to a gauge of 2 feet 7½ inches with cast-steel sleepers, and provided with a double Abt rack, in which cog-wheels on the driving axles work. The system has also been extended to mountain lines in several other countries, as, for instance, the Manitou and Pike's Peak Railway in Colorado, of standard gauge, rising 7552 feet in a length of 8¾ miles, with a maximum gradient of 1 in 4.

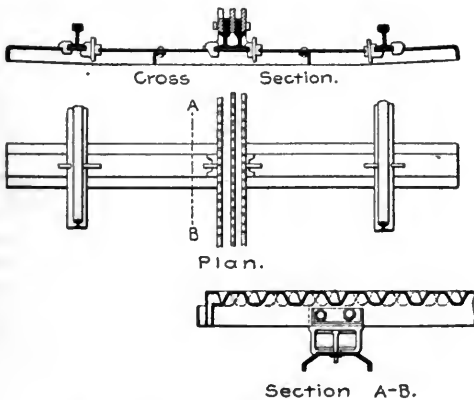

TRACK CONSTRUCTION OF ABT RACK RAILWAY.

Instances of the application of electricity as the motive power on mountain railways laid with the Abt rack, where water-power is readily available for generating the electrical current, are furnished by the Mont Salève Railway near Geneva, and the Gornergrat Railway ascending from Zermatt. These railways, constructed in 1891 and 1896-98, respectively, have lengths of 5.3-5 miles and 5.4-5 miles, with rises of 2363 feet and 4600 feet, and are laid to the meter gauge, with gradients of 1 in 4 and 1 in 5, and a double line of rack. In all these rack railways, special care is always taken to anchor the track firmly down into the solid ground, so as to prevent its creeping gradually downhill under the pressure of the cog-wheels on the rack.

ELECTRIC RAILWAYS and STREET RAILWAYS will be found treated under their own heads.

BIBLIOGRAPHY. Consult Poor's *Manual of Railroads* (New York, annual); *Annual Reports of the Interstate Commerce Commission* (Washington, D. C.); Hadley, *Railway Transportation; Its History and Its Laws* (New York, 1885). See LOCOMOTIVE; BLOCK SIGNAL SYSTEM; BRIDGE; AIR BRAKE; TUNNEL; etc.

RAILWAY TRAINMEN, BROTHERHOOD OF. See RAILWAY BROTHERHOODS.

RAIMONDI, RAIMONDI, ANTONIO (1826-90). An Italian geographer and naturalist, born in Milan. In 1850 he went to Peru, and was professor of botany in the University of Lima from 1862 to 1871. During this time he explored the country and gathered material for his proposed exhaustive work on the geography, botany, zoology, and ethnology of Peru. Three volumes on geography were published (1874-76-80) and called *El Perú*, but a part of the work was destroyed when Lima was captured in the Chilean War, and Raimondi died before completing it. His manuscripts became the property of the Lima Geographical Society.

RAIMONDI, MARCANTONIO (?-c.1534). The chief Italian line engraver of the Renaissance. The year of his birth is unknown, but he was a native of Bologna, where he studied engraving under Francia, devoting himself at first to niello. At the beginning of the fifteenth century we find him executing line engravings after the paintings of Francia, but also after his own designs. Even in these early prints the influence of the German engravers, like Schongauer, is evident, particularly in the landscape backgrounds. Greatly impressed by Dürer's engravings, he copied about eighty of his woodcuts and copper plates in line engraving, even counterfeiting Dürer's signature. He thus pirated without acknowledgment the entire *Life of the Virgin* and the *Little Passion*. The generally accepted account, derived from Vasari, of how Dürer obtained redress from the Venetian Government is improbable, since the first series was not published until after Dürer's visit to Venice in 1506.

Until 1510 Raimondi resided at Bologna, with occasional visits to Venice, but in that year he seems to have been at Florence, since it was the date of his celebrated engraving, "Les grimpeurs," after Michelangelo's cartoon, the "Battle of Anghiari," the background of which was taken from Lucas van Leyden. He was then probably on the road to Rome, where he henceforth devoted himself to the reproduction of the works of Raphael. The latter even sketched designs for him, and himself added the finishing touches to the plates. Marcantonio carried out these designs with great vigor and charm, rendering, as no other has done, the forms of Raphael, not only in line, but in spirit. Among the best of his works executed after Raphael were: the "Murder of the Innocents;" "Quos Ego" (Neptune riding on a shell); "Lucretia;" the "Judgment of Paris;" "Adam and Eve;" etc. After Raphael's death he engraved after Giulio Romano, notably a "Bacchus and Ariadne;" and after the antique, which he was largely instrumental in popularizing. His engraving of Giulio's illustrations of Ariano's *Sonnetti lussuriosi* caused his imprisonment by Clement VII., and he was ruined by the sack of Rome in 1527, when he was held

for ransom by the Spaniards at an exorbitant sum. He returned to Bologna, where he died not later than 1534. The chief pupils of his school at Rome were Agostino Veneziano and Marco Dente di Ravenna. Consult Delaborde, *Marc-Antoine Raimondi* (Paris, 1887).

RAIMUND, rí'munt, FERDINAND (1790-1836). An Austrian actor and playwright, born in Vienna. After playing on provincial stages in Hungary, he secured an engagement in Vienna at the Josephstädter Theatre in 1813, and in 1817 at the Leopoldstädter Theatre, where he soon became the most popular exponent of local comedy, and which he managed as director in 1828-30. In the meanwhile he had come before the public as a popular dramatist with *Der Barometermacher auf der Zauberinsel* (1823); *Der Diamant des Geisterkönigs* (1824); *Der Bauer als Millionär* (1826); *Alpenkönig und Menschenfeind* (1828); and others which, after severing his connection with the Leopoldstädter Theatre, he mounted on the stages of Munich, Hamburg, and Berlin, appearing himself in them in a starring capacity. His last and best play was *Der Verschrender* (1833), which is still popular on the German stage. In a fit of hypochondria Raimund attempted his life with a pistol and died within a week on his little estate of Gutenstein. He was a genuine poet in the popular vein, who dwelt with affectionate sympathy upon the life of the people, and weaved its joys and sorrows into the fabric of fantastic dramas of peculiar charm. Their pathos and humor are alike telling. His life was made the subject of a novel by Otto Ilorn (Bäuerle) and of several dramatic productions. By the Raimund Dramatic Club, founded in Vienna in 1890, the Raimund Theatre was established there in 1893.

RAIMUND, Golo. The pseudonym of the German novelist Bertha Frederick (q.v.).

RAIN (AS. *regn*, *rēn*, Goth. *riḡn*, OHG. *regan*, Ger. *Regen*, rain; connected with Lat. *rigare*, Gk. *βρέχειν*, *brechein*, to wet). Drops of water formed in the atmosphere by the condensation of its aqueous vapor and falling rapidly by virtue of their weight: the very small drops that fall slowly are spoken of as mist, cloud, or fog. The largest drops of rain that have been measured are as much as 0.25 to 0.30 inch in diameter and fall at the rate of from 15 to 25 feet per second. The smallest drops that are likely to be spoken of as rain are about one-twentieth of an inch in diameter and fall at the rate of about five feet per second. As rain water is condensed vapor that had previously been evaporated from distant water surfaces, therefore, in accordance with the laws of evaporation, it would be chemically pure water were it not for a small percentage of foreign substance which it gathers to itself from the atmosphere. Rain water washes down out of the air dust, soot, pollen, spores of fungi, and many other solid substances. Ordinary rain water contains an appreciable percentage of dissolved oxygen, nitrogen, ammonia, and carbonic acid gas, and in special cases it is found to contain nitric acid, sulphuric acid, and other components of the impure air of cities. The acid and alkaline impurities generally increase the power of the rain water to dissolve the mineral constituents of the earth's crust; the gases make it possible for plants and animals to live in rivers and ponds, which would be impossible if the water were

chemically pure. Rain water only becomes wholesome potable water for man's use after it has been thoroughly filtered through the earth, whence it issues as springs of pure water.

Up to the middle of the nineteenth century rain was supposed to be naturally formed by the mixture of cold and warm masses of moist air, but the publication of Espy's *Philosophy of Storms* (Boston, 1842), and his life-long contention that cloud and rain are not due to cooling by mixture or by radiation, but are a consequence of the cooling of the atmosphere by virtue of the work done in expansion, supported as he was by Professor Joseph Henry, Sir William Thomson (Lord Kelvin), and other physicists, finally led meteorologists to study the great thermodynamic problems of the atmosphere. When air is forcibly compressed, the work done by compression is represented by the increase in temperature of the confined air; *vice versa* when the air expands by diminution of pressure, the work done in expansion is represented by the heat abstracted from the expanding air, which therefore experiences a corresponding cooling. The laws of convective equilibrium governing the temperature and the volume of a unit mass of rising air were first expressed in the exact language of mathematical physics by Sir William Thomson in 1861. Graphic methods of treating the complex meteorological problems were devised by Hertz in 1884, and improved by Von Bezold in 1888 and Neuhoff in 1900. The analytical treatment of the subject is given by F. H. Bigelow with convenient tables in his report of 1900 *On the International Observations of Clouds*. When warm moist air ascends from near the earth's surface it cools by expansion; if no heat is added or subtracted, it is said to cool adiabatically, and does so at the rate of about one degree Centigrade per 99 meters of ascent, or one degree Fahrenheit for 185 feet, until it reaches an altitude at which its temperature is the same as the temperature of the dew point of the original air. At and above this elevation cloud is formed as the air ascends. If the rise continues until the air has cooled to the temperature of freezing point of water, then the watery cloud particles begin to change to ice, giving out a little of their latent heat as they do so. When in the course of its further ascent all the cloud particles have become ice, then any additional rise will be accompanied by the formation of snow crystals. This latter condition would continue to exist throughout the further ascent of the air were it not that in these higher regions the formation of snow is very slight. If the sun is shining upon the clouds, the process ceases to be adiabatic, and the particles of water or ice may be immediately evaporated back into vapor. Owing to the resistance of the air, the cloud particles fall very slowly to the ground, or may, in fact, be upheld indefinitely by a gentle ascending current. But if numerous small particles combine together into drops of water, the latter may fall rapidly to the ground as rain. The above paragraph correctly explains the formation of cloud by cooling due to expansion, but nothing is as yet known satisfactorily as to the process by which large raindrops are formed from the minute cloud particles.

Among the several plausible hypotheses are the following: (a) That the cloud particles are

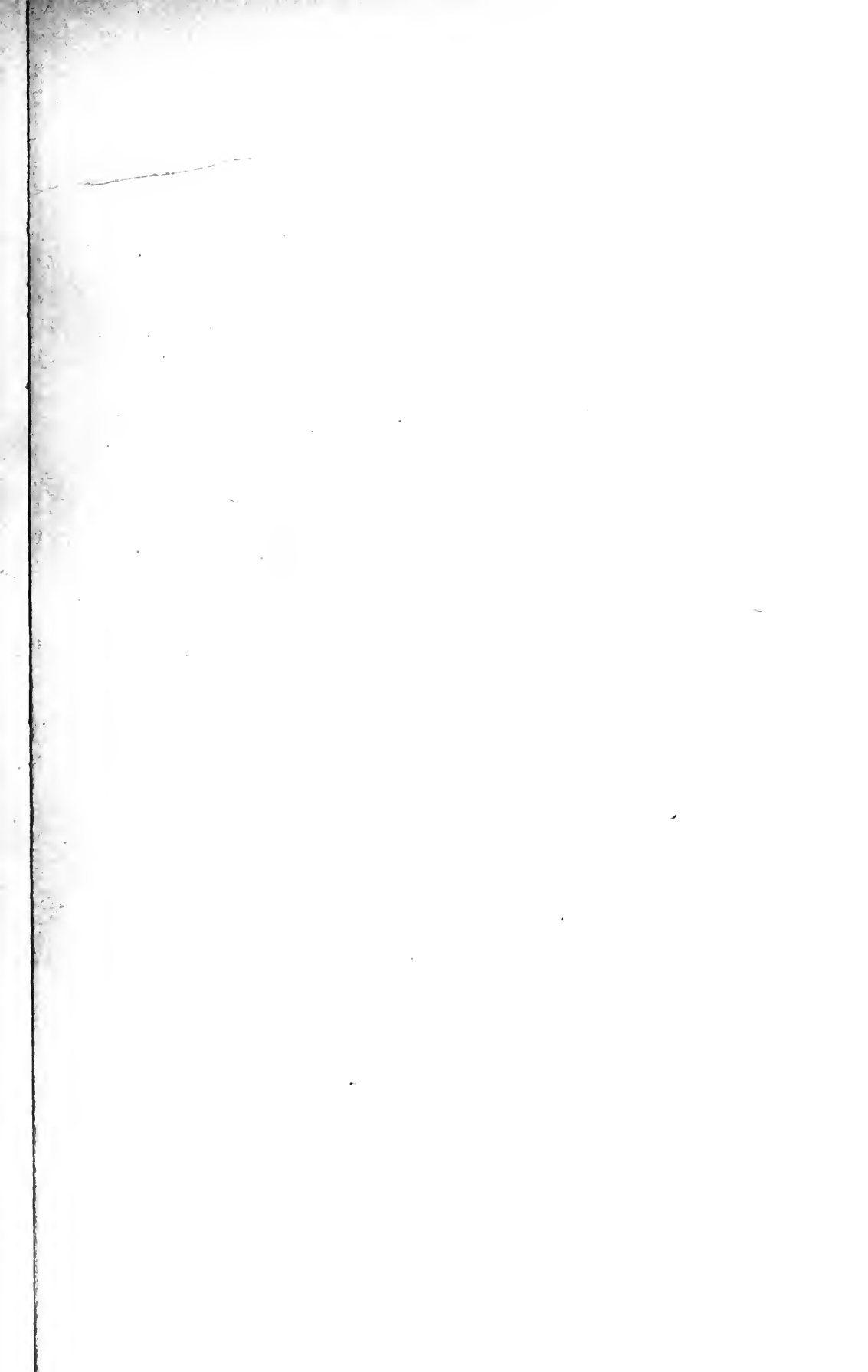



DISTRIBUTION OVER THE MEAN ANNUAL PRECIPITATION

1

INS.
10
20
40
60
80
120
180

SCALE OF RA
The figures on th

COPYRIGHT, 1902, BY

OF RAINFALL
LANDS
ANNUAL

EASTERN HEMISPHERE



MM.
250
500
1000
1500
2000
3000
4000

Coloring
represent inches.
D. MEAD & COMPANY.

jostled together by currents of air, or that the larger ones fall fast enough to overtake the smaller ones, so that in either case larger particles are formed which, as they descend, grow by the accretion of small particles that lie in their path. (b) That some of the smaller particles are positively and others negatively electrified, and consequently by attraction are made to coalesce. (c) That some particles, being larger than others, have different surface tensions, and that the larger ones are thereby enabled to grow at the expense of the smaller ones. (d) That the original cloud particles consist of vapor that has condensed upon particles of dust or foreign substances in the air, and that this condensation takes place more readily upon some nuclei than others, as is known to be the case from the observations of Wilson, Aitken, Barus, and others. (e) That the atmosphere within a cloud, being saturated, has no remaining nuclei upon which condensation can take place, and as the air continues to rise and cool it comes to a state of supersaturation and intense molecular strain, which is finally relieved by a violent condensation upon groups of cloudy particles already existing; this violent condensation takes place in such a way as to sweep many of the smaller cloud particles together into one large drop: C. T. R. Wilson has shown that these larger drops can only be formed when the air in the dustless cloud has been expanded and cooled at least one-third more than is required for ordinary dusty air. (f) Wilson has lately shown the plausibility of a slight modification of the preceding method; he finds that dustless air virtually acquires new nuclei on which condensation takes place when a beam of ultra-violet light or of the Roentgen rays, the radiation from cranium, or even ordinary sunlight, passes through the moist air, that in fact such nuclei are being formed in it all the time.

Professor J. J. Thomson's observations on the formations of 'ions'—namely, the breaking away from a molecule of some one of its integral components which he calls 'corpuscles'—suggest that the atmospheric 'ions' thus formed are active in producing cloudy condensation, and that the negative 'ions' attract moisture to themselves more readily than the positive, therefore they grow to be larger drops, and descending to the earth with their negative charges, give it negative electricity, while the atmosphere is left essentially positive.

GEOGRAPHICAL DISTRIBUTION OF RAIN. As all animal and vegetable life on the earth's surface depends more or less directly upon the quantity of rainfall and its distribution throughout the months of the year, therefore the geographical and seasonal distribution of rain claims our first attention. From the preceding section it is seen readily that the distribution of rain over the earth's surface must depend upon the influences that force air to ascend rapidly. Thus on warm clear days, when the surface of the ground or water is highly heated, the lower stratum of air acquires a decided upward motion by reason of its buoyancy. Masses of hot air are rising while the cooler air near by is descending. Thunder storms are usually formed in this way, and nearly every station in the torrid and temperate zones has a preponderance of local rains in the afternoon. Whenever an ocean

breeze or a monsoon wind rises high enough on a mountain side it gives rise to cloud and rain, so that the ocean winds bring more rain than the land breezes. The finest illustrations of this principle are seen in the rains of the southwest monsoon in India, in the rains that fall with southwest winds on the coast of Europe, or in the southerly winds with rain on the Gulf coasts of the United States. Again, when a moist warm wind meets a cold dry wind, the latter generally flows under and lifts up the former, because of the greater density of the cold air compared with the warm. Therefore above the cold air is formed a layer of cloud and oftentimes of rain due to the rapid elevation of the warm air. Illustrations of this are to be found on the southeast and southwest sides of the areas of low pressure that pass eastward over the United States throughout the year, and especially in the winter season. From the preceding it follows (1) that every rising slope, whether of mountain ranges or interior plains, should, other things being equal, show a greater rainfall as we proceed up the slope, and this distribution of rainfall with altitude has been found to agree with observations in Great Britain, Germany, India, the East Indies, and the United States; (2) considering the world at large, the heavier rainfalls should occur in regions where warm moist winds steadily impinge upon the mountain slopes. The above principles are exemplified in the rainfall charts contained in Bartholomew's *Physical Atlas* (London, 1899), and especially in the twenty-six maps showing the monthly and annual distribution of the rainfall on the land surface throughout the globe compiled by A. J. Herbertson and published by the Royal Geographical Society of London in 1900. Herbertson's charts of annual rainfall on the land surfaces are reproduced herewith.

SEASONAL DISTRIBUTION OF RAIN. This is in many respects more important than the total annual quantity. It is the combination of rainfall, temperature, and sunshine that determines the character of the vegetation in each part of the globe. In the Northern Hemisphere some stations have a large rainfall in June and July, when the sun is nearly overhead; but other stations have the minimum rainfall at this season. In the tropics most stations have two minima and two maxima of rainfall during the year. In the Southern Hemisphere, where the sun has its maximum power in December or January, even greater diversities appear. The growth of the perennial vegetation, and especially the annual plants and the important crops, is entirely controlled by these relations of sunshine and rain. In regions where the rainfall is insufficient to perfect the important grain crops, recourse must be had to irrigation, the success of which again depends upon the annual distribution of snow and rain.

Various types of rain prevail over the ocean as well as over the land, although, unfortunately, we have but very few measurements of the actual rainfall at sea, and must, therefore, speak only of the frequency of the rain. Thus on the Atlantic and Pacific oceans, under or near the equator, is a rainy belt, where the pressure is always low, the winds exceedingly light, variable or calm; here the sun almost invariably rises in a clear sky, but about midday clouds begin to gather, and in a short time the whole

face of the sky is covered with dark clouds which pour down prodigious quantities of rain. Toward evening the clouds disappear; the sun sets in a clear sky, and the nights are serene and fine. In latitudes 25° N. to 35° N. on both Atlantic and Pacific there is a region of northeast trade winds in which the rainfall is comparatively light and occurs equally in all parts of the earth.

The details of the distribution of rainfall in the United States are given by Professor A. J. Henry in his "Rainfall of the United States," *Weather Bureau Bulletin D, 1897*, and especially in the article, "Rainfall and Charts of Rainfall," in the *Monthly Weather Review* for April, 1902 (Washington, D. C.).

RAIN-BIRD. Any bird popularly believed to foretell rain. Many of these birds are cuckoos. Both of the North American species have this reputation, as also have the black nuth of Mexico and southward, which are frequently called 'rain-crows.' In the middle western portion of the United States the bird commonly called 'rain-crow' is the yellow-billed cuckoo. The East Indian cuckoos, called 'koels' (q.v.), have the same reputation, and are commonly known in India and the Malay countries as 'rain-birds' and 'foretellers.' To what extent this repute is justified is a question admitting of discussion. Birds, as well as other animals, are no doubt sensitive to changes in the temperature and humidity of the air, and some may be quick to recognize that certain of these changes portend disagreeable weather. The immediate effect or their anticipations may lead them to make outcries indicative of discomfort or alarm. A great variety of information and folk-sayings on this subject is given in Dunwoody's "Weather Proverbs," *Signal Service Notes, No. ix.* (War Department, Washington, 1883). For Oriental superstitions, see *Ibis* (London, 1879).

RAINBOW (A.S. *Regnboga, rēnboga*; OHG. *regan-bogo*; Ger. *Regenbogen*, from *Regen*, rain, and *boga*, bow). The term applied to the arc of prismatic colors which at times is seen when the sun or moon is shining while it is raining. It always is seen in the part of the heavens opposite to the sun, and is high when the sun is low, and low, near the horizon, when the sun is high. It is a short arc, or a complete one, resting on the earth at each end, according to the extent of the rain. Sometimes a second concentric bow is seen with the colors reversed. Both are due to the reflection and refraction of the rays of the sun in the drops of rain.

If the parallel lines S, Fig. 1, represent rays coming from the sun and falling upon the drop of water, the centre of which is O, it is possible to determine the path of each ray by applying the simple law of refraction. For example: the ray SB will be refracted to A, reflected to C, and finally refracted out to T. The parts of the ray which are reflected out at B, refracted out at A, or reflected in at C, need not be considered, as they do not contribute to the phenomenon. It may be shown that when the arcs BA and AC are equal, then the angle between SB and CT is greater than for any other case. In other words, when the ray passes through the drop symmetrically, the final direction of the ray is at the greatest angle with the original direction, and also that a greater proportion of the total light falling on the drop is sent out

in this direction than in any other. The light which falls farther out on the drop than B is mostly reflected off the drop, and that which falls nearer than B enters the drop, but

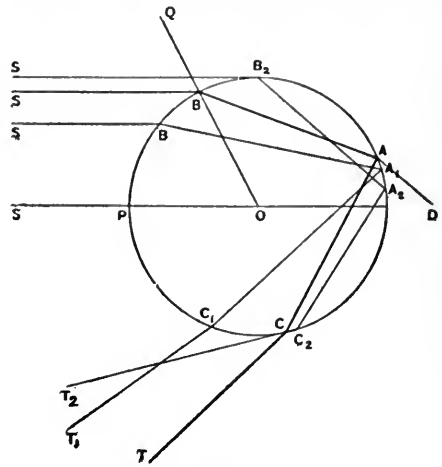

FIG. 1.

mostly passes out at the back at A. Inasmuch as the index of refraction is different for the different colored lights, it follows that the angle between SB and CT must be different for the different colors, less for violet than for red. An eye at T, Fig. 2, looking toward the drop, would see considerable of the light coming in the direction CT, but an eye at E₁ would only see a little light corresponding to the ray SB₂A₂C₂T₂, and an eye at E₂ would see no light from that drop. If we imagine the whole of Fig. 2 revolved upon the line TS' as an axis, then

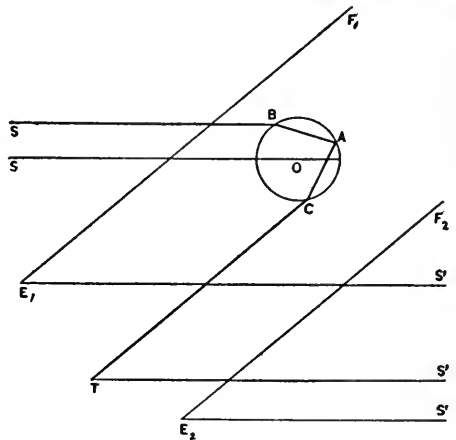

FIG. 2.

the ray SB becomes a cylindrical shell of rays, the drop becomes a circular arc of drops, and the ray CT becomes a conical shell of rays, which, seen by the eye at T, appears as a ring of light against the clouds as a background, having an angular radius equal to CTS'. If the red rays are considered this radius would be about $42^{\circ} 22'$, and for the violet rays $40^{\circ} 35'$, and for the intervening colors it would have corresponding values. Thus the ring of violet would appear the smallest and the red the largest, with the

other colors ranged between. Of course, a particular drop is only in the right position to contribute to this ring of light for a small fraction of a second, but others take its place. Moreover, the apparent diameter of the sun causes a widening of the line of light to a band, and these bands of different colors overlap and blend. The bow formed as above described is called the 'primary bow' and is much brighter than the 'secondary bow,' which is formed as

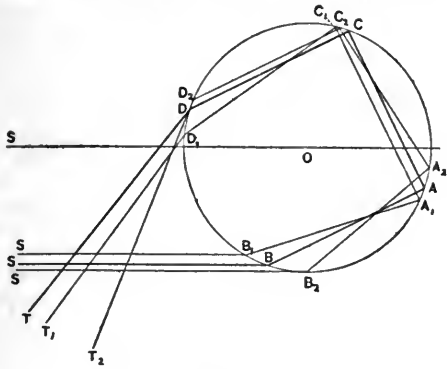

FIG. 3.

follows: By a line of reasoning entirely analogous to that given above, it may be shown that light falling upon the opposite half of the drop, as shown in Fig. 3, may undergo two reflections in the drop and emerge in the direction DT. Again, when the path is symmetrical in the drop, the angle between SB and DT is now smaller than for any other case, but larger for violet than for red, and in all cases larger than the angle between SB and CT in the primary bow. Applying a similar consideration to Fig. 4, and considering it revolved upon the line

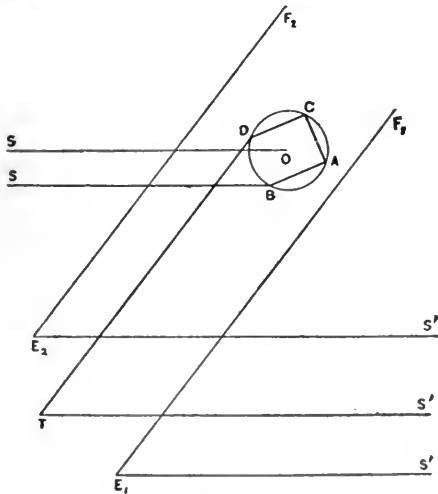

FIG. 4.

TS' as an axis, it will be seen that colored bands of light will be seen by the eye at T of an angular diameter greater than any in the primary bow, and with the violet having the largest and the red the smallest diameter. The angular radius of the red is about 50° 24' and of the violet 53° 22'. The values of the diameters

were calculated by Airy and experimentally verified by Miller. When the conditions are very favorable other fainter bows may be seen inside the primary and outside the secondary bow. These correspond to a still more complex combination of reflections and refractions of the rays in the drops. A lunar rainbow differs from a solar bow only in the intensity of the light and consequent paleness of the colors.

RAINBOW FALLS. A cataract in the State of Washington. See CHELAN, LAKE.

RAINBOW TROUT. The trout of the coast ranges of the Pacific Coast, from central California northward to Puget Sound, which takes its name (*Salmo irideus*) from the large, brilliant spots scattered over its bluish-silvery body. See TROUT; and Plate of TROUT AND GRAYLING.

RAIN CROW. See ANI; and Plate of CUCKOO.

RAIN GAUGE. An apparatus to catch the rain and measure its equivalent depth on the ground at any place. The simplest rain gauge consists of a vertical cylinder, into which one may dip a graduated stick and read off the depth of the collected water. Such an instrument is furnished by the United States Weather Bureau to its voluntary observers, and is illustrated in the accompanying figure. Other gauges consist essentially of funnels to catch the water, glass bottles to hold it, and slender graduated glass tubes by which to make minute

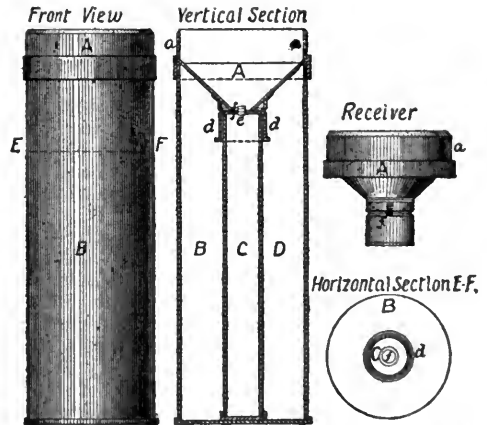

SIMPLE RAIN GAUGE, U.S. WEATHER BUREAU PATTERN.

measurements. Self-registering gauges are now made so economically that they are always to be recommended: those of the simplest pattern employ a tipping bucket, divided into two equal compartments, and tipping to the right and left alternately, according as the right or left compartment is filled. Each tip corresponds to a definite depth, such as a hundredth of an inch. Another favorite form consists essentially of a weighing machine, and every ounce of rain, or the equivalent depth, is properly recorded on a sheet of paper moved by clockwork. Both forms, as perfected by Professor C. F. Marvin, are used by the United States Weather Bureau.

It has long been known (since Heberden, 1776) that perfectly reliable gauges collect less rain the greater their height above ground, and it is now satisfactorily demonstrated that this is entirely due to the fact that the gauge causes eddies of wind around and even within its

mouth. These eddies carry away the smaller particles of rain or snow to a greater or less extent. On the average of all records that have been made in Europe and America and in all kinds of rain, the deficit of rain recorded by the gauge has been found to increase in proportion to the square root of the altitude above ground. Consequently the correct rainfall can be approximately determined if the observer notes the difference between the catches of two or more similar gauges set at different altitudes above the ground.

In 1855 Joseph Henry, in 1875 F. E. Nipher, and in 1886 Wild and Boernstein described appliances that largely annul the error due to the wind. Henry surrounded his gauge with a thin broad rim near the top, either horizontal or sloping downward; Nipher surrounded it with an umbelliform structure of wire gauze; Wild surrounded it with a closed board fence, but Boernstein placed a simple open board fence at a distance of about two feet around the gauge. When a gauge is set up within a shallow saucer-like depression in the ground, so that the mouth of the gauge is level with the earth beyond the edges of the pit, or when it is placed on the flat roof of a building and protected on all sides by a high balustrade, good measurements are also obtained. Most elaborate investigations into the peculiarities of rain gauges are published in the annual volumes of Symons's *British Rainfall*. For other special studies, see the works of Eastman, United States Naval Observatory; Hellmann, Berlin, 1890; Abbe, Washington, 1887 and 1892; Boernstein, Saint Petersburg, 1890; E. Berg, Saint Petersburg, 1895.

RAINIER, rā'nēr, MOUNT, or MOUNT TACOMA. One of the highest peaks of the United States, exceeded south of Alaska only by Mount Whitney. It is a regular volcanic cone rising from the Cascade Range in the southwestern part of the State of Washington to a height of 10,000 feet above its immediate surroundings and 14,526 feet above the sea (Map: Washington, C 2). Although its crater still emits sulphurous fumes, it is to be regarded as extinct, since the deeply eroded slopes of the mountain show that the last eruption must have occurred at a remote period. The lower slopes are densely forested, but the higher portion carries a series of fourteen glaciers, the largest in the United States south of Alaska. The ascent of the mountain is difficult.

RAINOLDS, rēn'olz, or **REYNOLDS**, JOHN (1549-1607). An English biblical scholar. He was born at Pinhoe, near Exeter. He graduated B.A. at Corpus Christi College, Oxford, in 1568, and became tutor to Richard Hooker. He was afterwards Greek teacher (1572-78). He took a prominent part in university affairs at Oxford and distinguished himself as a zealous Protestant. In 1593 he was made Dean of Lincoln, with the expectation that he should later exchange offices with Dr. William Cole, president of Corpus Christi. This arrangement was carried out in 1598, and the college prospered greatly under his management. Rainolds's greatest distinction is the part he took in the Hampton Court Conference (q.v.) and his connection with the translation of the Bible. It was he who urged the necessity of the latter work upon the King, and he occupied a prominent position among the translators; his com-

pany was that to which the prophets were assigned. Rainolds's writings were numerous, many of them, however, not being published till after his death.

RAINS, rānz, GEORGE WASHINGTON (1817-98). An American soldier and chemist, born in North Carolina. He graduated in 1842 at the United States Military Academy, and was an instructor there in 1844-46. He served in the Mexican War, was brevetted major for gallant conduct, and in 1849-50 fought against the Seminoles. Promoted in 1856 to be captain, he resigned in the same year and in 1861 entered the Confederate Army as colonel. He erected the Confederate powder-mill at Augusta, Ga., and was promoted to be brigadier-general. From 1867 he was professor of chemistry and pharmacy in the University of Georgia, and until 1884 was dean of the faculty. He published *Steam Portable Engines* (1860); *Rudimentary Course of Analytical and Applied Chemistry* (1872); and *Chemical Qualitative Analysis* (1879).

RAINS'FORD, WILLIAM STEPHEN (1850—). An American clergyman of the Protestant Episcopal Church. He was born at Dublin, Ireland, October 30, 1850. He took his degree at Saint John's College, Cambridge, in 1872, and was curate of Saint Giles's Church, Norwich, 1872-76. He was very successful as an evangelist, and came to the United States in 1876 to take part in gospel-tent meetings in New York. Subsequently he conducted evangelistic services in other cities of the United States, in London, and Canada. From 1878 to 1882 he was at the Cathedral of Saint James, Toronto. In 1883 he became rector of Saint George's Church, New York. He published a volume of sermons (1887); *Good Friday Meditations* (1901); *The Reasonableness of Faith and Other Addresses* (1902).

RAINY, rā'mi, ROBERT (1826—). A Scottish divine and scholar, born at Glasgow, January 1, 1826. Educated at Glasgow University and at New College, Edinburgh, he became minister of the Free Church at Huntly in Aberdeenshire (1851-54) and of the Free High Church in Edinburgh (1854-62). After serving for twelve years as professor of Church history, he was elected principal of New College (1874). In 1900 he was made moderator of the United Free Church Assembly. Among his publications are: *Three Lectures on the Church of Scotland* (1872; often reprinted); *Development of Christian Doctrine* (1874); *The Bible and Criticism* (1878); *The Epistle to the Philippians* (1892); and *Presbyterianism, a Form of Church Life and Doctrine* (1894).

RAINY LAKE. A lake forming part of the boundary line between Canada and the State of Minnesota, and situated 160 miles west of Lake Superior (Map: Ontario, K 8). It is a very picturesque sheet of water, nearly 50 miles long and five miles in average breadth. Its surplus waters are drained into the Lake of the Woods (q.v.) by the Rainy River, which is about 100 miles in length, and the banks of which are covered with pine-forests.

RAI SANYO, rī sän'yō (1780-1833). A Japanese author and historian, who, in 1827, after sifting 650 native books in twenty years of continuous labor, published in 22 volumes his great work, the *Nihon-Guashii*. It is written in Chinese and tells the story of the domination of

the Empire by the military class, from the twelfth century onward, picturing the rise of those military clans, the Taira and Minamoto, that usurped the power of the Mikado, and ending with the establishment of the Tokugawa shogunate in the early part of the seventeenth century. In his other work, the *Nihon Siki*, also in Chinese, published posthumously, Rai sketches in 16 volumes the history of Japan from B.C. 660 to 1596, discussing the character and conduct of each sovereign in turn. The effect of these writings was to educate the Japanese Samurai (q.v.) into a bitter hatred of the Shogun, and to set forward the revolution of 1868. The name of Rai Sanyo is cut upon the front of the Boston Public Library as one of the great names in the world's literature. Five books of the *Nihon-Guishi* were later translated into English in 1872 by Satow (q.v.), British Minister to Japan, and afterwards Minister to China. Consult: Chamberlain, *Things Japanese* (London and New York, 1891); and Aston, *History of Japanese Literature* (London, and New York, 1901).

RAISINS (OF. *raisin*, *reisin*, Fr. *raisin*, It. *racemo*, grape, dried grape, cluster of grapes, from Lat. *racemus*, cluster of grapes; connected with Gk. *ράξ*, *rhax*, berry). The dried fruit of the grape. Raisin grapes are usually the product of warm climates and contain from 28 to 30 per cent. of sugar. They are for the most part dried in the sun, and as this requires several weeks of practically rainless weather, the areas of commercial culture are limited to a few countries about the Mediterranean Sea and in the Western Hemisphere to Southern California and Chile. The principal and most valuable class of raisins is the Muscatel or Muscat from Malaga and Valencia in Spain, and from California. The seedless raisins of commerce are largely the product of the sultana grapes. The Thompson seedless, which is a promising seedless raisin grape in California, produces raisins a little larger than the sultana. The smallest raisins come from the small currant grape, originally from Corinth. The small black currant of Zante belongs to this class. (See CURRANT.) In the sun curing of standard raisins in California the bunches of grapes are picked by the stems, and all imperfect berries, dirt, etc., having been removed, laid in trays slightly raised so as to incline toward the sun. When about two-thirds dry, which will be at the end of six to eight days, they are turned by placing an empty tray over the filled one and inverting both. The upper or original tray is then removed and the grapes exposed four or five days longer for further drying. At the end of this time the grapes are stored and put through a sweating process of from fifteen to twenty days, when they are ready for packing. Sometimes the drying is done entirely in drying houses. In the Mediterranean districts the stems of the ripened bunches are sometimes partially cut and the sun drying begun on the vines. Another method of curing is to dip the bunches into a hot solution of potash lye, to which has been added a little salt and olive oil. This method is practiced much more in Europe and Asia Minor than in California. Some of the best raisins of commerce are thus treated. The raisin industry in California has developed rapidly, and in 1900 about 40,000 acres were devoted to this

crop. Consult Eisen, *The Raisin Industry* (San Francisco, 1890).

RAJA, rā'ja (Skt. *rājan*, king). Originally a title of those princes of Hindu race who, whether independent or not, governed a territory. It subsequently became a title given by the native governments, and in later times by the British Government, to Hindus of rank, and it is now not uncommonly assumed by zemindars or land-holders. The native princes now frequently assume the title of *mahārāja*, or great king. According to the ancient social system of India, the raja belonged to the kshatriya or military caste (see CASTE), although the title is now also given to or assumed by members of inferior castes. Consult: Foy, *Die königliche Gewalt nach den altindischen Rechtsbüchern* (Leipzig, 1895); Jolly, *Recht und Sitte* (Strassburg, 1896).

RAJĀŚEKHARA, rā'jā-shā'k'hà-rā (c.900 A.D.). A Sanskrit dramatist. He seems to have been born in the Dekkan, doubtless in the region about Vidarbha and Kuntala, whence he came to the Court of Mahendrapala, King of Kanauj. He was a Brahman, and his wife, Avantisundari, was a Rajput princess. Four plays are ascribed to Rajasekhara. The first is a drama in four acts, entirely in Prakrit (q.v.), entitled *Karpūramānjari*, or Camphor-Cluster. It was edited by Vamanacarya (Benares, 1872), and, together with the *Bālabhārata*, by Durgaprasad and Parab (Bombay, 1887), and with an admirable English translation, glossary, and account of the author by Konow and Lanman (Cambridge, Mass., 1901). The second drama is the *Viddhasālabhaijīkā*, or Broken Statue, also in four acts, which much resembles in plot the *Karpūramānjari*. It has been edited by Vamanacarya (Benares, 1871), by Vidyasagara (Calcutta, 1873; 2d ed., ib. 1883), and by Arte (Bombay, 1886). The remaining plays are based on the two great epics of India, the *Rāmāyana* (q.v.) and the *Mahābhārata* (q.v.). Of these dramas the *Bālarāmāyana*, in ten acts, is the more important. It was edited by Sastri (Benares, 1869) and by Vidyasagara (Calcutta, 1884). The last play, the *Bālabhārata* or *Pracandapāndava*, in only two acts, seems to be incomplete. It has been edited by Capeller (Strassburg, 1885). Consult Apte, *Rājasekhara, His Life and Writings* (Bombay, 1886).

RĀJĀTARĀNGINĪ, rā'jā-tā-rān'gè-nè (Skt., river of Kings). A work of the Kashmirian poet and historian Kalhana. In eight cantos with a total of about 8000 verses it tells the histories of the various dynasties which ruled Kashmir from the earliest (mythic) period down to the time of the author. Kalhana describes himself as the son of Campaka, the minister of the famous King Harsha, who ruled from 1029 to 1101. The history was written between 1148 and 1150 under the reign of Sinhadeva. Kalhana's chronicle is practically the sole extant work of a truly historical character in the entire range of Indian literature. He reports that he studied eleven historical works, but not content with that, he examined old documents, grants, proclamations, laws, and sacred books. He is especially well acquainted with the great epic, the *Mahābhārata* (q.v.), which he cites frequently. Above all he has the gift of character portrayal. The historians whom Kalhana mentions as his predecessors are all lost, so that the *Rajatarangini*

is the chief and direct source of information on the ancient history of Kashmir. The first three cantos, which deal with the two first dynasties, are almost wholly legendary. Kashmir was always closely connected with the Hindu kingdoms to the south, so that Kalhana's work is important authority for the history of India as a whole. Incidentally the *Rajatarangini* throws much light on the social, political, and religious conditions of India of the twelfth century. Stein published a critical edition of the text at Bombay in 1892, and a translation in two volumes, with an introduction, commentary, and appendices, at Westminster in 1900.

RAJENDRALALA MITRA, rā-jēn'drā-lā'li mē'trā,-RAJA (1824-91). An Indian Orientalist, born near Calcutta. He early devoted himself to historical and philological research, became librarian of the Bengal Asiatic Society in 1846, its vice-president (1861-85), and its president in 1885. To the *Journal* of the society he contributed many valuable papers. But he was better known for his *Antiquities of Orissa* (1875); *Buddha Gayā* (1878); *Indo-Aryans* (1881); and the *Sanskrit Buddhist Literature of Nepal* (1882), in which he showed especial skill in deducing history from artistic and architectural remains.

RAJKOT, rāj'kōt'. A town and railway station, capital of a Gujarat native State of the same name, on the Kathiawar Peninsula, Bombay, India, 110 miles west of Cambay. It has several educational institutions, including a Rajkumar college for native princes; and there is a bridge of some merit spanning the Aji River. A military cantonment is located here. Population, with cantonment, in 1891, 29,247; in 1901, 36,151.

RAJNA, rī'nā, Pio (1847-). An Italian philologist, born at Sondrio, and educated at Pisa. He taught in *licei* at Modena and Milan, and in 1883 became professor of Romance philology at the Florence School for Higher Studies. He published *Ricerche intorno ai Reali di Francia* (1872); *Le fonti dell' Orlando Furioso* (1876); *Le origini dell' epopea francese* (1884, winning the Diez Prize); and critical editions of Dante's *De Vulgari Eloquentia* (1896 and 1897, under the supervision of the Società Dantesca Italiana).

RAJON, rā'zhōn', PAUL ADOLPHE (1844-88). A French etcher, born in Dijon. He was a pupil at the Ecole des Beaux-Arts, and of Pils. He executed a large number of etchings from pictures in a careful and sympathetic manner. They include the notable portraits of J. S. Mill, Tennyson, Joachim, and Mrs. Anderson Rose, after Watts; Darwin, after Oulless; and the Emperor Claudius, after Alma-Tadema. He received medals at the Salons of 1869, 1870, and 1873. Consult Stephens, *Twelve Etchings by P. A. Rajon*, with a memoir (1889).

RAJPUTANA, rāj'pūt-tā'nā. A division of British India consisting wholly of native States with the exception of the small enclave of Ajmere-Merwara (q.v.), which is under British administration (Map: India, B 3). The division is bounded on the north by the Punjab, on the east by the United Provinces of Agra and Oudh, on the southeast by the Central India Agency, and on the southwest and west by Bombay. Its total area is 127,541 square miles, or twice the size

of New England. Rajputana is divided into two distinct physical divisions by the Aravalli Range, which crosses it from southwest to northeast. The northwestern and much the larger part consists of sandy and arid wastes. It includes the Tar, or Great Desert of Northern India. The southeastern portion is much more elevated and watered by numerous streams flowing chiefly to the Jumna, the largest being the Chambal, or Chumbul. It contains large fertile tracts, but consists principally of rugged and rocky country covered with jungle. The climate in the main portion is very hot and dry, and the rainfall scanty and irregular.

Agriculture, including herding, is the principal occupation. Pulse, cereals, cotton, and other fibres are grown. The status of agriculture varies greatly with varying climatic conditions. The scant rainfall over the larger portion of the region renders the industry precarious, and there is liability to famines. Some commerce is carried on with the surrounding regions. A railroad traverses Rajputana from northeast to southwest. Branch lines have been constructed by the agencies of Bikanir, Jodhpur, and Udaipur. The total population in 1901 was 9,723,301, the famines having caused a decrease of 2,267,203 during the preceding decade. The population is composed mainly of Hindus, of whom there were 8,090,269 in 1901. The Mohammedans numbered 924,656; the Animisties, 360,543; Jains, 342,595. The Christian religion has probably made less progress here than in any other portion of India, there having been in 1901 only 2840 Christians. Among the principal Rajput States are Bikanir, Jodhpur, Jaipur, Alwar, Bhartpur, Jaisalmer, Udaipur, and Kotah. The most important city is Jaipur. Each of the 19 States which compose Rajputana has an autonomous government under its own chief. While the Rajput clans represent a very small minority of the population, the chiefs of sixteen of the States are of that tribe. The chiefs in two of the other States are Jats, and the head of the third is a Mohammedan. The whole is under British suzerainty.

RAJPUTS, rāj'poots' (Hind. *Rājput*, from Skt. *rājanputra*, prince, from *rājan*, king + *putra*, son). The Rajputs, from whom Rajputana, in North-Central India, has received its name, number some 11,000,000. The name is an honorary one applied to a congeries of tribes and castes of diverse origin and customs. The Rajputs were originally the feudal conquerors of Western Hindustan. Despite their claim to be descendants of the ancient Hindu Kshatriya caste (see CASTE), it is doubtful whether their Brahmanism is not like other of their mental and physical qualities, a transferred character. The chief seat of the Rajputs is Rajputana, but they are also numerous in Gujarat, and were formerly powerful in Lower Sindh. Consult Crooke, *Tribes and Castes of the Northwest Provinces and Oudh* (Calcutta, 1896).

RAJSHAHĪ, rāj-shā'hé. A division of Bengal, British India, having an area of 17,356 square miles. It is divided into seven districts: Rajshahi, Dinajpur, Jalpaiguri, Darjiling, Rangpur, Bogra. Pabna. Population, in 1891, 7,726,701; in 1901, 8,489,788.

RAKE'S PROGRESS, THE. A series of eight paintings by Hogarth (1735), now in the

Soane Museum. They depict the career of a dissolute man of fashion of that day. They are entitled: (1) "The Heir and His Property;" (2) "Surrounded by Artists;" (3) "Tavern Scene;" (4) "Arrest for Debt;" (5) "Marriage;" (6) "Gaming;" (7) "Prison;" (8) "Madhouse."

RÁKÓCZY, rá'kō-tsi. A distinguished Transylvanian family, who played an important part in the affairs of Hungary during the seventeenth and eighteenth centuries. GEORGE I. RÁKÓCZY (1591-1648) became Prince of Transylvania in 1631. He married the heiress of the Báthory family, thereby acquiring immense riches. In alliance with the Swedes and the French he invaded Hungary in 1644 and succeeded in extorting new guarantees for Hungarian liberties in the Peace of Linz (1645). A great-grandson of GEORGE I. was FRANCIS II., Prince of Transylvania, born in 1676. His father, FRANCIS I., was elected Prince of Transylvania, but never assumed the office, and died soon after his son's birth. FRANCIS II. was a Protestant, married a princess of Hesse, and in 1701 was imprisoned on an accusation of conspiracy to incite rebellion, but he escaped to Poland, and headed an insurrection in Hungary against Leopold I. (1703), at the time when that prince was engaged in the War of the Spanish Succession. He soon gained possession of Hungary and Transylvania, his operations being facilitated by subsidies obtained by Louis XIV. In 1705 the insurgent parts of Hungary united themselves in a confederation, and placed Rákóczy at the head. He had previously been chosen Prince of Transylvania. In 1708 he was defeated by the Austrians; dissensions sprang up in the confederation, and during his absence in Poland (1711) a treaty of peace was negotiated between Austria and the confederation at Szatmár. This treaty Francis Rákóczy never acceded to. He lived in exile in France and Turkey, and died at Rodosto, on the Sea of Marmora, April 8, 1735. Consult his *Mémoires, sur les révolutions de Hongrie* (The Hague, 1739).

RÁKÓCZY MARCH. A military air by an unknown composer, popularized by the army of Francis Rákóczy II. of Transylvania. The Hungarians adopted it as their national march, and, like the "Marseillaise" in France, it has been placed under the ban of the Austrian Government at various periods of political excitement. The air most generally known in Germany and elsewhere out of Hungary as the Rákóczy March, which is introduced by Berlioz in his *Damnation de Faust*, is a weak paraphrase of the original version of Rucziska.

RÁKOSI, rá'kō-sé, JENÖ (1842—). An Hungarian author, born at Acsád, Eisenburg County, and largely self-educated. At twenty-one he went to Budapest, became a contributor to the *Napló* when that journal was under the charge of Kemény, and in 1866 scored a great success with his comedy, *Esop*. From 1875 to 1881 he was manager of the Hungarian popular theatre in Budapest and then founded the *Budapesti Hirlap*, a radical paper. His success with *Esop* made him a leader of the younger literary circle. Among his later works are the tragedy *Andrew and Joanna*, dealing with the murder of Andrew of Anjou by Joanna, I. of Naples (1885); a study of the nature of tragedy (1886); a very realistic and Zolaesque drama entitled *Magda-*

lene; The Greatest Fool, a novel; some dramas, comedies, and farces; and a comediotta, *Ida*, which was played in Dresden. His brother VICTOR (1860—) is a popular humorist.

RAKSHASA, rük'há-sá (Skt. *rakṣas*, *rakṣasa*, demon, probably from *rakṣ*, to injure, hardly from *rakṣ*, to protect, ward off). In Hindu mythology, the name of the principal class of demons. The Rakshasas play an important part in the religion of India from the Vedic period to the present time. They may assume various shapes at will, as of dogs, vultures, owls, and other ill-omened creatures, or of human beings. When they assume human form, they are occasionally beautiful, especially as women, but more often they are hideously malformed, with three heads, five feet, monstrous bellies, projecting teeth, crooked thighs, or with feet turned backward. Their special object of maleficence next to children is sacrificial worship, although they ever lurk to destroy the pious, especially by entering his body together with his food. The post-Vedic texts abound in tales of these demons, who there assume the vampire type. They are essentially nocturnal fiends, devourers of corpses, and haunters of graveyards. Among themselves the Rakshasas have kingdoms and enormous wealth which they bestow generously on those who win their favor. They are, therefore, regarded as the attendants of Kubera. They are constantly at war with the gods, but are routed by Vishnu (q.v.). Like many devils, they are extremely stupid, and may easily be cheated by their intended victims. The origin of these demons is uncertain. Some texts say they were either created by Brahma to guard the waters, or were born from his foot, while other accounts call them the children of Pulastya, or of Rakshas, son of Kasyapa. Consult: Muir, *Original Sanskrit Texts* (London, 1868-74); Crooke, *Popular Religion and Folk-Lore of Northern India* (2d ed., ib., 1896); Macdonell, *Vedic Mythology* (Strassburg, 1897); Wilkins, *Hindu Mythology* (London, 1900).

RALE, or **RASLE**, ráI, SÉBASTIEN (1657-1724). A Jesuit missionary in North America. He was born in Franche-Comté, became a Jesuit novice at Dôle in 1675, was an instructor from 1677 to 1684 at Carpentras and Nîmes, and in 1689 went to Canada as a missionary. He was stationed for two years at the Abenaki mission of Saint Francis, near the mouth of the Chaudière, afterwards spent two years among the Illinois Indians, and from 1694 until his death was stationed among the Norridgewocks, near the present Norridgewock, Maine. He learned the Abenaki language, acquired great influence over the Indians, and was believed by the English, apparently with good reason, to have been the instigator of the Indian attacks upon the English in this region, which resulted in the so-called Dummer's War (q.v.). In 1705 a party of English settlers attacked and burned the church which had been built by Rale; in 1722 another party pillaged Rale's cabin and burned the church, which had been rebuilt; and in August, 1724, a third party surprised the town, killed several Indians, and shot Rale. Among Rale's papers which were carried off by the English was his dictionary of the Abenaki language, upon which he had been engaged for thirty years. This is preserved in the library of Harvard University, and was pub-

lished by John Pickering in the *American Academy of Arts and Sciences Memoirs*, New Series, vol. i. (Cambridge, 1833). A number of Rale's letters are given in Thwaites (ed.), *Jesuit Relations* (Cleveland, 1903). Consult: Francis, "Life of Rale," in *Sparks's American Biography*, New Series, vol. vii.; Parkman, *A Half Century of Conflict* (Boston, 1892); Baxter, *The Pioneers of New France in New England* (1894); and, for a defense of Rale, Shea, *The Catholic Church in Colonial Days* (1886); and an article in the *United States Catholic Intelligencer*, vol. viii. (1831).

RALEGH, or RALEIGH' rā'li, CAREW (1605-66). An English politician, the second son of Sir Walter Raleigh. He was born in London, in 1604, and was educated at Oxford University. In 1635 he was appointed a gentleman of the privy chamber to Charles I. From 1648 to 1653 he was member of Parliament for Haslemere, and also sat in the Rump Parliament. After the Restoration he received the appointment of Governor of the Island of Jersey. He was killed in 1666. He was the author of a vindication of his father, entitled *A Brief Relation of Sir Walter Raleigh's Troubles*, which was published in 1669.

RALEGH, or RALEIGH, Sir WALTER (c.1552-1618). An English courtier, navigator, and explorer. He was the son of Walter Raleigh of Fardell, near Plymouth, in Devonshire, and studied for a time at Oxford. In 1569 he was in the Huguenot army at the battle of Jarnac, and he seems to have spent some five years in France. In 1577 he was among the hangers-on at Court, and in 1578 he sailed with a small fleet belonging to his half-brother, Sir Humphrey Gilbert, upon an alleged 'voyage of discovery,' though the capture of Spanish galleons was probably the real object in view. During 1580-81 Raleigh was a captain in the Irish service, and was a member of a commission for governing Munster. Upon his arrival at Court with Irish dispatches in December, 1581, his handsome presence and address attracted the attention of Queen Elizabeth. Within a few years he had received appointments and grants which placed him among the most wealthy courtiers. As vice-admiral of the western counties of England, he was in constant touch with the buccaneering expeditions against Spain, which sailed under pretended commissions from the Prince of Condé or William of Orange. He invested heavily in Sir Humphrey Gilbert's unfortunate expedition to Newfoundland in 1583 and after the latter's death applied to the Queen for a continuation of his patent. The privileges obtained entitled him to fit out expeditions for a period of six years and to take possession of unknown lands, in the name of the Queen. In 1584 Raleigh sent Amadas and Barlow to find a place for a settlement. As the Queen refused to allow Raleigh to leave England, he fitted out an expedition consisting of seven ships which sailed in 1585 under the escort of his cousin, Sir Richard Grenville, and planted a settlement on Roanoke Island, on the Carolina coast, with Ralph Lane (q.v.) as Governor. In June, 1586, however, the settlement was abandoned. Grenville left a new party of colonists, which was reinforced by settlers from England in the year following under John White, but ships sent out by

Raleigh failed to reach the colony, and when, in 1590, a relief expedition finally arrived at Roanoke all trace of the settlement had disappeared. Although the colony was a failure, the enterprise resulted in the introduction of the potato and of tobacco into England.

During 1587 and 1588, when Spanish invasion was threatened, Raleigh was one of a commission to draw up a plan for the defense of the country, and performed important services in levying and forming the militia in the west of England. It is not probable that he took any part in the actions against the Armada. Raleigh was not, as is frequently stated, with Drake in the Portugal expedition, in 1589; but at that time was in Ireland, where his friendship with the poet Spenser was formed. In 1591 he was made second in command of an expedition under Lord Thomas Howard to intercept the Spanish plate fleet. Again the Queen refused to let him leave England, and his place was taken by Sir Richard Grenville. In 1592 another expedition was equipped. Raleigh had obtained permission to command in person, but was, at the last moment, recalled and imprisoned in the Tower, because of an intrigue with a maid of honor, Elizabeth Throgmorton, which had become known to the Queen. There he remained from July to September, when the expedition returned. Raleigh was permitted to marry, although forbidden to come to Court. In 1593 he sat in Parliament as member for Cornwall. In 1594 he sent out an expedition in search of El Dorado (q.v.), which he conceived to be situated in the interior of South America, upon the Orinoco, in the country then designated as Guayana, or Guiana. The effort was unsuccessful, and Raleigh determined to go himself. He fitted out five ships—chiefly at his own expense—and obtained a commission from the Queen to wage war against the Spaniards. He penetrated into the interior, going up the Orinoco a distance of more than 400 miles, but was obliged to return for supplies. Upon reaching England he published his *Discoverie of Guiana* (1596). He brought back quartz containing gold, and the first mahogany seen in England. An expedition was sent against Cadiz in 1596 in which Raleigh distinguished himself by gallantry in action. In 1597 he was one of the commanders of a fleet sent to the Azores to intercept the Spanish treasure-ships. Many valuable prizes were secured. The next few years were passed in administrative duties, as member of Parliament, and as Governor of Jersey.

For many years Raleigh had active and powerful enemies at Court, and although even Essex, Howard, and Cecil could not permanently discredit him in the eyes of Queen Elizabeth, he met with nothing but ill treatment at the hands of James I. His posts and grants of monopoly were withdrawn, and a few months after the King's accession (1603) he was sent to the Tower on the charge of being privy to the plots contrived against the King's person by Lord Cobham and the Spanish agent, Count Aremberg. He was condemned under the harsh procedure of *lesa majestas* trials, for failing to produce conspicuous proofs of innocence. A reprieve was granted, and his personal property restored, but he still remained a prisoner in the Tower until his petition to be allowed to lead another expedition to the Orinoco was granted, in 1616. The

Spanish Ambassador protested, and Raleigh was ordered not to engage in any hostilities against the Spaniards, on penalty of his life. He sailed on June 17, 1617, and encountered an unbroken series of misfortunes. During the voyage the Spanish settlement of San Tomas was attacked and destroyed. Upon his return to England he was at once arrested, and after some deliberation was executed, by virtue of the former sentence, on October 29, 1618. During his long imprisonment in the Tower he wrote the *History of the World*, one of the monuments of Elizabethan literature. He also wrote treatises on religious and philosophical subjects, and several poems of merit. The chief lives of Raleigh are those by William Stebbing (1891), Edmund Gosse (1886), and Edward Edwards (1868), who also published Raleigh's letters.

RALEIGH, rā'li. A city, the county-seat of Wake County, and the capital of North Carolina, 148 miles north-northwest of Wilmington; on the Southern and the Seaboard Air Line railroads (Map: North Carolina, D 2). It is situated at an elevation of about 320 feet, and has a number of fine buildings, the State Capitol occupying a prominent site in a small square near the centre of the city. Other noteworthy structures are the post-office, the Governor's mansion, State Insane Asylum, State Institution for the Blind with separate departments for white and colored, the State Penitentiary, and the State Geological Museum. Raleigh is noted for its educational institutions, which include the State College of Agriculture and Mechanic Arts, opened in 1889, Peace Institute (Presbyterian), Saint Mary's School (Protestant Episcopal), Raleigh Male Academy, and the Baptist Female University; and for colored students, Shaw University (Baptist), opened in 1865, and Saint Augustine's Normal School and Collegiate Institute (Protestant Episcopal). Among the libraries in the city are the Olivia Raney (public), with 6000 volumes; the State, having 35,000 volumes; and the Supreme Court, with more than 13,000 volumes. Pullen Park, and the Confederate and National cemeteries, the latter having 1207 graves, 572 of unknown dead, are also of interest.

Raleigh is a large cotton and tobacco market, and industrially is of considerable importance, its manufactures in the census year of 1900 representing an invested capital of \$1,611,000, and having products valued at \$2,204,000. The principal establishments include cotton mills, car and wheel works, phosphate works, foundries and machine shops, cottonseed-oil mills, flouring mills, wood-working mills, etc. The government is administered under a charter of 1899, which provides for a mayor, elected biennially, and a unicameral council that controls elections of subordinate officials, excepting the tax collector and city clerk, who are chosen by popular vote. Population, in 1890, 12,678; in 1900, 13,643. The site of Raleigh was selected as a location of the permanent capital of the State in 1792, and in the same year the city was laid out and named in honor of Sir Walter Raleigh. In 1794 the Legislature met here for the first time, and by acts of 1795 and 1803 Raleigh was incorporated. General Sherman occupied the city during a part of 1865. Consult Battle, *The Early History of Raleigh* (Raleigh, 1893).

RALEIGH, ALEXANDER (1817-80). An English Congregational minister. He was born in Scotland; educated at the Lancashire Independent College, Manchester; and after holding charges at different places became a pastor in London (1858), and so continued till his death. He was highly honored by his brethren, being chairman of the Congregational Union of England and Wales in 1868 and 1879, and their representative at the National Council of the American Congregational Churches (1865). He published numerous sermons and expositions, noted for their spiritual fervor and elevated diction. Consult his *Life* by his wife (London, 1881).

RALEIGH, Sir WALTER. See RALEGH.

RAL'LENTAN'DO (It., slackening). A musical term, abbreviated *rallent.*, or *rall.*, indicating a gradual relaxing or diminution of time.

RALPH, JAMES (c.1698-1762). An American poet and pamphleteer, born in Philadelphia, Pa. He became an intimate friend of Benjamin Franklin, whom he accompanied to London in 1725. There he tried to support himself by writing, but with little success. Pope satirized his poem *Night* (1728) in the *Dunciad*. Afterwards Ralph attached himself to the Prince of Wales, and used his pen to assist his friends the Whigs in every possible way. When George III. ascended the throne, he was given a pension. His works include: *Zeuma* (1729), a poem; *The Groans of Germany* (1734), a political pamphlet; *The Use and Abuse of Parliaments* (1744); *History of England During the Reigns of King William, Queen Anne, and George I.* (1744); and some poems, essays, and plays.

RALPH, JULIAN (1853-1903). An American author and journalist, born in New York City. He joined the staff of the *New York Daily Graphic* in 1875, but within a year he left it and was on the staff of the *New York Sun* until 1895, gaining a world-wide reputation as a correspondent. In 1896 he became London correspondent for the *New York Journal*, was with the Turkish armies during the Græco-Turkish War in 1897, and in 1899 went to South Africa as war correspondent for the *London Daily Mail*. Besides numerous magazine articles, his publications include: *Dutchman or German* (1889); *On Canada's Frontier* (1892); *Chicago and the World's Fair* (1893); *Our Great West* (1893); *People We Pass* (1895); *Dixie* (1896); *Alone in China* (1898); *A Prince in Georgia* (1899); *Toward Pretoria* (1900); *An American with Lord Roberts* (1901); *War's Brighter Side* (1901); and *The Millionairess* (1902), a novel.

RALPH ROISTER DOISTER. A comedy by Nicholas Udall, probably written between 1534 and 1541 for the Christmas entertainment at Eton, of which Udall at that time was headmaster. It was printed anonymously in 1566, the only copy of that edition being now in Eton Library, and Collier was the first to connect Udall's name with it about 1820. It is noteworthy as the first English comedy. Its humorous and life-like characters far surpassing the wooden figures of the Moralities and even the personages of Heywood's farces. Ralph Roister Doister, a hare-brained, vain, boastful fellow, is egged on in his courtship of Dame Custance, a rich London

city wife, by Merrygreek, who maliciously enjoys the diversion of a fool in love. Though she does not intend to accept Ralph, his pursuit makes trouble between Custance and her betrothed, Gawin Goodluck. The fool's chagrin is soothed by Merrygreek by flattering his vain delusion that the lovers fear him, and all ends well.

RALSTON, rā'l'ston, WILLIAM RALSTON SHEDDEN- (1828-89). An English Russian scholar, and the son of W. P. Ralston Shedden, who, after making a fortune in India, returned to England. He was prepared by a private tutor for Trinity College, Cambridge, where he graduated B.A. in 1850. Though subsequently called to the bar, he never practiced. To free himself from the odium attached to a prolonged lawsuit, begun by his father and continued by his sister, for the Ralston estates in Ayrshire, he added the name of Ralston to Shedden. Entering the printed-book department of the British Museum (1853), he rose rapidly. He learned Russian and traveled extensively in Russia, forming a close friendship with Turgenieff. Owing to ill health, he resigned his post in the British Museum after serving for twenty-two years. He contributed largely to the *Athenæum*, the *Saturday Review*, and other periodicals, and published *Krilloff and His Pables* (1868); a translation of Turgenieff's *Liza* (1869); *Songs of the Russian People* (1872); and *Early Russian History* (1874).

RAM (AS. *ram*, *ramm*, Ger. *Ramme*, battering-ram, OHG. *ram*, *rammo*, Ger. *Ramm*, male sheep), MARINE. It was evident to the ancients that a ship, if given a sufficient rate of speed, could deal the enemy's vessel a more disastrous blow than could any weapon then known, so that the use of the ram is as ancient as maritime war. The oar-propelled galley furnished requisite speed and control for ramming, and to further the efficacy of the craft of this sort they were furnished with beaks. The short ranges at which ancient weapons were dangerous were favorable to the use of the ram, and most of the celebrated actions of the galley were decided by it. But the advent of gunpowder rapidly effected a change. With the introduction of sail propulsion ramming was nearly given over, but when steam came to the front it reappeared in a form which soon reached its highest development. The ram, however, has never accomplished much except under special conditions, and it is now regarded as a very subordinate weapon in naval warfare. W. Laird Clowes has carefully tabulated all the cases of ramming or attempted ramming which have taken place in modern naval warfare, and he finds that: (a) when both vessels have had plenty of sea room and were able to steer not one of the thirty-two attempts to ram were wholly successful—indeed, the ships attempting to ram received slightly the gravest injuries; (b) where the ramming took place in waters which were too contracted to admit of free manœuvring (32 cases also), 28 per cent. of the vessels attacked by ramming were sunk, as were 3 per cent. of the attacking ships, while the percentages of the attacked vessels which were seriously injured was about double that of the ships attempting to ram. The torpedo and the greatly enhanced gun power of recently built ships both serve to weaken the influence of the ram upon naval operations, leaving its probable

effective use confined to unusual and special conditions.

It is difficult to determine who first suggested ramming by steam vessels. One of the earliest designs is that of Capt. Samuel Barron of the United States Navy, which was made in 1827 and a model of which is preserved at the Naval Academy, Annapolis. At this time, however, there was but one steam man-of-war in existence, and it was not until the Civil War broke out that attention was seriously attracted to the importance of ramming. The *Merrimac* was fitted with a ram with which she sank the *Cumberland*, and the *Monitor* was designed to use her sharp bow for ramming if opportunity offered. After the sinking of the *Cumberland* many war vessels were supplied with rams, and at present nearly all fighting ships are so fitted, but it is not expected that the use of the ram will be other than exceptional.

The marine ram as a special vessel designed to use its beak as its principal weapon of offense appears to have had few advocates after the time of Captain Barron's ram in 1827 until late in the Civil War. Admiral Ammen of the United States Navy was a strong advocate of the purely ram type of vessel, and one of his designs was embodied in the U. S. S. *Katahdin*. About 1880 the British built the torpedo ram *Polyphemus*, which is like the *Katahdin* in many respects. No other large ram vessels have been built which are not also well armed with guns.

Among naval officers the use of the ram is now regarded as the last resort—a weak ship endeavors to sacrifice herself in destroying a more powerful one; a ship whose battery is disabled attempts to destroy a still powerful enemy; or a ship which refuses to surrender is given the *coup-de-grâce*. In all this, however, the danger of the torpedo is to be faced, and that is commonly regarded as more to be feared than the ram.

BIBLIOGRAPHY. For further information, consult: "The Ram in Action and Accident," by W. Laird Clowes (*Proceedings of the United States Naval Institute*, whole No. 69, Annapolis, 1894); Elliot, *The Ram* (London, 1884); Bennett, *The Monitor and the Navy Under Steam* (Boston and New York, 1900); *Proceedings of the United States Naval Institute* (various articles); *Journal of the Royal United Service Institution*, particularly 1875, but also various later volumes, (London); Noel, *The Gun, Ram, and Torpedo* (Portsmouth, Eng., 1888).

RĀMA, rā'mā. In Hindu mythology, the name of the sixth, seventh, and eighth incarnations of Vishnu (q.v.), Parasurama, Ramacandra, and Balarama. Of these the Ramacandra avatar (see AVATAR) is by far the most famous, as Rama is here the hero of the Sanskrit epic of the *Rāmāyana* (q.v.).

RAMA, or MELCHORA. An interesting tribe formerly upon the Rama River on the Caribbean coast of Southern Nicaragua, and now gathered upon a small island in Bluefield lagoon. They are a detached tribe of the Changuinan or Dorasquean stock of the Isthmus of Panama. They are kept under subjection by the dominant Mosquito (q.v.), and are now on the verge of extinction, having numbered only about 250 persons in 1891, all Christianized by Moravian missionaries, and described as being of fine physique and great strength.

RAMADAN, rā'mā-dān' (Ar. *Ramaḍān*, from *ramiḍa*, to be burning hot). The ninth month in the Mohammedan year. Mohammed is said to have had his first revelation in Ramadan, and every Moslem is therefore enjoined to keep a strict fast during this month from dawn to sunset of every day, and to abstain from eating, drinking, smoking, bathing, smelling perfumes, and other bodily enjoyments. During the night, however, the most necessary wants may be satisfied, and this permission leads to nightly indulgences in all sorts of enjoyments. As the Mohammedan year is a lunar one, the months rotate through the different seasons, and the fast of Ramadan becomes a severe affliction upon the faithful when the month happens to fall in the hot days of the summer. The sick, travelers, and soldiers in time of war are temporarily released from this duty, though it must subsequently be performed during an equal number of days. Nursing and pregnant women, and those to whom it might prove really injurious, are exempted from fasting. During this month twenty additional prayers are said after the night prayer. Very pious believers seclude themselves and devote their time to the reading of the Koran. The fast is followed by the feast of Beiram (q.v.). In establishing this fast Mohammed seems to have been guided by the Christian institution of Lent, which in the early Church varied in length from four to six weeks. The principal passages treating of the fast of Ramadan are found in the Koran, sura ii. 179-184. Consult: Wellhausen, *Reste arabischen Heidentums* (Berlin, 1897); D'Herbelot, *Bibliothèque orientale* (Paris, 1781); and the commentaries on the Koran.

RAMAKA, rā-mā'kā. Another name for the Egyptian princess Hatasu (q.v.).

RAMAKRISHNA, rā'mā-krīsh'nā (1833-86). A celebrated Hindu yogi or ascetic. He was born at Kamarpukur, near Jahanabad, in Bengal, and was the youngest son of a poor Brahmanic family. At sixteen years of age he attended the school of his eldest brother, Ramkumar Chattopadhyaya, at Calcutta, and followed him when he was appointed priest to the temple of the goddess Kali, founded in 1853 at Dakshinesvara. He became a devotee of Kali, and began a course of twelve years of asceticism. The fame of his humility, sanctity, and wonderful teachings spread, and crowds of people of all classes, including Keshub Chunder Sen, fell under his spell. His conduct was characterized by great tenderness and humility, and his teachings were distinguished by simplicity and purity of language. Consult Müller, *Ramakrishna, His Life and Sayings* (New York, 1899).

RĀMĀYANA, rā-mā'yā-nā (Skt., story of Rama). The second of the two great epic poems of mediæval India. It is in the main the work of a single author, Valmiki. Herein lies the important distinction between it and the *Mahābhārata* (q.v.). Though all its parts are not from the same hand, and though it is not entirely free from digressions or episodes, the poem tells a connected story of great interest in epic diction of the highest order; it ranks with the great epics of the world, and is even to this day the favorite poem of the Hindus.

The central figures in the epic are Rama and his devoted wife, Sita; the main event, the con-

quest of Lanka (probably Ceylon). Daśaratha, the mighty King of Oudh (*Ayōdhya*), having grown old, announces in open assembly that he has decided to consecrate his oldest son, Rama, as his successor, and Rama is accordingly acclaimed joyously. But the intriguing second Queen of Daśaratha, Kaikeyi by name, induces her husband to change his resolution in favor of her son Bharata and to banish Rama for fourteen years. Rama accepts his fate with great dignity, and retires with Sita to the forest Dandaka. When King Daśaratha dies, his son Bharata is called to the succession, but he refuses to usurp Rama's throne, and seeks him out in the wilderness in order to conduct him back to the throne in his capital city. Rama in his turn refuses to cross his father's decision; he removes his gold-embroidered shoes, and presents them to Bharata as an outer token of his resignation of the throne. But Bharata on returning places Rama's shoes upon the throne and holds over them the yellow parasol, the sign of royalty; he himself stands by and acts as the King's plenipotentiary. Now Rama continues in the wilderness, and makes it his mission to fight the demons who molest the ascetics of the forest in their holy practices. Ravana, the king of the demons, who lives in Lanka, plans revenge. One of his demons, in the guise of a golden gazelle, places himself in sight of Sita, who, eager to possess it, sends Rama to hunt it. During his absence Ravana, in the garb of an ascetic, is admitted to Rama's dwelling, and kidnaps Sita. On returning Rama gives himself over to despair, until a mysterious voice tells him the way to overcome his enemies and to rescue Sita. He allies himself with Hanuman (q.v.) and Sugriva, kings of the monkeys. Hanuman succeeds in finding Sita in Lanka, and the monkeys build a wonderful bridge from the mainland. Rama leads his army across, slays Ravana, and is reunited with Sita. They return home, and Rama, conjointly with Bharata, rules his happy people, so that the golden age has again come upon the earth.

The Ramayana consists of seven books in about 24,000 verses. Notwithstanding the essential unity of the entire epic, the first and last books are in a certain sense secondary. The first deals with Rama's youth up to his marriage with Sita; the last with Rama's life from his restoration to his death. In these Rama is apotheosized and identified with the god Vishnu (q.v.) as one of his incarnations. The main body of the epic (books ii.-vi.) deals with Rama as a national hero, the embodiment especially of the ethical ideals of the people. But the Rama-Sita story itself, notwithstanding that it presents itself outwardly as an heroic legend, is justly under the suspicion of containing one or more mythic roots, though the exact formulation and explanation of them is perplexing. In the Veda Sita (q.v.) is the personified furrow of the plowed field, the beautiful wife of Indra or Parjanya. Hence Rama has been identified with Indra (q.v.), the slayer of demons, especially of the demon Vritra. In the epos Ravana is supposed to have taken the place of Vritra. According to another interpretation, the legend is a mixture of culture and nature myth, typifying the spread southward toward Ceylon of Brahmanical civilization. The demons who disturb the ascetics in their holy practices are the barbarous tribes

who oppose Aryan culture. In any case, these mythical and other motives cannot have served as more than mere suggestions for the great story.

The Ramayana exists in three recensions which differ from one another in their reading, in the order of their verses, and in having each more or less lengthy passages that are wanting in the others. The best known and most popular of these is also the most original version of the poem. Its home is in the northwest and south of India; it has been edited a number of times in India, and is most accessible in the second Bombay edition of 1888. The second recension is at home in Bengal; it has been edited by the Italian scholar Gaspare Gorressio, who added to his edition a somewhat free Italian translation in poetical prose (Paris, 1843-70). The third recension apparently at home in the west of India is as yet unpublished, but is accessible in manuscripts at Berlin and Bonn. The poetic translation of the Anglo-Indian scholar Griffith in five volumes (Benares (1870-75) is based upon the first recension. Consult: Weber, *Ueber das Rāmāyana* (Berlin, 1870); Jacobi, *Das Rāmāyana* (Bonn, 1893); Ludwig, *Ueber das Rāmāyana und die Beziehungen desselben zum Mahābhārata* (Prague, 1894).

RAMBAUD, rān'bō', ALFRED NICOLAS (1842-). A French historian, born at Besançon. He was a pupil of the Ecole Normale, and after receiving his degree in 1870 traveled in Russia, and taught history at Caen and Nancy (1871-79). He was chief of a department in the Ministry of Public Instruction in Ferry's Cabinet in 1879-81, and held the portfolio of Public Instruction in the Méline Cabinet in 1896-98. He became professor of contemporary history at the Sorbonne in 1883, and was elected to the Academy of Moral Sciences in 1897. His works include: *La domination française en Allemagne. Les Français sur le Rhin 1792-1800* (1873); *La Russie épique* (1876); *Histoire de la Russie* (1878, translated by Lang as *A History of Russia*, 1879); *Histoire de la civilisation française* (1887); *Histoire de la civilisation contemporaine en France and Histoire de la Revolution française, 1789-1799* (1895). With Lavisse he directed the publication of the *Histoire générale du IVme siècle à nos jours* (1893-96).

RAMBAUT, ARTHUR ALCOCK (1859-). An English astronomer, born in Waterford and educated at Trinity College, Dublin. He was assistant in astronomy there from 1882 to 1892, when he became royal astronomer of Ireland; and in 1897 he was appointed Radcliffe observer at Oxford. His valuable astronomical papers are to be found in *Transactions* and *Proceedings* of the Royal Society, of the Royal Dublin Society, of the Royal Irish Academy, and of the Royal Astronomical Society.

RAMBERG, rām'bērk, ARTHUR, Baron (1819-75). A German genre painter and illustrator, born in Vienna, son of Georg Heinrich von Ramberg (1786-1855, a distinguished general), and grand-nephew of Johann Heinrich Ramberg (1763-1840, Court painter at Hanover, illustrator, and etcher, whose drawings, of which the Leipzig Museum preserves an extensive collection, were exceedingly popular in his day). Ramberg received his first training at the School

of Art in Prague from Franz Kadlik and others, then studied in Dresden (1844) under Julius Hübner, and passed through a subsequent formative stage under the influence of Schwind, whose romantic trend is apparent in the "Wedding Song" (after Goethe) and other works. His great coloristic talent was, however, most successfully displayed in some characteristic scenes from rural life, such as "Women of Daehau on Sunday" (1853), "Morning Devotion in the Mountains" (1855, New Pinakothek), "Walk with the Tutor" (1856), in little humorous episodes like "Hide and Seek," "After the Masked Ball" (1858), and in the idyllic "Meeting on the Lake" (1876), and "Invitation to Boating" (1879), all breathing an atmosphere of ideal beauty. The same refined sentiment and a rare delicacy of technique suggestive of the artist's thorough study of the Dutch masters, characterize the "Reading from Wieland" and the concertino in Terborch's manner "After Dinner" (1873, New Pinakothek). In 1860 Ramberg was appointed professor at the School of Art in Weimar, where he executed the historical painting "Court of Emperor Frederick II. at Palermo" (1866, Maximilianum, Munich), collaborated with Pauwels in the decoration of the Luther room at the Wartburg, and painted the "Fairy Tale of the Frog King" (Weimar Museum). It was, however, as an illustrator of the German classics that he earned his greatest fame, notably with the drawings for Cotta's jubilee edition of Schiller's poems, those for the "Schiller and Goethe Galleries" (with Pecht), but above all with the cycles of grisailles to Goethe's *Hermann und Dorothea* and to Voss's *Laise*. In 1866 Ramberg became professor at the Munich Academy. Consult: Pecht, *Deutsche Künstler*, etc., iv. (Nördlingen, 1885), and Rosenberg, *Geschichte der modernen Kunst*, iii. (Leipzig, 1889).

RAMBLER, THE. A periodical published twice a week from 1750 to 1752, by Dr. Samuel Johnson, who wrote all the numbers but five. These ponderous essays and observations on life and manners had a remarkable influence on English morals and language in their day, showing the force of a strong judgment and a noble nature, even through an unwieldy vehicle.

RAMBOUILLET, rān'bōō'yā', HÔTEL DE. The house which, toward the middle of the seventeenth century, was the most famous meeting-place of the cultivated society of Paris. The house itself had previously been known as the Hotel Pisini, the residence of the Marquis of that name, whose daughter, Catherine de Vivonne, received it as a part of her dowry on her marriage in 1600 with the future Marquis de Rambouillet. Dissatisfied with the style of the house, she had it entirely remodeled between 1610 and 1617. After its completion the young beauty, weary of the crowded assemblies of the Louvre, decided to remain at home and make her own house supply all the society she desired. Here, for a generation, assembled the most brilliant coterie in Paris, known, from their insistence on refinement in speech and manners, as *précieuse*. Among early frequenters were Richelieu, Malherbe, Balzac, Corneille, Racan, Voiture, and, somewhat later, Bossuet, Ménage, Chapelain, Scarron, Saint-Evremond, Benserade, and La Rochefoucauld. There too were trained the ladies

who were to found literary salons in their turn, Madame de la Fayette, Madeleine de Scudéry, the Duchess of Longueville, and Madame de Sévigné. Its influence was altogether refining, but it led in some to an exaggeration which resulted in a most ludicrous affectation. It must be borne in mind that Molière, in his *Précieuses ridicules*, was satirizing not this accomplished group, but the exaggerations of their pedantic imitators. From a little before 1620 the society which assembled here represented all that was best and brightest in the social life of the time. Its lustre began to decline after the marriage (in 1645) of the daughter of the house to the Duc de Montausier; and the troubles of the Fronde, the death of M. de Rambouillet in 1652, and his wife's increasing age and infirmities put an end to it. To the movement begun by Madame de Rambouillet is to be attributed an enrichment and purification of the literary and polite language, which gained in precision and flexibility and was thus differentiated sharply from every-day speech. From her came also an improvement in the social position of women, and in the forms of good conversation, in which France has ever since excelled. Consult: Vincent, *The Hôtel de Rambouillet* (Boston, 1900); Cousin, *La société française au XVII^e siècle* (Paris, 1858); Livet, *Précieux et précieuses* (ib., 1859); Roederer, *La société polie en France pendant le XVII^e siècle* (ib., 1834); and Somaize's curious *Grand dictionnaire des précieuses* (ib., 1661; new ed. 1856).

RAMBOV, râm-bôf'. A town in Russia. See OBANIENBAUM.

RAMEAU, rà'mó'. JEAN PHILIPPE (1683-1764). A famous French composer and organist, to whom is really due the foundation of the modern science of harmony. He was born of a musical family at Dijon. He studied the organ under Marchand in Paris and became organist at Lille and at Clermont. His theories of the relationship of sounds he published in 1721, under the title of *Traité de l'harmonie*, and in 1726 he published *Nouveau système de musique théorique*. The main points of his new harmonic theory were the reduction of all possible chords to a limited number of fundamental chords, resting upon an imaginary 'fundamental bass,' which was not the same as thorough or general bass, but a series of root tones which underlie the various chord-progressions. He employed the building up of chords in thirds, and made great use of inversions. These theories received the formal approval of the Academy in 1737, and had much to do with the development of theoretical music. His dramatic composition *Samson*, with a libretto by Voltaire, was rejected at the Opéra on account of its biblical subject. His second attempt, *Hippolyte et Aricie*, obtained a hearing in 1733, but was not immediately successful, and he was tempted to abandon dramatic composition. His next effort, the operaballet *Les Indes galantes* (1735), won public favor. *Castor et Pollux* (1737) is usually considered his best work. Other operas followed in quick succession and held the French stage for a generation, besides winning for him from Louis XV. the title of Court composer, especially created for him. His other compositions include: *Les talents lyriques* (1739); *Dardanus* (1739); *La princesse de Navarre* (1745); *Zais* (1748);

Pygmalion (1748); *Platée* (1749); *Daphné et Eglé* (1753); *Zéphire* (1757); *Les surprises de l'amour* (1759); *Les Paladins* (1760). He wrote several books of compositions for the clavier which were reprinted in 1861. As developments of his operatic works for the stage he produced *Génération harmonique* (1737) and *Démonstration du prince de l'harmonie*, and on the vogue which these operas enjoyed his chief title to fame rests. His services to music were acknowledged by the erection of a statue to him in his native town in 1880. Consult Pougin, *Rameau, sa vie et ses œuvres* (ib., 1876).

RAMÉE, rà'má'. LOUISE DE LA (better known under her pen-name—OUIDA (1840—)). An English novelist, born at Bury Saint Edmunds. Her father was English, her mother French. When about twenty years old she went with her mother and grandmother to London, where she began to write for periodicals under the name of 'Ouida,' her own childish mispronunciation of 'Louisa.' Her first novel, *Held in Bondage* (1863), was followed by *Strathmore* (1865); *Chandos* (1866); *Idalia* (1867); *Under Two Flags* (1867), dramatized and often played; *Tricotrín* (1869); *Puck* (1870); *A Dog of Flinders* (1872); *Pascarel* (1873); *Two Little Wooden Shoes* (1874); *Ariadne, the Story of a Dream* (1877); *Friendship* (1878); *Moths* (1880); *The Village Commune* (1881); *In Maremma* (1882); *Bimbi; Stories of Children* (1882); *Wanda* (1883); *Othmar* (1885); *Guilderoy* (1889); *Syrlin, Ruffino* (1890); *The Silver Christ* (1894); *Two Offenders* (1894); *Le Selve* (1896); *The Massareenes* (1897); *Toxin* (1897); *La Strega* (1899); and *Street Dust* (1901). Her varied contributions, always interesting, to the magazines, she has published from time to time as *Views and Opinions* (1895) and *Critical Studies* (1900). In after years she lived near Florence. Her novels, though tawdry in sentiment, exhibit picturesque power and striking dramatic effectiveness.

RAMENGIHI, rà-mén'gè. The real name of the Italian painter commonly known as Bartolommeo da Bagnacavallo (q.v.).

RAMESSES, or **RAMSES** (Gk. *Ῥαμῆσσης, Rhamesés, Ῥάμης, Rhampsés*). The name of twelve kings of Egypt of Dynasties XIX. and XX.

RAMESSES I., the first King of Dynasty XIX., ruled for a brief period about B.C. 1355. Beyond the fact that he waged war in Nubia, where he left an inscription, and constructed some of the buildings at Karnak, little is known of his reign. His mummy was found, in 1881, at Deir-el-Bahri. His son, Seti I. (q.v.), built the Memnonium at Karnak (q.v.) in honor of his father's memory.

RAMESSES II. (c. 1340-1273 B.C.), the son of Seti I. and the grandson of Rameses I., was the *grand monarch* of Egypt, the Sesostris of the Greeks. The earlier portion of his reign was spent in war with the Cheta or Hittites who occupied the former Asiatic possessions of Egypt as far south as the northern border of Palestine. In his second year he reconquered Phœnicia as far as Berytus, and left a memorial inscription on the banks of the Nahr-el-Kelb. In his sixth year he moved against the important city of Kadesh on the Orontes, but, though he was successful in an engagement with the enemy's chariot force, no decisive result was obtained and

the city did not surrender. In the fighting around Kadesh, Rameses, with a detachment of his troops, was cut off from the main body, and was for a time in personal danger. His exploits on this occasion form the theme of the so-called poem of Pentaur (q.v.), in which they are celebrated with gross exaggeration. The war continued with varying success for a number of years, but finally a peace was arranged by the terms of which Egypt retained Phœnicia as far as Byblus and a strip of territory to the north of Palestine. In his twenty-first year Rameses concluded an offensive and defensive alliance with the King of the Hittites and cemented it by marrying his daughter. The remainder of Rameses's long reign was peaceful, and is chiefly remarkable for the large number of important edifices constructed by the King, who, as a builder, surpassed all other Pharaohs. Among the many splendid temples created or added to by him those of Abu Simbel, Karnak, Luxor, Abydos, Memphis, and Bubastis, and the Ramesseum at Thebes deserve special mention. Rameses also usurped many monuments of his predecessors, cutting away their names and inserting his own name in their stead. By his many wives and concubines he had a numerous progeny, 162 of his children being mentioned by name on the monuments. He died after a reign of 67 years, and his mummy, at first buried at Bibân-el-Mulûk, was subsequently concealed from grave robbers in the shaft at Deir-el-Bahri, where it was found in 1881. Rameses II. was formerly regarded as the Pharaoh of the Oppression, and his son, Mer-en-Ptah, as the Pharaoh of the Exodus; see, however, the section on ancient history under EGYPT.

RAMESES III., the second Pharaoh of Dynasty XX., reigned for 33 years from about 1230 B.C., or perhaps a little later. In the fifth year of his reign he expelled the Libyans who had taken advantage of the weakness of Egypt at the end of Dynasty XIX. to establish themselves in the western part of the Delta. In the eighth year of his reign he attacked and made tributary the piratical Pula-stæ or Philistines, who had recently effected a settlement in Palestine and were making incursions into the Delta. Three years later he repelled a Libyan invasion, and in his twelfth year he raided the Amorite district north of Palestine. From this campaign he brought back rich booty which he lavished upon the temples of Egypt, and especially upon the national sanctuary of Ammon of Thebes. He made, however, no permanent conquests in Asia, and Egyptian influence in that quarter soon sank to a very low ebb.

Rameses III., like Rameses II., was a great builder. The great temple of Medinet Habu (q.v.) is his work, and he restored, or made additions to, temples in many parts of Egypt. The King's mummy was among those found at Deir-el-Bahri in 1881. He was followed by nine kings of little importance, all bearing the name of Rameses (RAMESES IV.-VII.), whose reigns mark a steady decline in the affairs of Egypt. Through the enormous wealth lavished upon the temples by many successive Pharaohs, the ecclesiastical interest had by this time attained a preponderating influence in the State, and the feeble successors of Rameses III. were mere puppets in the hands of the pow-

erful priesthood of Ammon. Finally, about B.C. 1100, Heri-hor, the high priest of Ammon of Thebes, dethroned Rameses XII. and made himself King in name as well as in fact. Consult: Wiedemann, *Ägyptische Geschichte* (Gotha, 1884-88); E. Meyer, *Geschichte des alten Ägyptens* (Berlin, 1887); Budge, *A history of Egypt* (New York, 1902); Müller, *Der Bündnisvertrag Rameses' II. und des Chetiterkönigs* (Berlin, 1902); *Die alten Ägypter als Krieger und Eroberer in Asien* (Leipzig, 1903).

RAMESESE'UM (Neo-Lat., from *Rameses*). A temple built by Rameses II. on the west bank of the Nile at Thebes and dedicated to the god Ammon. The temple is now in a ruined condition. The entrance is formed by a great pylon of which the inner face is well preserved and is covered with sculptures representing scenes from Rameses's Syrian campaigns. The outer court was originally inclosed by a wall and had a colonnade on either side. At the upper end, near the entrance to the inner court, lie the broken fragments of a colossal statue of Rameses II. The inner court was colonnaded on all four sides and the upper end is a terrace leading to the great hypostyle hall, which in plan resembles that of Karnak (q.v.). Sculptures on the southern half of the east wall represent the storming of a Hittite fortress in which Rameses and his sons take part. Consult: Lepsius, *Denkmäler* (Berlin, 1849-58); Wilkinson, *Topography of Thebes* (London, 1835); Mariette, *Monuments of Upper Egypt* (ib., 1877); Dümichen, *Geschichte des alten Ägyptens* (Berlin, 1878); Quibell, *The Ramesseum* (London, 1898).

RAMESWARAM, rä-mös-wü-rüm', or **RAMISSERAM**. A small island in the Gulf of Manar, forming the western end of the line of black rocks stretching from the Indian Peninsula to Ceylon and known as Adam's Bridge (Map: India, C 7). It is low and sandy and covers an area of 53 square miles. A temple here is believed to have been founded by Rama and has been visited for centuries by pilgrims from all over India. The chief town is Pambam, at the western end. The population of the island in 1891 was 17,854, chiefly Brahmins.

RAMIE (Malay name), *Boehmeria tenacissima*, or *nirca*; CHINA GRASS. A nettle-like but



RAMIE.

non-stinging East Indian shrub of the natural order Urticaceæ. The upright stems produced by the perennial rootstock furnish one of the most

durable of vegetable fibres. It is stronger than hemp and almost equals silk in fineness and lustre. The fibre is highly valued for making cordage, nets, various fabrics, and paper which is especially esteemed for banknote making. The plant requires a hot, moist, equable climate and a rich damp soil. It is propagated by seeds, cuttings, layers, and division. When the leaves can be readily stripped off, the stems are harvested and the fibres removed by machinery or, either before or after boiling in chemicals, by hand—either process being costly or otherwise unsatisfactory. The crop can be raised in the Southern United States, but the cost of obtaining the fibre is against the establishment of the industry, and foreign fields are relied upon to supply American needs. Consult: Special United States Consular Report No. 15, pt. i., *Promotion of Ramie Industry*; United States Senate Documents, Nos. 47 and 57, Fifty-fourth Congress, second session. See *BEHMERIA*; Colored Plate of FIBRE PLANTS, accompanying article HEMP.

RAMILLIES, rá'mé'yé'. A village of Brabant, Belgium, 13 miles north of Namur, and 28 miles southeast of Brussels (Map: Belgium, C 4). It is memorable as the place near which, on May 23, 1706, one of the most important battles of the War of the Spanish Succession was fought. The French forces were under the command of Marshal Villeroy and the Elector of Bavaria, while Marlborough led the troops of the allies. Villeroy, after a battle of three hours and a half, was defeated, with the loss of almost all his cannon, the whole of his baggage, and 13,000 men in killed and wounded, the loss of the allies being only about 3500.

RAMISSERAM, rá-mís'sér-üm'. An island between India and Ceylon. See *RAMESWARAM*.

RAMLER, räm'lér, KARL WILHELM (1725-98). A German poet, born at Kolberg. He studied theology at the University of Halle, and afterwards devoted himself to literature. In 1748 he was made professor at the Military Academy of Berlin, where he lectured on logic and literature. The first of his verse was published in the *Bremische Beiträge*, and he came to be considered a master of poetical diction. King Frederick William II. nominated him member of the Berlin Academy of Sciences, granted him a pension of 800 thaler per annum, and appointed him assistant director of the National Theatre in 1790, the sole director of which he was from 1793 to 1796. His fame as lyrical poet Ramler established by his edition of *Lieder der Deutschen* (1756), which he remodeled to a certain extent, and afterwards increased and reëdited as *Lyrische Blumenlese* (1774-78). Together with Lessing he published a selection of Logaus's epigrams (1759). He was a rigid adherent to the so-called classical models, and imitated Horace. By his correct translations and elegant style Ramler exerted great influence on the development and refinement of the German language, and he is regarded as the creator of the art of translating into German. His other writings include: *Sammlung der besten Sinngedichte der deutschen Poeten* (1766), and *Kurzgefasste Mythologie* (1790).

RAMMAN, räm'mán. A deity of the Babylonian pantheon, and also a Syrian god, probably

to be identified with the Babylonian Adad and the Syrian Hadad. Ramman, whose name, from a Babylonian root, means 'the roarer,' is the storm-deity. The name occurs rarely (with certainty) in Babylonian, but is found several times in the Old Testament under the corrupt form *Rimmon*, for *Rammon*. According to II. Kings v. 18, he was the chief deity of Damascus; the name also appears in the proper name Tabrimon (I. Kings xv. 18), and probably in several Palestinian place-names. This word was once generally read in a number of famous Assyrian names e.g. Ramman-nirari III. (fl. 800 B.C.), but since 1899 such a name is read Adad-nirari. We have then the equation of Ramman with Adad, the former being an old Babylonian deity, while the latter may have entered Mesopotamia from Syria. As the storm-god, Adad-Ramman is the deity presiding over the rainy season and floods, is the genius of the battle-onslaught, and is even a god of oracles. He carries the thunderbolts and the battle-axe, and is symbolized by the bull. In the Syrian sphere Adad appears under various names, Hadad, Addu, Daddu, the name being preserved in the biblical names Hadad and Ben-hadad. Hadad is likewise a storm-god, and was the chief in the Syrian pantheon, his cult extending from Aleppo and Singiri to the south of Damascus. In Zechariah xii. 11 occurs the obscure expression Hadad-rimmon, used of either a deity or a place named after a deity; whatever the term means, it is in line with the identification of Hadad and Rimmon. Consult: Jastrow, *Religion of Babylonia and Assyria* (Boston, 1898); Zimmern and Winckler in Schrader, *Keilinschriften und das alte Testament* (Berlin, 1902); Baethgen, *Beiträge zur semitischen Religionsgeschichte* (ib., 1888).

RAMMELSBERG, räm'méls-bérk, KARL FRIEDRICH (1813-99). A German chemist and mineralogist, born in Berlin. He studied in the University of Berlin, became a professor there in 1845, and taught also in the Royal Industrial Institute and the Academy of Mines. His specialty was mineralogical chemistry, and he also contributed greatly to analysis. His chief works include: *Handwörterbuch des chemischen Theils der Mineralogie* (1841, and often); *Lehrbuch der Stöchiometrie* (1842); *Chemische Metallurgie* (1850); 2d ed. 1865); *Kristallographische Chemie* (1855-57); *Elemente der Kristallographie* (1883); and *Chemische Abhandlungen* (1888).

RAMMOHUN ROY, rá-mó'hūn roi (1772-1833). A Hindu raja, scholar, and theist, the founder of the Bralmo-somaj (q.v.). He was born at Bordnan, Bengal, of a high-caste Brahman family. He received a good native education, acquired some knowledge of Persian, and at Patna and Benares studied Sanskrit works on Hindu law, literature, and religion. His religious views aroused the antagonism of his family and of his community, and in his two or three years' residence in Tibet he also gave offense by his denial that the Lama was the creator and preserver of the world. Becoming convinced that the English sway was beneficial to India, he applied himself to the study of the English language. For five years he held the office of revenue collector in the District of Rangpur. He published various works in Persian, Arabic, and Sanskrit, their

object being the uprooting of idolatry, and he was instrumental in procuring the abolition of suttee (q.v.). Becoming convinced of the excellence of the moral theories of Christianity, he published *The Precepts of Jesus, the Guide to Peace and Happiness* (1820), a work of Unitarian tendencies. In 1830 was opened the first building in the Brahma-Somaj or Theistic Church of India, which he had inaugurated and endowed. Shortly afterwards, as representative of the titular King of Delhi, who had created him a raja, he visited England. He was deluged with invitations to social, political, and ecclesiastical meetings, and in his anxiety to see everything and to please all, overtaxed his strength and died of brain fever at Bristol, where he is buried. Consult Carpenter, *The Last Days of Raja Rammohun Roy in England, with Biographical Sketch* (London, 1866).

RAMNES, rām'nēz, or **RAMNENSES**, rām-nēn'sēz. One of the three patrician tribes—Ramnes, Tities, and Luceres—which in the oldest times constituted the *populus Romanus*.

RAMOTH-GILEAD, rām'mōth-gil'ē-ād. One of the chief cities of Gad, east of the Jordan. It is called Ramoth in Gilead and in II. Kings viii. 29 Ramah; the Gilead of Iosea vi. 8 and Judges x. 17 may mean the same place. It is mentioned as a city of refuge and a Levitical city (Deut. iv. 43; Josh. xx. 8; xxi. 38), and as the headquarters of one of Solomon's commissarial officers (I. Kings iv. 13). It was a strong fortress and the key to an important district. Abab, King of Israel, was killed there in the wars with the Syrians (I. Kings xxii.), and his son Joram was wounded there some years later (II. Kings viii. 28). Reimun in the hills of Gilead, Es-Salt, and Jerash have been suggested as possible identifications of Ramoth-Gilead; the weight of the evidence seems to be in favor of the last named. Consult Merrill, *East of the Jordan* (New York, 1881).

RAMPANT (Fr., raging). In heraldry (q.v.), a term applied to a lion or other beast of prey when erect on its two hind legs, with only one of the fore-legs elevated, the head being seen in profile. Sometimes also termed counter-rampant.

RAMPART. See FORTIFICATION.

RAMPOLLA, rām-pōll'ā, MARIANO, Marchese del Tindaro (1843—). An Italian prelate, born at Polizzi, Sicily. He was educated at the Collegio Capranica, the Jesuit College, and the Accademia dei Nobili Ecclesiastici, all in Rome. Afterwards he entered the service of the Pope, and in 1875 was appointed counselor to the Papal Embassy at Madrid. Upon his return to Rome he became Secretary of the Propaganda for Eastern Affairs, and in 1880 Secretary of Ecclesiastical Affairs. In 1882 he was made Papal Nuncio at Madrid, and it was he who suggested the Pope as arbitrator between Spain and Germany in the dispute over the Caroline Islands in 1885. In 1887 he was created cardinal and made Secretary of State to the Pope. This difficult position brought him into contact with the Italian Government, especially during Crispi's Premiership, against the penal laws directed particularly against the clergy aroused the anxiety of the Vatican. His aim, pursued with considerable vigor, was to strengthen French

sympathies for the Holy See, and in this endeavor he antagonized Germany and Austria. On the death of Leo XIII. he was considered one of the leading candidates for the succession.

RAMPUR, rām-pōōr'. A native State, feudatory to the United Provinces of Agra and Oudh (q.v.), British India, having an area of 945 square miles. Population, in 1901, 532,067.

RAMPUR. The capital of the native State of the same name, British India, on the Kosila River, 38 miles northwest of Bareilly, with which it is connected by rail (Map: India, C 3). It has a military cantonment. The manufacture of pottery and damask is an important industry. Population, with cantonment, in 1891, 76,733; in 1901, 78,758.

RAMSAY, rām'zī, ALLAN (1686-1758). A Scotch poet, born at Leadhills in the parish of Crawford, Lanarkshire, October 15, 1686. His father was manager of Lord Hopetoun's mines at Leadhills, and his mother, Alice Bower, was the daughter of a Derbyshire miner. He received the ordinary education of a parish school. In his sixteenth year he was apprenticed to a wig-maker in Edinburgh, and soon married (1712) and set up for himself. In 1716, or a little later, he gave up wigmaking and began business as bookseller, first in High Street, under the sign of the Mercury, and afterwards in the Lucken-booths, under the heads of Drummond and Ben Jonson. Here he added to his business a circulating library, the first in Scotland. Care and industry enabled Ramsay to prosper in all his undertakings but one. In 1736 he built a theatre in Carrubbers Close. In the following year the licensing act, prohibiting all dramatic exhibitions without a special license, compelled him to close his theatre. In 1755 he built a quaint and picturesque house on the north side of Castle Hill, where he died, January 7, 1758.

Ramsay's earliest poems were written for the entertainment of the Easy Club (1712-15). After setting up as a bookseller, he issued many short humorous pieces, printed as broadsides and sold for a penny each. In 1716 he published the old Scotch poem *Christ's Kirk on the Green*, adding a canto of his own, and two years later still another canto. This was followed by a volume of *Scots Songs* (1719). By this time he was writing in the Horatian manner verse epistles to his friends. His first important publication was a collected edition of his poems in 1721, on which he realized 400 guineas. There followed *Fables and Tales* (1722); *The Fair Assembly* (1723); *Health* (1724); *The Tea-table Miscellany*, an anthology of Scotch and English songs (vol. i., 1724; vol. ii., 1725; vol. iii., 1727; vol. iv., 1740); *The Evergreen*, a Scotch anthology, containing his own *Vision* (1724); a pastoral drama, entitled *The Gentle Shepherd* (1725), to which songs were added (1728); a second collection of poems (1728); and *Thirty Fables* (1730). Ramsay's tales and fables are amusing, but coarse. His verse epistles are neat and graceful. His many songs, as *The Yellow-hair'd Laddie*, are the best before Burns. His finest longer lyric is *The Vision*. *The Gentle Shepherd*, which reached its tenth edition by 1750, was long held to be the best pastoral comedy ever written. It certainly marks an epoch in English pastoral poetry—the transition from the artificiality of Pope's pastorals to real life, treated lightly and

humorously. Consult: Smeaton, *Life* (Edinburgh, 1890); *Poems*, edited with a *Life*, by Chalmers, 1800; reissued and revised, Paisley, 1877; and *Poems*, selected, by Robertson (London, 1887).

RAMSAY, ALLAN (1713-84). A Scotch portrait painter, the son of Allan Ramsay of *Gentle Shepherd* fame. He was born in Edinburgh, and studied there and in London and in Rome. In 1767 he was made Court painter to George III. His brush could not begin to keep up with the demands made upon it, and he employed several assistants. Besides the King and Queen, whom he painted repeatedly, some of his famous sitters were Lord Bute, Gibbon, Chesterfield, Hume, Rousseau, and his wife. The three last-named canvases are in the Edinburgh National Gallery. The portrait of his wife is his masterpiece, and for beauty and workmanship rivals Reynolds. His works are said to have been excellent likenesses, and are natural and unaffected.

RAMSAY, Sir ANDREW CROMBIE (1814-91). A Scotch geologist, born in Glasgow. His education at the grammar school in that city was interrupted in 1827 by the death of his father, a manufacturing chemist, who had made several important discoveries, but had patented none of them. The family was left almost without provision, and Andrew entered a counting house, and in 1837 attempted business as a dealer in calico and linen. By 1840 this project had proved a failure, but in the following year, at 9d. a day, he was appointed assistant to the Geological Survey, with which he was connected until 1881, becoming local director for Great Britain in 1845, senior director for England and Wales in 1862, and director-general in 1871. Upon retiring from active service in 1881 he was knighted. In 1847 he had been appointed to the chair of geology in University College, London, and in 1851 received a like position in the Royal School of Mines. He was president of the Geological Society in 1862-64; became a fellow of the Royal Society in 1862; received the Neill Prize from the Edinburgh Royal Society in 1866, the Wollaston medal of the Geological Society in 1870, and in 1880 a Royal Society medal. He was a good lecturer, something of an improvisator, and an ardent lover of English poetry. His rather typical Celtic nature made him over hasty in judgment at times, and as a geologist he was a stratigrapher at the expense of paleontology or petrography. His most valuable work on glacial formations, *Old Glaciers of North Wales and Switzerland* (1860), was followed by a series of popular lectures, *Physical Geology and Geography of Great Britain* (1864; 6th ed. 1894); *Rudiments of Mineralogy* (3d ed. 1885); and *Historical Geography of Asia Minor* (1890). The theory with which he was most closely identified is that many lake basins are the result of glacial excavations. Consult Geikie, *Memoir* (London, 1895).

RAMSAY, ANDREW MICHAEL (1686-1743). A Scotchman who became a Roman Catholic in France, where he was known as the Chevalier de Ramsay. He was born at Ayr, the son of a baker, studied at the University of Edinburgh, and became a tutor in a nobleman's family. Being preoccupied with religious questions, he sought the leading theologians of his own coun-

try and also those of Holland, whither he went attached to the English army during the War of the Spanish Succession. He became acquainted with the mystic Poiriet, and visited Fénelon in France in 1710, and by them was led to adopt the Roman Catholic faith. He remained with Fénelon until the latter's death in 1715, inherited the papers of his distinguished mentor, and became his biographer. After Fénelon's death Ramsay became tutor to the Due de Châteaui-Thierry, and later went to Rome to act as tutor to the two sons of the Pretender, James Francis Edward. In 1730 he visited England and was made a member of the Royal Society. After his return to Paris he became tutor to the Vicomte de Turenne. His works, composed in good French, won him considerable popularity, but are now almost wholly forgotten. Among them are: *Discours de la poésie épique*, originally printed as preface of *Telemaque* (1717); *Essai philosophique sur le gouvernement civil* (1721); *Vie de Fénelon* (1723), translated into English by N. Hooke; *Le psychomètre, ou réflexions sur les différents caractères de l'esprit, par un milord anglais*, an essay dealing with Lord Shaftesbury's *Characteristics*; *Les voyages de Cyrus, avec un discours sur la mythologie des païens* (1727); *Poems* (1728); *Plan of Education for a Young Prince* (1732); *L'histoire du Vicomte de Turenne* (1735).

RAMSAY, DAVID (1749-1815). An American physician and author. He was born in Pennsylvania and settled in practice in Charleston, S. C., in 1773. He served as field-surgeon in the Continental Army during the Revolution. He became member of the State Legislature, 1776; was a member of the Council of Safety at Charleston, and was a prisoner of the British at Saint Augustine, Fla., 1780-81; from 1782 to 1786 he was a member of the Continental Congress, and its president, 1785-86. He was again a member of the South Carolina Legislature, 1801-15, and the president of the Senate of the State. He was shot by a lunatic. Among his works are: *History of the Revolution of South Carolina* (1785); *History of the American Revolution* (1789); *Life of Washington* (1807); *History of South Carolina* (1809); and *History of the United States, 1607-1808* (1816-17).

RAMSAY, EDWARD BANNERMAN BURNETT (1793-1872). A Scotch clergyman. He was born at Aberdeen and educated at the Cathedral Grammar School at Durham and at Saint John's College, Cambridge, where he took his degree in 1816. The same year he became curate of Rodden, in Somerset, and shortly added to his care the curacy of Buckland Denham, in the same county. In 1824 he assumed the curacy of Saint George's, York Place, Edinburgh, and two years later went to Saint Paul's, Carrubbers Close. The following year he became assistant of Bishop Sandford at Saint John's Church, succeeded him in 1830, and continued in the pastorate of that church until his death. In 1846 he was appointed by Bishop Terrot Dean of Edinburgh, and though three bishoprics were offered him, he declined them. His best known work was *Reminiscences of Scottish Life and Character* (1858; 22d ed. with memoir by Cosmo Innes, 1874). Among his other works are: *Diversities of Christian Character* (1858); *The Christian Life* (1862); *Lectures on Handel* (1862); and *Pulpit Table-Talk* (1868).

RAMSAY, JAMES ANDREW BROWN. See DALHOUSIE, tenth Earl and first Marquis of.

RAMSAY, NATHANIEL (1751-1817). An American soldier. He was born in Lancaster County, Pa.; graduated at Princeton in 1767; was admitted to the Maryland bar in 1771; and in December, 1776, became lieutenant-colonel in the Continental Army. At Monmouth (q.v.), June 28, 1778, he, together with Colonel Stewart, checked the advance of the English until Washington could rally the main army, but was badly wounded and was taken prisoner. He was exchanged in December, 1780, but retired on January 1, 1781. He was a member of Congress in 1786-87.

RAMSAY, WILLIAM (1852-). A British chemist, nephew of the geologist Andrew Crombie Ramsay. He was born in Glasgow, studied there and at Tübingen, where he received his doctor's degree at the age of twenty, was professor of chemistry at University College, Bristol (1880-87), and in 1887 became professor in University College, London. Ramsay made a special study of the less known gases. With Lord Rayleigh he discovered argon, a new constituent of the atmosphere. His other discoveries are helium and the atmospheric gases, neon, xenon, and krypton. He wrote several text-books of general chemistry, translated Beilstein's *Qualitative Analysis*, and in 1896 published *The Gases of the Atmosphere, the History of Their Discovery*.

RAMSAY, WILLIAM MITCHELL (1851-). A distinguished Scotch classical scholar and Church historian, born in Glasgow. He was educated at the universities of Aberdeen, Oxford, and Göttingen, and was elected fellow of Exeter College, Oxford, in 1882, and of Lincoln College three years later. In 1886 he was appointed professor of humanity (Latin) in Aberdeen University. Professor Ramsay became widely known for his researches in the history of the Church, especially in Asia Minor. His published works include: *The Historical Geography of Asia Minor* (1890); *The Church in the Roman Empire* (4th ed., 1895); *The Cities and Bishoprics of Phrygia* (1895-97); and *Historical Commentary on Galatians* (1899).

RAMSBOTTOM. A town in Lancashire, England, on the Irwell, four miles northwest of Bury (Map: England, D 3). Its industries comprise cotton mills, bleaching fields, calico printing establishments, iron foundries, and stone quarries. Its growth dates from the installation of calico printing by Sir Robert Peel. Population, in 1891, 16,700; in 1901, 15,900.

RAMSDEN, JESSE (1735-1800). An English optician and mechanician, born at Salterhebble, a suburb of Halifax in Yorkshire. He received a good education, and, after having first been engaged as a cloth-worker, became an apprentice in the workshop of an instrument-maker (1758). In 1762 he had gained such great skill that he was employed by the best artists. In 1766 he married Dollond's (q.v.) daughter and received, as her dowry, a share of his father-in-law's patent for achromatic telescopes. The sextants of his time were very imperfect, being untrustworthy within 5' of a degree, and Ramsden succeeded in reducing the possible error to within 30". He also invented a dividing-machine, which

could graduate instruments much more rapidly and accurately than could be done by hand. For this invention he received a reward from the Board of Longitude. He constructed the theodolite used by General Roy (q.v.), and also telescopes for the observatories of Blenheim, Mannheim, Dublin, Paris, and Gotha, and mural quadrants for those of Padua and Vilna. He was one of those who strongly recommended the introduction of the mural circle in place of the quadrant (q.v.), and he constructed also two of the former instruments for the observatories of Palermo and Dublin. The minor scientific instruments invented or improved by him are also numerous. Ramsden published: *Description of an Engine for Dividing Mathematical Instruments* (1777), also the following memoirs read before the Royal Society: "Description of two new Micrometers" (1777); "A New Construction of Eye-glasses" (1782).

RAMSEUR, STEPHEN DODSON (1837-64). An American soldier, born at Lincolnton, North Carolina. He graduated at West Point in 1860, and was assigned to artillery duty at Fortress Monroe. The next year, while serving in Washington, he resigned from the army, April 6th, and was made major of North Carolina State troops. With this rank he commanded a battery of artillery at the siege of Yorktown, but was soon elected colonel of the Forty-ninth North Carolina Infantry. He was engaged in the Seven Days' battles and was severely wounded at Malvern Hill, July 1, 1862. During his convalescence he was promoted brigadier-general October 27, 1862, and took the field soon after Fredericksburg. At Chancellorsville he led the advance of Rodes's division and won special commendation from both Lee and Jackson. On July 1, 1863, at Gettysburg, by a flank attack on the Federal right he helped to take possession of the town. He was engaged in the battles around Spottsylvania Court House, and after Hancock took the Confederate works on the morning of May 12, 1864, was sent to drive him out. In this he was successful, but was again severely wounded. On May 27th he was assigned to command of Early's division with rank of major-general. He took part in Early's raid and was engaged at Harper's Ferry and at the Monocacy. In the battle at Winchester, September 19th, his division was the first to be attacked, but retreated in good order. While covering the retreat at Cedar Creek October 19th he was mortally wounded and captured.

RAMSEY, RÄM'ZI, ALEXANDER (1815-1903). An American administration, 'war Governor' of Minnesota, born near Harrisburg, Pennsylvania, and educated at Lafayette College. He took a prominent part in politics as a member of the Whig Party, and in 1849 was appointed Territorial Governor of Minnesota. In that capacity he made treaties with the Sioux and Chippewas by which much valuable land was opened to settlers. From 1859 to 1863 he was Governor of the State of Minnesota. He became United States Senator in 1863, was reelected in 1869, was Secretary of War under President Hayes, and from 1882 to 1886 was chairman of the Edmunds Utah commission on polygamy.

RAMSGATE. A seaport and favorite watering-place on the Isle of Thanet, County of Kent, England, 65 miles southeast of London (Map: England, H 5). The town consists of well-ar-

ranged streets, crescents, and terraces; the older part, situated in a natural depression or cutting in the chalk coast, opens out toward the sea. The principal buildings are a Hebrew synagogue and college, a Benedictine monastery and college, and a small but beautiful Roman Catholic cathedral. The harbors, 47 acres in extent with 3300 feet of quays, serve as harbors of refuge for the Downs. Ramsgate is an important steam-packet station, with shipbuilding and fishing industries. Anciently a fishing village, it increased in importance about the beginning of the eighteenth century, when a successful trade with 'Russia and the East country' was opened up. The chief imports are timber, ice, and stone. The municipality, incorporated in 1884, is progressive, owns the water and gas supplies, has improved the drainage and provided an iron promenade pier, public parks, and esplanades. On Ossengal Hill, one mile west of the town, are the remains of a Saxon cemetery. Pegwell Bay, to the west, is the traditional landing place of Hengist and Horsa, and a monolithic cross at Cliff's End marks the landing place of Saint Augustine in 596. Population, in 1891, 24,733; in 1901, 27,693. Consult: Wright, *Wanderings of an Antiquary* (London, 1854); Simson, *Historic Thanet* (ib., 1891); "Ramsgate Reviewed," in *Municipal Journal* (ib., 1900).

RAMSONS. A weed. See ALLIUM.

RAMUS, PETRUS (Latinized form of *Pierre de la Ramée*) (1515-72). A French humanist, philosopher, and mathematician, born at the village of Cuth, in Vermandois, the son of a charcoal-burner of noble descent. In his twelfth year he became servant to a rich student at the Collège de Navarre; and by devoting the day to his master, obtained the night for study, and made rapid progress. He was profoundly dissatisfied with the scholasticism and authoritarianism of the day, and showed his contempt for the idol of the times by maintaining as his thesis for his master's degree in 1536 that all that Aristotle had said was false. Ramus, with two learned friends, opened a special class for reading the Greek and Latin authors, designed to combine the study of eloquence with that of philosophy. His audience was large, and his success as a teacher remarkable. He now turned his attention more particularly to the science of logic, which, in his usual adventurous spirit, he undertook to reform. His attempts excited much hostility among the Aristotelians, and when his treatise on the subject (*Animadversiones in Dialecticam Aristotelis*) appeared in 1543, it was fiercely assailed by the doctors of the Sorbonne, who managed to get it suppressed by an edict of Francis I. But Ramus had powerful friends, through whose influence he was, in 1545, appointed principal of the Collège de Presles, which he raised from a condition of decay to the most splendid prosperity. In 1551, under Henry II., the Cardinal of Lorraine succeeded in instituting for him a chair of eloquence and philosophy at the Collège de France. He mingled largely in the literary and scholastic disputes of the time, and, on account of his bustling activity, came under the satire of Rabelais. He had long been suspected of a leaning toward Protestantism, and he ventured formally to abjure the old faith. The outbreak of the religious wars drove him from France to Ger-

many and Switzerland, where he continued his academic activity. Unfortunately, he returned to Paris in 1571, and was one of the victims of the Massacre of Saint Bartholomew.

Ramus holds a most honorable place in the list of intellectual reformers. His assault on scholasticism is vigorous, and, on the whole, well directed; in his assertion of reason as the supreme criterion of truth, he must be regarded as the forerunner of Descartes and the modern world. His system of logic, by which perhaps his name is best known, is marked by its lucid definitions, its natural divisions, and its simplification of the rules of the syllogism; but it fails to make any real advance upon the old logic. His followers were a widespread and for a long time a powerful body of thinkers and teachers. Consult: Waddington, *Ramus, sa vie, ses écrits et ses opinions* (Paris, 1855); Desmaze, *Ramus* (ib., 1864); Lobstein, *P. Ramus als Theolog* (ib., 1878); Voigt, *Ueber den Ramismus der Universität Leipzig* (Leipzig, 1888).

RAMUSIO, rà-mōs'zè-ò, GIAMBATTISTA (1485-1557). An Italian compiler, born at Treviso. He was Ambassador of Venice to France, Switzerland, and Rome, and subsequently until his death held the post of secretary to the Council of Ten. He published *Delle navigationi e Vaggi*, etc., a collection of travels and voyages in three volumes (1550, 1559, 1566), of which the third was composed of material important for the history of early America. The most complete edition is that of 1606.

RANC, rà-n, ARTHUR (1831-). A French politician and author, born at Poitiers. He studied law in Paris and took such a violent part in the Republican activities under the Empire that he had to leave France. After the amnesty of 1859 he returned to Paris and contributed to the *Opinion Nationale*, the *Nain Jaune*, and other journals. Because of the tone of some of these articles he was imprisoned for four months. In 1870 he was elected maire of the Ninth Arrondissement of Paris, and joined Gambetta, who gave him the directorship of police, a post in which he highly distinguished himself. The following year he was elected to the National Assembly, but he voted against the arrangements for peace and resigned from the Assembly to become a member of the Commune. The violence of that body was contrary to his own views, and he resigned from it also. Afterwards the monarchist press attacked him and his organ, the *République Française*, for the part he had taken during the Commune, and after he had been elected from the Department of Rhône to the National Assembly of 1873, he was condemned to death in *contumaciam*. He had escaped to Belgium, where he remained until the amnesty of 1879 brought him back to France. He had continued his connection with the *République Française*, and became director of the *Petite République* in 1880. In 1881 he was elected Deputy from the Seine, and in 1891 Senator. He was consistently Republican throughout the Boulanger difficulties, and he took a leading part in the revision of the Dreyfus case. His works include *Sous l'empire, roman de mœurs politiques et sociales* (1872), *De Bordeaux à Versailles* (1877), and *Le roman d'une conspiration* (1868).

RANCAGUA, rà-n-kä'gwá. The capital of the Province of O'Higgins, Chile. It is situated in a

rich agricultural district on the railroad 40 miles south of Santiago (Map: Chile, C 10). In 1814 it was the scene of an important battle in which the patriot forces were defeated by the Spaniards. Population, in 1895, 6700.

RANCÉ, rān'sā', DOMINIQUE ARMAND JEAN LEROUTHILLIER DE (1626-1700). The founder of the reformed order of La Trappe. (See TRAPPISTS.) He was born in Paris January 9, 1626, and educated there. Having taken his degree in the Sorbonne, he soon became distinguished as a preacher, and through the favor of Cardinal Richelieu obtained more than one valuable benefice. He succeeded while yet a young man to a large fortune, and lived a careless and irregular life. After a time, however, having forfeited the favor of Cardinal Mazarin, and deeply moved by the sudden death of the Duchess de Montbazou, to whom he was much attached, he resigned all his preferments with the exception of the abbacy of La Trappe, in Normandy, to which he retired in 1662, with the intention of restoring the strict discipline of the Order. He lived in this seclusion for the rest of his life, and published a large number of works, chiefly ascetical. The only remarkable event of his literary life was his controversy with Mabillon, in reply to his *Etudes monastiques*, on the subject of the studies proper for the monastic life. He also wrote *De la sainteté et des devoirs de la vie monastique* (1683; Eng. trans., *A Treatise on the Sanctity and on the Duties of the Monastic State*, Dublin, 1830). In his youth he had edited the works of Anacreon, with translation and notes (1639), and dedicated the book to Cardinal Richelieu. He died at La Trappe, October 27, 1700. Migne reprinted his *Œuvres oratoires*. Consult his *Life* by C. Butler (London, 1814), and by Dubois (Paris, 1866).

RAND. A popular designation for the gold-bearing Witwatersrand (q.v.) reef in the Transvaal Colony, South Africa.

RANDA, rān'dā, ANTON (1834—). An Austrian jurist, born at Bistritz. He studied law at Prague, where he afterwards became professor of Austrian civil law. In 1881 he was appointed life member of the Austrian House of Peers, and soon afterwards he was made a member of the Imperial Court of Justice. He is considered one of the highest authorities on Austrian civil law. His publications include *Der Besitz nach österreichischem Rechte* (1865-95), which is his chief work, and *Der Erwerb der Erbschaft* (1867).

RAN'DALL, ALEXANDER WILLIAMS (1819-72). An American public official, born in Ames, N. Y. He was admitted to the bar, and in 1840 began practice in Waukesha, Wisconsin. In 1855 he was elected to the State Legislature, in the same year was appointed a judge of the Circuit Court, and in 1857 and 1859 was elected Governor of Wisconsin. In 1861 he was appointed by President Lincoln United States Minister to Italy, and upon his return in 1862 became First Assistant Postmaster-General. From 1866 to 1869 he was Postmaster-General.

RANDALL, JAMES RYDER (1830—). An American poet and journalist, born in Baltimore, Maryland, January 1, 1839. After being educated at Georgetown College where, on account of ill health, he did not graduate, he spent some

time traveling in South America, but he returned to the United States and began newspaper work in Louisiana before the beginning of the Civil War. The news of the fighting in Baltimore when the Massachusetts troops passed through the city inspired him to write his famous "Maryland, My Maryland," which was at once set to music and with "Dixie" became the most popular of Confederate songs. For sheer poetic merit it is thought by some to be the best martial lyric composed by any American. Mr. Randall wrote other war lyrics, some of which are good, but his fame rests upon the poem that first made him famous. At the close of the war he became an active journalist and was for many years editor of *The Constitutionalist* of Augusta, Georgia.

RANDALL, SAMUEL JACKSON (1828-90). An American political leader and legislator, Speaker of the National House of Representatives from 1876 to 1881. He was the son of Josiah Randall, a prominent lawyer of Philadelphia, where he was born. There he was educated at the University Academy. He early became prominent in the Whig Party, on the break-up of which both he and his father joined the Democratic Party. In 1858 he was elected a member of the State Senate. At the outbreak of the Civil War he went to the front with the ninety-day men as a private in the First Philadelphia City Troop. At the time of Lee's invasion of Pennsylvania in 1863, he recruited a company of which he became captain, and served also as a provost marshal. In November, 1862, he was chosen as a Democrat to represent the First Pennsylvania District in Congress, to which he was thirteen times successively reelected. In the Forty-third Congress (1873-75) he was placed on the Committee on Rules with Blaine, Banks, Garfield, and Cox, and by directing the Democratic opposition to the 'Force Bill' won general recognition as the leader of his party in the House. At the opening of the Forty-fourth Congress he was appointed chairman of the Committee on Appropriations. In December, 1876, he was elected to succeed Speaker Kerr, who had died during the recess of Congress, and thus was called upon to preside during the exciting and critical period of the disputed Hayes-Tilden election. He was reelected Speaker of the Forty-fifth and Forty-sixth Congresses (1877-81). After about 1883 Randall became the leader of a small group of Democrat protectionists who consistently opposed all attempts at tariff reform. At the Democratic national convention of 1880 he received 128½ votes on the second ballot for the nomination to the Presidency. With his Pennsylvanian constituents his influence and popularity remained strong to the last, and in his last two elections to Congress he was unopposed by the Republicans.

RANDAZZO, rān-dāt'sō. A town in the Province of Catania, Sicily, situated on the northern slope of Mount Etna, 26 miles by rail north-northwest of Catania (Map: Italy, J 10). There is trade in wine, oil, and cheese. Population (commune), in 1901, 11,798.

RANDEGGER, rān'dēg-gēr, ALBERTO (1832—). An Austrian-English composer, born at Triest. He was a pupil of Lafont in piano, and of Luigi Ricci in composition, and with two other young composers, produced two ballets

and an opera, *Il Lazzarone*, in 1852. In 1854 he produced his opera *Bianca Capello* at Brescia. As teacher of singing in London, where he settled about 1855, he became well known, and in 1868 was appointed professor of singing at the Royal Academy of Music. In 1857 he conducted Italian opera at the Saint James's Theatre, and was musical director of the Carl Rosa Opera Company from 1879 to 1885; and, upon the resignation of Benedict in 1881, became conductor of the Norwich Musical Festival. He wrote a comic opera, *The Rival Beauties* (1864); a dramatic cantata, *Fridolin* (1873); two scenas for soprano and orchestra, *Medea* (1869) and *Sappho* (1875); the *150th Psalm* for soprano solo, choir, orchestra, and organ, which was given at the Boston Musical Festival in 1872; *Funeral Anthem*, in memory of the Prince Consort; numerous other vocal pieces; and a well-known *Primer of Singing*.

RANDERS, rån'ers. A town of Jutland, Denmark, situated at the entrance of the Gudenaa into the Randers Fiord, 22 miles northwest of Aarhus (Map: Denmark, D 2). The chief manufactures are railroad cars, gloves, oleomargarine, and the chief exports grain, butter, eggs, and fish. Population, in 1901, 20,057.

RAN'DOLPH. A town, including several villages, in Orange County, Vt., 25 miles south by west of Montpelier; on the Central Vermont Railroad (Map: Vermont, D 6). It is the seat of the Randolph State Normal School, and has a public library. The surrounding district is chiefly engaged in farming and lumbering. Lumber and wooden ware are the principal manufactured products. Population, in 1890, 3232; in 1900, 3141.

RANDOLPH, ALFRED MAGILL (1836—). An American Protestant Episcopal bishop, born in Winchester, Va. He graduated at the College of William and Mary in 1855 and at the Theological Seminary of Virginia in 1858; was ordained priest in the Protestant Episcopal Church in 1860; was rector of Saint George's Church, Fredericksburg, Va., in 1860-62; was a chaplain in the Confederate Army in 1862-65; and was rector of Christ Church, Alexandria, in 1865-67, and of Emmanuel Church, Baltimore, from 1867 to 1883. In 1883 he became Coadjutor Bishop of Virginia, and in 1892 was himself elected Bishop of Southern Virginia.

RANDOLPH, EDMUND JENNINGS (1753-1813). An American statesman, the nephew of Peyton Randolph (q.v.). He was born in Williamsburg, Va.; graduated at William and Mary College; early became prominent as an opponent of the measures of the British Ministry, and, in consequence, was disinherited by his father, John Randolph, a staunch Loyalist. In August, 1775, he became one of Washington's aides, and in 1776 sat in the Virginia Constitutional Convention. He was chosen first Attorney-General under the new State Constitution (1776), sat in the Continental Congress from 1780 to 1782, and was Governor of Virginia from 1786 to 1788. In 1787 he headed the Virginia delegation to the Constitutional Convention, and took a prominent part in the debates, proposing the celebrated 'Virginia plan,' and opposing, among other things, the single executive, the Vice-Presidential office, and equality of the States in the Senate. He refused to sign the instrument as finally

drafted, but in the Virginia Convention strongly advocated its ratification. He helped to codify the Virginia laws, and in September, 1789, was appointed by Washington Attorney-General of the United States. On January 2, 1794, he succeeded Jefferson as Secretary of State, but resigned in August, 1795, primarily on account of an intercepted dispatch of the French Minister Fauchet, which led to charges being brought against him reflecting on his honor. Most of these charges have in recent years been effectually disproved. Returning to his home, he became the leader of the Virginia bar, and in 1807 helped defend Aaron Burr against the charge of treason. He wrote a *History of Virginia*, which, though never published, has been much used in manuscript by other historians. He also wrote (and published): *A Vindication of Mr. Randolph's Resignation* (1795); and pamphlets, entitled *Democratic Societies* (1795) and *Political Truth* (1796). He was one of the ablest speakers and one of the foremost lawyers of his time. Consult Conway, *Omitted Chapters of History Disclosed in the Life and Papers of Edmund Randolph* (New York, 1888).

RANDOLPH, JOHN, OF ROANOKE (1773-1833). An American statesman, born at Cawsons in Chesterfield County, Va., June 2, 1773; died in Philadelphia, June 24, 1833. He was descended from an old and wealthy Virginia family, and boasted that the Indian princess Pocahontas was one of his ancestors. Educated at Princeton and Columbia colleges, he began the practice of law, but in 1799 he was elected to Congress, where he became distinguished for his eloquence, wit, sarcasm, invective, and eccentricity. At a very early stage in his career he was the Democratic-Republican leader of the House of Representatives. He denounced the settlement of the Yazoo land dispute effected by Madison and Gallatin. In 1804 he introduced a resolution impeaching Justice Samuel Chase (q.v.) and was the foremost prosecutor in the famous trial in the following year. He ultimately broke with Jefferson, and lost his influence, although as a free lance and a hurler of invectives he never ceased to be feared. He opposed the War of 1812, and the Missouri Compromise, and stigmatized the Northern members who voted for the latter as 'doughfaces.' In 1822 and 1824 he visited England, where his eccentricities attracted much notice. In 1825 he began his two years' service as Senator from Virginia, and fought his famous duel with Henry Clay. In 1830 he was appointed Minister to Russia, and gave much occasion for scandal by his short stay and heavy demands on the Treasury. By his will he manumitted his 318 slaves, and provided for their maintenance in a free state. In some respects full justice has never been done to Randolph's intellect. He was not merely a well-read man and possessed of a good style, as appears from his *Letters to a Young Relative* (1834) and many of his speeches in Congress, nor was he simply an unparalleled master of invective; he was also a far-sighted statesman, who foresaw the direction American politics would take with regard to the question of slavery, and outlined the policy of Southern defense afterwards taken up by Calhoun and his followers. He was considered a Virginian of Virginians, upon whom young Southern extremists modeled themselves. Consult *Lives of him by Garland* (New York, 1850); by Adams,

American Statesmen (Boston, 1882); and Trent, *Southern Statesmen of the Old Régime* (New York, 1896).

RANDOLPH, PEYTON (1723-75). An American patriot of the Revolutionary period. He was born in Virginia, graduated at William and Mary College, studied law at the Temple in London, and in 1748 became the Royal Attorney-General for the Colony of Virginia. In the same year he became a member of the Virginia House of Burgesses, and served as chairman of a committee to revise the laws of Virginia. In 1764 he framed the remonstrance of the Burgesses against the threatened Stamp Act. In 1766 he resigned the office of Attorney-General, and devoted himself to furthering the cause of the Patriot or Whig Party, serving as chairman of the Committee of Correspondence and as president of the Virginia Convention of 1774. In the latter year he was chosen a delegate to the Continental Congress at Philadelphia, and was unanimously elected president of that body upon its assembling at Carpenter's Hall, September 5th. In 1775 he was again elected to the Continental Congress and again chosen president. In the same year he presided over the second Virginia Convention, and served as Speaker of the House of Burgesses. Shortly after his return to Congress he died suddenly of apoplexy.

RANDOLPH, THOMAS (1523-90). An English courtier and diplomat. He was educated at Oxford, and remained there until the Protestant persecutions in Mary's reign. Elizabeth sent him on missions to Germany and Scotland, where he mingled in all the complex political dealings between England and Scotland from 1559 until 1586. Mary banished him from her Court in 1566 on the charge of being concerned in Moray's rebellion; and he was afterwards sent on embassies to Russia (1568) and Paris (1573 and 1576). Several of his letters have been preserved; they give a vivid picture of the plots and counterplots at Mary's Court.

RANDOLPH, THOMAS (1605-35). An English playwright, educated at Westminster School and at Trinity College, Cambridge, of which he was elected a fellow in 1632. Except for visits to London, where he met Ben Jonson and other wits at the Devil Tavern, he passed his time at the university. He gained a reputation for graceful Latin and English verse and for dramatic performances arranged for the students. *Aristippus, or the Jovial Philosopher* (1630), a drama in verse and prose, is a satire on university education. With it was published the *Conceited Pedler*, a monologue of a rogue much like Shakespeare's Autolycus. There appeared posthumously a volume entitled *Poems, with the Muses' Looking-Glasse and Amyntas* (1638), bound with Milton's *Comus*. *The Muses' Looking-Glasse* is a witty comedy and *Amyntas* is a pastoral drama adapted from the Italian. To Randolph have been ascribed a pleasant comedy, *Hey for Honesty* (published 1651), and a Latin comedy, *Cornelianum Dolium* (1638). Consult his *Poetical and Dramatic Works*, ed. by Hazlitt (2 vols., London, 1875).

RANDOLPH, THOMAS JEFFERSON (1792-1875). An American statesman, born at Monticello, Va. He was the oldest grandson of Thomas Jefferson, and paid the debts that Jefferson left at his death. He also acted as Jefferson's lit-

terary executor, and in 1829 published *Life and Correspondence of Thomas Jefferson* (4 vols.). As a member of the Virginia Legislature, he in 1829 introduced a post-natal plan for the gradual abolition of slavery, but the bill was defeated in the following year. In 1851-52 he was a member of the State Constitutional Convention, and for seven years was rector of the State University. In 1872 he presided over the Democratic National Convention that nominated Horace Greeley for the Presidency.

RANDOLPH-MACON SYSTEM OF COLLEGES AND ACADEMIES. A system of five collegiate and preparatory institutions in Virginia, under Methodist control, and managed by one board of trustees, comprising a college for men, with two academies, and a college for women, with one academy. The organization is designed to secure close correlation between the preparatory school and the college, with economy of time and expense to both. Randolph-Macon College, for men, the parent institution of the system, was chartered in 1830 and opened in 1832 at Boydton, Va. The college was closed during the Civil War and was reopened in 1866. In 1867 it was removed to its present location, at Ashland, Va. It has no professional schools. The course is partially elective and leads to the degrees of bachelor and master of arts. Students for the ministry are exempt from tuition fees. The college had in 1902 a faculty of 10 instructors, 127 students of collegiate grade, an endowment of \$300,000, an income of \$20,000, grounds and buildings valued at \$95,400, the total value of the college property being estimated at \$119,979. The library contained 10,000 volumes. The feeding schools of the college are the Randolph-Macon Academy, at Bedford City, Va., established in 1890, and the Randolph-Macon Academy, at Front Royal, Va., established in 1892.

Randolph-Macon Woman's College was established in 1891 at Lynchburg, Va. In 1902 its attendance was 276, faculty 26. It has grounds of 25 acres, valued with the buildings at \$165,000, an endowment of \$165,000, with a total property valuation of about \$275,000. Its income for 1902 was \$87,500. Its library contained 4000 volumes. Its preparatory school, the Randolph-Macon Institute, at Danville, Va., was admitted in 1897. The chancellor of the system is William W. Smith.

RANELAGH, răn'e-lă. A popular resort in Chelsea, England, well known during the eighteenth century. The plot of ground, on which the building stood from 1742 to 1803, had belonged to the Earl of Ranelagh. The structure was a wooden rotunda built in imitation of the Pantheon at Rome, and could accommodate more than 6000 guests. The place was at one time frequented by the most fashionable society and by writers like Johnson and Goldsmith. After 1788 a rapid decline began, and in 1803 the building was demolished.

RANENBURG, răn'nyen-boörg. A town in the Government of Ryazan, Russia, about 230 miles southeast of Moscow. The place was granted in 1702 by Peter I. to Mentchikoff. It subsequently served as a place of exile for Mentchikoff himself and for Anna Karlovna. Population, in 1897, 15,347.

RANGABÉ, răn'gá'bá', or **RHANGAWIS**, ALEXANDROS RIZOS (1810-92). A Greek author

and statesman, born in Constantinople, and educated at Odessa and in the Military School at Munich, whence he entered the Bavarian artillery. In 1831 he returned to Greece and entered governmental employ, serving for several years in the department of the Ministry of Education. There he founded a new school system, primary and secondary, and established the Greek Archaeological Society. In 1844, after two years in the Department of the Interior, he was expelled because of his foreign birth. He was called in 1845 to the chair of archæology in the University of Athens, was Minister of Foreign Affairs (1856-59), became Minister to Washington (1867), to Paris (1868), served in a like capacity at Berlin (1874-86), and then accompanied Delyannis to the Congress of Berlin. He was a leader of the classicists who urged a return to ancient Greek, in which he wrote versions of Dante, Goethe, and Lessing, lyric, epic, and dramatic poetry, and a valuable volume on Greek archæology. In French he wrote *Antiquités helléniques* (1842-55) and *Histoire de la littérature néo-hellénique* (1877; in German, 1884; in Greek, 1888). His archæological dictionary (1888 et. seq.) was not completed. His son KLEON (1842-) occupied various diplomatic positions and is the author of lyric and dramatic poetry. In 1895 he became Greek Ambassador at Berlin.

RANGE (from OF., Fr. *ranger*, to align, from *rang*, line, from AS., OHG. *hring*, *hrinc*, Ger. *Ring*, Eng. *ring*; connected with OChurch Slav. *krangŭ*, circle, with Lat. *circus*, Gk. *κρίκος*, *krikos*, ring, or with Skt. *srñkhala*, chain). A term in gunnery, indicating the extreme distance a projectile can cover after leaving the muzzle of the piece from which it was discharged. The *maximum range* of a gun is the greatest distance to which it will throw its projectile under ordinary conditions of loading. The maximum range of the most powerful gun in the world (the Water-vliet Arsenal, U. S. 16-inch B. L. R.) is about 21 miles (20.978); the U. S. 10-inch B. L. R. has a maximum range of about 11.7 miles; the 8-inch about 10.6 miles, and the 12-inch B. L. mortar about 6 miles. The Krupp 9.45 inch gun, which held the maximum record before the United States 16-inch gun appeared, fired a projectile about 12½ miles, the greatest height reached during this flight being 21,456 feet.

The *effective range*, or the range at which the projectile may be counted upon to perform the work for which it is intended, is usually much smaller than the maximum range, and of course is a much more useful thing to know. The effective range of a modern field gun firing shrapnel is about 7000 yards (in the United States 6600 yards). *Point blank* range is when the piece is fired in a horizontal position; the range then increases with the elevation. See GUNNERY; BALISTICS.

RANGE-FINDER. An instrument used in naval and military operations to determine the horizontal distance of the object to be hit from the gun which is firing. They are of three principal types, those furnishing their own bases for measurement, those depending upon a known dimension of the object aimed at, and those utilizing a time observation. Those of the first-named type have the most general application and are therefore the most desirable, but satisfactory instruments are either very cumbersome or delicate.

or are liable to give ranges considerably in error. The instruments of the second type may be made fairly accurate, but have a narrow application. Those of the third type are generally inaccurate and are not of much use since the introduction of smokeless powders and rapid-firing guns.

The simplest method of obtaining range by utilizing a base at the point of observation is called Buckner's method and was devised by Lieut. Buckner, of the United States Navy. In the figure, AB is the mast of the ship, which is endeavoring to obtain the range.

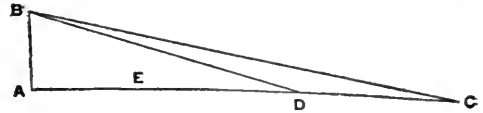

FIG. 1.

A is the water line, B the position of the observer, and D the position of the object observed; AB is therefore the height of the observer above the water; AEDC is the surface of the water from A to C (in the visible horizon of the point B); and AD is the desired range. By means of suitable tables the range AD corresponding to any height (AB) and angle (DBC) can be instantly ascertained. It therefore is only necessary to measure the angle DBC by means of a sextant or similar instrument. This method has the disadvantage that it removes the observer from the vicinity of the guns, requiring transmission of the range when it is ascertained; this takes time, and with rapidly moving ships is almost certain to cause error. Furthermore, if the enemy has more than one ship the confusion of ranges may be so serious as to render the ranges obtained nearly valueless. The form of auto-base range-finder largely used in fortifications has two observers at a short distance apart (this distance furnishing the base). Thus A and

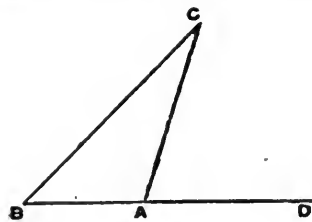

FIG. 2.

B are the observing stations, AB the known base, and AC or BC the range. The angles CAD and CBA and the distance BA being known, the distances CA and CB are quickly determined from tables similar to those in Bowditch's *Practical Navigator* for ascertaining the "Distance of an Object by Two Bearings." Most of the recent range-finders are constructed on the same general principle, but are arranged for operation by one person. The base is therefore much shortened, and this is sought to be compensated by the magnification of the angle at C so that it will appear equal to a much larger one before the unaided eye. The most prominent range-finders of the auto-base type are the Barr and Stroud, Zeiss, Davis, Lewis, and Fiske (turret type). Of these the first two have had widespread use and are considered fairly satisfactory and the others have given good results in experiments.

The commonest means of obtaining the distance of an object whose height is known is to measure the angle it subtends by means of a sextant. Thus

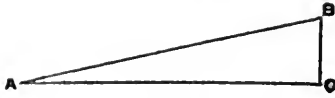

FIG. 3.

let BC be the object whose height BC is known. Then by measuring the angle at A the distance AC may be at once picked out of a table of right triangles. For convenience, a special form of sextant, called a stadimeter, has been invented by Commander Fiske of the United States Navy. The reading of the instrument is in yards instead of in angular measure, so that the use of the tables is avoided.

The third type of range-finder is merely a time-measurer which gives the interval between the observed flash of the enemy's gun and the hearing of the report. As the velocity of sound in air is known, the distance may be readily determined. For convenience, the reading may be given in yards instead of seconds. The Watkins range-finder is an instrument of this type and consists of a small glass tube containing a liquid and a moving index. When the flash of the gun is seen the instrument, previously held upside down, is inverted and the index falls slowly through the liquid; when the sound of the gun is heard the instrument is turned to a horizontal position. The side of the tube is graduated and the graduation mark at which the index is seen shows the distance. Aside from errors of range due to faulty graduation and irregularities of the velocity of sound in air, accurate determination of range by an instrument of this kind is practically impossible because of the rapidity of fire of modern guns, whereby the distinguishing of the sound of a particular gun is rendered very difficult.

For further information, see the articles on BALLISTICS and on GUNNERY; *Proceedings of the United States Naval Institute* (particularly the "Professional Notes" in numbers 97 to 102); *Annual of the Office of Naval Intelligence*, United States Navy (particularly the volume for 1900).

RANGELEY (rānj'lī) **LAKES**. A chain of lakes near the western boundary of Maine (Map: Maine, B 6). The principal members are Kennebeco, Rangeley, Mooseluemaguntic, Molechuckmunk, Richardson, and Umbagog. All of these are connected by streams in the order named, and form the sources of the Androscoggin River. They lie in a wild and beautiful region, and are a favorite resort of tourists and sportsmen.

RANGER, rānj'jēr, HENRY WARD (1858—). An American landscape painter, born in New York City and self-taught. He traveled in Holland and Germany, and first became known by his Dutch landscapes. Afterwards he exhibited several Canadian scenes, painted in the region of Quebec. His subjects include marines, forest interiors, and shore and field views. His later pictures are "Pasture Lot," "Morning at Highbridge," "Bradley's Mill Pond," a work of great tonal beauty.

RANGERS, MOUNTED. In 1832 the United States Government found it necessary to increase the regular army establishment, owing to increasing Indian troubles, and particularly be-

cause of the Black Hawk War of that year. One battalion of mounted rangers was raised, and added to the establishment, but was disbanded the following year, and a regiment of dragoons substituted, which afterwards was organized into what is now the First Regiment of regular cavalry.

RANGOON, rān-gōon', or **RANGUN**. The capital and chief port of Burma, India, on the Rangoon River, the eastern branch of the Irrawaddy, about 25 miles from the sea, in latitude 16° 42' N. and longitude 96° 13' E. (Map: Burma, C 3). Rangoon is finely situated for internal as well as foreign commerce, having a continuous water communication with the vast region on the Irrawaddy. The town, well laid out with straight streets crossing at right angles, extends for over a mile along the river front, and three-quarters of a mile inland. Rangoon is a stronghold of Buddhism, and on every side are seen monuments to Gautama. The most remarkable of these is the Shoay-Dagon, a shrine, the foundation of which is said to have been laid 583 years B.C. It stands on an artificial elevation within the military cantonment on the north, is 370 feet high, 1355 feet in circumference, and contains personal relics of Buddha; it is annually visited by thousands of pilgrims. The European buildings include the Government House, the court houses, post and telegraph offices, a cathedral, college, museum, free library, and hospital. Other notable features are the native bazaars, Dal-housie Park, and the several pretty lakes in the vicinity. Street railways give access to all the principal points. The chief industrial establishments are the lumber, rice, and oil mills; there are also manufactures of silk and cottons, mats, pottery, salts, and fish paste. The river front is lined with wharves, and two-thirds in value of the exports of Burma are shipped, and almost all the imports are received at this port, which is the third in importance of British India. The principal exports are teak and rice; the imports include cotton, cutlery, petroleum, hardware, liquors, wines, silks and woollens, and raw silk. The city was rebuilt by Alompra in 1755; the British captured it in 1824, but it was retaken by the Burmese. The British again took possession in 1852, since which time the city has been held by them. Population, in 1891, 180,324; in 1901, 234,881.

RANIERI, rā-nyā'rè, ANTONIO (1809-88). An Italian author, born in Naples. He was the devoted friend of Leopardi, whom he faithfully nursed until his death. He edited the collected works of Leopardi and wrote *Sette anni di sodalizio con Giacomo Leopardi* (1880), the biographical matter in which is not altogether reliable. The publication of his novel, *Ginevra o Porfana della Nunziata* (1839), and his history, *I primi cinque secoli della storia d'Italia da Teodosio a Carlomagno* (1841), involved him in trouble with the Government, but United Italy recognized his abilities, and at the time of his death he was a Deputy and a professor at the University of Naples. His writings were published in 1862-64, and a volume of *Scritti varii* in 1891.

RANJIT-SINGH, rān-jāt' sīng'h' (1780-1839). Maharaja of the Punjab, born at Gujranwala, the son of Maha-Singh, Sirdar of Sukur-Chukeah, who died when Ranjit-Singh was about

twelve years old. His widow took charge of the administration, and attempted by every means in her power to render her son effeminate, but without success. When he was about seventeen years old she died suddenly and under somewhat suspicious circumstances, and he immediately assumed the government. In 1799, having rendered important service as an ally to Zeman Shah of Afghanistan, who had invaded the Punjab, he received Lahore, which he held despite the efforts of the neighboring sirdars. To them he next turned his attention, and succeeded in subduing some and rendering others tributary. His successes alarmed the Sikh chiefs, allies of the British, situated between the Sutlej and the Jumna, who besought the interference of Lord Minto, the Governor-General. According to a treaty made with Ranjit-Singh in 1808 by Charles Metcalfe, the English gave up all interference north of the Sutlej, on condition that that boundary should be respected. Ranjit-Singh, thus freed from the only danger he feared, by 1812 had compelled all but three of the Punjab sirdars to resign their authority, and proclaimed himself Raja. In 1813 he obtained possession of Attock, took Multan by storm in 1817, and in 1819 annexed Kashmir, assuming after these exploits the title of maharaja. In 1822 he took into his service Allard and Ventura, two French officers who had served under Napoleon, and by their aid he finished the reconstruction of his army, with the view of extending his dominion to the west of the Indus. In pursuance of this scheme, he wrested the Province of Peshawar from the Afghans in 1829. After several years of desultory war with the Afghans, his army was routed by them in 1836, but this reverse does not seem to have affected the stability of his rule, even in the most recently acquired districts, and his reign was not disturbed by a single revolt. He died June 27, 1839. He was totally uneducated and could neither read nor write, but his administration was energetic, and, for an Oriental despotism, equitable. Consult Griffin, *Ranjit-Singh* (Oxford, 1892).

RANK, ränk, JOSEPH (1816-96). An Austrian novelist, born at Friedrichsthal. He studied law and philosophy in Vienna, but devoted himself entirely to literature, and won reputation with the popular tales *Aus dem Böhmer Walde* (1843), a new series of which, *Neue Geschichten aus dem Böhmer Walde*, was published in 1847. These and his other village stories rank among the best of their kind in German literature. Elected a member of the Frankfort Parliament in 1848, he sided with the moderate liberals, lived subsequently at Stuttgart, Frankfort, Weimar, and Nuremberg, and in 1861 became secretary of the Imperial Theatre at Vienna, being afterwards appointed to a similar position at the Imperial Opera. His numerous novels and tales include: *Florian* (1853); *Geschichten armer Leute* (1853); *Von Haus zu Haus* (1853); *Achtspännig* (1856); *Aus Dorf und Stadt* (1860); *Ein Dorfbrutus* (1861); *Im Klosterhof* (1875); and *Der Seelenfänger* (1885). Posthumously appeared *Erinnerungen aus meinem Leben* (Vienna, 1896). Consult Pröll, *Joseph Rank* (Prague, 1892).

RANK AND COMMAND. In the military or naval services, the different steps or grades of command are marked by a distinct title of rank or standing. The rank is relative to the

grade or command, and an officer may be of the same grade yet be inferior in rank to another. Officers of the same grade are senior or junior to each other, according to the priority of their commission. In the United States, the Regular Army commission takes precedence of either militia or State National Guard commissions of the same grade. Where the grade and date of commission of two or more officers is the same, seniority is according to length of previous service; and should their period of service be equal, the order of appointment determines the rank between officers of the same regiment. Brevet (q.v.) rank applies only to the army.

As responsibility and subordination are the basis of organization, rank and command are the necessary correlatives. Every rank should have its proper command, and conversely every command should be accompanied by a proper rank. The only safe guide is the custom of nations, according to which all the forces of the land, comprising usually several armies, are commanded by a general-in-chief, who is often the sovereign or head of the nation himself, if he should be by education and training a soldier capable of taking the field in that capacity; each separate army is commanded by a general or field-marshal, each army corps by a lieutenant-general, each division by a major-general, and each brigade by a brigadier-general. The regiment is commanded by a colonel, assisted by a lieutenant-colonel, each battalion by a major, and each company by a captain, assisted by first and second lieutenants.

There are some slight differences in the various armies of the world. For example, in France the highest rank is that of Marshal of France, and there is no grade corresponding to the United States major-general; in Germany the generals are classified as marshal-generals, colonel-generals, generals of infantry, cavalry, or artillery (commanding army corps), lieutenant-generals (commanding divisions), and major-generals (commanding brigades)—there are no brigadier-generals, and there are two grades of captains, first and second class. In Great Britain the battalions are commanded by lieutenant-colonels, and the field batteries by majors. The grades of non-commissioned officers, other than sergeant and corporal, are also quite different in the different armies.

Promotion is an important factor in rank and command, since its rate determines the age at which any particular rank or command is reached, and the latter is a very important element in the organization of an army, because rapid promotion insures to the higher commands young, and therefore energetic, officers. Germany may be taken as the type of the Continental armies, and there promotion from second to first lieutenant takes place in the arm of the service, from first lieutenant to captain by corps, from captain to major in the arm again, and above that in the entire army; transfers are often made in order to equalize promotion, and incapable officers are retired; in the general staff promotion is more rapid, because there are more majors than captains, and the former are continually passing out for service in the line. Promotion in the German army has been as follows: to first lieutenant after 7 years of service, to captain after 12, to major after 23, to lieutenant-colonel after 30, to colonel after 33, and to major-general after

36; in the general staff, however, captaincies are attained in two or three years less than in the line, and majorities three or four years earlier than in the line. See ARMY ORGANIZATION; ARMIES.

RANKE, rän'ke, JOHANNES (1836—). A German physiologist and anthropologist, born at Thurnau, Bavaria. He was educated in Munich, Berlin, and Paris, became a lecturer in physiology at Munich in 1861, in 1869 professor extraordinary and in 1886 full professor of anthropology, his being the first chair of that science in Germany. In 1889 he became curator and director of the collection of prehistoric objects of Bavaria presented by him to the State. Ranke is also editor of the *Beiträge zur Anthropologie und Urgeschichte Bayerns*, of the *Archiv für Anthropologie*, and of the *Korrespondenzblatt* of the German Anthropological Society, of which organization he was chosen general secretary. His published works include *Tetanus* (1865), *Die Ernährung des Menschen* (1876), *Das Blut* (1878), and *Beiträge zur physischen Anthropologie der Bayern* (vols. i. and ii., 1883-92).

RANKE, LEOPOLD VON (1795-1886). A celebrated German historian, who, with Niebuhr, was the founder of the modern historical school. He was born at Wiehe, in Thuringia. At the age of eighteen he went to the University of Leipzig, where he studied theology and the classics. In 1818 he became an instructor in the gymnasium at Frankfort-on-the-Oder. His field was classical literature, and in his systematic reading of the ancient historians he was aroused to the possibility of attaching to modern history that interest and vitality, the lack of which in most writers had repelled him from the subject. When his studies had carried him by gradual chronological progression up to the fifteenth century, Ranke had come to realize his mission, and thenceforth he turned to history as his life work. He first published the *Geschichte der romanischen und germanischen Völker von 1494-1535* (1824). He was in 1825 appointed professor extraordinary at the University of Berlin, and entered upon a study of the Venetian Relations, which gave him an insight into the historical value of diplomatic history, the use of which became one of the marked characteristics of his work. The result of these studies was his *Fürsten und Völker von Südeuropa im 16. und 17. Jahrhundert* (1827). He next received a commission from the Prussian Government to go to Venice and investigate the archives there, and in 1834-37 he published *Die römischen Päpste, ihre Kirche und ihr Staat im 16. und 17. Jahrhundert* (10th ed. 1900, under the title *Die römischen Päpste in den letzten vier Jahrhunderten*), a work which attracted the attention of the entire civilized world. In 1834 he was made a full professor at Berlin. Ranke's great studies of the Reformation period in Germany, France, England, and Italy all form parts of one related whole. These works are the most notable and important of Ranke's voluminous contributions to historical literature and form a unique study of the period. Ranke became historiographer of Prussia in 1841, and was the recipient of many honors in the course of his long life. He retired from his chair in Berlin in 1871, but in 1880 began the publication of a universal history. The volumes of the *Weltgeschichte* published before his death

carry the account to the eleventh century. Two additional volumes were edited by his assistants after his death. The whole was published in nine volumes (1881-88). All his works are of great value to students of history. Among them are: *Die serbische Revolution* (1829), republished as *Serbien und die Türkei im 19. Jahrhundert* (1879); *Die Verschwörung gegen Venedig, 1618* (1831); *Deutsche Geschichte im Zeitalter der Reformation* (1839-47); *Französische Geschichte, vornehmlich im 16. und 17. Jahrhundert* (1852-61); *Englische Geschichte im 16. und 17. Jahrhundert* (1859-67); *Zur deutschen Geschichte vom Religionsfrieden bis zum dreissigjährigen Kreige* (1868); *Geschichte Wallensteins* (1869); *Zur Geschichte Deutschlands und Frankreichs im 19. Jahrhundert* (1887). His collected works are published in 54 volumes, covering the whole range of modern European history. He died in Berlin. Consult his autobiography, *Zur eigenen Lebensgeschichte*, edited by Dove (Leipzig, 1890), vols. liii.-liv. of the collected works; Gugglia, *Leopold von Ranke's Leben und Werke* (1893); Guillard, *L'Allemagne nouvelle et ses historiens, Niebuhr, Ranke, Mommsen, Sybel, Treitschke* (Paris, 1899).

RANKINE, rän'kin, WILLIAM JOHN MACQUORN (1820-72). A Scotch engineer and physicist. He was born at Edinburgh, and studied at the University of that city, where he received honors for essays in physics. He afterwards studied civil engineering and was employed on various railways in Scotland as a civil engineer. He did not in the meantime neglect his theoretical studies and communicated a number of valuable papers to different learned societies. In 1849 he was elected a fellow of the Royal Society of Edinburgh and in this year read his celebrated paper *On a Formula for Circulating the Expansion of Liquids by Heat*. He published in the *Philosophical Magazine* (1851) a paper on the *Centrifugal Theory of Elasticity as Applied to Gases and Vapors*, in which this theory was elaborated. In 1853 he was elected fellow of the Royal Society and submitted to that body a paper on thermodynamics, *On the Geometrical Representation of the Expansive Action of Heat*. After delivering lectures in the university at Glasgow, he was elected regius professor of civil engineering in that institution in 1855, succeeding Prof. Lewis Gordon. Rankine may be considered one of the founders of the science of thermodynamics (q.v.), as with Lord Kelvin (then Sir William Thomson) and Clausius he put in permanent form those parts of Carnot's theory which agreed with the view then being accepted that heat and work are convertible. In applied science his work as an engineer was of a high order, and he was the first president of the Institute of Engineers in Scotland. He was also consulting engineer to the Government and corporations and was a contributor to the *Engineer*. He was the author of the following books: *Manual of Applied Mechanics* (1858); *Manuals of the Steam Engine and Other Prime Movers* (1859); *Manual of Civil Engineering* (1862); *Manual of Machinery and Mill Work* (1869); *Cyclopadia of Machine and Hand Tools* (1869). These have enjoyed a well-deserved and widespread popularity as text-books and have passed through many editions. Rankine was also the corresponding and general editor of *Shipbuilding Theoretical and Practical*

(1866). His *Miscellaneous and Scientific Papers* were published in 1880 and contain a biographical memoir of Prof. P. G. Tait.

RANSOM (OF., Fr. *rançon*, from Lat. *redemptio*, redemption, ransom, from *redimere*, to buy back, redeem, from *red-*, *re-*, back again, anew + *emere*, to buy). A price paid by a prisoner of war, or paid on his behalf, in consideration of his being granted liberty to return to his own country. In early times, when armies received little or no regular pay, the soldier looked for his reward in the booty he might capture, and this booty included the bodies as well as the chattels of the vanquished. The conqueror had the option of slaying his prisoner; but for his profit he would make him his slave or sell him into slavery. The transition would be natural to accepting compensation from the prisoner himself and setting him at liberty. In modern warfare, where the fighting is done by professional or paid soldiers, pecuniary ransoms are scarcely ever resorted to, freedom being granted to prisoners in exchange for others of corresponding rank captured on the opposite side. In international law the term ransom is also sometimes employed to describe a sum paid to redeem captured property, such as ships and the like. For example, a ship captured by a privateer may be redeemed by her owners at an agreed price, and is then entitled to a 'ransom bill' from her captors, that is, an instrument which is supposed to assure her safe conduct to her native ports, provided she follows a prescribed course.

RANSOM, MATTHEW WHITAKER (1826—). An American soldier and statesman, born in Warren County, N. C. He graduated at the University of North Carolina in 1847, and was admitted to the bar in the same year. In 1852 he was Presidential elector on the Whig ticket, and from 1852 to 1855 was Attorney-General of the State. He was a member of the Legislature in 1858-60, and in 1861 was one of the three peace commissioners sent to the Congress of the Southern States at Montgomery, Ala. When his State seceded, he was elected lieutenant-colonel of the First Infantry, June 3d, but was soon made colonel of the Thirty-fifth Regiment. With this he was in the Seven Days' battles, and was twice wounded at Malvern Hill. At Antietam he was in command of the brigade during part of the engagement. After Fredericksburg he served in North Carolina, and when promoted brigadier-general was assigned to the brigade formerly commanded by his brother, Robert. During the Gettysburg campaign he was in command of the Suffolk line, and checked the advance toward Weldon in July. His brigade suffered heavily in the recapture of Plymouth, N. C., in April, 1864. Afterwards he was transferred to Virginia, and served before Petersburg, and on the Crater line. During the latter part of 1864 he commanded a division, though his appointment as major-general was not confirmed. He was particularly complimented by General Lee for the assault on Hare's Hill, March 25, 1865, and was engaged at Five Forks. At the close of the war he engaged in farming until elected to the United States Senate in 1872. He served continuously until 1895, and gained great influence in the Democratic ranks.

RANSOM, ROBERT (1828—). An American soldier, born in Warren County, N. C. He graduated at West Point in 1850. In 1850-51 he was

at the Carlisle Cavalry School, and from 1851 to 1854 served in New Mexico. He was assistant instructor in cavalry tactics at West Point in 1854-55, and became first lieutenant First Cavalry, March 3, 1855. From 1855 to 1857 he was in Kansas and then was on recruiting service or frontier duty until 1861. He was made captain First Cavalry, January 31, 1861, but resigned his commission on May 24th. He was commissioned captain of cavalry in the Confederate Army, organized the First North Carolina Cavalry, and was chosen colonel. In November he commanded at Vienna, Va., in the first cavalry encounter of the war. On March 6, 1862, he was made brigadier-general to reorganize the cavalry in the West and Southwest, but after the fall of New Berne was sent to oppose the Federal forces in eastern North Carolina. During the Seven Days' battles in June-July, 1862, he was attached to Huger's division. In the Maryland campaign, in Walker's division, Longstreet's corps, he took part in the reduction of Harper's Ferry, and was especially commended for judgment and skill at Antietam. At Fredericksburg he commanded the division and had immediate charge of the defense of Mary's Heights. Until May, 1863, he was in charge of the defense of the Weldon railroad, but on his promotion to be major-general was assigned to the district including Appomattox and Blackwater. In October, 1863, he was in command in East Tennessee and Southwest Virginia, and remained until April, 1864, when he was recalled for the defense of Richmond. He opposed Butler at Bermuda Hundred and commanded Beauregard's left at Drewry's Bluff, May 16. In June he commanded Early's cavalry against General Hunter, and in the expedition into Maryland. In September he served as president of the court of inquiry concerning Morgan's operations in Kentucky and in November was assigned to Charleston. Illness compelled him to resign this position, and he surrendered to General Howard at Warrenton, May 2, 1865. For a time he served as express agent and city marshal at Wilmington, N. C., and then engaged in farming until 1878. In that year he was appointed superintendent of the United States harbor and river improvements about New Berne.

RANSOM, THOMAS EDWARD GREENFIELD (1834-64). An American soldier. He was born in Norwich, Vt., studied at Norwich University, and at the outbreak of the Civil War was elected major of the Eleventh Illinois Volunteers. Promoted to be lieutenant-colonel, he took part in the attacks on Forts Henry and Donelson, and distinguished himself at Shiloh. He served on the staff of General Grant, was promoted to be brigadier-general, fought at Vicksburg, and commanded a division in the Red River campaign. He subsequently commanded the Seventeenth Corps in the operations about Atlanta, and was promoted to be major-general. Consult: Wilson, *Sketches of Illinois Officers* (1862).

RANSOME, RAN'SUM, ARTHUR (1831—). An English physician, specialist in pulmonary complaints. He was born in Manchester, and was educated at Trinity College, Dublin, at Caius College, Cambridge, at Saint George's Hospital in London, and in Paris. He lectured on biology at Cambridge from 1857 to 1861, taught hygiene and public health at Owens College up to 1895,

and became fellow of the College of State Medicine. Ransome was lecturer on phthisis before the College of Physicians in 1890, and wrote: *Stethometry* (1876); *Prognosis in Lung Disease* (1882); *Causes of Consumption* (1884); *Treatment of Phthisis* (1896); and *Researches on Tuberculosis* (1897, winning the Weber-Parkes Prize).

RANTERS. An alleged English sect of the Commonwealth period of antinomian views. They were charged with immoral practices and were speedily suppressed. Thomas Fuller, in his *Church History*, associates them with the Familists. Probably many of the stories about them were idle gossip. The Primitive Methodists were also called Ranters because of the violent physical phenomena which attended their worship.

RANTOUL, रान्तूल, ROBERT, JR. (1805-52). An American lawyer and political leader. He was born in Beverly, Mass., graduated at Harvard in 1826, was admitted to the bar in 1829, and established himself in practice at Gloucester. He rapidly won distinction in his profession, became one of the leading supporters of Andrew Jackson in the State, and from 1834 to 1838 was a member of the Legislature. He was a member of the first commission to revise the laws of Massachusetts, and in 1837 was appointed by Governor Edward Everett a member of the first State Board of Education. In 1838 he removed to Boston, where his connection with several legal cases of great importance added to his growing reputation. In 1843 he was appointed Collector of the Port of Boston, and from 1845 to 1849 was United States District Attorney. In 1852 he defended Thomas Sims, the first slave reclaimed under the Fugitive Slave Act from New England. In 1851 he was elected to the United States Senate to fill out the remainder of the term of Daniel Webster, and in November of the same year was elected to Congress as the candidate of Democrats and Free Soilers. His strong opposition to the Fugitive Slave Law and to the general pro-slavery policy of the Democratic Party led to his exclusion from the convention of 1852, which nominated Franklin Pierce for the Presidency.

RANULA (Lat., little frog; so called from a fancied resemblance of the form of the swelling to a frog). A cystic tumor on the floor of the mouth due to obstruction and dilatation of one of the several ducts of the salivary glands or mucous follicles, opening under the tongue. The tumor contains a glairy fluid, resembling mucus or saliva, and as it increases in size pushes the tongue to the opposite side. Ranula is not painful, and these tumors sometimes reach a considerable size before relief is sought. The usual method of treatment is by free incision, or by removing a portion of the sac wall; if this is not effective, and the sac refills, the interior is touched with a caustic such as nitrate of silver or pure carbolic acid, to produce an adhesive inflammation of its walls.

RANUNCULACEÆ (Neo-Lat. nom. pl., from Lat. *ranunculus*, sort of medicinal plant, diminutive of *rana*, frog), CROWFOOT FAMILY. A natural order of about 700 widely distributed species of dicotyledonous herbs or sometimes shrubs, and, with few tropical exceptions, natives of cold damp climates. Acridity is the prevailing character of the order, a property which

disappears or is greatly reduced by drying or heating. Some are reputed poisonous; some are used in medicine; some have been used as food. Many of the species produce beautiful flowers, e.g. *ranunculus*, anemone, larkspur, peony, columbine, clematis (qq.v.). The classification and chief genera according to Prantl are as follows: *Paonica*—*Paonia*; *Helleboreæ*—*Caltha*, *Trollius*, *Helleborus*, *Nigella*, *Actæa*, *Aquilegia*, *Delphinium*, *Aconitum*; *Anemoneæ*—*Anemone*, *Clematis*, *Ranunculus*, and *Thalictrum*.

RANUNCULUS. A genus of about 250 species of mostly perennial herbs of the natural order Ranunculaceæ, some of them (crowfoots and buttercups) common in pastures and gardens, many (spearworts) in moist places, others wholly aquatic. *Ranunculus Asiaticus*, Asiatic ranunculus, or garden ranunculus, a native of the Levant, has been cultivated by florists in Europe for almost 300 years. From clusters of small tubers develops an erect branched stem, bearing bipartite leaves, and in the numerous cultivated varieties, large single or double terminal flowers, of various brilliant colors. The ranunculus is propagated by seed, by offset tu-



BUTTERCUP (*Ranunculus bulbosus*).

bers, or by dividing the clusters of tubers, which may be taken up in summer, after the leaves die, and for greenhouse work planted in rich friable soil in late autumn or for outdoor use in early spring. *Ranunculus Ficaria*, sometimes called pilewort and lesser celandine, a very common European species escaped from gardens in the vicinity of New York, Philadelphia, and elsewhere, is used as a pot-herb, and the small tubers are used for food, their acridity disappearing when they are boiled. *Ranunculus acris*, *Ranun-*

culus repens, etc., abundant in pastures, are supposed to give an unpleasant taste to milk and butter if eaten while fresh by cattle, but their acidity is lost in drying, and they are not injurious to hay, except as they are less desirable than grass, clover, etc. See Plates of BUTTERCUP; DICOTYLEDONS.

RANVIER, rān'vyá', LOUIS ANTOINE (1835—). A French histologist, born in Lyons. He studied medicine there and in Paris; received his degree in 1865; was adjunct of the histological laboratory in the Collège de France until 1875, when he was promoted to the chair of general anatomy; and was elected to the Academy of Medicine in 1886, and in 1887 to the Academy of Sciences, in the zoölogical section. His works, which cover almost every branch of histology, include: *Leçons d'anatomie générale* (1878-79); *Manuel d'histologie pathologique* (with Cornil, 1869-72); *Traité technique d'histologie* (1875-88; in German and Russian versions also); and *Leçons d'anatomie générale sur le système musculaire* (1890).

RANZ DES VACHES, räns dá vâsh (Swiss Fr., lowing of the cows, or, line of the cows). A name applied to certain simple native melodies of the Swiss Alps, which are usually sung by the herdsmen, and played by them when driving their herds to and from the pasture, on the alpenhorn (q.v.). It is a peculiarity of this music that it is seldom in tune, owing to the presence of the eleventh overtone (a tone between f^2 and $f^{\sharp 2}$) on the alpenhorn. Its principal characteristics are rising and falling broken chords, repetitions, and (when sung) the use of the *jodler*. A collection of ranz des vaches, along with other Swiss melodies (*Sammlung von Schweizer Kuhreigen und Volkliedern*), was published at Berne, in 1818; and these airs are also to be found in the *Allgemeines Schweizer Liederbuch* (1851). The ranz des vaches of Switzerland are ruder in their character than the mountain melodies of the Tyrol, with which they are sometimes confounded.

RAOULT, rá'ool', FRANÇOIS MARIE (1830-1901). A French chemist, born at Fournes, Nord, and educated in Paris, where he became doctor of physical science in 1862. He became professor of chemistry (1870) and then (1889) dean of the faculty of science in the University of Grenoble. His earlier studies were in electro-chemistry; but he is better known for his work on the freezing point and boiling point of solutions. About 1884 he discovered the general law of the freezing of solutions, demonstrating that the depression of the freezing point of a liquid, caused by dissolving in it equal quantities of substances, is inversely proportional to the molecular weights of the latter. In 1886 he produced experimental evidence showing that a similar law holds good for the vapor-tension (and hence the boiling point) of solutions. Raoult's researches thus furnished the experimental basis of the modern theory of solutions, developed principally by Van't Hoff and Arrhenius. The importance of this theory cannot be overestimated. But the immediate practical value of Raoult's laws lies in the fact that they permit of determining the molecular weight of innumerable substances that are non-volatile, but that are soluble in some liquid. See SOLUTION; MOLECULES—MOLECULAR WEIGHTS; FREEZING POINT; BOILING POINT; DISSOCIATION.

RAOUX, rá'oo', JEAN (1677-1734). A French genre and portrait painter, born at Montpellier. He was a pupil of Ranc, in his native city, and of Bon Boulogne in Paris, where he won the Prix de Rome in 1704. His reception picture "Telemachus and Calypso" is in the Louvre. Most of his works are portraits of actresses as mythological personages. These include Mlle. Prevost as a Baechante, and Mlle. Quinant as Amphitrite, and subjects such as "Young Girl Reading a Letter," in the Louvre, and "Flora," in the Historical Society, New York City. His style is graceful and pleasing, but artificial. There are works by him at Versailles, Berlin, and in the Hermitage at St. Petersburg.

RAPALLO, rá-päil'lo. A winter resort in the Province of Genoa, Italy, situated on the Gulf of Genoa, 16 miles by rail east by south of Genoa (Map: Italy, D 3). Rapallo has manufactures of lace and olive oil, and fisheries of coral and tunny. Population (commune), in 1901, 10,765.

RAPE (from ME., MLGer. *rapen*, to seize, snatch, Ger. *rafen*, to snatch, Eng. *rap*, to carry away, seize, confused with the unrelated Lat. *rapere*, to seize). The crime of having carnal knowledge of a woman against her consent and by force. The essence of the offense is that force be used, and it is immaterial what is the age of the woman, and whether she is married or single, chaste or unchaste. The only difference caused by the habitual unchastity of the woman is that in such a case it is less easy to satisfy the jury that the element of consent was wanting. The two elements of rape are the carnal knowledge and the force used. As to the element of resistance on the part of the woman, or force on the part of the man, several niceties often occur in the application of the law, from the great variety of circumstances attending this crime. With regard to an idiot woman, or an infant of tender years, it has been held that it is not necessary to prove resistance on her part, and that the crime may be committed though she made no resistance. If consent be extorted by fear and threats, or where several men join together, and resistance is useless, this is the same as using violence to overpower the woman. Where the woman is stupefied by drink so that the power of resistance is annihilated it is the same as knocking her down. In case force is used in the first instance, but the woman afterwards consents, the crime of rape will not be committed, though the evidence may establish the crime of assault. Some difficult cases have occurred with reference to married women who have been beguiled by men personating their husbands, and so been, in a sense, cheated out of their consent. But it has been repeatedly decided by courts, both in England and America, that such an offense was not rape. Other courts have held it to be rape, declaring that the act which the woman permitted under such deceit cannot properly be regarded as the real act which took place. Modern statutes have declared this to be the right view. They frequently, also, punish the carnal knowledge of girls under sixteen years of age, whether they have given consent or not.

One of the important circumstances attending the crime of rape is the mode of proof, and in this respect it differs from other crimes. It is held to be all but essential, as a corroboration of the woman's story, that if her cries of resistance

were not heard, at all events she should have, immediately after the offense, complained on the first opportunity to her friends or relatives. It is not allowed to give in evidence the particulars of such complaint, but merely the fact that she made a complaint against some person. Unless this important particular be proved, her evidence is looked upon with great suspicion, and may be discredited by the jury. One of the common defenses to a charge of rape is the unchastity of the woman, the object being to render it unlikely that she did not consent, and hence it is in practice considered a proper question for the prisoner's counsel to put to her whether she had not had connection with the prisoner before or with other men; but at the same time she is cautioned by the judge that she is not bound to answer such questions unless she likes. If, however, she denies the accusation, witnesses may be called to contradict her on that point.

At common law, a boy under fourteen years of age was conclusively presumed incapable of the crime of rape. By statute, in many of our States, this presumption may be rebutted by evidence. Consult: May, *The Law of Crimes* (Boston, 1893); Beale, *Cases on Criminal Law* (Cambridge, Mass., 1894); Clark and Lindsall, *A Treatise on the Law of Crimes* (St. Paul, 1900).

RAPE. A division of the county of Sussex, England. See SHIRE.

RAPE (from Lat. *rapa*, *rapum*, Gk. *ράπυς*, *rhapyς*, *ράφως*, *rhaphys*, turnip). *Brassica campestris*. A European and Asiatic herb of the natural order Crucifera, resembling a turnip in general growth, but with a spindle-shaped root. It is widely grown in Europe for the oil expressed from its seed ('coleseed') and for its foliage, which is an important stock food. In America the latter is its only use. The very leafy plant grows from 1 to 3 feet tall and is cultivated either broadcast or in drills like turnips in deep rich well-drained friable soil and in cool climates. It is a valuable green manure, since it effectively smothers weeds. It is especially esteemed as a sheep food. For dairy cattle it is less useful, since, unless fed with caution, it may unpleasantly flavor the milk.

RAPE OF LUCRECE, THE. (1) A poem by Shakespeare (1594), founded on the story of Lueretia and Tarquinius Sextus. (2) A drama by Thomas Heywood (1630).

RAPE OF THE LOCK, THE. A mock-heroic poem by Alexander Pope (1712), enlarged in 1714, written to smooth over a quarrel caused by young Lord Petre's cutting off a lock of Miss Arabella Fermor's hair. The poem describes this incident with airy grace and vivacity, delicately satirizing the social life of the time.

RAPE OF THE SABINES. A fine marble group, the work of Giovanni da Bologna (1583), representing a young Roman carrying off a woman of the Sabines over the body of a prostrate warrior. It stands in the Loggia de' Lanzi in Florence. The same subject is treated in a painting by Giordano, in the Dresden Museum, and in one by Rubens, in the National Gallery in London.

RAPHAEL SANTI, rä'fä-ël sän'tè (1483-1520). The most celebrated painter of modern times, also noted as an architect. The modern Italian form of his name is Raffaello, and his

family name is often written Sanzio. He was born at Urbino, on Good Friday (March 28th), 1483, according to Vasari, but according to the inscription upon his tomb by Cardinal Bembo, on April 6th. His father, Giovanni Santi (q.v.), was a painter of some merit and a poet, and his mother, Magia, was the daughter of Battista Ciarla, a merchant of Urbino. Of Raphael's youth almost nothing is known. His mother died in 1491, and he came under the care of a young stepmother, against whom he appeared in a lawsuit after his father's death in 1494. He probably received a good education, and grew up in the refined and artistic atmosphere of the Court of Urbino. Like his father, he stood in high favor with Duke Guidobaldo and his wife, and especially with Giovanna delle Rovere, the Duke's sister. He acquired the rudiments of painting from his father, inheriting from him a genial eclecticism, but, by reason of the father's early death, his real instruction began with another master. According to the former view, based upon Vasari, he studied with Perugino at Perugia; but Perugino's movements before 1499 render this view extremely unlikely. Morelli has shown that Raphael's earliest works resemble those of Timoteo Viti (q.v.), an Umbrian painter, who was a disciple of Francia at Bologna, and resided at Urbino between 1495 and 1500, of whom we also know that he was a friend of Raphael. As Perugino did not return to Perugia until 1499-1500, it was probably then that Raphael became his assistant. He imitated his master so closely that their works of this period are very difficult to distinguish. He was also much influenced by Pinturicchio, though it is doubtful whether he assisted him, as Vasari states, in the frescoes of the Cathedral of Siena. Very important for this early period is the so-called Raphael's "Sketch Book" in the Academy of Venice, a collection of drawings by various Umbrian masters, which Morelli has shown are mainly by Pinturicchio, though a few are probably by Raphael after his designs.

All the works of Raphael up to the time of his removal to Florence in 1504 belong to his Umbrian period. The earliest, according to Morelli, is a small "Saint Michael" in the Louvre, which also possesses "Apollo and Marsyas" and "Saint George and the Dragon" of the same period. Best known of all is the charming "The Knight's Dream" (National Gallery, London), an allegory, resembling the mythical vision of Hercules. These works closely resemble those of Timoteo Viti, in form and miniature-like execution, as well as in a delightful poetic sentiment. For Raphael's Madonnas of the Umbrian period, see MADONNA.

Raphael's more ambitious works resemble Perugino's, except that with him everything is more refined and artistic, the space composition is better, the execution more careful and powerful. After the departure of Perugino in 1502 he appears as an independent master at Perugia in his "Coronation of the Virgin," now in the Vatican Gallery. He executed three important altarpieces in the neighboring Citta di Castello, two of which survive—one, a "Crucifixion," being in the possession of Mr. Mond in London, the other, the famous "Sposalizio" (Marriage of the Virgin), in the Brera, Milan. The latter is generally supposed to be a copy of the same subject by Perugino at Caen, though

Berenson has lately pronounced the Caen picture a copy of Raphael's picture by Lo Spagna. Raphael's work is infinitely more refined and symmetrical, and is perhaps the most important of his Umbrian period. Morelli has justly assigned to Raphael the realistic portrait of Perugino in the Borghese Gallery, Rome, formerly attributed to Holbein.

Equipped with a letter of introduction from the Duke of Urbino's sister to Soderini, the gonfalonier of Florence, Raphael removed to that city in 1504. The opportunities for the development of a young artist were at that time the most favorable imaginable. Florence was in an artistic ferment over the battle of the giants, Michelangelo and Leonardo, in their rival cartoons for the Palazzo Vecchio (see MICHELANGELO; VINCI), and Fra Bartolommeo had just returned to the brush with new designs and ambitions in art. The youthful Raphael studied the frescoes of Masaccio in the Brancacci Chapel, whose "Adam and Eve" we recognize in his own Vatican frescoes, and the sculpture of Donatello, as may be seen in his admirable replica (1506) of the Louvre "Saint George," now in the Hermitage, Saint Petersburg, into which he has introduced the dramatic action of one of Donatello's reliefs in Orsanmichele. From Leonardo he learned modeling and chiaro-oscuro; from Michelangelo anatomy and dramatic action; from Fra Bartolommeo composition and the art of enlivening statuesque groups by contrasts. His intense diligence is proved by his surviving sketches of Michelangelo's and Leonardo's cartoons, and by the innumerable studies for his pictures. Though usually begun with his adoption of a figure or an idea of some other master, his studies end in something quite Raphaelesque.

Raphael's development during the Florentine period can best be traced in his Madonnas, in which the influence of the various masters is most apparent. Though, like the Florentine, he portrays the simple relation of mother and child, his works are essentially original in the earnestness of form, the elimination of the accidental, and in the absolute harmony of all parts both in color and line. The first early example is the "Madonna del Gran Duca" (Pitti Palace), still Umbrian in the draperies and rather resembling Timoteo Viti than Perugino. The transition from fourteenth-century Umbrian to Raphael's own style is seen in the four delightful examples at Berlin, Vienna, Florence, and Paris, in which the Virgin is represented with the infants Christ and John in the midst of a beautiful landscape. All show the influence of Leonardo in sentiment and composition, and the last named, "La belle jardinière," is one of the most perfect of Raphael's creations. The last of Raphael's Madonnas executed at Florence, the "Madonna del Baldachino" (Pitti), a monumental altarpiece, shows his close association with Fra Bartolommeo. Similar in character with the Madonnas are his less numerous "Holy Families," at Madrid, Munich, and especially the one with the beardless Joseph at Saint Petersburg.

Raphael's most important commissions during his stay in Florence came from Umbria. In 1505 he executed for the convent and chapel of San Severo in Perugia the fresco the "Adoration of the Trinity," a well-balanced composition, re-

mindings somewhat of Bartolommeo's "Last Judgment." For Lady Atalanta Baglione of the ruling family of Perugia, he executed "Entombment of Christ" (Borghese Gallery, Rome), an altarpiece in memory of her murdered son. This is his most original composition of the Florentine period, and shows the influence of Michelangelo. Two apostles of Herculean strength bear to the tomb the body of Christ mild and beautiful in death, while Magdalen clasps his hand, and in the background the Virgin sinks into unconsciousness. To the same period belongs the beautiful three-quarter figure of "Saint Catharine" in the National Gallery, London. Of his portraits the chief are those of Angelo Doni and his wife (1505), the latter recalling Leonardo's "Gioconda," the "Donna Gravida"—all in the Pitti Palace—and Raphael's own youthful likeness in the Uffizi. All of these date from the early part of his Florentine period.

From a letter of Raphael's, dated April 21, 1508, we know that he was then still in Florence, but from another of September 5th, that he was at Rome in the service of the Pope. His fellow citizen of Urbino, the architect Bramante, induced Julius II. to call him thither. With his accustomed tact in making the best use of artists, the Pope commissioned him to fresco four chambers of the Vatican. They were small, irregularly built, and poorly lighted, but Raphael, aided by the advice and assistance of Bramante, transformed them into spacious halls, with far vistas and beautiful architectural effects. In this work the development of his art during the Roman period may best be traced. The first room which he decorated was the Camera della Segnatura (1509-11), so called from the Papal signatures written there. It is by far the best, because executed almost entirely by his own hand. The general plan of the decoration was to represent the four spiritual powers "Theology," "Philosophy," "Poetry," and "Justice," typified by beautiful female figures occupying medallions in the ceiling of the room. On one of the large walls, under "Theology," is the celebrated "Disputa," in two divisions. Grouped about an altar on the earth below, grave theologians and laymen are discussing the mystery of the Trinity. One of them points upward, where, in the hierarchy of the heavens, the mystery is revealed. While this work is still Florentine in character, the wall under "Philosophy," the "School of Athens," shows a more independent and classic art. The scene is laid in a beautiful architectural hall, in which all the philosophers and wise men of antiquity, grouped about Plato and Aristotle, are discussing the problem of life. Among the philosophers to the right Raphael has introduced his own portrait and that of Sodoma. Upon the irregular wall under "Justice" are three representations typifying civil and canon law. Under "Poetry," esteemed by many the most beautiful female figure which Raphael ever painted, is the celebrated "Parnassus." Surrounded by the Muses, Apollo sits on a mountain which is so painted as not to be disturbed by an intervening window, and in the spaces on either side are the great poets of Greece, Rome, and Italy.

The second chamber, the Stanza d'Eliodoro (1512-14), represents the triumph of the Church over its temporal foes and over false doctrine.

The medallions and the beautiful decorations of the ceiling are after Raphael's designs, but the wall paintings were executed, at least in part, by himself. The conception is somewhat disturbed by the introduction of Papal portraits into three of the frescoes, but granting this necessity, the composition could not have been better done. The "Expulsion of Heliodorus from the Temple," a painting of mighty dramatic power, symbolizes the expulsion of Charles VIII. of France from Italy. "Attila and Leo the Great" is a remarkable composition, designed almost entirely of horsemen. The "Miracle of Bolsena" shows how the host was changed into blood under the eyes of an unbelieving priest, and over the other window "Peter's Release from Prison" is remarkable for its portrayal of the gloom of the night, under the triple illumination of the moon, torches, and the apparition of the angel. The paintings of this room, particularly the one last mentioned, are Raphael's most remarkable coloristic production, and show the influence of the Venetian Sebastiano del Piombo, who was at that time in Rome. They also show, in the splendid dramatic action, a further influence of Michelangelo, probably derived from frescoes in the Sistine Chapel. This is still more evident in the fresco of "Isaiah" (1512; San Agostino), and in those of the "Sibyls" (1514, Santa Maria della Pace), in which Raphael enters the list as a rival of Michelangelo. A third important influence upon Raphael's art was that of the classic monuments of Rome; but he harmonized all of these factors into an individual art of his own.

Before the death of Julius II. in 1513, Raphael assumed an important position at the Papal Court, and under Leo. X. his influence increased. Upon the death of Bramante, in 1514, he was made chief architect of St. Peter's, at his dying predecessor's request, and in 1515 he was appointed conservator of all the excavations of antiquities in and near Rome. The greatest statesmen and humanists of the day sought his friendship, and kings requested, as an especial favor, a work of his hand. He attended court with a following of fifty painters, and lived like a prince. Under such circumstances it was impossible for him to execute the remaining decorations of the Vatican with his own hand. He was compelled to intrust them and the execution of his architectural and other designs to his numerous pupils. His compositions became grander than ever, even though the execution suffered. The celebrated engraver Marcantonio Raimondi (q.v.) was entirely occupied in carrying out his designs for prints.

The third chamber of the Vatican, the Stanza del Incendio (1514-17), is decorated with historical scenes from the lives of Leo III. and Leo IV., the best of which, the "Incendio del Borgo," after which the room is named, represents Leo IV. miraculously extinguishing a fire at Rome. It is a wonderful piece of dramatic realism. Of the fourth chamber, the Sala Constantina, the designs only were furnished by Raphael, and of these only two were used, the principal of which, the "Victory of Constantine Over Maxentius," was executed by Giulio Romano. Near by are the decorations of the Loggie of the Vatican, which, of all his works, show the highest influence of the antique. The adornment is mainly of grotesques, copied after the Roman models lately

discovered in the Baths of Titus, and on the ceiling is the so-called Raphael's Bible, fifty-two pictures of biblical subjects executed by Giulio Romano.

But the most powerful decorative work of Raphael's later life is the ten delicately colored cartoons for the tapestries which hung upon the walls of the Sistine Chapel. The original tapestries are still in the Vatican, and there are copies at Berlin, Dresden, and Madrid, but only seven of the cartoons survive—all of them showing wonderful technique and power. The two best are the "Miraculous Draught of Fishes" and "Peter and Paul Preaching." For his friend Agostino Chigi he also designed the architecture and decorations of the Chigi Chapel in Santa Maria del Popolo, and the beautiful decorations of the Villa Farnesina. Of these, the fresco "Galatea" (1514) is perhaps the most perfect of all modern mythological pictures. In it the antique lives again, executed, however, with the more naturalistic technique of the sixteenth century. Raphael's talent as a narrator was never more perfectly exhibited than in the Farnesina with his story of "Cupid and Psyche" (1518-20), which, though executed by his pupils, contains some of the best modern versions of antique mythology. Especially beautiful is the fresco of "Jupiter Kissing Cupid," in which the majesty of old age and the beauty of youth are charmingly contrasted.

Along with these greater undertakings Raphael executed numerous easel pictures. His portraits are admirable realistic productions with a strong and unaffected conception of character, belonging, indeed, to the greatest portraiture that has ever been produced. Among the principal examples, besides those wonderful likenesses in his frescoes, is that of "Julius II.," surviving in a number of examples, of which the original is probably in the Pitti Palace. The old man is represented as seated in an arm-chair, engaged in deep meditation. Other celebrated specimens are the portraits of Leo X. (1518) with two cardinals, a splendid piece of realism; of Cardinal Bibbiena, of which the original is at Madrid, and a good replica in the Pitti Palace; of Tommaso Ingherami at Volterra; of Baldassare Castiglione and Joanna of Aragon, in the Louvre; and the beautiful "Donna Velata," the prototype of the Sistine Madonna, in Pitti Palace. The celebrated "Fornarina," formerly supposed to be a portrait of Raphael's beloved, is now attributed to Sebastiano del Piombo (q.v.).

Among his religious pictures, the greater number were Madonnas, most of them executed by his pupils. (For an enumeration and description, see MADONNA.) The best example of his early Roman period is the "Madonna della Sedia" or "Seggiola" (Pitti Palace), so called from the chair upon which she is seated. The Virgin is represented as a beautiful Italian woman in picturesque Roman folk costume. The expression of sublime maternal love in this picture has never been excelled. The last and grandest of all of his Madonnas, the consummation and perfection of all such efforts, is the "Sistine Madonna" (Dresden Gallery). Painted as an altarpiece for the Church of San Sisto at Piacenza, it was finished just before Raphael's death. The Virgin is not represented as a mother, but as the all-powerful Queen of Heaven descending from the



RAPHAEL

"SISTINE MADONNA," FROM THE PAINTING IN THE ROYAL GALLERY, DRESDEN

clouds, which are themselves composed of the heads of thousands of cherubs. The Christ-child looks with thoughtful eyes, as if conscious of his destiny as a Saviour of the world, while on either side Saint Sixtus and Saint Catherine kneel in adoration. At the base of the picture are the two celebrated cherubs.

His other religious pictures typify the waking religious consciousness of Italy in reply to the Reformation of the North: "Lo Spasimo di Sicilia" (Christ sinking beneath the Cross) (Madrid); "The Vision of Ezekiel" (Pitti Palace), minute in execution and beautiful in color; the celebrated "Saint Cecilia" (1515, Bologna), surrounded by four saints, listening with varied expressions of ecstasy to the heavenly chords; "Saint Michel Crushing Satan" (1518, Louvre); and "The Transfiguration" (Vatican), left unfinished at Raphael's death, and completed by Giulio Romano.

As an architect Raphael was not of the same importance as a painter. He was a disciple of Bramante, whose plan of Saint Peter's he continued, though he also had one of his own. (See SAINT PETER'S CHURCH.) The Farnesina is usually ascribed to Perruzzi, and of his other palaces the Palazzo Pandolfini at Florence is the only one carried out in accordance with his plans. His chief work, the Villa Madama, built about 1516 for Cardinal Giulio de' Medici, displays forms of simple majesty. As a sculptor he is reputed to have carved the "Boy Astride of a Dolphin" (Saint Petersburg), but the attribution is doubtful. He also tried his hand at poetry, but his few sonnets are amateur in character.

Raphael died on Good Friday (April 6), 1520, at the age of thirty-seven, as a result of a fever contracted during the excavations in Rome. All Rome mourned over his loss, and he was interred with great honor in the Pantheon. His character, like his art, was a perfect harmony of the elements which go to make life beautiful, and his contemporaries valued the one as highly as the other.

The opinion of Raphael's contemporaries, that his work was the highest perfection of pictorial art, has met with dissent among certain modern artists and critics, who find him lacking in this or that technical quality. But while he did not attain the very highest in all technical qualities, perhaps no other man possessed in such a high degree so many qualities which go to make up the perfect artist. His work embodies the best of all the Middle Italian schools, and it is, in this sense, the culmination of Italian painting. To whatever he adopted he added a harmony and grace, distinctly his own, attaining the nearest to the universal of any artist since the Greeks. And in one purely technical quality Raphael has never been surpassed by any artist. In his small pictures as well as in his great frescoes, in arrangement as well as in the treatment of space, his composition is faultless.

The chief cause of Raphael's great popularity with the general public is that he was what Berenson calls 'a lovable illustrator.' With an imagination that has never been surpassed, he has, better than any other one, embodied our conception of antiquity, translating it into forms surpassing our fairest dreams. He has Hellenized the Hebraic universe, creating, in place of the stern personages of the Old and New Testament,

those beautiful, ideal types which will last as long as art lasts. In his Madonnas and ideal figures he has created the types of womanhood which "embody for the great number of cultivated men their ideals and spiritual aspirations."

BIBLIOGRAPHY. The chief original source of information remains the biography of Vasari (ed. Milanesi, Florence, 1878; English translation by Blashfield and Hopkins, New York, 1896). The biographies of the eighteenth and early nineteenth centuries are antiquated, except those of Rumohr (Berlin, 1831), and Passavant (Leipzig, 1839; Eng. trans., London, 1872), which contains a valuable catalogue of Raphael's works. The numerous volumes of Gruyer (Paris, 1864, et seq.) are full of copious information. Other biographies are those of Wolzogen (Leipzig, 1865; Eng. trans., London, 1866); Förster (Leipzig, 1867); Grimm (ib., 1872; Eng. ed., Boston, 1888); Perkins (ib., 1878); Lübke (Dresden, 1882); Minghetti (Bologna, 1885); Riepenhausen and Dohme (Berlin, 1888); Clément (Paris, n. d.); Lützwow (Vienna, 1891); Cartwright (London, 1895); Knackfuss (Leipzig, 1895); and Strachey (London, 1900). The most important modern works are those of Anton Springer (Leipzig, 1878), a scientific, appreciative, and impartial production; Eugène Müntz (Paris, 1881), remarkable for its illustrations; Crowe and Cavalcaselle (London 1882), erudite and careful. The best technical criticisms on Raphael's early period, and, indeed, on many of his later works, are those of Morelli, in his *Italian Masters* (London, 1892-93), who has almost revolutionized current opinion. For his early period consult also monographs of Seidlitz (Munich, 1891) and Gronau (Berlin, 1902); for a good characterization and list of Raphael's works, Berenson, *Central Italian Painters* (New York, 1897). For his architectural works, consult: Pontani (Rome, 1845); Geymüller (Milan, 1883); and Hofmann and Bloch (Dresden, 1900). For his drawings, see the studies of Koopmann (Marburg, 1895-97) and Fischell (Strassburg, 1898).

RAPHANIA. Another name for Ergotism (q.v.).

RAPHELENGH, rá'fá-lěng', or **RAPHE-LING,** FRANCIS (1539-97). A Flemish scholar and printer, born at Lannoy, in French Flanders. He studied classical and Oriental languages in Paris, and afterwards taught Greek at Cambridge. Upon his return to the Netherlands in 1565, he entered the printing office of Christopher Plantin, in Antwerp, where he did valuable editorial work, and supplied original matter for books, in the form of notes and prefaces. He also worked on the Polyglot Bible, printed at Antwerp in 1571, by order of Philip II. of Spain. Afterwards he was appointed professor of Hebrew and Arabic at the University of Leyden. He published a Hebrew grammar and Chaldee and Arabic dictionaries.

RAPHIDES, rá'f-t-děz (Neo-Lat. nom. pl., from Gk. *ῥαῖς*, *rhap̄is*, needle, pin, from *ῥάπτειν*, *rhap̄tein*, to sew). Elongated, needle-shaped parallel crystals of calcium oxalate occurring in plants. It has been claimed that they protect plants against herbivorous animals, but investigation shows that injuries follow the eating of plants containing them. Raphis-bearing cells are found in great quantities in the parenchyma of mon-

ocotyledons, such as *Amaryllis*, *Crinum*, *Narcissus*, and *Hyacinthus*.

RAPIDAN. A small river of Virginia, tributary of the Rappahannock (q.v.), which it joins 10 miles above Fredericksburg.

RAPID-FIRE GUNS. Cannon for firing at moving objects and for delivering a heavy fire at critical periods of an engagement. The desired rapidity of fire is obtained by using fixed ammunition; that is, ammunition in which the projectile and charge are put up in one piece. After the limit of size for machine-gun action had been reached the advantages of rapid fire to guns of calibres large enough to be effective against torpedo boats was appreciated, and 3-pounders, and then 6-pounders were made by Hotchkiss and Nordenfelft, with one barrel and worked by hand, but with quick-opening mechanism and fixed ammunition. This movement progressed and developed to a remarkable extent between 1890 and 1900, heavier and heavier guns being required as torpedo boats increased in size and protection to their boilers (by coal, etc.)—the limit being the weight of charge conveniently handled as one piece, about 5 inches calibre.

The development of rapid-fire guns may be said to date from toward the end of the year 1881, when the British Admiralty advertised for designs of a gun that should fulfill the following requirements, viz: The weight of the gun and mount not to exceed ten hundredweight (1120 pounds); the projectile to weigh 6 pounds and have a muzzle velocity of not less than 1800 feet per second; the projectile and powder to be made up in one cartridge; the service of the gun to require not more than three men; under the above-mentioned conditions, the gun to be capable

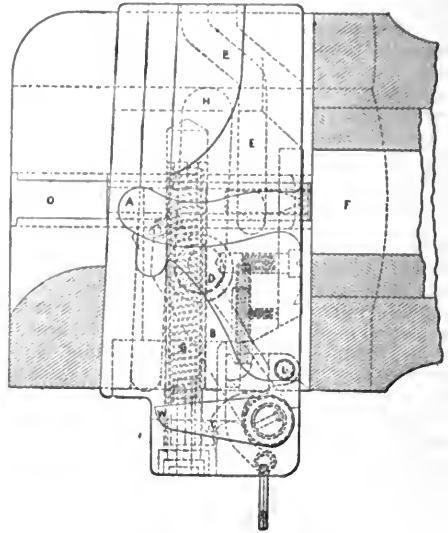

HOTCHKISS RAPID-FIRING GUN.

(American Ordnance Company Type.)

Breech Mechanism—vertical section. A, groove in which crank stud works as the block moves up and down when the crank is turned; B, hammer; C, lug which transmits pressure of main spring to hammer; D, stop bolt (on left side of gun—keeps block from falling out); E, guide slot in which works lug (P) on extractor; F, bore of gun; G, main spring; H, guide-bolt slot; J, crank; K, crank handle; L, pivot of sear; M, sear; N, extractor; O, extractor slot in left face of the housing of the breech; P, extractor lug which travels in slot E; Q, stop bolt; R, rocking shaft on which is the cocking toe; S, breech block; T, face plate; U, mainspring case; V, sear spring; W, cocking cam.

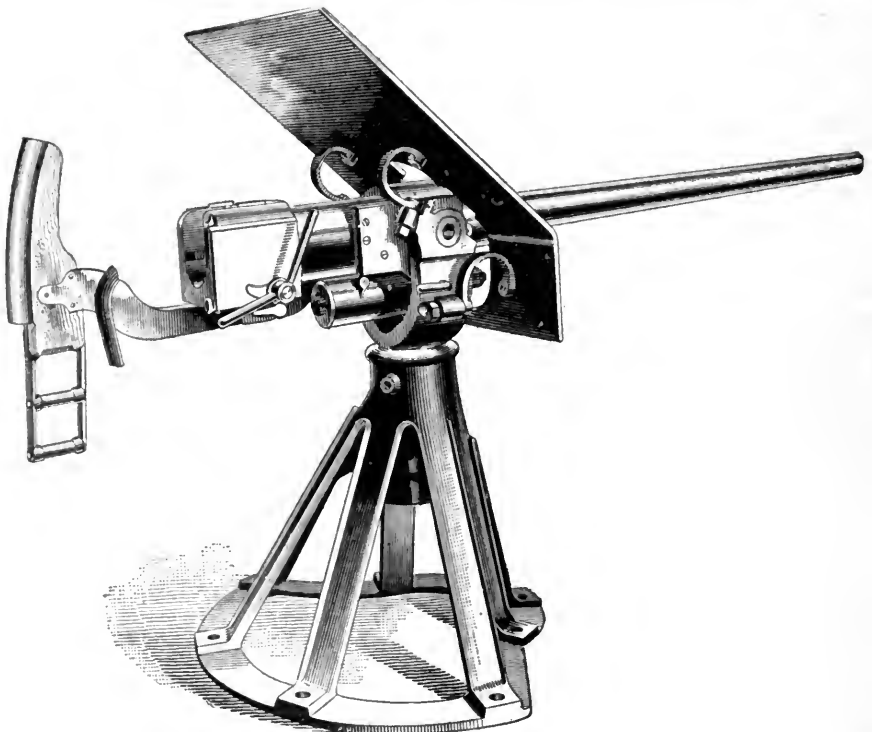

HOTCHKISS 6-POUNDER WITH DECK MOUNT.

of firing at least twelve aimed shots per minute. About the same time the French Department of Marine invited designs for a 3-pounder to fulfill relatively the same conditions. These two advertisements resulted in the production of the rapid-fire gun. Mr. Hotchkiss, an American who had established works in France, brought out a series of guns, 1, 3, and 6 pounders, and it is perhaps interesting to learn that the first order placed with him was from the United States Navy Department. Mr. Nordenfeldt brought out similar guns in England. The 3-pounder and 6-pounder rapid-fire guns advertised for by France and Great Britain were intended for use against torpedo boats, and it was considered that the calibres selected were amply large. Later experience has modified this view, but it must be remembered that the torpedo boats of 1881 were small, slow, and weak. Rapid-firing guns soon began to increase in size. In a short time the calibre of 6 inches was reached, but the fixed ammunition was found to be unwieldy and easily sprung out of shape. The next step was the separation of the projectile and powder in the larger guns, but retaining the brass case for inclosing the powder charge. The speed of fire in these guns was not reduced by the change, as the separate parts of the ammunition were more easily and rapidly handled.

tion at the same time. The system was almost immediately adopted for use in the new guns of the United States Navy, and it bids fair to be universally accepted for guns of 5-inch calibre and over.

In 1897 Messrs. Vickers Sons & Company brought out a new type in which no powder case

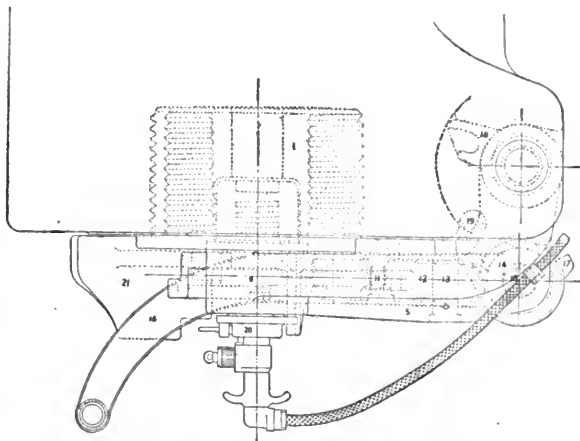

VICKERS-MAXIM BREECH MECHANISM.—HORIZONTAL SECTION.

The increased speed of fire in the intermediate calibres naturally led to a general improvement in the loading mechanism of all guns, and it is now safe to say that the rate of fire of large guns has been doubled in the past four or five years and gains are constantly being made. Krupp brought out what he called a *rapid-fire* 24-centimeter (9.45-inch) gun four or five years ago and in 1900 a 'rapid-fire' 28-centimeter piece, but they are not faster working than the new pieces of like calibre in the United States, British, and

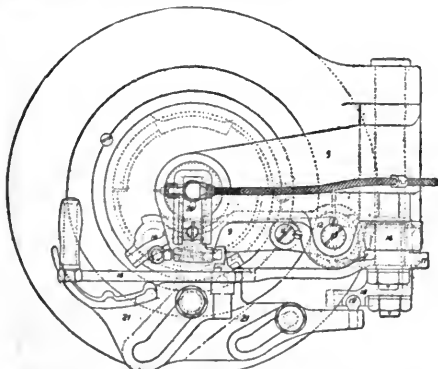

VICKERS-MAXIM BREECH MECHANISM FOR 6-INCH BREECH-LOADING RIFLE.—END VIEW.

1, Breech-plug; 5, carrier arm which supports the breech-plug; 9, long arm of toggle-joint lever for rotating the plug; 10, pin connecting toggle-joint lever to breech-plug; 11, pivot of toggle-joint; 12, short arm of toggle-joint lever; 13, pivot of short arm; 14, intermediate pulion with circumferential teeth set at angle of 45 and which gear into similar teeth on round end of short arm; 15, verticle pivot of 5, 12, and 14; 16, operating lever; 17, stop on intermediate pulion which prevents its turning independent of the carrier arm after the breech-plug is adequately rotated; 18, projection on carrier arm which presses against 19 and forces the loading tray into position; 19, stop on loading tray which takes against 18 and causes tray to rise; 20, firing mechanism; 21, loading tray.

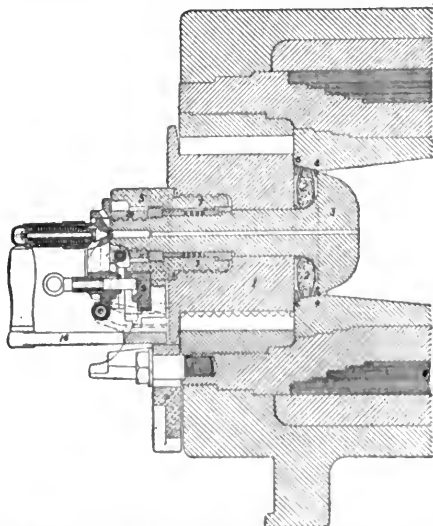

VICKERS-MAXIM BREECH MECHANISM FOR 6-INCH BREECH-LOADING RIFLE.—VERTICAL SECTION.

is used. The breech mechanism is of the rapid-working type and the obturation (i.e. the prevention of escape gas to the rear) is effected by means of a modified form of the De Bange gas check. (See GUNS, NAVAL). The primer is ejected automatically when the breech is opened and a loading tray is automatically drawn up in posi-

tion. Krupp's nomenclature was so obviously misleading that many officers are now avoiding the use of the expression *rapid-fire*.

In the United States Navy the terms *rapid-fire gun* and *quick-fire gun* are now officially defined as follows: (a) "A *rapid-fire gun* is one that has a quick-working system of breech closure

operated by a single throw of a lever or crank; uses either fixed or separate ammunition, but, when using the latter, requires the powder charge to be put up in a metallic cartridge case." (b) "A quick-fire gun is one that has a quick-working system of breech closure, operated by a single throw of a lever or crank, is fitted with an automatic lock, and uses separate ammunition with

mechanisms; Austria uses Skoda and Krupp mechanisms; the Nordenfeldt (except the Maxim-Nordenfeldt) is not much used in any naval service, and the Bofors is found chiefly in the

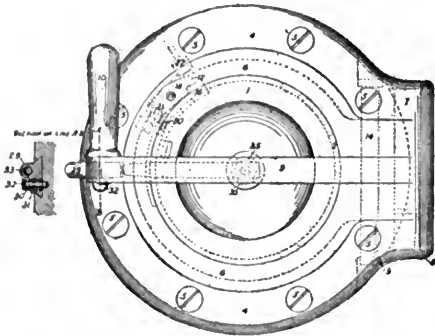

FLETCHER RAPID-FIRE BREECH MECHANISM.—END VIEW.

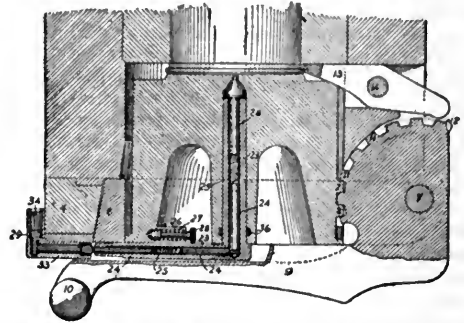

FLETCHER RAPID-FIRE BREECH MECHANISM.—HORIZONTAL SECTION.

1, Breech plug; 2, rotating rack to revolve plug; 4, hinge plate; 6, carrier ring supporting plug; 7, hinge bolt; 9, operating lever; 10, operating lever handle; 11, operating lever worm to revolve plug; 12, operating lever teeth to retract plug; 13, extractor; 14, extractor pivot; 15 and 8, spring locks to hold pins in place; 16, automatic locking bolt to hold plug in place; 17, pivot of locking bolt; 18, locking lever operating locking bolt; 19, pivot of locking lever; 20, locking lever spring; 22, locking bolt recess; 23, steel case inclosing firing-pin; 24, electric firing-pin (insulated—note heavy black lines); 25, electric firing-pin springs for insuring contact; 29 to 34, electric attachment lug for attaching wire from battery or dynamo.

the powder charge put up in a cartridge bag." These definitions are purely arbitrary, are used only in the United States Navy, and were decided upon solely as a matter of convenience. There was no hesitation in adopting the terms, as the nomenclature of rapid-firing weapons was in so chaotic a state that any authoritative change was an improvement. The terms rapid-fire in the United States and quick-fire in England had hitherto been synonymous.

The best-known and most widely used systems of rapid-firing breech mechanism are the Fletcher,

navies of Norway, Sweden, and Denmark. The best speed of firing of guns of different calibres is about as follows: 13.5-inch, 2 minutes; 13-inch, 2 minutes; 12-inch, 1 minute and 30 seconds; 11-inch, 1 minute; 10-inch, 1 minute; 9.2-inch, 25 seconds; 8.3-inch, 20 seconds; 8-inch, 10 sec-

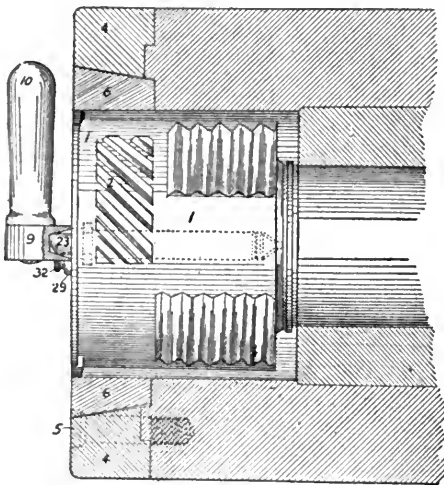

FLETCHER RAPID-FIRE BREECH MECHANISM.—VERTICAL SECTION.

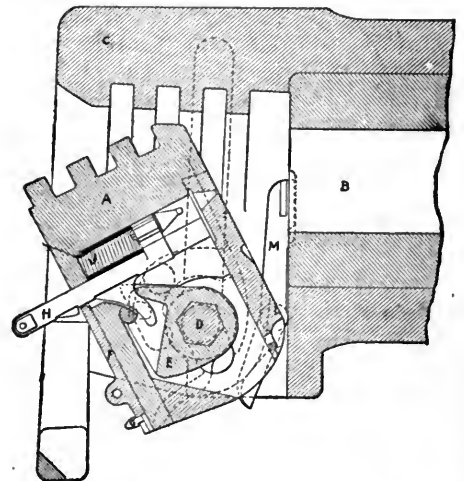

DRIGGS-SCHROEDER RAPID-FIRE GUN, LATEST MODEL, AMERICAN ORDNANCE COMPANY TYPE.

A, breech block; B, bore of gun; C, housing of breech; D, main shaft; E, operating cam; F, sear; G, sear spring; H, firing-pin; J, mainspring.

Dashiell, Hotchkiss, Driggs-Schroeder, Vickers-Maxim, Canet, Armstrong, Krupp, Skoda, Nordenfeldt, and Bofors. The first five kinds are used in the United States Navy; in England the Vickers-Maxim and Armstrong are chiefly used; in France the Canet and modifications of it and of other types are used; in Germany the guns are of Krupp model; in Russia various types have been used, but nearly all new guns have Canet

onds; 6-inch, 7 seconds; 5.5-inch, 7 seconds; 5-inch, 5 seconds; 4-inch, 4 seconds; 3-inch, 3.5 seconds; 2.24-inch (6-pounder), 3 seconds; 1.8-inch (3-pounder), in automatic 3-pounder, 1 second; 1.4-inch (1-pounder), in Maxim 1-pounder automatic gun, about 200 rounds per

minute. In the larger calibres the speed depends chiefly upon the mechanism of the mount and drill of the crew; in the smaller pieces, the speed depends chiefly upon the drill alone.

The rapid firing of modern guns has had a most marked effect upon battle tactics (see TACTICS, NAVAL) and design of ships. So far as the effect upon the former is concerned, naval critics are not fully in agreement, but in regard to the latter there is more unanimity of opinion. Battleships and armored cruisers are now thinly armor-plated over a very large portion of their sides, the plating being of sufficient thickness to keep out all shells from very rapid-working guns except those of the larger sizes at close range. Were it not for this armor the sides of battleships and the interior arrangements above water would soon be wrecked by the vast number of small projectiles which the numerous guns of a modern ship can deliver in a short space of time. The effect of this armor is to separate more widely the armored from the unarmored vessels and to render many old battleships unfit for modern fighting; but it likewise tends to decrease the differences between battleships and armored cruisers.

Notwithstanding the destruction effected by the rapid-firing guns of small calibre, the damage they inflict is rarely vital and decisive blows can only be delivered by large shells. In the naval battle of Santiago the smaller guns caused much destruction of life, but the damage to the Spanish ships, which caused three of them to surrender in about an hour after the first one was sighted coming out of the harbor, was caused by 8-inch and 12-inch guns. These wrecked the interior in a manner which was beyond the power of small pieces; two 12-inch shells destroyed the interior arrangements in the after end of the *Infanta Maria Teresa*, cut the fire-mains, and set the ship on fire so that access to the after magazines and shell-rooms was cut off; 8-inch shell cut the fire-mains and set fire to the *Oquendo* and *Viscaya*, and one exploded in the forward turret of the former, killing or wounding every soul in it and destroying the machinery for operating the forward 11-inch gun. A heavy shell (12-inch or 13-inch shell) burst in the after part of the *Oquendo*, causing enormous damage, and another struck the armor of the *Viscaya* at the waterline and, while it did not penetrate, the blow upon the plate crushed the frames and caused a leak which drove the people from the port engine-room and rapidly reduced the ship's speed. The destruction of life was greatest on the *Oquendo* and was chiefly due to the rapid-firing guns, which pierced the unarmored parts of her side as if they were of paper. On the *Cristobal Colon*, though she was struck by many small projectiles, the damage was trifling because her side was almost completely armored. She was brought to surrender by the heavy guns of the *Oregon*, which had just got her range and was rapidly overhauling her when she gave up and ran ashore.

The accuracy of rapid-firing guns as compared with larger pieces has been over-estimated. At long ranges they are less accurate, as the path of a small projectile is more curved than that of a large one having the same muzzle velocity; at short ranges small guns should be more accurate than large ones, as they are more readily handled.

BIBLIOGRAPHY. *Annual Reports of the Office*
VOL. XIV.—53.

of *Naval Intelligence*, Navy Department, Washington; *Proceedings of the U. S. Naval Institute*, Annapolis, Md.; Ingersoll, *Text Book of Ordnance and Gunnery* (Annapolis, 1899); Brassey, *Naval Annual*, London; the *Sailor's Pocket Book* (annual), London; *Annual Report of the Chief of Bureau of Ordnance*, U. S. Navy; *Annual Report of the Chief of Ordnance* U. S. Army. For information concerning rapid-firing and other guns in the United States and abroad, including tables and full details, see GUNS, NAVAL; ARTILLERY; MACHINE GUNS; ORDNANCE; etc.

RAPIN DE THOYRAS, rá'pán' de twá'rá', PAUL DE (1661-1750). A French historian, born at Castres, Languedoc. He was educated at the Protestant College of Saumur, and became an advocate in 1679, but the revocation of the Edict of Nantes (1685) forced him to leave France and he sought employment in England and afterwards in Holland. In 1693 he was appointed tutor to the Earl of Portland's son, with whom he traveled in Holland, Germany, and Italy, after which he took up his residence at The Hague, but in 1707 withdrew to Wesel, in the Duchy of Cleves, where he devoted the remaining years of his life to the composition of his History of England. This *Histoire d'Angleterre* was published at The Hague in eight volumes, the year before the author's death. It was translated into English by Nicholas Tindal (15 vols., London, 1725-31), and later translations and editions have also appeared.

RAPP, GEORGE (1770-1847). The founder of the religious society of Harmonists (q.v.). He was born at Iptingen, in Württemberg, Germany, and when he grew to manhood developed certain peculiar religious ideas. Having become desirous of organizing a religious community in accordance with these ideas, he gathered a number of followers; and, being persecuted in Germany, he in 1803 emigrated to the United States. In the following year he founded in Butler County, Pa., a community in which all things were held in common and where both sexes practiced celibacy. In 1815 the society removed to the banks of the Wabash in Posey County, Ind., and there founded a new settlement which they called New Harmony (q.v.). Nine years later, however, they sold out their rights to the reformer Robert Owen (q.v.), and returned to Pennsylvania, where they built the village of Economy. Of these communities Rapp was both spiritual and temporal head.

RAPP, ráp, JEAN, Count (1772-1821). A French general, born at Kolmar, Alsace. He entered the army in 1788. In 1795 he was only a lieutenant, but having become aide-de-camp to Desaix, he distinguished himself by his gallantry in Egypt, and on the death of his chief at Marengo he became aide-de-camp to Napoleon, and soon rose to be brigadier-general. His brilliant charge at Austerlitz, which put to rout the Russian Imperial Guard, was rewarded with the grade of general of division. For his services in the battle of Aspern (q.v.) he was named a count of the Empire (Aug. 1, 1809). Though opposed to the Russian expedition of 1812, he accompanied the Emperor throughout the whole of it, adding, on many occasions, to his military reputation. His defense of Danzig for nearly a year against a powerful Russian army added to his fame. The Russians, contrary to the articles of

capitulation, sent Rapp and his garrison prisoners to Russia, and he was not able to return to France till July, 1814. On reaching Paris he was well received by Louis XVIII., and in March, 1815, was one of those sent to oppose the return of Napoleon, but deserted with his troops and was appointed by Napoleon commander-in-chief of the Army of the Rhine and peer of France. In 1818 Rapp was reinstated by Louis XVIII. in the army. He left *Mémoires* (Paris, 1823). Consult Spaeh, *Le général Rapp* (Colmar, 1856).

RAP PAHAN'NOCK. A river of Virginia. It is formed by several headstreams in the Blue Ridge, flows southeastward, and enters Chesapeake Bay by a broad and long estuary running parallel with that of the Potomac and about 20 miles south of it (Map: Virginia, II 4). Its length is 250 miles. At Fredericksburg there is a fall supplying good water-power, and below that point the river is a fine, navigable tidal stream for nearly 100 miles. Its chief tributary is the Rapidan.

RAPPERSWYL, räp'ärs-vël. A town in the Canton of St. Gall, Switzerland, 22 miles southeast of Zurich, on Lake Zurich (Map: Switzerland, C 1). In the old Hapsburg Castle is the Polish National Museum containing a collection of antiquities, sculptures, and paintings. The Parish Church, the town hall, and the viaduct connecting Rapperswyl with Hurden and Pfäffikon are also of interest. Rapperswyl dates from the twelfth century. Population, 1900, 3412.

RAPPOLDI, räp-pöl'dë, EDUARD (1839—). A German violinist, born in Vienna. He studied under Jansa and Böhm, played in the Court Opera of Vienna (1854-61), then was conductor for five years of German opera at Rotterdam, and, after several years in Lubeck, Stettin, and Prague, and six years at the Berlin Royal School of Music as an instructor and a member of Joachim's quartet, in 1877 went to Dresden, where he became professor in the Conservatory and concert master at the Opera. Rappoldi wrote two sonatas for the violin and one for the piano as well as some song music. His wife, LAURA KAHRER (1853—), a teacher of piano in the Dresden Conservatory, studied in Vienna and subsequently with Liszt and Bülow.

RARITAN. A river of New Jersey. It is formed by two branches in the highlands in the northern part of the State, and flows eastward into Raritan Bay, an inlet of Lower New York Bay (Map: New Jersey, D 2). It is 75 miles long and navigable to the 'fall line' near New Brunswick.

RAROTONGA, rä'rô-tông'ä. The largest of the Cook Islands (q.v.), in the Pacific Ocean.

RASCAL LEAF-CRUMPLER. The larva of a phycitid moth (*Mincola indiginella*), which makes irregular crumpled cases on the apple leaves upon which it feeds. It works most extensively during May and June, when it is hidden by the foliage of the tree, which it helps eventually to denude. The larval cases are plainly seen in the winter time attached in clusters to the twigs by means of strong silken threads, and in these cases the larvæ pass the winter about one-third grown. In the spring, when the leaves first begin to bud out, the larvæ begin to feed, and reach full growth in June. The pupa is formed within the larval cases, and the moth

emerges in July, laying its eggs a little later. It feeds upon the apple and cherry, both wild and cultivated; upon the plum, quince, and crab-apple, and to a lesser extent upon the peach. The best remedy consists in collecting and destroying in winter the plainly visible larval cases.

RASCHDORFF, räsh'dörf, JULIUS (1823—). A German architect, born at Pless, Silesia, and educated at the Academy of Architecture in Berlin. In 1853 he became city architect at Cologne, where, besides restoring the Rathaus and several churches, he reconstructed the Gürzenich (1855-57), built the Stadt-Theater (1872), and with Felten the Municipal (Wallraf-Richartz) Museum (1855-61). Of several public structures in various other cities the House of the Rhenish Estates (1879) at Düsseldorf, in the style of the Italian Renaissance, is the most noteworthy. Appointed professor at the Academy in Berlin in 1878, he built the Technical Academy at Charlottenburg (with Hitzig, completed 1884), the English Church in Monbijou Park (1885), the Mausoleum of Frederick III. (1894), at Potsdam, and was associated with his son, Otto, in the erection, from his designs, of the new cathedral (1894-1902). Of his publications the following are the most important: *Entwürfe und Bauausführungen im Stile deutscher Renaissance* (1879); *Baukunst der Renaissance* (1880-90); *Palastarchitektur von Oberitalien und Toscana* (1883-96); and *Rheinische Holz- und Fachwerkbauten des 16. und 17. Jahrhunderts* (1895). His son, OTTO (1854—), born at Rheine, Westphalia, pupil of the Bauakademie in Berlin (1872-75), was appointed Government architect in 1882, professor at the Technical Academy in 1891, and collaborated mostly with his father, especially in the new Berlin cathedral.

RASH (OF. *rasche, rasque*, Fr. *rache*, Prov. *rasca*, rash, seurf, itch, from Prov., Sp., Port. *rasear*, to scrape, from Lat. *radere*, to scrape, shave). The common name of the exanthem of an affection of the skin, such as the eruption in nettlerash or urticaria, measles, scarlatina, erysipelas, and erythema (q.v.).

RASH'DALL, HASTINGS (1858—). An English historian and divine. He was educated at Harrow and at New College, Oxford, was ordained in 1884, was tutor at the University of Durham until 1888, when he was appointed fellow and lecturer of Hertford College, Oxford, and in 1895 received a like post at New College. He was select preacher at Oxford (1895-97), and preacher at Lincoln's Inn (1898 sqq.). His reputation as an historian is largely due to his *Life of Wielclif* in the *Dictionary of National Biography* (1900), and to his *Universities of Europe in the Middle Ages* (1895). He published, besides, *Doctrine and Development* (1889, a volume of sermons) and, with Rait, *New College*, a history (1901).

RASHER, or **RASCIERA** (perhaps from Sp. *rascaico*, sort of fish). One of the Californian rockfish (*Sebastes miniatus*) peculiar in its deep vermilion color, mottled with yellowish pink and speckled on the back and sides with clusters of black dots, so that the whole body has a dusky shade. It comes about two feet in length, and is a common market fish. See ROCKFISH.

RASHI, rä'shé (Rabbi *Shelômôh Yishâkî*, or Solomon ben Isaac, often erroneously called

Yarchi (1040-1105). A great Jewish commentator and exegete. He was born in Troyes, France, July 13, 1040. He began his studies under his father and continued them at Worms, at Mainz, and at Speyer under distinguished Jewish scholars. Returning to Troyes, he established a school for the study of the Bible and Rabbinic literature, and his fame drew scholars from far and wide, while many who could not consult him personally sought his opinion by letter. Rashi's reputation is greatest as a commentator. His Bible commentary is complete except from Job xl. 21 to the end of Chronicles. It was the first Hebrew book printed (1474), and is still generally included in good editions of the Bible for Jews. It has been translated into Latin by Breithaupt (Gotha, 1710-14). The renderings are generally the traditional ones and Midrashic authorities are followed, but simple literal explanations are also given, and the style is concise and full of meaning. Rashi also wrote a few liturgical poems of little value, and a famous commentary to 23 treatises of the Talmud, which was supplemented by his grandson, Rabbi Samuel ben Meir (Rashbam). This always accompanies editions of the Talmud. Consult: Zunz, in *Zeitschrift für die Wissenschaft des Judenthums* (Berlin, 1822); Graetz, *History of the Jews* (Eng. trans., Philadelphia, 1873).

RASK, räsk, RASMUS KRISTIAN (1787-1832). A Danish philologist. He was born at Brendekilde, near Odense, in the island of Fünen; studied at Copenhagen, and in 1808 published his first work, an introduction to the Icelandic language. In 1813 he went to Iceland, where he lived for two or three years, perfecting his knowledge of the language and history of the inhabitants. On his return to Copenhagen he was appointed sub-librarian to the university, and in 1818 published his researches on Iceland, which led Grimm to his discovery of the sound-shifting in the Germanic languages. (See GRIMM'S LAW.) After spending a year in Stockholm, where he published his Anglo-Saxon Grammar and the first critical and complete edition of the *Snorra Edda* and the *Edda Sæmundar*, he went to Saint Petersburg, where for two years he studied Sanskrit, Persian, Arabic, Russian, and Finnish. He then went to Astrakhan, where he studied the languages of the Tatars, and then began a journey through the country of the Turkomans, the Caucasus, Persia, Hindustan, and finally Ceylon, where he wrote his *Singalesisk Skrifflære* (1822). In 1823 Rask returned to Copenhagen; in 1825 he was appointed professor of literary history, and in 1828 of Oriental languages. In the following year he was made chief custodian of the university library; and in 1831, professor of Icelandic. But his immense labors had exhausted his energies, and he died at the early age of 45. Besides the productions already mentioned, Rask wrote *Frisisk Sproglaere* (1825); *Den gamle Aegyptiske Tidsregning* (1827); *Den ældste Hebraiske Tidsregning* (1828); besides grammars of several languages, and a great number of miscellaneous articles which were collected after his death, and published (1834-38), together with a *Life* by Peterson.

RASKOLNIKI, räs-kól'nä-kä, or **RASKOLNIKS** (Russ., schismatics). The generic name applied to all those of the Greek faith who dissent from the established Church in Russia. The

name used by the Raskolniki themselves is *Starobryadtsy* (old ritualists) or *Starovercysy* (old believers). The immediate occasion of schism was the correction of the old ecclesiastical books. In the first quarter of the sixteenth century Maksim, the Greek, began to revise them, but made some errors and was accused of heresy and imprisoned. The 'Hundred Chaptered Council' of 1550 undertook a correction by collating current translations, and not by comparing them with the Greek originals, and still more errors crept in and more dissatisfaction was occasioned. In the middle of the seventeenth century the Patriarch Nikon (q.v.) undertook a new revision. His predecessor, Joseph, had also corrected ecclesiastical books, and issued over 6000 copies, all containing the grossest mistakes. Nikon's opponents—and he had many, owing to his domineering spirit—now made the old revision a point of issue in their controversy with the patriarch. Prominent among them were the popes (priests) Lazar and Nikita, the deacon Fyodor, and especially the protopope Avvakum, a man uncommonly well-read, and a forceful speaker. The ecclesiastical council convened on December 11-22, 1667, approved the decisions of the previous councils with regard to religious matters and books, and anathematized those disagreeing with the council. The latter were now officially called Raskolniki, and from this time dates the rise of the *raskol*. Most of the dissenters were banished to remote monasteries, like that at Solofki on the White Sea. The Raskolniki kept up their objectionable propaganda from their places of confinement, and after a seven years' siege the monastery at Solofki was taken in 1676, the rebellious monastics were punished without quarter, and in 1681 Avvakum was executed. The anti-governmental spirit moved the Raskolniki to take a prominent part in the insurrections of the Streltsy (q.v.), and the Regent, Sofia, executed many of them in 1684.

About 1685 there came a split in the ranks of the Raskolniki. One faction considered priests a useless institution; these were called *bezpoportsy* (priestless). The other half argued that they were the champions of the old faith against the encroachments of Antichrist, and therefore priests were necessary for the struggle; these were the *poportsy* (priest party). Nikon had been declared the Antichrist, as the correction of books in 1666 (= 1000 + 666), according to apocalyptic calculations, coincided with the expected appearance of the Antichrist and the end of the world was due three years later, a date afterwards changed to 1702. After 1702, the Raskolniki turned to the internal arrangement of their Church, and then the division into the two factions mentioned above was consummated. Looking upon the Czar as Antichrist, they considered it a crime to pray for him, and everything anti-Czarist enlisted their sympathy. They were very active in the Pugatcheff rebellion in the latter half of the eighteenth century. A curious feature of the movement is the frequent occurrence of suicide among the Raskolniki. The doctrine took its rise in Avvakum's preaching of scorn for death and laudations of martyrdom. In the District of Poshekhone (Government of Yaroslav) as many as 1920 persons burned themselves during 1676-93, and in all about 20,000 people destroyed themselves up to 1690. As late as 1860 fifteen persons burned themselves in

the Olonets Government, and in 1897 a number died immured in a cellar.

The Government dealt severely with the Raskolniki from the outset, the law of April 17, 1685, prescribing death, almost without exception, to those persevering in the schism or assisting its adherents. In 1716 they were permitted to settle in cities on the payment of a double tax, but were not permitted to appear as witnesses against orthodox persons. The successors of Peter I. increased the severity of the enactments against them. In 1752 labels were required on their dress as a distinguishing mark. In 1768 and 1778 ukases forbade the building of churches and chapels and the use of bells. From 1769 on they could again appear as witnesses in court, the double tax was removed in 1782, and the following year the name Raskolniki was discontinued in official documents. Under Paul I. (1796-1801) their lot grew worse, and under Alexander I., in 1803, the word Raskolniki reappears in State papers. They are officially subdivided into three classes: I. Most obnoxious: (1) the Judaizers; (2) the Molokani (q.v.), who recognize no authority and object to taking oaths; (3) Dukhobortsy (q.v.), a variety of the preceding; (4) the Khlystovtsy, who introduce anthropolatry; (5) the Skoptsy (q.v.), enemies of society, and blasphemous as deriving their sect from Christ; (6) those Bezpopovtsy who oppose marriage and praying for the Czar. II. Obnoxious: the Bezpopovtsy who recognize marriage and pray for the Czar; these are harmful as being against priests and the Eucharist, and also on account of their democratic teachings. III. Least obnoxious: the Popovtsy, rather schismatics than heretics, as they keep most of the Church requirements and give most promise of reforming. Of the nineteen episcopal chairs among the 'old believers' thirteen are held by the Popovtsy, and only three by the Bezpopovtsy. In 1874, on account of the introduction of the universal military service, a new marriage law was proclaimed for the Raskolniki: the marriages were henceforth to be recorded by police officials, and the issue were considered legitimate. After numerous petitions presented in 1880-81, came the law of May 3, 1883, which brought considerable relief to the schismatics. Passports were now given to all Raskolniki, with the exception of the Skoptsy; they were free to engage in trade and occupy official posts, to perform divine service publicly, in private or special buildings, and to rebuild old churches, provided they are of an appearance distinct from the orthodox places of worship. Some other minor liberties were also granted, and lawful prosecution could be instituted against them for active propaganda only.

Among the distinguishing features common to all sects of the Raskolniki may be mentioned; the manner of crossing themselves with the first and middle finger; use of unrevised service-books; two-fold repetition of hallelujah; turning in church ceremonies "in the direction of the sun's movement," i.e. from left to right and not from right to left; use of seven instead of five altar-breads in the eucharistic offering; use of ancient icons and eight-pointed cross. Their predilection for everything antique appears in their use of the old Russian costume, and scrupulous objection to cutting their hair or shaving their beards. In general the Raskolniki are counted among the most industrious, sober, and intelligent elements

of the Russian population. As to their numbers a serious divergence of statistical data seems to be the rule; many Raskolniki conceal their faith before the magistrates, and even of those registered the governmental reports give only a small fraction, for fear of increasing their popularity with the masses. Thus, e.g. when the official returns in 1870 gave their number as 1,171,000, the foreign newspapers, on the basis of the secret governmental documents, gave a figure almost ten times as high. On this basis, says the Russian Encyclopædia, one can approximately guess their total number, when the report of the Holy Synod for 1893 places them a little below 2,000,000. Consult Strahl, *Beiträge zur russischen Kirchengeschichte*, vol. i. (Halle, 1827); Gerbel-Embach, *Russische Sektierer* (Heilbronn, 1883); Heard, *The Russian Church and Russian Dissent* (New York, 1887).

RASP. See FILE.

RASPAIL, rās'pä'y', FRANÇOIS VINCENT (1794-1878). A French naturalist and revolutionary. He was born at Carpentras, in the Department of Vaucluse, and went to Paris in 1815. There he became the editor of radical papers and fought at the barricades in the revolution of 1830. He opposed the Government of Louis Phillipe, and was prosecuted for his newspaper articles and for his membership of illegal societies. As leader of a mob (February 24, 1848) he forced the Provisional Government to proclaim the Republic, and with Barbés and Blanqui headed the insurrectionists who invaded the Hall of the National Assembly on May 15th, and sought to disperse the body. He was sentenced to five years' imprisonment. He was a member of the Corps Législatif in 1869 and of the Chamber of Deputies in 1876-77. As a naturalist he became known through the enthusiastic advocacy of camphor as an antiseptic. His works include: *Essai de chimie microscopique* (1831); *Nouveau système de chimie organique* (1833); *Nouveau système de physiologie végétale et botanique* (1837); *Nouvelles études scientifiques* (1861-64).

RASPBERRY (from *rasp*, OF. *rasper*, Fr. *râper*, from ML. *raspare*, to scrape, from OHG. *raspôn*, to scrape together (connected with Ger. *rappcn*, to seize, Eng. *rap*) + *berry*; so called from the rough surface). Several species of the genus *Rubus*, of the natural order Rosaceæ. The black-cap or black raspberry (*Rubus occidentalis*) is an American species with white flowers, and purplish-black fruits consisting of numerous drupes joined together. Since its introduction in 1832 it has become one of the most important of bush fruits and is extensively raised for dessert, canning, and evaporating. In nature the tips of recurved stems of the present season's growth take root during midsummer and late autumn, and give rise to a new plant—a habit utilized in cultivation. In commercial plantations the plants are set in rows 3 by 8 feet apart, given clean culture until time to put down the stem tips, when cultivation ceases. The first return, then, from a new raspberry patch is a crop of plants. The new shoots which spring up from the roots are cut back to 18 or 20 inches, when about that height, to induce the formation of fruit-bearing wood. As soon as the crop is gathered, the canes which have borne are cut away to increase the strength of the new wood which is to bear the

following season's crop. The crop is usually picked by hand; many growers, however, use a simple device consisting of an apron with a shallow box attached, into which the ripe fruit is jarred. After the fruit is dried it is run through a fanning mill to separate any leaves or twigs which fell with the fruits into the picking box.

Two species of red raspberries are cultivated, the native American red raspberry (*Rubus strigosus*) and the European (*Rubus Idoxus*.) These two plants are closely related botanically, but differ under cultivation, a marked distinction being the habit of the European species to continue fruiting throughout the season after ripening begins. This is a disadvantage to the commercial grower, but an advantage to the amateur. The European sorts are less hardy than the natives, and cannot be relied upon in the Northern States except in sheltered positions. The number of foreign varieties cultivated in the United States is comparatively small. Out of a total of 100 or more introductions not more than 6 or 8 have stood the test. Both forms of red raspberry propagate readily from sprouts and root cuttings. As a result of the habit of sprouting, the patches soon present the character of a matted row, although they are usually planted 3 by 6 feet apart in original plantations. Thorough cultivation is necessary, not only for the purpose of stimulating growth, but in order to hold the plants within bounds. The fruit of these species cannot be successfully gathered by machinery and is never evaporated. Its chief use is for dessert purposes, although the fruit is also prized in wine-making, for jam, and for canning.

Another important group of raspberries seems to have resulted from the crossing of *Rubus occidentalis* and *Rubus strigosus*. In habit of growth the plant resembles the black raspberry more closely than the red, since it propagates by 'tips,' has a firmer fruit than the red, with greater size and much better flavor than the black. For shipping it is much better than the red, and for dessert purposes superior to the black. Flowering raspberry (*Rubus oederatus*) is often planted for ornament. See Plate of RUBUS.

RASPBERRY DISEASES. The fungous diseases of the raspberry, blackberry, and dewberry are the same, and at times work serious injury. Among the most important are anthracnose and orange rust. The anthracnose (*Glaosporium necator*) is first indicated by the appearance of small rapidly growing purple spots upon the young shoots near the ground. As these spots enlarge and extend around the stems the centres become dirty white, the spots coalesce and rupture the epidermis, and the canes die as though girdled by a knife. The fruit may shrivel and remain upon the stems. Rust (*Croonia nitens*) attacks and dwarfs the young growth. Soon the leaves turn yellow and both they and the young stems become distorted and covered with masses of orange-colored spores, which rapidly spread the disease. The remedy recommended for the former is spraying with a fungicide (q.v.), for the latter digging and burning.

RASPBERRY INSECTS. The canes of raspberry bushes are attacked injuriously in the United States by two species of beetles. The raspberry cane-borer (*Oberca bimaculata*) lives

in the larval state in the centre of the cane, where it burrows downward, often causing the death of the cane. It is a native insect, feeding in the wild raspberries, but has transferred its attention to the cultivated varieties. The perfect insect is a cerambycid or long-horned beetle, with a long and narrow black body, the top of the thorax being pale yellowish. It appears in June, and the female lays her eggs toward the end of that month, girdling the young growing cane near the tip in two places and inserting the egg between the girdles. This insect feeds in blackberry as well as in raspberry stems. The remedy consists in pruning the girdled tips as soon as observed, and they are very evident from the withering of the terminal leaves. The other cane-borer is the red-necked Agrilus (*Agrilus ruficollis*). This is a buprestid beetle which lays its eggs in the stems of raspberry and blackberry, and the resultant larva makes a swelling in the cane. Several larvae will be found under the bark of one of these swellings, and when full-grown they penetrate to the pith and transform to pupæ from which the perfect beetles escape early in the summer.

Raspberry canes are sometimes damaged to some extent by the snowy tree-cricket (*Ecanthus niveus*), which perforates the stems to a distance of an inch or more, inserting its eggs in the perforations. This is the only damage done by this insect, which, after it issues, feeds upon plant-lice. The raspberry sawfly (*Selandria rubi*) in the larval condition feeds upon the leaves, and transforms to pupa at the surface of the ground or a little below the surface. This insect is destroyed, when abundant, by sprinkling with kellebore and water. Several species of Lepidoptera in the larval state feed upon the leaves of raspberry, and there is a little measuring worm which feeds upon the fruit. This species (*Synchlora arata*) reaches full growth about the time of the ripening of the raspberry, when it is about three-fourths of an inch long, of a yellowish gray color, each segment being furnished with several sharp thorns. It has the habit of disguising itself by attaching to these thorns small bits of vegetable matter, such as the anthers of flowers and bits of leaf. The adult moth is of a delicate pale-green color, and has a wing-expanse of about half an inch. The flea-like negro-bug (q.v.) is often found upon raspberries, and its presence may be discovered by the disagreeable odor of the fruit. The insect is so small that it is often taken into the mouth unnoticed until the disgusting flavor reveals its presence. Consult Saunders, *Insects Injurious to Fruits* (Philadelphia, 1889).

RASPE, räs'pé' RUDOLPH ERICH (1737-94). A German-English writer and mineralogist, born in Hanover. He studied in 1756-60 at Göttingen and Leipzig. In 1767 he became a professor in the Collegium Carolinum at Cassell, and curator of the Landgrave's cabinet of antiquities and coins. During this time he translated (1765) Leibnitz's philosophical works, wrote the poem *Hermis und Gunilde* (1766), published a critical treatise on Percy's *Reliques*, and papers on geology and mineralogy. In 1775 he was charged with purloining coins and other articles of value, and fled to England, where he published *Some German Volcanoes and Their Productions* (1776), a translation of Lessing's *Nathan der*

Weise (1781), and, with the assistance of Horace Walpole, a treatise on the origin of painting in oil (1781). Later he became assay-master at mines in Dolcoath, Cornwall (1782-85), and compiler of the excellent *Descriptive Catalogue* of more than 15,000 casts of gems, forming the collection of James Tassie of Edinburgh. In 1791 he was in the north of Scotland, where he obtained from Sir John Sinclair of Ulster funds for metallurgical experiments. He then decamped with the money to Muckross, County Donegal, Ireland. This incident was introduced by Scott in *The Antiquary*. Raspe published in 1785, in chap-book form, *Baron Münchhausen's Narrative of His Marvellous Travels and Campaigns in Russia*, based partly on his recollections of Hieronimus Karl Friedrich, Baron von Münchhausen (1729-97), who had much local renown in Hanover for his exaggerated tales of putative hunting adventures, and partly on similar material preserved in his commonplace-book. His work constitutes chapters 2-6 of the latter-day Münchhausen. See MÜNCHHAUSEN.

RÄSS, räs, ANDREAS (1794-1887). A German theologian, born at Sigolsheim, Alsace, and educated in Mainz. He was ordained priest in 1816. In 1842 he was nominated Bishop of Strassburg. At the Vatican Council he was a staunch supporter of the dogma of infallibility. Räss founded the periodical *Der Katholik*, and wrote many theological treatises. His printed works include: *Konvertiten seit der Reformation* (1866-80), and together with Weiss, Bishop of Speyer, he published *Leben der Väter und Märtyrer* (23 vols., 1821-27), a translation of Butler's *Lives of the Saints*.

RASSAM, räs-säm', HORMUZD (1826—). A celebrated Assyriologist, born of native Christian parents at Mosul. He acted as agent and overseer for Layard (q.v.) during his two expeditions in 1845-47 and 1849-51. In 1852-54 he conducted excavations at Kalat Shirgat, Nimrud, and Koyunjik under the direction of Sir Henry Rawlinson and the British Museum, and discovered the palace of Assurbanipal and the second half of the library at Koyunjik. (See NINEVEH.) In 1864 he was sent by the British authorities to Abyssinia, where the King had imprisoned certain Europeans. Rassam was himself held captive from 1866 until Sir Robert Napier's victory over the Abyssinians in 1868. After the sudden death of George Smith in 1876 the officials of the British Museum again asked Rassam to take charge of excavations in Assyria. In 1878 he began operations in Nineveh, and from January of that year till July, 1882, he was continuously in the field in both Assyria and Babylonia, with the exception of three visits to England to report and receive funds to continue the work. He strove to excavate a great number of sites and to make striking discoveries rather than to do the best kind of work, and his lack of proper training also proved a disqualification for his task. Nevertheless he made important discoveries, such as the bronze gates of Balawat (q.v.), obtained a large number of exceedingly valuable inscriptions, and identified and partially excavated the ancient Sippara (Abu Habba). He published *The British Mission to Theodora, King of Abyssinia* (1869) and *Asshur and the Land of Nimrod* (1897), an account of his excavations.

RASSE (from Javanese *rasa*, from Skt. *rasa*, flavor, taste). A Malacca weasel. A small civet (*Viverricula malaccensis*) which inhabits the Malay Peninsula, eastward to Formosa, and also the island of Madagascar, where it was probably introduced long ago. It differs from the ordinary civets, being of slighter build, enabling it to climb trees, and in lacking a mane. It has along its back and sides seven blackish stripes, more or less broken into spots, some curving bars on the throat, and a long, tapering dark-ringed tail. This animal is made to yield the scent called 'civet,' which accumulates in its prescrotal glands, and which is removed from them at intervals, by means of a little spoon-shaped instrument.

RAS'SELAS. A prose romance by Dr. Samuel Johnson (1759), written during the evenings of one week to defray the expenses of his mother's funeral. Most popular of all Johnson's works, it has been translated into most modern languages. The story of the Prince of Abyssinia, who left the Happy Valley, where he had been brought up, to explore the world, shows the vanity of human happiness, the author's protest against the easy optimism of his day.

RASTATT, or **RASTADT**, rä'stät. A town in the Grand Duchy of Baden, Germany, on the Murg, three miles from its junction with the Rhine, and 15 miles by rail southwest of Karlsruhe (Map: Germany, C 4). Its strong fortifications were dismantled in 1890. The town has a large palace (now a barrack), a gymnasium, and an industrial school. It manufactures iron hearths, tobacco, and lace. Rastatt is memorable for the two congresses held here. At the first, in 1714, a treaty of peace (following that of Utrecht) was signed which brought the War of the Spanish Succession to a close. The second congress was that of 1797-99 between France and the German Empire. It effected nothing, a new coalition having been formed against France. Its dissolution was followed by the assassination of two of the French delegates, a crime which aroused great indignation throughout Europe. For about 20 years previous to 1866 the fortress of Rastatt was occupied by the troops of the German Confederation. The Baden revolution in 1849 began and ended in Rastatt, which finally surrendered to the Prussians. Population, in 1890, 11,557; in 1900, 13,940. Consult Hüffer, *Der Rastatter Gesandtenmord* (Bonn, 1896).

RASTENBURG, rä's'ten-böörk. A town in the Province of East Prussia, Prussia, on the River Guber, 64 miles southeast of Königsberg by rail (Map: Germany, J 1). It has a royal gymnasium and a sanatorium for epileptics. Among the industrial establishments are iron and brass foundries, sugar factory, flouring mills, etc. Population, in 1900, 11,144.

RAT (AS. *raeti*, OHG. *ratto*, Ger. *Ratte*, Fr., Prov. *rat*, It. *ratto*, rat; of uncertain etymology). Any of the larger rodents of the genus *Mus*. (See MORSE.) Two species are very widely distributed over the world—the black rat (*Mus rattus*) and the brown rat (*Mus decumanus*). Both appear to be natives of Central Asia. The black rat found its way to Europe about the beginning of the 16th century, but the brown rat did not reach England until about 1728. The British Jacobites were accustomed to delight themselves with the notion that it came with the House of Hanover,

and chose to call it the 'Hanoverian rat.' It also received the name of 'Norway rat,' from a belief that it was introduced from Norway. The date of introduction into America is very doubtful, but the black or Alexandrine rat seems to have come first, and has been gradually driven westward by its large and more savage cousin. The brown rat is the larger and more powerful of the two, and has waged war against the other with such success as to cause its total, or almost total, disappearance from many districts where it was once abundant, yet in some places the black rat is still the more plentiful of the two. Both infest ships, and are thus conveyed to the most distant parts of the world, and both are 'wharf rats.'

The black rat is nearly 7½ inches in length, exclusive of the long tail. The brown rat attains a length of more than 10½ inches. Besides its large size and comparative shortness of tail, it differs from the black rat in its smaller ears and less acute muzzle, as well as in its lighter color and shorter hair. Both species are extremely prolific, breeding at a very early age, several times in a year, and producing from 10 to 14 at a birth.

Rats feed indiscriminately on almost any kind of animal or vegetable food; they make depredations in fields of grain and pulse, from which they often carry off large quantities to be stored in their holes, and thus have become a serious pest in the West Indian sugar plantations. They devour eggs; they kill poultry, partridges, and the like, and become a pest of ill-kept dwellings and storehouses. Their strong rodent teeth enable them to gnaw very hard substances, such as wood and lead pipes, either for food or in order to make their way to food. They are creatures of no little intelligence, and many curious stories are told of the arts which they employ to attain desired objects, of the readiness with which they detect the approach of danger, and the skill with which they avoid it. Under certain circumstances they undertake migrations in large companies. Their sense of smell is very acute, and the professional rat-catcher is very careful that the smell of his hands shall not be perceived on the trap. They are capable of being tamed, and have in some instances proved interesting pets.

The flesh of rats is seldom eaten. The skin is used for making a fine kind of glove-leather. During the prevalence of the bubonic plague in India, Australia, and Cape Colony, in the latter part of the nineteenth century, it was ascertained that there was a direct connection between the prevalence of the disease and the abundance of rats, and it was shown that the rats were themselves liable to the plague, and myriads perished from it. Investigation showed that the fleas, with which rats are infested, are hosts for the plague germ, and that thus rats unwittingly served as an important means for spreading the disease. Measures were taken, in consequence, to kill them in the ports of India in large numbers.

RATAFIA (Fr. *ratafia*, from Malay *araq*, from Ar. *araq*, arrack, from *araqa*, to sweat + Malay *tāfia*, spirits distilled from molasses, Eng. *taffy*). A cordial flavored with fruits or the kernels of fruits. The name is used generically to include several varieties of fruit liqueurs. Procope, the ancient master distiller of Paris, includes under this term liqueurs, or syrups as we

should say, of cherries, strawberries, gooseberries, apricots, peaches, and other fruits. He it was who first proposed the pressure of the fruits without infusing them entire. Some years afterwards Breard, one of the chiefs of the fruitery of Louis XIV., gave these (white) liqueurs the name *Hypocques*, to distinguish them from other ratafias. Consult Mew and Ashton, *Drinks of the World* (New York, 1892). See LIQUEUR.

RATE (OF. *rate*, from ML. *rata*, fem. sg. of Lat. *ratus*, fixed, settled, p.p. of *rerī*, to think). In the United States Navy the titles of petty officers are termed rates or ratings, which are synonymous with rank as applied to a commissioned or warrant officer. Ships of this navy are by law divided into classes called rates. Vessels of the first rate have a displacement tonnage in excess of 8000 tons; second rate, from 4000 to 8000 tons; third rate, from 1000 to 4000 tons; and fourth rate, of less than 1000 tons. Converted merchant vessels which are armed and equipped as cruisers are of the second rate if of over 6000 tons, and of the third rate if of over 1000 and less than 6000 tons. Auxiliary vessels such as colliers, supply vessels, repair ships, etc., if of over 4000 tons, are of the third rate. Auxiliary vessels of less than 4000 tons—except tugs, sailing ships, and receiving ships which are not rated—are of the fourth rate. Torpedo-boat destroyers, torpedo boats, and similar vessels are not rated. Ships of the first rate are commanded by captains; of the second rate, by captains or commanders; of the third rate, by commanders or lieutenant-commanders; of the fourth rate, by lieutenant-commanders or lieutenants. Vessels not rated are commanded by lieutenant-commanders, lieutenants, ensigns, or warrant officers.

RATE. The term applied to the taxes assessed and collected by local authorities in England. The objects subject to taxation being assessed, a 'rate' is fixed sufficient to bring in the needed income. The taxes being imposed by various administrative bodies such as the counties, or poor law districts, we find frequent references to 'county rates,' 'poor rates,' etc. As the entire revenue of local bodies rests upon this basis, the term rate is frequently used by English writers as synonymous with direct taxation, other forms of taxation being designated customs, duties, imposts, etc. The distinctions here noted are not in use in the practice of American communities or in the writings of American authors upon taxation.

RATEL (Fr., diminutive of *rat*, rat), or HONEY BADGER. A badger-like animal of South Africa. See BADGER.

RATH, rät, GERHARD VOM (1830-88). A German mineralogist, born at Duisburg and educated in Berlin, Bonn, and Geneva. In 1863 he became professor of mineralogy at the University of Bonn, and a few years afterwards was made director of the Mineralogical Museum there. He made scientific researches in mineralogy, petrology, and especially the geology of the Rhine, Alps, and Italy. He published the results of his researches in Poggendorff's *Annalen*, in the *Zeitschrift der deutschen geologischen Gesellschaft*, and in the *Monatsberichten* of the Berlin Academy, and in such publications of his own as *Ein Ausflug nach Kalabrien* (1871), *Durch Italien und Griechenland*.

land nach dem heiligen Land, and Naturwissenschaftliche Studien (1879).

RATHBONE SISTERS, ORDER OF. See PYTHIAS, KNIGHTS OF.

RATHENOW, rä'te-nô, or **RATHENAU**. A town in the Province of Brandenburg, Prussia, on the Havel, 45 miles west-northwest of Berlin (Map: Prussia, E 2). It manufactures optical instruments, furniture, asbestos, and stoves. Population, in 1890, 16,353; in 1900, 21,043.

RATHMINES (râth-mînz') AND **RATHGAR**, -gâr'. A municipality of Leinster, Ireland, suburban to Dublin (q.v.). Population, in 1891, 27,796; in 1901, 32,602.

RATIBOR, rä'tê-bôr. A city in the Province of Silesia, Prussia, on the Oder, 44 miles south-southeast of Oppeln (Map: Prussia, H 3). It has a handsome courthouse, a theatre, and a gymnasium. It has manufactures of iron-foundry and machine-shop products, snuff, sugar, chocolate, paper, furniture, and chemicals. The town was the capital of the former Principality of Ratibor. Population, in 1900, 25,236.

RATICHIUS, râ-tik'î-ûs (Ger. RATKE, or RATICHI), WOLFGANG (1571-1635). A celebrated educational reformer, born at Wilster, in Holstein, and educated at the Hamburg Johanneum and the University of Rostock. While sojourning in Holland (1603-11) he devised a new method for teaching languages quickly. He tried to enlist the Prince of Orange in his cause, but failing, he betook himself to Germany. At Amsterdam, Basel, Strassburg, Frankfurt, Weimar, Augsburg, Köthen, and various other places he put into operation his method of instruction. His executive ability, however, was not commensurate with the scope of his ideas, and he consequently failed in all his undertakings. His personality, moreover, alienated both assistants and patrons. He advocated, above all, the use of the vernacular as the proper means for approaching all subjects, and demanded the establishment of a vernacular school on the basis of the Latin school. His fundamental idea of method was that nature should be followed, meaning by that that there is a natural sequence along which the mind moves in the acquisition of knowledge, through particulars to the general, thus for the first time applying the Baconian theory of induction in education. Consult: Barnard, *German Teachers and Educators* (Hartford, 1878); Quiek, *Educational Reformers* (New York, 1890). See EDUCATION; PEDAGOGY.

RATIFICATION (ML. *ratificatio*, from *ratificare*, to ratify, from Lat. *ratu*s, fixed, settled + *facere*, to make). In law, acts or words by which a person adopts as his own obligation the legal effect of an unauthorized act done by another on his behalf or for his benefit, or by which a person confirms and assents to be bound by a voidable obligation. If a person ratifies and accepts the benefits of an act, he must also be responsible for any consequences of the act, such as damage committed by the unauthorized person in doing it. Ratification may be *express*, that is, by assent expressed in positive terms, or *implied*, from acts from which a reasonable person would infer assent.

In Scotch law the term is applied to the separate acknowledgment of a married woman that a deed executed by her is voluntary and

made with full knowledge of its legal effect. See CONTRACT; INFANT; and consult the authorities referred to under CONTRACT.

RATING, in naval service. See RATE.

RATIOCIANITY (Lat. *ratiocinatio*, from *ratiocinari*, to reason, from *ratio*, reckoning, relation, reason), or REASONING. Reasoning, in psychology, is a successive association of judgments. Suppose that a complex of ideas (say, the look of a cloudy sky) is presented to consciousness. The attention plays upon this complex, and in obedience to some one of its various conditions (see ATTENTION) fixes upon some one of the constituent ideas. This idea is therefore drawn out of the mass, and rendered more prominent; at the same time, it becomes liable to associative supplementing. The complex of ideas is then reconstituted; we have what is technically known as an 'association after disjunction.' When this association takes place in verbal terms, we call the resulting complex a judgment. Thus, to work out the instance taken: I look at the sky, and say, "It is going to rain!" Certain of the visual ideas have attracted my attention; they have been drawn out from the general mass of visual ideas present in consciousness, and have been supplemented by the idea of rain. The whole situation has then been put together again; there has been a reassociation after the disjunction; and the prominent idea in the reconstituted consciousness is the idea of rain. The association takes a verbal form; the promise of rain is 'pre-iated' of the total look of the sky, so that we describe it as a judgment.

In saying, then, that reasoning is a successive association of judgments, we are saying, first, that it is an extremely complicated process. For the judgments that are successively associated are themselves the products of association after disjunction. In the instance given, the disjunction may well have been the work of the passive attention; in the typical judgment of logic, the work of an active attention is presupposed, and the whole process thus becomes, on its psychological side, much more complicated than we have represented it to be. As, however, the further complication is a matter not of kind, but simply of degree, we need not go into it in detail.

Again, in defining reasoning as we have defined it, we are saying, secondly, that it is a process that must have appeared relatively late in the history of mind. For the ideas in terms of which the constituent judgments are couched are symbolic (verbal) ideas, not reproductions or pictorial ideas; and a long mental history separates the reproductive from the symbolic idea. The reproductive counterpart of reasoning is to be found in the constructions of the creative or active imagination. See IMAGINATION.

Consult: James, *Principles of Psychology* (New York, 1890); Titchener, *Outline of Psychology* (ib., 1899); Ladd, *Psychology, Descriptive and Explanatory* (ib., 1894); Wundt, *Physiologische Psychologie* (Leipzig, 1893). For reasoning as a logical process, see DEDUCTION; INDUCTION; SYLLOGISM.

RATIONALISM (Lat. *rationalis*, from *ratio*, reason). A term employed in philosophy and theology to denote a system in which the reason is supreme. In theology it is contrasted with supernaturalism, and is used to describe a movement of thought, which had its important repre-

representatives in Germany in the last half of the eighteenth century, but was to be found in England and elsewhere in the previous century in the earlier stages of development. According to one of its recent historians, Kahnis, it "makes the educated reason of the times the standard of all religious truth, and the material principle of this reason is virtue, which demands and sustains belief in God and immortality." In philosophy, the term is used to denote the doctrine that reason is an independent source of knowledge, distinct from sense-perception and having a higher authority. In this sense it is opposed to sensationalism (q.v.). It is more widely used, however, for the view opposed to empiricism (q.v.) that in philosophy certain elementary concepts are to be sought, and all the remaining content of philosophy deductively derived from them. This view was first explicitly stated by Descartes, developed by Spinoza and Leibnitz, and formulated by Wolff. Kant endeavored to transform rationalism by showing how reason was implicit in experience; and Hegel revived it in a transformed sense with the construction of experience itself as a system of reason. Consult Lecky, *History of the Rise and Influence of the Spirit of Rationalism in Europe* (London, 1865); Tulloch, *Rational Theology and Christian Philosophy in England in the Seventeenth Century* (ib., 1872); Pfeleiderer, *The Evolution of Rationalistic Theology since Kant* (Eng. trans., ib., 1892); Hagenbach, *German Rationalism* (Eng. trans., Edinburgh, 1865). See also GERMAN THEOLOGY; KNOWLEDGE, THEORY OF.

RATIONS (from Lat. *ratio*, reckoning, relation, reasoning). In the United States Army, a ration is officially defined as "the allowance for the subsistence of one person for one day, and varies in components according to the station of the troops, or the nature of the duty performed." There are four descriptions of rations, which are known severally as the garrison ration, field ration, travel ration, and the emergency ration. In active service, or during emergencies, troops receive the *emergency ration*. Beef cattle are bought only when necessary for supplying troops on the march or during a campaign. Fresh meats are issued ordinarily seven days in ten, and salt meats on the remaining three days. In the United States Navy the ration is not allowed to officers paid on the army basis, but for all others it is commuted to a cash payment of 30 cents a day. The enlisted force of the navy is furnished food in accordance with a fixed allowance table without regard to its cost, which is, however, about 30 cents a day, and this sum is allowed when the ration is commuted (i.e. paid in money).

British soldiers have only one regular ration, which is the equivalent of the United States Army garrison ration. It consists of three-quarters of a pound of meat and one pound of bread per day. In war time the meat ration is increased to one pound. The official value of the ration is sixpence (12 cents). All other food over this amount, and such articles as tea, coffee, sugar, butter, salt, pepper, etc., are bought by the soldier at his own expense. Fourpence per day is deducted from the soldier's pay, and from the fund thus raised the articles necessary are obtained. In time of war, or on transports, the Government supplies all needed food, and the soldier receives his full pay. One of the most

important features of the Army Reorganization Bill submitted by the Secretary of State for War in 1902 was the proposal that the Government supply all necessary food, without charge, to the soldiers.

In the German Army the same skill and refinement of detail that marks the entire army organization is brought to bear on the question of the soldiers' daily food, with a result that while probably it is the most economical system in Europe, it is also one of the most excellent. The component parts are bread or zwieback, rice, bacon, fresh or canned meat, coffee, and salt. Japanese soldiers in time of peace receive a ration of rice besides which they are allowed extra pay to cover the expense for meat, vegetables, and so on. The most scientific ration in the world is that of the Italian Army. There are two regular rations, the garrison and the campaign.

RATIO STUDIO'RUM (Lat., scheme of studies). A code of rules which forms the basis for the guidance of Jesuit education. See JESUITS.

RATISBON. A city of Germany. See REGENSBURG.

RATISBONNE, rà'tès'bôn', LOUIS GUSTAVE FORTUNÉ (1827-1900). A French author and critic, born in Strassburg, and educated there and in Paris. He resigned from his post in the governmental employ on the declaration of the Empire; entered journalism, being on the staff of the *Debats* (1853-76); succeeded Feuillet as librarian at Fontainebleau; and in 1874 was appointed librarian to the Senate. Ratisbonne was the literary executor of Alfred de Vigny. His critical and literary studies included a metrical version of Dante's *Divina Commedia* (1854-59) and the essay *Henri Heine* (1885). But he was better known for his felicity as a poet of childhood, in such works as *Au printemps de la vie* (1857); *La comédie enfantine* (1860); *Les petits hommes* (1868); *Les petites femmes* (1871); various *Albums* under the pseudonym Trim; and *Les grandes ombres* (1900).

RATITÆ (Neo-Lat. nom. pl., from Lat. *ratitatus*, marked with the figure of a raft, from *ratia*, raft). A primary division of modern birds (Neornithes) based on the shape of the sternum, which is flat and without a keel. (See Plate of BIRDS, Fig. 4.). The Ratitæ are a very small group of the most ancient lineage, now confined to the Southern Hemisphere. It includes the extinct groups Dinornithes (moas), and Epyornithes (rocs), and the modern ostriches, rheas, emeus, cassowaries, and kiwis. Except the kiwis all are of very large size. The body is uniformly feathered (see PTERYLOSIS), and various anatomical features are characteristic. Naturalists are not agreed as to the precise relationships which exist between the Ratitæ and certain other groups, as, for instance, the Stereornithes (q.v.), but it is plain that the group is the most primitive of any having existing representatives; and it is now generally believed that it represents a degenerate stage of descent from ancestral forms which were birds of flight. Consult Gadow, in Bronn's *Tierreich Aves* (Berlin, 1893); Beddard, *Structure and Classification of Birds* (London, 1898); Evans, *Birds* (London, 1900); and the authorities therein cited. See BIRDS, FOSSIL; FLIGHTLESS BIRDS; and the names of various species of Ratitæ, as MOA, OSTRICH, etc.

RATNAGIRI, rāt'nā-gē'rē. A district in the Territory of Concan (q.v.), British India.

RATON, rà-tôn'. A city and the county-seat of Colfax County, N. M., seven miles south of the northern boundary of the Territory, and 22 miles south of Trinidad, Colo.; on the Atchison, Topeka and Santa Fe Railroad (Map: New Mexico, F 1). It is the centre of a stock-raising and farming region, which is also noted for its extensive coal deposits. There are large railroad repair shops here, the city being a division terminal of the Santa Fe line. Population, in 1890, 1255; in 1900, 3540.

RAT PORTAGE. A port of entry in Ontario, Canada, picturesquely situated on the Lake of the Woods at its outlet, and on the Canadian Pacific Railway, 133 miles east of Winnipeg (Map: Canada, M 7). The Winnipeg River here falls about 20 feet, affording good water power. There are several flour and saw mills; also reduction works. The town has become of considerable commercial importance, owing to the development of the gold-mining district in the vicinity. Population, in 1891, 1806; in 1901, 5202.

RATRAM'NUS (sometimes incorrectly called BERTRAM, or BERTRAMUS). An Aquitanian monk and theologian of the early ninth century, connected with the Monastery of Corbie, Picardy. He wrote a famous treatise, *De Corpore et Sanguine Domini*, a defense of the purely symbolical theory as to the Eucharist. In 1526 the work was brought into prominence through its being quoted by Bishop Fisher, of Rochester, as an exposition of the Roman Catholic doctrine regarding the Eucharist. Reprinted in 1527 at Cologne, it was much read by Protestants, and was placed on the *Index* by the Council of Trent. Subsequently it was defended within the Roman Catholic Church by Sainte-Beuve and Jacques Boileau. Ratramnus also wrote *Contra Græcorum Opposita*, in defense of the whole system of Western dogma. The collected works may be found in Migne's *Patrologia Cursus Completus, Series Latina*, tome 121 (Paris, 1844).

RATTAN, **RATAN**, or **ROTTANG** (Fr. *rotin*, *rotang*, from Malay *rotan*, rattan), *Calamus*. A genus of about 200 species of mostly East Indian palms with reed-like, slender, often jointed stems sometimes several hundred feet long. A few species are found in Africa and Australia. The name rattan is extended to other similar palms of the same tribe although placed by botanists in different genera. The stem, which is very smooth, hard, and siliceous externally, is either erect, or ascends by means of hooked prickles at the extremities of the midribs of its leaves. It then descends in graceful festoons and may climb neighboring trees. All the species are useful, being much employed in their native countries for making bridges, plaited work, chair bottoms, rope, and so on, and are very largely exported, generally under the name of cane, for similar purposes. *Calamus Rotang* and *Calamus rudentium*, occurring in India, Burma, and Ceylon, are among the most useful species. The walking sticks called Malacca canes are believed to be the produce of *Calamus Scipionum*; the plant, however, does not grow in Malacca, but in Sumatra. The fruit of some species of rattan is used as food, and the young shoots, variously prepared, are used as vegetables. A very fine

kind of dragon's blood (q.v.) is obtained from a species of rattan (*Calamus Draco* or *Dæmonorops Draco*), and particularly from the fruit, on the surface of which it appears as a resinous exudation. *Calamus acanthospathus* is one of the hardest species, occurring as it does at elevations of 6000 feet in the Himalayas.

RATTANY. See RHATTANY.

RATTAZZI, ràt-tât'sé, Mme. DE SOLMS-RATTAZZI-DE RUTE. See BONAPARTE, LÆTITIA MARIE WYSE.

RATTAZZI, URBANO (1808-73). An Italian statesman, born at Alessandria, Piedmont. He studied law at Turin and became an advocate at Casale. In 1848 he was elected a member of the Sardinian Parliament, and after sitting in the Casati Cabinet was called into the Ministry of Gioberti. He was one of those who urged Charles Albert into a continuance of the war with Austria in 1849, and after the defeat of Novara he was obliged to retire from the Ministry. He became the leader of the Left Centre, or Moderate Radical Party. In 1851, when Napoleon's coup d'état complicated foreign relations, an alliance was concluded between Cavour and Rattazzi, who had hitherto been opponents. Rattazzi took the portfolio of Justice in 1853, and subsequently that of the Interior in the Cavour Ministry. He disagreed with Cavour on the French alliance and retired from the Cabinet in 1858, but returned upon Cavour's resignation after the Peace of Villafranca. He was opposed to the surrender of Savoy and Nice to France, and he again retired in 1860. In March, 1862, after the failure of Ricasoli's Ministry, he was intrusted with the formation of a new Cabinet, but resigned after a few months. He returned to office in 1867, but his ambiguous attitude regarding Garibaldi's expedition against Rome in that year led to the downfall of his Ministry in October. He died at Frosinone. Consult: *Lettres inédites du comte de Cavour au Commandeur Urbain Rattazzi* (Paris, 1862); S. G., *Urbana Rattazzi* (Turin, 1861); De Rute, *Rattazzi et son temps* (Paris, 1881-87). An edition of his speeches, edited by Scovazzi, was published at Rome (8 vols., 1876-80).

RATTIGAN, SIR WILLIAM HENRY (1842—). An English lawyer, born in Delhi. He was educated at the High School, Agra, and at King's College, London, and was entered at the bar in 1873. He was additional member of the Supreme Legislative Council of India from 1892 until 1893, and member of the Punjab Legislative Council from 1898 until 1899, and at different times was Judge of the Chief Court of the Punjab. He was knighted in 1895, and was returned to Parliament as member for Northeast Lanarks in 1901. His works include: *The Science of Jurisprudence* (3d ed. 1892); *Private International Law* (1895); *Digest of Customary Law for Punjab* (6th ed. 1901); and *De Jure Personarum, or the Roman Law of Persons* (1873).

RATTLE-POD. A species of *Crotalaria* (q.v.).

RATTLESNAKE. An American venomous serpent of the family Viperidæ and subfamily Crotalinae, distinguished from its congeners by a horny jointed appendage terminating the tail, the shaking of which causes a rattling noise likened to that of the ancient castanets or *crotali*.

RATTLESNAKES

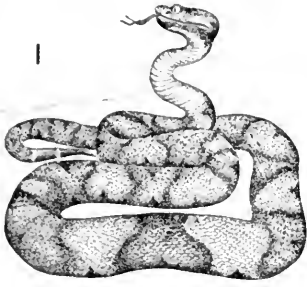

1

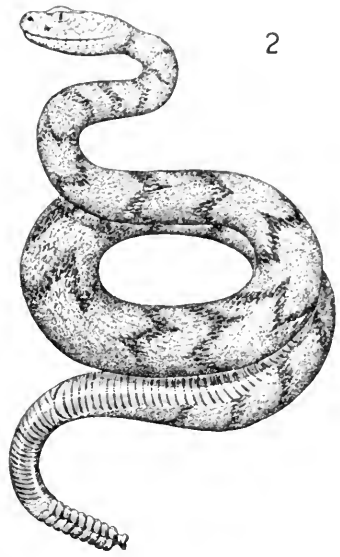

2

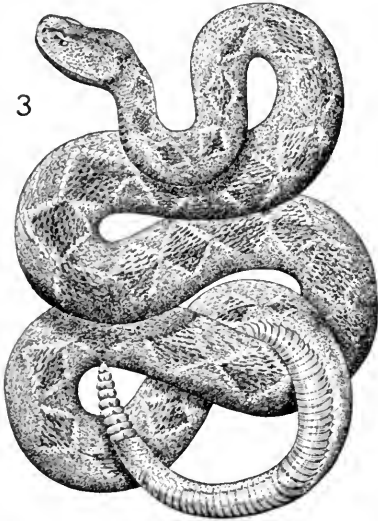

3

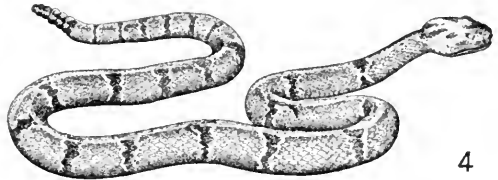

4

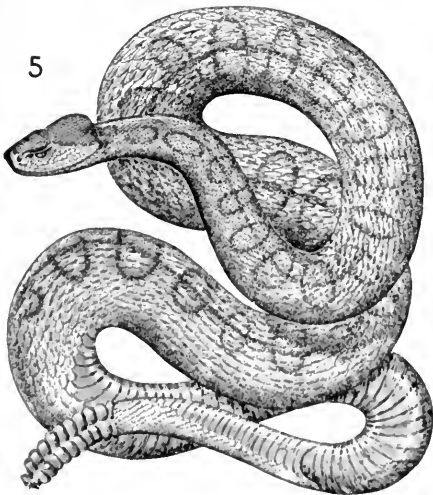

5

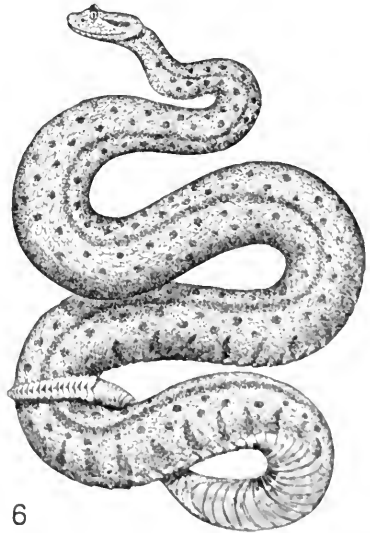

6

1. COPPERHEAD (*Ancistrodon contortrix*).
2. EASTERN BANDED RATTLESNAKE (*Crotalus durissus*).
3. DIAMOND RATTLESNAKE (*Crotalus adamanteus*).

4. GREEN RATTLESNAKE (*Crotalus lepidus*).
5. PLAINS RATTLESNAKE (*Crotalus confluentus*).
6. HORNED RATTLER, or SIDEWINDER (*Crotalus cerastes*).

The *Crotalinae*, until recently regarded as a family (*Crotalidae*, 'pit-vipers'), stand at the head of the ophidian ranks as the "most specialized type of snake structure," and exhibit the "highest efficiency of the venom apparatus." They are viper-like serpents of moderate length—none exceeding, and few approaching eight feet—but thick, heavy,

The curious epidermal structure at the end of the tail consists of a tapering series of amber-colored horny flattened bells which are locked into one another. The oldest or terminal bell (the 'button') is in reality the horny covering of the tip of the tail which was not discarded when the skin was first molted. At each succeeding molt the tip is pushed out by the new skin, and so a 'bell' is added at the base with each new shedding of the remainder of the skin. Theoretically these bells ought to indicate the number of moltings, and the age of the snake; but wear and accident interrupt or break the set so often that the rule does not hold with any certainty.

When the serpent is excited in any way it vibrates its tail, which (unless the creature is moving) is then held upright in the centre of the coiled body, with the head erect and menacing before it. This vibration—which is indulged by many kinds of snakes under nervous excitement—produces a peculiar humming noise, which increases in intensity and pitch as the snake's alarm or anger and the speed of vibration are augmented, until it may sound like the droning of an angry bee. The origin of the rattle can only be guessed at. A tendency toward armature of the tail is apparent in several other genera of pit-vipers; and in *Sistrurus* the rattle is much less well developed than in *Crotalus*. Apart from being a mere expression of emotion, the rattle serves to warn away cattle that might tread upon it, or enemies that might wish to seize it. This warning is well understood among all the wild animals, but when antelopes and deer hear it they will often attack the reptile and cut it to pieces with their sharp hoofs. The rattle is also believed to be a useful means of calling the sexes together.

The poison apparatus, fangs (which are of the proteroglyphic type), and the manner and result of biting, are treated of under SNAKE. Here it needs only be said that, like the vipers generally, these snakes are sluggish and loth to bite when it can be avoided, or when they are not surprised into a sudden stroke. This disposition varies, however, with the weather, their hunger, the season (all are irritable when sloughing their skin), and it differs in various species. Even the smallest may cause a man serious illness and perhaps death if it succeeds in introducing much poison into a wound; while a fairly delivered bite from the larger ones is almost certain to prove fatal. Its enemies are mainly confined to a few of the larger colubrine snakes, as the blacksnake, king-snake, and the like; to the pronghorn, Western deer, and Southern peccaries. Against man the rattlesnakes can make feeble resistance. Domestic pigs kill and eat as many as they can find, and rarely suffer harm, because of the thickness of the skin and the layers of fat underneath it, which prevent the fangs from entering or carrying venom to the system. Hunting of rattlesnakes affords occasional profit to a few persons, who find a market for their skins and for the clear smooth oil yielded by their fat, which is esteemed by watchmakers and gunsmiths, and is in demand as a medicine among the ignorant.

The most common and well-known of the rattlesnakes is that one (*Crotalus durissus*) formerly abundant all over the East, from the White Mountains in New Hampshire, and Lake Superior in the North, to the borders of the dry plains,

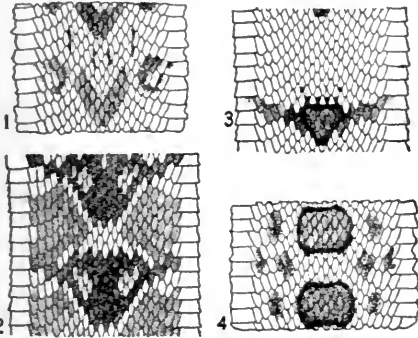

PATTERNS OF COLOR MARKINGS.

1, Common Eastern banded rattlesnake (*Crotalus durissus*); 2, Diamond rattlesnake (*Crotalus adamanteus*); 3, green rattlesnake (*Crotalus lepidus*); 4, plains rattler (*Crotalus couffientus*).

and extremely muscular. They are viviparous, and mainly terrestrial; but one, at least (the moccasin), is decidedly aquatic, and several in Central and South America are arboreal. In colors they vary adaptively to their haunts. All are more or less distinctly marked with darker spots and patterns of squarish form. The group is predominantly American, but several species inhabit the East Indies, some of them belonging to the American genera *Aneistrodon* and *Lachesis*. The latter includes more than half of the 60 or so species of pit-vipers recognized, and is mainly Neotropical. Among its species are the large and dangerous bushmaster and fer de lance (qq.v.). Among smaller genera one is *Teleuraspis*, a spe-

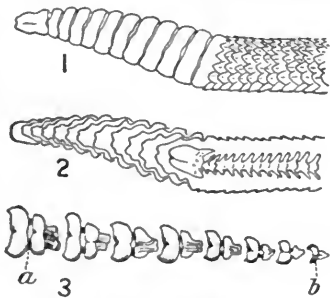

RATTLE OF A RATTLESNAKE.

1, Perfect rattle of a large banded rattlesnake; 2, longitudinal section of rattle; 3, separate segments of disjointed perfect rattle of *Crotalus* (side view): a, basal 'joint'; b, button.

cies of which (*Schlegelli*) is arboreal and often winds around the stems at the centre of banana bunches, where it sometimes fatally bites the first man to handle the fruit. None of these have rattles. The true rattlesnakes, then, are only those pit-vipers which belong to the genera *Sistrurus* (three species) and *Crotalus* (15 species), all of which, except two species of *Crotalus* in South America, belong to the Northern Continent.

It is larger in the Southern States than northward, and occasionally reaches a length of five feet, with a diameter in that case of four to five inches. The ground-color above varies from bright tawny to dark brown. A light line runs from the mouth to the eye, with a dark patch below; and the body is marked with three rows of confluent irregular brown spots, forming about 21 zigzag cross-bars. The head is oval in outline. This snake inhabits wooded regions, avoiding prairies. It is especially fond of rocky districts, and hence is most numerous among mountains, where it is inclined to gather in considerable numbers in certain holes and caverns in the autumn, in order to undergo the winter sleep in closely entwined companies. About nine young are born annually in mid-summer. The Southern States have a still larger species known as the 'diamond rattlesnake' (*Crotalus adamanteus*) on account of the rhomboidal black blotches, each perfect in all its angles, and edged with yellow, which ornament its yellowish body. This snake sometimes reaches, on the Mangrove Islands of western Florida, a length of eight feet, and has so great a thickness that large individuals may be regarded as the most bulky of all venomous snakes, for the Oriental cobras, although sometimes longer, are far more slender. The range of the diamond rattlesnake extends along the coast from North Carolina to Texas, and a variety ranges westward to Lower California. Two other similar and almost equally large and dreadful snakes are *Crotalus molossus* and *basiliscus*. Southern California also has a remarkable species (*Crotalus ruber*), which has an oblong head, and whose markings are deep red or sometimes chestnut, upon a paler reddish ground. The rattlesnake of the plains (*Crotalus confluentus*) is a light-colored, obscurely marked, rather small species. It is highly variable in form and color, and is the kind constantly found in prairie-dog towns. Several other species occur in the Rocky Mountain region and Northern Mexico, one of which (*Crotalus ecrastes*) is the characteristic snake of the deserts of the valleys of the Rio Colorado and Gila, where the people call it 'sidewinder,' from its habit of progressing sideways instead of in the usual way. It takes its specific name from the fact that the plates above the eyes are thickened into hornlike cones, sometimes of considerable height. It is not of large size, but is dangerous because of the virulence of its poison.

The small, active prairie rattlesnakes, now greatly reduced in number, differ sufficiently from the genus *Crotalus* to be set apart into the genus *Sistrurus*. One of them (*Sistrurus miliaris*) is the ground-rattler of the Southern States, too frequently met with in stubble fields and grassy places. A Northern congener is the black rattlesnake or 'massasauga,' once common between the Alleghany Mountains and the plains, but now nearly exterminated except on the frontier. This species (*Sistrurus catenatus*) may reach a length of 30 inches, and is brown, with a series of darker brown transverse spots on the back, beneath each of which is a small brown spot forming a linear series along the sides. Its rattle is small, but can be heard at a considerable distance, and its bite is likely to be exceedingly troublesome to men and domestic animals, although not often fatal. These snakes prefer low, wet ground, the draining of which by the spread

of farming operations has been the principal agency in their decrease.

Consult: Cope, *Crocodilians, Lizards, and Snakes of North America* (Washington, 1900); Stejneger, "Poisonous Reptiles of the United States," in *Annual Report United States National Museum* for 1893 (Washington, 1895); Bumpus, *Standard Natural History*, vol. iii. (Boston, 1885); Stejneger, "Reptiles of Death Valley," in *North American Fauna*, No. 7 (Agricultural Department, Washington, 1893). See SNAKE and Plate of RATTLESNAKES.

RATTLESNAKE PIKE. See SAND-PIKE.

RATTLEWING, or WHISTLEWING. The golden-eye duck. See GOLDENEYE.

RATZBURG, rät'se-boōrk, JULIUS THEODOR (1801-71). A German entomologist. He was born and educated in Berlin, where in 1828 he became privat-docent at the university. Two years afterwards, upon the removal of the Berlin Forestry School to Eberswalde, Ratzburg became its professor of natural science. By his work there as a teacher and his publications, he ranks as the founder of the scientific treatment of entomology as related to forestry. Among his more important writings are: *Die Forstinsekten* (1837-44; 2d ed. 1885); *Die Waldverderber und ihre Feinde* (1842); *Die Ichneumonien der Forstinsekten* (1844); *Waldverderbnis durch Insektenfrass* (1866-68); some botanical treatises, and a *Forstwissenschaftliches Schriftsteller-Lexikon*, completed by Acherson and containing an autobiography (1874).

RATZEL, rät'sel, FRIEDRICH (1844-). A German geographer and traveler, born at Karlsruhe, and educated in science at Karlsruhe, Heidelberg, Jena, Berlin, and elsewhere. As correspondent of the *Kölnische Zeitung* he traveled in 1869 in Italy, Sicily, and Southern France, and in 1872-75 in the United States, Mexico, and Cuba. In 1876 he became professor of geography at the Polytechnic School of Munich, and in 1886 was appointed to a similar position at the University of Leipzig. Among his printed works are: *Sein und Werden der organischen Welt* (1868); *Wandertage eines Naturforschers* (1873-74); *Vorgeschichte des europäischen Menschen* (1875); *Städte- und Kulturbilder aus Nordamerika* (1876); *Die Vereinigten Staaten von Nordamerika* (1878-80); *Die Erde, in 24 Vorträgen* (1881); *Völkerkunde* (1895); and *Die Erde und das Leben* (1902). With Schweinfurth he edited Emin Pasha's letters of travel and reports (Leipzig, 1888).

RAU, rou, KARL HEINRICH (1792-1870). A German economist, born at Erlangen. He studied at the University of Erlangen, where he became privat-docent in 1812, professor extraordinary in 1816, and in 1818 full professor of political economy. In 1822 he was called to the chair of political economy at Heidelberg University. His principal works are: *Ueber das Zunftwesen und die Folgen seiner Aufhebung* (1816); *Grundriss der Kameralwissenschaft und Wirtschaftslehre* (1823); and *Lehrbuch der politischen Oekonomie* (1826-37). Rau was at first an adherent of the views of the earlier German economic writers, and defended the policy of the guild regulations and of mercantilism. In his *Lehrbuch*, which was long considered the classical German work on economics, he adopts the gen-



RAUCH
STATUE OF FREDERICK THE GREAT IN BERLIN

eral position of Adam Smith and Say, but retains a tendency to advocate the extension of the economic functions of the State. He founded in 1835 the *Archiv der politischen Oekonomie und Polizeiwissenschaft*.

RÄUBER, roi'bër, DIE (Ger., The Robbers). An early play of Schiller (1781), which, with many imperfections, attained great success by reason of its dramatic power. The hero, Karl Moor, a student in Leipzig, is disowned by his father through the machinations of his brother, and in desperation becomes the captain of a band of robbers. His exploits are directed toward righting wrongs and punishing misdeeds, and he becomes famous as an outlaw. Finally he returns to his home, rescues his father from his brother's cruelty, and in expiation of his deeds delivers himself up to the law.

RAUCH, rouk, CHRISTIAN DANIEL (1777-1857). The most celebrated German sculptor of the nineteenth century. He was born January 2, 1777, at Arolsen, in the Principality of Waldeck. His father was employed at the Court of Prince Frederick II. of Hesse, and in 1790 the lad was apprenticed to the Court sculptor Valentin at Arolsen; in 1795 he became assistant to Ruhl, Court sculptor at Cassel. On the death of his father in 1797, Rauch abandoned sculpture temporarily, and entered the personal service of King Frederick William III. of Prussia. Studying at odd moments, he came under the influence of Johann Gottfried Schadow; in 1802 he exhibited his first statue, a "Sleeping Endymion and Artemis," and in 1803 his bust of Queen Louise. In 1804 he went to Rome, provided with a small stipend. During his six years' stay at Rome his art was chiefly influenced by Thorwaldsen and by the antique. Among these early works were reliefs of "Hippolytus and Phedra," "Mars and Venus Wounded by Diomedes," and busts of the King of Prussia and Queen Louise, besides others executed by order of the King of Bavaria for the Walthalla.

In 1818 he was summoned to Berlin by the King and given the commission for a monument to Queen Louise in the royal mausoleum at Charlottenburg. The marble statue of the Queen, dressed in a light garment which charmingly reveals the figure, reclines on a simple sarcophagus. This work, one of the most interesting in modern German sculpture, gave Rauch a European reputation. A similar statue of the Queen, even more successful, was placed in the park of Sans Souci at Potsdam. While engaged upon his works he found time to model numerous excellent portrait busts, among the best of which are those of Dürer (1837, Walthalla), of Thorwaldsen for the King of Denmark, and a colossal bust of Goethe (1820). In 1819 he established a royal atelier of sculpture in Berlin, and assisted Schinkel in his scheme for the museum, which was finished in 1830.

A projected statue of Goethe for Frankfort was modeled, but not executed, though a charming statuette of the poet in his study gown is well known. Rauch made an interesting series of bronze statues of German heroes of the Napoleonic wars, the best of which are at Berlin and at Breslau. Other important works are: the monument of the two Polish princes Mieczislaw and Boleslaw, in the Cathedral of Posen (1840); the statue of Albrecht Dürer in Nuremberg

(1840); the Max Joseph monument in Munich (1833); the gable group and six smaller Victorias for the Walthalla near Regensburg. His greatest work is the immense bronze monument of Frederick the Great in Berlin (1839-51). A colossal equestrian statue of the King surmounts a pedestal, about the base of which are groups of generals and soldiers, and bas-reliefs representing scenes in the life of Frederick. Rauch's works combined, to a remarkable extent, absolute natural truth with ideality of character, and he succeeded in the difficult task of adapting modern costume to the ideal portrait representation. He was the founder of the Berlin school of sculpture, the most important in Germany, and in which his spirit yet prevails. Consult: *Abbildungen der vorzüglichsten Werke Rauchs mit erläuterndem Text von Waagen* (Berlin, 1827-29); Eggers, *Christian Daniel Rauch* (5 vols., ib., 1873-90), the leading biography, upon which Cheney's *Life of Christian Daniel Rauch* (Boston, 1893) is based; Dobbert, *Rauch* (Berlin, 1877); Eggers, *Rauch und Goethe, urkundliche Mittheilungen* (ib., 1889); also Merckle, *Das Denkmal König Friedrich des Grossen* (Berlin, 1894).

RAUHES HAUS, rou'es hous. One of the earliest industrial institutions for poor boys, founded by Wichern at Horn, near Hamburg, November 1, 1833, in an old house called by its former occupant 'Ruges Hus,' which by a mistranslation into high German became Raupes Haus. There are now about 25 buildings occupied by the boys, who live in groups (families) of 12 or 15 under the charge of a brother. The scope of the school has widened with its growth, and now comprises: (1) Department for neglected children who receive a common school education and are trained for handwork, and later on are apprenticed or employed in the institution. (2) Department for trades instruction. (3) Boarding department for boys of better families. (4) A training school, begun in 1845, for workers in charitable societies and institutions. The men are called brothers, and most of them have found service under the Innere Mission (q.v.) (5) Book department, including a printing office, started in 1844. The oversight and care of the children falls largely on the assistants, who are training for work in other institutions. The Raupes Haus with the institution at Mettray, France, have been widely and favorably known. Consult Wichern, *Das Rauhe Haus von 1833-83* (Hamburg, 1883).

RAUMER, rou'mër, FRIEDRICH LUDWIG GEORG VON (1781-1873). A German historian, born at Wörlitz, near Dessau. He studied at Berlin, Halle, and Göttingen, and held government appointments from 1806 to 1811. In that year he was made professor of political science at Breslau, and in 1819 was called to Berlin. He traveled widely during the years from 1827 to 1843, and the results of his observations were embodied in several works. He was secretary of the Berlin Academy of Sciences, but resigned in 1847. He was a member of the German National Assembly of 1848-49 at Frankfort. Subsequently he became a member of the Upper House of the Prussian Diet. His more important works are: *Geschichte der Hohenstaufen und ihrer Zeit* (1823-25, 5th ed., 1878), a

standard work on that period; *Ueber die geschichtliche Entwicklung der Begriffe von Recht, Staat und Politik* (2d ed., 1826); *Geschichte Europas seit dem Ende des 15. Jahrhunderts* (1832-50); *Beiträge zur neuern Geschichte aus dem Britischen Museum*, etc. (1836-39); *Die vereinigten Staaten von Nordamerika* (1845); *Antiquarische Briefe* (1851); *Handbuch zur Geschichte der Litteratur* (1864-66). With F. A. Brockhaus he founded in 1830, and until 1867 also edited the *Historisches Taschenbuch*.

RAUMER, KARL (GEORG VON) (1783-1865). A German geologist and educator, born at Würnitz, brother of the preceding. After studying at several German universities, and at the mining academy at Freiberg, in 1811 he became professor of mineralogy at Breslau, and in 1819 at Halle, whence in 1823 he went to the Dittmar training school in Nuremberg, and in 1827 he was appointed professor of natural history at Erlangen. Among his works are: *Geognostische Fragmente* (1811); *ABC-Buch der Kristallkunde* (1820-21); and *Lehrbuch der allgemeinen Geographie* (1832; 3d ed. 1848). On education he wrote an important *Geschichte der Pädagogik* (1843-51), which has been translated into English and published in America. Raumer's autobiography was published at Stuttgart in 1866.

RAUPACH, rou'päg, ERNST (1784-1852). A German dramatist. He was born at Straupitz, Silesia; studied theology at Halle; was for ten years tutor in Russia, and was subsequently (1816) appointed professor of philosophy, German literature, and history in the University of Saint Petersburg. Raupach left Russia in 1822, and, after a visit to Italy, settled in Berlin, where he devoted the remainder of his life chiefly to writing for the stage. His facility was remarkable, and he wrote in all about eighty plays, besides letters and poems. Among his early pieces the following are noteworthy: *Die Gefesselten* (1821); *Die Freunde* (1825); and *Isidor und Olga* (1826). Among his comedies may be mentioned *Die Schleichhändler*; *Der Zeitgeist*; and the farces, *Denk' an Cäsar* and *Schelle im Monde*. Of his posthumous works are: *Der Keckspieler* (1853); the tragi-comedy, *Mulier Taccat in Ecclesia* (1853); and *Saat und Frucht* (1854). The popular drama *Der Müller und sein Kind* still holds the stage. He collected his earlier plays in two volumes, *Dramatische Werke komischer Gattung* (1829-35), and *Dramatische Werke ernster Gattung* (1830-43). Raupach's writings display great knowledge of stage effect, a happy talent for the invention of new and interesting situations, and a fine play of verbal wit. Consult Pauline Raupach, *Raupach, eine biographische Skizze* (Berlin, 1853).

RAUPENLEIM, rou'pen-lim (Ger., caterpillar lime). A crude petroleum product resembling an impure vaseline, more or less greasy, smooth, of a butter like consistency at ordinary temperatures, and absolutely resisting wash by rains, which is frequently used to form a band about trees to keep certain insects from climbing to the branches.

RAUPP, roup, KARL (1837-). A German landscape and genre painter, born at Darmstadt. After studying under Jakob Becker at the Städels-Institute in Frankfurt, he became a pupil and zealous follower of Piloty in Munich (1860-65).

where he soon gathered a small school. From 1868 to 1878 he was professor at the School of Arts in Nuremberg, and after then at the Academy in Munich. His finely colored scenes from fishermen's and peasant life around Chiem Lake, which form his favorite subjects, show equal devotedness in the treatment of landscape and figures, and include: "In the Face of the Storm" (1885, Dresden Gallery); "Peace" (1889, National Gallery, Berlin); "Serious Meeting" (1889, Münster Gallery); and "Chiem Lake" (1898, Reichstags-Gebäude, Berlin). He published a *Katechismus der Malerei* (3d ed. 1898).

RAVAILLAC, rá'vá'yák', FRANÇOIS (1578-1610). The assassin of Henry IV. of France. He was born at Angoulême, was a notary's clerk and schoolmaster, suffered imprisonment for debt, and became diseased in health and unsettled in mind. After his release he joined the Order of Feuillants in Paris, but was expelled as a visionary fanatic, and then became inspired with hatred of the Huguenots, and determined to kill the King. On May 14, 1610, as the King was passing in his coach through the narrow street of Laferronnerie, Ravailiac climbed upon the right rear wheel of the carriage at the moment that its advance was hindered by a heavy wagon, and leaning forward he plunged a knife into the breast of the King. The first blow glanced aside but at the second thrust the knife entered the heart. Ravailiac escaped in the confusion, but was soon captured, admitted his guilt, and after a formal trial was put to death in the Place de Grève, May 27th, being torn asunder by horses. He steadily refused to say whether he had accomplices. Suspicion has rested upon the Queen, Maria de' Medici, and her favorites, the Concini, upon the Duke of Epernon, and on the Spanish Court and its Jesuit advisers, but proof is lacking. Both Martin and Poirson have examined the case against Ravailiac with care, and have come to the conclusion that the real cause was fanaticism which had degenerated into monomania. Consult: Poirson, *Histoire du règne de Henri IV.* (Paris, 1857); Loiseau, *Ravailiac et ses complices* (ib., 1873); Martin, *Histoire de France*.

RAVANA, rá'vá-ná (Skt., howler). The name of a Rakshasa (q.v.) who ruled over Lanka or Ceylon, and was said to be a monster with ten heads. He carried off Sita, the wife of Rama, to his residence, but was ultimately conquered and slain by the latter. See RĀMĀYANA.

RAVELIN. See FORTIFICATION.

RAVEN (AS. *hracfn*, OHG. *hraban*, *raban*, Ger. *Rabe*, raven; perhaps connected with OPruss. *kracco*, black woodpecker, Lat. *corvus*, Gk. *κόραξ*, *korax*, raven, Lat. *cornix*, Gk. *κόρῳξ*, *korōñc*, crow, Skt. *karava*, raven, and with Lat. *crocire*, OChurch Slav. *krakati*, to croak, as well as with OHG. *hruoñ*, AS. *hroc*, Eng. *rook*). The largest of corvine birds (*Corvus corax*), a species of crow usually more than two feet in length. The feathers on the neck are long, narrow, and pointed, forming a ruff; the bill is strong, compressed, sharp, somewhat hooked, and surrounded at the base with feathers and bristles. The wings are long and powerful; the color is uniform black, lustrous in the male, and although this bird is nowhere migratory, even during winter in the Arctic regions, it never turns white at that season, as do most Arctic

animals. The raven was originally to be found in almost all parts of the Northern Hemisphere, but is now nearly or quite extinct east of the high central plains, though still numerous in the western half of the country, and in Northwestern Canada. It goes about alone, or in pairs, and is one of the most omnivorous of birds, feeding on fruits and nuts, insects, worms, mollusks, birds' eggs and fledglings, and small mammals. It rejoices in carrion, and not infrequently attacks weak or sickly beasts, almost invariably choosing their eyes as its first point of assault. It makes its nest of sticks, coarse weeds, wool, hair, and the like, on a narrow ledge of a precipice or in some similarly inaccessible situation, usually as early as February. The eggs are green, thickly marked with dark streaks and blotches. (See Plate of EGGS OF SONG BIRDS.) Ravens are occasionally captured when young and become interesting pets. By nature they are impudent, cunning, inquisitive, and mischievous. They destroy everything that can be destroyed, apparently with real pleasure; and they will steal anything they can carry off, particularly glittering things. Moreover, they have considerable power of imitating human speech. Newton and others regard the raven as the most highly developed mentally and physically of all birds. It is celebrated for its longevity, and instances are on record of its living seventy or eighty years. In the Southwestern United States there is found a crow-like bird, the white-necked raven (*Corvus cryptoleucus*), with the neck-feathers of a raven, but their bases pure white. Several other species are known in various parts of the world. Consult Newton, *Dictionary of Birds* (New York, 1896), and authorities therein cited. Compare CROW; JACKDAW; and see Plate of JAYS, MAGPIES, ETC.

RAVENALA. A Madagascar plant. See TRAVELER'S TREE.

RAVENEL', HENRY WILLIAM (1814-87). An American botanist, born in Saint John's Parish, Berkeley County, S. C. He became a planter in Saint Johns, and then went to Aiken, S. C. He made a special study of the phenogams of South Carolina and various fungi and cryptogams. The genus *Ravenelia* of the Uredinea is named after him. His works include: *Fungi Caroliniani Essiccati* (1853 to 1860), and *Fungi Americani Essiccati* (1878 to 1882) with M. C. Cooke.

RAVENNA, rá-vén'ná. The capital of the Province of Ravenna, in the Compartimento of Emilia, Italy, situated on a marshy, unhealthy plain between the Lamone and the Fiumi Uniti, six miles from the Adriatic, and about 40 miles east by south of Bologna (Map: Italy, G 3). Ravenna, connected with the sea by a canal, is surrounded by old bastions and low walls where may still be seen the iron rings to which the cables of ships were formerly fastened when the city was a seaport. It lies in a compact form. On the outskirts are extensive parks and pleasure grounds. In the centre of the town is the Piazza Vittorio Emanuele, with two high columns erected in 1483 by the Venetians and bearing the statues of Saints Vitalis and Apollinaris. The streets are wide and the squares are adorned with interesting statues, but the houses present a gloomy appearance, and the place, in its stillness, has a rather depressing effect on the visitor. With its basilicas Ravenna

is highly important in the history of Christian art from about 400 to 800, the Byzantine and the early Roman forms of architecture being here abundantly illustrated and suggestively united in the ancient churches. The basilicas here differ in many respects from those of Rome. Their interiors manifest also Ravenna's prominence in mosaic painting. The Cathedral of Sant' Orso was rebuilt in 1734, and is of no great interest. Its ivory throne of Saint Maximian, its "Elijah" by Guido Reni, and the ornamentation of animals and foliage are, however, valued. The fine octagonal Baptistery adjoining, supposed to be part of a Roman bath, was largely reconstructed after 1865. The interior is embellished with statues, and with the oldest (fifth century) of the rare mosaics of Ravenna, one of which here represents the Baptism of Christ. The interesting Church of San Vitale, situated where the saint was martyred, was consecrated in 547. It is octagonal. Its choir is embellished with rich mosaics. Charlemagne patterned the cathedral at Aix-la-Chapelle after this church. In the vicinity is the noteworthy mausoleum of Galla Placidia, now the San Nazario e Celso, begun in the middle of the fifth century by that Empress. Its mosaics also are fine. Many of the earliest buildings in Ravenna are due to Galla Placidia and her brother Honorius. These structures form in fact the unique period of its religious architecture. The interesting Basilica of Sant' Apollinare Nuovo, containing elaborate mosaics, was built by Theodoric as an Arian church. Adjacent to the Church of San Francesco is the tomb of Dante. It was reconstructed in 1780. His remains, which were kept hidden until 1865, are now inclosed in a marble urn. Another noteworthy church is the large Sant' Apollinare in Classe Fuori, dating from 535, and restored in 1779.

In the northeast portion of Ravenna stands the old city castle, the Rocca di Brancaleone, of Venetian origin, and partly demolished in 1735. Still farther northeast is the mausoleum of Theodoric the Great, called the Rotonda, decagonal in shape, with a flat roof. A part of the palace of Theodoric, architecturally as well as historically of great interest, is still to be seen, together with a porphyry basin which is designated as the King's coffin. The archiepiscopal palace, decorated with excellent mosaics, was restored in the sixteenth century. The Academy of Fine Arts, founded in 1827, has nothing of great note. The Byzantine Museum contains sculptures, fragments of architecture, etc. The former Monastery of Classe, dating from 1515, holds the municipal collections. The communal library, dating from 1707, has about 75,000 volumes and 800 manuscripts, including several very precious ones. Ravenna is intimately associated with the lives of Dante and Lord Byron. They made famous the ancient pine forest which extends many miles along the coast to the southeast. Directly south of the city rises the column of Gaston de Foix, who on April 11, 1512, defeated the Spanish and Papal forces here and fell in the moment of victory. The principal industries are the cultivation of the vine, the spinning and weaving of silk, and the manufacture of wine, glass, leather, bricks, and musical instruments. A large fair is held in May. The commerce is in cereals, wine, fruits, rice, and fish.

The population of Ravenna (commune) was, in 1881, 60,573; in 1901, 89,957.

HISTORY. Ravenna is one of the oldest towns in Italy. In Augustan times the Roman Adriatic fleet was stationed here and there was considerable commerce. In 404 the Emperor Honorius made this, then a city on the sea, his abiding place because it was well defended. Some years later it became an archiepiscopal see. Ravenna attained its distinctive prominence after the fall of the Roman Empire. It was seized by King Odoacer, and passed (493) into possession of the Ostrogoth Theodoric and became a magnificent seat of royal power. It was taken by Belisarius in 540 (539?), and was a place of official importance under the Greek emperors until 752 (see **RAVENNA, EXARCHATE OF**); it was next ruled by the Lombards. It soon fell into the hands of Pepin the Short, who turned it over to the Papal sway. Late in the thirteenth century it fell under the sway of the Polenta family. In 1441 it became subject to Venice, under whose régime it prospered greatly. In 1509 it was taken by Pope Julius II., and it remained a Papal possession until 1797. After being under French control for 17 years it was restored to Papal dominion by the Congress of Vienna, and became a part of the Italian kingdom in 1860.

Consult: Quast, *Die altchristlichen Bauwerke von Ravenna* (Berlin, 1842); Cardoni, *Ravenna antica* (Faenza, 1879); Diehl, *Ravenna; études d'archéologie byzantine* (Paris, 1885); Gregorovius, "Von Ravenna bis Mentana," in *Wanderjahre in Italien*, vol. iv. (5th ed., Leipzig, 1892); Goetz, *Ravenna* (ib., 1901).

RAVENNA. A village and the county-seat of Portage County, Ohio, 30 miles southeast of Cleveland; on the Erie, the Pennsylvania, and the Baltimore and Ohio railroads (Map: Ohio, II 3). It is in the lake region of northeastern Ohio, and has important agricultural interests. There are also iron works, machine shops, boiler works, foundries, and manufactories of flour, lumber products, brick and tile, electrical supplies, chairs, etc. Population, in 1890, 3417; in 1900, 4003.

RAVENNA, EXARCHATE OF. The designation of that part of Italy which was under the rule of the Byzantine emperors from 568 to 752. The capital of the governor or exarch (q.v.) was at Ravenna, and for a short time he ruled over the whole of Italy. When in 568 the Lombards began to invade Italy, which had been conquered by Narses (q.v.) in 553, the old Roman names and divisions rapidly disappeared, and new ones arose. A high military functionary, the exarch, was sent from Constantinople to resist the barbarians, the first one being appointed some time between 572 and 584. The Lombards soon conquered large portions of Italy, so that the various parts of the exarchate were no longer continuous, there being finally seven separate strips of territory, the chief of which situated about Genoa, and known as Liguria, was taken by the Lombards in 640. In 752 Aistulf, King of the Lombards, captured Ravenna, and the exarchate ceased to exist. The government of the exarch was always a military one and almost independent of all control, due to the difficulty of communication with Constantinople. The name exarchate continued to be used for the territory around Ravenna, which

had been given to the Papacy by Pepin in 755, as late as the twelfth century. Consult: Diehl, *Etudes sur l'administration byzantine dans l'exarchat de Ravenne* (Paris, 1888); Hartmann, *Untersuchungen zur Geschichte der byzantinischen Verwaltung in Italien* (Leipzig, 1889).

RAVENSBURG, rä'vens-böörk. A town in Württemberg, Germany, situated in a fertile valley, on the Schussen, 52 miles by rail south by west of Ulm (Map: Germany, C 5). It is mediæval in appearance. The leading industries are the spinning and weaving of woolen and linen fabrics. Ravensburg, founded in the eleventh century by the Welfs, became a free Imperial city in 1280. It belonged to Bavaria from 1803 to 1810, when it passed to Württemberg. Population, in 1900, 13,444.

RAVENSCROFT, EDWARD. An English dramatist, of the seventeenth century, best known for his polemic with Dryden. His plays were remarkably successful translations or remodelings of old plays. *Mamamouchi*, played first in 1671, adapts Molière's *Bourgeois gentil homme*; *The Wrangling Lovers* (1676) is an imitation of Thomas Corneille's *Engagements du hasard*; *Scaramouch* is a contamination of the *Marriage forcé* and the *Fourberies de Scapin*; and in *The Canterbury Guests* (1694) Ravenscroft actually composed a play almost entirely from his own previous work.

RAVENSCROFT, THOMAS (c.1592-c.1635). An English composer. He was born near London, received his musical education in Saint Paul's choir, and had the degree of bachelor of music conferred on him in 1607. In 1611 appeared his *Melismata, Musically Phansies*, etc., a collection of 23 part-songs, some of them of great beauty; and three years later he brought out another collection of part-songs under the title of *A Brief Discourse*, an essay on the old musical modes. Turning his attention to psalmody, he published in 1621 a collection of psalm tunes for four voices entitled *The Whole Book of Psalms, composed into Four Parts by Sundry Authors to Such Tunes as Have Been, and are Usually Sung in England, Scotland, Wales, Germany, Italy, France, and the Netherlands*. This was the first publication of its kind and innumerable similar works of subsequent date have been largely indebted to it. Each of the 150 psalms has a distinct melody assigned it. Two collections of secular songs similar to the *Melismata*, and entitled *Pammelia* and *Deuteromelia*, have been assigned to Ravenscroft; but it is probable that only a few of these songs were composed by him, while he may have revised and edited the whole. A selection from his works was printed by the Roxburgh Club in 1822. He died in London.

RAVENSTEIN, rä'ven-stin, ERNST GEORGE (1834—). A German-English geographer and cartographer, born at Frankfort-on-the-Main. He became, when eighteen years old, a pupil of Dr. A. Petermann, the celebrated geographer of Gotha. Removing to England, he was for twenty years (1855-75) in the service of the Topographical Department of the War Office. He served for years on the Councils of the Royal Statistical and Royal Geographical Societies, and was professor of geography at Bedford College in 1882-83. He was thoroughly instructed in the German school

of geography and his influence upon geographical interests and improved map-making in Great Britain has been helpful. He carried out many of his ideas as to the best methods of imparting cartographic information in his *Systematic Atlas* (1884), and especially as an expert in African geography and cartography and the history of early explorations. His *Map of Equatorial Africa* (1884) was the most notable map of a large part of the continent on a large scale that had been made up to that time. He was the first to receive the Victoria gold medal of the Royal Geographical Society (1902).

RAVESTYEN, rä've-stin, JAN VAN (c.1572-1657). A noted Dutch portrait painter, born at The Hague, where he entered the guild in 1597 and was repeatedly its dean. He was the first to paint those large groups of magistrates, and governors or trustees of corporations, and the like, in which Frans Hals, van der Helst, and Rembrandt displayed such mastery. The Municipal Museum at The Hague contains four pictures of that kind by this favorite painter of the fashionable society at The Hague, to wit: "Civic Guard Issuing from the Doelen" (1616); "Banquet of the Town Council" (1618); "Meeting of the Town Council" (1636)—superior to all others in coloring, full of grave harmony—and "Six Officers of the White Arquebusiers" (1638). In the Royal Gallery at The Hague are 24 portraits, "Colonels in the Dutch Service" (dated from 1611 to 1624). In the Brussels Museum may be seen the portrait of "Kenau Hasselaar," the famous heroine of Haarlem; in Dresden that of "Maurice of Orange" (1605); and in Brunswick the portrait of a "Lawyer" (1622), and an interesting life-size "Family Group of Ten." Others are in the Louvre (1633, 1634), in Amsterdam, Berlin, Munich, Copenhagen, and Turin, and a portrait of "Lucretia van der Meulen" is in the gallery of the Historical Society, New York City.

RAVIGNAN, rä've'nyän', GUSTAVE FRANÇOIS XAVIER DELACROIX DE (1795-1858). A noted French pulpit orator. He was born at Bayonne, studied in the Lycée Bonaparte at Paris, and having embraced the legal profession (1814), and obtained his degree, was named auditor of the Cour Royale at Paris, and afterwards (in 1821) received an appointment in the tribunal of the Seine. In 1822 he resolved to enter the Church. Having spent some time in the College of Saint Sulpice, he soon passed into the novitiate of the Jesuits at Montrouge, and thence to Dôle and Saint Acheul for his theological studies, at the termination of which he was himself appointed a professor (1828). On the expulsion of the Jesuits from France (in 1830), Ravignan withdrew to Brieg, in Switzerland, where he first taught, and then preached in various places. In 1835 he appeared in the pulpit of the Cathedral of Amiens, and finally (in 1837) was selected to replace Lacordaire (q.v.) at Notre Dame, Paris, in the duty of conducting the special 'conferences' for men which had been opened in that church. For ten years Ravignan occupied this pulpit with a success which has rarely been equaled, and his 'conferences' are regarded as models of ecclesiastical eloquence. In 1842 he undertook in addition to preach each evening during the entire Lent; and it is to the excessive fatigue thus induced that

the premature break-down of his strength is ascribed. He published an apology of his Order in 1844 (Eng. trans., *On the Jesuits, Their Institute, Doctrines, etc.*, London, 1844); and in 1854 a more lengthened work with the same view, *Clément XIII. et Clément XIV.*, which was intended as a reply to the *Life of Clément XIV.*, by the Oratorian Father Theiner. These, with some occasional sermons and 'conferences' (Eng. trans., London, 1873), constitute the sum of the publications issued during his life. He died in the convent of his Order at Paris. Consult his *Life* by A. Frogier de Ponlevoy (Eng. trans., London, 1869), and Poujoulet (Paris, 1862).

RAWALPINDI, rä'wül-pin'dè or rä'al-. A municipality and large cantonment, the capital of a district of the Punjab, British India, between the rivers Indus and Jhelam, 90 miles southeast of Peshawar (Map: India, B 2). It has a fort used as an arsenal and is encircled by a chain of defensive works. Its importance is purely military. It occupies part of the site of ancient Gajipur, and interesting archaeological relics have been unearthed. In 1849 the Sikhs surrendered here after their defeat by Gough at Gujarat. Population, in 1891, 73,800; in 1901, 87,688.

RAWDON-HASTINGS, FRANCIS, first Marquis of Hastings. An English soldier and statesman. See HASTINGS, FRANCIS RAWDON-HASTINGS, first Marquis of.

RAWITSCH, rä'vich. A town in the Province of Posen, Prussia, 64 miles south of Posen (Map: Prussia, G 3). It manufactures snuff, cigars, copper, iron, carpets, furniture, and horse-hair goods. Rawitsch was founded in 1632 by Protestant refugees. Population, in 1900, 11,739.

RAWLE, rä'l, WILLIAM (1759-1836). An American jurist, born in Philadelphia. After studying law in New York for some time Rawle went to London, and completed his studies in the Middle Temple. Returning to Philadelphia, he was admitted to the bar in 1783, and in 1791 was appointed United States District Attorney for Pennsylvania by President Washington, in which capacity he prosecuted the leaders of the Whisky Rebellion. He was once counsel for the United States Bank, was chancellor of the Associated Members of the Bar of Philadelphia and of the Later Law Association of Philadelphia, and in 1830 assisted in revising the civil code of Pennsylvania. In addition to his legal activities, he took much interest in science and in philanthropic and other undertakings; was the first president of the Pennsylvania Historical Society; and was a president of the Abolition Society; and for forty years was a trustee of Pennsylvania University. His publications include: *Judication of Rev. Mr. Heckewelder's "History of the Indian Nations"* (1818); *A View of the Constitution of the United States* (1825; 2d ed. 1829); and *Discourse on the Nature and Study of the Law* (1832). Consult Wharton, "A Memoir of William Rawle, LL.D.," in the *Collections of the Pennsylvania Historical Society*, vol. iv. (1840).

RAWLE, WILLIAM HENRY (1823-). An American lawyer, born in Philadelphia. He graduated at the University of Pennsylvania in 1841. Three years afterwards he was admitted to the bar, and quickly rose to prominence in his profession. He was vice-provost of the Law Academy

of Philadelphia from 1865 to 1873, and from 1880 until his death, was vice-chancellor of the Law Association of Philadelphia. In 1852 he published the first edition of his *Practical Treatise on the Law of Covenants*, which is still an authoritative work. Besides various important works, which he edited, he wrote *Equity in Pennsylvania* (1868); *Some Contrasts in the Growth of Pennsylvania and English Law* (1881).

RAWLINS. A city and the county-seat of Carbon County, Wyo., 136 miles west by north of Laramie; on the Union Pacific Railroad (Map: Wyoming, F 5). It is the seat of the State Penitentiary. Rawlins has considerable commercial importance as the shipping centre for extensive sheep-raising and mining interests. The Union Pacific Railroad maintains repair shops here. Population, in 1890, 2235; in 1900, 2317.

RAWLINS, JOHN AARON (1831-69). An American general and Secretary of War, born in East Galena, Ill. At Galena he studied law in the office of Isaac P. Stevens, with whom in 1854 he entered into partnership. On April 16, 1861, shortly after the fall of Fort Sumter, he made a powerful war speech at a meeting which was presided over by Ulysses S. Grant. Shortly afterwards he became a major in an Illinois regiment, but at the request of Grant, who was now a brigadier-general and who had been favorably impressed by Rawlins, he resigned that post in order to become Grant's assistant adjutant-general. From that time until the close of the war he was Grant's close friend and adviser. He became chief of staff in November, 1862, and was honored with numerous promotions, ending with that of brevet major-general, March 13, 1865. Although he had had no previous military training, Rawlins showed keen insight into military problems. General Sherman said of Rawlins that he was "an intense thinker, and a man of vehement expression; a soldier by force of circumstances rather than of education or practice, yet of infinite use to his chief throughout the war and up to the time of his death." When Grant became President he made Rawlins his Secretary of War. Rawlins, however, had contracted consumption as a result of exposure during the war, and he died at Washington, September 6, 1869.

RAWLINSON, GEORGE (1812-1902). An English historian and Orientalist. He was born at Chadlington, Oxfordshire, November 23, 1812. He was the brother of Sir Henry Creswicke Rawlinson (q.v.). He graduated at Trinity College, Oxford, in 1838, taking a first class in classics; was elected a fellow of Exeter College in 1840, tutor in 1842, gained the Denyer Theological prize in 1842 and 1843, and subsequently received various high university appointments, including the Camden professorship of ancient history in 1862. From 1872 he was canon of Canterbury Cathedral, and was rector of All Hallows' Church, London, from 1888 until his death. His Bampton lectures in 1859 were published in the following year under the title of *Historic Evidence for the Truth of Christian Records*. His other works include a translation of *Herodotus* (1858-60) with notes and appendices, in which many of his brother's discoveries are incorporated; *The Five Great Monarchies of the Ancient World—Chaldea, Assyria, Babylonia, Media, and Persia* (1862); *Manual of Ancient History* (1869);

Historical Illustrations of the Old Testament (1870); the *Sixth Oriental Monarchy—Parthia* (1873); the *Seventh Oriental Monarchy—the Sassanians* (1875); *The Origin of Nations* (1877); *A History of Ancient Egypt* (1881); *A History of Phœnicia* (1889); *The Story of Parthia* (1893); and *A Memoir of Major-General Sir H. C. Rawlinson, Bt.* (1898).

RAWLINSON, SIR HENRY CRESWICKE (1810-95). An English soldier, diplomat, and Assyriologist. He was born at Chadlington, Oxfordshire, and after education at Wrington and Ealing, entered the military service of the East India Company in 1827, benefiting on the long Cape voyage to India by the company and counsels of the diplomat and Orientalist Sir John Malcolm. His facility in learning Hindustani and Persian made him interpreter at eighteen, and a year later he became paymaster of his regiment. In 1833, with other English officers, he was appointed to assist in the reorganization of the Persian Army. While stationed at Kermanshah in 1835, he began to study the Old Persian cuneiform inscriptions. The results of his research were submitted to the Royal Asiatic Society of London in 1837; in the same year his account of his travels through Susiana was printed in the *Journal* of the Royal Geographical Society, and the following year an account of a journey through Persian Kurdistan appeared. During the course of the Afghan troubles he left Persia to take up an appointment as political agent at Kandahar in 1840, and served throughout the campaign with distinction. He was appointed political agent in Turkish Arabia in 1843, consul at Bagdad in 1844, and in 1851 was promoted Consul-General. His official positions facilitated his archaeological researches, and in 1846 his successful decipherment of the Persian cuneiform inscriptions, especially that of Darius Hystaspis at Behistun, marked an epoch in the knowledge of Persia's history and ancient languages, and also prepared the way for the decipherment of the other cuneiform alphabets. Later successful work was accomplished in excavations in Babylonia for the trustees of the British Museum. He returned to England in 1855. In 1858 he was elected member of Parliament for Reigate, but the same year resigned on being appointed member of the Council of India. In 1859 he went to Teheran as Envoy Extraordinary and Minister Plenipotentiary to the Court of Persia. From 1865 to 1868 he again sat in Parliament as member for Frome. In 1871 he was elected president of the Royal Geographical Society. In 1875 his *England and Russia in the East*, created a considerable stir, owing to its revelations of the interior workings of Asiatic politics. Rawlinson received the honor of knighthood in 1891, and was a member of the Council of India until his death. His *Persian Cuneiform Inscriptions at Behistun* (1846-49), contained in the *Journal* of the Royal Asiatic Society, created an epoch in philology, and his *Cuneiform Inscriptions of Western Asia*, in collaboration with Pinches (5 vols., 1861-91), is almost equally important. He contributed largely to Farrier's *Caravan Journeys* (1856), and many of his discoveries are incorporated in *Herodotus* (1858) by his brother, Canon George Rawlinson (q.v.). Consult G. Rawlinson, *Memoir of Major-General Sir Henry Creswicke Rawlinson* (London, 1898).

RAYs AND SKATES

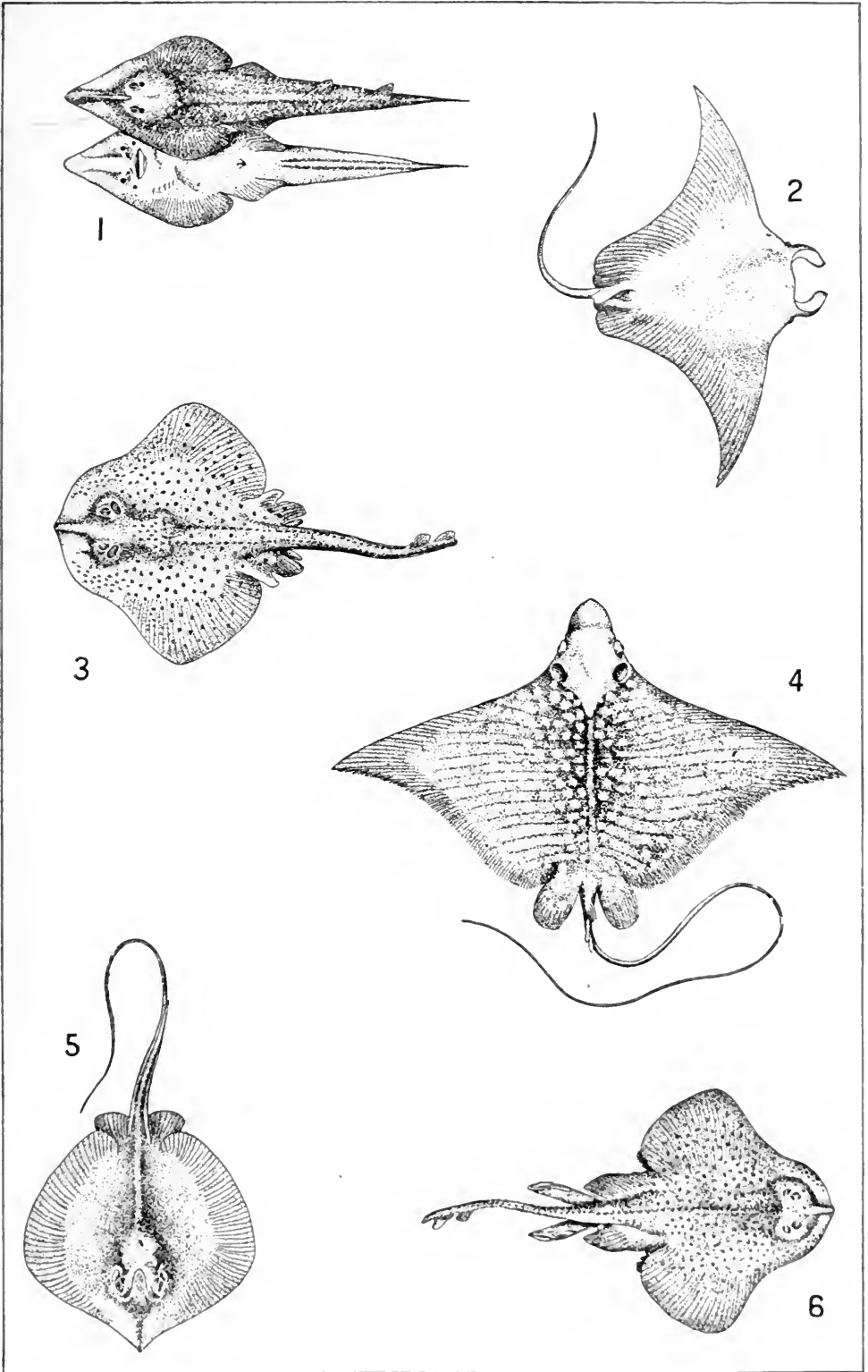

1. GUITAR-FISH (*Rhinochimaera lentiginosa*); upper and lower surfaces.

2. DEVIL-FISH (*Manta birostris*).

3. BIG SPOTTED SKATE (*Raja ocellata*).

4. SPOTTED STING-RAY (*Aetobatus narinari*).

5. FLORIDA STING-RAY (*Dasatis sabina*).

6. COMMON SKATE (*Raja erinacea*).

RAWLINSON, ROBERT (1810-98). An English civil and sanitary engineer, born in Bristol. He was first employed in work on docks and harbors, and then on the London and Birmingham Railway, under Robert Stephenson. Afterwards he worked in Liverpool, where he was assistant surveyor to the corporation, and Government inspector. In 1855 he was put at the head of the sanitary commission sent by England to the Crimea, and did much to lessen the terrible mortality among the soldiers. His works include: *Drainage of Towns* (1854); *Lectures on Sanitary Questions* (1876); and *Hygiene of Armies in the Field* (1883).

RAWMARSH. A town in the West Riding of Yorkshire, England, 2½ miles north of Rotherham (Map: England, E 3). It has collieries, foundries, machine works, and potteries. The municipality owns its gas and water works, electric lighting, street railways. Population, in 1901, 14,600.

RAWNS'LEY, HARDWICK DRUMMOND (1850—). An English clergyman and poet, born at Shiplake-on-Thames, September 28, 1850. After graduating from Balliol College, Oxford, he took orders in the English Church (1875), and became curate at the mission of Clifton College, Bristol, vicar of Wray at Windermere (1878-83), then vicar of Crosthwaite at Keswick and honorary canon of Carlisle. He published many volumes of verse, and among his prose works are: *Village Sermons* (two series, 1894 and 1897); *Life and Nature at the English Lakes* (1899); and *Memories of the Tennysons* (1900).

RAWSON, ALBERT LEIGHTON (1828—). An American author, traveler, and artist. He was born at Chester, Vt., and educated privately at Black River Academy, Ludlow, Vt. Always much interested in esoteric orders, he was adopted as brother by the Adwan Bedouins of Moab, initiated by the Druses on Mount Lebanon, and in America became one of the founders of the Order of Nobles of the Mystic Shrine, also a member of the Theosophical Society and the Society of the Rosy Cross. He has illustrated several books dealing with the East, among them *lives of Christ* by Beecher, Deems, and Crosby. He has published various translations from Oriental languages, a *Vocabulary of the Bedouin Language of Syria and Egypt* (1874), and a *Dictionary of Arabic, German, and English* (1876).

RAWTENSTALL, *ra'ten-stal*. A municipal borough in Lancashire, England, on the Irwell, 18 miles north of Manchester (Map: England, D 3). It is a busy manufacturing centre with woolen, cotton, and carpet manufactures, collieries, and stone quarries. Population, in 1891, 29,500; in 1901, 31,000.

RAY (OF. *raie*, *raye*, Fr. *raie*, from Lat; *raja*, ray, roach; connected with AS. *roche*, LGer. *ruche*, Ger. *Roche*, MDutch *roch*, OF. *roche*, *rosse*, Fr. *roche*, Eng. *roach*). A general name for the elasmobranch fishes of the order Batoidei, characterized by the dorso-ventrally flattened body. This order includes the saw-fishes, sea-devils, stingrays, skates, guitar-fishes, and torpedoes (qq.v.). The true rays have a flat body; the pectoral fins are large and fleshy, appearing as lateral expansions of the body, and along with it forming a circular disk or a rhomboid, to which is attached a rather long and slender tail. The pectoral fins are prolonged till they meet in

front of the snout, and backward till they join the ventral fins. The eyes and spiracles look upward. The gill-openings (five) are on the under side of the body, close behind the mouth; and toward the tail are the stomach, intestines, and other viscera. The males are furnished with claspers. Most of the species are egg-laying; but the guitar-fishes (*Rhinobatidae*) are peculiar in that their eggs are retained until they hatch within the body. The eggs are large and are inclosed in thin horny cases resembling those

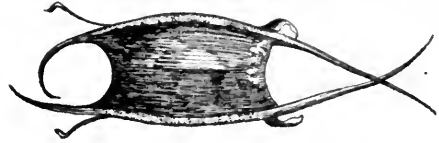

TYPE OF RAY'S EGG.

of sharks, but more rectangular in form, with projections at each of the four corners, by which they catch upon and are held to eel-grass or other supports until they hatch. These eggs are familiarly known in England as 'skate barrows,' and in America as 'mermaids' purses.' Rays are found in all seas, especially in the warmer ones, and commonly inhabit sandy or muddy shores, lying on the bottom, where they feed on mollusks and are often cast up on the beach.

The most common rays in the United States are those of the typical family Rajidae, usually called 'skates.' Those of the family Myliobatidae are called 'eagle-rays' (q.v.). A large section of the order is known as the suborder Masticura, or whip-tailed rays, in allusion to the very long slender tail, which in most species, especially of the family Dasyatidae, is armed, near its base, by one or more large jagged, erectile spines, capable of inflicting a severe and even dangerous wound. This has given to those fishes the name of stingray. The common stingray of the Atlantic shore is the 'clam-cracker' (*Dasyatis centroura*), which abounds from Maine to Cape Hatteras, and sometimes reaches a length of ten to twelve feet. The color is olive-brown above and nearly white below. Until half grown the young are smooth, but as they approach maturity broad conical bucklers appear on the back and tail, and many flattened tubercles. This tendency to grow rough with age characterizes most of these fishes, but is sometimes checked, as in the case of the smooth stingray or 'bat-fish' (*Myliobatis californicus*) of the Pacific Coast. Stingrays gather upon beds of cultivated oysters, or in places where clams abound, and destroy great numbers of these valuable mollusks. No trace of any poison glands has been found, but Kingsley says that the mucus of the fish probably possesses poisonous qualities.

Fossil selachians allied to the rays are represented by fragmentary remains from Devonian and Carboniferous rocks and by more perfect and abundant material in the Mesozoic and Tertiary deposits. Exquisitely preserved skeletons of *Rhinobatis* from the Jurassic lithographic stone of Bavaria present few differences from modern species of the same genus. Consult: Kingsley, *Standard Natural History* (Boston, 1885); Goode, *Fishery Industries*, sec. i. (Washington, 1884); Jordan and Evermann, *American Food and Game Fishes* (New York, 1902). See Plate of RAYS AND SKATES.

RAY, ISAAC (1807-81). An American physician, born at Beverly, Mass. He graduated in medicine at Bowdoin College in 1827, and in 1841 was appointed superintendent of the Augusta State Insane Asylum. He was superintendent of the Butler Hospital for the Insane at Providence, R. I., from 1845 to 1866, when he removed to Philadelphia, where he wrote extensively for periodicals. He was the author of *Conversations on Animal Economy* (1829); *Medical Jurisprudence of Insanity* (1838); *Education in Relation to the Health of the Brain* (1851); and *Mental Hygiene* (1863).

RAY, JOHN (1627-1705). An English naturalist. He was educated at Cambridge, where he became a fellow and took orders in the Church of England. He resigned his fellowship in 1662 and for a time lived with his friend Francis Willughby, with whom he afterwards traveled extensively in England and on the Continent, studying botany and zoölogy. Ray published the following important works on the classification of plants and animals: *Catalogus Plantarum Angliæ* (1670); *Ornithologia*, with Willughby (1676); *Methodus Plantarum Nova* (1682); *Historia Piscium*, with Willughby (1686); *Historia Plantarum* (1686-1704); *Synopsis Methodica Animalium, Quadrupedum, et Serpentina Generis Vulgarium* (1693); *Historia Insectorum* (posthumous, 1710). Ray's position in science is an important one, in that he was the first to attempt a classification of animals and plants which should express their natural relationships and he first introduced a workable definition of the term *species*. His work furnished the basis upon which Linnaeus and Cuvier have constructed the modern systems of classification. The Ray Society of London perpetuates his worthy fame.

RAYET, râ'yâ', OLIVER (1847-87). A French archaeologist, born in Cairou (Lot), and educated at the Normal College and in the French School at Athens (1869), whither he returned after the Franco-Prussian War. Soon afterwards the Rothschilds sent him with Albert Thomas to carry on excavations in Miletus. In 1884, having acted as maître de conférences in Greek epigraphy at the Ecole des Hautes Etudes, and as suppléant in various chairs of archaeology, he became professor of archaeology at the Bibliothèque Nationale. The *Monuments de l'art antique* (1884 sqq.) was begun under his editorial charge. His other works were mostly in periodicals, but in 1888 were published a *Histoire de la céramique grecque*, edited by Max Collignon, and a series of essays, *Etudes d'archéologie et d'art*.

RAYLEIGH, râ'li, JOHN WILLIAM STRUTT, third Baron (1842—). A distinguished physicist. He was educated at Trinity College, Cambridge, graduated in 1865, as senior wrangler in the mathematical tripos, and became a fellow of the college in 1866. He succeeded to the title of baron in 1873. He was professor of experimental physics in the University of Cambridge during 1879-84, and professor of natural philosophy in the Royal Institution of London since 1887. He has been a fellow of the Royal Society since 1873, vice-president of the British Association (section A) since 1882, member of numerous other scientific societies, including the United States National Academy of Sciences, and a correspondent of the Institute of France. Since 1896 he has been the

scientific adviser to Trinity House, the British Lighthouse Board. In 1894 he discovered, in conjunction with Professor Ramsay, a new element, present in the atmosphere, which he has since prepared in quantity and has named argon. For this discovery he received from Columbia College, on recommendation of the National Academy of Sciences, the Barnard medal 'for meritorius service to science.' Lord Rayleigh ranks as one of the greatest living physicists. His experimental work has been largely in the field of electrical standards and in physical optics; but he has carried on important researches in nearly every branch of physics, especially in acoustics, where his investigations are of the greatest value. His work is characterized by extreme care and accuracy, and the use of the most simple apparatus, often home-made. He is the author of many valuable papers in the *Philosophical Magazine*, *Philosophical Transactions*, *The Theory of Sound* (2 vols., 1877-78 and 1894), and has edited J. Clerk Maxwell's *Heat*. His collected papers have been published in four volumes (London, 1899-1903).

RAYMOND VI. Count of Toulouse. See TOULOUSE.

RAYMOND, ANDREW VAN VRANKEN (1854—). An American clergyman and educator, born at Vischer's Ferry, N. Y. He graduated at Union College in 1875 and the New Brunswick Theological Seminary in 1878. He held pastorates at Paterson in 1878-81, at Plainfield in 1881-87, and at Albany in 1887-94, when he was made president of Union College.

RAYMOND, BRADFORD PAUL (1846—). An American educator, born near Stamford, Conn. He served through the last year of the Civil War, and in 1866 entered Hamline University, Red Wing, Minn. On its suspension in 1869, for lack of funds, Raymond hired the college buildings and conducted the institution to the close of the year. Having completed his academic course at Lawrence University, Appleton, Wis., he studied theology at Boston University, and philosophy at Leipzig and at Göttingen. After a short pastorate at Nashua, N. H., he became president of Lawrence University in 1883, and of Wesleyan University in 1889.

RAYMOND, HENRY JARVIS (1820-69). An American journalist and politician, born at Lima, Livingston County, N. Y. He graduated at the University of Vermont in 1840, and removed to New York City, where he studied law, and contributed to the *New Yorker*. When, in 1841, Greeley founded the *Tribune*, Raymond became associated with him as assistant editor. In 1848 he left the *Tribune*, and took an editorial position on the *Courier and Enquirer*, becoming at the same time associated with the publishing house of Harpers as a literary adviser. In 1851 he founded the *New York Times*, the first number of which appeared on September 18th of that year. He was a strong anti-slavery Whig, and after serving in the State Assembly, in 1854 he was elected Lieutenant-Governor of the State. In 1856 he became one of the most active and influential leaders of the new Republican Party in New York, was a member of its first national convention and drafted the famous *Address to the People*. In 1861 he was again elected to the State Assembly and chosen Speaker. In 1864 he was elected to Congress. After Lin-

coln's death he took the position that the Southern States had never actually been out of the Union and gave his partial support to Johnson's plan of reconstruction. In 1866 he left the Republican Party, was one of the promoters of the National Union (Loyalists') convention at Philadelphia, and wrote the *Address and Declaration of Principles* adopted by it. Raymond was the author of *A Life of Daniel Webster* (1853); *Political Lessons of the Revolution* (1854); *Letters to Mr. Yancey* (1860); and *A History of the Administration of President Lincoln* (1864), enlarged and republished in 1865 as *The Life and Public Services of Abraham Lincoln*. Consult *Maverick, Henry J. Raymond and the New York Press for Thirty Years* (Hartford, 1870).

RAYMOND, JOHN HOWARD (1814-78). An American educator, born in New York City. He graduated at Union College in 1832; studied law at New Haven, and in 1834 entered the theological seminary (now Colgate University) at Hamilton, N. Y. In 1839 he became professor of rhetoric and belles-lettres at Madison University, and in 1850 professor of belles-lettres at Rochester University. He organized the Brooklyn Collegiate and Polytechnic Institute in 1856, and from 1865 until his death was president of Vassar College and professor of mental and moral philosophy there. Consult *The Life and Letters of John H. Raymond* (New York, 1880).

RAYMOND, JOHN T. (1836-87). An American comedian, whose real name was O'Brien. He was born in Buffalo, N. Y. In 1858 he made his early success with *Sothern in Our American Cousin*, in which he afterwards appeared in London and in Paris. His greatest popular 'hit,' however, was as Colonel Mulberry Sellers in a dramatization of Mark Twain's *Gilded Age* (1873), a character that became completely identified with his own breezy optimism. Consult: McKay and Wingate, *Famous American Actors of To-Day* (New York, 1896); Matthews and Hutton, *Actors and Actresses of Great Britain and the United States* (New York, 1886).

RAYMOND, ROSSITER WORTHINGTON (1840-). An American mining engineer and metallurgist, born in Cincinnati, Ohio. He graduated at the Brooklyn Polytechnic Institute in 1858, and after spending three years in study at Heidelberg, Munich, and Freiberg, he entered the Federal Army as additional aide-de-camp with the rank of captain. In 1864 he began practice in New York as a consulting engineer, but in 1868 became United States Commissioner of Mining Statistics, a position which he held until 1876. After 1867 he was connected with mining journals, and from 1870 until 1882 he was lecturer in Lafayette College on economic geology. He published annual reports of mining statistics, 1869-76; *Peter Cooper* (1901); and several other works.

RAYMOND OF PEÑAFORTE, pá'nyá-fór'tá (c.1180-1275). A Spanish theologian, born at the Castle of Peñaforte, in Catalonia, and educated at Barcelona and Bologna. On his return to Spain he became canon of Barcelona (1219), then archdeacon, and in 1222 a member of the Dominican Order, of which he was made General in 1238. In 1230 he was appointed by Gregory IX. to codify the canon law. His *Decretalia* form the fifth volume of the present canon law,

and his *Summa de Pœnitentia* (printed in 1603) make a compendium of ecclesiastical jurisprudence. Raymond became Archbishop of Tarragona in 1235, and was prominent in the work of the Inquisition in France and Spain, and in preaching crusades against the Moors. He was canonized in 1601, and January 23d was made his day. Consult *Danzas, Raymond de Pennafort* (Poitiers, 1885).

RAYMOND OF SABUNDE, sá-bōōn'dá (?-1437). A Spanish theologian. He was born in Barcelona, taught theology, philosophy, and medicine at Toulouse (1430-32), and died as rector of the university there. His fame rests upon his natural theology, which he wrote in Spanish, but which appeared in a Latin translation after his death, and has been widely circulated (latest edition, Sulzbach, 1852). Montaigne translated it into French (Paris, 1569; latest edition, 1605). This famous book employs the expression now so familiar that there are two books by which the truth can be known: the book of Nature and the book of Revelation. The essential contents of these two books are the same. The difference is that in the latter truth is given dogmatically in the shape of precept, whereas in the former truth is arrived at by means of investigation and ratiocination. He even endeavors to demonstrate that the book of Nature contains evidence of the divine mysteries of Christianity. His assertion in his prologue that although reason unaided by revelation could not discover these mysteries, yet, given these mysteries, reason was competent to explain them, caused this prologue to be put upon the index by the Council of Trent, and so it is not given in the edition of 1852. He was a mystic of the school of Raymond Lully. Consult: Matzke, *Die natürliche Theologie des Raymundus von Sabunde* (Breslau, 1846); Huttler, *Die Religionsphilosophie des Raymundus von Sabunde* (Augsburg, 1851); Kleiber, *De Raymundi Vita et Scriptis* (Berlin, 1856).

RAYNAL, rá'nál'. GUILLAUME THOMAS FRANÇOIS (1713-96). A French author. He was born at Saint-Geniez, and was educated for the priesthood with the Jesuits of Péczenas. In 1747 he went to Paris, and was attached to the Church of Saint Sulpice. His peculiarities soon led him out of the Church, and he became one of the editors of the *Mercur de France*, where his philosophic mind found associates and scope, and his taste for history made him an historian. His works, though not now of high value, were conspicuous in their time, when philosophy and literary independence were novelties. Among them was *Histoire philosophique et politique des établissements et du commerce des Européens dans les deux Indes* (1770), which contained writings of Diderot as well as Raynal, and fell under the condemnation of the Parliament in 1781. His *Révolution d'Amérique* appeared in an English translation in London (1781), and was severely criticised by Thomas Paine.

RAYNOUARD, rá'nōō'ar', FRANÇOIS JUSTE MARIE (1761-1836). A French philologist and poet, born at Brignoles, September 18, 1761. He studied at Aix, became advocate, entered politics as a Girondin Deputy (1791), was imprisoned during the Terror, achieved reputation as a dramatist and poet; was elected to the Academy (1807), and became its perpetual secre-

tary (1817). After the fall of the Empire he distinguished himself by linguistic researches, especially in Provençal. His theories, though often false, stimulated the progress of Romance philology. (See ROMANCE LANGUAGES.) Note-worthy are his poem *Socrate dans le temple d'Aglaure* (1803), the tragedy *Les templiers* (1805), his anthology of Troubadour poetry (1816-21), and a Troubadour Lexicon (*Lexique roman*, 1838-44). His linguistic theories are embodied in the *Recherches sur l'ancienneté de la langue romane* (1816), and the *Grammaire comparée* (1821).

RAZIN, rä'zén, STENKO (?-1671). A Russian rebel, born in Teherkask. In 1667 he was elected leader of the rebellious Cossacks, and, after plundering the caravans and fisheries along the Volga and meeting defeat in Persia (1668), he attacked Russia. Pardonned once by Alexis, he rebelled again. Joined by dissatisfied elements, Razin was at first successful, captured many cities, and ruled along the Volga as far as Nizhni Novgorod. Then he was several times defeated, and in 1671 was executed at Moscow. He was a hero of the popular *bilini*, and Kostomaroff made him the subject of an historical monograph (Saint Petersburg, 1859).

RAZORBACK. A whale, the finback (q.v.). Also, a name in the United States for a semi-wild hog, common in the Southern States.

RAZORBILL, or RAZOR-BILLED AUK. An auk (*Alca torda*), very common on the coasts of the North Atlantic, frequenting lofty precipices, from which its eggs are taken, with those of guillemots, by persons who are let down by ropes. The eggs are esteemed a delicacy, and the flesh of the bird itself is much used for food. The razorbill is about 17 inches long, and takes its name

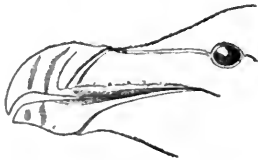

BILL OF RAZORBILL.

from its sharp-edged, puffin-like beak. The anterior parts, back, wings, and tail, are black, the breast and belly white. It is a very fierce bird, and, if seized, will lay hold of the hand in return. The egg is about three inches long, bluish-white or buffy, heavily spotted with brown. Great numbers of razorbills, are annually killed for the sake of their feathers, particularly on the coast of Labrador, where they are extremely abundant. See AUK.

RAZOR-CLAM. An edible bivalved mollusk of the family Solenidae, whose elongated shell, gaping at each end, suggests the handle of a razor. (See Colored Plate of CLAMS.) The species are numerous, and inhabit the sands of all shores except in the coldest parts of the world. The common species of the eastern coast of the United States is *Ensatella Americana*, which is an inhabitant of sand flats and bars where the water is pure. They live in holes which run down vertically, two or three feet, and into which they retreat when alarmed. It is useless to attempt to dig them out, as they burrow so rapidly that they are soon beyond the reach of the spade. This species is five or six inches long, about an inch broad, and handsomely colored.

RÊ, rä (less correctly RA). The name by which the sun-god was most generally known in

ancient Egypt. According to the Egyptian myths, Rê appeared upon the surface of the primeval ocean and, overcoming the powers of darkness, brought order out of chaos, and assumed the government of the world. He reigned for a long period, but finally grew old, the gods became unruly, and the great goddess Isis, who was profoundly versed in magical lore, took advantage of his failing strength to wrest from him by a stratagem his secret name, the source of his power. Even men rebelled against him, and in his anger he sent down the goddess Hathor to destroy them, but he relented at the sight of the terrible slaughter and turned the goddess from her purpose. Wearing at length with the struggle, Rê gave up the government of the world and retired to rest in heaven upon the back of the celestial cow. With the spread of the solar religion throughout Egypt, Rê was identified with a number of local deities who were regarded as special manifestations or phases of the same god. Horus of Edfu, for example, was the morning sun rising upon the horizon or the sun of spring coming forth in renewed activity after gloom of winter. Tum or Atum of Heliopolis, the great centre of solar worship, was the sun setting in the west, and Osiris represented the same phase. The identification was gradually extended to divinities like Ammon of Thebes and Min of Koptos, who originally possessed no solar character whatever, and in course of time nearly every divinity in the Egyptian pantheon came to be identified with Rê. Amenophis IV., of the Eighteenth Dynasty, carrying this theological tendency to its logical conclusion, endeavored to establish a species of monotheism based upon the worship of Rê, under the new name of Aten or the solar disk, as the universal source of life, but the reformed religion died with its founder. Rê is usually represented as a hawk-headed man holding in one hand the symbol of life and in the other the royal sceptre. Upon his head is the solar disk in the coil of the uræus serpent. In the Book of the Dead (q.v.) the god is conceived as sailing through the heavens during the day in his bark, giving light to the world, and as continuing his voyage at night through the lower world, to rise again the following day. As he advances, his brilliant rays overwhelm the fiends who would impede his progress. The Egyptian Pharaohs were believed to be the direct descendants of the god, and from the time of the Fifth Dynasty the title 'Son of Rê' formed an essential part of the royal titulary. Consult: Erman, *Life in Ancient Egypt* (London, 1894); Wiedemann, *Religion of the Ancient Egyptians* (New York, 1897). See also EGYPT, section on the religion of ancient Egypt.

RÊ, rä, ÎLE DE. A small island on the coast of the French Department of Charente-Inférieure, opposite the city of La Rochelle, from which it is separated by the Pertuis Breton (Map: France, E 5). It is about 16 miles long and 3 miles broad, and consists mainly of sand dunes, with cliffs on the southeast coast, where there are several forts. Saint-Martin, the capital of Rê, is a well-fortified little town, with a good harbor and trade. The chief occupations of the inhabitants, who in 1901 numbered 14,232, are fishery, oyster-farming, viticulture, and the manufacture of salt. In 1627, while the Huguenot stronghold of La Rochelle was besieged by

the forces of Louis XIII., the English, under the Duke of Buckingham, made a powerful but unsuccessful expedition against the island.

REACTION. In psychology, a term used to denote response to sensory stimuli. In experimentation this response takes the form of physical action, and as the stimulus applied is also physical, the time between the giving of the stimulus and the response may be readily measured by means of electrical appliances and delicately adjusted clocks. This time is called the reaction time, and includes physical, physiological, and psychical factors in the process measured. Reaction time is found to vary much both with individuals and with practice, and since the physical and physiological processes may be assumed or shown to be fairly constant, it affords a fair test of variation in the times of mental processes.

Simple reaction time may be determined in many ways. Let us suppose that a clock, recording accurately to the $\frac{1}{10000}$ second, is connected electrically with a hammer and an electric key. The connections are so arranged that the hands of the clock begin to move when the hammer falls upon its block. The sound thus made serves as stimulus to the reactor, who presses the button of the electric key as soon as he has heard it; the pressing of the button stops the clock hands, and the time of reaction (the time elapsing between the giving of the simple stimulus and the execution of the simple movement made in response to it) is thus registered in thousandths of a second. Very many observations have been made, with auditory, visual, and tactual stimuli, so that the norms of reaction are now well established. The simple reaction time is, evidently, the time required for the purely physiological process of conduction of excitation from sense-organ to brain; for the psychophysical process of sensation and impulse; and for the purely physiological process of conduction of excitation from brain to hand. If we know the rate of conduction in sensory and motor nerves, we can, by subtraction, determine the time required for the central or psychophysical process alone.

The simple reaction time varies largely with direction of the attention. There are three possibilities. The reactor may seek to distribute his attention, to attend both to the coming stimulus and to the movement of reaction; or he may attend predominantly (almost exclusively) to the sensory stimulus, or again to the movement. So we have three norms of reaction time: the central or natural time, the sensorial or complete time, and the muscular or abbreviated time. The natural time of an untrained subject will differ, according as he is disposed by his mental constitution to attend mainly to his own movement or to the stimulus presented to him; but it will, in every case, lie somewhere between the two extreme times. The norms for these (in thousandths of a second), as determined with practiced subjects, are:

	Sensorial	Muscular
Sight.....	270	180
Sound.....	230	120
Touch.....	210	110

The times differ, that is, with differences of sense-organ appealed to; and the average differ-

ence between the two times for the same sense department is $\frac{1}{10}$ second.

The simple reaction experiment presents two aspects, a qualitative and a quantitative. Regarded in the first aspect, the reaction is the exact type of a voluntary action; it is an impulsive action reduced, by laboratory devices, to its lowest terms; it differs from the impulsive actions of real life only by greater simplicity of motive (stimulus) and greater simplicity of responsive movement. We may therefore make it the basis of an introspective examination of action at large—in which case the time-values have merely a regulative importance, as an external check or control upon the validity of introspection. Regarded in its second aspect, the reaction measures the duration of a certain complex mental process. If, then, we vary this process in known ways, the consequent variation of the reaction times gives us a similar measure of other mental processes.

(1) Under the first heading we note that the course of the simple reaction may be qualitatively changed in various ways. The subject may be required to react to stimuli of different quality (e.g. tones, colors); to stimuli of different intensity (e.g. weak and strong pressures); to stimuli of varying intensity or quality (e.g. irregular alternation of loud and weak noises); under distraction; and without preadjustment of attention, i.e. without any signal that the experiment is about to begin. Further, the complex types of action may be studied. (See ACTION.) The subject may react to one of two or more known stimuli; he is told, perhaps, that either black or white will be shown, and that he is not to move until he has 'made sure' of the nature of the impression (discrimination reaction). Or he may be left in the dark, save in a general way, as to the nature of the stimulus: he is to react to a visual impression, and not to move until he has made sure of it, but the impression may be black, white, gray, or a color (cognition reaction). Again, he may be told that either black or white is to be shown, and that he is to respond to black by a right-hand and to white by a left-hand movement. Here we have the conflict of impulses characteristic of selective action. Once more, he may be told to respond to black, but not to answer at all if white is shown: here we have the conflict between impulse, on the one hand, and a group of ideas which do not prompt to movement, on the other, that is characteristic of volitional action. Selective and volitional actions may also be put together on the basis of the cognition reaction.

(2) Under the second heading we note, first, that an association may be interpolated into the course of the reaction. The reactor is shown a color; he is not to move until he has associated some idea to the color. The time of the association reaction *minus* the time of the simple reaction to the same stimulus gives us a rough measure of the duration of association. It averages three-quarters of a second. Secondly, we find that the cognition of intensities takes a longer time than that of qualities. This accords with the fact that quality is the absolute, and intensity a relative attribute of sensation. Thirdly, the reaction time to tonal fusions lasts longer, the higher the fusion degree: we cognize a minor third more quickly than we cognize a major third. Finally, the reaction method en-

ables us to trace the course of habituation, fatigue (q.v.), expectation, and practice (q.v.).

BIBLIOGRAPHY. Sanford, *American Journal of Psychology*, ii. (Worcester, 1888-89); Lange, *Philosophische Studien*, iv. (Leipzig, 1888); Wundt, *Physiologische Psychologie* (ib., 1893); Jastrow, *The Time Relations of Mental Phenomena* (New York, 1886); Külpe, *Outlines* (London, 1895); Titchener, *Outline* (New York, 1899); id., *Experimental Psychology* (ib., 1901); Flournoy, *Observations sur quelques types de réaction simple* (Geneva, 1896); Stern, *Ueber Psychologie der individuellen Differenzen* (Leipzig, 1900). See PSYCHOLOGICAL APPARATUS.

REACTION (in medicine). A special vital movement tending to overcome some noxious action or influence affecting the organism. The term is also applied to an effect produced by the application of a stimulus to a nerve or muscle. In surgery the term has a special significance, and is used to indicate the process of recovery from a state of collapse. Collapse, reaction, and the general effects of shock upon the system are considered under SHOCK.

REACTION, CHEMICAL. A term applied to the transformations of substances into other substances having more or less different properties. (See CHEMISTRY.) It is noteworthy that the mutual transformations of the allotropic modifications of one and the same element must be considered as chemical reactions. Thus, the transformation of yellow phosphorus into red phosphorus is a chemical reaction. In essence the two substances are identical; but they nevertheless differ in their chemical behavior, and under the same physical conditions they possess different physical properties; so they must be considered as two distinct chemical individuals and their transformation into each other must be considered as a chemical reaction.

The general laws according to which chemical reactions take place include the law of the conservation of matter, the law of the conservation of the elements, the law of definite combining masses, the law of combining volumes, the law of mass action, and, of course, the law of the conservation of energy. The conservation of energy plays an important part in thermo-chemistry and electro-chemistry (q.v.). The other laws, with the exception of that of mass action, have been considered in the general article CHEMISTRY (q.v.). In the present article it remains to discuss briefly the action of masses.

At first consideration the concept of mass action appears to contradict the law of definite proportions. According to the latter, while substances may be mixed in any proportion whatever, chemical combination only takes place between definite relative quantities. Thus, oxygen combines directly with hydrogen only in the proportion of eight parts (by weight) of the former to one of the latter, whether a given mixture in which the reaction is caused to take place contains the two gases in this or in any other proportion. What, then, can the masses of the reacting substances have to do with the course of the reaction? A simple example may serve to illustrate the point in question. Ordinary alcohol and acetic acid combine in the proportion of 46 parts of the former to 60 parts of the latter. If 46 grams of the alcohol should be left in contact with 60 grams of the acid for a sufficiently long time, 30.7 grams

of the alcohol would combine with 40 grams of the acid ($30.7 : 40 = 46 : 60$), yielding 58.7 grams of ethyl acetic ester and 12 grams of water. The rest of the alcohol (15.3 grams) and of the acid (20 grams) would remain uncombined, side by side with the ethyl acetic ester and water, no matter how long the mixture were kept (in one experiment the mixture was actually kept for seventeen years). Now, if instead of 46 grams a larger quantity of alcohol were left in contact with 60 grams of acetic acid, more of the latter would ultimately be found to have entered into combination, and consequently less than 20 grams of it would ultimately remain free. But the proportion of alcohol and acid combined would still be 46 parts of the former to 60 parts of the latter. This example illustrates the following principles: (1) Whatever the proportion of the reacting substances present, chemical combination takes place between the same relative quantities; (2) whatever the proportion of the reacting substances present, the possible maximum of each may not enter into combination, a fraction of the several substances present refusing to combine at all, as long as they remain in contact with the products of the reaction; (3) the amounts of the substances present determine the fraction that will enter into combination and the fraction that will remain free. The first of these principles is nothing else than the law of definite proportions. On the other hand, the doctrine of mass action has reference to the second and third of these principles, dealing, not with the relative combining quantities, but with the extent to which combination takes place.

A fact of the greatest importance for the theory of chemical transformations is that the course of many reactions can be reversed. For instance, we just said that ordinary alcohol and acetic acid partly combine to form ethyl acetic ester and water. But ethyl acetic ester and water, if allowed to remain mixed for a sufficient length of time, will react and produce free acetic acid and alcohol. In this transformation again the ester and water would partly react (in accordance with the law of definite proportions) and partly remain unchanged. Quantitative experiment would reveal the following facts: (1) If we should mix 88 grams of the ester with 18 grams of water (88 and 18 are, respectively, the reacting weights of the two substances), then $29\frac{1}{3}$ grams of the former and 6 grams of the latter would react to form 20 grams of free acetic acid and $15\frac{1}{3}$ grams of alcohol, while the remaining $58\frac{2}{3}$ grams of the ester and 12 grams of water would refuse to enter into reaction; (2) if after all change has ceased in our mixture, we should add to it a further quantity of either ester or water, then a further (but not complete) decomposition of ester into alcohol and acid would take place; (3) if, on the contrary, after all change has ceased in our mixture, we should add to it, not ester or water, but either free acetic acid or alcohol, a further change would take place, resulting in the formation of more ester and water. It would thus become clear that in a mixture of reacting substances with the products of their reaction, when the mixture is in a state of 'chemical equilibrium,' we may cause a reaction to take place either in one direction or in the opposite direction, by changing the relative masses of the ingredients. In other words, the masses of

substances may determine the course of a chemical reaction. The importance of this statement in chemical theory will be so much the more obvious if we consider that there is good reason for assuming that *all* reactions are reversible. Says Nernst: "It has been formerly often maintained that 'reversible reactions' are exceptional, or that two different classes of reactions must be distinguished, reversible and non-reversible. But no such definite line of demarkation exists by any means, and there is no doubt that under appropriate experimental conditions it will be possible to cause any reaction whatever to take place now in one, now in the opposite direction; that is to say, *in principle every reaction is reversible.*"

But what, then, becomes of the old notion of chemical affinity? According to that notion, a chemical change takes place solely because the components of a given substance have a greater affinity for the components of another substance than for one another: two compounds AB and CD react and yield AC and BD solely because the affinities between A and C, B and D, are greater than the affinities between A and B, C and D. If this notion were correct, the opposite reaction, viz. the transformation of AC and BD into AB and CD, would evidently be impossible. But many reversible reactions are known as a matter of fact. Therefore the old notion of chemical affinity as the sole cause of reactions must be either discarded or essentially modified. A careful study of facts leads to the following conclusion: The course of reactions and the final equilibrium to which that course leads are certainly influenced by the chemical affinities (whatever may be their ultimate nature); but those affinities are not alone in determining the chemical phenomena which they influence. In studying reversible reactions it is found that the action of masses comes in as a factor in all cases, without an exception. But it is also found that if chemically equivalent masses are started with in all cases, the fractions of those masses actually entering into reaction and the fractions remaining unchanged vary from case to case. In other words, as just stated, the equilibrium finally attained depends both on the nature of the reacting substances and on the masses present to start with. Still another factor takes part in influencing the course and end of reactions, viz. the temperature. Or, more exactly, the specific affinity factor at work in each case varies with the temperature. But this variation will be considered under THERMO-CHEMISTRY, and may be left out of account in the present discussion, in which all reactions are assumed to take place at constant temperature.

We have seen above that the total fraction found transformed when a reaction is over depends, among other things, on the masses present at its beginning. Similarly, it may be demonstrated by facts that the fraction transformed in a given interval of time *during* the reaction depends on the masses present at the beginning of that interval. And since the reaction itself obviously changes the masses present, part of the original substances gradually disappearing as such and masses of the products of the reaction gradually appearing in their stead, it is evident that the magnitude of the fraction transformed in unit of time varies from instant to instant. Were this not so, the 'velocity' of

a chemical reaction might be defined in terms of the amounts found transformed in any finite interval of time. But since, as just explained, the velocity is variable, it can be defined only in terms of the infinitely small amounts transformed in infinitely short intervals of time. (If this does not seem clear, see the article CALCULUS.) It may, however, be asked: But why consider at all the velocity of reactions? The answer is, Because it is the velocity that is immediately determined by affinity and mass action; and so, conversely, it is by measuring the velocity that affinity and mass action can be studied quantitatively. In the case of a reversible reaction, the direction of the change is the direction in which the velocity of reaction is the greater; the amount actually found transformed in any time depends on the difference between the velocities with which the two opposite reactions take place; and when the two velocities are equal, there is equilibrium. Thus the velocities of a reaction describe its course completely.

The development of the principles discussed in the preceding paragraphs forms the object of chemical kinetics and statics, the two subdivisions of the modern 'doctrine of affinity.' Chemical kinetics deals with chemical change; chemical statics with chemical equilibrium. At the basis of both is the law of mass action in its precise mathematical form, which may now be considered as established beyond the slightest possibility of doubt. For it has been demonstrated in three different ways: (1) by mathematical deduction from the kinetic theory of gases; (2) by mathematical deduction from the laws of thermodynamics; and (3) by extensive experimental observation. Correctly, but vaguely, the action of masses was first understood by the Frenchman Berthollet, in the beginning of the nineteenth century. In 1867 Guldberg and Waage, two Norwegian investigators, published a work (*Etudes sur les affinités chimiques*) in which the principles of chemical statics and kinetics were first stated and demonstrated in their rigidly mathematical form. But this work remained unknown for a number of years. Meanwhile Van't Hoff discovered the law of mass action independently in 1877; and from this date may be said to commence a new epoch in theoretical chemistry. The principal names connected with the demonstration and mathematical and experimental development of the law are, besides those of Guldberg and Waage, the names of Van't Hoff, Horstmann, Gibbs, Arrhenius, and Ostwald.

For further information, consult the works on theoretical and physical chemistry recommended in the article CHEMISTRY. See also ACIDS; DECOMPOSITION; DISSOCIATION; ELECTRO-CHEMISTRY; ESTERS; SOLUTION; THERMO-CHEMISTRY.

READ, CHARLES (1819-98). A French scholar, born in Paris, where he studied law, and served first in the magistracy and then in the administration, in the department of religious education (1852-58), and in that of historical documents (1865-70). In 1852 he founded the French Protestant Historical Society. His own labors preliminary to a history of the Reformation in France, which he did not complete, were mostly editorial, and include editions of Chamier's journal (1859), of Agrippa d'Aubigne's *Tragiques* (1872), and of his *Enfer* (1873) and

Printemps (1874), and of *Hotman's Tigre* (1875).

READ, GEORGE (1733-98). An American patriot, one of the signers of the Declaration of Independence. He was born in Cecil County, Md., received an academic education at Chester, Pa., studied law, and in 1752 was admitted to the bar in Philadelphia. Two years later he established himself in practice in Newcastle, Del. From 1763 to 1774 he was Attorney-General for the Crown for the counties of Kent, Delaware, and Sussex. In 1774 he was elected to the first Continental Congress. He was conservative, and at first stoutly opposed the idea of independence, but finally became convinced that independence was the only course, and affixed his signature both to the petition to King George and to the Declaration. Thenceforward he was enthusiastic in his support of the colonial cause, and as chairman of the first Naval Committee (1775-77) was largely instrumental in the establishment of the first American Navy. In 1776 he framed the new Constitution of Delaware, presided over the convention which adopted it, and became Vice-President and acting President (Governor) of the new State. He codified the Delaware laws, and in 1782 became a judge of the United States Court of Appeals for Admiralty Cases. He was a delegate to the Annapolis Convention of 1786 and to the Constitutional Convention in the following year. He was elected United States Senator in 1789 and again in 1791, but resigned in 1793 to become Chief Justice of Delaware, which post he continued to hold until his death. Consult W. T. Read, *Life and Correspondence of George Read* (Philadelphia, 1870).

READ, JOHN MEREDITH, JR. (1837-96). An American diplomat and writer. He was born in Philadelphia, graduated at Brown University in 1858, and at the Albany Law School in 1859, and was admitted to the bar. From 1860 to 1866 he was Adjutant-General of New York State, and was an active political organizer. Three years later he was appointed the first United States Consul-General to France and Algeria, where he organized the American consular service, and where, during the Franco-German War, he acted as Consul-General for the German States. In 1873 he was transferred to Greece as United States Minister to that country; and there he displayed such skill and energy, especially during the critical period which followed Russia's defeat of Turkey in 1878, that he earned the thanks of his Government. In 1879 he resigned and aided Greece in securing the territory which had been ceded to her by Turkey. His later years he spent mostly in Paris, engaged in study and research. He was a member of several societies and published a number of works, including *Military Reports and Suggestions* (1861); *Historical Inquiry Concerning Henry Hudson* (1864-66); *Charles Reade at Home* (1873); *The English Ancestry of Washington* (1894); and *Historic Studies in Vaud, Berne, and Saroy, from Roman Times to Voltaire, Rousseau, and Gibbon* (1897?).

READ, NATHAN (1759-1849). An American inventor. He was born in Warren, Mass., graduated at Harvard in 1781, and was tutor there from 1783 to 1787. In 1788 he conceived the idea of utilizing the steam engine for propelling boats and carriages, and, with that end in view,

began a series of experiments which resulted in the invention (1789) of the vertical multitubular fire-box boiler (patented August 26, 1791) now in general use. In 1796 he established the Salem Iron Foundry for the manufacture of anchors and chain cables, and in 1798 patented a machine for cutting and heading nails at one operation. He was a member of Congress from 1800 to 1803, and in 1807 removed to the vicinity of Belfast, Me., where he was for some years Chief Justice of the Court of Common Pleas. Among his inventions were: a pumping engine, a threshing machine, a method for equalizing the action of windmills, and a plan for utilizing the force of the tide, by means of reservoirs. Consult *Nathan Read: His Invention of the Multitubular Boiler and Portable High-Pressure Engine* (New York, 1870), by his nephew, David Read.

READ, OPIE PERCIVAL (1852-). An American author and editor, born in Nashville, Tenn. He edited the *Kansas Gazette* from 1878 until 1881. In 1883 he established the *Arkansas Traveller*, of which he was editor until 1893. His works include: *A Kentucky Colonel* (1889); *Emmett Bonlore* (1893); *A Tennessee Judge* (1893); *My Young Master* (1896); *Bolonyo* (1897); *The Wives of the Prophet* (1894); *In the Alamo* (1901); and several plays.

READ, THOMAS BUCHANAN (1822-72). An American poet and artist, born in Chester County, Pa., March 12, 1822. Apprenticed to a tailor, he ran away, learned cigarmaking in Philadelphia, sign painting in Cincinnati, other trades in other cities, published newspaper verse in Boston (1843), and for the rest of his life gave himself up to painting, visiting Europe several times, and finally residing in Rome. He achieved fair success in this art and somewhat in sculpture, but he is best known as a poet, especially for his stirring *Sheridan's Ride*, and his charming stanzas entitled *Drifting*. His first volume, *Poems*, appeared in 1847. *Lays and Ballads* followed the next year; *The New Pastoral*, an elaborate description of Pennsylvania life (1854); *The House by the Sea* (1856); and several other volumes attest his energy. In 1848 he compiled a volume entitled *Female Poets of America*, which was illustrated by engravings of portraits painted by himself. He also wrote a prose romance, and was conspicuous in his generation for versatility of talents, which, if concentrated, might have won him permanent fame. He died in New York City, May 11, 1872. Consult his *Poetical Works* (Philadelphia, 1865 and 1867).

READE, CHARLES (1814-84). An English novelist and playwright, born at Ipsden House, in Oxfordshire, June 8, 1814. He entered Magdalen College, Oxford, graduating A.B. in 1835 and M.A. in 1838; was elected lay fellow of his college (1835); made dean of arts at Magdalen (1845), and vice-president (1851); in the meantime had studied at Lincoln's Inn, and was admitted to the bar (1843). Reade never married, but formed a platonic friendship with an actress named Laura Seymour. He passed several years at his rooms in Magdalen, made many tours abroad, but lived mostly in London. Combative by nature, he was engaged in numerous lawsuits. He died at Shepherd's Bush, April 11, 1884.

Reade began his literary career as a playwright, and to the end continued to write plays

either single-handed or with others. He had great facility in expanding a play into a novel or in reducing a novel to a play. In 1852 *Masks and Faces*, written with Tom Taylor, was brilliantly received at the Haymarket. Reade turned this play into the novel *Peg Woffington* (1853), which was soon followed by the delightful *Christie Johnstone* (1853), having as heroine a New-haven fisher lass. In 1856 appeared *It is Never Too Late to Mend*, exposing prison discipline in England and Australia. This 'novel with a purpose,' which created a sensation, was succeeded by *Hard Cash* (1863), dealing with the iniquities of insane asylums; *Griffith Gaunt* (1865), on the marriage problem; *Put Yourself in His Place* (1870), on the terrorism of trades unions; *A Terrible Temptation* (1871); and *A Woman Hater* (1877), advocating woman's rights. All these novels are powerfully written. By itself stands Reade's masterpiece, *The Cloister and the Hearth* (1861), an historical romance, having as hero the father of Erasmus, and dealing in a wonderfully vivid manner with student and vagabond life in Europe toward the close of the Middle Ages. After Reade's death appeared *The Jilt and Other Tales* (1884) and *Good Stories of Man and Other Animals* (1884).

Reade is not among the greatest novelists. He had not a keen artistic sense. His character drawing is picturesque rather than psychological, and he often develops his situations in a highly sensational way. But he always had a story to tell; and therein he excelled perhaps all his contemporaries. Consult: Compton Reade, *Charles Reade, a Memoir* (London, 1887); and for a cordial estimate, Swinburne's *Miscellanies* (ib., 1886).

READE, JOHN (1837—). A Canadian journalist and author. He was born in Ballyshannon, Ireland, was educated at Queen's College, Belfast, and in 1856 came to Canada, where he established the *Montreal Literary Magazine*, and subsequently was connected with the *Montreal Gazette*. In 1864 he was ordained to the ministry of the Church of England. He was elected president of the Montreal Society for Historical Studies in 1887, and in 1896 a fellow of the Royal Society of Literature of Great Britain. His books include: *The Prophecy and Other Poems* (1870); *Language and Conquest* (1883); *The Making of Canada* (1885); *Literary Faculty of the Native Races of America* (1885); *The Half-Breed* (1886); and *Aboriginal American Poetry* (1887).

READE, WILLIAM WINWOOD (1839-75). An English traveler and novelist, nephew of Charles Reade. He began his travels by a visit to the western coast of Africa (1862), and on his return published an account of his tour called *Savage Africa*. Inspired by Du Chaillu's spirited sketches, he returned to Africa in 1868, started from Sierra Leone and traveled to the source of the Niger. Shortly afterwards he published the *African Sketch Book*, and in 1873-74 was special correspondent for the *London Times* during the Ashantee War. In addition to his *Story of the Ashantee Campaign* and other works on travel, he wrote several novels of no great merit, such as *Charlotte and Myra* (1859); *The Veil of Isis, or the Mysteries of the Druids* (1861); the singular work called *The Martyrdom of Man* (1872); and *The Outcast* (1875).

READER (from *read*, AS. *rǣdan*, Goth. *rēdan*, OHG. *rātun*, Ger. *raten*, to counsel, advise: connected either with Lat. *creri*, to think, or with Ochurch Slav. *raditi*, to be anxious for, Lith. *rodas*, willing, Skt. *rādḥ*, to be successful). The title of the third among the minor orders of the Roman Catholic Church, designating a class whose duty it was originally to read the lessons (q.v.) of Holy Scripture in public worship. Traces of their existence as a distinct clerical class are found as early as Justin Martyr, Tertullian, and Cyprian. By present usage, however, the office is nothing more than a formal step to the priesthood. See also LAY READER.

READING, rēd'ing. A municipal, Parliamentary, and county borough, the capital of Berkshire, England, on the Kennet, near its confluence with the Thames, 36 miles west of London (Map: England, E 5). The town is irregular in plan, but well built, and has fine buildings which include a municipal block with two town halls, clock tower, free library, valuable museum, concert hall, etc. Other buildings are the assize courts, the grammar school, founded in 1445, the University Extension College, and Sutton's Abbey Hall. Reading has interesting churches, and the remains of a magnificent Benedictine abbey, founded in 1121 by Henry I., whose burial place it became. Of its three parks the Palmer Park forms a fine recreation ground. The town owns valuable real estate, water, abattoirs, and markets; maintains bathing places, libraries, museum, art gallery, sewage farm, and provides technical instruction. It has an important trade in corn and agricultural produce; famous seed farms and biscuit manufactories, iron works and foundries, breweries, and manufactures of silks, ribbons, velvets, paper, and sauce. The town was of importance in 871, when the Danes made it their headquarters. Domesday mentions it as Radynge. Stephen built a castle which was destroyed by Henry II. Nine parliaments were held within the abbey, which Henry VIII. converted into a palace. In 1643 Reading surrendered to the Parliamentarians, who destroyed the abbey palace. Population, in 1891, 60,054; in 1901, 72,214. Consult: Coates, *History and Antiquities of Reading* (London, 1810); Doran, *History of the Borough and Castle of Reading* (ib., 1832); Jones, *Sketches of Reading: Historical, Archæological, and Descriptive* (Reading, 1870).

READING. A town in Middlesex County, Massachusetts, 12 miles north of Boston, on the Western Division of the Boston and Maine Railroad (Map: Massachusetts, E 2). It is chiefly a residential town. There is a public library with more than 8600 volumes. Church organs, organ pipes, carriages, boots and shoes, rubber, rubber cloth, imitation leather, games, and wire brushes are the most important manufactured products. The government is administered by town meetings convened annually. Reading was settled in 1638 and was incorporated in 1644. Population, in 1890, 4088; in 1900, 4969.

READING. A city and the county-seat of Berks County, Pennsylvania, 59 miles northwest of Philadelphia; on the Schuylkill River and the Schuylkill Canal, and on the Philadelphia and Reading, the Pennsylvania, and the Wilmington and Northern railroads (Map: Pennsylvania, F 3). It covers an area of about six square miles,

and is regularly laid out. There are 72 miles of paved streets, more than two-thirds of this distance being laid with macadam. The public park system comprises 198 acres. Mount Penn, to the east, and the Neversink Mountain to the south of the city, which afford magnificent views, are reached by inclined and electric railways. The more important educational institutions in Reading are the Inter-State Commercial College, the Reading Classical School for Boys and Girls, and Schuylkill Seminary. Other noteworthy features include the county court house, city hall, opera house, Girls' High School building, Masonic Temple, the public and the Berks County Law libraries, and the Reading, Homeopathic, and Saint Joseph's hospitals. The annual county fair is held here, handsome grounds and a race-track being maintained by the association in the northern part of the city. Reading is situated in a region possessed of much mineral wealth, including iron, coal, and limestone, and is an important manufacturing centre. In the census year 1900 an aggregate capital of \$27,975,628 was invested in the various industries, which had an output valued at \$36,902,511. Nearly one-third of the capital and one-fourth of the output were represented by the iron and steel-interests. There are extensive shops of the Philadelphia and Reading Railroad, foundries and machine shops, breweries, and manufactories of cigars, hosiery, knit goods, hats, carriages, pottery, paper, and wood pulp.

The government is vested in a mayor, chosen every three years, and a bicameral council, and in subordinate officials, the majority of whom are either elected by the people or appointed by the council. The school board is chosen by popular vote. The city has a net debt of about \$1,300,000; and the assessed valuation of property (real and personal) is about \$46,000,000. For maintenance and operation, there is spent annually about \$923,000, the main items being \$256,000 for schools, \$235,000 for the water department, \$69,000 for municipal lighting, \$61,000 for sinking fund and interest on debt, \$57,000 for streets, \$52,000 for the police department, \$42,000 for the fire department, and \$33,000 for sewers. The water-works, which were constructed at an expenditure of \$1,937,762, are owned by the municipality. Laid out in 1748 and settled mostly by Germans, Reading (named from Reading, England) was incorporated as a borough in 1783, its population then being 2100, and in 1847, with a population of about 12,000, it was chartered as a city. Its boundaries were extended in 1867 and 1869. Population, in 1890, 58,661; in 1900, 78,961.

READING. The process of conveying to the mind by sight written or printed words or symbols. Almost as commonly the word refers to the vocal expression of that which written or printed symbols are intended to convey. Still more broadly, reading is used to designate the art of speaking to an audience what has been composed by another.

The oldest method of teaching reading and the one that has been most widely followed is the alphabetic or synthetic method. By this a pupil first learns to identify the letters of an alphabet with certain sounds, and then to group these sounds in such a way as to produce others which stand for mental images. In the sixteenth

century Iekelsamer, the publisher of a German primer, pointed out that the sounds representing letters only confused the beginner when he came to combine them into words; but it was not until the latter part of the eighteenth century that any other method was able really to establish its claim to superiority. Since then, the analytic method, usually subdivided into the Look-and-Say or word method and the Syllabic method, has been constantly growing in favor. By this, pupils are first taught to associate a mental image with a single word or combination of words, and only later to analyze these combinations into their phonetic or alphabetic elements. The reading book has been made a means of inculcating certain dominant national ideals and principles as well as a drill book. The tendency has been to use selections from standard authors, and to provide for unabridged selections, rather than for extracts.

Reading as the oral expression of literature differs from the ordinary reading aloud in that the expression is usually to an audience, and in that the speaker commonly recites from memory, instead of reading from a printed page. As an art it is to be distinguished from oratory, where the speaker deals with that which he has himself composed.

BIBLIOGRAPHY. Kehr, *Geschichte des Leseunterrichts* (Gotha, 1889); id., *Praxis der Volksschule* (10th ed., ib., 1885); Laurie, *Language and Linguistic Method* (Edinburgh and London, 1893); Hinsdale, *Teaching the Language Arts* (New York, 1896); Arnold, *Reading, How to Teach It* (Boston, 1896); Bates, *Talks on the Study of Literature* (ib., 1897); Stanley Hall, *How to Teach Reading* (Boston, 1897); Chubb, *The Teaching of English* (New York, 1902); Carpenter, Baker, and Scott, *The Teaching of English* (ib., 1903).

READJUSTERS, or REFUNDERS. The name applied to a political party in Virginia, from 1878 to 1885, which favored the 'readjustment' or scaling down of the State debt. At the close of the Civil War the public debt of Virginia amounted to about \$41,000,000, which was increased by the extravagance and corruption of the reconstruction governments. On account of the general impoverishment of the time, the interest account could not be met, although the rate of taxation had been enormously increased. An act of 1870-71 to refund the debt was repealed in the following year, but the repealing act was not sustained by the courts. Still the arrears of interest increased, and by 1878 the State was pretty well divided between 'debt payers' and 'readjusters.' During that year the Legislature passed the 'McCulloch Bill' which provided for the issue of new bonds to be exchanged for outstanding bonds dollar for dollar, and to bear interest at 3 per cent. for ten years, 4 per cent. for twenty years, and 5 per cent. for ten years, making an average of 4 per cent. for forty years. The 'readjusters' organized themselves into a political party, and succeeded in gaining a majority of the seats in both Houses of the Legislature. Their leader was H. H. Riddleberger, who won notoriety by his bill declaring that the State ought not to pay any part of the interest upon the public debt which had accrued during the Civil War and the period of Reconstruction. The bill proposed to scale down

the public debt from \$31,102,571 to \$19,665,196, and to devote to its payment only that portion of the State revenues for which no other use could be found. The bill passed both Houses of the Legislature, but was vetoed by the Governor. In the State election of 1881 the readjusters, with the help of the Republicans, defeated the Conservative Democratic Party, which approved the McCulloch bill. The readjusters now passed three important measures. The first two, popularly known as 'Coupon Killers,' were designed to prevent the payment of State taxes by means of coupons from bonds issued in pursuance of the McCulloch act and the act of 1871. The third measure was substantially the Riddleberger bill reënacted. The majority of the bondholders refused to accept the settlement and tested the constitutionality of the 'Coupon Killer' acts in the courts. In nine decisions, generally known as the 'Virginian Coupon Cases,' the United States Supreme Court declared in substance that the later act forbidding the receipt in payment of taxes of those coupons which were received under the act of 1871 was an impairment of the obligation of contracts in conflict with the Constitution of the United States and therefore void. In the legislative session of 1884, before the final decision was made, several acts were passed for the purpose of rendering the coupons worthless, and in the sessions of 1886 and 1887 still further attempts of this kind were made. Recently a final settlement in the nature of a compromise between the State and the bondholders has been effected, and the long-continued controversy over the debt question seems to have come to an end. Consult Scott. *The Repudiation of State Debt* (Boston, 1893).

REAGAN, rē'gan, JOHN HENNINGER (1818—). An American statesman, born in Sevier County, Tennessee. In 1839 he removed to the Republic of Texas and settled east of the Brazos. He began the study of law and was admitted to the bar in 1846. From 1852 to 1857 he was judge of the Ninth Judicial District. From 1857 to 1861 he was a member of Congress, but resigned to serve as delegate to the Texas Secession Convention, by which he was elected a Deputy to the Provisional Congress of the Confederate States. On March 6, 1861, he was appointed Postmaster-General of the Confederate States under the Provisional Government, and was reappointed in February, 1862, after the permanent Constitution was adopted. In 1865 he was also acting Secretary of the Treasury. He was captured with President Davis, May 10, 1865, and was confined in Fort Warren until October. While in prison he wrote the celebrated *Fort Warren Letter* to the people of Texas, advising them to confer civil rights upon the negro and admit the more intelligent to the suffrage, lest worse and more radical measures should follow. This was misconstrued and subjected him to much harsh criticism in the State. From 1875 to 1887 he was a member of Congress, and for ten years he was chairman of the Committee on Commerce. He was the author of the Reagan Interstate Commerce Act, which became law in 1887. In 1887 he was elected to the United States Senate, but resigned in 1891 to become chairman of the Texas State Railroad Commission.

REAL ACTION. Under the common-law system of pleading, an action brought for the recovery of the possession of real property. A real action may be based merely on the right of possession, as where a tenant under a lease is ejected and seeks to recover back possessions, in which case it is classed as *possessory*; or it may be based on right of title in the property, as where an heir claims inherited real estate, in which case the action is said to be *droitural*. A real action was begun by a writ. Thus, a possessory real action was begun by a writ of entry or writ of assize, whereas a *droitural* real action was commenced by a writ of right, writ of formodon, or a writ of dower, according to the nature of the right or title involved. A real action was distinguished from a mixed action by the fact that in the latter damages could be recovered.

The old forms of real actions have been superseded in nearly all jurisdictions by the more modern action of ejectment, and in code States by statutory proceedings to recover real property. See ACTION; EJECTMENT; FORMS OF ACTIONS.

REAL ASSETS. See ASSETS.

REAL ESTATE. Land, together with such growing crops, trees, etc., and improvements thereon as are considered to be a part of and pass with it, or any interest in land greater than a term of years. In general, all movables and interests in land less than a freehold are called personal property to distinguish them from the above. Real estate descends to the heirs of a deceased owner, and is subject to dower and curtesy. Greater formalities are required to convey or incumber real estate than are necessary in dealing with personal property. The terms 'real estate' and 'real property' are used interchangeably, and for a more complete discussion of the rules of law applicable thereto, see the article under the latter title. Consult: Blackstone, *Commentaries*; Leake, *Digest of the Law of Land*; Washburn, *Real Property*.

REALF, rälf, RICHARD (1834-78). An English-American poet, essayist, and reformer, born in Sussex. He published his first volume of verse in London in 1852: it was entitled *Guesses at the Beautiful*. At the age of twenty he emigrated to the United States, and settled in Kansas, where he became interested in the anti-slavery movement and was an adherent of John Brown. During the Civil War he served in the Union army, and at the close worked in behalf of the negroes. In 1870 he was writing for the Pittsburg *Commercial*, and lectured in various parts of the country. He died by his own hand at Oakland, California. An edition of his poems was issued in 1899 by Col. Richard J. Hinton.

REALGAR (from Ar. *rahj al-ghār*, powder of the mine, mineral powder). A mineral arsenic monosulphide that crystallizes in the monoclinic system, and is of a red or orange-yellow color, with a resinous lustre, and is generally translucent, though sometimes transparent. It occurs with lead and silver ores at various localities in Bohemia, the Harz, Hungary, and Transylvania; also in Utah and California in the United States. Realgar was formerly somewhat used as a pigment; it is also called 'red orpiment,' or 'ruby sulphur.'

REALGYMNASIA. See GYMNASIA.

REALI DI FRANCIA, *ra-ä'le dö frän'ehä*, I. (It., royal men of France). A chivalric romance attributed to the Italian writer Andrea da Barberino, and therefore of about the end of the fourteenth or the beginning of the fifteenth century. It is a legendary account of the kings of France, whose history is traced back to a Roman origin, since their line is made to begin with Constantius, the banished son of Constantine the Great. The simple and straightforward style is attractive, despite the crudities of expression. Consult the critical edition of the *Realì* by Bandedli (Bologna, 1892).

REALISM. In philosophy, a term used to denote (1) the metaphysical theory that universals have an existence independent of individual objects (see **NOMINALISM**); and (2) the metaphysical view that objects of experience have an existence independent of the consciousness to which they are presented; opposed to idealism (q.v.). See **KNOWLEDGE, THEORY OF; METAPHYSICS.**

REALISM AND NATURALISM. The doctrine of a school of novelists who opposed and still oppose idealism or romanticism. Realism soon spread throughout Europe and the United States. Although we technically apply 'realistic' to a nineteenth-century school of writers, realism may be traced back through the ages. We find it in Boccaccio and in Chaucer, in the picaresque novels of Spain, in Nash, in Voltaire, and in Richardson, still more in Fielding, Smollett, and Defoe, each of whom intended to produce illusions of actual every-day life or reality in exceptional phases. Each of these writers is quite as realistic in the main as the authors of *Mme. Bovary* and of *Une vic*. The early modern realists were at last submerged in romanticism.

The romantic school had regarded the function of the novelist as one of the imagination. His task was to imagine a series of incidents more or less probable, and a set of characters more or less heroic or unusual. His world was in many respects an ideal world. The idealist, who has always existed, wishes for his part to choose beautiful themes, to improve on men, one might almost say, to make angels out of them at times—in a word, to paint things not as they are, but as the idealist would have them. Poets have lived in a dream-world oftener than writers of prose. Fairy tales are mostly idealistic, even when their personages are witches and goblins, for such beings are merely idealizations of evil. Realism is avowedly closest to nature; romanticism elings to nature, but loves freakish things, whether they be ugly or pleasing; idealism says what is ugly can be made beautiful, and that what is beautiful can be made more beautiful. Idealism gives us beautiful works, such as *A Midsummer Night's Dream*, *La petite Fadette*, Valera's *Peppita Jimenez*, and *Undine*, as well as many pastoral romances about people who are preternaturally beautiful, or good or bold, or even wicked, whose conversations sparkle with epigrams, whose main business, in fine, is not closely related to the dead level of existence or to average truth. But realism, naturalism, romanticism, and idealism, vague words, to say the least, are all only Nature reflected by various mirrors held up to her in countless ways. Each denotes a tendency stronger at one period than at another, and the tendency is never hard to feel, yet always too subtle, too shifting, to be

defined. Again, the realism of literature in another phase is the realism of sculpture and the graphic arts. The extreme realists conceive of the vocation of the novelist as that of an accurate reporter of what he has carefully observed in the every-day life of the world about him. Fancy, they say, hinders this exact reproduction of truth, for the realistic school deals only with facts. To it nothing is too trivial, or too commonplace, or too unpleasant to be recorded. In a word, 'any corner of nature,' if accurately depicted, will be profoundly interesting.

The progenitor of this school is said by the French nineteenth-century realists themselves to have been Rousseau, who in his *Confessions* adopted the plan of setting forth minutely the exact details of his life, concealing nothing, not even those incidents that were in the highest degree discreditable and shameful. But Rousseau merely furnished the suggestion of the tremendous force that lies in outspoken truth, and did not himself apply the theory to fiction. This was done by Marie Henri Beyle (1783-1842), better known by his pseudonym 'Stendhal,' who, in his novels *Armance*, *Le rouge et le noir*, and *La chartreuse de Parme*, developed a process of ruthless vivisection based on observation of social and physiological phenomena. The realistic method was carried out on a grand scale by Honoré de Balzac (q.v.) in his *Comédie humaine*. In this marvelous series of works Balzac attempted to delineate the entire life of his time, extenuating nothing, glozing over nothing, but setting forth motive and action with minute fidelity to truth. The discrepancy between Balzac's theories and his practice is obvious to those who would hold him to his word. Closely following him came Gustave Flaubert (q.v.), whose *Madame Bovary* (1857) achieved forthwith a great success and as great a scandal. It was a study of provincial life, as unsparing as any study of Balzac's, but superior in style. Joris-Karl Huysmans (1848—) pushed realism to extreme lengths, choosing subjects and scenes that are usually banished from polite society, and his *Marthe* (1876), which was too crude for even the indulgent censorship of modern France, may be taken as a sublimated type of the 'naturalistic,' as distinct from the merely 'realistic,' novels.

The naturalists of fiction are realists and something more. They profess to derive from Stendhal through Balzac and Flaubert. That is to say, they adopt the analytic method and devote themselves chiefly to the study of character. But they go further and object to the processes of art. According to them, literature, to be strictly 'scientific,' is comparable not with painting or drawing, but with anatomy and dissection. It is worth our while to observe that the so-called realistic and then the naturalistic school rose with, or after, the great rise of experimental science in the early years of the nineteenth century. Yet few genuine scientists would admit the scientific pretensions of the most conscientious realists or naturalists; for, even when their science is not imaginary or the work of dabblers, it is necessarily perverted or modified so as to give a continuous picture of life. No biologist, psychologist, or any other scientist, save the linguist, would think of looking for trustworthy observations in the works of realistic or naturalistic novelists. Unfortunately, too, the extreme realistic school, and

later the naturalistic writers, sought their material in the baser walks of life, for they found little in the humdrum existence of decent mediocrity wherewith to stir their readers. True, some realists asserted that 'truth' (meaning their observations) is never dull, and it must be confessed that the Goncourts combined to 'report' with extraordinary interest, and often charmingly, many scenes which at first blush would be called dull and unsuggestive; but this result was achieved by dint of talent, which found a hundred new thoughts in relations and presented them with skill. If, however, we were to gather statistics from the more modern realistic school; especially in the Romanic countries, we should almost certainly find that the school called realistic has dealt rather slanderously with the national life. It has dwelt on freakish or morbid themes and has made its appeal to the beast in man. On the other hand, it has served to awaken readers to the falsehoods or to the fatuous aspects of the romantic and idealistic schools. But there are no hard and fast boundaries. Zola is often romantic; Victor Hugo is often realistic. Realism is a tendency in authorship and not a definite province in literature. This observation may be verified by perusing the works of Stendhal, Balzac, Flaubert, Maupassant, the Goncourts, Zola, and Daudet in France, of Verga, Fogazzaro, and Gabriele d'Annunzio in Italy, of Valdés and Galdós in Spain, of Hauptmann and Sudermann in Germany, of Tolstói's later work, and of Ibsen and Björnson in Scandinavia. In England the later realists had their greatest representatives in Thackeray, Dickens, and George Eliot. Here again it may be said that the most consistently realistic of these, George Eliot, was closely affiliated with experimental scientists, just as was the case in France. But English realism was never extreme. It has not wallowed; it has not treated its fictitious personages with the cynical scorn of the French school. It has had no Zola to be repudiated by his 'master' Taine. Realism, however, took a firm foothold in England. Thackeray and George Eliot have been followed by George Meredith, Thomas Hardy, and George Moore, and by W. D. Howells in the United States, in whom is many a romantic touch, but also imaginative common sense, decency, gentleness, and an agreeable absence of those scientific pretensions which once roused the smiles or the indignation of scientific men in France and elsewhere.

Those whom we are wont to reckon in the realistic school are novelists or tellers of short tales. Their object ostensibly is to observe, analyze, and describe the actions of others, or their thoughts as uttered, or it may be only as implied. This condition requires imagination; for fragmentary manifestations in other beings must be supplemented by the experiences of the author in order to make a continuous narrative. If now we turn to the diarist and the autobiographer, we shall find that realistic portrayal is not thus hampered; for the diarist and the autobiographer find a ready-made continuity in their own experience. Fancy is not a necessary factor of their art. Hence Pepys is a realist of the first order; so, too, is Benvenuto Cellini; nor need we wonder that the French realistic school discovered a prototype, if not a pattern, in Jean Jacques Rousseau.

Consult: Zola, *Le Roman expérimental* (Paris,

1880); id., *Les Romanciers naturalistes* (Paris, 1881); Chandler, *Romances of Roguery* (New York, 1899); Brunetière, *Le roman naturaliste* (Paris, 1892); Cross, *Development of the English Novel* (New York, 1899). See articles on the various authors cited; also NOVEL and ROMANTICISM.

REAL PROPERTY. In the artificial classification of property rights adopted by the English and American law, real property comprehends the larger part of the rights (those, namely, known as "freehold" interests) in land, together with a limited number of other rights, which have for one reason or another, been subjected to the same rules of law. The most important of the latter are certain "incorporeal" interests, as they are called, such as hereditary offices, titles of honor, franchises, annuities, tithes, and the like; while, on the other hand, not a few interests in land, such as leaseholds, mortgages, and certain other creditor's estates, have, for historical or practical reasons, found their place in the rival category of personal property. The famous expression, "lands, tenements and hereditaments," usually employed as an exhaustive description of real property rights, is thus an inaccurate statement of such rights, certain landed interests, as has been seen, not being included in the description of real property, while other forms of such property, as heirlooms and the "incorporeal" interests above referred to, not being in the feudal sense "held" of a superior lord, cannot be described as tenements. The term "hereditament," alone, has come to represent all the varieties of property known as "real," and to be in a sense coextensive in meaning with that class of interests, as they all have the common quality of heritability. Indeed, from the conception of heritability as a quality, or incident of estates in real property, we have, by a curious process of inversion, arrived at the notion of real property as anything capable of inheritance, and have included in the category of real property many classes of rights having nothing to do with land, for no better reason than that, by local custom or otherwise, they descend, like freehold estates in land, to the heir of the possessor.

The ordinary division of real property into "corporeal" and "incorporeal hereditaments" has been considered in the general discussion of property rights. (SEE PROPERTY.) Though not free from objection, it may be taken as a convenient description of such interests in land as rest on possession and such as do not involve possession, respectively. The former comprise the so-called freehold estates of possession (fee simple, fee tail, and life estates), and the latter all future estates (as remainders, reversions and the like), a great variety of equitable interests in land (of which the most important are trusts and equities of redemption), and the large class of interests in the land of others, known as easements and profits.

The feudal origin of our real property law and the strange conception derived therefrom that lands are not like chattels, susceptible of absolute ownership, but only of tenure and of the qualified ownership described by the term "estate," has been considered elsewhere. (SEE ESTATE; FEE; PROPERTY.) It remains to be noted that incorporeal as well as corporeal heredita-

ments are subject to be "held" in estates, rather than owned outright, and that there may as well be a fee simple, a fee tail, or a life estate in a remainder, a trust or an easement, as in the visible land with which all of these terms are concerned. The difference between the two classes of hereditaments lies rather in the processes by which they may be acquired and transferred. Both descend to the same heir upon the same event, and both are alike subject to the free power of alienation, but the nature of the one renders it incapable of seizure or possession, and therefore alienation by the ancient process of livery of seisin to "lie in livery," i. e. to be susceptible of delivery, wherefore it "lies in grant," and is transferred only by deed. Our modern instrument of conveyance is merely the ancient deed of grant, originally appropriated to the incorporeal hereditament, but now employed for the alienation of corporeal property as well. See ALIENATION; DEED; GRANT; HEREDITAMENT.

The history of the law of real property is one of the most interesting chapters in the long record of social and political progress from the Norman conquest of England to the present time. The rise and decay of the system of feudal tenure, the transformation of the law of land by the court of chancery in the institution of uses and trusts and in its assumption of jurisdiction over mortgages, the changes which that law underwent in its migration to America, are only the more obvious and dramatic developments of a long and steady process of amelioration. The base rights of inheritance and alienation gained in the thirteenth century have been followed by a constantly enlarging conception of the rights of offspring to the inheritance and by a growing freedom of alienation. Conveyancing, once the most intricate and technical of professional tasks, requiring the services of a specially trained class of lawyers, has been robbed of its terrors, and promises, in the near future, to become as simple a matter as the sale of a horse. Entails and other restrictions upon the free control of the land by the generation in possession have been well nigh done away with, and the paramount rights of the State have been narrowed to the rare exercise of the right of escheat upon the failure of heirs. Consult the authorities cited under the title PROPERTY, and, in addition, Kent, *Commentaries on American Law*; Digby, *Introduction to the History of the Law of Real Property* (5th ed., Oxford, 1897); Jenks, *Modern Land Law* (Oxford, 1899); Tiffany, *The Law of Real Property* (St. Paul, 1903).

REALSCHULE, rä-äl'shōō'le. A German school of secondary instruction differing from the Gymnasium inasmuch as it offers no instruction in the classical languages and lays stress on science. The Realschule is an outgrowth of the realistic tendencies of the seventeenth and eighteenth centuries. The institutions that Francke established at Halle toward the close of the seventeenth century laid unusual stress on the study of nature. At the same time notable efforts were being made to introduce more science into the classical schools generally. In 1747 Hecker established at Berlin an *öconomisch-mathematische Realschule*, which may be regarded as the prototype of the Realschule of to-day. It gave instruction in the German, French, and Latin languages, writing, arith-

metic, drawing, history, geography, and the elements of geometry, mechanics, and architecture, and also in religion and ethics. Some optional study of various occupations and trades was also provided.

The Realschule of to-day has a six years' course, and its graduates go directly into business life. Those who wish to take the university courses in science and mathematics attend the *Oberrrealschule*, which has a nine years' course. The programme in this school is like that in the Realgymnasium, with the exception of the omission of Latin and the substitution thereof of more work in mathematics, natural history, chemistry, mineralogy, French, and English. Graduates of these two types of schools are regarded as on the same plane educationally, but both are looked upon as somewhat inferior to the graduates of the Gymnasium. Consult: Russell, *German High Schools* (New York, 1899); Bolton, *Secondary School System of Germany* (ib., 1900). See NATIONAL EDUCATION; GYMNASIA AND REALGYMNASIA.

REAPERS, REAPING (from *reap*, AS. *ripan*, to reap; connected with OHG. *rifi*, Ger. *reif*, AS. *ripe*, Eng. *ripe*). The first implement used for reaping was the reaping hook or sickle, dating from the Stone and Bronze ages (Fig. 1, a, b,

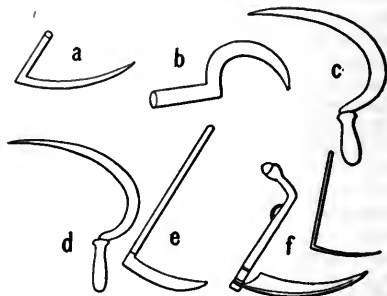

FIG. 1. VARIOUS FORMS OF SICKLES AND SCYTHES.

c, d). Records of this implement are found in Egyptian history n. c. 1400 to 1500. The earliest form of the sickle had a slightly curved blade with straight handle; later the blade was toothed or serrated, and its form approached that of the modern sickle. As a rule the edge was made plain and sharp like a knife. The ancient Jews used a sickle of the Egyptian form. In China and Japan to-day are found sickles of much the same form as those which have been used there from time immemorial. The Greeks and Romans used smooth-bladed sickles or a sickle with toothed blade attached to a curved stick. The latter also used a small hooked knife resembling a pruning hook. The scythe followed the sickle and was apparently introduced by the Romans, by whom it was employed mainly for cutting grass. Pliny, in his writings, distinguishes between the sickle and the scythe, and Crescenzo described both in 1548. At first the scythe was intermediate in construction between the sickle and the modern scythe, as in the Hainault scythe (Fig. 1, f). In time the blade became lighter, and the handle underwent numerous changes in form and material until the modern crooked wooden pattern was evolved. The next step was the fastening of fingers (one to four) to the scythe parallel with the blade, thus evolving the so-called cradle scythe (Fig. 2, a). The fingers were

at first made shorter than the blade, and the operator cut toward, and left the cut grain leaning against, the standing grain. The Americans made improvements in these old forms, and developed the American cradle scythe (Fig. 2, *b*) about the period from 1776 to 1800. This implement

little progress was made until 1822, when Henry Ogle brought out his side-draught machine, with reels, reciprocating knife (straight-edged) over

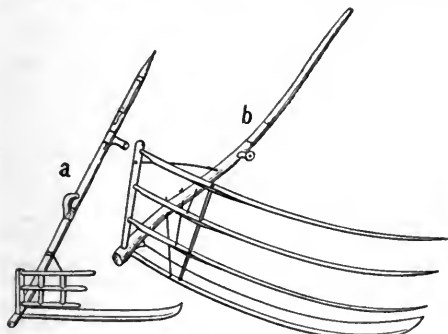

FIG. 2. FORMS OF CRADLE SCYTHES.

was in universal use in America at the beginning of the nineteenth century. It is now employed only where the use of reaping machines is impracticable. Both sickle and scythe are widely useful agricultural implements.

The first reaping machine recorded in history is the Gallic header (Fig. 3) mentioned by Pliny, A.D. 23, as used in the extensive fields of the lowlands of Gaul. This consisted of a large box with projecting teeth along its front edge, which was pushed through the grain by an ox hitched in rear. The heads were caught and torn off by the teeth and were raked into the box by an attendant. A similar machine was

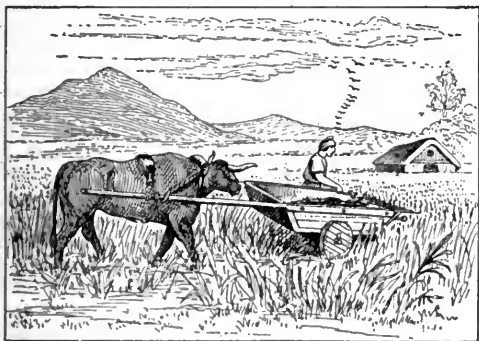

FIG. 3. THE GALLIC HEADER.

mentioned by Palladius four centuries later, but it was forgotten for ages. In modern times the idea of a mechanical reaper seems to have originated with Cabel Lloft of Britain, who in 1785 suggested a machine somewhat after the pattern of the Gallic header. It was probably never constructed. After that date numerous unsuccessful attempts were made to construct a practical reaping machine on the Gallic header plan or using the revolving knife idea. In 1807 Salmon of Woburn made the first reciprocating and advancing-motion machine, its cutter consisting of vibrating knives over stationary cutters. This machine as well as that of Gladstone was provided with a rake to sweep the grain from the platform. A number of machines were invented and given trial about this time, but

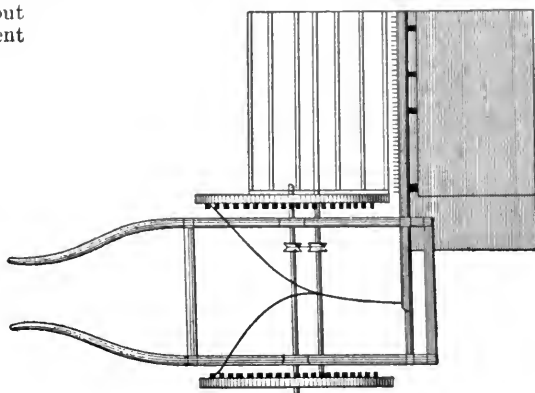

FIG. 4. OGLE'S REAPING MACHINE.

stationary fingers, dividers, and platform, thus foreshadowing the essential features of the modern reaper (Fig. 4). In 1827 Patrick Bell invented a machine which was used with considerable success in England and Scotland. Its cutter worked on the shear principle. The cut grain was carried to one side by means of revolving rollers. It had reels and dividers, and was pushed through the grain by a team hitched in the rear. This machine, although built on a wrong principle, is important because it was simple in construction and fairly efficient in practice. It was introduced to some extent in America.

From this time forward independent English development of the reaper practically ceased, and reaper construction began to be influenced by American ideas and methods.

The first patent for a reaping machine in America was granted to Richard French and T. J. Hawkins of New Jersey in 1803. In 1812 a patent was granted to Peter Gaillard of Pennsylvania for a grass-cutting machine, which was the first of its kind in America or England. A more successful grass cutter was invented by Jeremiah Bailey of Pennsylvania in 1822. It was built on the revolving cutter plan, with side-draught and an arrangement for keeping the cutter at a uniform distance from the ground. Several other machines followed these, the most important of which was that of William Manning of New Jersey, patented in 1831, which had a cutting device very closely resembling those of Hussey and McCormick, which afterwards became important. It also had a grain divider, the first recorded on an American machine. At this epoch American genius combined all the best features of preceding inventions, English and American, in two practical machines, that patented by Obed Hussey of Maryland in 1833 and that patented by C. H. McCormick of Virginia in 1834. These machines were very similar in principle. Hussey's was provided with a cutter of pointed blades attached to a bar, which vibrated through slots in iron fingers projecting from the front of the cutter bar. The grain fell on a platform and was raked off by a man riding on the machine. It had no reels. McCormick's had a serrated edge knife with

way outline instead of pointed sections as in Hussey's. It was provided with a divider and reels, but no seat for the attendant who raked off the cut grain. Both were side-draught machines. McCormick's was arranged so that it could be either drawn or pushed. These two machines furnished the basis upon which all successful modern machines have been constructed. They continued to be improved, but not until nearly the middle of the century could

wire. The most practical of these earlier machines, although not strictly a binder, was that known as the Marsh harvester, patented in 1858, in which the cut grain was elevated to a receiving box from which it was taken and bound by two men riding on the machine. This machine contained many features of the modern binder, especially the delivery of the grain by a canvas carrier over the drive wheel as distinguished from the 'low-down' type in which

the binding device was attached to the self-rake. In 1864 Jacob Behel invented the knotting bill, which, with slight modifications, is used in almost all modern binders. In the meantime various fairly successful wire-binding machines were put on the market by different manufacturers, but in 1875 John F. Appleby, who had invented a successful twine knoter as early as 1859, made a binding apparatus, which with subsequent improvements furnished the basis for the binding apparatus of almost all modern binders, which are essentially a combination of this binding device with the Marsh type of harvester.

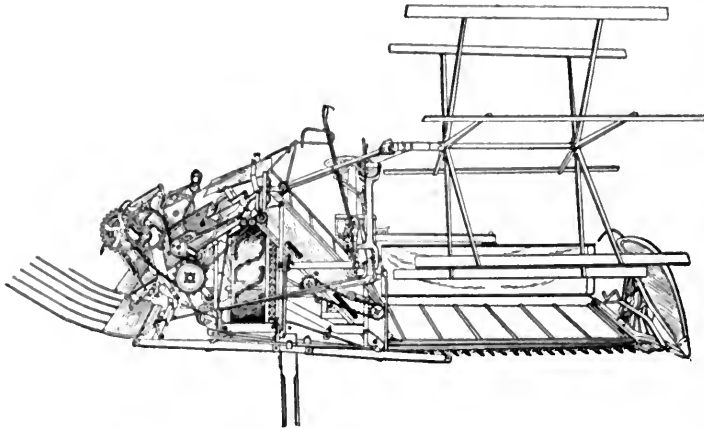

FIG. 5. A MODERN HARVESTER AND BINDER—FRONT VIEW.

they be said to have achieved any practical success. They were entered in competition with each other and with English machines at the Exposition in London in 1851. Development was rapid thereafter. Both machines were introduced into England, where they influenced reaper construction to the abandonment of the older types.

In 1848 Nelson Platt, an American, invented a self-acting rake, which swept over a quadrantal platform and left the grain in gavels at the side of the machine. This was the first of the sweep-rake type, although numerous devices for delivering the grain in gavels at the side of the machine had been patented. In 1851 Palmer & Williams and William H. Seymour obtained patents for sweep-rakes over quadrantal platform. In 1856 Owen Dorsey of Maryland patented a self-rake which was an improvement of Hoffheim's type, invented in 1852. McCormick introduced his self-rake in 1861, based on S. A. Lindsay's patent of 1859. In this, which may be taken as a type of the self-rake machines, a rake is so used that "during one part of the revolution of the gathering-reel it acts as one of the vanes of the reel in bending the standing grain to the cutting blades. When the rake reaches the cutting blades in front of the platform, it ceases to revolve around the reel-shaft (which continues its rotary motion), and is made to move horizontally upon a vertical hinge, to which one end is attached (the points of the teeth being near the surface of the platform), sweeping the cut grain off at the side, and depositing it on the ground in sheaves ready for the binder."

The first recorded attempt to bind grain by machinery was made by John E. Heath of Ohio, who obtained a patent in 1850, which was for a twine or cord binder. Other patents rapidly followed for machines using cord, straw, and

The most advanced and complicated type of harvester is probably the combined header and thresher which is used to a considerable extent in some parts of the Western United States and in Australia, where there is no fear of rain during the harvest. This machine heads, threshes, cleans, and sacks the grain at one operation. Machines of this kind are pushed through the grain either by a traction engine or by horses, thirty to forty of the latter being required for each machine. They have a capacity of from 60 to 125 acres per day. Headers are also made for use uncombined with a thresher. The cut grain is deposited by means of elevators in wagons which are drawn beside the headers. It is stated that as early as 1850 a machine was invented and successfully tried in Devonshire, England, which stripped the grain from the straw, cleaned it, and ground it into flour at one operation.

The mower developed simultaneously with the reaper. In fact, many of the earlier machines were designed to be used either as a mower or as a reaper. A separate machine for cutting grass was patented as early as 1812 by Peter Gaillard of Pennsylvania. Hussey's original machine was really a mower, being built on principles afterwards adopted and developed in the construction of mowers. The most prominent name connected with the early development of mowers is that of W. F. Ketchum, who patented in 1847 a mower of simple design, having a single driving wheel. After the adoption of the Hussey type of cutter this machine proved a very successful mower of the rigid bar class. The first patent for a mower of the flexible bar type was granted to Cyrenus Wheeler in 1854. The flexible bar idea was further developed in a machine invented by Jonathan Haines in 1855. This had two drive wheels and a cutter bar

joined to the main frame in such a manner that it could be lifted over obstructions. In 1856 Aultman & Miller patented a machine which contained practically all of the essential features of the successful modern mower, viz. two driving wheels (the best types of modern reapers have one), the flexible cutter bar, with rapidly reciprocating blades, having smooth-edge sections, which was so hinged to the main frame that it could be raised and folded over against the latter when the machine was not in use. While combined reapers and mowers are still made, separate machines for the two purposes are considered preferable. The modern reaper has been adapted to the harvesting of all crops, such as maize, rice, peas, etc., and modified to meet all sorts of conditions, and has enormously decreased the labor involved in harvesting. Consult: Ardrey, *American Agricultural Implements* (Chicago, 1894); Stephens, *The Book of the Farm*, vol. ii. (Edinburgh and London, 1871); Scott, *Textbook of Farm Engineering* (London, 1885); Swift, *Who Invented the Reaper?* (Chicago, 1895); Stabler, *Overlooked Pages of Reaper History* (ib., 1897); *Official Retrospective Exhibit of the Development of Harvesting Machinery at the Paris Exposition, 1900*, United States Department of Agriculture Office of Experiment Stations, Bulletin 103.

REAR-ADMIRAL. See ADMIRAL.

REAR GUARD. A detail of troops assigned to the duty of protecting the baggage and rear of a column on the march. Rear guards are practically advance guards reversed, and are used to protect a force advancing against or retreating before an enemy. In the former case they pro-

tect the rear of the column against attacks by guerrillas (q.v.), partisans of the enemy, or other marauders, and prevent straggling. The most important as well as most difficult duty, however, is when covering and protecting a column in retreat, in which case the rear guard is subject to incessant attack. To organize speedily an effective rear guard out of troops demoralized by defeat is a crucial test of both officers and men. Coolness, courage, and absolute discipline are demanded of the men, while resourcefulness and tactical skill in the officer commanding must be second only to his bravery. Under ordinary conditions the distance of a rear guard from the main body is about the same as that of an advance guard (q.v.). At night the distance is considerably lessened. The ever-present danger with a rear guard is the danger of being turned, and to guard against this flanking patrols are sent out to reconnoitre and patrol the flanks. Every available method and opportunity is taken to delay the pursuing force; bridges and roads are destroyed, passages or defiles blockaded, fords rendered difficult of passage, crops destroyed, and horses and wagons removed. Whenever possible, the rear guard consists of all three arms, and particularly of cavalry, the strength of the guard varying according to the circumstances of the case. The diagram shown is a theoretical disposition of a rear guard consisting of a company of infantry, 100 men.

REAR HORSE. See MANTIS.

REASON. See RATIOCINATION; UNDERSTANDING.

RÉAUMUR, rá'ó'múr', RENÉ ANTOINE FERCHAULT DE (1683-1757). A French naturalist and physicist, born in La Rochelle, February 28, 1683. He was educated in the Jesuits' College at Poitiers and at Bourges, and in 1703 he went to Paris, where he continued the study of physics and mathematics. His earliest publications were mathematical and obtained him an election to the Académie des Sciences in 1708. He then interested himself in the study of marine animals; he proved the power of regeneration in crustaceans, studied locomotion in starfishes, showed that zoöphytes were animals, studied the action of the electrical organ of torpedo and the phosphorescence of marine animals. In 1710 he began to compile a large work for the Government, *Description de divers arts et métiers*. Somewhat later a series of important memoirs on the production of steel and on improvements in the manufacture of iron won him a yearly pension of 12,000 livres. He discovered the method of tinning iron; studied the production of fine porcelain; also the condition of forests, mines, auriferous rivers, and the fossil beds of France. He invented the Réaumur thermometer, in which for the first time the zero-point was made to coincide with the freezing-point. (See THERMOMETER.) Amid all these activities Réaumur was constantly carrying on his investigations in the field of natural history. The most important of all his publications are his works in this department; of these the greatest is *Mémoires pour servir à l'histoire des insectes* (6 vols., 1737-1748). He left materials for a history of quadrupeds and birds afterwards made use of by Brisson and Buffon.

REBEC (OF. *rebec*, *rebeke*, Fr. *rebec*, from Ar. *rabāb*, *rebec*, from *rabba*, to be master). A three-stringed instrument played with a bow. It was of Indian origin, and from Persia it was carried to Arabia, Northern Africa, and, about the eighth century, by the Saracens into Spain. It was in outline like the mandolin, shaped like the half of a pear, with a long neck, finished by

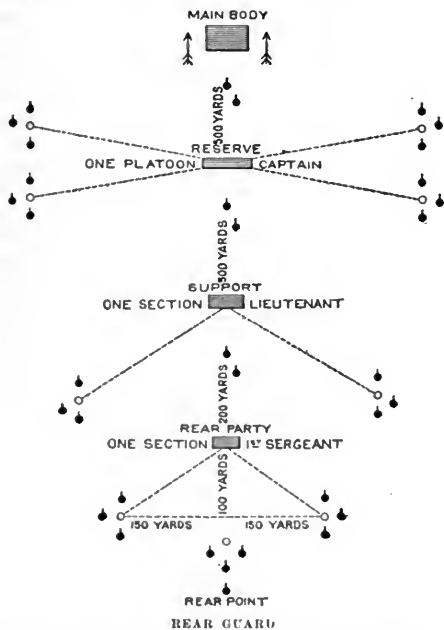

tect the rear of the column against attacks by guerrillas (q.v.), partisans of the enemy, or other marauders, and prevent straggling. The most important as well as most difficult duty, however, is when covering and protecting a column in retreat, in which case the rear guard is subject

a curved human head. Two trefoil-shaped sound holes ornamented the belly, and the instrument was fitted with a bridge and sound-post. The performer held it against his breast, or under his chin, like a violin. The rebec was the parent of the violin, and the three gut strings were tuned like the three lower violin strings, G, D, and A. The tone was loud and harsh, but powerful, which made it a favorite in mediæval orchestras. Specimens are very rare. For illustration, see Plate of MUSICAL INSTRUMENTS.

REBECCA. The beautiful Jewess, daughter of Isaac of York, in Scott's *Ivanhoe*. She loves the hero, whom she nurses after the tournament at Ashby, but is pursued by the Templar Bois Guilbert. Convicted of sorcery, she is condemned to the stake, but is saved by Ivanhoe, who enters the lists as her champion. With her father, Isaac the Jew, she leaves England for Spain, a country then more hospitable to the Jews than England.

REBEKAH. See ISAAC.

REBELLION (Lat. *rebellio*, from *rebellis*, making war again, from *re-*, back again, anew + *bellum*, war). In its narrowest sense, open resistance to authority. In its public-law signification rebellion is the armed opposition to the government of a portion of its subjects for the purpose of securing a change in the constitution or laws, or with a view to preventing the execution of the laws. Unless the authority against which the resistance is directed be lawful there is no rebellion. Thus, resistance to an officer who is acting beyond his legal powers is not an act of rebellion. Rebellion is sometimes said to differ from insurrection in that it is a more general and more perfectly organized resistance than insurrection, and usually undertaken with a view to subverting the government, that is, the difference chiefly is one of degree. This is the view taken by the United States Supreme Court (*Price Cases*, 2 Black). Other authorities hold the reverse to be true. According to the latter view a rebel is one who openly refuses to obey the authority of the State, while an insurgent goes further and attacks the government with the intent of overthrowing it or replacing it by another. According to the public-law view civil war is a struggle between two parties occupying substantially the same geographical limits for the possession of the government, each claiming to be the legitimate party. Rebellion, on the other hand, in its advanced stage (or insurrection, according to the second view propounded above), is the attempt of a section of the people to overthrow the government or its authority with a view to replacing it by another of a different type, or for the purpose of constituting a separate nation with a separate sovereignty. Finally, there is the distinction between rebellion and revolution, which may be summed up as the difference between failure and success.

Every person who engages in rebellion is liable to the criminal penalties for treason established by the government against which he rebels and he is dealt with by the ordinary civil authorities, but when the rebellion becomes so widespread as to embrace a vast majority of the inhabitants of a considerable portion of the country, and when the rebels have succeeded in establishing a government and raising an army or navy, and especially if they have won recognition as bel-

ligerents from foreign nations with the rights incident thereto, those who are captured are usually treated as belligerents in conformity with the rules of civilized warfare. While endeavoring to enforce its constitutional rights against armed rebellion, a nation has all the powers, not only of a sovereign, but also of the most favored belligerent. The Constitution of the United States authorizes Congress to provide for calling out the militia to suppress insurrections, and Congress has done so by empowering the President to call upon the militia whenever in his judgment danger from rebellion requires that step. The Supreme Court has decided that the President is the sole judge as to when the exigency shall have arisen. In pursuance of this authority the President has called out the militia three times in our history—namely, in 1794, to suppress the Whisky Rebellion in Pennsylvania; in 1812, to repel the British invasion; and in 1861, to suppress the insurrection in the Southern States.

REBELLION, WAR OF THE. See CIVIL WAR IN AMERICA.

REBENSTEIN, rä'b'en-stĕin, A. The pseudonym of the German author Aaron Bernstein (q.v.).

REBER, rä'bĕr, FRANZ VON (1834—). A German art-historian, born at Cham, Bavaria. After studying in Munich and Berlin he went to Rome, and in 1858 established himself as lecturer at the University of Munich, was appointed professor at the Polytechnicum there in 1863 and director of the Royal Gallery in 1875. His writings include: *Die Ruinen Roms und der Campagna* (2d ed. 1879); *Geschichte der Baukunst im Altertum* (1864-67); *Kunstgeschichte des Altertums* (1871; trans. and supplemented by Clarke, New York, 1882); *Geschichte der neueren deutschen Kunst* (2d ed. 1884); *Kunstgeschichte des Mittelalters* (1886; trans. 1887); *Geschichte der Malerei vom Anfang des 14. bis zum Ende des 18. Jahrhunderts* (1894); and *Die phrygischen Felsdenkmäler* (1897). He translated the ten books of Vitruvius on *Architecture* (1865) and the *History of the Antwerp School of Painting* by Rooses (1880).

REBER, rä'bär', NAPOLÉON HENRI (1807-80). A French composer, born at Mühlhausen, Alsace. He studied with Reicha and Le Sueur, wrote chamber-music, and set to music the new songs of the best French poets. He became professor of harmony at the Conservatory in 1851, and succeeded Halévy as professor of composition in 1862. He was inspector of the branch conservatories from 1871 and elected to Onslow's chair in the Académie in 1853. Among his works are: A ballet, *Le diable amoureux* (1840); the comic operas, *La nuit de Noël* (1848), *Le père Gaillard* (1852), *Les papillotes de M. Benoist* (1853), and *Les dames capitaines* (1857). His instrumental works, which are written in the spirit of the German classics, consist of four symphonies, one overture, and one suite for the orchestra, three stringed quartets, one stringed quintet, one pianoforte quartet, seven pianoforte trios, and pieces for the pianoforte and violin. For the voice he wrote thirty-three songs with pianoforte accompaniment, a *Chœur de pirates*, *Le soir*, an *Ave Maria* and *Agnus Dei* for two sopranos, tenor, bass, and organs, besides

Vocalises for soprano or tenor. His *Traité d'harmonie* (1862) ranks among the best modern works on theory and has been reprinted several times. He died in Paris.

REBMANN, räb'män, JOHANNES (1820-76). A German missionary and African explorer, born at Gerlingen, Württemberg. He was sent by the British Church Missionary Society to Mombasa, East Africa, as an assistant to Krampf, with whom in 1849 he discovered the mountains Kilimanjaro and Kenia. Rebmann spent thirty-eight years in Africa and acquired considerable knowledge of several of the native languages. He published a *Dictionary of the Kinyassa Language* (1877) and a map of East Africa (1856).

REBOLLEDO, rä'bó-lyä'bó, BERNARDINO DE, Count (1597-1676). A Spanish poet, born at Leon. From his youth he was a soldier and fought against the Turks and in Barbary and in the Thirty Years' War. He was made Ambassador to Denmark (1647) and afterwards to Sweden, and lived for several years in the north. In 1663 he was appointed Minister of State, a post he held until his death. His works include: *Ocios* (1650), a poem; *Selva militar y política* (1652), a didactic poem; *La constancia victoriosa* (1655), and some epistles, epigrams, and excellent ballads. His style is prosaic, but it is simple and usually unaffected. The three-volume edition of his works (Madrid, 1778) contains a biography.

RECALESCENCE. See HEAT.

RÉCAMIER, rá'ká'myá', JULIE, Madame (1777-1849). A famous French leader of society, born at Lyons. In 1793 she married a wealthy but aged Parisian banker, Jacques Récamier, and his wealth enabled her to shine in society. Her *salons* became famous as the rendezvous of the foremost writers and thinkers of the time. For Madame de Staël she had a great and lasting regard, and in 1806, after M. Récamier was ruined, she was the guest of Madame de Staël at Coppet, in Switzerland. In 1811 Napoleon ordered her to leave Paris on account of her political views, and she then resided for several years in Switzerland. In 1815, however, she returned to Paris and established herself in the Abbaye-aux-Bois, where her beauty and charm made her the centre of a group of the brilliant men and women of the time. Châteaubriand, Balanche, and others were her friends and admirers. The only suitors for her hand toward whom she evinced any partiality were Prince August of Prussia and later Châteaubriand. The history of their efforts to win her in marriage is well known, but though her husband died in 1830, she remained a widow until her death. Consult: *Souvenirs et correspondance tirés des papiers de Mme. Récamier* (Paris, 1859); Mme. Lenormant, *Madame Récamier* (ib., 1872); Brunier, *Vie de Madame Récamier* (ib., 1875); English translations of first two of these (Boston, 1867 and 1869); Châteaubriand, *Mémoires d'outre tombe*, vols. 8-10 (Paris, 1848).

RECANATI, rä'ká-nä'té. A town in the Province of Macerata, Italy, situated on a hill between the Musone and the Potenza, 15 miles south of Ancona (Map: Italy, II 4). It has a fourteenth-century Gothic cathedral, a statue of the poet Leopardi, a library, and a new town hall. There are manufactures of silk, and wine and

olive oil are made. Population (commune), in 1881, 19,524; in 1901, 15,586.

RECAPITULATION THEORY (Lat. *recapitulatio*, from *recapitulare*, to recapitulate, from *re-*, back again, anew + *capitulum*, chapter, diminutive of *caput*, head), or BIOGENETIC LAW. A statement of the fact that the development of the individual is an epitome of that of the order or class to which it belongs. The basis of the law or principle is the well-grounded view or assumption now universally held by biologists that all animals have had a common ancestry, proved by the fact that all the animals whose embryological development has been carefully studied pass through stages or temporarily inherit structures or states of structures which are permanent in and characteristic of the more primitive or ancestral members of the class to which they belong. Compare PALINGENESIS. See BIOGENESIS.

RECAPTURE. In international law, a term having reference to the retaking by an armed vessel of one belligerent or its ally of a prize captured by a vessel of the other belligerent from a subject or citizen of the first. To adjust the conflicting rights of original owner and recaptor, a legal fiction, the *jus postliminii* of the Romans, was devised. According to this rule the title to property recaptured from an enemy in war was reverted in the original owner upon payment of salvage to the recaptors. The rights of persons recaptured from the enemy were restored upon the payment of a certain sum. The amount of salvage is determined by a prize court in accordance with the law of the State to which the recaptor belongs. The law of the United States recognizes the principle of reciprocity as regards the amount paid foreign vessels recapturing American vessels from the enemy. With regard to salvage allowed domestic recaptors, the law prescribes from one-twelfth to one-half the value of the prize, according to the difficulty involved in making the recapture and the character of the vessel. The law of France allows one-tenth; that of England, one-eighth; that of Spain, one-eighth to one-sixth; Denmark, one-third; Sweden, one-half. According to the practice of the United States salvage is not allowed if the recapture takes place after condemnation by a prize court, since the title is regarded as having passed from the original owner to the captor, and if sold by the court, the title of the purchaser is incontestible. The English practice is to restore the recaptured property to the original owner upon payment of salvage without regard to the time of recapture.

RECEIPT (OF. *reccete*, *recepte*, Fr. *reccette*, from ML. *recepta*, receipt, fem. sg. of Lat. *receptus*, p.p. of *recipere*, to receive, from *re-*, back again, anew + *capere*, to take). The transaction by which one takes into his possession or custody property delivered to him by another. It is also the technical name for an acknowledgment of the receipt of property executed in writing by one who has taken the property into his possession or custody.

A written receipt is evidence only of the fact that money or property was received by the persons executing it. It does not differ in legal effect from any other evidence of the fact of receipt, although it may be more conclusive than mere verbal testimony. A written receipt may accordingly be explained or contradicted by other

evidence and will have no effect if fraudulently procured or untrue in fact. It is owing to its character as evidence that a receipt is to be distinguished from a release (q.v.), which operates as a discharge or extinguishment of a legal obligation. In a few States, however, notably New York, it has been held that a simple receipt, when given with intent to extinguish a debt, would be deemed a gift of the debt although given without consideration and would thus extinguish the debt. This is anomalous, inasmuch as a receipt is evidence only and not a contract. A receipt is not subject to the parol evidence rule. (See EVIDENCE.) It may, however, be incorporated in a contract, as in the case of bills of lading (q.v.) or warehouse receipts (q.v.), which may and usually do contain both a receipt for the goods delivered to the carrier or warehouseman and a contract fixing the terms of the bailment. So far as the bill of lading or warehouse receipt is a contract it is subject to the parol evidence rule and cannot be contradicted by oral testimony; but its effect as a receipt may be explained or contradicted by such testimony. This rule, however, varies when the bill of lading or warehouse receipt has been indorsed to an innocent holder for value. The carrier or warehouseman will then be estopped to deny the receipt as written. It seems probable that one delivering property or paying money in performance of a legal obligation may not lawfully demand a receipt as a condition of the performance of his obligation. The question, however, is not settled. Receipts are required by statute to be given in some cases. Consult the authorities referred to under CONTRACT.

RECEIVER (OF. *receveur*, *receveur*, Fr. *receveur*, from *recevoir*, to receive, from Lat. *recipere*, to receive). An indifferent person between the parties to a litigation appointed by a court of equity to take charge of and preserve property or money involved in the litigation, and to collect the rents, issues, and profits thereof pending a final disposition of the controversy. A receiver is an officer of the court. Property placed in his care is regarded as being *in custodia legis*, to be administered by him under direction of the court; and it thus is not subject to other judicial process, and jurisdiction cannot be acquired over it by other courts having concurrent jurisdiction over the subject of the suit. See JURISDICTION.

The appointment of a receiver is one of the important forms of the preventive remedy exercised by courts of equity, and is of great benefit when there is danger that property which is the subject of judicial controversy may be wasted, destroyed, or removed from the jurisdiction of the court pending the litigation. By the appointment of a receiver the court insures its preservation and final appropriation as its decree may direct. As the mere legal custody of the receiver is sufficient for this purpose, he acquires no title or lien upon the property. He is a ministerial officer, and in general his powers are those only which are granted by the order or decree appointing him. If acting within his powers he has some discretion and may exercise his judgment as to the manner of their exercise. In that case he is not liable for errors of judgment, but if negligent or acting outside his authority, he is personally liable for his misconduct. When in doubt as to his powers he may apply to the court for author-

ity and directions as to their use. A creditor or other interested party may also apply to the court for modification of the order appointing the receiver or for supplementary orders to govern his conduct, or in a proper case for an order removing him. In general a receiver has no authority to sue unless directed by the court to bring an action; and action may not be brought against him without the express authority of the court. He is deemed to have implied authority to employ counsel when reasonable and proper. The powers and duties of receivers are now generally regulated by statute or to some extent by rules of court.

The following are the more important cases in which a receiver will be appointed, although the classification is not exclusive: (1) When there is no present legal owner of property involved in the proceeding, although the parties to the litigation are equitably entitled to it, as in case of an intestate's personal property. The same relief is now generally obtained by the appointment of a temporary administrator. (2) When the legal owner is incompetent to manage his property, as in case of infancy or lunacy, and there is no guardian or commission having legal authority to protect the property. In most jurisdictions guardians of infants and committees of lunatics have statutory authority sufficient to render the appointment of a receiver in such cases unnecessary. See GUARDIAN. (3) When the litigants are equally entitled to the custody of the property and justice requires that neither one should be permitted to control it to the exclusion of the other, and circumstances do not permit their joint control, as in the case of the dissolution and winding up of a partnership or the partition of real estate. (4) When the title or possession of property is held by one in a fiduciary capacity or relation who is not properly performing his trust, as a mortgagor in an action to foreclose a mortgage, a trustee in an action for an accounting, or one having property claimed in a judgment creditors' action. (5) When the appointment of a receiver is necessary to assist in carrying out the decree of the court, as where in judgment creditors' actions, in order to satisfy the judgment, a receiver is required to sell the property conveyed in fraud of creditors.

The appointment of a receiver is always a matter within the discretion of the court and cannot be claimed as an absolute right. Often the propriety of granting an application for a receiver is a matter of great delicacy and importance, requiring the highest judicial capacity.

Courts of equity would not exercise their jurisdiction to appoint a receiver for an insolvent corporation merely because it was insolvent. Statutory jurisdiction is now generally given for that purpose and in many other cases where it was formerly not the practice to grant relief by the appointment of a receiver. Thus, for example, statutes now authorize the appointment of receivers to take charge of assets in the winding up of corporations; to preserve the estate of a bankrupt pending bankruptcy proceedings; to receive sums due on judgment debts and apply them to the payment of the judgment; and in many other cases.

The expenses of the receivership, including the receiver's own fees, are a first lien on the property held by him as receiver. In some cases the court will authorize a receiver to raise money for the

purpose of preserving the property and continuing it in business by issuing receiver's certificates, which are made a first lien on the property. This will ordinarily be done only when some public interest will be subserved by the continuance of the property in business, as in the case of railroads or other public-service companies. Such certificates, when issued, are non-negotiable securities, payable out of the fund in the receiver's hands. They create no personal liability and their validity depends upon their compliance with the order authorizing their issue. If issued below par the holder can recover only the amount actually received for them by the receiver unless he was authorized to issue them at a discount. One who indorses a receiver's certificate does not become liable as an indorser of negotiable papers, but as a mere assignor only. The holders in general will not be allowed to sue upon them, but may in a proper case obtain an order of the court directing their payment. See CHANCERY; EQUITY. Consult: High, *Treatise on the Law of Receivers* (3d ed., Chicago, 1894); Short, *Railroad Bonds and Mortgages* (Boston, 1897); Cababé, *Receivers by Way of Equitable Execution* (3d ed., London, 1900); Kerr, *Treatise on the Law and Practice as to Receivers* (4th ed., ib., 1900).

RECEIVING SHIP. In the United States Navy, vessels are stationed at each navy yard for the enlistment of men and to furnish quarters for men from the time of their enlistment until drafted into sea-going ships. While on board these receiving ships the men are drilled and trained as far as the time of their retention and other circumstances will permit. On some receiving ships there are schools for yeomen (ship's clerks), petty officers, etc.

RECEIVING STOLEN GOODS. A criminal offense which consists in taking possession or control of stolen goods with a guilty knowledge of the fact and with the fraudulent or dishonest intention of continuing to deprive the rightful owner of the possession of his property. By the early common law in England, the offense was merely a misdemeanor, but by statute it has been made a felony. In the majority of the United States it is a distinct criminal offense, classed as a felony, and is punishable with about the same severity as larceny. A number of States classify the offense under the general head of larceny. Consult the authorities referred to under CRIMINAL LAW.

RECENT PERIOD (Lat. *recens*, fresh, new). In geology, the name given to the epoch that has elapsed since the Pleistocene and the beginning of history. Many geologists now include it under the Pleistocene period (q.v.).

trace with any definiteness either their origin or history. According to II. Kings x. 15-28, Jehoradab, the son of Rechab, displayed great zeal for the Yahweh worship in the days of Jehu. In the days of Jeremiah the Rechabites are found in Judah and they took refuge in Jerusalem when Nebuchadnezzar invaded the land (Jer. xxxv.). In Nehemiah iii. 14, Malchiah, the son of Rechab, is mentioned as one of those who assisted in rebuilding the walls of Jerusalem. The Rechabites represent the extreme conservative element of the Hebrew and allied clans which maintained the old nomadic customs and rites and opposed the higher forms of culture. They continued to live in tents, and their antagonism to agriculture manifests itself in their scruples about drinking wine (Jer. xxxv. 6-10), which in the ancient Orient was a symbol of agricultural fertility. This element was probably not limited to any single clan; the same conservative tendency appears in various incidents in the Old Testament. For example, in the narrative of Cain and Abel a distinct preference is shown for Abel, the pastoral nomad, over Cain, the agriculturist. And again in Genesis ix. 20-27 the Rechabite point of view is represented in the story of Noah and the vineyard which he planted. Consult the Old Testament theologies of Oehler, Schultz, and Dillmann; also Smend, *Alttestamentliche Religionsgeschichte* (Freiburg, 1893); Robertson Smith, *Religion of the Semites* (2d ed., London, 1894); Bennett, *Commentary on Jeremiah* (ib., 1895); Budde, *The Religion of Israel to the Exile* (New York, 1899).

RECIDIVISTS (from Lat. *recidivus*, falling back, from *recidere*, to fall back, from *re*, back again, anew + *cadere*, to fall). The term applied in penology to those who have been more than once sentenced for crime, i.e. old offenders. It is a striking commentary on the effectiveness of penal systems that according to official returns from the leading nations of the world the recidivists are 40 per cent. or more of the prison population. Z. R. Brockway estimated the percentage in the prisons of New York at not less than 60; while W. D. Morrison, of England, estimates that the percentage is not less than 70. It is even possible to find an individual who has been arrested 1000 times, while in the large cities, even of America, individuals who have served more than 100 short sentences are by no means unknown. H. M. Boies estimates that "at least two-thirds of the crimes in America are committed by recidivists and that the yearly cost of their incarceration could be estimated at \$400,000,000."

Yvernes in his work, *La Récidive en Europe*, gives the following table:

RELAPSED	England, 1871	Sweden, 1871	France, 1826-74	Italy, 1870	Scotland
	<i>Prisoners</i>	<i>Thieves</i>	<i>Tried</i>	<i>Tried</i>	
Once	38%	54%	45%	60%	16%
Twice	18%	28%	20%	30%	13%
Thrice	44%	18%	35%	10%	

RECHABITES, rēk'á-bīts (Heb. *Rēkābīm*, from *Rēkāb*, Rechab). A Kenite clan (see KENITES) who retained their nomadic habits and mode of life in the midst of agricultural Palestine. The notices of them in the Old Testament are too few to make it possible to

According to the census of 1890 the percentage of recidivists in the United States was 26.42. This is undoubtedly far too low, as criminals in America conceal their identity by passing from State to State. None of the foregoing figures can be accepted as absolute, and comparisons between

countries are unsatisfactory because of varying laws and differing degrees of success in enforcing them. The statistics serve roughly to show that recidivism is a serious aspect of crime and to throw light on the practical question of crime prevention.

Drähms has figured from various sources the percentage of recidivists in the different countries as follows:

	Year	Percentage
England.....	1897	56
Germany.....	39.7
Holland.....	44
France.....	1895	41
Belgium.....	1898	39
Norway.....	1895	50
Prussia.....	1898	82

It is clear that short sentences and fines do not protect society against instinctive and professional criminals. Nothing short of permanent incarceration should be thought of in many instances. In others where the possibility of reform may still be admitted the indeterminate sentence may wisely be employed. In England the Habitual Offenders Act deprives the recidivist of the presumption of innocence until guilt is proved and keeps him under surveillance when not in prison. A few timid experiments have been made here and there by American commonwealths in the direction of greater severity toward 'second offenders,' but in general American law on this subject is lax and unscientific. Sentimentalism, indifference, and a prevailing belief (which has no basis in fact) that criminals in general are victims of circumstances and may usually be 'reformed' by humane treatment, have made the United States a veritable paradise of professional offenders. Consult: Yvernes, *La récidive en Europe* (Paris, 1874); Wines, *Punishment and Reformation* (Boston, 1895); Drähms, *The Criminal* (New York, 1900). See CRIMINOLOGY; PENOLOGY.

RECIFE, rá-sê-fá. The capital of the State of Pernambuco, Brazil. See PERNAMBUCO.

RECIPROCAL (from Lat. *reciprocus*, alternating, reciprocal, probably from **recus*, backward, from *re-*, back again, anew + *procus*, forward, from *pro*, before). One number is said to be the reciprocal of another if their product is unity. E.g. $a \cdot \frac{1}{a} = 1$, hence a and $\frac{1}{a}$ are reciprocals. Also $\frac{a}{b} \cdot \frac{b}{a} = 1$, hence $\frac{a}{b}$ and $\frac{b}{a}$ are reciprocals. The term is variously used in geometry. See POLE AND POLAR; DUALITY.

RECIPROCAL EQUATIONS. An equation is said to be reciprocal when its roots admit of being arranged in pairs of the form $r, \frac{1}{r}$. In the case of a reciprocal equation of even degree the coefficients of the terms equidistant from the extremes are equal and have the same sign. In the case of those of odd degree, the coefficients of the terms equidistant from the extremes have the same absolute value and have either the same or opposite signs. One root of a reciprocal equation of odd degree must therefore be +1 or -1. Dividing by $x \pm 1$, such an equation reduces to one of even degree.

RECIPROCITY (from Lat. *reciprocus*, alternating, reciprocal). A tariff policy under which two or more sets of tariffs contemporaneously exist; a high schedule of duties for countries which have entered into no special agreement with the enacting country, and one or more lower schedules for such others as may be willing to offer correspondingly reduced schedules in return. The reciprocity system sprang up as a means of relief from the old navigation laws, and was then gradually extended, not only to tariff duties, but to general matters of commercial privilege as well. The organization of the German Zollverein (q.v.) gave a strong stimulus to the idea of mutual freedom of exchange; and the movement thus begun gradually developed into a semi-free-trade era, which lasted until about 1870. Great Britain repealed the corn laws during the years succeeding 1846, and in 1860 negotiated a treaty with France containing liberal commercial concessions. This was followed by some twenty-seven other reciprocal arrangements between the leading European States, which resulted in great freedom of exchange, and largely stimulated trade. A similar movement in the United States culminated in the liberal tariffs of 1846 and 1857. Very generous treaties of reciprocity were negotiated by the United States with the German Zollverein and Mexico, respectively (1844 and 1859), but both failed of ratification.

The first real experiment in reciprocity made by the United States is found in the Canadian treaty of 1854. Between the years 1846 and 1855, it was several times sought to secure the passage of 'concurrent legislation' by the two countries, making mutual tariff concessions. These efforts failed—partly for political reasons, but largely because of difficulties connected with the allied questions of fisheries and the navigation of the Saint Lawrence. Finally, the reciprocity treaty was negotiated, and passed by the Senate (receiving the President's signature August 5, 1854), owing largely to personal work in Washington by Lord Elgin, then Governor-General of Canada. As ultimately adopted, the Canadian treaty covered the navigation of the Saint Lawrence, the fishery question, and provided for mutual free trade between Canada and the United States in the products of the two countries. The immediate effect of the treaty was apparently to stimulate trade. Its popularity, however, received a severe blow in the crisis of 1857, which reduced both the imports and exports of the United States in the Canadian trade, but the volume of business almost immediately revived. Various complaints, however, arose against continuing under the treaty, a principal objection being that the Canadians were not keeping good faith. Commissioners of the United States examining into the advisability of the reciprocity relations made diametrically opposite reports. Between 1860 and 1865, the question of abrogating the treaty was much discussed in Congress. The strained relations with England on account of the *Alabama* claims brought the question to the front and finally, in 1865, a Senate resolution terminating the agreement was concurred in by the House, being signed by the President January 18, 1865. The relations of the United States with Canada under the treaty closed March 17 of the same year. Since that time numerous efforts have been made to renew the reciprocity trade relations between the two

countries; in 1866 by a Canadian delegation; in 1869 by Sir John Rose; in 1873 by George Brown and Sir Edward Thornton, and in 1890-92 by Hon. Robert Bond, all with no result. So also various bills and resolutions for reciprocity with Canada were tabled or voted down in Congress from time to time. Attempted amendments to tariff bills met the same fate. The most recent development in the struggle for better trade relations with Canada has been the appointment of the 'Joint High Commission,' which was to settle all points in dispute between the two countries, including reciprocity. Its work has thus far had no result.

An important experiment in reciprocity was undertaken in the treaty of 1875 between the United States and Hawaii. The plan of annexing the Hawaiian Islands had been brought forward several times before 1875, and one or two abortive efforts to secure a reciprocity treaty with them had been made. What finally forced the question upon the attention of Congress was the growing power of England in the Pacific, and the development of British trade with the islands, added to the fact that American citizens had acquired large holdings of land in Hawaii, and were desirous of receiving discriminating trade advantages. The signal for action was given by internal disturbances in the islands in 1874, and the accession of a king strongly favorable to American interests. A treaty was finally negotiated and was signed by the President April 17, 1875, going into effect June 30. A bill to make the modifications of duties rendered necessary by the treaty was brought up and passed in the House of Representatives. By this treaty the United States admitted, free of duty, sugar and a few tropical products, including rice, while Hawaii relieved of duty various kinds of agricultural and meat products as well as machinery and other manufactures. At the time the treaty was adopted, our imports from Hawaii amounted to about \$1,300,000 annually, our exports being a little over \$600,000. No reduction in the price of sugar resulting, there naturally occurred a great increase in the price of sugar lands in Hawaii and a great growth in exports of sugar to the United States. This meant, of course, a corresponding loss of duties to our Government without any compensating growth of exports to the islands. Our imports were \$4,606,444 in 1880, \$8,887,497 in 1885, \$12,313,908 in 1890, \$7,888,961 in 1895, and \$17,187,380 in 1898; as against exports of \$2,086,190, \$2,787,922, \$4,711,417, \$3,723,057, and \$5,907,155 during the same years. Most of the imports were of sugar, and it was estimated that the duties lost to the United States during the life of the treaty ranged from \$2,000,000 to \$12,000,000 a year. In 1883 the question of renewing the treaty (first concluded for seven years) came up in Congress and strong opposition to it was shown; but a new agreement was finally ratified and put into effect (December 7, 1887). The growth of hostile feeling displayed during this reciprocity struggle had, however, alarmed the sugar interests, who now began to fear the ultimate abrogation of their reciprocity privilege. This fear led to a vigorous annexation movement in the islands, resulting eventually in the annexation of the islands in 1898.

During the decade 1880-1890 reciprocity first

began to be advocated in the United States as a definite tariff policy. The revision of the tariff by the Republicans in 1833 was unsatisfactory to the manufacturers, who were beginning to build up an export trade, and who wanted larger foreign markets. In 1883 a treaty was negotiated with Mexico, and in 1884 one with Spain for Cuba and Porto Rico, and another with Santo Domingo, were arranged, but they were all either killed or withdrawn by President Cleveland. In 1884 President Arthur, under authority from Congress, sent a commission to visit the South American countries and discuss the question of reciprocity with their governments. On its return, a report was made by the commission in which tariff reductions on wool and sugar were laid down as a necessary basis for reciprocity with South America, and practical failure in negotiations was reported as a result of the commission's lack of power to hold out promises of such concessions. About this time President Cleveland took office (1885) and sought to secure general tariff revision, in place of further efforts to get reciprocity treaties. A Republican majority, however, appeared in the Congress which met in 1889, and that party concluded to act upon the recommendation made by the South American commission that a Pan-American congress be summoned to discuss trade relations. Such a congress met in 1889 at Washington, under the title of the "International American Conference." This body favored reciprocity, but indicated that tariff treaties must be based upon real reductions of duty on important articles. Many delegates expressed great doubt as to the intentions of the United States in this respect, and the general result of the conference was rather discouraging.

A considerable surplus had been accumulated in the national treasury during the first Cleveland administration, and it was desired by the Republicans on coming into office in 1889 to reduce incomes without lowering the tariff in general. This was done by the McKinley Act (1890), which admitted raw sugar free of duty, and offered a bounty to domestic sugar-growers. At the same time, it was sought to appease our exporters (who wanted larger markets) by using the reduction of sugar duties as a means of forcing corresponding reductions in foreign tariffs. This attempt was made in Sec. 3 of the McKinley Act, known as the reciprocity section, in which the President was ordered to impose specified duties upon raw sugar, molasses, coffee, tea, and hides, otherwise to be admitted free, unless the countries of origin should grant us compensating tariff concessions. These provisions had been brought about largely through the efforts of Mr. Blaine, who regarded some concessions to our agricultural and exporting interests as a political necessity. The principal article included in the reciprocity section was, of course, sugar; and this was admirably adapted for use as a basis for tariff bargaining, because of the sugar bounty system of Europe. The bounty system had resulted in tremendous overproduction of sugar and had thus led to a great desire to find outside free markets for it. In the debate on the McKinley reciprocity section the meaning of the policy was explained with greater fullness than ever before. It was shown (1) that the products admitted to the United States must not compete with those

produced by us; (2) that the countries traded with must be such as would take our surplus of manufactures and farm produce; and (3) that the volume of trade gained by us under any agreement must be fully equivalent to that granted to the foreign country. The McKinley Act was adjudged constitutional by the Supreme Court (*Fields vs. Clark and Boyd vs. U. S.*) and Mr. John W. Foster, representing the State Department, negotiated treaties under it with Brazil, Spain for Cuba and Porto Rico, and England for Jamaica, Trinidad, Barbadoes, Guiana, and the Leeward and Windward Islands. Treaties were also signed with Santo Domingo, Guatemala, Salvador, Costa Rica, Honduras, and Nicaragua. These treaties closely resembled one another and were designed to carry out the idea of South American reciprocity. They all included reductions of duty on live animals, some grains, corn, meat products, bridge-building materials, cottonseed and its products, cars, wagons, etc., railway material, timber and iron for ship-building, and engines. Colombia, Haiti, and Venezuela declined to make tariff treaties; and President Harrison, therefore, enforced against them the retaliatory duties provided in the McKinley Act. Treaties of a rather different sort were negotiated with Germany and Austria-Hungary, by which we secured some reductions on certain cereals, meat products, flour, etc., and on sundry manufactures of cotton, wool, chemicals, and machinery. These were the so-called 'beet-sugar treaties.' Little effect could be seen as a consequence of the reciprocity treaties, but it should be noted that during the life of these agreements trade conditions all over the world were much disturbed, so that the period was not a good one for observing their working. In general, their effects were slight and confined to a few countries, while imports were more largely stimulated than exports. So far as the latter grew at all, the increase is found in cereals, iron, steel, etc.

The accession of President Cleveland to office for the second time (1893) was the signal for an effort to reduce the tariff. A bill introduced by William L. Wilson for this purpose retained raw sugar on the free list as well as coffee, tea, and hides, and reduced the bounty to domestic growers. In the Senate, however, the tariff on raw sugar was restored. It had not been intended by Mr. Wilson to interfere with the existing reciprocity treaties, although he did intend to repeal the section granting power to impose retaliatory duties. The re-imposition of the sugar tariff, however, *ipso facto* abrogated the treaties, and protests were filed by the representatives of Germany and Austria, while complaints were made by Brazil, Guatemala, Nicaragua, Costa Rica, and Santo Domingo. Trade, however, does not appear to have been materially affected by the abrogation of the reciprocity treaties, save in one or two unimportant cases. In some instances an improvement in trade followed. One of the first acts of the Republicans, as they gradually regained power after the passage of the Wilson bill, was to announce their allegiance to reciprocity as a policy. A crop of bills and resolutions on the subject came up in the first session of the Fifty-fourth Congress and were referred to the House Committee on Ways and Means.

The Republican victory of 1896 was interpreted as a verdict in favor of higher tariff duties and

of reciprocity treaties. A bill providing for both had been drafted, and was early introduced, by Mr. Dingley. In this bill as first presented, reciprocity, like that of the McKinley Act, was contemplated. The original draft offered moderate reductions of duty upon various commodities, but while the bill was under debate an amendment was offered authorizing the President to negotiate reciprocity treaties which should later be ratified by the Senate. As finally passed, the act thus authorized the Executive to conclude treaties based upon a few unimportant commodities and to negotiate such other reciprocity treaties as he might deem appropriate for submission to the Senate. President McKinley, under this act, appointed Hon. John A. Kasson special commissioner for the negotiation of reciprocity treaties. Treaties were negotiated and proclaimed with France, Portugal, Germany, and Italy. Later, an arrangement with Switzerland was executed. No agreements with South American countries were entered into. The treaties with the European countries mentioned gave us favorable treatment for a few agricultural products, oils, and some machinery. These reciprocity treaties are the only ones now in operation. Mr. Kasson, however, negotiated treaties with various countries under the clauses of the Dingley Act, authorizing the President to secure such agreements as he might deem best for submission to the Senate. These 'Kasson treaties' included treaties with France, Great Britain on behalf of Barbadoes, British Guiana, Turks and Caicos Islands, Jamaica, and Bermuda, Denmark for Saint Croix, and with Ecuador, Nicaragua, and Santo Domingo. These had nearly all been sent to the Senate by the end of 1899. They were coldly received and referred to the Foreign Relations Committee. The treaties with South American countries were chiefly concerned from our side with reductions of duty on cane sugar and tropical fruits, wool, and a few other products, that with France made some concessions on knit goods, bric-à-brac, cheap jewelry, cutlery, and similar small articles. None of them was seriously discussed except that with France, and even in that case, so loud a protest was raised by manufacturers who conceived their interests to be attacked that the treaty was pigeonholed. It was, however, very generally conceded that the terms of this agreement were unexceptionable. A general reciprocity discussion began in the newspapers, and protectionists displayed a strong disposition to repudiate the whole reciprocity policy. It was more and more felt that danger inhered in the discussion of such treaties, because of the probability that they would make a breach in the protection system which might lead to too general tariff revision. This opinion was distinctly voiced in the so-called 'reciprocity convention' of manufacturers, which met in Washington in October, 1901. President McKinley, however, seemed inclined to recede from his advanced protectionist position, and in a noteworthy speech at the Buffalo Exposition, just prior to his assassination, in September, 1901, had taken strong ground for reciprocity. This gave a factitious impetus to the reciprocity movement which ultimately concentrated its strength in an effort to secure reciprocity with Cuba.

No treaty with Cuba had been negotiated by Mr. Kasson. This was due to the fact that the

war and subsequent negotiations with Spain lasted during the time that his reciprocity negotiations with the various countries were in progress. After the United States had assumed control of Cuba, it imposed upon the constitutional convention of the Cubans the so-called Platt Amendment, which was passed, after much opposition, partly on the strength of an alleged promise made by President McKinley to a delegation of Cubans that, should the amendment be accepted, he would secure a large tariff reduction for Cuban sugar exported to the United States. President Roosevelt attempted to fulfill this supposed promise by urging Cuban reciprocity upon Congress at the session 1901-02. A bill providing for a mutual 20 per cent. reduction of duties on Cuban and American products was introduced in the House of Representatives, but met with strong opposition from those representing beet-sugar interests, which had sprung into prominence subsequent to 1890. These men charged that the advocates of reciprocity with Cuba were playing into the hands of the refining combination, which, it was said, had bought largely of Cuban lands and was seeking to secure cheap raw material through reciprocity. As a compromise it was proposed to grant the desired reductions, provided that the protection accorded under the Dingley Act to the process of refining (sugar 'differential') should be revoked. Such an amendment was incorporated into the reciprocity bill and it was passed by the House. The Senate, however, objected to the amendment and the bill was killed in committee. The autumn elections (1902) strengthened the Administration. During the recess a reciprocity treaty was negotiated with Cuba and placed before the Senate at the session 1902-03. Although nothing was then done, a special session of the Senate in the spring of 1903 passed the Cuban treaty. In its original form, it secured important reductions on American agricultural and manufactured products exported to Cuba in return for the concession of 20 per cent. on Cuban imports to the United States, but the beet-sugar interests contrived to have it amended by a clause providing that no reductions should be granted to any but Cuban sugar during the life of the treaty. This stipulation necessarily implied the destruction of all prospect of passing the other treaties negotiated by Mr. Kasson with South American countries, inasmuch as these were largely based on sugar. Meantime, Secretary Hay had negotiated (October-November, 1902) a reciprocity treaty with Newfoundland whereby certain of our products were to be admitted to that colony in exchange for bait privileges for our fishing vessels in Newfoundland ports. This treaty was pigeonholed during the session 1902-03, owing to the influence of New England fishing interests. During the years 1902-03 an unusually strong agitation for reciprocity with Canada sprang up in the Northwest and in New England. This was due to the growing need for cheap lumber, ores, and coal along the northern boundary of the United States.

At the present time reciprocity in Europe has assumed a somewhat different form from that which has been developed in the United States. That is primarily due to the interpretation put upon what is known as the 'most-favored nation clause' in international agreements and which differs from the meaning assigned to that clause in

American diplomacy. According to European usage, treaties incorporating the 'most-favored nation clause' assure to the signatory countries treatment as favorable as that granted to any other nation. Tariff concessions made to others become at once common to all nations having 'most-favored' relations with the country making such concessions. On the other hand, American statesmen have adhered consistently to the view that trade concessions offered by it to some other country need not become common to a third country unless that third country grants concessions similar to those of the second country. It has been noted that under the European view of the most-favored nation clause the reciprocity treaties adopted subsequent to 1860 inaugurated an era of very free trade. This was terminated shortly after 1870, owing partly to the desire to increase national customs revenues, and partly to the hostilities engendered by war and political struggles. Elaborate tariffs were adopted by most European countries between 1870 and 1885. These gradually developed into two principal systems—that of 'general or conventional' tariffs and that of 'maximum and minimum' tariffs. The former is the plan adopted by Germany, Austria, Switzerland, and Italy, while the latter is pursued by France, Russia, Spain, Norway, Greece, and Brazil. Under the general or conventional tariff system, a higher schedule is applied to those countries which have entered into no special commercial arrangement, while another or 'conventional' tariff is granted to those which receive favored-nation treatment. Under the maximum and minimum system minimum rates are given to most-favored nations, and the home produce is thus assured fixed protection. Maximum rates, or such others on such articles as the Executive may see fit, are enforced against nations not receiving favored-nation treatment, and the Executive is allowed to bargain with these other countries for mutual tariff concessions. The latter system is of course more flexible than the general or conventional tariff. As against these methods, which might be regarded as general reciprocity, our reciprocity system must be placed in the light of a series of special bargains based on no systematic plan. Reciprocity in Europe to-day is represented by the network of commercial treaties existing under these two systems. These have become exceedingly complex and interdependent. Whereas the older notion of reciprocity seemed to be based on mutual concession, the essential idea of the policy to-day seems to be that of retaliation. A movement for higher and higher retaliatory duties seems to be growing very general in Europe, while the introduction of such a system is vigorously urged in England, the classic country of free trade. This is shown by Mr. Chamberlain's proposal in the early summer of 1903 for an Imperial customs tariff, or reciprocity, union between the colonies and the mother country, which would simply mean lower colonial tariffs to English exports, in exchange for retaliatory English tariffs against foreign products competing with those of the colonies. The difficulty, of course, lies in the danger of making food dearer in Europe. It is to be observed that so soon as reciprocity becomes general in scope it is indistinguishable on the one hand from the idea of tariff revision and reduction, and on the other from that of tariff retaliation. When not general in scope it implies

special arrangements carrying benefits usually to special classes in the community, at the expense of other classes.

RECITATIVE (It. *recitativo*, from It., Lat. *recitare*, to recite). A species of vocal composition which differs from an air in having no definite rhythmical arrangement, and no decided or strictly constructed melody, but approaches, in tonal succession and rhythm, to the declamatory accents of language; it is, in fact, as near an approach as possible to speech delivered in musical sounds. When any part of a recitative is to be performed in strict time, this is indicated by the words *rec. a tempo*. When a recitative is accompanied merely by a few simple chords of an instrument it is called *recitativo secco* or *parlante*, declaimed recitative. When the voice is accompanied by a considerable portion of the instruments of the orchestra, either in sustained chords or florid passages, it is termed *recitativo accompagnato*, *stromentato*, or *obbligato*. See LEITMOTIV; MELOS.

RECKE, rĕk'e, CHARLOTTE ELISABETH CONSTANTIA VON DER, usually known as ELISA (1756-1833). A German author, born on the estate Schönburg, in Courland, a daughter of Count Friedrich von Medem. In 1771 she married Baron von der Recke, from whom she was divorced six years later. Her unhappy married life and the untimely death of her daughter produced in her an inclination to mysticism and spiritualism, which was increased through acquaintance with Cagliostro, whom she met at the Court of her sister Dorothea, Duchess of Courland. In 1784, while she was living at Karlsbad, she was made aware of Cagliostro's character, and was thereupon prompted to write *Nachricht von des berühmtesten Cagliostro Aufenthalt in Mita* (1787). Her other books include *Geistliche Lieder einer vornehmen Kurländischen Dame* (1780-1815) and *Gebete und religiöse Betrachtungen* (1826).

RECKE, ERNST VON DER (1848—). A Danish poet, born in Copenhagen. His first lyric drama, *Bertran de Born* (1872), with music by P. Heise, achieved an immediate success at the Royal Theatre, and retains its popularity. His other works also show marked dramatic ability. They include: *Lyriske Digte* (1876); *Kong Liurigild og hans Sønner* (1878), a tragedy; *Knud og Magnus* (1881), a tragedy; *Fru Jeanna* (1891), an opera; and *Hertuginde af Burgund* (1891), a play. He also wrote two creditable books on Danish verse, *Principerne for den danske Verskunst*, etc. (1881), and *Dansk Versloerei kortfattet Fremstilling* (1885).

RECKLINGHAUSEN, rĕk'ling-hou'zen, FRIEDRICH VON (1833—). A German pathologist, born in Gütersloh, Westphalia. He studied in Bonn, Würzburg, and Berlin. 1852-55, graduating from the University of Berlin. He took up pathology under Virchow, and later pursued his studies in Vienna, Rome, and Paris. After serving as an assistant to Virchow in the Pathological Institute in Berlin, he became, in 1865, professor of pathological anatomy in Königsberg, whence he was called six months later to Würzburg, and thence, in 1872, to the University of Strassburg. His researches in pathology, especially of the nervous system, have been notable and valuable. Among his contributions to literature are: *Die Lymphgefäße und ihre Beziehung zum Bindegewebe* (1861); *Ueber die multiplen Fibrome der*

Haut und ihre Beziehung zu den multiplen Neuromen (1882); and "Handbuch der allgemeinen Pathologie des Kreislaufs und der Ernährung," in Billroth und Lücke's *Deutsche Chirurgie* (1883), as well as articles in *Virchow's Archiv*.

RECKONING (from *reckon*, AS. *ge-recenian*, Goth. *rahnjan*, OHG. *rĕkhanōn*, Ger. *rechnen*, to reckon; connected with AS. *raeu*, account, OHG. *rahha*, thing). In navigation, the reckoning is the calculation of the position of the ship by means of observations of heavenly bodies and the record of courses and distances sailed which is to be found in the log. *Dead reckoning* (q.v.) is where the ship's position is computed merely from the record of its movements made in the log without making astronomical observations. See NAVIGATION; SAILINGS.

RECLUS, re-kly', ELISÉE (1830—). A French geographer, born in the Gironde. He was educated in Rhenish Prussia, and subsequently studied at Montauban and under Karl Ritter at the University of Berlin. His republican principles forced him to leave France after the coup d'état of Louis Napoleon in 1851, and he then traveled in Great Britain, the United States, and South America. After his return to France in 1858, he published the results of his travels and geographical studies in several geographical works and in contributions to the *Revue des Deux Mondes* and the *Tour du Monde*. His repugnance to the Napoleonic reign induced him to join the Internationals in 1869, and, arrested as a soldier of the Commune during the siege of Paris in 1871, he was sentenced to transportation for life. Charles Darwin and other distinguished scientists united in a petition to the French Government for his recall, on the ground of the services which he had rendered to science and popular education, and in 1872 his sentence was commuted into one of banishment. He then established himself in Switzerland until he returned to France under the amnesty of 1879. In 1882, however, he was condemned with Prince Krapotkin as a leader and organizer of the anarchist movement and again fled to Switzerland. Twelve years later he was sentenced to transportation for twenty years. While in exile in Switzerland he began his masterpiece, *Nouvelle géographie universelle* (20 vols., 1874-94). This work, which was published in English under the title *The Earth and Its Inhabitants*, containing over thirty-five hundred maps, in addition to numerous engravings, is an evidence of Reclus's remarkable talent for exposition and his extraordinary scientific knowledge. Of his other geographical works, mention should be made of *La terre* (1867; 4th ed. 1877; Eng. trans., *The Earth*, 1871) and *Les phénomènes terrestres, le monde et les météores* (1872). In 1892 he became professor of comparative geography at the University of Brussels. At the outbreak of the Civil War in the United States his articles were of conspicuous value in arousing public sympathy in France for the administration of President Lincoln.

RECLUSE (OF., Fr. *reclus*, from Lat. *reclusus*, p.p. of *recludere*, to shut up, from *re-*, back again, anew + *cludere*, to close). One of a class of hermits who, from a motive of special penance, or with a view to the more strict observance of Christian perfection, remained shut up from all converse, in a cell or other place of

strict retirement. To avoid the danger of the practice ministering to mere self-will or to fanatical and unbalanced austerity, it was strictly regulated from the middle of the seventh century; and the recluse, who must be a person of tried virtue, was with due solemnity locked up in the presence of the abbot or the bishop, who placed his seal upon the door, not to be removed without the authority of the bishop himself. Nuns also were found to practice the same voluntary seclusion, especially under the rules of the Benedictine, Franciscan, and Cistercian Orders. Consult: Pavy, *Les recluseries* (Lyons, 1875); Hauber, *Leben und Wirken der Eingeschlossenen* (Schaffhausen, 1844).

RECOGNITION (Lat. *recognitio*, from *recognoscere*, to know again, from *re-*, back again, anew + *cognoscere*, from *co-*, together + *gnosere*, to know). An object is said to be 'recognized' when it appears as familiar. Thus one recognizes an acquaintance or a locality that has been visited before. Recognition stands midway between the feeling of strangeness or novelty, on the one hand, and the affective indifference which characterizes the cognition of a well-worn environment, on the other. Associations apart, unknown objects tend to arouse a feeling of uneasiness, or even of alarm; very familiar objects, such as one's tools, or breakfast table or writing desk, tend to become indifferent, taken for granted, while objects which are encountered occasionally produce a mildly pleasant mood which forms the core of recognition. There is a fourth stage in the affective reaction which appears in tedium or ennui. At this stage active interest has gone beyond its indifference point and has passed into monotony. One is said to feel bored, to be tired of one's surroundings, etc.

It is not always easy to discriminate between recognition and cognition. In fact, the terms have often been used indiscriminately. But it is better to reserve the word cognition for the identification of well-known or commonplace objects which do not arouse the cognitive mood, or again, of objects whose kind is well known, although the individual perceived may be unknown.

Recognition is closely related to memory (q.v.). In memory, it is a *recollection*, that appears familiar. The remembrance of a debate in which one took part, or of a fire witnessed last week, bears the mark of familiarity in the sense that it comes before one as a part of past experience. In recognition, it is a present *perception*—the object before one—that is familiar. The recognition need not refer explicitly to the past; the memory always does.

There are two forms of recognition: direct and indirect. (1) In *direct* recognition there arises at once a belief that the object perceived is known. This belief appears under two forms. Either it takes the general form, 'this object is familiar,' or some specific form, such as, 'this object is my neighbor's dog, Rover.' In the first case there is bare familiarity; in the second case there is familiarity *plus* additional knowledge of the object as a particular object. (2) In its *indirect* form, recognition is brought about mediately; i.e. an object is recognized by means of its environment, by reason of the surroundings in which it is set. This takes place when the object itself fails to arouse the mood of

familiarity and is known only through attendant circumstances either past or present.

Recognition has performed a very important biological function in the history of the race. It is one of the means by which the organism adapts itself to its environment. Like many of the more important emotions—fear, anger, sympathy—it is deeply rooted in instinct. The animal learns to trust that which is familiar, that which has stood the test of acquaintance, and to show distrust in the face of the novel and untried. Thus have developed, side by side, a pleasant aggressive mood of confidence in presence of the known and an unpleasant shrinking mood of diffidence and dislike in presence of the unknown. The refined and modified successors of these instinctive attitudes persist in our moods of familiarity and unfamiliarity.

BIBLIOGRAPHY. Hoeffding, *Outlines of Psychology* (New York, 1891); Wolfe, in *Philosophische Studien*, vol. iii. (Leipzig, 1886); Lehmann, *id.*, vols. v., vii. (ib., 1889; 1892); Hoeffding, *id.*, viii. (ib., 1893); Külpe, *Outlines of Psychology* (New York, 1895); Ward, *Mind*, N. S., ii., iii. (London, 1893-94); Titchener, *Outline of Psychology* (New York, 1899); Spencer, *Principles of Psychology* (New York, 1890); Sully, *Outlines of Psychology* (New York, 1891). For recognition as an experimental method, see MEMORY.

RECOGNITION MARKS. The bars and stripes of various animals which Wallace thinks serve for recognition by animals of their own species. He claims that color for recognition is "a totally distinct category, to some extent antagonistic or complementary" to protective coloration (q.v.). Recognition colors and markings are prevalent among butterflies and moths, and among them "its chief function may have been to secure the pairing together of individuals of the same species." Recognition marks during flight are very important for all birds which congregate in flocks or which migrate together; and they usually consist of well-contrasted markings on the wings and tail. These markings occur in pigeons, hawks, finches, warblers, ducks, etc., and are illustrated graphically in *Bird Lore*, vol. iii. (New York, 1901). Recognition marks occur in many mammals, such as the zebra, many antelopes, gazelles, and allied African forms, including the eland, koodoo, etc.

On the other hand, objectors assert that such stripes and spots are for protection, i.e. concealment (see PROTECTIVE COLORATION), and that they represent "spots or streaks of sunlight passing through foliage or reflected from leaves." Consult: Wallace, *Darwinism* (New York, 1889); Pocock, "Antelopes and Their Recognition Marks," in *Nature*, vol. lxii. (London, 1900).

RECOGNIZANCE, *rê-kôg'nî-zans* or *rê-kôn'î-zans* (ML. *recognoscantia*, from Lat. *recognoscere*, to know again). An obligation entered into by a person with a court of record, whereby he binds himself under a penalty to do or not to do a particular thing required of him by the court, and which is made a part of the record. Recognizances differ but little in form from ordinary bonds, except that they need not be executed with the same formality, as they are entered into before the court, and that they are commonly given by persons under a criminal charge. In many jurisdictions recognizances need not be

signed by the person binding himself, as the simple fact of his assent being made a part of the record by order of the court is considered sufficient.

Recognizances are commonly given by prisoners accused of trivial crimes to secure their temporary release, or even permanent release on probation, and, as the name indicates, they contain or imply a recognition or acknowledgment of the offense. The most frequent conditions are that the 'recognitor' keep the peace, or appear at some adjourned hearing of his case. In such a case the prisoner is said to be discharged 'on his own recognizance.'

Recognizances differ from bail bonds in that the latter are usually required to be executed by sureties who can qualify as owning real estate of a certain value. A further distinction is that a recognizance is usually considered as a sort of conditional judgment, and on the default of the recognitor a *scire facias*, or order to show cause, issues to him, requiring him to show good reason why execution should not issue against him immediately for the amount named in the recognizance. In many of the United States bail bonds have entirely superseded recognizances. See BAIL; BOND.

RECOIL (from OF., Fr. *reculer*, from ML. *recolare*, to go backward, from Lat. *re-*, back again, anew + *culus*, posterior; connected with Ir. *cúl*, back). The force of the high pressure suddenly produced by the explosion of a charge of powder acts with equal intensity in all directions. Hence its tendency to set in motion, not only the projectile, but also the gun—just as a spring compressed between two bodies would tend to set both moving in opposite directions. The retrograde movement of the gun, after the explosion of the powder, is known as its recoil, which in the early days of artillery development was responsible for many serious accidents. Devices for utilizing the recoil have now reached so high a degree of perfection that the total time consumed in the recoil and return to firing position—or to battery—is for heavy guns but a fraction of a second. See ORDNANCE.

REC'OLLET (OF. *recollet*, Fr. *récollet*, from Lat. *recolletus*, p.p. of *recolligere*, to recollect, from *re-*, again + *com-*, together + *legere*, to gather). A name given to the members of certain reformed bodies of monastic Orders, whether of men or women, in the Roman Catholic Church. Among Orders of men, an offshoot of the Augustinian hermits, which, under Louis de Montaya, in 1530, obtained considerable popularity in Spain, was called by this name, and the Order still exists at Medina-Sidonia, Leon, and Pamplona; but outside of Spain this Order is better known under the title of the Reformed Franciscans, who were established in France under Henry IV. and Louis XIV., and spread thence into Belgium, their houses in these countries and Germany becoming so numerous that they reckoned no less than ten provinces. A reform of the Cistercian Order of nuns in Spain was called by the same name.

RECONNAISSANCE (Fr., recognition). The acquiring of information as to the strength and disposition of the enemy, features of terrain, etc. The great prerequisite of successful strategy is the possession of accurate information regarding the number, character, and ef-

fectiveness of the enemy, together with a complete knowledge of his position, disposition, and of the intervening terrain. The method of securing this information is (1) by scouts; (2) by reconnoitring patrols; (3) by special reconnaissance; (4) by reconnaissance in force; and (5) by topographical reconnaissance. Efficient scouting is more a necessity under modern conditions than ever before, smokeless powder and magazine rifles combined rendering it almost an impossibility for the ordinary cavalry patrol, and occasionally for even the infantry patrol, to secure information. The invisibility of the rifleman, and the difficulty of determining whether the firing is from a strong force firing individually or a small force using their magazines, make the employment of cavalry in a special reconnaissance, which is usually designed to develop the enemy without risking a general engagement, an extremely hazardous undertaking. In a difficult or broken country they come within the death zone before becoming aware of the presence or vicinity of an enemy. Under favorable conditions, or against an inferior foe, the special reconnaissance is a very effective operation. A reconnaissance in force is almost invariably the precursor of a general engagement, all three branches of the service taking part in it. It is an operation designed to develop the enemy, compelling him to disclose his disposition for defense or counter-attack, and if possible to betray any weakness there may be in his plans. On the development of the reconnaissance will largely depend the nature and character of the attack, as well as the point and general direction of its delivery. A topographical reconnaissance is carried out by specially selected officers, with or without escorts, who map out the country over which an advance or attack may be made, having special reference to the immediate plans of the commanding general. For more detailed information regarding this branch, see ENGINEERING, MILITARY.

RECONSTRUCTION (from Lat. *re-*, back again, anew + *com-*, together + *struere*, to heap). In American history, the process by which, after the Civil War, the seceded States were restored to their normal relations with the Union. The only provision of the Constitution that seemed to have any bearing on the matter was that which makes it the duty of the United States to guarantee to every State in the Union a republican form of government. Even this was not explicit, for it was not stated which branch of the Government—whether the Executive or Congress—was charged with the execution of the constitutional mandate. Among the views as to the status of the States at the close of the war several deserve a brief explanation: First, there was the Southern view, based on the assumption that the acts of secession were invalid and of no effect. Its cardinal doctrine was the indestructibility of a State, either by its own act or by act of the United States Government. All that was necessary, therefore, to the reestablishment of normal relations with the Union was for the State governments to cease their resistance to the Government of the United States, and repeal all measures passed in furtherance of secession and rebellion. Second, there was the view of President Lincoln, based on the assumption that the act of rebellion in each State was the act not of

the State itself, but of combinations of disloyal persons who had unlawfully subverted the loyal State governments. The States, therefore, continued to exist as members of the Union, though they were out of their 'proper practical relations' with it. According to this view the problem of reconstruction consisted simply in placing the loyal element in the seceded States in control of the State governments which had been subverted by the disloyal element. Furthermore, President Lincoln regarded the problem as one devolving upon the Executive rather than upon Congress—for the work of creating a loyal element necessarily involved the exercise of the pardoning power, which alone was vested in the President—and the support by the military arm of the loyal governments so established. Thirdly, there was the Congressional view, which held that reconstruction was a legislative problem; that as a result of rebellion the Southern States were 'deprived of all civil government,' and that all *de facto* governments set up during the war were illegal. This view has been called the 'forfeited rights' theory. The States continued to exist, but as disorganized communities subject to the paramount authority of the United States. In pursuance of this view Congress passed an act in July, 1864, which was fathered by Henry Winter Davis in the House and Benjamin F. Wade in the Senate, and which provided a remedy for the defects of the Presidential scheme as understood by the supporters of the Congressional view. The view embodied in this measure differed from that of President Lincoln, first, in regarding the problem of reconstruction as a legislative problem; second, in requiring the loyalty of a majority of the adult white males of the State for the basis of the reconstructed government instead of the loyalty of one-tenth, as required by President Lincoln's plan; thirdly, in requiring the abolition of slavery as the starting point in the process of reconstruction. President Lincoln refused to sign the bill before the expiration of the session, thus indirectly defeating it. A fourth view was the so-called State suicide theory of Charles Sumner, enunciated by him in a series of resolutions offered in the Senate in 1862. The gist of these resolutions was that the attempt of a State to secede from the Union, involving as it did an attempt to exclude the Constitution of the United States from the territory of the State, was, if successfully sustained by force, equivalent to a practical forfeiture by the State of all rights under the Constitution. It involved, furthermore, the immediate extinction of the State sovereignty and its reduction to the position of a Territory under the exclusive jurisdiction of the Government of the United States. Finally, there was the view ably expounded by Thaddeus Stevens, and popularly called the conquered province theory, according to which rebellion against the national authority by a State of the Union not only put an end to its existence as a State, but even forfeited its rights as a Territory under the Constitution. The inhabitants of such a community were remanded to the status of an unorganized province owned by the National Government and subject to its dominion without the restraint of constitutional limitations. The advocates of this theory appealed to the actual facts of the case to show that at the close of hostilities the Southern States were in the condition of de-

pendent provinces subject to the absolute dominion of the conqueror.

Of the several theories advanced, that held by President Lincoln was the first to receive attention. Early in 1862, large portions of Louisiana, Arkansas, and Tennessee having been recovered by the Federal armies, the President appointed 'military governors' in those districts with somewhat vague and undefined powers. In general they were to take the initiative in the movement to reestablish civil governments and prepare the way for representation in Congress. In his third annual message of December 8, 1863, the President announced a more definite and systematic plan of reconstruction, to which was appended a proclamation of amnesty offering a full and complete pardon to all who would take an oath to support the Constitution of the United States and the Union of the States thereunder, as well as all acts of Congress passed during the war, and all proclamations of the President, with reference to the slaves. From the benefits of the amnesty were excluded certain classes of men who had held high military or civil offices under the Confederate Government or who had left the service of the United States to engage in the rebellion. He then proposed to restore the State governments in the seceded States to the amnestied class by declaring that whenever a number of persons not less than one-tenth of those who had cast votes in such State at the Presidential election in 1860 had taken the oath, if they were qualified voters by the State law in force at the time of secession, and had reestablished a State government republican in form, such government should be recognized by the Executive as the true Government of the State. He said, however, that whether members sent to Congress from any State so reconstructed should be admitted to their seats rested exclusively with the two Houses. The proclamation did not apply to Virginia, both the President and Congress having from the first recognized the loyal Pierpont Government at Alexandria as the true Government; nor did it apply to Missouri and Kentucky. 'Ten per cent.' governments, so called, were accordingly established in Louisiana and Arkansas in the following year. Representatives were also elected to Congress, but when the new members from the reconstructed States appeared with their credentials neither House would admit them to seats. In Tennessee the President's plan of reconstruction was put into operation early in 1865. Representatives were chosen to Congress, but they were refused admission to their seats in December, 1865. In the meantime Congress had assumed the right to take in hand the matter of reconstruction, and had passed the Wade-Davis Bill, to which reference has already been made. In February, 1865, it also passed a resolution which prohibited the counting of any electoral votes for President or Vice-President in the election of 1864 from States which had passed secession ordinances. The refusal of the President to sign the Wade-Davis measure, and his proclamation in regard to the subject in which he stated his objections to the setting aside of the constitutions and governments in Louisiana and Arkansas, made a breach between the President and Congress inevitable.

After the assassination of President Lincoln, President Johnson took up the policy of his predecessor without material change, and on

May 29th issued a proclamation of amnesty and pardon to all persons who had neglected to avail themselves of the benefits extended by the amnesty proclamation of President Lincoln. His proclamation of amnesty differed from that of President Lincoln only in the enlargement of the classes of excepted persons. Besides those who had held high rank in the Confederate military and civil service and those who had resigned positions in the service of the United States to enter the rebellion, and a few other classes, President Johnson excluded all who had voluntarily taken part in any capacity in the Confederate service and who were the owners of taxable property of the value of more than \$20,000. Persons excluded from the benefits of the amnesty were allowed to make special application to the President, who promised that such clemency would be extended as appeared to be consistent with the facts of the case and the peace and dignity of the United States. By subsequent proclamations the President appointed provisional Governors for the States of North Carolina, Mississippi, Georgia, Alabama, South Carolina, and Florida, and directed them to call constitutional conventions in their respective States for the purpose of restoring the said States to their constitutional relations with the United States. The heads of the several executive departments were at the same time directed to put the laws of the United States into operation in these States, and the United States judges were required to open the courts and to proceed with the business on their dockets. President Johnson regarded the States of Virginia, Louisiana, Arkansas, and Tennessee as already reconstructed, and therefore provisional Governors were not appointed for those States. During the summer and autumn of 1865 conventions were held in all the States not yet reconstructed, except Texas; and when Congress assembled in December of that year they had all passed ordinances either 'repealing' the ordinances of secession or pronouncing them null and void *ab initio*; they had all abolished slavery by constitutional amendment; and with one or two exceptions all had passed ordinances repudiating State debts incurred in aid of the rebellion. They had, moreover, held elections for members of the Legislature, for State officers, and for members of Congress, and the Legislatures had met and with two or three exceptions had chosen United States Senators and ratified the Thirteenth Amendment to the Constitution of the United States. When, therefore, Congress met in December, the President was able to inform that body that all the States except Texas, whose convention did not meet until March, 1866, "had been reconstructed and were ready to resume their places in the two branches of the National Legislature."

Congress, however, did not accept the view of the President, but appointed a joint committee of nine Representatives and six Senators to inquire into the condition of the seceded States and to report by bill or otherwise whether any of them were entitled to representation in Congress. Pending the report of the committee and the action of Congress thereon, it was resolved that no member should be received into either House from any State lately in arms against the United States. The chief reason for the rejection of the President's plan was the character of the police legislation passed by several of the Southern Legisla-

tures in the autumn of 1865. On account of the general demoralization of the freedmen after emancipation, together with their habits of improvidence and shiftlessness, all the Southern States passed stringent police measures to prevent disorder and pauperism among them. One of the chief objections urged against these laws was that in most cases they applied only to the negro race. In Mississippi, for instance, negroes were prohibited from renting or leasing land in incorporated towns and they were allowed to be competent witnesses only in cases at law in which they were parties. The Republicans in Congress professed to see in these measures an attempt to reenslave the freedmen of the South. In the meantime the Thirteenth Amendment, abolishing slavery, had secured the ratification of the requisite number of States and had been promulgated by the Secretary of State as the law of the land. In March, 1866, Congress passed the Civil Rights Bill (q.v.) conferring the rights of citizenship upon the freedmen. This act established complete equality in the enjoyment of civil rights for all citizens without respect to color or race. On March 27th President Johnson vetoed the bill, but early in April Congress passed it over his veto. About the same time Congress passed a measure to enlarge the powers of the Freedmen's Bureau (q.v.). It too was vetoed, and was not passed over the veto. In July another measure for the same purpose was passed, was vetoed by the President, and passed over his veto. In the meantime Congress was debating a proposition to amend the Constitution so as to place beyond the reach of any subsequent Congress the provisions of the Civil Rights Bill. In June the proposed amendment secured the necessary two-thirds majority of both Houses and was sent to the State Legislatures for ratification.

In the same month the Joint Committee on Reconstruction made its report declaring that the seceding States had deliberately abolished their State governments and Constitutions so far as these connected them with the Union, and were consequently disorganized communities; and that guarantees of future security should be required as an essential condition of restoration to normal relations with the Union. The committee recommended denial of representation to these communities until "sufficient guarantees were provided which would tend to secure the civil rights of all citizens, temporary restoration of suffrage to those not guilty of participation in the rebellion, and the disqualification from office of at least a portion of those whose crimes have proved them to be the enemies of the Union and unworthy of public confidence." During the period intervening between the report of the joint committee and the reassembling of Congress a riot had occurred between the white and black races in New Orleans, resulting in the death of 40 or 50 persons and the wounding of 160 others; and the President in the course of a journey to Chicago had used indiscreet language in his criticism of Congress. When Congress met in December, 1866, it made an unsuccessful effort to impeach the President, and then, in order that the President might be prevented from carrying out his policy of reconstruction, enacted a law requiring the new Congress, which contained a large majority opposed to the executive policy, to meet on March 4, 1867. Next it passed the

Tenure of Office Act (q.v.) to limit the President's power of removal. It then passed acts establishing negro suffrage in the District of Columbia and in the Territories. Finally it practically deprived the President of his power of command over the army and vested it in General Grant, whose position was further made irremovable.

Meantime Congress was spurred on by the action of all the Southern States except Tennessee in rejecting by votes nearly or quite unanimous the proposed Fourteenth Amendment. It now took up the work of reconstruction in earnest, showed little or no disposition to yield to the views of the President, and in February passed an "Act to provide for the more efficient government of the seceded States," assigning as a reason that "no legal State governments or adequate protection of life, liberty, or property existed in those States, and that it was necessary that peace and good order should be enforced in them until loyal and republican State governments could be legally established." The bill was promptly vetoed by the President, and on the same day was passed over his veto. The act divided the ten seceding States into five military districts, as follows: (1) Virginia; (2) North and South Carolina; (3) Georgia, Florida, and Alabama; (4) Mississippi and Arkansas; (5) Louisiana and Texas. Each district was to be under the command of an army officer not below the rank of brigadier-general, appointed by the President, and charged with the duty of protecting all persons in their rights of person and property, of suppressing insurrection, disorder, and violence, either by military commission or through the local courts. In the meantime the existing civil governments were to be deemed as provisional only and subject to the authority of the United States. The act also contained provisions for the calling of a convention by the people of the State with a view to restoration in the Union. By a supplementary act passed March 19th by the new Congress, the voluntary action of the States was anticipated and the process of reconstruction hastened. This measure directed the district commanders to cause to be registered as voters all persons, without regard to race or color, not disqualified by participation in rebellion; to hold an election for delegates to a State convention; and if a majority of the registered voters were in favor of holding a convention, to call it together for the purpose of adopting a new constitution. As soon as the Constitution was ratified it was to be transmitted to Congress, and if it were approved by that body, the State was to be readmitted to representation in Congress. The President promptly vetoed the act, on the ground that some of its provisions were without constitutional warrant, that it purposed to disfranchise the great body of respectable whites, and that it conferred the suffrage on the mass of ignorant freedmen. With equal promptness the measure was passed over the executive veto. The President, despite his hostility to the act, at once appointed the district commanders, his first appointees being Generals Schofield, Sickles, Ord, Thomas, and Sheridan. These officers with military commands assumed control of their respective districts and immediately put into operation martial law. Orders were issued in every district for the regulation of various matters of private law and for the prevention of discrimina-

tion against the blacks. Boards of registration were appointed in each county and the work of registering the new electorate was soon in full progress. In the early winter of 1867 elections were held in all the military districts, and by February, 1868, conventions were in session in every Southern State that had seceded from the Union. The Constitutions drafted by these bodies reflected the views of the delegates, a majority of whom in most instances were freedmen and Northern Republicans who had emigrated to the South after the war, and who came to be called in derision 'carpetbaggers.' The constitutions drafted by them provided equality in civil rights and in some cases undertook to secure social advantages for the blacks. They established negro suffrage and in most cases disfranchised those whites whom the proposed Fourteenth Amendment would disqualify from holding office. In several States those who had violated the rules of civilized warfare or had voted for secession were likewise disfranchised. Everywhere except in Mississippi, Texas, and Virginia reconstruction constitutions were promptly ratified by the new electorates. In Mississippi, on account of several provisions of a proscriptive character in the new Constitution, a determined and systematic campaign was undertaken by the whites for the purpose of defeating ratification. By the aid of a considerable proportion of the colored voters they were successful, and the State was left to continue for a while longer under military rule. In Texas and Virginia the obnoxious features of the constitutions created such strong opposition that the reconstructionists were induced to delay indefinitely the submission of those instruments and these States likewise continued under military rule. In the other States, the constitutions having been duly ratified and the Fourteenth Amendment adopted by the newly constituted Legislatures, Congress on June 22, 1868, readmitted Arkansas into the Union, and on June 25th Georgia, North Carolina, South Carolina, Florida, Alabama, and Louisiana. The Fourteenth Amendment was also declared by the Secretary of State to have been adopted by the requisite number of States and was accordingly promulgated as a part of the Constitution. In the meantime the Georgia Legislature had rejected the negro members elect to that body, and the United States Senate thereupon refused admission to the Senators from that State after the act of June 25th had declared the State reconstructed. Thus at the time of the accession of General Grant (1869) to the Presidency four of the States were still unrestored to their full places in the Union. He at once recommended to Congress the submission of the constitutions of Virginia and Mississippi to the people in such a manner as to enable them to vote separately upon the obnoxious provisions. Congress acted upon the President's recommendation and the constitutions were promptly ratified without the objectionable clauses. By the same act Congress authorized the President to submit the Constitution of Texas to the voters, which was done and it, too, was ratified. In the cases of these three States, however, Congress imposed an additional condition which had not been required of the other reconstructed States, namely, the ratification of the Fifteenth Amendment. In January, February, and March, 1870, respectively, Virginia, Mississippi, and Texas were restored to

their full positions in the Union, but subject to certain conditions which to some extent impaired their equality with the original States. Finally, after being twice reconstructed, Georgia complied with the new conditions imposed by Congress, and by an act of June 24, 1870, was again restored to her place in the Union and military government was withdrawn.

From the technical point of view reconstruction was now complete, but the consequences of what has come to be generally recognized as a mistaken policy were destined during the ensuing years to be far-reaching in their effects upon the reconstructed States. As a result of the disfranchisement of large classes of whites and the enfranchisement of the negro race, which outnumbered the whites in some of the Southern States, the local and commonwealth governments fell into the hands of unscrupulous adventurers from the North and West, who controlled the colored vote and excluded the native whites from participation in the administration of the government. Negroes who but a few years earlier were in slavery now filled up the Legislatures, held many of the executive offices, many of the minor judicial positions, and in some cases occupied seats on the benches of the higher courts. An era of extravagance, amounting to outright plunder in some States, now set in. Legislative sessions were frequent and long drawn out, the members voting themselves a large per diem as compensation for their services. Bulky codes were enacted and numerous offices, amounting to sinecures in many cases, were created for the benefit of the 'carpetbaggers,' who now came in great numbers to the South. The rate of taxation everywhere was increased out of all proportion to the ability of the people to pay in their then impoverished condition. In Mississippi the rate rose from one mill on the dollar to fourteen, and resulted in the confiscation of one-sixth of the entire land of the State for non-payment of taxes. In most of the States large debts were created for projected improvements, many of which were never carried out. In Louisiana and South Carolina a wholesale system of plunder was inaugurated. In the latter State the public debt was increased from \$5,000,000 in 1868 to \$18,000,000 in 1872, with little to show for it. The tax levy of \$500,000 a year was raised to \$2,000,000, although the value of taxable property had decreased from \$400,000,000 to \$200,000,000. Soon disorders began to arise in all the Southern States, and presently the Ku-Klux Klan (q.v.) was organized to terrorize the negroes and exclude them from the enjoyment of their newly acquired political rights. The disorder became so great that Congress was called upon to take action to preserve order and protect the blacks. By the so-called Enforcement Act of 1870 the Federal courts were given jurisdiction of a series of offenses committed with the intention of denying equal rights to any citizen of the United States. The Federal district attorneys now bestirred themselves throughout the South, and many indictments were found under the act, but few convictions followed. In the following year Congress passed the so-called Ku-Klux Act, which authorized the President to suspend the writ of habeas corpus and employ military force for the suppression of violence in any community. Acts were also passed providing for Federal supervision of elections, and

finally, in 1875, an act was passed to secure equality of treatment to negroes in theatres, railway cars, hotels, and other public places. This act, however, as well as the chief provision of the Ku-Klux Act, was declared by the Supreme Court to be unconstitutional, not being within the power of Congress. As the extravagance and corruption of the carpetbag governments increased, the determination of the whites to regain control of affairs became fixed. The withdrawal of the military forces from the South left the reconstruction governments without power to maintain themselves. Already by 1870 North Carolina, Tennessee, Texas, Georgia, and Virginia had been 'reclaimed' from the Republicans. Meantime the wholesale removal of political disabilities by Congress restored to public life many old and respected citizens of the South. This, together with the division of the Southern Republicans into conservative and radical wings, the former coalescing with the Democrats, made possible Democratic success. In 1874 Alabama and Arkansas went Democratic, and the carpetbag governments in those States came to an end. In the following year a great campaign was waged in Mississippi not unaccompanied by violence, intimidation, and even riots, but which resulted in the defeat of the Republicans. The 'Mississippi plan' was applied with success, in 1876, to the three remaining States of Louisiana, South Carolina, and Florida. The 'redemption' of the Southern States was now complete, and was followed by a general emigration of the 'carpetbaggers' to the States of the North and West. The subsequent virtual disfranchisement of the negro race in the South marks the final recession from the status established by the process of reconstruction.

Consult: Dunning, *Essays on the Civil War and Reconstruction* (New York, 1898); Burgess, *Reconstruction and the Constitution* (New York, 1902); Andrews, *The United States During the Last Quarter of a Century* (New York, 1896, 2 vols.); Scott, *Reconstruction in Civil War* (Boston, 1895); McPherson, *Political History of the Rebellion* (Washington, 1864); id., *Political History of Reconstruction* (Washington, 1871); Herbert, *Why the Solid South?* (Baltimore, 1890); Cox, *Three Decades of Federal Legislation*; McCarthy, *Lincoln's Plan of Reconstruction* (New York, 1901); Blaine, *Twenty Years of Congress* (Norwich, Conn., 1884). Consult also a series of excellent articles in the *Atlantic Monthly*, vols. lxxxvii and lxxxviii.

RECORD (OF. *record, recort*, from ML. *recordum*, witness, record, judgment, from Lat. *recordari, recordare*, to remember, call to mind, from *re-*, back again, anew + *cor*, heart), **JUDICIAL**. A written history or account of the entire proceedings in a case. The importance of keeping such records was not recognized until long after regular tribunals of justice had been established. It seems to be undisputed that William the Conqueror introduced the practice into England. At the early common law it was the custom for the proper court official to enter upon pieces of parchment the pleadings and a brief account of all the steps and proceedings taken in the action, including the judgment. These various pieces were attached together in regular order, and wound into a spiral roll for convenient safe keeping. This was known as the 'judgment roll,' and this term is still applied to the various

pleadings and papers including the judgment when filed together as a part of the record. Afterwards the records were kept by writing them in books instead of on parchment, and in a few jurisdictions to-day every item of a judicial record is entered in books which become the public records of the court. However, in many jurisdictions the record of a case is composed partly of entries in the clerk's books, and partly of the original pleadings and judgment filed in the proper office.

A complete judicial record of an action should contain, in some form, the date of issue, the pleadings, the various necessary steps taken before trial, a minute of the fact of the trial, the appearances for the parties, the name of the judge before whom the cause was tried, the verdict of the jury or disposition by the court, and the final judgment. Under most practice acts, the successful party, in order to enforce his rights under the determination of his case by the court, must attend to the entry of judgment by presenting to the clerk of the court an instrument containing a statement of the determination of the action and an order for the proper relief, which is then signed by a judge or a clerk for the court, and entered. If he is careless the record may remain incomplete, and no process can be issued to carry out the direction of the court. The record of a court is conclusive evidence of the facts which it sets forth as between the parties thereto, and cannot be attacked collaterally. See PLEADING; PROCEDURE; RES JUDICATA, and consult the authorities referred to under PLEADING; PRACTICE.

REC'ORDE, ROBERT (c.1510-58). An English mathematician, born at Tenby, in Pembroke. He was educated at Oxford, and was elected fellow of All Souls' in 1531. He afterwards went to Cambridge and studied medicine, receiving his degree in 1545. In London he is said to have become Court physician. He became comptroller of the mint at Bristol (1549), and general surveyor of the mines and money (1551). He died while imprisoned for debt in King's Bench Prison, Southwark. Recorde was one of the first in England to adopt the Copernican system, then in its infancy. He was the first to introduce algebra into England, and his views of the science were very advanced for the time. His invention of the sign of equality, =, given in his *Whetstone of Witte*, and his method of extracting the square root of polynomials, are the only evidences of originality generally recognized by mathematicians. The equality sign seems, however, to have been a mediæval abbreviation for *est*. His text-books were recognized authorities in England for many years, and it was more than a century after his death that they ceased to be used in the schools. His chief works were: *The Grounde of Artes* (1540, and frequent editions until 1699); *The Whetstone of Witte, or the Second Part of Arithmetike*, a work on algebra (1557); *The Pathway to Knowledge, or the First Principles of Geometry* (1551); *The Castle of Knowledge, a Treatise on Astronomy and the Sphere* (1551); *The Urinal of Physick*, a work on medicine (1547).

RECORDER. In England, the sole judge of a borough court of Quarter Sessions, and frequently judge of the borough civil court of record. Only barristers of five years' standing are eligible, and the appointment is for life or

during good behavior. The recorder does not take charge of the administrative duties of the Court of Quarter Sessions (q.v.). In most boroughs he may practice law, as his salary is often merely nominal. He is appointed by the Home Secretary on behalf of the Crown. This title is also applied to the chief judge of the Mayor's Court of London, and to one of the judges of the Central Criminal Court.

The title is seldom applied to judges in the United States. The principal instance of note is in New York, where one of the judges of the Court of General Sessions is called the Recorder. The name was derived from that of the English judge. He devotes his entire time to his duties, just as the other criminal judges, not being allowed to practice. It is an elective office.

RECORDER. The name of a musical instrument formerly in use in Great Britain, somewhat like a flageolet, but with the lower part wider than the upper, and a mouth-piece resembling the beak of a bird. Its pitch was an octave higher than the flute, and it had a pleasing tone. Its compass was about two octaves, from f¹ to f².

RECORDING ACTS. Under this head are included all statutes providing for the recording or registration of conveyances, liens, and incumbrances of every description, affecting the title to real and personal property. The chief object of such laws is to provide a means of giving public notice of the existence and character of all instruments affecting titles to property, and thereby prevent fraud and render titles more secure than under the common law. Such acts are not usually mandatory in their terms, but in effect they render it unsafe for a purchaser or incumbrancer to neglect to have his instrument of title recorded. For example: if A sells a piece of land to B, and the latter neglects to have his deed recorded, and A subsequently executes another deed of the same land to C, an innocent purchaser for value, the latter will take precedence over B if he has his deed recorded first. Recording acts usually provide for the establishment of record offices, and inspection by the public at reasonable hours. Usually the whole instrument must be copied in the record books, but sometimes only the substance is noted. Instruments presented for record should be duly acknowledged or executed in the form required by statute. The effect of recording is to give constructive notice of the existence of an instrument, which is made equivalent to actual notice. See RECORDING OF DEEDS; TITLE, REGISTRATION OF.

RECORDING OF DEEDS. At common law, the transfer of title to real property by livery of seisin (q.v.) was a public and notorious act, making unnecessary any formal public record of the transaction. The modern practice of recording transfers of property on public records was therefore unknown to the common law. The Statute of Uses (27 Henry VIII., c. 10), which made permissible the conveyance of real estate by deed privately executed, gave rise to the necessity of some method of publicly recording all instruments of conveyance. The first step in this direction was taken by the Statute of Enrollments (27 Henry VIII., c. 16), which provided for the enrollment or recording of all deeds of bargain and sale. As the statute did not in terms apply to leases of real estate, the lawyers

of the time speedily invented a method of evading the statute by means of conveyance by lease and release (q.v.). The Statute of Enrollments thus became practically inoperative almost from the time of its enactment. (See CONVEYANCE.) A later statute (7 Anne, c. 20) required the recording of deeds of all real estate located in the County of Middlesex, and this was followed by some other statutes having a purely local application. There is, however, no statute in England of general application requiring that deeds be recorded, and the practice of recording deeds has never become common in that country.

In the United States from the earliest time there have been statutes providing for the recording of conveyances of real estate, and now generally in the different States there are statutes providing for the recording of all deeds or instruments affecting the title to real estate, and in certain cases instruments affecting the title to personal property. Thus generally deeds, leases, mortgages, assignments, and releases of mortgage, wills, lis pendens, mechanics' liens, and liens upon or affecting real estate may be recorded. And in many States mortgages and conditional sales of personal property may be recorded. The method of recording is usually prescribed by statute. Generally the document is transcribed on public record books provided for the purpose. The place of record is usually, in case of real estate, the county in which the property is located, or, in case of personal property, the town or city in which the property is located or where the mortgagor or owner resides, or both; and there are numerous special provisions governing the recording of instruments affecting transitory property, as vessels, canal boats, and the like. The instrument to be recorded must be properly executed, and it is generally required that it shall be acknowledged before a notary or a corresponding public officer. It is generally deemed to be recorded from the time it is filed in the office of the public officer whose duty it is to record the instrument.

The effect of recording a deed or conveyance in accordance with the various recording acts is to give constructive notice of the deed or conveyance to all who deal with the property. Recording a deed is not necessary to determine the rights of those who are parties to it and their privies; but if the deed is not recorded a subsequent purchaser who has recorded his deed and who had no notice of a prior conveyance will be deemed to have title rather than the first purchaser who did not record his deed. In other words, as between two innocent parties claiming from the same grantor he has a good title who first records his deed.

Unless the recording act specifically otherwise provides, creditors or those buying with notice of a prior conveyance will not be protected by the recording act, but will acquire only the title actually vested in their grantor. The effect of the recording acts, therefore, is to make the public record the conclusive record of the ownership or interest in real property to all who rely upon it, and any one who deals with the property, except a creditor or one having actual notice of an unrecorded instrument affecting the property, may rely upon the state of the public record on the date of taking a deed or conveyance as determining completely the right or interest which he acquires. In England, owing to the practice

of not recording instruments of conveyance, it is usual to give the buyer of real estate who is entitled to receive them all the conveyances affecting the property as muniments of title. In the United States this is not necessary or usual, as the public record is sufficient evidence of the title; and the buyer is entitled only to the grantor's conveyance with the usual covenants of warranty.

RECORDS, PUBLIC. In the broadest sense, a public record is a written account, history, or memorandum of a fact or event of general public interest, made by a public official in the performance of his duties, and intended to be preserved as permanent evidence of the matters to which it relates. However, the term is usually confined to authenticated accounts of legislative acts and proceedings, the judgments and records of proceedings of courts of law, and the originals or copies of wills, mortgages, and conveyances, preserved under recording acts.

The nations of remote antiquity had very little idea of preserving these memorials for the public benefit. Accounts of the doings of the rulers were indeed preserved, as by the clay tablets of Nineveh and Babylon, but they recorded merely military expeditions or the splendor of the monarch, rather than laws or rights affecting the general public. However, as the world became more enlightened and the common people were accorded some rights, it became customary to promulgate laws and preserve them in writing in some royal repository, and these were the first true public records. No provision was made for their inspection by the people, and where it was desirable to promulgate a law affecting the people in general, it was usually written upon parchment, or some more indestructible substance, and posted in a public place, or communicated to those in authority in various districts and proclaimed by them, through their subordinates or deputies, to the people in their respective districts. No method of recording titles to real estate was known until comparatively modern times. Thus, in A.D. 303, the principal laws of Rome were painted on twelve wooden boards, known as the 'Twelve Tables' and exhibited in the Forum. During the mediæval ages the laws were usually written on parchment and preserved by certain public officials, but it seems that no systematic record of judgments or conveyances was kept. The French were probably the first nation to keep judicial records in the sense we employ the term now, and the Normans introduced the practice into England.

Under the feudal system the method of conveying land was by feoffment with livery of seisin, a sort of dramatic ceremony on the land itself, and written conveyances were not introduced until after the Statute of Uses, 27 Hen. VII., c. 10. By 27 Hen. VIII., c. 16, known as the Statute of Enrollments, it was provided that conveyances by 'bargain and sale' should be enrolled, that is, recorded. These acts were the basis of the recording acts in England and the United States.

England has the most complete collection of public records of any of the older nations of the world. However, until 1838, these records were so negligently kept that many valuable ones were destroyed or lost. The oldest English records are the 'tallies in exchequer,' which were made

by means of wooden sticks marked on one side with notches to indicate the sum for which the tally was an acknowledgment, while on the other two sides were written the amount, the name of the payer, and the date of the transaction, and then dividing the stick longitudinally, so that it could be fitted together again and read, the one half being preserved in exchequer, and the other given to the person who had paid the money. This rude contrivance was probably of Norman-French origin, the name being derived from the French *taille* (to cut off), and it probably proved satisfactory in those simple times. This method continued until 1783, when the statute of 23 Geo. III., c. 82, abolished the office of 'tally-cutter,' and substituted indented paper checks as receipts for payments into exchequer. Most of the accumulated tallies, being practically useless, were destroyed by burning.

During the era of the Norman kings the Parliamentary records were in the Norman-French language, and were written on parchment. This language continued to be used for Parliamentary records until the fifteenth century, and Latin was in common use in judicial records until the reign of George II. Various methods for preserving the records were employed before the art of bookbinding came into practical use. Some were crudely bound in book form; others were attached together and wound up in rolls (q.v.); and the parchments containing many records were simply folded and filed in their original form. One of the most noted ancient records is the 'Domesday Book,' which, as its name indicates, is in book form, and contains a record of land surveys and titles to land, compiled by order of William the Conqueror. This was probably the first attempt to make a complete record of the ownership or tenure of land. Such records as had been kept by the Saxons prior to the Conquest had been preserved by the clergy in monasteries and religious houses, and this practice was continued as to many important records for centuries. Many copies of the *Magna Charta* were put under the Great Seal and delivered to the archbishops for safe keeping.

During the reign of the Conqueror and his immediate successors, great progress was made in the matter of keeping public records. The elaborate system of feudal tenures introduced by William necessitated records in order to protect the King in his rights to military services, taxes, etc., and also in the interests of the great lords of the realm, whose power constantly encroached upon and abridged that of the King, and records were an effective means of preserving useful precedents, which would thereafter be considered binding on the Crown. The early court records were scattered about in the various palaces where the kings sojourned during their visits to the different parts of the kingdom. This was due to the fact that the principal court, the *Curia Regis*, followed the King's person, as he was the 'fountain of justice' and originally heard certain petitions, etc., himself. Upon the permanent establishment of the higher courts at Westminster, the court records were deposited in the cellars of Westminster Hall, which were damp and ill adapted for the purpose. A large number of valuable records were also deposited in the Tower. At various times since the thirteenth century the problem of the preservation,

and indexing of the records has been agitated in England. In 1800 a Parliamentary committee accomplished a great deal in the way of discovering and arranging ancient public records. Various commissions supplemented this work between the latter date and 1835, when a Parliamentary committee, appointed for the purpose, made a complete investigation of all that had been previously done in this regard, and their report was the basis of the subsequent legislation on the subject. The statute of 1 and 2 Viet., c. 94, restores to the Master of the Rolls his ancient authority as chief custodian of the court records, giving him in addition the charge of all the records of the kingdom. The act also provided for the establishment of a Public Record Office and for the erection of suitable buildings, and authorized the Master of the Rolls to appoint deputies and assistants, and to take all necessary steps for the careful preservation of all public records. In pursuance of this statute, the Master of the Rolls appointed a deputy keeper, who has active charge of the Record Office, and who issues yearly reports of the work of his department. Provision has been made for the reasonable inspection of records, and authenticated copies may be obtained, which will be received as evidence by the courts. The main Public Record Office building is situated in Fetter Lane, London.

A committee of the House of Commons in 1837 described the public records of England as comprised under four classes: (1) Independent series of records of territorial surveys at different periods; (2) series of enrollments comprising on one roll, varieties of distinct entries, classed together according to their formal character; (3) records of judicial proceedings; (4) separate documents, as letters, inquisitions, and privy seals. The act of 23 Viet. above referred to defines what is legally a public record. It provides that the term 'public records' shall include "all records, rolls, writs, books, proceedings, decrees, bills, warrants, accounts, papers, and documents whatsoever of a public nature belonging to her Majesty."

Some of the records collected were obtained in the library of the Vatican at Rome, being records of taxation by the Popes. One class consists of the various territorial surveys, beginning with the Domesday Book, and including, among others, the *Rotuli Hundredorum*, *Extenta manerii*, *Testa de Nevill*, *Pope Nicholas's Taxation*, *Henry VIII's Survey*, and the *Survey of the Commonwealth*. Another extensive class belongs to the exchequer, including the *Pipe Roll*, or great roll of the exchequer, beginning with the second year of Henry II., containing yearly accounts of the revenues of the Crown; the *Memoranda* and *Originalia* rolls, records of the *First Fruits and Tenths*, records of the *Court of Augmentations*, instituted to decide questions regarding possessions belonging to the Crown on the dissolution of the monasteries; and the *Placita*, or records of pleadings and judgments. The *Rotuli Curie Regis* contain the record of the proceedings in the King's Court; and there are numerous classes of records of the proceedings in the various courts of common law and in the Court of Chancery. The record of *Fines and Recoveries* is an unbroken record of the transfer of lands from 25 Henry II. down to 1833, when this species of conveyance was abol-

ished. The *Charter Rolls* are records of charters, of grants of privileges to religious houses, towns, and corporations, and creations of nobility from 11 Edward II. to Edward IV. The *Patent Rolls* are enrollments of instruments written on open (*patentes*) sheets of parchment, having pendent from them the great seal, and addressed to the liege lords of the kingdom. The *Close Rolls* are records of such letters under the great seal as were dispatched closed or sealed up—royal mandates to particular persons for particular purposes, and not intended for public inspection. The *Liberate Rolls* contain writs issued out of Chancery ordering the payment of money from the treasury. The *Fine Rolls* contain accounts of fines paid to the King for license to alienate lands, freedom from knight service, passing or renewal of charters, wardships, safe conduct, pardons, etc. The *French Rolls*, *Norman Rolls*, and *Gascon Rolls* relate to the affairs of France, Normandy, and Gascony, when held by the English; and the *Rotuli Scotiae*, to transactions with the ancient Kingdom of Scotland. An important class of the records are those connected with Parliament, including *Statute Rolls*, *Parliament Rolls*, *Records of Parliament*, and *Statutes* from 1485 to the present time, with the *Journals of the Lords and Commons* from Henry VIII. to the present time, and the *Writs of Summonses* and returns to Parliament. The *State papers* originally sprung from Privy Council and Chancery, and include the correspondence of the Privy Council, Secretaries of State, and other public departments, with miscellaneous domestic papers from the time of Henry VIII. to George II., a mass of correspondence with foreign powers, and an extensive collection relating to ecclesiastical affairs after the Reformation. Since 1855 the State Paper Office has become a part of the Public Record Office.

SCOTLAND. The ancient Parliamentary and judicial records of Scotland were removed to the Tower of London by Cromwell, and after the restoration of Charles II. were ordered to be shipped back to Scotland, but the ship on which they were loaded foundered in a storm and they were lost. Many of the curious ancient records, however, have been preserved, and together with the modern and contemporary records are kept in the General Register House under the care of the Lord Clerk Register. There are district register houses in Scotland, and when a volume of records is completed in one of these, it is sent to the General Register House.

IRELAND. Many of the ancient records of Ireland were destroyed during the wars which ended in the subjugation of the Irish people by the English. The system of keeping public records has never been so complete as in England, but the more important of the older records are now kept in repositories in Dublin.

UNITED STATES. Our Government started with the English methods of keeping public records from its beginning, and no nation pays more attention to the preservation of these muniments of private rights. In all States deeds, mortgages, etc., are required to be recorded to protect a title to land, and practically all instruments affecting property, real or personal, must be recorded in most States. Judicial records are kept by the clerks of the various courts. The statutes, etc., are kept by the State officials, and are open for inspection. The Federal Govern-

ment carefully preserves the *Declaration of Independence* and all Federal papers and documents. Each State, county, and municipality makes provisions for the safe-keeping of its own records.

LAW AS TO PUBLIC RECORDS. By the common law the general public had no absolute right to examine records preserved by the governmental authorities. For example, a person could not demand to see a record of title to real estate simply because he desired to make an abstract thereof out of curiosity or for historical research. Only such persons as had an interest in the property, or expected to acquire an interest in it, could, as a matter of right, demand to see the records, and compel the custodian to allow inspection in case of his refusal. The theory of this rule was that the time of public officers should not be taken in showing records to persons having no actual interest in seeing them. This has been carried to the extent of refusing to allow title guaranty companies the privilege of examining records of titles to land for the purpose of making abstracts thereof for use in their offices. This rule is also true as to judicial and other public records by the common law, and it still obtains in some of the United States. However, in England and in most of the United States, the statutes provide that public records may be inspected by any one, with reasonable regulations as to time and manner of examination.

A public record is good evidence of the matter to which it relates, and most jurisdictions provide that copies of a record, duly authenticated by the official custodian, shall be received in evidence with the same force and effect as the originals. This saves the public inconvenience of having records in daily use transported to the courts during a trial. The printed statutes of a State are deemed to be official, and must be accepted as such by the public.

Consult: Cooper, *An Account of the Most Important Public Records of Great Britain* (London, 1832); Thomas, *Official Handbook to the Public Records* (ib., 1853); Ewald, *Our Public Records* (ib., 1873); Scargill-Bird, *A Guide to the Principal Classes of Documents Preserved in the Public Record Office*; Reeve, *History of English Law* (ib., 1869); and the *Commentaries* of Blackstone and Kent. See CONVEYANCE; JUDGMENT; LIEN; MECHANICS' LIEN; RECORDING OF DEEDS; RECORD, JUDICIAL.

RECOUPMENT (OF., Fr. *recoupment*, from *recouper*, to recoup, cut off, or again, from *re-*, back again, anew + *couper*, to cut, from *coup*, cut, from Lat. *colpa*, from Gk. *κόλαφος*, *kolaphos*, blow with the fist, from *κόλαπτειν*, *kolaptein*, to strike). The right of a defendant in an action at law to reduce the amount of the plaintiff's recovery in the action by the amount of any damage which he has suffered by the act or omission of the plaintiff growing out of the transaction or contract sued upon. The term originally signified a mere reduction of the amount of the recovery because of partial payment or former recovery, but in modern practice it denotes any affirmative claim for damages growing out of the cause of action brought which the defendant asserts as a defense for the purpose only of reducing the amount of the plaintiff's recovery, although he might at his option assert the claim in an independent action. Thus in an action



upon contract for the purchase price of goods, the defendant may recoup damages which he has suffered because of the plaintiff's breach of a collateral warranty of the quality of the goods; or in an action by a common carrier to recover freight money, the defendant may recoup for loss or injury to the goods resulting from a violation of the plaintiff's obligation as a common carrier. In an action upon contract damages recouped may be for tort, or vice versa provided the recoupment grows out of the transaction sued upon. Recoupment differs from 'set-off' and counterclaim.

Recoupment is a common-law doctrine and has become established in the several States of the United States by judicial decision. The exact limits of the application of the doctrine vary considerably in the different States, and a discussion of the rules of the different States would involve the consideration of technical details not within the scope of this article. In many States, particularly those having codes of civil procedure, there are statutory forms of counterclaim which include both recoupment and set-off. See SET-OFF; COUNTERCLAIM.

RECOVERY. See COMMON RECOVERY.

RECREATION PIERS. In several American cities, wharves reserved for the use of the public and designed to supplement the park system of the city as breathing places for the inhabitants of the congested districts. Those in New York City may be taken as typical. In 1892 the Legislature provided that certain docks in the city of New York be set aside as 'recreation' piers and that these be covered with permanent structures, the upper story to be wholly free to the public, while the lower decks were to be devoted to the exigencies of trade. The first pier was completed in 1896, and in 1903 there were seven such in Greater New York, situated as follows: East Third Street, East Twenty-fourth Street, East 112th Street, Christopher Street, West Fiftieth Street, and West 129th Street, in the Borough of Manhattan, and North Second Street in Brooklyn. Fireproof pavilions of steel have been erected on all of these piers, which vary in length from 200 feet to 722 feet (at East Third Street). Seats are provided for the use especially of mothers and children, and in the evenings there is music, and frequently dancing. The attendance at the East Third Street pier during the first year was estimated as ranging from 500 to 2000 in the afternoon, and from 3000 to 7000 in the evening. The piers are naturally open only during warm weather, but at East Third and East Twenty-fourth streets there are glass inclosures so that these may be utilized for winter-garden purposes.

RECRUITING OFFICER, THE. A comedy by George Farquhar, produced in 1706. The military scenes are sketches from life, drawn from Farquhar's experience in the army. The title-character is Sergeant Kite.

RECRUITMENT (Fr. *recrutement*, from OF. *recruter*, Port. *recrutar*, *reclutar*, from ML. *reclutare*, to recruit, patch, mend, from Lat. *re-*, back again, anew + *AS. clūt*, from Welsh *clwt*, Ir. Gael. *clud*, Manx *clooid*, clout, patch), MILITARY. The raising of men for military service. Recruitment of armies in general is by voluntary enlistment (the method adopted by the United States and Great Britain) or by con-

scription, or compulsory enlistment (the system in use on the Continent of Europe). The recruiting system of Germany is the model for nations adopting compulsory service. The country is divided geographically into as many corps districts as there are army corps (the latter are more or less permanently located), and these are subdivided into division, brigade, regimental, battalion, and company districts. Each company is recruited in its own geographical district. Each brigade district has also from two to six *Landwehr* (the reserve of the active army on the war footing) districts, which are the units of recruitment for this body. The recruits are examined by a commission of civil and military officers. Those physically, mentally, or morally unfit are rejected; the rest draw lots, the lower numbers being taken to fill the annual contingent, the higher passing to the Erastz Reserve (a reserve of recruitment). Ordinarily the young men are not called out till they are twenty years of age nor after they are forty. Between seventeen and twenty and over forty they belong to the *Landsturm*, the last reserve of the Empire. After completing his term of service in the ranks the soldier passes into the reserve of the active army, retaining his place in his regiment, borne on its books, and liable to recall till about twenty-six years old; he then passes to the *Landwehr* battalion of the district, the *Landwehr* command keeping the register of names and addresses. The special method of recruitment for an army in the field, now adopted by all nations, whatever the general system of recruitment may be, is by so-called *depot* battalions, etc., which remain in the home country and receive and train all the recruits for a particular regiment, etc. The methods for recruitment used in the United States will be found discussed under ENLISTMENT, where information as to the qualifications of recruits is given. The accompanying illustration shows a circular used in the American Revolution to obtain recruits. See ARMIES; ARMY ORGANIZATION; etc.

RECTANGLE (OF., Fr. *rectangle*, from Lat. *rectiángulum*, right-angled triangle, from *rectus*, right, straight + *angulus*, angle). A parallelogram having four right angles. See PARALLELOGRAM; MENSURATION.

RECTIFYING. See DISTILLED LIQUORS.

RECTOR (Lat., ruler, director). An ecclesiastical and academic title, meaning in the former sense a clergyman who has the charge of a parish and full possession of all the consequent rights and privileges. In the Church of England a rector differs from a vicar in that the latter is entitled only to a certain portion of the ecclesiastical income specially set apart to the vicarage. The office of rector as developed in England was carried over to the American colonies, where, however, a unique development came about. Under the American civil church law (q.v.) the parishes of the Protestant Episcopal Church, like the religious societies of other denominations, received civil incorporation, and the American rector, instead of continuing to be regarded, like the English, as a corporation sole, became *ex officio* the president of a corporation constituted of the rector, wardens, and vestrymen. To the rector belongs the possession and use of the temporalities of the parish, but only for the service of the church. In the Roman Catholic

Church the title of rector is frequently given to a parish priest or to the superior of a college or a religious house, more especially the superior of a Jesuit seminary or college. A 'missionary rector' in this Church is a priest appointed by the bishop to certain parishes in England, and in the United States to the charge of any parish. Some few are known as 'irremovable rectors'; these cannot be transferred to other parishes or removed for any other cause than proved misconduct.

In academic usage the title of rector is given in many places to the head of a college or of a university. In this sense it was employed by the colonial institution of America until the middle of the eighteenth century, for instance, the head of Yale College was called rector.

RECTUM (abbreviation of Lat. *rectum intestinum*, straight intestine). The lowest (or, in animals, the most posterior) part of the large intestine. Some anatomists include the sigmoid flexure of the large gut as a part of the rectum. In this view, the first part of the rectum consists of a loop beginning in the left iliac fossa and ending opposite the third piece of the sacrum. When unfolded this loop resembles the Greek capital letter omega, and is about 17½ inches in length. It lies wholly within the pelvis, and it is attached by a meso-colon to the abdominal and pelvic wall. The remaining part of the rectum extends from the middle of the third piece of the sacrum to the anus. The term rectum should be limited to this portion, free of meso-colon, lying in the hollow of the sacrum to the tip of the coccyx, thence curving backward and downward to the anal orifice. The portion that lies against the sacrum is about 3½ inches long, the remaining part about 1½ inches long. The upper part of the rectum proper is covered with peritoneum, which ceases at a point five inches above the anus. The structure of the rectum is considered under **INTESTINE** (q.v.).

RECTUM, DISEASES OF THE. The rectum is the seat of a number of congenital deformities. Imperforate anus or entire abscess of the anus is sometimes found in newly born children. Occasionally the rectum opens into the vagina or urethra. These conditions have to be met with prompt surgical measures. An imperforate anus is punctured or incised and kept open by bougies until healing takes place, and a preternaturally narrowed rectum or anus is dilated with rectal sounds, or with the finger. Sometimes an artificial anus has to be made, either at the natural site or higher up in the inguinal region. In feeble or ill-nourished children prolapse of the rectum or anus is apt to occur from diarrhoea and excessive straining at stool, or in connection with worms, stone in the bladder, or other irritation. Prolapse is reduced by the application of cold compresses, and gentle replacement of the protruding tissue with the fingers. It is then retained by a pad, and recurrence is combated by the use of astringent and antiseptic injections. A perfect cure, however, is only to be secured by the removal of the causative condition.

Adults are subject to numerous disorders of the rectum. Inflammation (proctitis) results from constipation and from chronic diarrhoea and dysentery. Ulceration of the rectum may be due to abrasions from hardened fecal masses, to syphilis, or to tuberculosis; it may be single or

multiple. Ulcers are treated locally by cleansing and astringent injections, with constitutional remedies adapted to the individual case. Spasm of the rectum (proctospasm) or sphincter ani is a not uncommon manifestation of neurasthenia and hysteria, but its most usual causes are anal fissure and hemorrhoids. Stricture, which may result in complete occlusion, may be simple or malignant. It is often caused by cancer of the rectum. When due to cancer the pain is intense and lancinating, and the patient has an emaciated appearance. The stools are often flattened out like ribbons, and contain blood and mucus. Stricture of the rectum is best treated by laxatives, cleansing injections, and by gradual dilatation with soft rubber bougies. In the case of cancer, however, these measures are only palliative. Here it is often necessary to remove a part or all of the rectum and stitch the colon to the edges of an artificial opening in the abdominal wall at the groin, thus forming a new anus. Patients can thus live in comparative comfort.

Fissure of the anus is a crack at the anal opening, producing spasm of the sphincter muscle. It causes violent burning pain during defecation, and the dread of this suffering results in voluntary inaction of the bowels and habitual constipation. Intense itching often accompanies fissure. Strict cleanliness and the application of healing ointments usually suffice to cure this condition. Touching with the point of a stick of lunar caustic is a valuable remedy. Fistula in ano consists of the unhealed track of an abscess adjacent to the lower part of the rectum on the verge of the anus. An abscess in this region heals with great difficulty, because of the constant movement of these parts and the passage of feces, which reinfect and irritate it. Fistula is not uncommonly associated with hemorrhoids, cancer, or stricture. These are the varieties of fistula: The *blind external* terminates in a cul-de-sac near the bowel and opens at or near the margin of the external sphincter; the *blind internal* fistula opens into the bowel and has no external orifice; the *complete* has both an internal and an external opening. The symptoms are passage of wind and feces through the opening and of a discharge which stains the clothing. Repeated attacks of inflammation ensue and new abscesses form. Treatment in all varieties of fistula is free incision and cutting out of the fistulous tract. See **FISTULA**.

Hemorrhoids or piles are venous tumors situated either within, without, or on the margin of the anus, and are caused by congestions and inflammation of the abundant vascular areas of the rectum. (See **PILES**.) Polypus of the rectum is a tumor attached by a narrow pedicle, and originating in a relaxed fold of the mucous membrane, or in granulation tissue springing from an ulcer, or in a mass of hemorrhoids. The only remedy is removal.

Pruritis of the anus is a symptom of many diseases, both local and distant. It may and often does accompany such widely diverse affections as piles, fissure, seat worms, eczema, nerve disturbances, Bright's disease, jaundice, constipation. The itching is almost unbearable and is worse at night. The general treatment will depend on the exciting cause. Locally sedative lotions and ointments are employed and strict cleanliness observed. Eczema (q.v.) often affects this region.

RECUSANT (OF. *recusant*, Fr. *récusant*, from Lat. *recusare*, to reject, from *re-*, back again, anew + *causa*, cause). In English ecclesiastical legislation, any person who refuses to attend the services of the Established Church. Laws against recusants have borne most heavily upon Roman Catholics, who in earlier times were generally suspected of plotting against the Government and the person of the sovereign. The first of such laws was passed under Elizabeth in 1581, but the culmination of such legislation in her reign was in 1593. A law passed in that year read that all Popish recusants over sixteen years of age must "repair to their places of dwelling where they usually heretofore made their common abode, and shall not, at any time after, pass or remove above five miles from thence." If they did remove, their goods were forfeited to the Crown. A careful list was made of all such persons. If they had no property they were required to leave the country, upon penalty of being treated as felons. If they made public submission, they were to be absolved. Consult the act in Gee and Hardy, *Documents Illustrative of English Church History*, pp. 498-508 (London, 1896). The Popish recusants still being considered a source of danger after Elizabeth's reign, additional and more stringent laws were passed against them. Thus in the third year of King James (1606) there were two such acts, "for the better discovering and repressing of Popish recusants;" and "to prevent and avoid dangers which may happen from Popish recusants;" in the twenty-fifth year of Charles II. (1685), one "for preventing dangers which may happen from Popish recusants;" and there were similar laws under William and Mary and Anne. All such legislation was abrogated in the reign of Victoria.

RED. One of the three primary colors, the rays of which are least broken, and which is, consequently, at the end of the spectrum (q.v.). It is much used, as well in the fine arts as in dyeing and other applied arts. The mineral, animal, and vegetable kingdoms contribute the materials from which red colors are derived. The mineral world furnishes vermilion and the red ochres; the animal, carmine, scarlet, and others; and the vegetable, the different madder pigments. (See these titles.) Since 1848 the term red, as being the color of blood, has been applied by their opponents to the radical parties, especially in France. The red flag has been adopted as the emblem of their creed by the Social Democrats the world over.

RED ADMIRAL. See ADMIRAL and Colored Plate of BUTTERFLIES.

REDAN (OF. *redun*, *redent*, Fr. *redan*, from Lat. *re-*, back again, anew + *dens*, tooth). A work in fortification which consists of two parapets, whose faces join in forming a salient angle toward the enemy, like a letter V, in which the apex is to the front. The construction is similar to a redoubt (q.v.). See FORTIFICATION; SIEGE AND SIEGE WORKS.

RED ANT. See HOUSE ANT.

RED-BACKED MOUSE, or WOOD-MOUSE. A small meadow-mouse (*Erotomys Gapperi*) of the wooded regions of Canada and the Eastern States, especially numerous in boggy regions. The color of the back is bright reddish chestnut, lightening below into buffy white. There is

also a Northern gray variety. These mice have the general habits of meadow-mice, but those of southern New Jersey inhabit exclusively the Sphagnum bogs, where they burrow deeply in the moss, making tunnels and nests below the frost-line.

RED-BACKED SANDPIPER. A shore-bird, the dunlin (qq.v.), also known to American gunners as 'winter snipe' and 'blackbreast.'

RED BANK. A town in Monmouth County, N. J., 26 miles south of New York City, with which it has steamboat connection; on the Shrewsbury River, and on the Pennsylvania and the Central of New Jersey railroads (Map: New Jersey, D 3). It is an attractive residential place and a popular summer resort. There are in Red Bank Shrewsbury Academy, and public and high school libraries. The leading manufactories include carriage shops, a clothing factory, a large canning factory, boiler works, and gold-beating establishments. Population, in 1890, 4145; in 1900, 5428.

RED BAT. A small North American bat (*Lasiurus borealis*) 4.4 inches long and 11 inches in expanse of wing. Its fur varies from bright rust-red to gray, with a whitish patch on each side of the breast. It is one of the commonest of our bats, dwells in dark eaves and garrets, and is more likely to come out in daylight than any other species. Those of the Northern States migrate southward in winter. It was formerly called the New York bat.

RED-BELLIED SNAKE. A common harmless snake (*Storeria occipitomaculata*) of the eastern half of the United States, allied to the garter snakes, but shorter and more robust; it is also called 'wampum-snake.' It is chestnut or grayish brown; a paler line, about three scales wide, runs along the spine; the hindhead shows three pale blotches, and the abdomen is salmon red. A nearly related species is DeKay's snake (*DeKayi*), but this is more grayish and has a gray belly. Another small red-bellied snake in the Mississippi Valley is Kirtland's (*Tropidoclonium Kirtlandi*), but its head is shining black, and lines of round black spots mark its whole length. A much larger species is the red-bellied water snake (*Natrix erythrogaster*), which is found in the Southern States and northward to Michigan. It reaches a length of 4 feet.

REDBIRD. A local name for many different birds of red plumage. In the United States the name is given to the tanagers and to the cardinal-bird (qq.v.).

REDBREAST. See ROBIN.

RED-BREASTED (or ROBIN) **SNIPE.** A dowitcher (q.v.).

REDBUG. A heteropterous insect (*Dysdercus suturellus*) which damages cotton and oranges in the Southern United States; also called cotton stainer. (See COTTON INSECTS.) The term 'redbug' is also applied in parts of the Southern United States to the larvæ of certain harvest mites, also called jigger.

REDCAP. A breed of domestic fowls, the largest of the Hamburg group, and long established in good repute.

RED CEDAR RIVER. See CEDAR RIVER.

RED CLOUD (translation of his native name, *Maappya-luta*) (c.1825—). A chief of the Ogala Sioux. He was born about 1825, and rapidly rose to the first rank in his band by his bravery and success upon the warpath and wisdom in council. He was active in wars with the Crow, Blackfoot, and other tribes, and fought against the Government in the war which began in 1863 and lasted almost continuously until 1868. With Sitting Bull he opposed the sale of the Black Hills in 1876, and also the agreement of 1889, by which the Sioux surrendered half of their remaining country. He supported the Messiah doctrine and the ghost dance in 1890. In his warrior days, according to his own statement, he 'counted coup' eighty times, i.e. performed eighty separate deeds of valor against the enemy, any one of which entitled him to some distinguishing badge of honor. His most notable encounter was an engagement with the Crows, in which he is said to have killed fourteen of the enemy. As a delegate for his people he made numerous visits to Washington.

RED CROSS, KNIGHTS AND LADIES OF THE. A fraternal and benefit order founded in 1879 by members of the Ancient Order of United Workmen and other societies. The order provides death, old age, and disability benefits, and claims to have an ample reserve fund to meet all contingencies. It is under the supervision of the Insurance Departments of the various States in which councils exist, and the rates for insurance are based on the Fraternal Congress Experience Table of Mortality. The ritual is founded on the life and teachings of Constantine the Great. The emblem of the order is a red Greek cross, surmounted by a crown with a white five-pointed star in the centre. The motto is 'Omnia pro caritate.' The total membership in 1902 was 427,426.

RED CROSS, ORDER OF THE. (1) A Russian order with two classes, established in 1878 at the close of the Turkish War. It is conferred on women only, and is bestowed by the Empress. (2) An English order founded by Queen Victoria, in 1883, for women who have distinguished themselves in the care of sick soldiers. It is conferred on foreigners as well as English women. The decoration is a golden cross bearing the words 'Faith, Hope, Charity,' and the date 1883.

RED CROSS KNIGHT, THE. The hero of the first book of Spenser's *Faerie Queene*, typifying holiness, and secondarily Saint George, also the Church of England. At first an awkward clown, when armed he becomes the "goodliest man in that company" and the champion of Truth (Una) against the dragon. Deceived by Archimago, he deserts Una for Duessa (Rome), and Una with the lion (Reason), meeting Archimago disguised as the Red Cross Knight, is deceived also. The real Knight is attacked by Orgoglio (Pride) and thrown into prison, from which he is rescued by Prince Arthur. After resting in the House of Holiness he wins the victory over the Dragon and marries Una.

RED CROSS SOCIETIES. International associations whose purpose is to mitigate the horrors of war by alleviating the sufferings of the sick and wounded. They are the result of an agitation begun by M. Jean Henri Dunant (q.v.), a philanthropic citizen of Geneva, Switzerland.

On June 24, 1859, he chanced to be present at the battle of Solferino and was an eyewitness to the vast amount of unnecessary suffering that resulted from the inability of the regular surgical corps to care for the thousands of wounded who lay upon the field. Three years later he published the widely read book, *Un souvenir de Solferino*, in which he vividly described the horrors he had witnessed and proposed that societies should be formed in every country in time of peace for the purpose of training nurses and collecting supplies so that when war broke out the work of the regular military surgical corps could be supplemented. M. Dunant's proposal was well received by the Genevan Society of Public Utility, and an agitation was begun which resulted in an international conference at Geneva in October, 1863. A provisional programme was agreed upon by the delegates of the sixteen nations that were represented, and in the following August a more formal diplomatic congress, composed of representatives from the same number of nations, was held in the same city. On the 22d of that month was signed what is known as the Geneva Convention (q.v.). Contrary to generally received opinion, the Convention makes no direct provision for the organization of Red Cross societies, but it renders such societies possible; and at the previous conference it had been stipulated that each nation which should ratify the Convention should have one national committee or society, civil in its character and functions, which should alone have the right to authorize the sending of surgical corps to a war. The Convention was quickly ratified by fourteen nations, a number that has now been increased to forty-three, and thus its provisions have come to be a recognized part of international law. During the Servian War of 1876 the Turkish Government notified the signatory powers that it had adopted the crescent instead of the red cross as the badge of its societies, and Russia, which shortly afterwards entered the conflict, agreed to accept the substitution provided Turkey would respect the red cross of her adversaries.

When the American National Red Cross Society was formed in 1881 (the Convention was ratified by the United States in the following year) its president, Miss Clara Barton (q.v.), decided that its usefulness should be widened by including not only relief during war, but also during great calamities, such as famine, pestilence, flood, or fire. This new feature received the unanimous sanction of the international and national committees. In carrying out the idea the American Association has expended about \$2,000,000 since its organization, and has afforded valuable relief to the sufferers from the Michigan fires of 1881, the Florida yellow fever of 1888, the Johnstown flood of 1889, the Russian famine of 1891-92, the South Carolina tidal wave of 1893, the Armenian massacres of 1896, the Spanish reconcentrado system in Cuba in 1897-98, the Galveston tidal wave of 1900, the Mont Pelée eruption of 1902, and other disasters. The assistance which the association rendered during the Spanish-American War of 1898 should also be mentioned.

It was soon found that the Convention of 1864 was in certain respects inadequate and that some revision was desirable. In 1867 the first

International Red Cross Conference, held at Paris, proposed such a revision, and in the following year a diplomatic congress convened at Geneva to consider the matter. This congress agreed to add a few supplementary clauses, one of which provided that the principles of the Convention should be applied to naval warfare. Owing to the Franco-Prussian War and to other causes, however, the clauses were not ratified by the powers and consequently had no binding force as international law. It was not, in fact, until the Hague Peace Conference of 1899 that it was agreed to apply the principles of the Convention to war upon the seas. At other international conferences of the Red Cross Societies, at Berlin in 1869, Geneva in 1884, Karlsruhe in 1887, Rome in 1892, Vienna in 1897, and Saint Petersburg in 1902, other subjects for amplification were discussed. Among these were the relations of the Red Cross to the army, the means that should be taken to impress upon the soldiers the necessity of respecting the red cross, and the measures that would best prevent the abuse of the emblem by persons who might make use of it to cloak hostile designs. This last subject, in particular, was much discussed during the South African War. All the conferences have, however, been hampered by the fact that they can only recommend changes; in order to become an integral part of international law such changes must be ratified by the nations.

The various national Red Cross associations are not intimately connected, but the society at Geneva is regarded as the central committee of all. Through it all international communications are made, and by it an international bulletin is published. Many of the national committees also issue publications. The president of the Geneva Committee is Gustave Moynier; that of the American national organization is Miss Clara Barton.

BIBLIOGRAPHY: Moynier, *Etude sur la convention de Genève* (Paris, 1870); id., *La Croix-Rouge, son passé et son avenir* (ib., 1882); Du Camp, *La Croix-Rouge de France* (ib., 1889); Ariga, *La Croix-Rouge en extrême orient* (ib., 1900); Lueder, *Die Genfer Convention* (Erlangen, 1876); id., *La convention de Genève au point de vue historique, critique et dogmatique* (ib., 1877); Criegien, *Das rothe Kreuz in Deutschland* (Leipzig, 1883); *The Red Cross of the Geneva Convention: What It Is, Its Origin and History* (Dansville, N. Y., 1881); Barton, *History of the Red Cross* (Washington, 1883); id., *History of the Red Cross in Peace and War* (New York, 1898); *Bulletin international des sociétés de la Croix-Rouge*, published four times a year by the International Committee of Geneva; *Memorial des vingt-cinq premières années de la Croix-Rouge, 1863-1888*, published by the same committee; and *American National Red Cross Relief Committee Reports* (New York, 1898; 2d ed. 1899).

RED DEER. The common deer of Europe, the males of which are the 'stags' hunted in Scotland and elsewhere. See DEER; DEER-STALKING.

RED'DING. A city and the county-seat of Shasta County, Cal., 170 miles north of Sacramento, on the Sacramento River, and on the Southern Pacific Railroad (Map: California, B 1). The court house and sanatorium are note-

worthy features of the city. Redding is situated in a mining and lumbering section, and manufactures lumber, foundry and machine-shop products, etc. Population, in 1890, 1821; in 1900, 2946.

RED'DITCH. A town in Worcestershire, England, on the Arrow, 13 miles southwest of Birmingham (Map: England, E 4). It is the centre of the needle-manufacturing industry, and pins, fish-hooks, and fishing tackle also are largely made. The municipality owns its electric lighting plant. Population, in 1891, 11,300; in 1901, 13,500.

REDDLE (also *raddle*, *ruddle*, from AS. *rudu*, redness, from *rēad*, red), or RED CHALK. An ochreous red iron ore used for making crayons and as an abrasive for polishing glass.

REDEEMER, ORDER OF THE. A Greek order founded in 1829 and reorganized by King Otto in 1833. Its membership consists of persons distinguished in the War of Liberation, and in commerce, industry, science, or art. The decoration is a white cross on a green wreath of oak and laurel; on the medallion is an image of the Saviour. The reverse bears the Greek cross. See PLATE OF ORDERS.

REDEMPTION (Lat. *redemptio*, from *redimere*, to buy back, redeem, from *red-*, *re-*, back again, anew + *emere*, to buy). In law, the determination of a creditor's right in property, real or personal, by the discharge of the obligation for which the property is held. The term is most frequently employed to denote the release of a pledge or mortgage. In either case the legal interest of the creditor (pledgee, mortgagee) is terminated *ipso facto* by the performance by the debtor of his obligation or the legal tender thereof, and thereafter the possession of the creditor is wrongful. See PLEDGE; CONDITION; EQUITY OF REDEMPTION; FORECLOSURE, etc.

REDEMPTIONISTS. See TRINITARIANS.

REDEMPTORISTS (Fr. *rédeemptoriste*, from Lat. *redemptor*, redeemer, from *redimere*, to buy back, redeem), also called LIGORIANS. A congregation of missionary priests founded in 1732 by Saint Alphonsus Liguori (q.v.). The members of the Congregation of the Most Holy Redeemer were bound to seek their own perfection by the obligations and rules of a religious life and to devote themselves to apostolic work among the most neglected and forsaken souls, especially in country places. The instructions given by the members are of the simplest and plainest character. The congregation was originally founded in Naples, but being approved by Benedict XIV. in 1749, spread rapidly throughout Italy and afterwards extended into Germany and Switzerland. The suppression of the Jesuits in 1773 left a hiatus in missionary fields which the Redeemtorists were called upon to fill. By the end of the eighteenth century the congregation had spread throughout most of the countries of Europe and in the early part of the nineteenth century houses were established in North and South America and in Australia.

Saint Alphonsus founded also an Order of Nuns called Redeemptoristines. This is a strictly contemplative Order with a number of convents in Italy, three in Austria, four in Belgium, three in Holland, two in France, and one in Ireland. For their constitution and early history, see Dumor-

tier, *Les premieres Redemptoristines* (Lille, 1884).

The Redemptorists are noted for their faculty of doing effective missionary work among the uncultured classes of the population. Their missionary system includes frequent 'renovations' in order effectively to secure the good already done, and the frequent reception of the sacraments is recommended for the perpetuation of the fruit of the missions. According to the latest official catalogue of the Redemptorist Order (1901) there are 16 provinces and one vice-province of the congregation. These are known as the Roman, Neapolitan, Sicilian, Lyonesse (which has houses in Chile and Peru), the Austrian, the Belgian (which has houses in Canada, in the West Indies, and in the Congo region), the Baltimore (which has a mission in Mayaguez, Porto Rico), the Bavarian (with two houses in Brazil), the Province of Holland (which has a mission in Surinam), the Lower German (with three houses in the Argentine Republic), the English, the Irish (with three houses in Australia), the Province of Paris (with three houses in Ecuador and Colombia), the Spanish, and the Province of St. Louis, U. S., besides the Province of Prague in Bohemia, and the Vice-Province of Alsace-Lorraine. Altogether there are 175 houses, with 3300 members, of whom 1620 are priests, 489 clerical students, 150 choir novices, 733 professed lay brothers, and 300 lay novices. In the United States there are 520 members, of whom 270 are priests. For the history of the Order in America, consult Wuest, *Annales Provinciae Americanae* (Hchester, Md., 1888).

REDFIELD. A city and the county-seat of Spink County, S. D., 40 miles south of Aberdeen; on the Chicago and Northwestern and the Chicago, Milwaukee and Saint Paul railroads (Map: South Dakota, G 5). It is the seat of Redfield College (Congregational), opened in 1887, and of the Northern Hospital for the Feeble-Minded, a State institution. Population, in 1890, 796; in 1900, 1015.

REDFIELD, WILLIAM C. (1789-1857). An American man of science and affairs, born at Middletown, Conn. In 1820 he became interested in steam navigation and after studying numerous boiler explosions which at that time were alarming the public, he founded a line of *safety barges* towed by a steamer at a safe distance to ply between New York and Albany. After public confidence had been restored this line was utilized for the carriage of freight and became the predecessor of the lines now in operation. Mr. Redfield was also active in beginning the New York and Albany, now the Harlem Railroad, and the New Haven and Hartford and the Hudson River railroads; and as early as 1829 he proposed the construction of a road connecting the Mississippi with the Hudson. In science, though he devoted some attention to geology, his principal contributions were in the field of meteorology. He developed a theory of storms by which he sought to demonstrate that all violent gales are whirlwinds and have a rotary and progressive movement; that the direction of revolution is always uniform; and that the velocity of rotation increases from the margin toward the centre of the storm. He reorganized the American Association of Naturalists and Geologists as the American Association for

the Advancement of Science, and became its first president in 1843. Among his publications are "Remarks on the Prevailing Storms of the Atlantic Coast of the North American States" (*American Journal of Science*, vol. xx.); "Notice of American Steamboats" (ib., vol. xxiii.); "On the Courses of Hurricanes" (ib., vol. xxxv.); "Short Notices of American Fossil Fishes" (ib., vol. xli.); and "The Law of Storms and Its Penalties for Neglect" (*New York Journal of Commerce*, June 19, 1850). Consult Ohmsted, *Scientific Life and Labors of William C. Redfield* (New Haven, 1857).

REDFIN. The name given to two or three dace or minnows, which have notably red fins, and especially to the common shiner (*Notropis cornutus*), found in almost every small stream east of the Rocky Mountains and north of Georgia. It exhibits many local varieties of form and color, some never exceeding four inches, while others reach eight inches in length. It may be distinguished from other shiners by its large size, steel-blue back, with a gilt line along the spine, and another along each side, and the rosy tint of the lower fins. Compare SHINER; and see Plate of DACE AND MINNONS.

REDFISH. (1) The red drum or channel bass' (*Sciaenops ocellatus*). It is a rich iridescent gray in color, often washed with coppery red, and

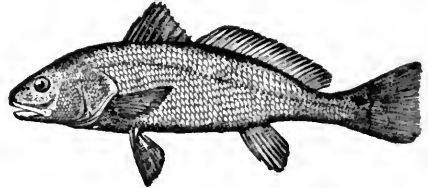

REDFISH OR CHANNEL BASS.

reaches a length of five feet and a weight of 75 pounds, but is usually much smaller. It is to be found along the whole southern coast of the United States, is everywhere valuable as a food-fish, and on the Texas coast is said to exceed in economic importance all other fishes found there. (2) In southern California, a large and handsome fish (*Pimelometopon pulcher*) related to the doncellas. The body is somewhat deep and compressed, and the blunt forehead in the adult carries a very prominent fatty hump, whence the fish is frequently called 'fathead.' In the males the head, dorsal, anal, and caudal fins are purplish-black, and the rest of the body varies from clear crimson to blackish-purple. The females are dusky rose-color. This handsome fish, which reaches a length of three feet and a weight of 13 to 15 pounds, is caught abundantly with hook and line in the kelp beds along the shore, and is a favorite with the Chinese, who salt and dry its flesh. (3) One of the most important and richly colored of the Californian rosefishes (*Sebastes marinus*). See ROSEFISH. (4) The Alaskan name for the 'red' or blue-back salmon (*Oncorhynchus nerka*). It is known in two forms, one large and one small. See SALMON.

RED GAME, or GROUSE. The common moor-fowl or ptarmigan (*Lagopus Scoticus*) in its summer dress. See GROUSE; PTARMIGAN.

REDGAUNTLET. A novel by Sir Walter Scott (1824). The hero, Sir Arthur Redgauntlet, brought up as Darsie Latimer, falls unknow-

ingly into the hands of his uncle, an ardent Jacobite, and is forced into the plot to restore the Pretender, Charles Edward. After the failure, Mr. Redgauntlet follows the Pretender to France, where he retires to a monastery. Sir Arthur, now in possession of his estate, bestows his sister on his faithful friend and rescuer, Alan Fairford.

RED GRAVE, RICHARD (1804-88). An English genre and landscape painter, born in London. After exhibiting the "River Bent, Near Hanwell" at the Royal Academy in 1825, he was admitted to its schools the following year. In 1850 he was made Royal Academician. He was head master of the school of design in 1848 and art superintendent in 1852. In 1857 he was made inspector general of art schools and surveyor of Crown positions, holding the latter position until 1880. Among his paintings are "Gulliver on the Farmer's Table" (1837); "Quinten Matsys, the Blacksmith at Antwerp" (1839); "Ophelia" (1842), one of his best figure pictures; "Country Cousins" (1848, National Gallery); and "Hidden Among the Hills" (1881). Redgrave is author of *An Elementary Manual of Colors* (1863). His brother, **SAMUEL** (1802-76), studied architecture at the Royal Academy in 1833, but is best known as a manager of a number of important art exhibitions, and especially as an author on art topics. Assisted by his brother, he published *A Century of Painters of the English School* (1866). He also prepared a *Dictionary of Artists of the British School* (1874).

REDHEAD. A numerous and widespread American duck (*Aythya Americana*), closely allied to the canvasback, but differing from it in having the head chestnut red and in other par-

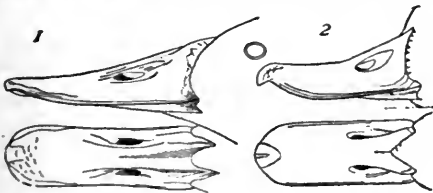

1. BEAK OF CANVASBACK. 2. BEAK OF REDHEAD.

ticulars given under **CANVASBACK** (q.v.); also in the shorter bill, as illustrated herewith. They appear in great numbers in spring and fall, especially about fresh-water marshes, assembling in large migratory flocks and keeping close together; but they are strong, hardy birds and swift fliers. Early in March they hasten northward to breeding places in Canada. They are excellent eating, and are constantly substituted by dishonest gunners and caterers for the highly prized canvasback. Consult: Elliot, *Wildfowl of the United States and British Possessions* (New York, 1898); Job, *Among the Waterfowl* (New York, 1902); and books relating to shooting.

REDHOUSE, SIR JAMES WILLIAM (1811-92). An English Orientalist and diplomat, born near London, and educated at Christ's Hospital. He entered the employ of the Turkish Government as a draughtsman in 1826, and in 1838, after various travels, became translator to the Grand Vizier. In 1854 he was appointed Oriental translator to the British Foreign Office, and in 1857 at Paris he took a prominent part in the treaty with Persia. His great work, a dictionary of Persian, pure Turkish, and Arabic, was left un-

finished and in manuscript. His published works include: *Grammaire raisonnée de la langue Ottomane* (1846); *A Dictionary of Arabic and Persian Words Used in Turkish* (1853); *English-Turkish and Turkish-English Dictionary* (1856); *Lexicon of English and Turkish* (1861); *History, System, and Varieties of Turkish Poetry* (1880); and a version of Merlana's *Mesneri* (1881).

REDINTEGRATION (Lat. *redintegratio*, from *redintegrare*, to restore, from *red-*, re-, back again, anew + *integrare*, to make whole, from *integer*, entire, from *in-*, not + *tangere*, to touch). A term first introduced into the psychology of association (q.v.) by Hamilton, for whom it meant the reinstatement, through the suggestion of one element, of all the elements which had previously constituted an act of cognition. A tendency has, however, arisen in modern psychology to restrict the word to those cases of association in which a constituent part of an original situation associatively reinstates the total situation. James calls such cases 'impartial redintegration.' Whether impartial redintegration ever occurs in complete form is more than doubtful; as a functional type of the reproducing consciousness it may, however, be usefully distinguished from 'mixed' association and 'focal' association. Consult: Hamilton, *Lectures on Metaphysics*, vol. ii. (Edinburgh, 1859); Reid's *Works*, vol. ii., Notes, edited by Hamilton (ib., 1863); James, *Principles of Psychology* (New York, vol. i., 1890); Hodgson, *Metaphysics of Experience* (London, 1898).

RED JACKET. A village in Houghton County, Mich., 14 miles north of Houghton; on the Mineral Range, the Copper Range, the Chicago, Milwaukee and Saint Paul, and the Chicago and Northwestern railroads (Map: Michigan, E 1). It is noted for its mining interests, being situated in the highly productive copper region of northern Michigan. Population, in 1890, 3073; in 1900, 4668.

RED JACKET (*Sa-go-ye-wat-ha*, 'he keeps them awake') (c.1751-1830). A celebrated chief of the Seneca Indians. He received his English name in reference to the great pride he took in a scarlet jacket given to him shortly after the Revolution, by an English officer. During the Revolution he fought on the side of the English, and in 1784 bitterly opposed the Treaty of Fort Stanwix, by which the Iroquois ceded some of their land to the United States. Though originally without rank in his tribe, he soon, through his eloquence in council, became one of the principal chiefs. In 1810 he gave the United States Government some valuable information concerning the schemes of Tecumseh, and during the war on the frontier (1811-14) assisted the United States troops. Subsequently he became a confirmed drunkard, and for this and other reasons was deposed by a council of chiefs in 1827, but was soon restored to his old rank. He was never prominent as a warrior and seems to have been a coward, but as an orator he was unrivaled, and in council had the greatest influence. By many he has been considered the most eloquent speaker the Indian race ever produced. Though at first in favor of the education of his people, he subsequently changed his mind and became the bitterest opponent of schools and of Christianity. He has been called "the last of the Senecas," he having been the last of that tribe's great chiefs.

Consult the biography by Stone (1867), and that by Hubbard (1886).

REDLANDS. A city in San Bernardino County, Cal., 68 miles east of Los Angeles; on the Santa Fe, the Southern Pacific, and the San Bernardino and Redlands railroads (Map: California, E 4). It is situated among the foothills of the San Bernardino Mountains in one of the most beautiful regions of the State. Among the features of the city are the A. K. Smiley Library and two attractive parks. The vicinity is known as one of the greatest orange-producing sections in the world, and for the shipment of this and other fruit Redlands is an important centre. It carries on a trade also in barley, wheat, and building stone, and manufactures brick, piping, and lumber products. The city is governed by a board of trustees, one of whom is the president, whose term of office is four years. Redlands was settled in 1881, and was incorporated seven years later. Population, in 1890, 1904; in 1900, 4797.

REDLEG. The red-legged partridge. See PARTRIDGE.

RED-LETTER DAY. A lucky day, a fortunate or auspicious day; so called because in the old liturgical books the greater holy days were always marked with red letters. See RUBRIC.

RED LIQUOR. A crude aluminum acetate used as a mordant in calico printing. It is prepared in various ways, often by dissolving eight parts of alum in boiling water, which is then added to a solution of six parts of lead acetate and the mixture is well stirred. Lead sulphate is formed, which is precipitated as a heavy mass, the supernatant clear liquid being the 'red liquor.'

RED MEN, IMPROVED ORDER OF. A fraternal and beneficial order claiming unbroken succession from the 'Sons of Liberty' (q.v.), and other Revolutionary societies, and reorganized in 1835 at a convention in Baltimore. The Grand Council of Maryland was created at this convention, the old ritual was revised, and soon the council-fires of the order were lighted in several States of the Union. In 1847 the Grand Council of Maryland called another convention at which was organized the Great Council of the United States, which was made the supreme governing body of the order. The government of the order is modeled after that of the United States. The Great Council of the United States is composed of representatives of the various State Grand Councils, which in turn are made up of representatives from the various tribes in the State jurisdiction. The ritualistic work consists of three degrees, viz.: Adoption, Warrior, and Chief. The officers of the tribe are prophet, sachem, senior sagamore, junior sagamore, chief of records, and keeper of wampum. The officers or chiefs of the Great Council of the United States are great inehonee, great senior sagamore, great junior sagamore, great prophet, great chief of records, great keeper of wampum, great toekon, great minewa, great guard of forest. The conditions of membership are: age twenty-one years, citizenship in the United States, good health and character, and belief in the existence of a Supreme Being, 'the Great Spirit.' There is a Chieftain's League or Uninformed Rank in the order. The Degree of Pocahontas is for the especial benefit of the female relatives of the Red Men, who are eighteen years of age and over. The Improved Order of

Red Men (including the Degree of Pocahontas, which has a membership of 50,000) had at the close of 1902 a total membership of over 300,000. During the decade ending that year it had paid for the relief of members nearly \$4,000,000, for the relief of widows and orphans \$125,000, and for the burial of the dead nearly \$1,000,000. The emblem of the order is the eagle and the motto, 'Freedom, Friendship, and Charity.'

REDMOND, JOHN EDWARD (1851—). An Irish Parliamentary leader, head of the Nationalist Party. He was born in Dublin, the son of William Archer Redmond, and at twenty-five, after the completion of his course in Trinity College, Dublin, having been admitted to the bar, was elected to the House of Commons. There he became a whip of the then weak Irish Party and was one of the most prominent organizers of the Home Rule propaganda throughout England. On the break in the Nationalist ranks, consequent on the Parnell divorce case, Redmond sided with the minority which urged that Parnell's leadership should still be followed; but in 1900, in spite of his bitter abuse of the other wing of the Irish Party, he became a leader in the movement for union and was chosen to succeed Dillon as head of the reorganized party. His *Historical and Political Addresses, 1883-97*, were published in 1898.

RED OAK. A city and the county-seat of Montgomery County, Iowa, 50 miles east by south of Omaha, Neb.; on the East Nishnabotna River, and on the Chicago, Burlington and Quincy Railroad (Map: Iowa, B 4). It makes brick, tile, apiary supplies, pottery, and flour. Red oak was incorporated in 1869. Population, in 1890, 3321; in 1900, 4355.

REDONDELA, rā'dón-dá'lá. A town of Northwestern Spain, in the Province of Pontevedra, situated at the head of the Bay of Vigo, 12 miles south of Pontevedra. The inhabitants are chiefly engaged in fisheries. Population, in 1900, 11,488.

REDOUBT (OF. *reduit*, Fr. *réduit*, from ML. *reductus*, refuge, redoubt, from Lat. *reducere*, to lead back, from *re-*, back again, anew + *ducere*, to lead). A field fortification. A redoubt varies in form and solidity according to the exigencies of the case, and the time at the disposal of the defenders. The cavity caused by the excavation of earth for the construction of the parapet is called the ditch, and constitutes a formidable obstacle to the enemy. The sides of the ditch are known as the escarp and the counterescarp, respectively (see Plan in article FORTIFICATION), and are made as steep as possible. Chevaux-de-frise (q.v.) or similar constructions are placed along the bottom of the ditch. If the parapet is very high, a berm (q.v.), or narrow strip, will be left between the base of the parapet and the edge of the ditch, and generally fortified by *fraizes*, or sharp-pointed stakes, projecting over the ditch, from both berm and counterescarp. The exterior slope of the parapet has been found to resist artillery fire to greater advantage when left at its natural slope; but the superior slope is constructed with an incline of 1 in 6, permitting the defenders to observe the ground in front of the ditch without injuring the crest of the parapet. The interior slope (1 in 3 or 4) is strongly revetted. In field redoubts, the height of

the parapet rarely, if ever, exceeds 12 feet. Traverses (q.v.) are constructed similarly to the parapet, and are usually thrown across the covered way or other important points as a protection against enfilade fire, or (as *parados*) to defend the troops garrisoning the rear face from fire coming from the front. See SIEGE AND SIEGE WORKS.

REDOWA (Bohemian *rejďowák*, *rejďowachka*, from *rejďowati*, to turn around). A Bohemian dance introduced into Paris and London about 1846. In Bohemia two varieties exist: the *Rejďovák* in $\frac{3}{4}$ or $\frac{3}{8}$ time, and the *Rejďovacke* in $\frac{3}{4}$ time. The dance resembles the Polish mazurka. Meyerbeer introduced it into his opera *Le prophète* in 1849.

REDPATH, JAMES (1833-91). An American journalist and political writer, born in Berwick-on-Tweed, Scotland. He came to New York at eighteen and the next year joined the staff of the *Tribune*. His articles on the effects of slavery on society and on production caused him to be denounced as an abolitionist. In 1859 he made two visits to Haiti, where he was appointed Commissioner of Emigration. Returning to America, he founded a Haitian bureau and published a weekly newspaper, *Pine and Palm*, to advocate the emigration movement of negroes from America to Haiti, in which he induced several thousands to participate. During the war he was with the armies of Sherman and Thomas. At Charleston he was made Superintendent of Education, reorganized the school system of South Carolina, and founded the Colored Orphan Asylum. During the Irish famine of 1881 he represented the New York *Tribune* in the famine district, and afterwards lectured on Irish subjects in the United States and Canada, founded *Redpath's Weekly* (1881-83) to promote the Irish cause, and edited the *North American Review*. Among his books are: *Hand-book to Kansas* (1859); *The Roaming Editor* (1859); *Southern Notes* (1860); *Guide to Hayti* (1860); *Life of John Brown* (1860); and *Talks About Ireland* (1881). He also assisted Jefferson Davis in the latter's historical and autobiographical work.

REDPOLL. A small northern linnet-like finch of the small genus *Acanthis*, visiting the United States and Central Europe in winter. The plumage is streaky with dusky white and buffy shades, the face and throat often blackish. The males have the crown crimson and the breast rosy or carmine. All the redpolls are birds of high latitudes and breed in extreme Arctic regions, making nests of dried grasses, lined with hair, feathers, and down, in a low bush or tuft of grass, and laying pale blue, finely speckled eggs. The best-known in America is the "common" redpoll (*Acanthis linaria*), a bird less than $5\frac{1}{2}$ inches long, appearing irregularly in the Northern States, in flocks of considerable size, and feeding on small seeds, like goldfinches.

RED RIDING HOOD, LITTLE. The popular fairy-tale of the little girl devoured by the wolf which personates her grandmother. The source of the English version is *Le petit chaperon rouge* in Perrault's *Contes du temps passé* (1677). Tieck gives the tale in his *Volksmärchen* in 1795, and the brothers Grimm in their collections of fairy-tales. In the latter the wolf is cut open by

a hunter, and the child is set free; this feature allies the story with many monster-swallowing incidents in various folk-lore, while the tale itself in varying forms is widespread.

RED RIVER, or SONG-KOI. A river of Tongking, French Indo-China. It rises in the mountains of Southern China, and flows in a nearly straight southeast course of over 600 miles, emptying into the Gulf of Tongking through a large delta (Map: China, B 7). Its course is obstructed by several rapids, which, however, have been partly overcome so that small specially constructed steamers can ascend the river to Lao Kai on the Chinese frontier. Hanoi, the capital of Tongking, lies on its banks, and the river is of considerable commercial importance. Its delta is the most fertile and populous part of the country.

RED RIVER. The southernmost of the large tributaries of the Mississippi. It rises in the northern part of Texas in the fissures of the Llano Estacado, and flows eastward along the northern boundary of Texas until it enters Arkansas, where it turns to the south, and entering Louisiana traverses that State in a southeasterly direction to its junction with the Mississippi, 341 miles above the mouth of the latter, and opposite the southwestern corner of the State of Mississippi (Map: Texas, D 1). Its length is estimated at 1550 miles. For the first 60 miles it flows through a cañon with perpendicular rocky sides 500 to 800 feet high, after which it enters a sandy and arid plain, where it broadens out to a width of nearly 3000 feet, but with a very shallow depth. Farther down it enters the fertile alluvial bottoms, which throughout its middle course are densely wooded. Here the course becomes very sluggish and meandering, while the river continually shifts its bed by washing away the material from one bank and depositing it on the other, thus offering serious impediments to navigation. Here also the river shows a remarkable tendency to form snags or rafts of driftwood. Up to 1873 such a raft of tree-trunks and driftwood 32 miles long extended from a point some distance above Shreveport, La. In that year a navigable channel was cut through, and now the river is kept clear by constantly removing the floating timber. In its lower course in Louisiana the Red River sends out numerous bayous, some of which rejoin it, while others penetrate directly to the Gulf of Mexico, parallel with the Mississippi. The chief of the latter is the Atchafalaya (q.v.), which has up to the present received a large part of the volume of the main stream, though engineers are now endeavoring to force the whole of the Red River into the Mississippi by damming up the bayou. (See MISSISSIPPI RIVER.) Large sums have been expended by the National Government in improving the navigation of the Red River. It has a navigable length of about 1250 miles, and its tributaries, chief of which is the Washita, afford in addition 2100 miles of navigable waterways. Steamers drawing four feet can ascend to Shreveport at all seasons except in extreme low water, while at high water they can reach nearly to the Texan boundary. Consult Marcy, *Exploration of the Red River of Louisiana* (Washington, 1853).

RED RIVER OF THE NORTH. A river rising in the northwestern part of Minnesota a

few miles from the sources of the Mississippi (Map: North Dakota, H 1). It flows first southward through a chain of numerous lakes, then westward to the boundary between Minnesota and North Dakota, which it follows in a northerly course until it enters Manitoba, where it empties into the southern extremity of Lake Winnipeg. Its length is about 700 miles. Its course lies through an almost perfectly level plain which was formerly the bottom of Lake Agassiz (see LAKE), and which is a famous wheat-producing region. The river and its branches have cut narrow channels through the plain with clay banks 20 to 60 feet high. The southern branch of the Red River connects through Lake Traverse with the Minnesota and Mississippi rivers, so that during high water small steamers may sometimes pass from the Mississippi to Lake Winnipeg. Owing to the difference in latitude between the upper and lower courses, spring sometimes arrives at the former while the latter is still ice-bound, so that the waters are piled up and inundate the plain.

REDROOT. A popular name for various unrelated plants. One of the best known is *Lachnanthes tinctoria*, of the natural order *Hæmодо-*



REDROOT (*Lachnanthes tinctoria*).

raceæ, which grows in wet sandy soils near the coast of the Eastern United States. It has sword-shaped leaves mostly close to the ground, and an unbranched almost leafless stem which bears at its summit a dense compound cyme of woolly yellow flowers. The perennial roots contain a red coloring matter sometimes used in dyeing. Alkanet (*Alkanna* or *Achusa tinctoria*), certain American pigweeds (*Amarantus* spp.), and *Ceanothus americanus* are also called redroot. See CEANOTHUS; ALKANET; AMARANTH.

RED'RUTH. A town in Cornwall, England, the centre of a famous mining district, $9\frac{1}{2}$ miles northwest of Falmouth (Map: England, A 6).

In 1792 gas was first used here for lighting purposes. Tin, from numerous mines in the vicinity, is smelted in the town, and iron foundries are in operation; another important product is copper. Population, in 1891, 10,324; in 1901, 10,450.

RED SANDSTONE. A term formerly applied to the combined Devonian and Permian rocks, when their relations to the Carboniferous strata were unknown. The discovery that one set of the Red Sandstone was below the coal, while the other was above it, caused the division into the Old Red Sandstone, or Devonian, and the New Red, or Permian. For some time after this division, the original term was retained by a few geologists, but it is now quite given up. See OLD RED SANDSTONE; PERMIAN SYSTEM.

RED SCALE. The name applied in Florida to *Aspidiotus ficus*, and in California to *Aspidiotus citri*, two common and destructive enemies of the orange. See ORANGE INSECTS.

RED SEA (Lat. *Mare Rubrum*, Gk. *Ἐρυθρὴ Θάλασσα*, *Erythrē Thalassa*), or **ARABIAN GULF**. An arm of the Indian Ocean separating the Arabian peninsula from Northeastern Africa, and lying between latitudes $12^{\circ} 30'$ and 30° N. (Map: Asia, C 6). It extends in a northwest direction from the Strait of Bab-el-Mandeb, 20 miles wide, through which it communicates with the Gulf of Aden, to the Isthmus of Suez, and is 1380 miles long. It is narrowly elongated in shape, with a breadth between 100 and 200 miles maintained for the greater part of its length. In the north the sea divides into two arms, cutting off the Sinai Peninsula: these are the Gulf of Suez in the west, 170 miles long and 25 miles wide, and the Gulf of Akabah in the east, 110 miles long and 12 miles wide. The Gulf of Suez is connected by the Suez Canal (q.v.), about 100 miles long, with the Mediterranean. The basin of the Red Sea is formed by a line of fracture running through the great Archæan mass capped by the limestone plateaus of Egypt and Arabia. The Archæan rocks are exposed here and there along the coast. A branch fissure with steep rocky sides forms the Gulf of Akabah, and runs northward as the depression called El-Arabah, the deep sink of the Dead Sea, and the valley of the Jordan. The shores of the Red Sea are bordered on the Arabian side by sandy deserts, which form a narrow strip backed by the limestone range. On the Egyptian side there are wide, sandy plains in the north, rising farther south into elevated tablelands, and finally into the mountains of Abyssinia. Each shore, particularly the eastern, is lined with immense coral reefs which in some places extend 25 miles or more from land. They have occasioned numerous islands and archipelagoes. The principal groups are the Farsan Islands near the Arabian shore and the Dahlak Islands near the African. The mean depth of the Red Sea is about 2000 feet. Through the greater part of its length runs a central channel with a depth exceeding 3000 feet, divided by comparatively shallow ridges into three basins, of which the northern and southern have a maximum depth of about 4200 feet, and the central of nearly 7500 feet. The Strait of Bab-el-Mandeb is 1200 feet deep. In the Gulf of Suez the depth is scarcely more than 200 feet.

The mean temperature of the surface water is 77° in the north, 80° near the middle, and 84°

in the south. Below a depth of 1200 feet there is a uniform temperature of 71° in all parts of the sea and down to the greatest depths. The sea differs in this respect from the open ocean, where the temperature continues to fall through a much greater depth. The surface temperature of the Red Sea sometimes rises above 100°, and there is an enormous evaporation, the air being almost constantly saturated as fast as it is supplied by the winds. The heat being intense, the climate on the Red Sea is very depressing. Its salinity amounts to about 4.2 per cent., increasing with the depth, while that of the ocean is 3.5 per cent. The tides are irregular, and in some places imperceptible. The prevailing winds are north and northwest, but in the southern section they change to the southeast during winter. The marine flora and fauna of the Red Sea are very rich and interesting. The indigenous species are quite different from those of the Mediterranean, showing that the two seas must have been separated since the Eocene epoch. Since the opening of the Suez Canal, however, there has been a considerable inter-migration. From the earliest times the Red Sea has been a great highway of commerce between India and the trading peoples of the Mediterranean lands, and was used successively by the Egyptians, the Phœnicians, Arabs, and in the Middle Ages by the Venetians, until the discovery of the route around the Cape of Good Hope. Since the opening of the Suez Canal in 1869 it has regained its importance as the main route of commerce between Europe and the East.

Consult: Luksch, *Vorläufiger Bericht über die physikalisch-oceanographischen Untersuchungen im Roten Meer* (Vienna, 1896); Hood, "The Red Sea Currents and Navigation," in *Nautical Magazine*, vol. lxxviii. (London, 1899).

REDSHANK. One of the best known of the British and European sandpipers (*Totanus calidris*), having conspicuous red feet. Compare GREENSHANK.

RED-SHOULDERED HAWK. See BUZZARD; HEN-HAWK.

RED SNAPPER. See SNAPPER.

RED SPIDER. A name among florists for one of the spinning mites of the genus *Tetranychus*, and particularly of *Tetranychus telarius*, a cosmopolitan species, probably originally European. They frequently do considerable damage to plants, causing the leaves to turn a rusty color, but they may be kept in check by the application of a kerosene emulsion spray to which flowers of sulphur has been added. See MITE.

REDSTART (from *red* + *start*, AS. *stort*, Ger. *Sterz*, tail; perhaps connected with OHG. *stürzen*, Ger. *stürzen*, to hurl, or with Gk. *στόρν*, *storthē*, prong). Either of two small warblers. The American redstart (*Setophaga ruticilla*) is one of the wood-warblers (q.v.). The male is black, with white belly, and the sides, basal half of wing, and tail-feathers are bright salmon-red; the female is ashy where the male is black and yellow where he is salmon. It winters in tropical America, but appears in the United States early in the spring. The nest is built of fine strips of bark, leafstalks, and the like, lined with fine rootlets, in the fork of a small tree some distance from the ground. The eggs are white spotted with brown. The redstart feeds

wholly upon insects, which it pursues with great activity. He is not much of a songster, but his beauty and liveliness make him a well-known and popular bird. See Colored Plate of WOOD-WARBLEDERS.

The European redstart is a similar bird, but of the family Sylviidae, and is widely diffused over Europe, Asia, and the north of Africa. It has a very soft melodious song, which is continued during the breeding season far into the night, and resumed at early dawn. In confinement it becomes very tame, and has been known to imitate the song of other birds, and even to learn a tune.

RED-TAILED HAWK. See BUZZARD; HEN-HAWK.

RED TAPE. A term used to denote excessive routine and formality in the management of official affairs; a servile adherence to precedent. Before the invention of the modern appliances of elastic bands, file-holders, and other means for securing papers, all official documents were bound together by red ribbons or tapes. The necessary delay caused by the undoing of tapes by slow-moving Government officials, before business could be transacted, came at length to stand as representative of all delays. The 'Circumlocution Office' in Dickens's *Little Dorrit*, representing the roundabout ways of a fictitious public office, is an amusing satire on this subject.

REDTOP GRASS (*Agrostis alba*, and its variety *vulgaris*). This grass varies greatly in its habit of growth. Some of its forms are tall-growing and are largely cultivated for hay, being usually sown in mixtures with timothy and clover. It is one of the best grasses for permanent pastures in the New England and Eastern States, and thrives best in moist soils unsuited to other valuable grasses. When once established this grass will maintain itself against encroachment by weeds or less valuable grasses. Some forms are very useful for lawns. This grass is also called florin, bent grass, and, in the Eastern United States, herd's grass. The names are all applied to other species of *Agrostis* in different regions.

REDUPLICATION (Lat. *reduplicatio*, from *re-*, again + *duplicare*, to double, from *duplex*, double, from *duplus*, double, from *duo*, two + *-plus*, -fold.) In *inflection* (q.v.), a prefix to a word which normally consists of the initial consonant or consonants with a vowel which is either the vowel of the root (q.v.) of the word or is *e*. The reduplication is generally found in verbs, although it sometimes occurs in the formation of nouns. In the verb it is a characteristic in Sanskrit (q.v.) and Avesta (q.v.) of the intensive and desiderative formations, as Sanskrit *hanti*, 'kills,' *janghanti*, 'kills repeatedly,' *jighāmsati*, 'desires to kill.' It is also found in some aorists, as Sanskrit *dharati*, 'holds,' *adidharam*, 'I held,' and in a number of present formations, as Sanskrit *dadāmi*, Greek *δίδωμι*, 'I give.' It is most usually found, however, in the perfect tense, of which it is a distinguishing mark in Sanskrit, Avesta, and Greek, as Sanskrit *dr̥śti*, 'hates,' *didr̥śa*, Avesta *didraēša*, 'I hated,' Greek, *λύω*, 'I loose,' *ἐλύω*, 'I loosed.' There are sporadic instances in Latin, as *mordco*, 'I bite,' *momordi*, 'I bit,' while examples are comparatively numerous in Gothic, as *faiƿah*, 'seized,' from *fāhan*; *haihāt*, 'called,' from *hāitan*; *taitōk*,

'touched,' from *tēkan*. The original force of the reduplication seems to have been intensive or perfective. This view explains its use in the perfect and aorist tenses of the verb, and also its employment in the Sanskrit intensive and desideratives. Its occurrence in nouns is probably based on analogy with its normal use in the conjugation of verbs.

RED WATER. At times the water of the open sea near coast lines and of harbors more or less suddenly turns red, and at the same time the phenomenon is accompanied by the death of fishes and molluscs in great quantities. This has been found to be due to the presence in enormous numbers of an animalcule known as *Peridinium* (or *Glenodinium*). This is an infusorial form representing a singular type of flagellate protozoa, class Mastigophora and order Dinoflagellata. It differs from ordinary flagellate infusoria by being protected by a remarkable and often beautifully ornamented and complex shell formed of cellulose. The body is nearly symmetrical; from a longitudinal groove springs a large flagellum, while a second flagellum lies in a transverse groove. The protoplasm in one

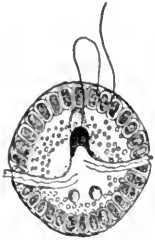

GLENODINIUM.

species examined contains chromatophores colored with chlorophyll, or an allied pigment of a yellow color, called 'diatomin.' Other forms live in fresh water.

In Hertwig's *Zoology* it is stated that these organisms have recently been placed near the plants because with their brown chromatophores their food relations are like those of plants, although the taking of solid food by a mouth-opening has been observed. The armor, formed of cellulose plates, is also plant-like. The pigment appears to vary in hue in different species, being yellow, brown, or reddish brown.

RED-WATER, BLOODY URINE, MOOR-ILL, HAEMATURIA. A disease of cattle, and occasionally of sheep, attributed to eating coarse, indigestible, imnutritive food, continued exposure to inclement weather, and other indefinite causes. Attention to the proper nutrition of the stock, a supply of good water, and the improvement of pastures by draining, liming, and manuring, have been recommended as preventives.

RED WHELK. See SPINDLE-SHELL.

RED WING. A city and the county-seat of Goodhue County, Minn., 40 miles southeast of Saint Paul, on the Mississippi River, here spanned by a high bridge, and on the Chicago, Milwaukee and Saint Paul, and branches of the Chicago and Northwestern and the Chicago Great Western railroads (Map: Minnesota, F 6). It has a State training school, the Hauge Seminary, the Lutheran Ladies' Seminary, and city and private hospitals. Red Wing is situated in a rich agricultural region, but is better known for its manufactures, which include stoneware, sewer pipe, furniture, linseed oil, malt, beer, lime, hats, flour, lumber products, and shoe specialties. The government is vested in a mayor, elected biennially, and a unicameral council. Settled in 1845, Red Wing was incorporated in 1858. Population, in 1890, 6294; in 1900, 7525.

REDWING. (1) An American blackbird (*Agelaius phoeniceus*) of the oriole family (Icteridae). The male in full plumage is jet-black, with the bend of the wing bright scarlet, bordered with buff. The female is variegated with brown and buff, black and white. The redwing is 9½ inches long. It breeds throughout the United States, but winters from Virginia southward. The nest is built of coarse grass and rushes among the bushes or reeds of a swamp, and the eggs are pale blue, with peculiar pen-stroke markings of dark purple or black. (See Colored Plate of EGGS OF AMERICAN SONG BIRDS.) The note is a loud clear call well imitated by the syllables *cong-ka-rée*, the last one accented and prolonged. The redwing is one of the first of the spring migrants in the Northern United States, and often appears in large flocks. Even when breeding the birds are more or less sociable, and several pairs are usually found in the same marsh. Like its relatives, the other blackbirds and the bobolink, the redwing feeds on both insects and seeds, and also enjoys unripe corn or grain, and occasionally raids the maize fields to a destructive extent. See BLACKBIRD.

(2) An English thrush (*Turdus iliacus*) which spends the summer in the northern parts of Europe and Asia, and migrates southward in winter as far as the Mediterranean. The general color is a rich clove-brown on the head, upper parts of the body, and tail; the lower parts whitish, tinged and streaked with brown; the under wing-coverts and axillary feathers bright reddish orange. The redwing congregates in large flocks and has an exquisite song.

(3) One of several other birds with red on the wings, as one of the South African partridges (*Francolinus Le Vaillantii*).

REDWITZ, rēd'vīts, OSKAR, Baron von (1823-91). A German poet, dramatist, and novelist, born in Lichtenau, near Ansbach. He is best known for his ultrapatriotic poem *Das Lied vom neuen deutschen Reich* (1871, 11th ed. 1876). Other noteworthy poems by him are *Amaranth* (1849, 36th ed. 1886) and *Odilio* (1876). A novel, *Hermann Stark* (1868), and the dramas *Philippine Welser* (1859), *Der Zunftmeister von Nürnberg* (1860), and *Der Doge von Venedig* (1863) may also be named.

REDWOOD (*Sequoia sempervirens*). A California conifer which grows upon the Pacific Coast mountains and is next in size to the *Sequoia gigantea*, or 'big tree.' (See SEQUOIA.) It often attains a height of 250 feet, and sometimes 300 feet, with a diameter, in the largest, of 15 feet. The young wood is red, but on exposure to the air and light it sometimes fades. The timber, which is common on the Pacific Coast, is soft, straight-grained, easily worked, durable, and well suited for inside finishing of houses, since it takes a good polish. The redwood sends up suckers from the stumps, and seeds itself well, so that the forests are maintained. Redwood is also a name given



A BRANCH OF REDWOOD.

REDWOOD



SEQUOIA SEMPERVIRENS

a leguminous tree of India, where the wood is much used as a dye.

REDWOOD, BOVERTON (1846—). An English consulting chemist and authority on petroleum. He was born in London, studied at University College School, and learned pharmacy. As an expert on coal oils, Redwood traveled in Europe and America, acted as a member of technical juries of award in international expositions and health exhibitions, and was frequently consulted by the English Parliament on legislation in regard to the oil trade. His published works include: *Cantor Lectures on Petroleum and Its Use* (1887); *Reports on Accidents with Mineral Oil Lamps and on the Transport of Petroleum Through the Suez Canal* (with Abel, 1890 and 1892); *Treatise on Petroleum* (1896); *Detection of Inflammable Gases* (1896, with Clowes); and, with Thomson, *Handbook on Petroleum* (1901).

REE. A North American Indian tribe. See **ARIKARA**.

REED (AS. *hrēod*, OHG. *hriot*, riot, Ger. *Ried*, *Riet*). The common name of certain tall grasses growing in moist or marshy places. The common reed (*Phragmites communis*) is abundant in Continental Europe, Asia, and America in wet meadows and stagnant waters, and by the banks of rivers and ditches. It grows chiefly in rich alluvial soils. The hard, almost woody culms are 5 to 10 feet high, and bear at the top a large reddish-brown or yellowish much-branched panicle. They are used for making garden screens, light fences, and frameworks to be covered with clay in partitions and floors. Cattle readily eat the young shoots, but refuse the hard old ones. Nearly allied to this is *Arundo Donax*, the largest of European grasses. It is 6 to 12 feet high, and has thick, hollow, woody culms, and a purplish yellow panicle, silvery and shining from silky hairs. The woody stems are an article of commerce, and are used by musical instrument makers for reeds of clarinets and mouthpieces of oboes. They are also made into walking-sticks and fishing-rods. The creeping roots contain much starch and some sugar. *Arundo Karka* is supposed to be the grass called *Sur* in Sindh, of which the flower-stalks are very fibrous; and the fibres, being partially separated by beating, are twisted into twine and ropes. The sea reed (*Ammophila arundinacea*) grows along the sandy shores of the Great Lakes and the Atlantic Ocean, and is one of the best sand-binding grasses for regions adapted to its growth. The small cane *Arundinaria tecta* is called reed in the United States.

REED. In music, a thin strip of cane, wood, or metal secured at one end in front of an aperture, through which a current of air passing sets it in vibration. The vibrations thus started are either communicated to an inclosed column of air, or are released into the open air, in either event producing a musical sound. The reed is of two kinds, the *beating* reed and *free* reed. The former is used in the reed-pipes of an organ (q.v.), and requires to be placed within a tube in order to produce a musical sound. It consists of a metallic cylinder, with the front part cut away, and a brass spring or tongue placed against the opening and attached at the upper end. The resultant note is dependent for its pitch on the length of the tongue, which is regu-

lated by a strong spring of wire pressing against it. The quality of the sound is determined to a large extent by the length and form of the pipe in which the reed is placed. The double reed consists of two beating reeds striking against each other. The *free* reed differs from the beating reed in that the tongue is a little smaller than the opening, and strikes, not the edge of the opening, but the air. Its note is more smooth and mellow than that of the beating reed, and it has the advantage of not requiring a pipe, which is a necessary appendage to the latter. Besides being occasionally adapted to organ-pipes, it is used without a pipe in the concertina and harmonium. The history of the beating reed can be traced back to the earliest known civilizations; the single form is now represented by the clarinet, chalumeau, and saxophone; while the double form is now seen in the krumhorn, oboe, and bassoon. The free reed was introduced into Europe in the eighteenth century, its prototype being the Chinese *chéng*. See **MUSICAL INSTRUMENTS**.

REED, ANDREW (1787-1862). An English clergyman and philanthropist. He was born at Beaumont House, Saint Clement Danes, London. In 1807 he entered Hackney College, and in 1811, after preaching in many parts of England, he decided upon the Congregational Chapel at New Road, London. He continued the pastorate of this congregation until 1861. As a philanthropist his efforts were devoted to the establishment of orphan asylums. His other charitable works were the Asylum for Idiots, founded in 1846, and the Royal Hospital for Incurables, begun in 1855, with its home at Putney House, Surrey. He was the author of various works of a religious character. Consult his *Memoirs*, edited by his sons (London, 1863).

REED, SIR CHARLES (1819-81). An English politician, educator, and philanthropist. He was the son of Rev. Andrew Reed (q.v.), and was born near Sonning, in Berkshire. He was educated chiefly at the Hackney Grammar School. At the age of seventeen he was apprenticed to a firm of woolen manufacturers at Leeds, and in 1842 he entered the printing business in London. A prosperous career led to his independent establishment as type-founder in 1861, a business which continued until his death as 'Sir Charles Reed and Sons, Limited.' He held many offices of public trust, besides taking an active part in the administration of the institutions founded by his father. In 1868 he entered Parliament as Liberal member for Hackney, and retained his seat until 1874. He was re-elected as member for Saint Ives in 1880. During his Parliamentary career he was identified with the discussions of educational questions, and was elected chairman of the London School Board in 1873, retaining the post until his death. In 1876 he was president of the Judges on Education at the International Exhibition of Philadelphia. He made collections of antiquities as an avocation, and was part translator with H. T. Riley of *Liber Albus*, the *White Book of the City of London*, published in the Rolls Series in 1862, besides being a frequent contributor to *Notes and Queries*. He was also joint editor with his brother Andrew of *Memoirs of the Life and Philanthropic Labors of Andrew Reed, D.D.* (1863).

REED, SIR EDWARD JAMES (1830—). A British naval engineer, born near Sheerness. He was

educated at the School of Mathematics and Naval Construction at Portsmouth, and became secretary of the Institution of Naval Architects. From 1863 to 1870, when he resigned, he was chief constructor of the British Navy. In 1886 Gladstone appointed him Lord of the Treasury, and from 1874 to 1895 he was a member of Parliament. In 1880 he was created a knight commander of the Bath. He published: *Our Iron-clad Ships* (1869); *Letters from Russia in 1875* (1876); *The Stability of Ships* (1884); and, in collaboration with Admiral Simpson, *Modern Ships of War* (1888).

REED, HENRY (1808-54). An American educator and critic, born in Philadelphia, Pa. He graduated at the University of Pennsylvania in 1825, studied law, and was admitted to the bar in 1829. In 1831 he became assistant professor of English and of moral philosophy in the University of Pennsylvania, and in 1835 was made professor of rhetoric and English literature at the same institution. This he held till the year of his death, which occurred in the sinking of the steamship *Arctie*, September 27, 1854. His literary work consisted mainly of the posthumously published lectures and essays on literature; *Lectures on English Literature* (1855); *Lectures on English History and Tragic Poetry as Illustrated by Shakespeare* (1856); and *Lectures on the British Poets* (1857). He did much by his editions of Wordsworth to further the study of that poet in America. His works were edited by his brother, William Bradford Reed (q.v.).

REED, JOSEPH (1741-85). An American patriot of the Revolutionary period. He was born at Trenton, N. J., August 27, 1741, and graduated at the College of New Jersey, now Princeton, in 1757. From 1763 to 1765 he studied law in England, being entered at the Middle Temple. He then began practice at Trenton, and in 1767 became deputy secretary of New Jersey. On his return in 1770 from a second visit to England, where he married a daughter of Dennis Deberdt, the agent of Massachusetts in England, he removed to Philadelphia, served on the Committee of Correspondence, and was president of the Pennsylvania Provincial Congress in 1775. In 1775 he served as a delegate to the Continental Congress and became Washington's secretary and aid-de-camp. He was adjutant-general during the New Jersey campaign, the success of which was due in no small degree to his knowledge of the country. In 1777 he declined the posts of Chief Justice of Pennsylvania and Commissioner of Indian Affairs, and a promotion to the rank of brigadier-general, and remained in the army as a volunteer without pay, serving with credit in the battles of Brandywine, Germantown, and Monmouth. He was a member of the Continental Congress in 1778, and signed the Articles of Confederation. He was president of the Pennsylvania Supreme Executive Council from 1778 to 1781, in which capacity he helped to suppress the revolt of the Pennsylvania line in the latter year. He had previously caused the trial of Arnold for maladministration. During his administration he aided in founding the University of Pennsylvania and advocated the gradual abolition of slavery. Reed died March 5, 1785. Consult W. B. Reed, *Life and Correspondence of Joseph Reed* (Philadelphia, 1847).

REED, THOMAS BRACKETT (1839-1902). An American lawyer and political leader, born at Portland, Maine. He graduated at Bowdoin College in 1860; emigrated to California, where he taught school, in the meantime devoting his spare moments to the study of law; returned to Portland in 1864, and was appointed paymaster in the United States Navy, in which capacity he served until his honorable discharge in November, 1865. Shortly thereafter he was admitted to the bar and began the practice of law at Portland. In 1868-69 he was a member of the Lower House of the Maine Legislature, and in 1870 sat in the State Senate.

From 1870 to 1872 he served as Attorney-General of Maine, and from 1874 to 1877 was solicitor of the City of Portland. In 1876 he was elected to Congress and was continuously reelected until 1898. In 1889 he was chosen Speaker of the House. Again in 1895 and in 1897 he was elected Speaker, but before the expiration of his last term he resigned his seat in Congress and entered upon the practice of law in New York City. As Speaker of the National House of Representatives, he made a notable innovation upon the parliamentary procedure of that body by adopting the practice of counting as present those members of the opposition who, though physically present, refused to vote in order to prevent a quorum. This innovation created a storm of opposition in the House and was denounced as revolutionary. His rulings, however, were sustained by the majority. The practice was soon acquiesced in by the Democrats, and it has come to be a permanent part of the procedure of the Lower House. In 1896 Reed was a prominent candidate for the Republican nomination for the Presidency, but was defeated by William McKinley. He died at Washington in December, 1902. Speaker Reed was an able parliamentarian and an efficient speaker, his addresses often being enlivened by rare wit and humor.

REED, WALTER (1851-1902). An American army surgeon, sanitarian, and bacteriologist, born in Virginia. He received his medical education in the University of Virginia and in Bellevue College Hospital, New York City. He was appointed assistant surgeon in the army in 1875, and in 1890 was assigned to duty in Baltimore, where he remained a year. During this period he made an especial study of bacteriology in the laboratory of Prof. William Welch in Johns Hopkins University. In 1893 he was appointed curator of the Army Medical Museum in Washington, and established a laboratory in which he gave instruction in bacteriology to the student officers of the newly established Army Medical School, and did much original work in bacteriology and in the conduct of special sanitary inspections and investigations. In 1898 he was placed at the head of a board, of which Drs. Victor C. Vaughan and E. O. Shakespeare were the other members, to investigate the epidemic occurrence of typhoid fever among the troops assembled for the Spanish-American War. It developed the surprising fact that infected water was not an important factor in camp epidemics of typhoid fever, but that the infection was distributed by the agency of flies and on the hands, feet, and clothing of the men. Their work is remarkable for the patience and skill with which a vast number of facts were brought together and collated. In 1899 Reed, with his assistant, Carroll, demonstrated the

fallacy of the claim of Sanarelli that the bacillus *icteroides* was the causative agent of yellow fever. In 1900 Reed went to Havana at the head of a commission to investigate the etiology of yellow fever, and demonstrated that yellow fever is transmitted from man to man only by the bite of mosquitoes of a certain variety (*Stegomyia fasciata*), which have become infected by previously biting persons sick of yellow fever. The work of this commission is remarkable for the accuracy and completeness of its experimental work, the devotion with which its members exposed themselves (two of them having submitted to experimental inoculations with infected mosquitoes), and the far-reaching importance of their conclusions. Practical application of this discovery was at once made by the American military authorities, with the result that yellow fever was exterminated in Cuba. At the time of his death Major Reed was first on the list of majors of the Medical Department of the United States Army, to which rank he had been promoted in 1893, and the Secretary of War had recommended to Congress his promotion by a special act to the rank of colonel for this work, saying: "The brilliant character of this scientific achievement, its inestimable value to mankind, the saving of thousands of lives, and the deliverance of the Atlantic seaboard from constant apprehension, demand special recognition from the United States." Congress granted to his widow a pension of \$125 a month. See INSECTS, PROPAGATION OF DISEASE BY. Consult Kean, *Senate Document No. 118*, "The Scientific Work and Discoveries of the Late Major Walter Reed, Surgeon, U. S. A."

REED, WILLIAM BRADFORD (1806-76). An American politician and journalist, born in Philadelphia, brother of Henry Reed (q.v.). After graduating at the University of Pennsylvania in 1825 he went to Mexico as private secretary of Joel R. Poinsett; studied law; was elected State Attorney-General (1838); was made professor of American History at the University of Pennsylvania (1850); in 1857 became Minister to China, where he negotiated the treaty of June, 1858; and on his return (1860) was active in Democratic politics and in New York journalism. He was for a time American correspondent of the *London Times*, author of many controversial and historical pamphlets and of essays contributed chiefly to the *American Quarterly* and the *North American Review*. He wrote also an excellent *Life and Correspondence of Joseph Reed*, his grandfather (1847), and *Life of Esther de Berdt*, afterwards Esther Reed, his grandmother (1853). He died in New York, February 18, 1876.

REEDBIRD. The name in the Middle States of the bobolink (q.v.). In England the name belongs to a warbler, the 'reed-wren' (*Acrocephalus streferus*), and to the reed-bunting (q.v.).

REEDBUCK, or REITBOK. A small goat-like antelope of Central and Southern Africa (*Cervicapra arundineum*), the males alone of which were provided with horns, which vary greatly in size and shape. It is never found far from water, is slow and unsuspicious, and hence is becoming rare. Consult Selater and Thomas, *Book of Antelopes* (London, 1894-1900).

REED-BUNTING, or SPARROW. A small dark-colored European finch (*Emberiza scharniculus*), fond of marshes and wet meadows, which is common throughout Europe, and frequently called

'black-headed bunting.' See Plate of BUNTINGS AND GROSBEAKS.

REED'ER, ANDREW HORATIO (1807-64). The first Governor of Kansas Territory. He was born at Easton, Pa.; was educated at Lawrenceville, N. J., studied law, and practiced with great success at Easton. He became influential in the Democratic Party and in 1854 was appointed Governor of the new Kansas Territory by President Pierce. It was expected by those who had secured his appointment that he would assist in the work of making Kansas a slave State, but this, owing perhaps to the lawless behavior of the border ruffians from Missouri, he did not do, and instead became favorable to the Free-State Party in the Territory. As a result of his attitude, a delegation of Democrats, headed by Jefferson Davis, demanded his removal. With this demand the President complied, and Reeder was removed from office after a tenure of a little more than a year. He then became one of the leaders of the Free-State Party, and in September, 1855, was nominated as delegate to Congress by the Big Spring convention. A little later he was again chosen delegate by the same party, but was never allowed to serve. In the following July he was elected United States Senator by the Legislature organized under the Topeka Constitution, but as Kansas was not admitted to Statehood, he was not permitted to take his seat. Not long afterwards he returned to the East, and was received with great enthusiasm by the opponents of slavery. Upon the outbreak of the Civil War he was appointed a brigadier-general, but felt himself too old and infirm to serve. Consult Robinson, *The Kansas Conflict* (New York, 1892), and Spring, *Kansas* (Boston, 1885).

REEDFISH. One of the two ganoid fishes (the other being the bichir, q.v.) which constitute the sole remaining representatives of the order Crossopterygii, which was of great importance in ancient times. This modern ganoid is a small fish dwelling in the rivers on the west coast of Africa, and has an elongated, terete body with a curiously divided dorsal fin and no pelvic fin. There is only one species (*Calmoichthys Calibarius*) which lives in deep pools, and apparently buries itself in the mud at the bottom, where it feeds on fishes and other aquatic animals.

REED INSTRUMENTS. Properly speaking, those musical instruments which are sounded by means of a reed. This general class is divided into two groups: those sounded by the beating reed, and those sounded by the free reed. The first group comprises the single beating reed, typified by the saxophone; the double beating reed, typified by the oboe, and a combination of single and double, with the addition of an air reservoir. The best known example of this latter arrangement is the bagpipe.

Free reeds were copied directly from the Chinese chêng. They are limited almost wholly to instruments of the concertina and harmonium type, though they are occasionally used in pipe organs. Reed organs were invented and perfected in this country, between 1812 and 1850. Their universal form was that of a small organ without pipes, having free reeds and a treadle bellows, although the various modifications received different names. See HARMONIUM; MELODEON; MUSICAL INSTRUMENTS.

REED-MACE. A plant. See TYPIA.

REEF (Dutch *rif*; probably connected with Icel. *rifa*, fissure, from *rifa*, to split, Eng. *rive*). A barrier of rock or sand extending along the shore of an island or continent. The most common type of a rock reef is that formed by coral organisms which flourish in the shallow portions of tropical seas. (See CORAL ISLAND AND CORAL REEF.) The sediment carried seaward by rivers and the sands beaten up by waves accumulate along the seashore as sand reefs inclosing long, narrow lagoons. See BAR.

REEF. See SAIL.

REEL (AS. *rēol*, *hrēol*, Icel. *hræll*, *ræll*, Gael. *ruidhil*, weaver's reel). A lively, gliding dance whose origin is probably Celtic, though its resemblance to a Danish national dance has led many to ascribe it to Scandinavian sources. It is usually danced by two couples, but admits of a greater number. The music is in general written in 8-bar phrases in common time of four crotchets in a measure, but sometimes in jig time of six quavers. The principal characteristic of all reel figures is a circular movement during which the performers face each other and describe a series of figures of eight. The strathspey (q.v.) is merely a slow form of the reel.

REENTRY. The act of entering into possession of lands in the exercise of a right reserved to a lessor or grantor in a lease, deed, or other conveyance upon certain conditions. In order to take advantage of a right of reentry, a person should first demand payment, or compliance with the terms of the lease or conveyance, and upon a refusal or neglect to do so, enter peaceably, if he can, but otherwise he must proceed at law. Right of reentry may be waived by receiving rent accruing after breach of a condition, with knowledge of that fact.

REES, ABRAHAM (1743-1825). A British encyclopædist, born at Llanbrynmair, Wales. He studied for the ministry at Hoxton Academy; was for many years mathematical tutor there, and pastor of a Presbyterian church in Southwark. In 1783 he was settled over a church in the Old Jewry. Between 1781 and 1786 he improved and greatly enlarged *Chambers's Cyclopædia*, which had first appeared in two folio volumes in 1728. Encouraged by the success of this work, he set to work upon *The New Cyclopædia, or Universal Dictionary of Arts and Sciences, Biography, Geography, History*, etc. The first volume of this was issued January 2, 1802, and the last, or forty-fifth volume, in August 1820.

REES, JOHN KROM (1851—). An American astronomer, born in New York City and educated there at Columbia College and School of Mines. After teaching at Washington College, Saint Louis, he became adjunct (1881) and then full professor (1884) of astronomy and geodesy at Columbia University. He had witnessed the solar eclipse of 1878 at Fort Worth and published a report thereon; and in 1884 published *Observations of the Transit of Venus, December 6, 1882*. He became a prominent member of the American Meteorological Society and wrote on international time systems and on variation of latitude, especially that of New York City. In 1900 he received the title of Chevalier of the Legion of Honor in recognition of services as juror in the department of instruments of precision at the Paris Exposition. Professor Rees was intimately connected

with Rutherford in the latter's work of celestial photography, and was one of the American delegates to the Astronomical Congress on Photography.

REEVE (AS. *gerēfa*, probably from *ge*, generalizing prefix + **rōf*, OHG. *ruova*, Icel. *rōf*, number, or from *rōf*, famous, Goth. *hrōps*, OHG. *ruof*, Ger. *Ruf*, outcry, AS. *hrōpan*, to cry out). The name given in England, especially in Anglo-Saxon times, to various officials. The reeve was ordinarily the presiding officer of a district, and was known by his district, e.g. *tūngerēfa*, the reeve of the township; *scīrgerēfa*, the reeve of the shire (our modern sheriff). In later times the reeve is prominent in constitutional history, since he and four men from each township attended the great hundred courts held by the sheriffs twice a year. Furthermore, it was the reeve and four men from each township on the royal demesne who were summoned to the Council of Saint Albans in 1213, this being the first instance in which the commons were represented at a Great Council. Consult Stubbs, *Constitutional History of England*, vol. i. (6th ed., Oxford, 1897).

REEVE, CLARA (1729-1807). An English novelist, daughter of William Reeve, perpetual curate of St. Nicholas, Ipswich, in Suffolk. She was educated by her father. On his death (1755) she settled with her mother and two sisters at Colchester, in Essex, where she began authorship. In 1772 she translated Barclay's *Argenis*, a famous Latin romance of the seventeenth century, under the title of *The Phœnix*. In 1777 appeared *The Champion of Virtue, a Gothic Story*, reissued the next year with its title changed to *The Old English Baron*. This romance, interesting in itself, is also of considerable significance as a link between Horace Walpole's *Castle of Otranto* and the romances of Mrs. Ann Radcliffe. Miss Reeve also wrote other novels and some verse. In historical criticism she produced the pleasant *Progress of Romance* (1785). Consult Beers, *English Romanticism* (New York, 1898), and see ROMANTICISM.

REEVE, HENRY (1813-95). An English man of letters, born at Norwich, and educated at Geneva and Munich. He traveled extensively and met the leading literary people of his day. From 1837 to 1887 he was registrar of the Privy Council, and from 1855 until his death he was editor of the *Edinburgh Review*. He translated De Tocqueville's *Democracy in America* (1835-40) and Guizot's *Washington* (1840); edited Greville's *Journal of the Reigns of King George IV. and William IV.* (1874); and wrote *Royal and Republican France* (1872), and *Petrarch* (1878).

REEVE, TAPPING (1744-1823). An American lawyer and jurist, born at Brook Haven, Suffolk County, Long Island. He graduated at Princeton in 1763, was a tutor there from 1767 to 1770, and in 1772 established himself at Litchfield, Conn., in the practice of law. He was an ardent patriot during the Revolution, was a member of several important local committees of safety and defense, and served as a recruiting officer. Shortly after the close of the war he opened at Litchfield a law school, which for a number of years was the best known and most successful institution of the sort in the country. This school he

conducted alone until 1795, and then in association with James Gould until 1820. He was a strong Federalist, but except for brief terms in the Connecticut Legislature and council, his services were all of a judicial nature. In 1798 he was elected a judge of the Connecticut Supreme Court, and remained on the bench for sixteen years, becoming Chief Justice shortly before his retirement in 1814. His publications include: *The Law of Baron and Femme; of Parent and Child; of Guardian and Ward; of Master and Servant, etc.* (1816), since republished in many editions, and *A Treatise on the Law of Descent* (1825).

REEVES, rēvz, Mrs. HENRY (HELEN BUCKINGHAM MATHERS) (1853—). An English novelist, born at Misterton, in Somersetshire, August 26, 1853. She was educated at Chantry, near Frome. In 1876 Miss Mathers married Henry Reeves, a London surgeon. Her first novel, *Comin' Thro' the Rye* (1875), gained wide attention. It was followed by the popular *Cherry Ripe* (1877), *My Lady Green Sleeves* (1879), and several others, including novelettes, *The Land o' the Leal* (1878) and *As He Comes Up the Stair* (1878). Among her later novels are: *A Man of To-Day* (1894); *The Lovely Malineourt* (1895); *The Sin of Hugar* (1896); *Bam Wildfire* (1898); and *Becky* (1900).

REEVES, JOHN (c.1752-1829). An English writer on law, born in London. He was educated at Eton, Cambridge, and Oxford, and was admitted to the bar in 1779. In 1791-92 he was Chief Justice of Newfoundland. In 1792 he proposed "An association for preserving liberty and property against Levelers and Republicans," of which for a time he was chairman. This society was the outcome of his strong feeling against the French Revolution. An anonymous pamphlet published by him in 1795 was considered a libel on Parliament, and he was arraigned for publishing it, but though his opinions were condemned, he was acquitted. His most important work is his *History of the English Law, from the Time of the Saxons to the End of the Reign of Edward I.* (1783, afterwards brought down through the reign of Elizabeth, 1829; the whole in 5 vols.; American edition, 1880). His other works include *A History of the Law of Shipping and Navigation* (1792) and *A History of the Government of the Island of Newfoundland* (1793). As King's printer, he produced several editions of the Bible—particularly one with notes in nine volumes (1825)—and of the Prayer-Book.

REEVES, JOHN SIMS (1822-1900). An English tenor, born at Woolwich. He studied under J. B. Cramer, T. Cooke, and other noted artists, and appeared in public as an operatic barytone at Newcastle in 1839. His debut was a success, and he acquired fresh fame in Scotland and Ireland. After further study in Paris he appeared at Milan in the tenor part of Edgardo in *Lucia di Lammermoor*, when his singing electrified the audience. At Drury Lane in 1847 as Edgardo, he was immediately recognized as the foremost living English tenor, and was engaged in 1848 at Her Majesty's Theatre. In 1851 he was equally successful as first tenor at the Italian opera in Paris. He retired from the stage and became a professor in the Guildhall School of Music in 1892, but on account of financial re-

verses returned to the concert platform and in 1896 made a successful tour in South Africa.

REFERENCE, REFEREE (from Lat. *referre*, to refer, bear back, from *re-*, back again, anew + *ferre*, to bear, carry). In law, the referring or sending of issues or questions arising in a legal proceeding to a competent attorney as referee, to be tried or examined by him in the place and stead of a judge and jury. A reference may be voluntary, or compulsory. It has been held in many States that compulsory references are constitutional. Actions involving long and complicated accounts, and divorce actions, where privacy and secrecy are desired by the parties, are the most frequently tried before referees. Referees are usually only appointed as the occasion arises, but under the United States Bankruptcy Act standing referees are appointed by the courts. The findings of a referee are contained in a report which is filed with the court ordering the reference, and on its confirmation by that court a judgment may be entered in accordance with the decision of the referee. This judgment may be reviewed on appeal by an appellate court. A referee may demand his fees as a condition of filing his report, and the successful party usually pays them in order to enter judgment. The fees and expenses of a reference are very large and litigants frequently oppose a motion to send a case to a referee, on that ground. Referees correspond to masters in chancery, appointed by courts of equity, but in code States, referees hear both legal and equitable actions. See ARBITRATION; COURT.

REFERENDUM (Neo-Lat. nom. sg. neu. of Lat. *referendus*, to be referred, gerundive of *referre*, to refer, bear back). The term applied to the practice of submitting laws to the electorate for approval or rejection. In the application of the referendum the law is first formulated by the legislative body or the constituent assembly and is then submitted to the electorate. The logical complement of the referendum is the *initiative*, by means of which the people are enabled to draw up their own measures and have them voted on without the intermediation of the Legislature. By this method a petition signed by a certain proportion of the voting constituency is presented to the Legislature requesting that a certain measure be submitted to the popular vote. This the Legislature is bound to do without change in the measure, although it may submit an alternative measure to be voted on at the same time. In Switzerland, in every canton of the Confederation except Freiburg, the referendum in one form or another is established by law. In about one-half of the cantons the referendum is 'optional' or 'facultative,' that is, the laws are submitted to the popular vote only when submission by petition of a certain per cent. of the voting constituency is demanded. In the others it is 'obligatory,' that is, the laws must be submitted without petition. It is always obligatory in the case of proposed constitutional changes, whether cantonal or Federal. In the domain of ordinary legislation it is usually employed only in the case of important measures of a general character. Since 1874 the referendum has been a feature of the government of the Confederation. The Constitution provides that upon the demand of eight cantons or 30,000 citizens any Federal law of general application

must be submitted to the people. During the first nineteen years after its adoption by the Federal Government 20 laws out of a total of 150 were thus submitted, 14 being ratified and 6 rejected. The *initiative* was adopted by the Federal Government in 1891 as a means of introducing proposals to revise the Constitution. See SWITZERLAND, section on *Government*.

In the United States the referendum is employed in one form or another in every State and municipality. Very early in our history it became an established principle of American law that all State Constitutions and proposed amendments should depend for their validity upon the ratification of the electorate at the polls. From this it was but a step to the position that propositions to call constitutional conventions should be made a subject for the referendum and this practice became in time well established. Not only has the referendum been employed in the United States for the adoption of organic laws, but it has been used quite as often or more often in the enactment of statutes. It was first employed to determine the question of incorporation of towns, the organization of school districts and counties, the incurring of loans, the undertaking of public improvements, etc. One of the most general uses of the referendum is the determination whether towns and cities shall permit the sale of intoxicating liquors. This method was first employed in Rhode Island in 1845. Another favorite subject of the referendum has been the question of the location of State capitals and county-seats. The referendum has never been employed by the Federal Government for general purposes, although an act of Congress of 1846 providing for a recession of a part of the District of Columbia to Virginia was submitted to a vote of the qualified voters of the district.

The question early arose as to whether the use of the referendum was permissible where not expressly authorized by the State Constitution. From 1826 to 1847 the courts of various States upheld the constitutionality of legislative acts providing for the use of the referendum on the ground that it was not a delegation of legislative power, but simply popular coöperation. Beginning with a decision of the Delaware Supreme Court in 1847, several opinions were given against this view which had the effect of inducing the incorporation of provisions in the constitutions authorizing the referendum. The most valuable work on the referendum is that by Oberholtzer (New York, 1900). Consult also Cleveland, *The Growth of Democracy in the United States* (Chicago, 1898).

REFINING OF METALS (from Lat. *re-*, back again, anew + Eng. *fine*, from OF. *fin*, probably from Lat. *finitus*, finished, p.p. of *finire*, to bound, limit, from *finis*, boundary). The final purifying process in the metallurgy of certain metals such as copper, lead, tin; the object of the process is to obtain the metal in as near as possible a chemically pure form. See COPPER; LEAD; GOLD; SILVER; TIN; NICKEL; IRON.

REFLECTION (Lat. *reflexio*, a bending back, from *reflectere*, to bend back, from *re-*, back again, anew + *flectere*, to bend). A general phenomenon observed in the case of all kinds of wave-motion. If there are two media separated by a bounding surface, in which the trains of waves of the particular kind have different ve-

locities, waves traveling in one medium and meeting this bounding surface will suffer reflection—either total or partial. This is illustrated in aerial waves by the phenomenon of echoes, and in ether-waves by the common use of mirrors of various kinds. The laws of regular reflection are that the incident and reflected rays make equal angles with the line drawn perpendicular to the surface of the point of incidence, and that the two rays and this line lie in a plane. (See LIGHT.) To reflect a train of waves the reflecting body must have a size larger than the wavelength of the waves; a pile rising above the surface of a lake may reflect ripples, but long waves pass around it; a pane of window-glass will reflect aerial waves characteristic of a shrill sound and allow others to pass; a small particle of matter floating in the air may reflect such short ether-waves as produce the sensation of blue light, but allow to pass those so long as to produce red. If the bounding surface between the two media is rough, that is, has inequalities which are comparable with the lengths of the waves, they will be scattered by these and diffusely reflected, e.g. ground-glass surfaces.

REFORMATION (Lat. *reformatio*, from *reformare*, to form anew, from *re-*, back again, anew + *formare*, to form, from *forma*, shape). In law, the rectification or amendment of contracts or other legal instruments pursuant to the judgment or decree of a court of equity. If a term is incorporated into a written instrument by mistake so that it does not represent the real intention of the parties, such intention, by reason of the parol-evidence rule (see EVIDENCE), cannot be shown in any proceeding at law founded upon the written instrument. Courts of equity, however, will give relief from the consequences of such a mistake by compelling the cancellation and surrender of the written instrument and the execution of a new instrument to conform to the actual intention of the parties when there is complete agreement between the parties. Justice then requires that the written instrument should conform to that intention and should be reformed if it does not. But if the terms of a contract were never agreed upon, there is nothing on which to base a decree of the court directing the execution of a new contract. The ordinary rules governing equitable proceedings apply in proceedings to reform written instruments; and the court will give such incidental relief as is necessary to carry out the main purposes of the proceeding. See CONTRACT; MISTAKE; EQUITY; COMMON LAW; EVIDENCE, etc.; and compare RESCISSION. Consult the authorities referred to under CONTRACT; EQUITY; EVIDENCE.

REFORMATION, THE PROTESTANT. The name applied to the great revolt in Europe in the sixteenth century against certain doctrines and practices of the Roman Catholic Church. Up to that time Western Christendom had been a religious unit, under the primacy of the Pope. The Reformation movement, therefore, inevitably affected the general polity of Western Europe and wrought an entire change in its religious and political constitution. The Reformation was thus, if the strict significance of the term is adhered to, a revolution rather than a reformation, while the latter term could properly be applied to the resulting movement within the Roman Catholic Church, which is known as the Catholic Counter-

Reformation. The present usage is, however, established, and is to be accepted with explanation of its actual significance. In its broad constitutional aspects the Reformation was a revolt against the universal supremacy of the Papacy and represented the German idea of separate ecclesiastical bodies on national lines, as opposed to a centralized Church government. In a large ethnic view it was a continuation of the old conflict between German individualism and Latin unity. Protestantism, indeed, the ultimate expression of the Reformation in organized sects, took root permanently only in Northern or Germanic Europe, while in Latin Europe after a sharp struggle between the tendency of individuals to the use of private judgment in spiritual matters and the demand of the established Church for uniformity, the old polity triumphed and Italy, Spain, France, and Austria remained in the Papal obedience.

BEGINNINGS OF THE REFORMATION. The Reformation is dated from the year 1517, when Martin Luther (q.v.) challenged the Papal authority in his famous ninety-five theses, but its true meaning is to be found by referring to great currents of thought and action that through the Middle Ages had been modifying society. Since the establishment of the new Western Empire by Charles the Great in 800 there had been an almost continual contest between the emperors, the temporal heads of Christendom, and the popes, the spiritual heads, over the limits of their respective authorities. The theory of the spiritual and the temporal powers, upon which Christian Europe was constituted, proved not to be a workable one, and every conflict between pope and emperor over the limits of temporal and spiritual jurisdiction sowed the seeds of future discord. The exercise of control by Otho I. (q.v.), the Investiture quarrel (see INVESTITURE), the losing battle of the Hohenstaufen emperors, all tended in this direction; and although the Church triumphed, it did so at the cost of rents in its own armor which made the Reformation possible.

The rise of the spirit of nationality and its resentment of Papal control in ecclesiastical affairs as shown in the contests between some of the French kings and the popes, and in the revolt against Roman influence of which Wiclif was the most notable exponent in England, worked to the same end. Wiclif's religious teachings, with their bearing upon the great political questions that were coming to the front in the fourteenth and fifteenth centuries, were carried from Oxford to Prague, where John Huss (q.v.) took them up and made Bohemia almost a Protestant country before Protestantism was known. Huss was condemned and executed at Constance in 1415, but the work he had done in Bohemia made that country prepared ground for the Reformation seed. Luther's principles were anticipated by Wiclif and Huss, but in their day conditions were not ripe for the great revolution. The universities were often potent factors in the spread of ideas which gradually sapped the foundation of traditional beliefs, and led to the questioning of the authority upon which the old beliefs rested. The migration of students from one university to another spread the doctrines of rationalistic teachers far beyond their own lecture rooms. Thus were the ideas and the writings of Wiclif carried to Prague.

(See UNIVERSITY.) When Dante (q.v.) headed the great revival of learning and letters, which, starting in Italy, spread over Europe, a new and more permanent shape was given to the growing controversy as to the relations of Church and State. Dante in the *De Monarchia* and Marsilius of Padua (q.v.), a partisan of the emperors, in the *Defensor Pacis*, attempted to find new bases for the relations of Church and State in Christendom; and the latter especially advanced political theories that were distinctly modern in their nature. The Renaissance (q.v.), by opening new fields of thought, gathered in all these currents and gave them new power. Devoted Catholics, like Dante and later Savonarola, demanded reform within the Church, reform 'in head and members,' as the University of Paris reformers put it. Skepticism became rife; while a few men who could not be skeptics, and would not accept a religious system of which the popes of the fifteenth century were the representatives, sought for another basis of faith. Many sects in different countries, the offspring of abortive attempts at a return to simpler primitive Christianity, or of mystical or heretical teaching, had also prepared the minds of the masses of the people, less accessible to the more intellectual currents of the age, for a new movement. Such were the Apostolic Brethren, Beghards, Beguins, Cathari, Flagellants, Fratitelli, and the Lollards. The earlier sects of the Albigenses (q.v.) and the Waldenses (q.v.) or Vaudois were also in a way a part of these earlier movements that formed the motley advance guard of the Reformation, but they lacked the intellectual strength and the political and social power that were necessary to make an abiding impression on feudal Europe.

GERMANY. Germany with its more than three hundred States, loosely held together in the Empire, and seeking blindly to realize German nationality, always pulling hard against the assertions of Papal authority and of the Emperor, who represented Hapsburg rather than German interests, was in the sixteenth century in a favorable condition for starting the new movement for which the centuries had thus been preparing. Strenuous efforts were being made by the Papacy to raise money to complete Saint Peter's and to carry on war with the Turks. Martin Luther, then a professor in the University of Wittenberg and a parish priest, was aroused against the system which connected the distribution of indulgences with these efforts, as carried on by Tetzel (q.v.). On October 31, 1517, Luther nailed to the church door at Wittenberg the ninety-five theses in which he challenged the abuses of the Church. He seemed unconscious of the tremendous revolution he was setting on foot, but events moved rapidly. He defended his position on historical grounds in public disputation and in writing, taking by degrees a more advanced position than at first. In his scheme, which rested on salvation by faith rather than by the formal works of the sacraments, he reduced the seven sacraments to three—baptism, the Lord's Supper, and penance. On the 10th of December, 1520, he publicly burned a copy of the Papal bull of excommunication which had been directed at him by Leo X. and also one of the canon law, thus symbolically breaking with the whole system upon which the Roman ecclesiastical structure rested. In 1521, sum-

moned by the new Emperor, Charles V., to the Diet at Worms, he refused to retract and was sequestered for a time in the Castle of Wartburg, under the protection of his friend the Elector Frederick of Saxony. He had now reached the point where he must begin a constructive movement. He translated the Bible into vigorous colloquial German, assisted by his friend and coworker, Melancthon, and entered into communication with the North German princes, many of whom gave him their support. At the Diet of Speyer in 1529 a majority of the princes and representatives of the cities issued the 'Protest' which gave to the adherents of the new movement the name of Protestants, and a year later at the Diet of Augsburg, when the Emperor was present, they set forth their views in the Augsburg Confession (q.v.), prepared by Melancthon, which it was hoped would be a means of mediation. The Protestants were then in a minority, however, and a decree of condemnation was passed, beginning the long and bitter struggle. The Protestants organized the League of Schmalkald for defense, but for some time the political difficulties with which Charles had to deal in his rivalry with France and the necessity of uniting Germany against the onslaughts of the Turks made him defer the execution of the decree of Augsburg. But in 1546, immediately after the death of Luther, the Emperor turned his attention to the Schmalkald League and in 1547 he defeated it with the aid of Duke Maurice (q.v.) of Saxony. (See MÜLLBERG.) The return of the latter to the Protestant side turned the tables and the Emperor concluded a treaty at Passau in 1552, in which the Protestants stipulated for the free exercise of their religion, until the meeting of a diet which should settle a permanent religious peace; and in return they agreed to lend assistance against the Turks, who were still menacing the frontiers of the Empire. The promised diet assembled at Augsburg in 1555 and framed articles for the religious pacification of Germany, according to which each prince might choose between Lutheranism and Catholicism, the religion of the prince to be that of his people. Any prelate on becoming Protestant was to resign his benefice, and subjects of ecclesiastical princes were to enjoy religious liberty. This peace gave recognition to the Lutherans. It established a *modus vivendi* between the adherents of the old and new creeds, which soon proved to be a precarious one, and finally the issues between Catholics and Protestants were fought out in the Thirty Years' War to a settlement in the Peace of Westphalia (1648).

DENMARK AND SWEDEN. In the neighboring countries of Denmark and Sweden the progress of reformed opinions had been more rapid than in Germany. In both these countries the sovereigns took the lead. In Sweden particularly Gustavus Vasa pursued a vigorous policy in favor of the Reformation. He invited Lutheran teachers into his dominions, and showed special zeal in the circulation of a Swedish version of the Scriptures, made by one of these teachers, named Olaus Petri, who occupies the most prominent place among the Swedish reformers. At an assembly of the States at Westerås in 1527 it was unanimously resolved that the Lutheran doctrines should be adopted in Sweden, and a Reformed Church, entirely independent of

Rome, established. The same result occurred in Denmark in 1539, when an assembly of the Danish States at Odense gave formal sanction to a plan of religious doctrine, worship, and discipline, drawn up by Bugenhagen, a disciple and friend of Luther, whom Christian III. had invited from Wittenberg for the purpose.

SWITZERLAND AND CALVIN. Parallel with the Lutheran movement in Germany a religious revolt on similar lines developed in the German cantons of Switzerland under the leadership of Ulrich Zwingli (q.v.), a Zurich pastor (1519). The causes of the Swiss movement were partly political, but the underlying principles involved were the same as in Germany, and the outbreak was finally due to the question of indulgences. The cantons surrounding Lake Lucerne remained, as they are to-day, strongly attached to the Catholic faith. Their resistance to the reformers led to a civil war, and Zwingli was killed in 1531 while accompanying the troops of Zurich on a disastrous expedition. Before Zwingli's death in 1529 an attempt was made by the friends of the two reform leaders to bring Luther and Zwingli into coöperation. Luther and Melancthon met Zwingli, Bucer, and Œcolampadius at Marburg on the invitation of Philip, Landgrave of Hesse, one of the earliest and wisest supporters of the Reformation. The meeting failed to accomplish anything, owing to their difference in regard to the Lord's Supper, which Zwingli held to be a memorial and a symbol, while Luther insisted on the acceptance of the doctrine of consubstantiation as a fundamental principle of Christian faith. Thus the division of Protestantism began on the very threshold. Zurich declared its ecclesiastical independence in 1524, Berne and Saint Gall followed in 1528, Basel and Schaffhausen in 1529. The movement was checked temporarily by the defeat of Zurich and the death of Zwingli, but the accession of Geneva to the Protestant cause in 1535 and the establishment there of John Calvin, the great organizer of the Reformation, gave a new impulse to the Swiss movement and speedily made Switzerland a centre for the promulgation of Reformation ideas. Calvin was the needed element to make the Reformation aggressive. Luther was too thoroughly a German to carry much weight except among Germanic peoples, and Lutheranism became a German State religion, settling in time into a rigid mold which prevented expansion. Calvin, on the other hand, was more of a jurist and administrator than a preacher. His theological creed was one that in those days most of the reformers could accept, and his *Institutes* became the constitution of Protestantism, outside of the North German and Scandinavian countries. The Swiss followers of Zwingli adhered to the new leader. Two great Protestant sects were thus formed at the very beginning—Lutherans and Calvinists or 'Reformed.' From the teachings of Calvin came the congregational idea of Church government with its far-reaching political consequences. The Protestants of France, Holland, and Scotland followed the guidance of Calvin, who maintained a constant correspondence with the leaders of the Reformed movement in these countries. A little later, when persecution began in England, English exiles came to the Continent, imbibed the lessons of Calvinism, and carried them back to become the marrow of English Puritanism.

FRANCE. The new doctrines took a strong hold among some of the upper and middle classes in France as early as 1523, among their supporters being Margaret, Queen of Navarre, the sister of Francis I. Most active in the propaganda at this stage were Lefèvre and Farel, the latter formerly a priest. But France had always been the stronghold of Catholicism, and the fact that the Protestant movement took on a class form was against it in a country where class lines were sharply drawn and sympathy between the orders was lacking. The peasantry opposed an immovable front to the new creed, and the vacillating policy of Francis I. and the fierce factional spirit engendered by the struggle prevented the Reformation from obtaining in that country the national standing that it gained in Germany and elsewhere. The most important contribution of France to the movement was in the person of John Calvin. Both Farrel and Calvin were driven into Switzerland. The latter settled for a time at Basel, where he published the first edition of the *Institutes*, the preface of which, dated August 1, 1535, was addressed to Francis I. In the following year Calvin was drawn to Geneva through the influence of Farel, and there entered upon his great career. A succession of civil wars, known as the Wars of Religion, convulsed France and threatened its ruin, but in the end the old Church triumphed and France retained its historic place as a chief pillar of the Roman Catholic Church. See HUGUENOTS.

SOUTHERN EUROPE. In Italy and Spain, as in France, the idea of the Reformation gained ground at first quite rapidly with the upper and intellectual classes, but did not appeal to the masses of the people. Many leading Catholics, such men as Caraffa and Contarini in the College of Cardinals, were desirous of the reform of existing ecclesiastical abuses, but had no sympathy with revolt against the Papacy. Protestantism obtained no footing in either Italy or Spain, and after the Council of Trent it practically disappeared. The Inquisition and the Index (qq.v.) were used as instruments in the suppression of heresy. The Inquisition had become active in Spain in the fifteenth century, but it was utilized to its fullest extent under Philip II.

THE NETHERLANDS. The Netherlands were Spanish provinces at the beginning of the Reformation period, but, as in other Germanic countries, the Reform doctrine found ready acceptance, and Charles, and after him Philip, attempted the same policy that was so effective in Spain. But the long and desperate struggle resulted in the erection of an independent Protestant State out of the northern Dutch provinces. See ALVA; EGMONT; HOORN; WILLIAM OF ORANGE.

EAST-CENTRAL EUROPE. As has already been said, John Huss had made Bohemia practically a Protestant country, and its inhabitants adopted the Reformation with great readiness and entire sincerity. They were severely punished for refusing to act against their Protestant brethren of the League of Schmalkald, but in 1609 they were able to extort from the Emperor Rudolph II. the so-called *Majestätsbrief*, an edict of toleration. Many followers of Huss, however, did not accept Lutheranism. The rising of the Bohemian Protestants in 1618 was the opening episode of its Thirty Years' War. They were crushed in 1620 and Protestantism was rooted out. In Po-

land, although it remained a strongly Catholic country, there were many Lutherans and Calvinists. In Hungary Bohemians, Germans, and Waldenses aided in spreading the Reformed doctrines, but the rivalries between Lutherans and Calvinists, intensified by the fact that the former were principally Germans and the latter Magyars, weakened the Protestant cause and enabled Catholicism to maintain the upper hand.

ENGLAND AND SCOTLAND. It has long been asserted that there was a strong popular support among the common people of these countries for the Reformation ideas, traceable mainly to the work set on foot by John Wiclif, and that as early as the beginning of Luther's activity there were indications of a revival of evangelical religious life among the tradesmen of London, and the peasantry in different parts of the country, particularly in Lincolnshire. The residence of Erasmus in England in the beginning of the reign of Henry VIII. stimulated a spirit among the educated classes which, while it remained for the most part faithful to the Roman Catholic Church, as in the case of More and others, yet helped to advance a dissenting movement. In 1529, a year before the meeting of the Diet of Augsburg in Germany, the usurpations of the clergy and the manifold ecclesiastical abuses prevailing in the country were the subject of Parliamentary legislation. But the most recent historical research has tended to show that the survival of Lollard ideas and the popular support of such a movement have been much overestimated. In both England and Scotland, the Reformation was closely bound up with political conditions. In Scotland the nobility made use of it as a trenchant instrument against royal authority; and in England Henry VIII. espoused its cause in furtherance of his own policies. The negotiations as to Henry's divorce from Catharine had been proceeding for some time, and the country was greatly excited by the course of events. In 1533 Henry was married to Anne Boleyn and his former marriage with Catharine was declared void. All appeals to Rome were forbidden. Henry found it helpful to his own plans to be free from ecclesiastical interference, and in the two following years the sovereign was declared to be the supreme head of the Church of England, with authority to redress all errors, heresies, and abuses in the Church; the monasteries were dissolved; and Parliament petitioned that a new translation of the Scriptures might be authorized and set up in churches. (See ENGLAND; HENRY VIII.) In all this course of reformation, however, there was but little religious impulse on Henry's part, for we find him again in 1539 passing the statute known as the Six Articles, which rendered it penal to deny the doctrine of transubstantiation, or to affirm that priests might marry. The King's move, however, fell in with the vigorous growing spirit of English nationality and hence received support. With the accession of Edward VI. in 1547 the Reformation greatly advanced. The statute of the Six Articles was repealed with other measures of the close of Henry's reign. The Parliament of 1548 established the use of the Book of Common Prayer; the clergy were permitted to marry; the cup was allowed to the laity; and in 1551 the 42 articles of religious belief, afterwards reduced to 39, were promulgated. The temporary restoration of Catholicism by Mary and the final es-

establishment of Protestantism under Elizabeth are well-known events, belonging to the special history of these reigns.

In Scotland the reforming impulses began with Patrick Hamilton. Hamilton was educated in Paris and in Germany, and learned there the doctrines which he introduced into his native country. There was something, indeed, of the same popular movement, known under the name of Lollardism in Scotland, as in England, and Hamilton's preaching may have served to kindle the dying embers of this movement. His early death in 1528 undoubtedly produced a great effect. After Hamilton George Wishart appears as the next champion (q.v.) of the Scottish Reformation; and in connection with him we first hear of John Knox, who became finally the leading spirit of the movement, by whose influence the Reformation was established in Scotland in 1560. The Scottish Reformation followed the type of the Calvinistic Reformation in Geneva, where Knox had taken refuge during the period of persecution in Scotland, and acted for some years as the companion of Calvin. Episcopacy was abolished, and the Reformed Church set up in every respect as far as possible in opposition to the Papal system.

For the efforts made by the authorities of the Roman Catholic Church to counteract the dissident movement, see COUNTER-REFORMATION; TRENT, COUNCIL OF.

BIBLIOGRAPHY. Among the best original sources for the Reformation are the works and correspondence of the noted men of the period. For certain aspects, however, the Papal archives furnish the most desirable material. For this the various collections of documents should be consulted, notable among which are: Tomasetus, *Bullarum, Diplomatum et Privilegiorum Sanctorum Romanorum pontificum*, vols. iv., v. (Tours, 1859-60); Chevalier, *Répertoire des sources historiques du moyen-âge* (Paris, 1877-83); *Collectio Bullarum*, vol. ii. (Rome, 1750). The decrees of the council are to be found in Labbé, *Sacrosancta Concilia* (Venice, 1728-33), while all the facts and documents relative to the Council of Constance have been separately collected and are to be found in the monumental work of Hardt, *Magnum Œcumenicum Constantiense Concilium* (Frankfort and Leipzig, 1697-1700). Among secondary works, which treat specifically of the Reformation and the conditions which produced it, three works are specially important: Ranke, *Deutsche Geschichte im Zeitalter der Reformation* (Berlin, 1847) represents the old, conservative view, now generally known as the Protestant presentation; Janssen, *Geschichte des deutschen Volkes seit dem Ausgange des Mittelalters* (Freiburg, 1877-94; Eng. trans., London, 1896-1903), and Pastor, *Geschichte der Päpste* (2d ed. Freiburg, 1891-95; Eng. trans., London, 1896-98) present ably and scientifically the views of the recent Catholic school of historians. Probably the best work in English, which covers this period is Creighton, *History of the Papacy During the Reformation* (London and Boston, 1882-94). Other works of value are Bezold, *Zur Geschichte des Husitentums* (Munich, 1874); Gebhardt, *Die Gramina der deutschen Nation gegen den römischen Hof* (Breslau, 1884); Gregorovius, *Geschichte der Stadt Rom* (3d ed., Berlin, 1879-

80); Hefele, *Conciliengeschichte* (Freiburg, 1867-74); Lorenz, *Papstwahl und Kaiserthum* (Berlin, 1874); Lindner, *Geschichte des deutschen Reiches* (Brunswick, 1875-80); Palacky, *Geschichte von Böhmen* (Prague, 1845-60); Reusch, *Der Index der verbotenen Bücher* (Bonn, 1883-85); Rossman, *Betrachtungen über das Zeitalter der Reformation* (Jena, 1858); Ullmann, *Reformation vor der Reformation* (Hamburg, 1841-42); Gasquet, *The Eve of the Reformation* (London, 1900). The various general Church histories, especially those of Baur, Gieseler, Hardwick, Ilase, Kurtz, Hergenröther, Darras, Alzog, and Riffel are also valuable. Seebohm, *The Protestant Revolution* (London, 1887; Häusser, *Period of the Reformation*, trans. from the German (ib., 1873); and Fischer, *History of the Reformation* (New York, 1890), are small works, valuable for a general aspect of the Reformation. The Reformation in the great institutions of learning may be best studied in Denifle, *Die Universitäten des Mittelalters* (Berlin, 1895). Consult also the principal works mentioned under RENAISSANCE.

REFORMATORIES. Penal institutions for young offenders where the object of punishment is subordinated to that of moral regeneration. It is difficult to fix definitely the time when it was recognized that juvenile offenders should not be merely punished for crime, but that efforts should be made to reform them.

The eighteenth century was fruitful in humanitarian movements and the condition of prisoners was not overlooked in the general effort to ameliorate suffering, and to awaken the sense of individual responsibility which was characteristic both of the religious revival under the Wesleyans, and of the political reforms led by the French and English radicals. The philanthropic efforts of John Howard and Elizabeth Fry, in particular, prepared the way for new views in penology. At the same time interest in the care of neglected children and of juvenile delinquents which had from the days of Elizabeth found expression in the English Poor Law (q.v.), was leading to many new experiments. The most valuable of these, however, was first tried in Germany, where, in 1833, the Rauhes Haus (q.v.) in Hamburg introduced the plan of having the children cared for in 'families' on the cottage plan. This principle was adopted at Mettray, France, in 1839, and has since become the favored method for juvenile reformatories, though the congregate plan still exists and has its adherents. Captain Brenton, of England, about 1830 urged that no child under sixteen should be sent to prison, but should be trained in some special institution. In accord with his ideas an industrial school for girls was started at Chiswick. In 1847 the institution at Saint George's restricted its care to boys charged with or convicted of crime. From this time the movement made progress in England. In 1854 the Reformatory Schools Act was passed, which took legal cognizance of the principles of the reformatories. France, in 1850, had already enacted similar legislation. Distinction must be made between the purely industrial schools which receive children who are destitute and the reformatory schools which receive those guilty of criminal acts. Sometimes, particularly in the earlier institutions, the two classes were mixed.

In 1898 there were in England 48 reformatories and 144 industrial schools; Prussia had 7 reformatories and 16 private institutions under Government supervision. In 1896 France had 6 public and 12 private reformatories for boys (one being in Algeria), and 4 public and 7 private for girls. In Holland juvenile delinquents under ten are sent to reformatories, of which there are four. Most of these schools are situated in the country.

The reformatory system has had its widest development in the United States. In 1824 the House of Refuge on Randall's Island, New York, was established by law. It was and still is conducted on the congregate plan. Other cities followed the example. Such houses of refuge were under private control, but the public shared in the expense. These early institutions were followed by State reform schools. The change in names is interesting. All indications that the boys were committed to the institution for breaches of the law were avoided, as for example in the title of the Lyman School for Boys (1848). Besides these institutions for delinquents there have sprung up many industrial schools for orphans and neglected children. Usually the two are separated and the sexes also are usually in separate schools. In 1900 there were 65 juvenile reformatories in the country, with a population of 19,410, while the total number of children they had sheltered was 209,600. In the earlier institutions the employment of the children was too often decided from a financial standpoint solely. It is now recognized that it should be not 'productive,' but 'instructive.'

It remained for the United States further to develop the reformatory system and make it applicable to young men and women. The principles introduced at Norfolk Island by Macdonochie, and in Ireland by Crofton, had found favor in the country. It was proposed to combine these with the principles of the reformatories and seek not merely to punish, but to bring to self-support and self-respect the younger criminals for whom there might yet be hope. The beginning of this movement dates from the National Prison Congress of 1870, at which Z. R. Brockway outlined a plan for a new class of institutions. In 1866 New York had enacted legislation establishing a reformatory. The plans were altered in 1869, but it was not opened until 1876, when Mr. Brockway was appointed superintendent of the Elmira Reformatory (q.v.). In 1877 the principle of the indeterminate sentence was legally adopted. The growth of the institution and its constant success won world-wide attention. In 1877 Massachusetts founded a reformatory for women at Sherborn, and in 1884 one for men at Concord. Many other States have followed the example of these two.

The fundamental idea of these reformatories is that instead of repressive and punitive measures there should be constant training along lines of industry, physical and mental development, to enable the prisoner to stand alone after his release. To make more effective this training, his self-interest is appealed to by the indeterminate sentence. This makes the length of his stay in the institution largely dependent upon his behavior and progress while there. He is thus stimulated to take advantage of his opportunity. His release is conditional, and if he violates the terms of his parole he may be returned to the

institution. The claim is made that fully eighty per cent. of young felons released from American reformatories have subsequently led upright lives. Unfortunately, the claim can be neither supported nor disproved, because no systematic trace and record is kept after the full term of the original sentence has expired.

The age limits within which first offenders are sentenced to reformatories vary. The lower limit is usually fifteen or sixteen years. The upper limit seldom exceeds thirty. In form of construction reformatories are like prisons with separate cells. The inmates are divided into grades, usually three. The Shelborn Reformatory for Women in Massachusetts has four. There are different privileges for the different grades, and release on parole is open only to those in the highest. Consult: Barrows, *The Reformatory System in the United States* (Washington, 1900). The best general sources are Drähms, *The Criminal* (New York, 1900), and Wines, *Punishment and Reformation* (ib., 1895). The Reports of the International and National Prison Congresses, and the Reports of the National Conference of Charities and Correction contain many papers on the general subject. See JUVENILE OFFENDERS; PENOLOGY; PRISONS.

REFORM BILLS. In English history, the name of several measures introduced into Parliament, chiefly during the nineteenth century. These bills, three of which were passed—namely, in 1832, 1867, and 1884-85—aimed to abolish the abuses which had grown up in regard to the representation in the House of Commons. The franchise was also widely extended, and in practice the House of Commons became all-powerful. For details regarding the struggle, which preceded the passing of the great Reform Bill of 1832, see GREY, CHARLES, second Earl Grey; for the provisions of the various acts, see PARLIAMENT. See also sections on *History and Government* under GREAT BRITAIN.

REFORMED CATHOLIC CHURCH. A movement begun in New York City between 1880 and 1885 among priests who had renounced the jurisdiction and doctrine of the Roman Catholic Church and engaged in evangelistic labors among the people. It has 6 ministers, 6 church organizations, and 1500 members, chiefly in New York, Massachusetts, Pennsylvania, and Illinois.

REFORMED CHURCH IN AMERICA. THE. A body of Christians in the United States composed originally of settlers from Holland, but now largely intermixed with elements from many other sources. Until 1867 it was known as the Reformed Protestant Dutch Church in North America. The history of the Church begins with that of the Reformation in the Netherlands, where the movement met with a hearty welcome.

Entering from Germany, it afterwards received its chief impetus from Switzerland and France. Hence its distinctive type of the Reformed doctrine and the more democratic Presbyterian polity. But in Holland, as elsewhere, there had been a great preparation made by reformers before the Reformation. The monks John Eseh and Henry Voes for their evangelical preaching were burned at Brussels (1523) and were perhaps the first martyrs of the Reformation. The Reformed Church of the Netherlands began her more formal existence in 1566, when the so-called 'League of Beggars' was formed.

Field preaching and the singing of evangelical hymns rapidly spread the Reformed doctrine. Conventions or synods of the Dutch Reformers during the next two decades formulated a liturgy and rules of Church government, and adopted standards of doctrine—the Belgic Confession and the Heidelberg Catechism (qq.v.). Because of Spanish persecution these synods were held outside of Dutch territory. In 1643 copies of these rules of Church government were sent to the Westminster Assembly as a specimen of Presbyterian polity. In 1618-19 the famous Synod of Dort (qq.v.), called to consider the controversy which had sprung up between the Calvinists and Arminians, formulated the Canons of the Synod of Dort.

The earliest Dutch Church organization in America was made in New York in 1628 by Rev. Jonas Michaëlius. This is now the strong and wealthy Collegiate Church, with its half-score of buildings and fourteen ministers. During the government of the West India Company down to 1664 thirteen Dutch churches were established in America and sixteen ministers in all had officiated. Then came the English conquest. Dutch immigration ceased. It was a question whether the Dutch Church could survive under the English Government. During the next half century there was an almost constant struggle with the English Governors, who naturally sought to establish the Church of England. During this same period there was also a considerable accession of Huguenots to the country, who largely fell into the fold of the Dutch Church. At first, however, during the reigns of Charles II. (1660-85) and James II. (1685-88), full liberty was ostensibly granted to all denominations. But with the accession of William III. (1688) the normal policy of the English Government was restored, and more persistent attempts were made to impose the Church of England on a population which was overwhelmingly Dutch. A Ministry Act was secured in 1693, but it had been so emasculated in its passage that it was found to be entirely unsectarian; yet it was often arbitrarily perverted by certain of the Governors in favor of the Church of England. Because of such perversion the Dutch Church of New York City managed in 1696 to extort a charter from Governor Fletcher, and this course was successfully followed by other Dutch churches, so that the Dutch Church really remained ecclesiastically independent. During this period of struggle the churches increased to forty, and about twenty-four new ministers were sent from Holland.

During the eighteenth century many Palatines arrived on the Hudson, making sooner or later about twenty German churches, which were also under the Classis of Amsterdam. Increasing desire for a general ecclesiastical organization and for institutions of learning now began to be expressed. There were some conflicts at first between the more revivalistic methods of Berthoff and Frelinghuysen, which were of a Labadistic character, and the more conservative methods of others. A church organization styled the Cætus was formed in 1747, but, owing to ecclesiastical interference from Holland, it found itself unable to ordain. Hence it declared itself an independent American Classis with full powers in 1754. Meantime, an effort was made to establish a Dutch divinity professorship in Kings College, New York City, which was accomplished in 1755,

but this split the Church more completely and led to the securing of a charter for Queen's College (New Brunswick, New Jersey) in 1766 and an amended charter in 1770. The two parties came together in 1771 upon articles of union, securing semi-independence from the Church of Holland, but the Revolution delayed the speedy development of the new plans. In 1784 a professor of theology was elected—Rev. Dr. John H. Livingston—and this was the beginning of a theological seminary, the first in the country.

In 1792 an Americanized constitution of Church government was adopted, which has gone through two revisions since—namely, in 1832 and 1874. The Church continued to grow slowly. In 1800 there were about 100 churches and forty ministers in service. The number of ministers did not equal the number of churches until 1845, when there were 375 of each. In 1846 began a new Dutch immigration which settled in the middle West, but is now penetrating even to the Pacific Coast. Many of these new-comers fell into the old Dutch Church, and there are now more than 200 churches from this source and as many ministers.

In doctrine the Reformed Church in America has ever adhered to the standards already referred to, adopted in Holland. She also indorsed the Westminster Catechism in 1837. Her form of government is of the so-called Presbyterian type, first proposed by Calvin, and was adopted in 1568. This enumerated four classes of officers in the Church, viz. ministers, teachers (or professors), elders, and deacons. Four grades of ecclesiastical bodies were also defined, viz. Consistories, Classes, Provincial Synods, and a General Synod. The Reformed Church has a liturgy, but this is obligatory only in the administration of the sacraments and ordinations. It has received some additions from time to time as necessity required. In all other respects her mode of worship is free. The General Synod is incorporated and holds all funds and endowments of the theological seminaries, and, in part, of the colleges and other agencies. The General Synod operates through a board of direction. The colleges are also incorporated, as well as the various boards, such as the board of education, the board of foreign missions, the board of domestic missions. The churches exist in New York, New Jersey, Pennsylvania, Maryland, Ohio, Michigan, Wisconsin, Indiana, Illinois, the Dakotas, Minnesota, Kansas, Nebraska, Montana, South Carolina, Oklahoma, and Washington.

In 1903 the Reformed Church in America reported 633 churches, 703 ministers, 61,000 families, and 113,000 communicants. There are also about 119,000 children in the Sabbath schools. Nearly \$400,000 was raised during the year for benevolent objects, and \$1,250,000 for congregational purposes. This Church has several flourishing institutions: Rutgers College (1766) and a theological seminary (1784) at New Brunswick, N. J.; Hope College (1866), and the Western Theological Seminary (1866) at Holland, Mich.; and incipient institutions in other States. The Church has been especially successful on the foreign field, having missions in India, China, Japan, and Arabia, having sent out more than 200 missionaries, male and female. In 1902 the wonderfully successful Classis of Arcot, India, with 25 regularly organized churches, many of them having native pas-

tors, was formally transferred in the interests of Church union to the Synod of South India, of the South Indian United Church. The missions in China and Japan are working in hearty union with missions of other denominations.

BIBLIOGRAPHY. Consult: Hansen, *The Reformed Church of the Netherlands* (New York, 1884); Brodhead, *History of the State of New York* (ib., 1853-71); Gunn, *Memoir of Rev. John H. Livingston, D.D.* (ib., 1829; 2d ed. 1856); Demarest, *History and Characteristics of the Reformed Church* (ib., 1856; 2d ed. 1890); id., *Centennial Discourses* (ib., 1876; 2d ed. 1877); Corwin, *Manual of Reformed Church* (ib., 1859; 4th ed. 1902); id., *Centennial of the Theological Seminary at New Brunswick* (ib., 1885); id., *Ecclesiastical Records of the State of New York*, published by the State, under the supervision of Hugh Hastings, State Historian, 2 vols., 1620-1700 (Albany, 1901). These are the documents procured by Rev. Dr. Corwin in Holland (1897-98), with collateral material from other sources; to be followed by four more volumes (1701-1800).

REFORMED CHURCH IN THE UNITED STATES, THE (GERMAN REFORMED). A religious body founded by emigrants from the Palatinate and other districts of Germany. Their first minister was Rev. Samuel Guldin, who came in 1710; their first church was founded at Germantown, Va., 1714; and their first permanent pastor, who became the organizer of the Church, was Rev. J. P. Boehm, who organized the first congregation at Falkner Swamp, Pennsylvania, in 1725. Their organization as a denomination was completed by Rev. Michael Schlatter, who was sent by the Reformed Church of the Netherlands (1746) and organized their Synod (then called a Cetus) September 29, 1747. He revisited Europe in 1751, bringing back (1752) six young ministers who became the forerunners of others sent over by the Reformed Church of the Netherlands. The Church continued under the supervision of the Church in Holland till 1793, during which time that Church sent over 31 ministers and spent about \$20,000 on the Pennsylvania churches. When the Church in Pennsylvania became independent in 1793 it numbered 22 ministers, 78 congregations, and about 15,000 members. After it had become independent it had to face two serious difficulties. One was the change of language from German to English, which caused friction in congregations and the loss of many of the young people, who became English before the Church service did. The other difficulty was the lack of a theological seminary in which to train ministers. The old method had been for prominent ministers to train the young men privately, and three of them had founded what were virtually private theological seminaries; Rev. C. L. Becker, at Baltimore; Rev. S. Helffenstein, at Philadelphia; and Rev. F. L. Herman, at Falkner Swamp. But this method proved insufficient to supply the number required. So the Synod of 1820 determined to found a theological seminary of its own. This was opened (1825) at Carlisle, removed later to York and to Mercersburg, and is now located at Lancaster, Pennsylvania. After the seminary had been founded a classical school was connected with it which grew into Marshall College, later Franklin and Marshall College at Lancaster. This movement for the foundation

of a seminary, however, resulted in a division of the Church, as those who opposed the movement separated and formed a free synod in 1822, which in 1837 returned to the mother synod.

Meanwhile the denomination was spreading southward from Pennsylvania through Virginia to the Carolinas, and westward through Ohio, Indiana, and the Western States. Most of the German churches in New York State went into the Dutch Reformed Church. A missionary society was organized in 1826 which published (1828) the first Church paper, *The Magazine of the German Reformed Church* (later called *The Messenger*). The western part of the Church founded Heidelberg College and Theological Seminary (1850) at Tiffin, Ohio. A mission house to educate German ministers was opened at Franklin, Wisconsin (1860). The call of Rev. J. W. Nevin in 1840 and of Rev. Philip Schaff in 1844 prepared the way for the controversy about the Mercersburg theology (q.v.) and the liturgy. As the result of the liturgical movement the *Provisional Liturgy* was published (1757), the *Order of Worship* (1866), and the *Western Liturgy* (1867). The Low Church party in the East founded Ursinus College (1870) at Collegeville and a theological school (1871) (now at Philadelphia). The liturgical controversy continued till 1878, broken only by the observance of the tercentenary of the Heidelberg Catechism in 1863, which led to a union of the Eastern and Western sections of the Church in a General Synod. In 1878 that General Synod appointed a peace commission, which later drew up a new liturgy, the *Directory of Worship*, which was adopted by the Church. Since the peace movement has been completed the Church has been increasing rapidly, gradually centring its work in the boards of the General Synod. Missions were opened in Japan (1879), among the Indians in Wisconsin (1878), and in China (1900). Doctrinally the Church was eradled in Calvinism, as all its ministers sent by Holland were required to subscribe to the Calvinistic Confessions; but in 1844, under Dr. Nevin and Dr. Schaff, the mediating theology of Germany was introduced. The denomination numbered in 1902 8 synods, 58 classes, 1107 ministers, 248,929 members, and about 750,000 adherents. Its contributions in 1901 were \$270,288 for benevolent objects and \$1,303,000 for congregational purposes. Consult: Dubbs, *History of the German Reformed Church* (American Church History Series, vol. viii., New York, 1895); Good, *History of the Reformed Church in the United States, 1725-92* (Reading, 1899); id., *Historical Hand-Book* (Philadelphia, 1902); id., *Women of the Reformed Church* (ib., 1902).

REFORMED CHURCHES. A term employed in a conventional sense to designate those Protestant churches which follow the doctrines and polity of Zwingli and of Calvin (q.v.) rather than the Lutheran. (See LUTHERANISM.) The influence of Calvin proved more powerful than that of Zwingli, and on the Continent of Europe the Reformed churches are generally known as Calvinistic churches, the name Protestant Church in some countries being almost equivalent to Lutheran. One chief distinction of the Reformed churches is their doctrine of the Lord's Supper (q.v.); another is that concerning the divine sovereignty and election. (See CAL-

VINISM.) They also reject certain ceremonies which the Lutherans have seen fit to retain. The Church of Scotland, the Protestant Church of France, that of the Netherlands, some German churches, and the Protestant churches of Hungary, Bohemia, and Poland belong to the Reformed churches. Most of the Protestant churches in the United States have sprung from Reformed churches in Europe. See REFORMATION; PRESBYTERIANISM.

REFORMED EPISCOPAL CHURCH, THE. A religious body which was originated for such members of the Protestant Episcopal Church as were opposed to the growth of sacramentarianism and sacerdotalism in that communion, and for any others who, like-minded with them, desire to be associated with a Church evangelical in its teachings, liturgical in its worship, and episcopal in its government. It was organized in New York City, December 2, 1873, with eight clergymen and twenty laymen, all of whom had been or were at the time ministers and laymen in the Protestant Episcopal Church identified with the 'evangelical' or 'Low Church' party. One of them, George David Cummins, had been Assistant Bishop of the Diocese of Kentucky until November 10, 1873, when by letter to the presiding Bishop he resigned his office and withdrew from the denomination. He became the Bishop of the new organization; the Rev. Charles Edward Cheney of Chicago was also elected bishop, and consecrated on a subsequent day. The following statement, condensed from the declaration of principles adopted at the organization, explains in the briefest form possible the doctrines held: I. The Reformed Episcopal Church declares its belief in the Holy Scriptures of the Old and New Testaments as the word of God and the sole rule of faith and practice; in the Apostles' Creed; in the divine institution of the sacraments of baptism and the Lord's Supper; and in the doctrines of grace substantially as they are set forth in the 39 articles of religion. II. It recognizes and adheres to episcopacy, not as of divine right, but as a very ancient and desirable form of Church polity. III. Retaining a liturgy, not imperative or repressive of freedom in prayer, it accepts the Book of Common Prayer as it was revised, proposed, and recommended for use by the General Convention of the Protestant Episcopal Church (1785); reserving the right to make alterations in it, provided that the substance of faith be kept entire. IV. It condemns and rejects the following doctrines as contrary to the word of God: (1) That the Church of Christ exists only in one form of ecclesiastical polity. (2) That Christian ministers are 'priests' in another sense than that in which all believers 'are a royal priesthood.' (3) That the Lord's table is an altar on which an oblation of the body and blood of Christ is offered anew to the Father. (4) That the presence of Christ in the Lord's Supper is a presence in the elements of bread and wine. (5) That regeneration is inseparably connected with baptism.

At the sixteenth General Council, Baltimore, 1900, there were reported as belonging to the denomination in the United States and Canada: 7 bishops, 81 presbyters, 13 deacons, 94 parishes, 10,002 communicants, of whom 428 were added by confirmation, and 191 were otherwise received during the past three years, 876 Sunday school

teachers, and 10,106 scholars; total offerings of three years preceding, \$172,418; value of church and parish buildings and rectories, \$1,609,930. The Reformed Episcopal Church in England at the same date had 1 bishop, 24 presbyters, 1 deacon, and 3 lay readers, 21 parishes, with 1500 communicants, 2580 Sunday school scholars, and 256 teachers. The denomination is strongest in Philadelphia and Chicago, and has 11 parishes in Canada and British Columbia. It has a well-equipped theological seminary in Philadelphia, with a faculty of 5 professors, and a preparatory department; maintains 2 denominational papers, and supports a Woman's Foreign Missionary Society, with two effective stations in India. The trustees of its sustentation fund hold endowments of over \$125,000.

REFORMED MENNONITES, THE. See MENNONITES.

REFORMED PRESBYTERIANS. See CAMERONIANS; PRESBYTERIANISM.

REFRACTION (ML. *refractio*, breaking up, refraction, from Lat. *refringere*, to break up, from *re-*, back again, anew + *frangere*, to break). A phenomenon, like reflection, common to all kinds of wave-motion. If there are two media separated by a bounding surface in which the trains of waves of the particular kind travel with different velocity, a train of waves in one medium will, on reaching the bounding surface, produce similar waves in the other medium; these are called refracted waves, because in general each ray of the incident waves has its direction changed or broken at the surface. (See LIGHT.) Snell's laws for refraction are that the angles α_1 and α_2 made by the incident and refracted rays with a perpendicular to the refracting surface at the point of incidence are

connected by the relation: $\frac{\sin \alpha_1}{\sin \alpha_2} = n$, a constant

for the two media if the waves have a constant wave-number, and that the two rays and the perpendicular to the surface are in one plane. It is easily seen that the index of refraction is the ratio of the velocities of the waves in the two media, V_1 and V_2 ; viz., $\frac{\sin \alpha_1}{\sin \alpha_2} = \frac{V_1}{V_2}$.

Therefore this ratio, which is called the 'index of refraction,' is different for different media; and for any one case it varies with the wave-number if there is dispersion (q.v.). Refraction is illustrated in aerial waves by the effect on them of heated columns of air; and in the case of ether-waves by the action of prisms, etc. Certain crystals and strained isotropic bodies exhibit 'double refraction,' that is, if a ray of light falls upon them there are two refracted rays. See LIGHT.

REFRACTION, ASTRONOMICAL. The effect of refraction in the appearance of the heavenly bodies is to make them appear higher in the sky. Thus refraction increases the altitude, but it does not alter the azimuth. In the figure S is the true position of the star, and S' the apparent. The refraction is greatest at the horizon, where it is about 37'. This is evident since the angle of incidence is here the greatest. From the horizon to the zenith the refraction constantly decreases, very rapidly near the horizon and more slowly at greater elevations. It varies approxi-

mately as the tangent of the zenith distance down to a zenith distance of about 70° , and is entirely independent of the distance.

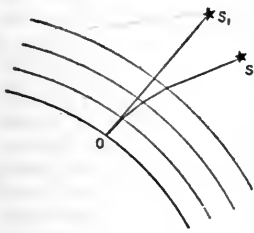

The effect of refraction upon the rising and setting of the heavenly bodies is to make them appear to rise earlier and set later than they would if there were no atmosphere. The horizontal refraction varies from $35'$ to $39'$.

Therefore when we see the sun's lower limb rising the whole disk is really below the horizon. In this way the refraction accelerates the sunrise in our latitudes from 2 to 4 minutes. At sunset the sun is delayed an equal amount. Thus the total effect of refraction is to increase the length of the day at the expense of the night from 4 to 8 minutes, according to the inclination of the sun's diurnal circle to the horizon.

Refraction also explains the elliptic appearance of the sun's and moon's disks when near the horizon. Owing to the rapid increase in the amount of refraction near the horizon, the lower limb appears more elevated than the upper, thus shortening the vertical diameter.

Another effect of refraction when the air is much disturbed is to make the stars 'dance,' especially when seen through a large telescope with high power. This is due to the constant displacement of the image by the varying refraction.

REFRIGERANTS (from Lat. *refrigerans*, pres. part. of *refrigerare*, to cool again, from *re-*, back again, anew + *frigerare*, to cool, from *frigus*, Gk. *ψῑγος*, *rhigos*, cold). A name given to a class of medicines which reduce the temperature of fevers, allay thirst, and cause a feeling of coolness and refreshment throughout the system. They lessen the force of the circulation by quieting the over-excited heart, and excite perspiration and an increased urinary flow. Most of these remedies belong to the class of the vegetable acids and their salts, but aconite and similar drugs, which act primarily on the circulation, may also be considered refrigerants. The vegetable acids used are tartaric, citric, acetic, and oxalic. Citric acid is most useful in the form of lemonade or orange juice; acetic acid in the form of vinegar. Oxalic acid is a dangerous drug and is only given in very dilute solutions and in very small doses. The *diaphoretic* refrigerants (those which excite perspiration) are aconite, veratrum viride, and potassium citrate. The latter is a favorite ingredient of fever mixtures. The *diuretic* refrigerants (those which stimulate the urinary flow) are the bicarbonate, citrate, acetate, bitartrate (cream of tartar), sulphate, chlorate, and nitrate of potassium. The latter is active particularly in the form of the ethereal spirits popularly known as 'sweet spirits of nitre.'

REFRIGERATING MACHINES. See REFRIGERATION.

REFRIGERATION (Lat. *refrigeratio*, from *refrigerare*, to cool again). The art of producing cold by artificial means. It has been practiced since very ancient times, but it is only in com-

paratively recent times that improved systems and apparatus have enabled such operations to be conducted profitably and on a commercial scale. Mechanical refrigeration is now employed in the manufacture of artificial ice; for the freezing and chilling of freshly killed meat in slaughter houses; for the cooling of stores for meat, fish, fowl, fruits, vegetables, and other perishable provisions; for cooling the atmosphere of dwellings and hospitals; for certain engineering operations; and for a variety of manufacturing processes. The number and variety of refrigerating devices available for these purposes are very great, but they all belong to one or the other of the following five classes: (1) Devices in which the more or less rapid liquefaction of a solid is utilized to abstract heat; (2) devices by which the abstraction of heat is effected by the evaporation of a portion of the liquid to be cooled; (3) devices in which the abstraction of heat is effected by the evaporation of a separate refrigerating agent of a more or less volatile nature, which agent is subsequently returned to its original condition by mechanical compression and cooling; (4) devices by which the abstraction of heat is effected by the evaporation of a separate refrigerating agent of more or less volatile nature under the direct action of heat, which agent again enters into solution with a liquid; (5) devices in which air or other gas is first compressed, then cooled, and afterwards permitted to expand while doing work. These five processes of refrigeration are termed, respectively, the liquefaction process, the vacuum process, the compression process, the absorption process, and the cold-air process.

LIQUEFACTION PROCESS. Liquefaction is one of the most ancient methods employed for artificial cooling. The reduction of the temperature of water by the melting of saltpetre is said to have been known in India at a very remote period. The Romans are said to have cooled wine by immersing the bottle containing it in a second vessel filled with cold water, into which saltpetre was gradually thrown, while at the same time the bottle was rapidly rotated. Freezing water by the use of a mixture of snow or powdered ice and saltpetre was mentioned by Latinus Tancredus in 1607, and wine by means of snow and common salt by Santorio in 1626. The best among the many forms of apparatus for making ice on this principle are probably those of Toselli and Siemens. In Toselli's machine the frigorific agent employed is a mixture of ammonium nitrate and water, which produces a reduction of temperature of about 40° F. The apparatus consists of a vessel in which the solution of the ammonium nitrate is effected, and of a can wherein are placed a number of circular molds of different sizes. These molds previously filled with water are inserted in the freezing mixture and a thin film of ice is formed round their edges; these tapered tubes of ice are then withdrawn from the molds and placed one inside the other, thus forming a small stick of ice. In Siemens's apparatus the frigorific agent is calcium chloride, whose dissolution in water produces a reduction of temperature of only 30° F., and to admit of this reduction being sufficient to produce ice with water at an initial temperature of 65° F., a heat interchanger is provided in which the spent liquor, which is at a temperature of about 30° F., is employed to cool the water

before it is mixed with the salt. The Siemens apparatus has been used in making artificial ice with much success, but, being less economical than more modern ice-machines, has never come into general use. When these devices or others of the same type are used for cooling purposes brine is cooled in them and then circulated in the usual manner through a system of circulating pipes. The general law governing the production of cold by frigerific mixtures is that during the liquefaction of a solid a certain amount of heat not indicated by or sensible to the thermometer is absorbed, which heat is abstracted from any surrounding bodies. The absorption of heat from the surrounding bodies is the greater the more rapidly the solid is liquefied.

VACUUM PROCESS. The cooling of liquids on this principle depends upon the conversion of the sensible heat into latent heat (see HEAT) during evaporation, and has been practiced in all ages. A primitive example of this process in its crudest form is the practice in India and other warm countries of placing earthen vessels of water in a natural or artificial draught so that the liquid may be cooled by surface evaporation. The first machine for the production of ice by the vacuum process appears to have been invented in 1755 by Dr. Cullen, who in that year made the discovery that the evaporation of water could be facilitated by the removal of the atmospheric pressure by means of an air pump, to such a degree as to enable him to freeze water even in summer. This apparatus was the parent of all those subsequently designed, but seems not to have been a commercial success. In 1777 Nairne found that by the introduction of sulphuric acid into the receiver for the exhaust the aqueous vapor could be absorbed from the rarefied air and the latter dried, thus preventing the formation of a permanent atmosphere over the water and hindering the continuity of the evaporation. Nairne was followed by other inventors, but it was not until the second quarter of the nineteenth century that Edmund Carré invented a commercially successful machine adapted to produce the *carafes frappes* commonly used in Parisian cafés and restaurants. This machine consisted of a cylindrical vessel intended to contain the charge of concentrated sulphuric acid, of an air pump so arranged that it could be connected to the mouth of the carafe, and of an agitator coupled to the air-pump lever for the purpose of keeping the sulphuric acid in motion. The Carré machine proved most successful for its purpose, and improved forms of the device are still manufactured, the largest of which are capable of producing 80 pounds of ice per day. In 1878 Franz Windhausen patented a vacuum machine, an improved form of which was installed in 1881 at the Aylesbury Dairy, London, England. This machine was nominally capable of producing from 12 to 15 tons of ice per 24 hours. The ice-forming vessels in this machine were six in number, circular in transverse section and slightly tapered. The mouths of these vessels were connected with the sulphuric-acid chamber and the vacuum pump, and water was admitted to them in fine streams, which offered extended surfaces for evaporation and almost instantly congealed into ice globules which fell to the bottoms of the molds and there froze together. To facilitate the release of the ice from the molds, they were surrounded with hollow

jackets into which steam could be forced until the ice was melted loose. Various other forms of vacuum machines have been devised, but the two described are typical examples and explain the process sufficiently. Like the liquefaction process, the vacuum process cannot compete in economy with the more strictly mechanical processes, and vacuum machines are now used only for domestic ice-making and similar small installations.

COMPRESSION PROCESS. The system of absorbing heat and thus producing cold partly by vaporization and subsequent liquefaction, and partly by compression and cooling, is in accordance with the well-known law of physics that all substances during the process of passing from a liquid to a gaseous state are bound to absorb a certain amount of heat, and while returning from a gaseous to a liquid state to give up or throw off the same amount of heat. Whatever the refrigerating or heat-absorbing agent that may be used, the following cycle of operations is obligatory in all machines working upon this principle: (1) Compression, that is the refrigerating agent in gaseous form is subjected to a pressure sufficient to reduce it to a liquid form, this pressure varying with the nature of the agent and the temperature of the condensing water. During this compression a degree of heat is developed in accordance with the amount of pressure to which the gas is subjected or to the volume to which it has to be reduced relatively to that of the gas in order to produce liquefaction. (2) Condensation, during which process the heat developed during the compression of the gas is carried away by forcing the latter through water-cooled pipes, the heat being transferred to the cooling water. At this point the gas is ready to assume the liquid form, in doing which an additional amount of heat is given off to the water. (3) Expansion, during which the liquefied gas is admitted to series of coils of pipe, and being suddenly relieved of pressure, instantly flushes or expands into gaseous form, in doing which, according to the above mentioned law of physics, it is forced to take a quantity of heat which it

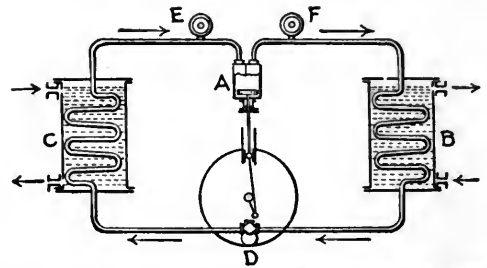

FIG. 1. DIAGRAM ILLUSTRATING THE OPERATION OF A REFRIGERATING MACHINE ON THE COMPRESSION PRINCIPLE.

draws from the surrounding objects, first, of course, the pipes wherein it is confined, and second, such substances as may be in contact with the pipes and which it is desired to cool, as air, water, and brine. The amount of heat thus abstracted or absorbed is equal to that previously given up to the cooling water in the condenser. This cycle of compression, condensation, and expansion having been completed, the refrigerating agent is in its first state again and is ready for another cycle. The three operations described being essential, all machines operating according

cylinder, and the cycle of operations just described is again performed. Following now the course of the sealing and cooling oil, which, as previously mentioned, is heated with the gas during compression, this oil is passed from the compression cylinder mingled with ammonia gas into the pressure tank, where most of it separates from the gas and falls to the tank bottom. The heated oil is then conducted through a pipe to the lowermost pipe of the oil cooler, which is similar in construction and operation to the ammonia condenser. After being sufficiently reduced in temperature in the oil cooler the oil flows through the strainer into the oil pump, which is so constructed that it delivers the cooled oil into the compression cylinder, distributing it to either side of the piston or plunger during its compression stroke when it is being compressed and heated. From the compression cylinder the oil proceeds again through the cycle just described. Most of the oil separates from the ammonia gas in the tank, but any small amount that passes on is taken out when it reaches the separating tank. The three salient parts of the apparatus described are the compressor, the condenser, and the expansion coil.

There are numerous compressors of other makes, all of which differ structurally from the De La Vergne and from each other. Condensers

as will give a large amount of radiating surface. Their arrangement depends upon the purpose for which refrigeration is to be employed, whether for cold storage or ice-making or other purposes. Systems of refrigeration which use other refrigerating agents than ammonia differ from the ammonia system chiefly in the character and construction of the compressor. They all have the same cycle of operations—namely, compression, condensation, and expansion—which is constantly repeated. The advantages and disadvantages of ammonia and of the other cooling agents used in refrigeration by the compression system may be briefly summarized as follows: The chief advantages of anhydrous ammonia (see AMMONIA) are its possession of greater heat-absorbing power than that of any of the others, that it liquefies at a comparatively low temperature, and that it is not as explosive nor as inflammable as ether. The advantage of ether as a refrigerating agent is that it liquefies at low pressure and comparatively high temperature, which adapts it for hot climates. Its disadvantages are that an ether compressor is about seventeen times as large as an ammonia compressor of the same capacity, and that ether is a highly inflammable and explosive gas when mixed with air. The advantage of sulphuric acid or sulphur dioxide is that it liquefies at a low pressure—not so low as ether, but considerably lower than ammonia. Its chief disadvantage is that it is liable to form sulphuric acid on exposure to air, which acid rapidly destroys iron. Carbon dioxide has the advantages of being non-inflammable and having a high specific gravity, which renders its heat of vaporization for a given volume much higher than that of ammonia; it also has no corrosive action on copper. Its disadvantages are the high pressure required to liquefy it and its fatality to animal life when present in air in any quantity.

ABSORPTION PROCESS. The absorption process of refrigeration was invented by Ferdinand Carré about the year 1850. It is founded upon the fact of the great capacity possessed by water for absorbing a number of vapors having no boiling points, and of their being readily separable therefrom again by heating the combined liquid, hence it is commonly known as the absorption process. The process involves the continuous distillation of ammoniacal liquor and requires the use of three distinct sets of apparatus: (1) A set for distilling, condensing, and liquefying the ammonia; (2) a set for producing cold by means of a refrigerator and absorber, a condenser, a concentrator, and a rectifier; and (3) a pumping plant for forcing the liquor from the condenser into the generator for redistillation. The three operations are each distinct from the other, but when the plant is actually working they must be continuous and are dependent upon one another, forming separate stages of a closed cycle of operations. An advantage of the absorption process is that the bulk of the heat required for performing the work is applied direct without being transformed into mechanical power. The first machines constructed on this principle were, however, very imperfect in operation, by reason of the impossibility of securing an anhydrous product of distillation. This was owing to the distillation, which is the most important operation and has of necessity to be executed in a rapid manner, being, in the first machines, very imperfectly

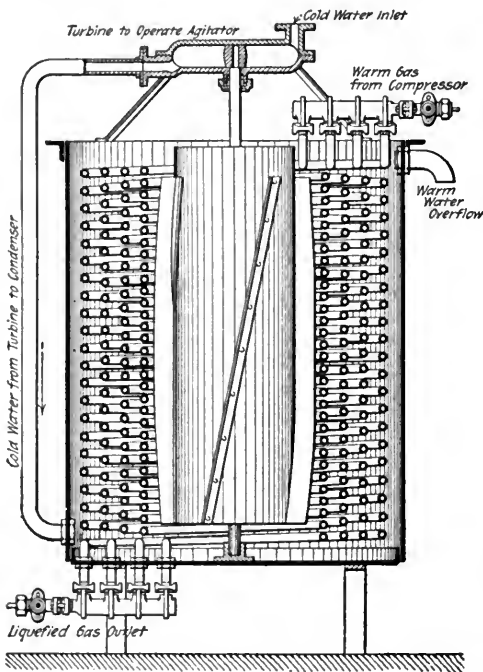

FIG. 3. DIAGRAM SECTION OF CONDENSER FOR LIQUEFYING AMMONIA GAS IN COMPRESSION SYSTEM.

are of two general types, surface condensers and submerged condensers. In submerged condensers the pipe coils are submerged in the cooling water, and Fig. 3 shows a vertical section of such a construction. In surface condensers the cooling water is simply allowed to trickle from above onto the pipe coils, whence it falls into a basin and is conducted away. The condensers shown in Fig. 2 are of the surface type. Expansion coils are simply coils of pipe of such section

effected, and the liquor resulting therefrom being naturally much diluted with water. Another serious result of the above defect was the accumulation of weak liquor in the refrigerator and the consequent necessity for constant additions of ammonia. By subsequent improvements, however, made by Reece in 1867-70, by Mort in 1870, by Stanley in 1875, and by F. Carré in 1876, by Beck in 1886, and by Mackay and Christiansen, Tomkins, and Pontifax in 1887, the distillate has been rendered nearly anhydrous and the absorption machines have been brought to a very considerable degree of efficiency. The number of absorption machines which have been invented is large, and they can be described in detail only in special

but the same general process is followed by all machines.

COLD-AIR PROCESS. The cold-air process of refrigeration is based on the principle that the compression of air or other gas generates heat and the subsequent expansion thereof generates cold, and cold-air machines operate by first compressing air in a cylinder, passing it under pressure through cooler, and finally allowing it to expand again in an expansion cylinder. The advantage of cold-air machines are that no chemicals of any description are required, that very low temperatures can be obtained rapidly by their use, that their construction is comparatively simple and their application is easy, and that the en-

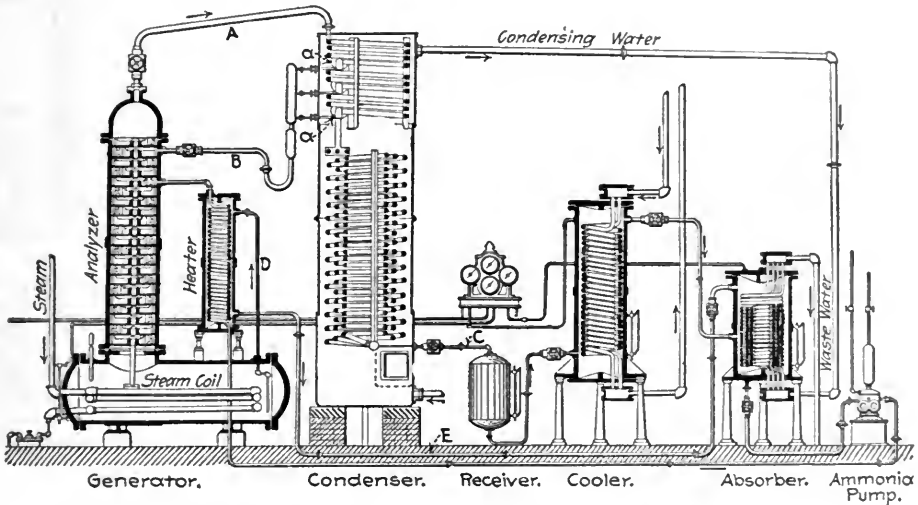

FIG. 4. DIAGRAM SECTION OF REFRIGERATING PLANT IN AMMONIA ABSORPTION SYSTEM.

treatises. For a general explanation of the absorption process the installation shown by Fig. 4 has been selected. Following first the course of the ammonia gas, we start with the generator and analyzer, which are filled with aqua-ammonia. This liquor is treated by the steam coil in the generator and the ammonia evaporates, the gas passing through the pipe A to the condenser, which is a cylindrical vessel containing a coil of pipe and filled with water. The upper coils of the condenser pipe are provided with drips, *a a*, in which the water vapor which is mingled with the ammonia gas is condensed and led back to the generator by the pipe B. The ammonia gas is cooled while passing down the condenser coil and finally liquefies at the bottom and runs through the pipe C into the receiver. From the receiver the liquid ammonia is led into the cooler, where it changes into gas and abstracts heat from the coil of brine pipe. The gas then passes to the absorber, where it meets the weak ammonia solution from the generator and is reabsorbed. The liquor is then pumped from the absorber back into the generator, where it is again heated. When the liquor in the generator is released of its ammonia it passes by the pipe D into the heater, and thence by the pipe E into the absorber, where it meets the ammonia gas from the cooler and reabsorbs it. The cooling or refrigerating is done by the brine which circulates through the cooler. The foregoing description applies in detail only to one make of machine,

the machine is situated externally to the chamber or store being cooled and is consequently accessible at all times. The invention of the cold-air machine is ascribed to Gorrie, who is said to have designed the first machine of this class in 1849, and improvements were made by Alexander Kirk in 1863, by Giffard in 1873, and by Windhausen, Bell-Coleman, and several others. By these successive improvements the trouble from moisture and freezing had with the early machines been largely overcome, and the present cold-air machine is a valuable and efficient device, particularly for small installations.

The purposes to which mechanical refrigeration is applied are, as already stated, numerous. It is possible to group them, however, under a few general heads, and for the present occasion the following heads are selected: Cold storage, ice-making, marine refrigeration, and manufacturing.

COLD STORAGE. Cold storage includes practically all applications of refrigeration to the preservation of foodstuffs. A cold-storage plant comprises a refrigerating plant of one of the forms previously described and a store which is kept cold by the refrigerating plant and in which all the provisions to be preserved are placed. Cold stores vary in size from the single-room store used by the hotels, larger residences, butcher shops, etc., to large buildings containing numerous rooms for the storage of all kinds of provisions.

The size of the refrigerating plant varies, of course, with the size of the store which it has to keep cold. The refrigerating processes most used for cooling stores are the cold-air, the compression, and the absorption processes. When the cold-air process is employed the air is as a rule admitted to the store, and after it has done its duty is conducted back to the compressor for recompression. When compression or absorption systems are used the refrigeration is effected in one of three ways: (1) By cooling a non-congealable brine and then pumping it through a system of pipes in the store; (2) by causing a current of air generated by means of a fan or otherwise to impinge against surfaces reduced to a low temperature by the expansion of the refrigerating agent itself; (3) by expanding the gas direct through pipes placed in the chambers. The agent employed in the *brine circulating system* consists of a solution of chloride of sodium (common salt), chloride of calcium, or chloride of magnesium, or any other suitable solution capable of standing very low temperatures without congealing. To extract the heat from the brine the method most commonly employed consists in passing it through a tank fitted with suitable coils of pipes through which the chilled liquefied ether, carbonic acid, ammonia, or other agent expands and forms gas. The cooled brine from this tank is then pumped through a system of circulating pipes in the refrigerating chamber. In the *direct expansion system* the pipes in which the ether, carbonic acid, or ammonia expands and makes gas are located directly in the refrigerating chamber. In the *cold-air blast system*, the expansion coils are placed in a separate chamber and the cold air from that chamber is blown by fans into the refrigerating chamber, sometimes being washed by passing through a shower of cold brine and then dried by passing through a mass of calcium chloride or other hygroscopic material.

The construction of refrigerating chambers varies with their purpose and the arrangement of piping adopted, but they are always tightly closed rooms with thick walls carefully insulated to prevent escape of cold and entrance of heat. Speaking generally, cold-storage rooms or chambers are maintained at a temperature of about 34° F., chilling rooms at about 30° F., and freezing rooms at anything from 0° F. to 10° F. The proper methods of storing and the temperatures for the cold storage of various articles, as meats, fish, butter, cheese, milk, eggs, fruits, and vegetables, are intricate problems, which different authorities solve in different ways; their full discussion can be attempted only in special treatises.

MARINE REFRIGERATION. Marine refrigeration embraces generally the operation of cold stores and ice-making plants on shipboard. These are merely modifications of the plants used on land to adapt them to the special conditions which prevail on shipboard. These conditions are chiefly limited space and the necessity of using a refrigerating agent which is not deleterious to persons or property. To meet the last condition, cold-air and carbonic-acid machines offer advantages which have caused them to be very largely adopted. Fig. 4 shows a carbonic-acid compression machine designed for use on shipboard. The main point to be noted is the compactness of the arrangement. Fig. 5 is a plan of a cold-storage room on a large passenger steamer. The following

is a description of the refrigerating rooms on the steamers *Campania* and *Lucania* which are fitted to carry cargoes of meat: The cargo holds of the steamships *Campania* and *Lucania* are refrigerated with machines of the Kilbourn type. The meat-carrying chambers in each of these vessels

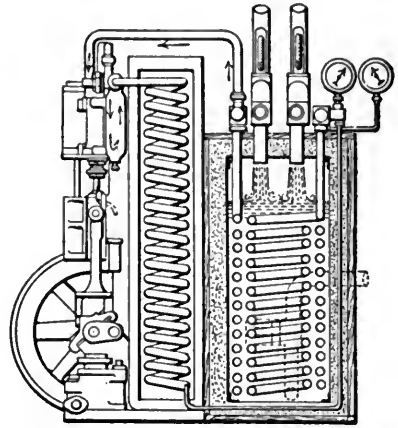

FIG. 4. MARINE TYPE OF CARBONIC-ACID COMPRESSION REFRIGERATING MACHINE.

consist of three chambers situated forward on the orlop or lower deck, and having a total capacity of 20,000 cubic feet, which renders them able to carry 2700 quarters of beef. The chambers are very carefully insulated, the walls consisting, first, of a double thickness of tongued and grooved boards having a layer of waterproof paper between them; next, a two-inch

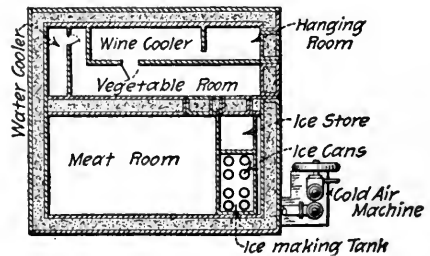

FIG. 5. ARRANGEMENT OF REFRIGERATING PLANT ON LARGE PASSENGER STEAMER.

layer of good quality hair felt and another double thickness of tongued and grooved boards, with a similar layer of paper between them; and finally an inch air space, between the latter and the inner or iron deck, the whole being well varnished. The brine-cooling pipes, which are of heavy two-inch galvanized tube with malleable cast return bends, are placed on the ceiling between the deck-beams, thus economizing head room, and the rails for the meat-hooks are 1½-inch galvanized round iron, firmly clipped to the beams supporting the decks. The meat-hooks which are placed upon the latter, for carrying the quarters of beef, are of steel galvanized. Thermometer tubes from the upper deck are provided to each chamber, so that the temperature may be ascertained in any part of the chamber when desired.

ICE-MAKING. One of the most important applications of refrigeration is the manufacture of artificial ice. There are several methods of ice

manufacture practiced commercially, and each of these will be briefly described, and, afterwards, a more detailed description will be presented of one of the most popular ammonia compression can systems employed in America. The great difficulty in manufacturing artificial ice is that of producing a clear, transparent material, for, unless special provisions are made to get rid of it, the air in the water fails to escape, because of the rapid freezing, and an opaque ice containing air bubbles and of inferior keeping qualities is produced. Five methods may be employed for preventing this opacity and forming clear crystal ice: (1) Freezing the water slowly at comparatively high temperatures; (2) agitating the water in cans, molds, or cases during the process of freezing so as to admit of the escape of the imprisoned air; (3) forming thin slabs of ice on what is known as the wall or plate system; (4) freezing the water in shallow stationary cells; and (5) de-aërating the water before placing it in the molds or cells. Freezing the water slowly at comparatively high temperatures is simply an imitation of the natural process, the water being exposed in well-insulated rooms to an atmosphere cooled below freezing point. The process is too slow to be successful commercially. In the can system, which is one of the most popular, metal cans are set in a tank containing chilled brine and these cans are filled with the water to be frozen. Extending down into these cans is a bar or rod of wood which is given a swinging motion by suitable mechanism,

boiling, or frozen in a vacuum, or distilled. The vacuum system is but little used. In the other systems the evaporated or distilled water is frozen either by the can system or plate system.

Turning now to a specific example of ice-making, Fig. 6 shows a plant for making ice on the ammonia compressor can system: The ammonia compressor plant has already been described in a preceding section and will be neglected here. To follow now the water from the well to the loading platform, where it is delivered as ice, we begin with the well-water pump in the boiler house. Water from this pump splits into two currents, one of which rises to the top of the building, and discharges into the water-storage tank. This water, as shown by the pipes leading from the tank, flows over the gas and oil cooler and also over the ammonia condenser. From the pans, or cemented floor, on which these stand it flows

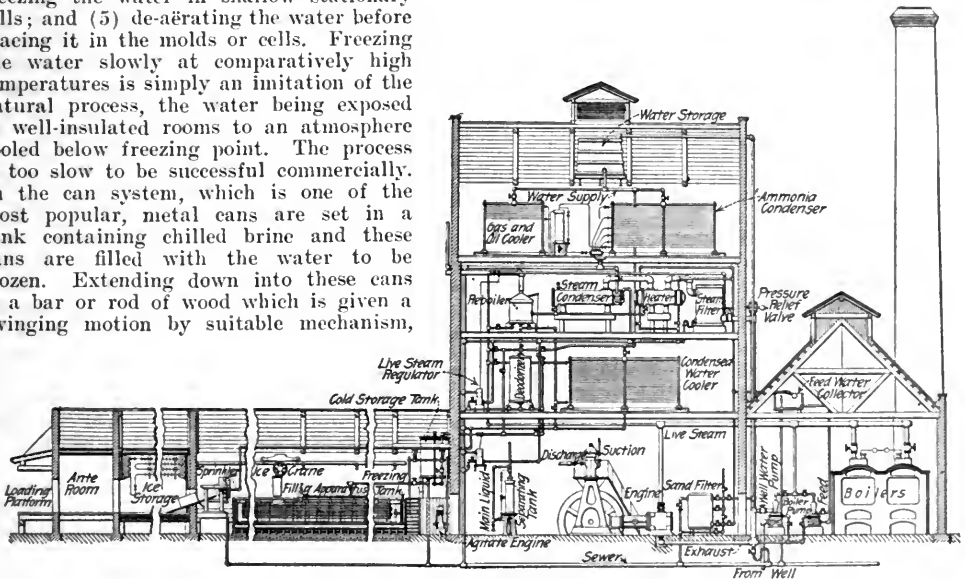

FIG. 6. SECTIONAL DIAGRAM OF ARTIFICIAL ICE-MAKING PLANT; DE LA VERGNE SYSTEM.

thus agitating the water, and facilitating the escape of the contained air. In the plate or wall system the water to be frozen is placed in a large refrigerator tank which is divided into compartments by a series of parallel hollow partitions. In these hollow partitions brine is circulated, causing a sheet or plate of ice to freeze to both sides of each. When these ice plates have frozen to a thickness of 8 to 12 inches, the cold brine is drained from the partitions and replaced by warm brine, which causes the plates to melt loose, after which they are lifted from the tanks and sawed into blocks. The standard size of plate in the United States is 8 × 16 feet × 11 inches. As in the can system, agitators are employed to expel the air from the water during freezing. In the stationary cell system a tank, as in the plate system, is divided by both transverse and longitudinal hollow partitions, so that the ice is frozen in rectangular blocks instead of in long flat plates. The methods of freezing and freeing the ice and of agitating the water are the same as in the plate system. In the de-aërating system the water to be frozen is either evaporated by

to the floor below, where it enters the steam condenser. After traversing the condenser it passes through the next floor, runs along the ceiling, and empties into the vertical standpipe (seen to the extreme left) connecting with the sewer. Water from the water storage also flows by a pipe (hidden by the ammonia condenser) to the condensed-water cooler, from the base of which it passes through the floor, runs along the ceiling of the first floor, and empties into the sewer standpipe. This disposes of one current from the well-water pump; the other passes through the sand filter, whence it rises to the third floor and passes through the heater. From this heater it again descends to the feed-water collector in the boiler house, whence it is drawn off by the boiler-feed pump, and by it sent into the boilers. It leaves the boilers in the form of live steam. The pipe conveying this live steam has branches supplying the engine, the well-water pump, the boiler-feed pump, and is continued along the ceiling of the first floor, rising to the third floor, where it is connected with the reboiler and also the steam filter. The purpose of its connection with the

reboiler is apparent; the connection with the steam filter is utilized to automatically supply a small quantity of live steam to make up for any deficiency in exhaust steam. Other connections of the live-steam pipe to the various apparatus are shown, which are used for cleaning out. The exhaust steam from the engine, and also for the two water pumps, passes beneath the first floor and rises through the boiler-room and outside the main building to the third floor. Before it enters this it has a chance to escape through the pressure release valve if for any reason the various apparatus through which it passes should cause sufficient back pressure to impair the proper working of the engine. The exhaust steam passes first into the steam filter, thence into the heater, where it heats the water which as we have already seen passes through this same heater on its way to the boiler. From the heater it passes to the condenser, thence to the reboiler. From this it goes through the condensed-water cooler to the deodorizer on its way to the cold-storage tank. From the cold-storage tank water is fed by a hose in any can whose place may be rendered vacant by the withdrawal of a can of ice. There we must leave the now thoroughly purified and distilled water in repose for some sixty hours. After this interval of time the can is lifted by the ice crane suspended from the carriage on which it is run down the tank-room to the sprinkler. In the sprinkler the can receives a shower bath of warm water and the ice when loosened drops out of itself and glides into the ice-storage room, the sprinkler in the meantime automatically putting itself into position to receive another can, thereby shutting off the supply of warm water. The cake of transparent ice is allowed to remain in the ice-storage room until the time for the wagons to appear at the loading-platform approaches, when it and as many of its fellow blocks as are required are withdrawn into the anteroom. A block of ice may pass straight through the ice-storage room and the anteroom to the loading platform, or it may remain a week or two in the storage. This ice-storage room is seen to be supplied with refrigerating pipes, so that if the demand is fluctuating the blocks will be preserved intact, only so much being withdrawn into the anteroom as is necessary for immediate use. The following table shows the structural sizes and weights of blocks made by the can system:

WEIGHT OF BLOCKS	Size of can, inches	Time of freezing
50 pounds.....	6 X 12 X 26	20 hours
100 "	8 X 16 X 32	36 "
150 "	8 X 16 X 42	36 "
200 "	11 X 22 X 32	60 "
300 "	11 X 22 X 44	60 "
400 "	11 X 22 X 57	60 "

The time of freezing is with 18° F. brine.

MANUFACTURING. In general it may be said that refrigeration is applied to all processes of manufacturing where it is desirable or necessary to have at some period a temperature below the normal atmospheric temperature. Some of these processes are brewing, chocolate-making, dynamite manufacture, india-rubber manufacture, sugar-making, and chemical-making. The method of application varies with the process, but it is in general simply a modification of refrigerating processes as applied to cold storage and ice-mak-

ing. There are numerous books on refrigeration, but the general reader will find the subject amply treated in Wallis-Taylor's *Refrigeration, Cold Storage, and Ice-Making* (New York, 1903). See LIQUEFACTION OF GASES.

REFRIGERATION OF THE EARTH.

That the earth is radiating more heat into space than it receives is evidenced by the fact that the temperature rises as the crust of the earth is penetrated. The flow of heat is always from a higher to a lower temperature, and consequently there is a constant conduction of heat from the interior to the surface of the earth, and a loss into space. The rate of flow of heat is dependent upon the conductivity of the material and the rate of rise in temperature. A substance is said to have the unit of heat conductivity when it will conduct the unit of heat the unit of distance in the unit of time through the unit cross-section, the temperature rising one degree for the unit length. In the present system unit conductivity corresponds to the transfer of enough heat to raise one pound of water one degree Fahrenheit in one second through a bar of one square foot cross-section when the temperature falls one degree for one foot in the direction of flow. Determinations of the increase in temperature as the earth's crust is penetrated show that there is a marked variation from one locality to another, this variation depending upon the character of the rocks penetrated, the amount of disturbance they have undergone, and other local conditions. In the well at Wheeling, W. Va., which has a depth of 4,500 feet, the rise in temperature has been found to be 1° F. for each 75 feet of descent; in the well at Sperenberg, Prussia (depth 4,170 feet), the increase is 1° for 59 feet; and in the Schladabach well, near Leipzig (depth 5,740 feet), the increase is 1° for 65 feet. At other localities the rate varies from 15 to 200 feet for 1° F.

Various causes have been suggested for this interior heat of the earth, but considering all the related astronomical and physical considerations it is most probable that it is a remnant of the original nebular heat which has not yet been dissipated, and which has been prolonged by the results of the condensation from the nebulous state. Under the phrase 'age of the earth' is usually understood the time since the earth became practically solid and the present method of cooling by conduction commenced. From data as to the conductivity of the rock materials and the rise in temperature it is possible to make certain estimates as to the age of the earth, and the latest and perhaps best is that by King, who, after an exhaustive discussion, concludes that it is about twenty-four million years and that the temperature at the time when convection ceased was about 2000° C. (3600° F.). The amount of heat reaching the earth's surface from the interior in a year is sufficient to melt a layer of ice about one and a quarter inches thick, that is about one-thousandth of the amount reaching the earth from the sun. Consult article by King, in *American Journal of Science* (New Haven, 1893).

REFUGE, CITY OF. See CITY OF REFUGE.

REFUNDERS. See READJUSTERS.

REFUNDING (from *refund*, OF., Fr., *refondre*, to restore, pay back, remodel, from Lat. *re-*

fundere, to pour back, restore, from *re-*, back, again, anew + *fundere*, to pour). A financial operation by which a government or corporation changes the terms of an existing debt. In public finance the term is used synonymously with conversion. A government may refund its debts to secure better terms either with respect to rate of interest or with respect to time of payment of principal. Public debts are usually created at a time when public credit is low; accordingly a high rate of interest must be offered to tempt investors. With the restoration of credit, it becomes possible for the government to borrow money at a lower rate of interest; and if the terms of its original debt permit, it is good financial policy to pay off that debt with money borrowed at the lower rate. In practice, the holders of the old obligations usually exchange them for the new, so that a refunding operation changes neither the principal of the debt nor the creditors to whom it is due; although technically a new debt has taken the place of the old one.

Quite apart from improvements in public credit, the rate of interest at which a government can borrow money tends constantly to decline, owing to the general fall in the rate of interest. Most modern governments are burdened with a more or less permanent debt; accordingly their recent history shows a series of refunding operations, resulting in a steady decline of interest on public debentures. The policy of refunding of debts, while justly popular, naturally meets with the hostility of public creditors, who have at times been powerful enough to influence the action of the government, as in France, 1878-1883, when the government could have replaced obligations bearing interest at over six per cent. by obligations bearing interest at less than four. The public obligations were largely in the hands of small holders, whose political influence deterred the ministry from undertaking the operation.

Refunding can take place advantageously only when government debentures are above par on the market. It is therefore bad policy for a government in need of funds to sell low-interest bonds below par, since such a policy prevents it from taking advantage of a fall in the rate of interest. See DEBT, PUBLIC; FINANCE; Subhead FINANCE under the articles UNITED STATES, GREAT BRITAIN, GERMANY, etc.

REFUSE DISPOSAL. See GARBAGE AND REFUSE DISPOSAL.

REGAL (OF., Oit. *regale*, Fr. *régale*, from Lat. *regalis*, regal, from *rex*, king). A small portable finger-organ in use in the sixteenth and seventeenth centuries, and perhaps earlier. The pipes rested on the air-chest, which was filled by the bellows; the bellows were managed with one hand, and the keys with the other. The musical collection of Henry VIII. contained 13 regals. The name continued in use as late as 1770.

REGALBUTO, rā'gāl-bōō'tō. A town in Sicily, 26 miles west-northwest of Catania (Map: Italy, J 10). Salt and sulphur are mined, and there is a trade in cereals and wine. Population (commune), in 1901, 11,038.

REGALDI, rā'gāl'dē, GIUSEPPE (1809-83). An Italian poet, born at Novara. He studied law at Turin, but upon hearing Giustiniani, resolved to become like him, an *improvisatore*, and, from 1833 until 1836, traveled much

in that capacity, and with considerable success. His political opinions, expressed with fire and frankness, involved him in difficulties with the authorities of various Italian towns, and for a time he traveled in the East and in Greece. At the time of his death he was professor of history at the University of Bologna. His works include *La guerra* (1832), *Poesie estemporanee e pensate* (1839), *Canti* (1840), *Canti nazionali* (1841), *Canti e prose* (1861-65), and *Storia e letteratura* (1879), essays. Consult Orlando, *Giuseppe Regaldi* (1880).

REGALIA (ML., royal prerogatives), or REGALE, RIGHT OF. A right in ecclesiastical things, claimed by sovereigns in virtue of the royal prerogative, which has frequently been the subject of controversy between kings and popes. It involved several points as to presentation to benefices, most of which formed the object from time to time of negotiation by concordat; but the most serious conflict arose out of the claim made by the Crown to the revenues of vacant benefices, especially bishoprics, and the coordinate claim to keep the benefice or the see vacant for an indefinite period, in order to appropriate its revenue. (For the general history of the controversy, see INVESTITURE.) The specific term *Droit de régale*, however, recalls mainly the conflict in France between Louis XIV. and certain French bishops, notably those of Alet and Pamiers, who were supported by the Pope, Innocent XI. For a detailed history of this particular strife, consult: Phillips, *Das Regalienrecht in Frankreich* (Halle, 1873), Gérin, *Recherches historiques sur l'assemblée du clergé de France de 1682* (Paris, 1870).

REGARD'ANT (OF., looking). A term used in heraldry (q.v.) with reference to an animal whose head is turned backward.

REGEL, rā'gel, EDUARD VON (1815-92). A German-Russian botanist, born in Gotha, where he received his horticultural training. He was then employed in the botanical gardens of Bonn, Berlin, and Göttingen. In 1842 he became director of the botanical gardens in Zurich, and lecturer at the university there. In 1855 he was made director of the Imperial gardens in Saint Petersburg. He did much to promote culture of fruit in Russia. His numerous printed works on botany include *Flora Bonnensis* (1841), *Allgemeines Gartenbuch* (1855-58), *Descriptiones Plantarum Novarum in Regionibus Turkestanicis Collectarum* (1873-82), and *Aliorum Adhuc Cognitorum Monographia* (1877).

REGELATION (Lat. *regelatio*, a thawing, from *regelare*, to thaw, from *re-*, back again, anew + *gelare*, to freeze, from *gelu*, frost; connected with Lith. *geluma*, intense cold, Goth. *kalda*, OIIG. *kalt*, AS. *ceald*, Eng. *cold*). A term first applied by Faraday to describe the phenomena occurring when two pieces of ice are brought into contact under pressure. The ice melts at the plane of contact and the water thus formed freezes when the pressure is relieved, thus uniting the two pieces. That ice melts with pressure, and that its melting point is lowered as the pressure increases, was first shown by Professor James Thomson, and then demonstrated experimentally by his brother, Lord Kelvin, and this property serves to explain the phenomena involved in regelation. A wheel track in the snow

is generally covered with a thin film of ice for the reason that the snow melted by the pressure of the wheels freezes as soon as the pressure is removed. A snowball is made by the pressure of the hands causing the snow to melt, and then the water is solidified. Consequently if the snow is dry and cold and below the freezing point, the pressure of the hands will not suffice. If a press is used, the snow will be melted and cylindrical or other forms of transparent ice can be formed. The well-known experiment of looping a cord or wire around a block of ice and attaching a weight will also show regelation. Here the pressure on the cord melts the ice and allows the string to cut its way through the block, but at the same time the water thus formed is again frozen and the block left in its original solid condition. A union between two pieces of ice will take place when they are in contact under water, even if the temperature is considerably above that of the air. In such a case, however, the capillary action of the film of water between the two faces renders the internal pressure less than the external and acts to bring the two pieces together with pressure. The phenomenon of regelation is also quoted to explain the formation and movement of glaciers (q.v.). The glacier in its progressive movement acts much as a viscous solid, the top moving faster than the bottom and the middle faster than the sides. The pressure of the vast quantity of snow above melts the ice or snow at the bottom, and this, escaping and flowing down, freezes and solidifies, a gradual slipping away of the base occurring. As the foot of the glacier descends it reaches warmer regions, so that melting will take place with less pressure and the water will drain off. In this way it is possible to explain much of the formation and movement of glaciers, though of course the problem is very complex and other causes exert powerful influences. Consult Preston, *Theory of Heat* (New York, 1894). See HEAT.

REGENERATION (Lat. *regeneratio*, from *regenerare*, to generate anew, from *re-*, back again, anew + *generare*, to beget, from *genus*, family). Replacement of lost parts, renewal of organs, or completion of an organism from a part. In 1744 the Swiss naturalist Trembley found that on cutting hydras in two, or slicing them into thin rings, from each ring grew out a crown of tentacles; and in splitting them into longitudinal strips each portion became a well-shaped hydra. Finally he turned one inside out and in a few days the evaginated hydra swallowed pieces of meat, though its former stomach-lining had now become its skin. Bonnet found that from the same region of a worm, like the earthworm, a head or tail may arise according to whether that region happens to lie at the anterior or posterior end of the cut surface. Thus if a worm (*Lumbriculus*) be cut into two pieces, a new tail will develop from the posterior end of the anterior piece, and a new head from the front end of the posterior piece. In another species of fresh-water annelid Bonnet found that a new tail developed at the anterior end of the posterior piece, and not a head. As the result of recent experiments on the earthworm it is ascertained that if from one to five of the anterior segments be cut off, the same number come back; if more are cut off, the process of regeneration begins only after a longer interval, and only four or

five segments come back as a rule; if the cut be behind the middle, the time before regeneration begins is still longer, and fewer worms succeed in regenerating at all. Each end of the body can regenerate in its own direction only.

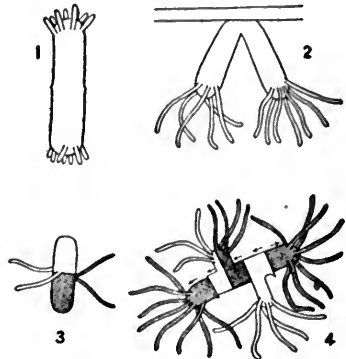

REGENERATION OF HYDRA.

1, Two anterior pieces of hydra united by their arboral ends; 2, hydra split in two, hanging vertically downward; 3, two posterior ends of hydra united by oral surfaces; 4, five pieces united as shown by arrows. (After Morgan.)

The effect produced by external factors in experiments on regeneration are noteworthy. A hydroid (*Eudendrium*) failed to develop new heads when kept in the dark, but when placed in the light the new heads quickly appeared, showing that light acts as a stimulus; and instead of a head a root will develop at the distal end of a piece if that end be brought into contact with some fixed object, and conversely a new head will appear at either the nearest or farthest end if the end be freely surrounded with water; in this case the external agent is the stimulus which determines the differentiation of the part; and experiments have produced some extremely curious manifestations of how this stimulus acts. For example, a piece cut from the stem of *Antenularia* and suspended vertically in the water will develop a new stem at the upper end, and roots at the lower end, regardless of the normal position. Here gravity alone determines that the upper end shall grow into a new stem and the lower end into a new root. In the one case, where the upper end corresponds to the proximal end of the original hydroid, the new part (a stem) replaces the lost root-end, and this change Loeb calls 'heteromorphosis.' In the other case, says Morgan, where the upper end corresponds to the distal end of the original hydroid, the new part (a stem) replaces the lost part of the stem. This is what is usually meant by 'regeneration.'

It is of some theoretical interest to know whether the old cells directly form the new tissue or whether reserve cells are present that bring about the result. From experiments thus far made Morgan thinks that this may vary with different forms. In *Planaria*, a flatworm, a new head forms on the anterior end of the posterior half of the worm, but the entire anterior half is never replaced by new tissue. In this same planarian Randolph has discovered a most important relation existing between the old and new parts. If a planarian be cut in two longitudinally in the median plane, the right half regenerates a new left half of the same size as the part removed, and the left half also develops a new right half

of corresponding size. If, however, the worm be cut longitudinally into a larger and smaller strip, the former replaces as much as was contained in the smaller part removed, but the smaller part does not develop the lost larger part, but forms only as much new tissue at its cut side as is about equivalent to its own breadth.

ANIMAL GRAFTING. Although this subject is not one of practical importance as regards animals, it is a matter of interest connected with the regeneration of the grafted parts, and in the case of the lower animals may lead, if portions of different species or genera are grafted upon each other, to results bearing on heredity. The first experiments in animal grafting are the famous experiments with the hydras by Trembley. He found that if a hydra is cut in two, the pieces can be reunited by their cut surfaces, the result being a complete animal. He also successfully united the head end of one hydra with the posterior half of another; but he failed to obtain a permanent union between individuals of different species. Lately Wetzel has cut two hydras in two and found that the two anterior pieces united by the aboral cut surfaces, so that each end bore a head with tentacles; he succeeded in a variety of similar experiments. King and others in the same way produced double-headed hydras, and wrought a number of variations on this theme. Lateral grafts were found to differ from lateral buds, the latter after four or five days separating by constricting at the base. Peebles succeeded in grafting in *Tubularia*, *Hydractinia*, etc. Joest has succeeded in grafting earthworms, producing double-headed and double-tailed specimens, also in splicing, making a long worm out of three separate pieces; he grafted or spliced together with such success worms of

graft, such as the muscles of the legs with those of the stock. 'Tandem' unions were more successful, a pupa deprived of the head and part of the thorax being joined to another deprived of its abdomen back of the fourth segment. The moths thus resulting had a long body with two sets of wings and legs, yet there was no internal fusion of organs, only the skin and appendages and wings sharing in the fusion. 'Twin' unions were produced by aboral and oral poles, also lateral 'twin' unions; these experiments were easily performed because only a little of each component was cut away.

The grafting of tadpoles by Born (1896-97) has excited much interest. If the anterior half of one tadpole was fused with the hinder half of the same or another tadpole, a single individual was formed which was kept alive in several cases until the time of metamorphosis. If the head of a tadpole is cut off and grafted upon the side of the body of another tadpole, the head will remain alive and continue to develop in its new position, and may grow to the size of that of the



GRAFTING A FROG.

A combination in which the anterior part of *Rana esculenta* was united to the posterior part of *Rana larvalis*. The blood of the posterior component was driven through the vessels by the action of the heart of the anterior component. The animal lived for 17 days. (After Morgan.)

stock. He succeeded in uniting tadpoles of different species in several different ways, i. e. by their heads, or by their ventral surfaces, or longer and shorter tadpoles were made by using pieces longer or shorter than a half. In all these cases there was no regeneration (says Morgan) at the place of union, and the internal organs, the digestive tract, nervous system, and blood-vessels unite when brought into contact. When like organs are brought together the substance of one unites directly with the substance of the other, and if the organ is a hollow one, as is the digestive tract or the nerve-cord, their cavities also become continuous. Born succeeded in grafting tadpoles even of different genera. It should be observed that in all these and other combinations each developing part retains its specific characters, "and although in several cases one part received its nourishment from the other through the common circulation, yet no influence of one component on the other could be observed." Morgan states that in the mammals it is impossible to carry out grafting experiments on the same scale as those described in lower forms. Thus we could not graft an arm of a man upon another. While the tissue might have the power to unite, the difficulty would be in supplying the grafted arm with nourishment, etc., during the long time required for the union to take place. Yet smaller parts of the body may be successfully grafted, and there are, he says, several recorded instances in which parts of a finger, or of the nose, are said to have been cut off and to have reunited after being quickly put back in place. As regards cases of grafting, Hunter and also Dubamel grafted the spur of a young cock upon the comb, where it continued to

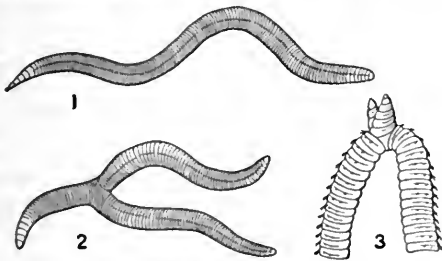

REGENERATION OF WORMS.

1. Union of two pieces of *Allobophora terrestris* in normal position 22 months after operation. Piece of *Lumbricus rubellus* grafted on side of body of another individual to produce a double-tailed worm. 3. Union of two worms (by anterior ends) from each of which eight anterior segments had been removed. (After Morgan.)

different species, and even of different genera (*Lumbricus rubellus* and *Allobophora terrestris*), though it was a more difficult undertaking; but the new worm "reacted as a single individual, and lived for eight months." As to more specialized animals, as insects and vertebrates, it appears that as in Crampton's experiments with grafting the pupae of silkmoths (*Philosamia Cynthia*, *Samia Cecropia*, etc.), like tissues of two components fuse with like, while unlike tissues become organically united by connective tissues. He grafted small pieces upon entire pupae, *Philosamia Cynthia* upon *Samia Cecropia*, *Callosamia Promethea* upon *Samia Cecropia*, but the fusion was entirely a superficial one, there being no internal connection between the organs of the

grow to its normal size. Other similar experiments have met with varying success.

TRANSPLANTATION OF SKIN. Cases of this sort of plastic surgery are becoming frequent. Morgan states that pieces of human skin may be without great difficulty grafted upon an exposed surface, "and it has been said that small pieces succeed better than large ones, owing, most probably, to their being able to absorb sufficient oxygen, etc., and keep alive until new blood-vessels have grown into the grafted piece." The skin of the negro has been transplanted upon a white man. In many cases the transplanted skin has remained alive for a time, yet later it was thrown off by new skin growing under it and replacing it. Even grafting of internal organs is now attempted with more or less success in operative surgery. The results of grafting bone, etc., show, adds Morgan, that all kinds of tissue may continue to live, and the cells multiply in different parts of the body, but there seems to be nothing in these cases comparable to a regeneration of the entire organ. In the new situation the cells often assume an entirely new arrangement. After a period of activity, a process of degeneration commences and the piece atrophies.

BIBLIOGRAPHY. Morgan, *Regeneration* (New York, 1901), contains a full bibliography; Crampton, "An Experimental Study upon Lepidoptera," in *Archiv für Entwicklungsmechanik der Organismen*, vol. ix. (1899).

REGENERATION. A term used in theology, to indicate either the entire spiritual change which passes upon men when they become Christians, or the divine agency in eliciting the act of faith in distinction from conversion, which is the part of man, and comprises repentance and faith. The words of Christ to Nicodemus, "Verily, verily, I say unto thee, except a man be born again, he cannot see the kingdom of God," are accepted as the expression of the universal necessity of regeneration by the Christian Church. In the view of the Roman Catholic and Eastern Churches, and of the High Church school among Anglicans, the change is inseparably connected with baptism, always in the case of infants, and of those adults who interpose no obstacle to divine grace. In this view baptism constitutes always a real point of transition from the natural to the spiritual life, so that every baptized person—or at least every rightly baptized person—has already become a Christian, although he may fall away from the grace that he has received. According to most Protestants regeneration (including conversion) is a special, conscious process, which takes place independently of baptism, or of any other outward fact or ceremony. It implies a sensible experience—an awakening whereby men come to see the evil of sin, and the divine displeasure against sin, and, through the Holy Spirit, are born again, put away their former evil life, and begin to live a new divine life. The controversy as to the meaning and method of regeneration was especially acute in the Anglican communion in the nineteenth century. The Gorham Judgment (see **GORHAM CONTROVERSY**) agitated the entire Church of England in the forties, and a protest against what were called sacramentarian views on this question led more than any other cause to the secession of the Reformed Episcopal Church in the United States.

REGENSBURG, rä'gëns-böörk, or Ratisbon. A city of Bavaria, Germany, capital of the Upper Palatinate, situated on the Danube opposite the mouth of the Regen, 65 miles northeast of Munich (Map: Germany, E 4). It is distinctly mediæval in appearance, with narrow, crooked streets, and ancient houses, with loop-holed towers and coats-of-arms. A stone bridge dating from the twelfth century connects Regensburg with the suburb of Stadthof on the opposite bank of the Danube. The cathedral, begun in 1275 and completed in 1534 with the exception of the towers, is pure German Gothic. It contains many fine monuments and other objects of art. The Rathaus, dating partly from the fifteenth century, is interesting as the seat of the Imperial Diet from 1663 to 1806. Another building of historical interest is the inn Zum Goldenen Kreuz where Charles V. lodged during the Diet of 1547 and where he met Barbara von Blomberg, the mother of Don John of Austria. The villa of the King of Bavaria is a magnificent building in the Gothic style, commanding a fine view of the surrounding country. There are a number of seminaries, and schools of religious music, glass-painting, and agriculture. Interesting collections are owned by the local historical and natural history societies. There are manufactures of paints, porcelain ware and pottery, machinery and other iron and steel products, knit goods and cloth, musical instruments, rifles, spirits, etc. Boat-building and book printing and binding are also industries of importance. Population, in 1900, 45,426, principally Roman Catholics. Near Regensburg is the German 'Temple of Fame,' called the Valhalla (q.v.).

Regensburg was the Celtic settlement of *Rad-asbona*, called by the Romans *Castra Regina*. It was the residence of the early dukes of Bavaria and became the seat of the bishopric of Regensburg in the eighth century. From the eleventh century to the close of the Middle Ages Regensburg was one of the most important cities of Southern Germany and carried on a flourishing trade with the East. It was early raised to the position of a free Imperial city. As the frequent residence of the German emperors Regensburg was the scene of many important diets, and became the permanent seat of the Diet in 1663. In the territorial changes following the Treaty of Lunéville in 1801, it was assigned to Dalberg (q.v.). In 1810 it passed to Bavaria. Consult: Gemeiner, *Chronik der Stadt und des Hochstifts Regensburg* (Regensburg, 1800-24); Gumpelzhaimer, *Regensburger Geschichte, Sagen und Merkwürdigkeiten* (ib., 1830-38); *Chroniken der deutschen Städte*, vol. xv. (Leipzig, 1878); Küsser, *Alt- und Jung-Regensburg* (Regensburg, 1895); Walderdorff, *Regensburg in seiner Vergangenheit und Gegenwart* (ib., 1896); Fink, *Regensburg in seiner Vorzeit und Gegenwart* (ib., 1900).

REGENT-BIRD. See **BOWER-BIRD**.

REGENT DIAMOND. See **PITT DIAMOND**.

REGENT'S PARK. One of the largest London parks, covering 472 acres, and containing the Zoölogical and Botanical gardens. It was laid out in the time of George III. on the site of the earlier Marylebone Park, once filled with game, subsequently cleared for a pasture, again replanted, and named for the Prince Regent (George IV.).

REGENT STREET. A noted London street, a mile in length, laid out in 1813 to connect Carlton House, the Prince Regent's residence, with Regent's Park. It contains the finest shops of the city.

REGGIO DI CALABRIA, rād'jō dē kā-lā'-brē-á. The capital of the Province of Reggio di Calabria, Italy, situated on the Strait of Messina, 8 miles southeast of Messina, in Sicily (Map: Italy, K 9). The climate of Reggio is salubrious, and the scenery beautiful. Behind the city rises Aspromonte, where Garibaldi was taken prisoner in 1862. The city has a modern cathedral, an old castle, a statue of Garibaldi, a museum of antiquities, a public library, a lyceum, a technical school, and a seminary. There are manufactures of linens, silks, perfumes, olive oil, etc. The trade is chiefly in wine, fruit, grain, and fish. Population (commune), in 1881, 39,296; in 1901, 44,415.

Reggio is the ancient *Rhegium*, founded by fugitives from Messina about B.C. 723. In B.C. 387 it was destroyed by Dionysius of Syracuse, but became a prosperous city again under the Romans. During the Middle Ages it was plundered by Goths, Saracens, and Turks. It was almost totally destroyed by the great earthquake of 1783, but has since been rebuilt on modern lines.

REGGIO NELL' EMILIA, nēl'lá-mē'lyá. The capital of the Province of Reggio nell' Emilia, Italy, situated on a branch of the Po, and on the Piacenza-Bologna and other railroads, 16 miles west-northwest of Modena (Map: Italy, E 3). It is surrounded by walls and has broad and regular streets. The fifteenth-century cathedral is embellished with statues and monuments. Some of the churches, notably Madonna della Ghiara, contain famous frescoes. The theatre is one of the finest in Italy. There are a museum with a natural history collection, and a library with 55,000 volumes and many valuable manuscripts; also a lyceum, a technical institute, and a seminary. The city lies in a fertile district, and trades in wine, rice, and flax. There are manufactures of cotton and silk stuffs, brooms, leather, and cement. Population (commune), in 1881, 50,651; in 1901, 58,490. Reggio, the ancient *Regium Lepidi*, was a flourishing city under the Romans. It was made the seat of a bishopric in 450. In the twelfth century it became a republic, but passed into the possession of the Este family in 1290. It was repeatedly wrested from them, but was permanently secured early in the sixteenth century, and afterwards shared the fortunes of Modena. Reggio is the birthplace of Ariosto.

REGIA (Lat., royal house). The official residence of the Pontifex Maximus at Rome, situated on the Sacred Way, in the space between the Temple of Faustina and the Temple of Vesta. In it were chapels to Mars and Ops, a hall for religious conventions, and the archives of the priesthood. On its walls were engraved the *Fasti consulares* and *triumphales*, fragments of which were discovered in 1543, when the building was demolished and its material used in the construction of Saint Peter's. The Regia was burnt four times.

REGICIDES (from Lat. *rex*, king + *-cida*, assassin, from *cadere*, to kill). A name given in English history to those persons most active

in bringing about the death of Charles I., and especially to those members of the High Court of Justice, sixty-seven in number, who on January 27, 1649, voted for his execution. Fifty-eight of the sixty-seven, besides Ingoldsby, who was not present when sentence was pronounced, ultimately signed the death-warrant. In 1660, preparatory to his return, Charles II. issued the Declaration of Breda, whereby pardon was granted to all, excepting such as Parliament might afterwards except. The Convention Parliament later passed an act of indemnity, but with many exceptions. Nineteen regicides, who had surrendered voluntarily, were kept in prison, together with six others, till their death, as far as is known, though they were never tried. Ten were executed immediately and three others were caught in Holland, brought to England, and executed. Many lived in exile for the rest of their lives, Goffe, Whalley, and Dixwell (qq.v.) in the American colonies. But even the dead were not spared, the bodies of some being exhumed, dragged to Tyburn, and there burnt, after having been exposed on the gallows. Consult: Régis, *Les Régicides dans l'histoire et dans le présent* (Paris, 1890); Noble, *The Lives of the English Regicides* (London, 1798).

REGICIDES' CAVE. A cavern near the top of West Rock, a cliff at New Haven, Connecticut. It was the place of concealment of the regicides Goffe and Whalley in 1661.

REGILL'US, LAKE. Anciently a small lake of Latium, to the southeast of Rome somewhere about the foot of the Tusculan hills, probably occupying an extinct volcanic crater at a place called Cornufelle, near the modern Frascati. Lake Regillus is celebrated in the semi-legendary history of Rome as the scene (B.C. 496) of a great battle between the Romans under Aulus Postumius and the Latins, on behalf of the banished Tarquin, under O. Mamilius.

REGIMENT (Lat. *regimentum*, government, from *regere*, to govern). A military organization consisting of from two to four battalions (according to the army organizations of the various nations). For purposes of military administration the regiment is the administrative unit, and in large operations requiring great numbers of troops it would be practically the tactical unit. See ARMY ORGANIZATION; BATTALION; COMPANY.

REGIMENTAL COURT-MARTIAL. See COURTS, MILITARY, paragraph *The Regimental Court-Martial*.

REGINA. The capital of the District of Assiniboia and of the Northwest Territories, Canada, 357 miles by rail west of Winnipeg, on the Canadian Pacific Railroad (Map: Northwest Territories, H 4). It is the military headquarters of the Northwest Mounted Police. An important trade in the products of the region is carried on. Population, 1901, 2645.

REGIOMONTANUS (1436-76). A German mathematician and astronomer, whose real name was Johannes Müller. He was born near Königsberg (whence his Latin name), was educated at Vienna, and was a pupil of Georg Peurbach (qq.v.). He collected numerous Greek MSS. and translated many of them, especially the works of Ptolemy, Apollonius, Archimedes, and Hero of Alexandria. He also brought the al-

gebra of Diophantus to the notice of Europeans. Regiomontanus was the author of a treatise on plane and spherical trigonometry, *De Triangulis Omnimodis* (1533), which contained the sine and cosine. Adopting the half chord of the Arabs, he constructed tables of sines and tangents. His work on arithmetic and algebra, entitled *Algorithmus Demonstratus* (1534), was among the first containing symbolic algebra. He established an observatory and printing press in Nuremberg, and produced tables of eclipses, and works on astronomy and astrology. He was called to Rome by Sixtus IV. to revise the calendar, but died there the following year, and was buried in the Pantheon. His works include: *Ephemerides ab Anno 1475-1506* (1474); *Calendarium Norum* (1473); *De Quadratura Circuli* (1463); *Disputationes Dialogus contra Gerhardi Cremonensis in Planetarum Theorias Deliramenta* (1475); *De Reformatione Calendarii* (1484); *De Cometæ Magnitudine Longitudineque* (1531); *Tabulæ Directionum Profectionumque* (1575); *De Doctrina Triangulorum* (1463). Consult Ziegler, *Regiomontanus* (Dresden, 1874). A collection of his letters was edited by Murr (Nuremberg, 1786).

REGISTER (ML. *register, registra, registrum*, variants of *registum*, register, books of record, from Lat. *registus*, p.p. of *regerere*, to record, from *re-*, back again, anew + *gerere*, to carry). In music, the compass of a voice or instrument; specifically, a series of tones produced by the same mechanism and having the same quality. Generally considered, there are three registers in the female voice and two in the male voice. Those notes which proceed naturally and freely from the voice constitute the so-called *chest-register*. The *head-register* embraces those notes which are produced by a somewhat strained contraction of the glottis, while the *falsetto* register is that midway between the two. See ALTO; BARYTONE; BASS; MEZZO; SOPRANO; TENOR; PHONETICS; SINGING; VOICE.

REGISTRATION, OF CHATTEL MORTGAGES. The statutes of several of the United States provide for the registration of chattel mortgages in addition to filing the instruments. This system is designed solely to give notice to the public, and does not combine the guaranty of validity secured by registration of titles to land in some States. The names of the parties, the amount secured, and date of execution, are usually the only facts registered, and, therefore, it practically only amounts to an index of the mortgages on file. See TITLE, REGISTRATION OF.

RE'GIUS. See RHIGIUS.

REGIUS PROFESSOR (Lat., royal professor). The name given to the professors the patronage of whose chairs is vested in the Crown. In the English universities the term is especially applied to those professorships founded by Henry VIII. See UNIVERSITY.

REGLA, rā'glā. A town of Cuba in the Province of La Habana, situated on the east shore of Havana Harbor, opposite the capital (Map: Cuba, C 3). It is connected with the latter by ferry, and with Guanabacoa, 3 miles to the east, by a street railroad. It is also the terminus of a railroad to Matanzas, has sugar warehouses, foundries, and shipyards, and receives a consider-

able part of the shipping of the harbor. Population, in 1899, 11,363.

REGNARD, re-nyār', JEAN FRANÇOIS (1655-1709). A French dramatist. In 1678 he was captured by corsairs on his way from Italy to France and held as a slave at Algiers. This event occasioned his novel *La Provençale*. Later he traveled very widely, from Scandinavia to Turkey, returning finally to France (1683), dividing the time between Paris and his estate at Grillon. Regnard wrote several prose dramas (1688-93); then short plays in verse, and in 1696 produced his first great comedy, *Le joueur*, which with that that followed, *Le distrait* (1697), *Démocrite* (1700), *Les folies amoureuses* (1704), *Les Ménechmes* (1705), and *Le legataire universel* (1708), made him second only to Molière in contemporary esteem. He continued also to write dramas in prose, of which *La foire de Saint-Germain* is most noteworthy, and in *La suite de la foire* he combined prose and verse. Regnard died at Grillon September 4, 1709. He sought to combine the qualities of La Bruyère and Molière, but for this he lacked depth, strength, and seriousness. He shows to best advantage in plot, action, and dialogue, not in analysis and portrayal of character. Regnard's works were collected in 5 vols. in 1731, and in 2 vols. in 1854. Everything of primary importance is in the *Collection Didot* (Paris, 1820). The latest edition is by Moland (ib., 1875). There is a *Bibliography* by Marchéville (ib., 1877), and a critical study by Mahrenholtz (Oppeln, 1887).

REGNAULT, re-nyô', HENRI (1843-71). A French figure and genre painter. He was born in Paris October 30, 1843. After a brilliant record in classical studies, he entered the atelier of Lamothe, and afterwards that of Cabanel, won the Prix de Rome in 1866, and during the two years spent at Rome he designed, among other illustrations, those for Wey's *Rome*. Among his paintings executed at the same time was "La dame en rouge." In 1868 he went to Spain, and while at Madrid he devoted himself especially to the study of Velazquez, whose influence appears in his equestrian portrait of Marshal Prim, one of the finest of the century. Refused by the sitter, it was taken by the artist to Paris, where it created a great sensation in the Salon of 1869, and is now hung in the Louvre. From the same year dates his "Judith," and in 1870 he exhibited "Salome," a symphony in yellow—an incarnation of sensual cruelty. In that year he went to Morocco, whence he sent his famous symphony in red, the "Moorish Headman"—a type of the dreamy cruelty of Oriental fatalism. But hearing of the disastrous opening of the Franco-German War, he hastened back to Paris, and, enlisting in a regiment, was killed at the sortie of Buzenval, January 19, 1871. In the following year the pupils of the Ecole des Beaux-Arts erected a monument to him in the chief court of that school. Regnault was the greatest of the followers of Delacroix (q.v.), whose worthy heir he was, both as regards temperament and technique. He resembled him in brush work and in color, and his drawing is even surer. Consult: Regnault's *Correspondance*, edited by Duparc (Paris, 1872), and his biography by Baillièze (ib., 1871-72), Cazalis (ib., 1872), Timbal (ib.,

1872), Larroumet (ib., 1886), and Roger Marx, in *Les artistes célèbres* (ib., 1886).

REGNAULT, HENRI VICTOR (1810-78). A distinguished French chemist and physicist, born at Aix-la-Chapelle, Germany. When a mere boy he went to Paris and found employment in a drapery establishment. In this manner he was able to provide for himself and his sister, while devoting his leisure hours to study. In 1830, at the age of scarcely twenty years, he was admitted to the Ecole Polytechnique, and two years later, on completing his course of study, engaged in mining engineering. After filling for some time the chair of chemistry at Lyons, he was elected a member of the Academy of Sciences, and became, in 1840, professor of chemistry at the Ecole Polytechnique. In the following year he succeeded Dulong as professor of physics at the Collège de France. In 1847 he was made chief engineer of mines, and in 1854 director of the porcelain manufactory at Sèvres. Regnault was distinguished for extreme skill and patience in experimental work, more than for brilliance or novelty in discovery, or the philosophical interpretation of empirical data. He devoted himself especially to the careful measurement of the constants of nature, laying the foundation on which important chapters in theoretical and physical chemistry have since been worked out by other investigators. His greatest work is that on the numerical data bearing on the working of steam-engines, for which the Royal Society of London awarded him their Rumford medal. This work forms vol. xxi. of the *Mémoires* of the Academy of Sciences. A few of his contributions may be mentioned here. He measured with great care the specific heats of various substances, and his determinations showed that the specific heat of solid chemical compounds is very nearly equal to the sum of the products of the specific heats and the numbers of atoms of the ingredient elements. He similarly showed that the specific heat of a solid alloy can be calculated directly from the specific heats of the component metals. He determined precisely the values of the vapor-tension of water corresponding to various temperatures, and measured the vapor-tensions of mixtures such as those of sulphuric acid and water. He determined the densities of the so-called permanent gases and investigated the true relations between the pressure and volume of gases. According to the law of Boyle and Mariotte, the pressure of a gas kept at constant temperature is inversely proportional to its volume. Regnault showed that this important law, while applicable in ideal cases, and hence interesting to the theoretical engineer, is in reality only approximately correct; that for most gases the pressure is somewhat smaller than that required by the law, while for hydrogen, which he called a more than perfect gas, the pressure is greater than that required by the law. Regnault's data have led to important developments in the kinetic theory of gases and to more correct views concerning the relations between the gaseous and liquid states of aggregation. Among his contributions to organic chemistry deserves mention the discovery of a number of interesting compounds, including derivatives of the unsaturated hydrocarbons. He published his observations in the *Annales de Chimie et de Physique* and the *Comptes Rendus* of the Academy of Sciences. He also wrote: *Cours élémentaire de*

chimie (1849-50, and several later editions), and an abridgment of this work, entitled *Premiers éléments de chimie* (1850; 6th ed. 1874). A collection in 3 volumes of most of his papers on gases and vapors appeared under the title, *Relation des expériences entreprises pour déterminer les lois et les données physiques nécessaires au calcul des machines à feu* (1847-70). Consult Dumas, *Eloge historique de Henri Victor Regnault* (1881).

REGNAULT, JEAN BAPTISTE, Baron (1754-1829). A French painter, of the classical school. He was born in Paris and studied under Bardin; took the Prix de Rome in 1776; was elected to the Academy in 1783 and made professor in the Ecole des Beaux Arts in 1795. His works are in the cold correct style of the pupils of David; the best known are the "Baptism of Christ," much praised by Raphael Mengs, and his masterpiece, the "Education of Achilles," both of which, along with other works are in the Louvre. Among his pupils were Guérin, Hersent, Blondel, and Richehomme.

REGNIER, re-nyá', CLAUDE AMBROISE, Duke of Massa (1736-1814). A French statesman, born at Blamont, Meurthe-et-Moselle. An advocate by profession, he was a deputy to the States General (1789), took a prominent part in establishing the Republican judiciary, but retired during the Reign of Terror. In 1795 he was elected to the Council of the Ancients. He became president of that body in 1798, shared in the coup d'état of the following year, and, as Councillor of State under Bonaparte, was intrusted with the revision of the civil code. He was Minister of Police in 1802-04 and Minister of Justice in 1802-12, when he was made president of the Legislative Assembly.

REGNIER, HENRI DE (1864-). A French poet, born in Honfleur (Calvados), and educated in Paris at the Collège Stanislas. The series of sonnets, entitled *Siles* (1887), which first brought the poet to public notice, were essentially classic and correct. A new manner, new metres, and the sparing use of the *vers libre* in the volumes which immediately followed, marked him as a leader among the Symbolists or Decadents and a pupil of Mallarmé and Verlaine. In this period mention should be made of *Episodes* (1888), less personal or analytical than any preceding volume, and but little more than a series of voluptuously beautiful pictures; of *Poèmes anciens et romanesques* (1890), in which symbolic meaning is given to many old stories; of *Tel qu'en songe* (1892), with its mystic and reflective fancy of double personality; and of *Arcthuse* (1895), his most finished work, an admixture of Hellenic myth and beauty with Celtic melancholy. *La corbeille des heures* reverts to the theme of the earlier poems with an added beauty of treatment. And in *Médailles d'argile* (1900) the poet returns to his earlier exactness of metre. In his fiction, *La canne de jaspé* (1895), *Le trèfle blanc* (1899), and *La double maîtresse* (1900) he shows the same fondness for the unreal or for the chronologically remote, and the same melodious command of words. In 1900 Regnier received the Vitet prize from the French Academy. His ability as a critic was shown in his lectures to the American Cercle Français in 1900, and by an essay on Mallarmé in the *Revue de Paris* for 1898.

REGNIER, MATHURIN (1573-1613). A French satirist, the nephew of Desportes, the poet. He was born at Chartres; took orders as a youth, and went in 1593 as secretary with the Cardinal de Joyeuse to Rome. He returned in 1604, and in 1609 was made a canon in the Chartres Cathedral. He died in the prime of his talent, as the result of his excesses. His sixteen satires include: *Le goût décide de tout*; *L'honneur l'ennemi de la vie*; *L'amour qu'on ne peut dompter*; *Regnier apologiste de lui-même*; *La folie est générale*; and *Le mauvais lieu*. The ninth attacks Malherbe. Dowden says: "His satires are those of a painter whose eye is on his object, and who handles his brush with a vigorous discretion; they are criticisms of society, and its types of folly or of vice, full of force and color, yet general in their intention, for, except at the poet who had affronted his uncle, le bon Regnier struck at no individual." The only work printed during the poet's lifetime was *Satires et autres poésies de Mathurin Regnier* (1608 and 1613). The best editions of his work are those of Viollet-le-Duc (1853), Barthélemy (1862), and Courbet (1869 and 1875). Consult Vianey, *Mathurin Regnier* (Paris, 1896).

REGRATING. An old common-law offense, consisting of buying 'corn and other victuals' and scheming to enhance the price artificially. The offense was early made a matter of statute in England, and probably is not recognized as a common-law offense in the United States. The ancient crimes known as *forestalling* (q.v.) and *engrossing* (q.v.) were quite similar in nature.

REG'ULA (Lat., rule). A band under a triglyph (q.v.) in the Doric style. It has the shape of a narrow stripe of marble, and on the lower side has six *guttæ* (q.v.). It seems to represent an original wooden cleat secured by nails.

REGULA FAL'SI (Lat., rule of the false). The Latin name for the method of false position (q. v.). This method was largely used in the Middle Ages in the solution of equations. E.g., the simple equation $ax + b = 0$ was solved thus: If z_1 and z_2 are any two numbers, and $az_1 + b = c_1$, $az_2 + b = c_2$, then $x = \frac{z_2c_1 - z_1c_2}{c_1 - c_2}$.

REGULAR ARMY AND NAVY UNION OF THE UNITED STATES OF AMERICA. A patriotic society founded in Washington, D. C., on November 4, 1897. It has for its principal objects to provide for comrades when sick or in need; to assist in the burial of its dead; to keep alive old friendships formed in the service; to suggest and encourage the enactment of necessary laws for the benefit of soldiers, sailors, or marines; and to keep before the people and the officials of the Government the necessity and justice of giving employment in the Government service to men honorably discharged or retired who have rendered faithful military service to the Government, and who are trustworthy and competent. It admits to membership members of the regular army, navy, or marine corps of the United States, or those who have been honorably discharged or retired if they have served for five years in either branch of the service. Its insignia consists of a badge pendant from a ribbon, which is the national flag, with a clasp at the top formed of a spread eagle,

while the badge itself consists of a cross with the emblems of the different branches of the service in the points, and in the centre a triangle, with the letters A, N, and M, signifying Army, Navy, and Marine, surrounded by the legend "Trinitas Protego, R. A. and N. U., U. S." It has a membership of upward of 6,000, divided among garrisons and sub-garrisons in the United States and the Philippines.

REGULATED COMPANIES. Associations of merchants formed in early modern times to exploit monopolies of special branches of foreign trade. Each member of the company embarked his capital in the monopolized trade, managing his own business, but subject to the regulations of the company. These companies were formed on the model of the mediæval guild (q.v.). They made rules for admission to the company, decided how great a volume of business each member should transact, and sometimes fixed prices. The company as a body possessed property, as, for example, factories in the country with which they traded; but there was no idea of making profits to be distributed to the company as a whole. Through their regulation active competition among members was obviated, and coöperation against foreign competitors assured. Thus it became possible to carry on trade which an isolated trader would not have ventured upon.

The earliest regulated companies were those formed by the merchants of the Hanseatic League (q.v.) for trading in England. The plan was adopted by the English merchants who first engaged in foreign trade, the Merchants of the Staple, and the Merchants Adventurers (q.v.). The regulated company was the form of organization of the Levant Company, incorporated in 1581, to carry on trade in the Eastern Mediterranean; the Muscovy Company (1554), of merchants trading in Russia; the Eastland Company, incorporated under Elizabeth, to carry on trade with the Baltic countries. The East India Company, as originally constituted, formed a transition from the regulated to the joint-stock company. In the last named company individual members were not given a right to carry on trade on private account, but were required to trade through sub-companies, under the control of the parent company.

This form of organization was in its time distinctly superior to unregulated private trading, but it proved inadequate for carrying on so hazardous and extensive a trade as that with the East Indies, and was gradually supplanted by the joint-stock company. After 1612 the East India Company had abandoned the principle of the regulated company. The other companies mentioned continued to exist in their original form until the eighteenth century. In the seventeenth century they showed a tendency toward monopoly, excluding, through excessive entrance fees, traders who desired to gain membership. Hence arose a class of 'interlopers,' who traded in the monopolized region in defiance of the company. The minute regulations imposed upon members proved to be vexatious in the more enterprising trade of the seventeenth century, and were in large measure responsible for the decline of the companies.

REGULATORS, THE. The name given to those who actively opposed excessive taxes, dishonest sheriffs, and extortionate fees, in North

Carolina, in 1765-71. Practically all authority was at this time centred in the royal Governor; the taxes were levied exclusively upon the poll; there was little money in the western counties and no market for the products of these counties. The court officials, moreover, were accused of exacting illegal fees. Disturbances in Mecklenburg and Granville Counties in 1765, and in Orange County in 1766, were easily put down. The Regulation proper began in Orange County in the spring of 1768, the 'Regulators' agreeing to pay no more taxes until they were satisfied that such taxes were according to law, and to pay no more than the legal fees. The news that the Assembly had appropriated £15,000 to build a house for the Governor increased the dissatisfaction. Minor disturbances occurred in the county, and the county militia was ordered out. William Butler and two other Regulators were fined and imprisoned. Edward Fanning, register of the county, was found guilty of extortion in office on five counts and was fined a penny and costs on each. The Assembly in 1769 was in sympathy with the Regulators. Petitions from Anson, Rowan, and Orange Counties demanded among other things salaries for officers instead of fees, a property tax, and that ministers of any denomination should be allowed to perform the marriage ceremony. This Assembly was dissolved by the Governor November 6th, after a session of two weeks. In September, 1770, renewed disturbances occurred in Orange County. The Assembly thereupon expelled Herman Husband, one of the leaders of the Regulators, passed a Riot Act, voted £500 for the defense of the town, but proceeded to pass much legislation demanded by Regulators. In May, 1771, Governor Tryon (q.v.), at the head of a large force, proceeded to Hillsboro. On May 16th he met about 2,000 Regulators, of whom hardly half were armed, at Alamance Creek. A sharp contest ensued for two hours. Of the Loyalists 70 were killed and wounded, while 9 of the Regulators were killed, a "great number" wounded, and 15 taken prisoners, one of whom was hanged on the spot. Six of the prisoners were tried and executed. By July 4th more than 6,000 men had taken the oath of allegiance, and the Regulator leaders were pardoned by the King before the Revolution. In 1772 it was estimated that 1,500 had emigrated to the West, and the excitement was over. During the Revolution most of the Regulators adhered to the King. Consult Bassett, "The Regulators of North Carolina," in the *Report of the American Historical Association for 1894* (Washington, 1895).

REGULUS, MARCUS ATILIUS. A Roman general. He was consul for the first time in B.C. 267, and, for his successes against the Sallentini, obtained the honor of a triumph. Chosen consul a second time (B.C. 256), he was sent along with his colleague, L. Manlius Vulso, at the head of a navy of 330 ships (with a land army on board) against the Carthaginians, it being the ninth year of the First Punic War, and encountering the enemy's fleet off Heraclea Minor, he totally defeated it. The Romans then landed near Clypea, where they established their headquarters, and ravaged the surrounding Carthaginian territory with fire and sword, but Manlius being recalled to Rome with one-half of the land forces, Regulus was left to carry on the war

with the remainder. For some time he was victorious in every encounter, but at last (B.C. 255) suffered a total defeat; 30,000 Romans were left dead on the field, about 2,000 fled and took shelter in Clypea, and Regulus, with 500 more, was taken prisoner. Regulus remained in captivity for five years, but when fresh reverses induced the Carthaginians to solicit peace, he was released on parole and sent to Rome in company with the Punic envoys. The rest of his history is one of the most favorite of Roman tales. According to these legends, Regulus at first refused to enter Rome, since he was no longer a citizen; after this conscientious scruple was overcome, he declined to give his opinion in the senate until he was commanded to do so; he then earnestly dissuaded them from agreeing to any of the Carthaginian proposals, even to an exchange of prisoners, and after he had succeeded, by his earnest appeals, in obtaining the rejection of the Carthaginian offers, he resisted all persuasions to break his parole, though conscious of the fate that awaited him, and, refusing even to see his family, returned with the ambassadors to Carthage, where the rulers put him to death with the most horrible tortures. The common story is that he was placed in a cask or chest stuck full of nails with the points projecting inward, and rolled about till he expired; and on the news of this event reaching Rome, retaliations equally atrocious were committed on two of the noblest Carthaginian prisoners. This story, however, is not mentioned by Polybius (about B.C. 200), who details at great length the achievements of Regulus.

REHAN, re'an (originally CREHAN), ADA (1860—). An American actress. She was born in Limerick, Ireland, April 22, 1860, and was brought to the United States when about six years old. While still at school she appeared upon the stage, but she virtually began her career by a two years' engagement at Mrs. Drew's theatre, in Philadelphia, during 1873-75. Subsequently she was with John W. Albaugh's company, playing leading juvenile parts, often with well-known stars, in Baltimore, Albany, and elsewhere. When Augustin Daly opened his theatre in New York in 1879, she joined his company, with which she continued till his death. As leading woman in the company, and after 1894 as a recognized 'star,' she played the heroines in a long series of successful comedies, for which Daly's management was noted. Both in the delicate art of high comedy and in more farcical characters she won for herself before 1890 a place in the front rank of American actors. Her two greatest rôles are those of Rosalind in *As You Like It* and Katharine in *The Taming of the Shrew*, while her Viola and her Lady Teazle have also been much admired. Among her parts in Mr. Daly's lighter productions were those of Valentine Osprey in *The Railroad of Love*, Peggy in *The Country Girl*, Kate Verity in *The Squire*, Nancy Brasher in *Nancy and Company*. She was Maid Marian in Tennyson's *Foresters*, and Roxane in Daly's presentation of *Cyrano de Bergerac*. Miss Rehan had great success in Germany in 1886, as also in Paris; and in London in 1888 and on frequent subsequent visits her popularity became almost as great as in this country. Consult: Winter, *Ada Rehan, A Study* (limited ed., New York, 1891); McKay and Wingate, *Famous American Actors of To-day* (New York, 1896);

Strang, *Famous Actresses of the Day in America* (Boston, 1899); Hapgood, *The Stage in America, 1897-1900* (New York, 1901).

REHATSEK, rá'hát-shek, EDUARD (1819-91). An Orientalist, born at Illach, in Slavonia, and educated in Budapest. He lived for several years in the United States—mostly in New Orleans—and in 1847 settled in Bombay, where he became professor in the Wilson College. About 1871 he became examiner to Bombay University in Latin, Arabic, and Persian, but in 1881 he resigned from this post, and spent the last decade of his life as a Hindu pundit. He contributed to the *Calcutta Review*, to the *Indian Antiquary*, to the *Journal of the Royal Asiatic Society, Bombay Branch*, and to the *Zeitschrift der deutschen Morgenländischen Gesellschaft*. His published works include a valuable catalogue of the Arabic, Persian, Turkish, and Hindustani manuscripts in the Mulla Firuz (1873); *Amusing Stories* (1870), *Fortune and Misfortune* (1871), both from the Persian; a version of Mirchond's *Universal History* (1893); and a translation of Mir Khwänd's *Garden of Purity* (1891-94).

REHEARSAL, THE. A burlesque by George Villiers, Duke of Buckingham, produced in 1671, ridiculing D'Avenant, Dryden, Sir Robert Howard, and other writers of the heroic dramas of the Restoration. It was long popular, and was imitated by Fielding in *Tom Thumb the Great* and by Sheridan in *The Critic*.

RE'HOBO'AM (Gk. Ῥοβοᾶμ, *Rhoboam*, Heb. *Rēhūb'ām*, probably the [divine] kinsman is, or makes, wide). The son of King Solomon by his wife, Naamah, princess of the royal house of Ammon, and his successor, in early youth, to the throne of all Israel (c.937-920 B.C.). The hereditary jealousy of the northern tribes toward Judah, aggravated by Solomon's tyrannical exactions, came to a head at once upon the son's accession. He proceeded to Shechem to receive the homage of the north, and arrogantly rejected the demand of his subjects that he lessen their burdens (I. Kings xi. 43; xii. 15). The leadership of the discontented tribes by Jeroboam, who already in Solomon's reign had been exiled for conspiracy (I. Kings xi. 26-40), and who had returned upon the death of Solomon, indicates a well-defined plan of revolt. The temper of northern Israel is further shown by the murder of Adoram, the aged minister of public works. Rehoboam, taken unawares, had to flee to Jerusalem; he made a show of compulsion by force of arms, but Judah had no forces commensurate with those of the north, and hostilities were confined to border warfare; according to the narrative he was forbidden to prosecute the war by the prophet Shemaiah (I. Kings xii. 16-24). From this time the so-called Kingdom of Judah consisted only of the tribe of Judah, and half of Benjamin, with remains of Dan and Simeon. During the reign of Rehoboam Palestine was invaded (c.733 B.C.) by Shishak, or Sheshonk, the founder of the Twenty-second Egyptian Dynasty. The narrative relates his spoliation of Jerusalem, where the temple suffered heavily (I. Kings xiv. 25-28). (See SHISHAK.) Rehoboam reaped the fruits of his father's vainglorious policy, and personally doubtless deserves the biblical condemnation (I. Kings xiv. 21-24), while his wife, probably a descendant of Absalom, exerted

a powerful and evil influence in the government. He was succeeded by his son Abijam (Abijah). See JEROBOAM I.

REHO'BOTH (Heb. pl. of *rēchōb*, wide, particularly the plaza by a city gate, the market and forum of an Oriental town, hence a common place-name). (1) The name of a well dug by Isaac (Gen. xxvi. 22). As it is associated with Beer-sheba, the identification with the name of Wady el-Rubeibe, eight miles southwest of Beer-sheba, is plausible. Here Robinson discovered ruins of a large town, to whose origin the biblical tradition may refer. The name may appear in an Egyptian geographical list, and also in the Tell-el-Amarna Tablets. Consult: Robinson, *Biblical Researches*, vol. i. (Boston, 1841); Palmer, *Desert of the Exodus* (Cambridge, 1871). (2) Rehoboth by the River, properly River-town, the home of an Edomite king (Gen. xxxvi. 37; I. Chron. i. 48). As 'The River' is *par excellence* the Euphrates, the place has been assigned to Mesopotamia; but it can only be located in Edom.

REICHA, rīk'á, ANTON (1770-1836). An Austrian musical theorist and composer, born at Prague. He was nephew and pupil of the musician Joseph Reicha. From 1794 to 1799 he was piano teacher in Hamburg, where he wrote an opera, *Obaldi ou les Français en Egypte*, which he took to Paris for production. He was unsuccessful with this, but two symphonies obtained for him a reception as instrumental composer. He lived in Vienna from 1801 to 1808, where he became intimate with Beethoven and was on friendly terms with Haydn, Albrechtsberger, and Salieri. In 1808 he returned to Paris, and brought out the operas *Cagliostro* (1810), *Natalie* (1816), and *Sapho* (1822). These were only fairly successful. His Italian opera, *Argina, regina di Granata*, had previously failed in Vienna. He gained, however, a high reputation as theorist teacher and instrumental composer. In 1818 he succeeded Méhul as professor of counterpoint and fugue at the Conservatory, was naturalized in 1829, and succeeded to Boieldieu's chair in the Académie in 1835. Among his works are many instrumental pieces, especially string quartets and quintets for wind instruments, and the treatises: *Etudes ou théories pour le pianoforte dirigées d'une manière nouvelle* (1800); *Traité de haute composition musicale* (1824 to 1826); and *L'art du compositeur dramatique* (1833). He was not an inventor, but his theoretical works are of practical value and still stand in high repute.

REICHARDT, rīk'art, GUSTAV (1797-1884). A German song writer, born at Schmarsow, near Demmin. He received his first musical training from his father, and studied theology at the universities of Greifswald and Berlin, where he also continued his musical studies. After 1819 he devoted himself entirely to music. He was a piano and violin virtuoso, and published several technical treatises. He also wrote numerous popular songs with piano accompaniment, the most familiar of which are *Das Bild der Rose* and *Was ist des Deutschen Vaterland?*

REICHARDT, JOHANN FRIEDRICH (1752-1814). A German composer, conductor, and writer on music, born at Königsberg. He had good musical training, and studied philosophy at Königsberg and Leipzig. In 1775, upon the death

of Agricola, he obtained the position of Kapellmeister at Berlin. During an extended leave of absence in London and Paris (1785 to 1786) he brought out his Passion music (after Metastasio) in both cities. He was commissioned to write two operas, *Tamerlan* and *Panthée*, for the Grand Opéra; but the death of Frederick II. made it necessary for him to return at once to Berlin and the operas were not produced. Under Frederick William II., he was permitted to increase the orchestra and obtain new singers from Italy, but later was suspended for three years and finally dismissed in 1794, on account of his sympathy with the French Revolution. Upon the death of the King he returned to Berlin, but the French occupation, in 1806, drove him back to Königsberg. Jerome Napoleon, however, forced him to return, and appointed him Kapellmeister at Cassel. He composed numerous German and Italian operas, incidental music to plays, and *Singspiele* which had considerable influence on the development of German opera. As a song composer he ranks high. He set about 60 of Goethe's lyrics to music. He published: *Ueber die deutsche komische Oper Briefe eines aufmerksamen Reisenden, die Musik betreffend* (1774-76); *Studien für Tonkünstler und Musikfreunde* (1793); *Vertraute Briefe aus Paris* (1804-05); and *Vertraute Briefe, geschrieben auf einer Reise nach Wien* (1810), all of which are of permanent value. For his life consult Schletterer (Augsburg, 1865-68).

REICHENBACH, rī'ken-bāc. A town in Silesia, Prussia, 32 miles southwest of Breslau (Map: Prussia, G 3). It has an old castle, and a Realgymnasium. It manufactures cotton and woolen fabrics, wagons, and sausages. A convention was concluded here between Austria and Prussia in 1790 by which the two powers agreed to respect the integrity of Turkey and Poland respectively. Population, in 1900, 15,052.

REICHENBACH. A town in the Kingdom of Saxony, Germany, 56 miles by rail south of Leipzig (Map: Germany, E 3). It has a new town hall, a commercial school, and a Realschule. There are wool mills, dye works, and machine shops. Population, in 1900, 24,498.

REICHENBACH, KARL, Baron von (1788-1869). A German naturalist and technologist, born at Stuttgart. He was educated at the University of Tübingen. He established iron works at Villingen and kilns for the production of charcoal at Hausach. His researches in connection with the manufacture of charcoal led him to study the products of destructive distillation of organic bodies in general, and he was the first to obtain creosote and paraffin. In 1821, in connection with Count Hugo zu Salm, he founded the iron works at Blansko, in Moravia, and took charge personally of their superintendence. This position afforded him valuable opportunities for original research, and his numerous observations and inventions have proved of great value to science and art. His name is also connected with what he thought to be the discovery of a new force of nature, an account of which may be found under *Op*. His principal publications include: *Geologische Mitteilungen aus Mähren* (1834); *Physikalisch-physiologische Untersuchungen über die Dynamide des Magnetismus, der Electricität, etc., in ihren Beziehungen zur Lebenskraft* (1849; trans. into English). Consult Schrötter, *Karl Freiherr von Reichenbach* (Vienna, 1869).

REICHENBERG, rī'ken-bērck. An important industrial town in the Crownland of Bohemia, Austria, situated on the Neisse, 52 miles north-east of Prague (Map: Austria, D 1). It is a well-built town with a number of interesting churches, of which the *Kreuzkirche*, built at the end of the seventeenth century, contains an altar-piece by Albert Dürer, a sixteenth-century palace, belonging to the counts of Clam-Gallas, a new Rathaus, and a number of monuments. The educational institutions of the town comprise a technical school, a higher gymnasium, a seminary for teachers, a textile school, a municipal theatre, and an industrial museum. The textile industry—of which Reichenberg is one of the principal centres in Austria-Hungary—was introduced into the town as early as the beginning of the fifteenth century, and Reichenberg, together with a number of adjacent villages, produces now cloth, carpets, and various kinds of woolen and cotton goods on a very large scale. Reichenberg contains also the immense meat and malt extract works of Liebig & Co. Population, in 1890, 30,890; in 1900, 34,204, chiefly Germans.

REICHENHALL, rī'ken-hāl. A town and watering-place in the Kingdom of Bavaria, Germany, picturesquely situated amid lofty mountains, on the Sallach, eight and a half miles southwest of Salzburg (Map: Germany, E 5). It is the centre of the Bavarian salt works (the largest in Germany). The saline baths, famous since the eighth century, are the most important in the German Alps. Population, in 1895, 4193.

REICHERSBERG, rīk'ers-bērck, GERHON VON. See GERHON or GERHOCH VON REICHERSBERG.

REICHMANN, rīk'mān, THEODOR (1849-1903). A German dramatic barytone, born at Rostock. He was educated musically under Elsler, Mantius, Röss, and Lamperti, and soon became famous for his voice, which was of a very dramatic quality. He sang in several important theatres of Germany and Austria, and from 1882 to 1889 he was a member of the Vienna Court opera. One of his most famous achievements was his creation of the part of Amfortas at the Bayreuth festival. In 1899-90 he sang in German opera in New York, after which he returned to Vienna.

REICHSRAT, rīks'rāt. (1) The national legislative assembly of the Austrian (Cisleithan) half of the Austro-Hungarian monarchy. See AUSTRIA-HUNGARY. (2) The Upper House of the Bavarian Parliament (Landtag). See BAVARIA.

REICHSTADT, rīk'stāt, NAPOLÉON FRANÇOIS CHARLES JOSEPH BONAPARTE, Duke of (1811-32). The only child of Napoleon I. and the Empress Maria Louisa, sometimes known as Napoleon II. He was born in Paris, March 20, 1811. The infant prince was proclaimed King of Rome and baptized on June 9 in the Cathedral of Notre Dame, by Cardinal Fesch. After the battle of Waterloo Napoleon abdicated in favor of his son, but the Senate took no notice of Napoleon II., and called Louis XVIII. to occupy the French throne, whereupon Maria Louisa and her child removed to the palace of Schönbrunn, near Vienna, where they remained till the Treaty of Vienna had rearranged the affairs of Europe. Maria Louisa then proceeded to take possession of the Duchy of Parma, while her son continued to reside at the Austrian Court with his grandfather, Francis I. By an Imperial patent, dated

July 22, 1818, he was created Duke of Reichstadt, with the rank of an Austrian prince. He received a liberal education, but never enjoyed robust health, nor did he exhibit energy of character. He died at Schönbrunn, July 22, 1832. His body was interred in the Imperial tomb at Vienna. Consult Welschinger, *Le roi de Rome, 1811-32* (Paris, 1897).

REICHSTAG, rik's'täg. See GERMANY.

REID, rēd, Sir GEORGE (1841—). A Scotch painter, born in Aberdeen. He was a pupil of the Trustees Academy in Edinburgh, and also studied under Mollinger, Israels, and Yvon. He succeeded Douglass as president of the Royal Scottish Academy in 1891, and was knighted in the same year. He is noted as a delicate painter of flowers and landscape, and as a fine portraitist. His works in this latter line include portraits of Lord President Inglis, in the Scottish Parliament House, of John Mackenzie, and of H. Wellwood Maxwell.

REID, GEORGE AGNEW (1861—). A Canadian artist, born near Wingham, Ontario. He began to study art in Toronto under Robert Harris, continued it in Philadelphia with Thomas Eakins, and then went to Paris, where he studied with Constant, Lefebvre, Dagnan-Bouveret, and others. A frequent exhibitor at the Salon, his oil paintings were also displayed at the leading exhibitions in Canada and the United States, and he won a World's Fair Columbian medal for his large canvas, "The Foreclosure of the Mortgage" (1893). Some of his other important pictures are "Drawing Lots," "Dreaming," "The Other Side of the Question," "Mortgaging the Homestead," "The Berry Pickers," "A Story, Adagio," "A Modern Madonna," "Lullaby," and "Twilight," while he was also particularly successful in panels for mural decoration. The series of these in the entrance hall of the municipal buildings, Toronto, was presented to the city by Mr. Reid and placed there at his own expense. In 1898 he was elected president of the Ontario Society of Artists.

REID, JAMES SMITH (1846—). An English classicist, born at Sorn, Ayrshire, Scotland, and educated at the City of London School and Christ's College, Cambridge. He was Fellow of Christ's College from 1870 to 1872 and classical lecturer of Pembroke College (1873-78 and 1880-85), and tutor of Gonville and Caius College 1885—. In 1899 he was made professor of Ancient History. His publications include editions of many of Cicero's philosophical works and orations and numerous philological papers.

REID (THOMAS) MAYNE (1818-83). A British writer of hunting romances and tales of adventure, born at Ballyronee, County Down, Ireland, April 4, 1818. His father was a Presbyterian minister and Mayne Reid was educated for the same profession, but the thirst of adventure led him to emigrate to the United States. In 1840 he arrived at New Orleans, where he worked as a storekeeper, negro-overseer, and actor. As a hunter and trader among the Indians, he gained that knowledge of scenery, manners, and characteristics which he afterwards used to advantage in his *Scalp Hunters*, *White Chief*, and many other romances. He devoted five years to travel in the United States. In 1846 he obtained a commission, and served with

distinction in the Mexican War. In 1849 he sailed for Europe to take part in the struggle for independence in Hungary, but got no farther than France. He then went to England, and began his long series of romances. In 1867 he returned to New York, and founded the unsuccessful *Omnard Magazine*. In 1870 he went back to England, where he died October 22, 1883. Among his many tales of adventure on land and on sea are: *The Rifle Rangers* (1850); *The Desert Home* (1851); *The Free Lances* (1851); *The War Trail* (1857); *The Boy Tar* (1859); *Afloat in the Forest* (1865); *The Castaways* (1870). Most of Reid's stories were translated into French, and many of them into German. Consult the *Memoir* by his widow, Elizabeth Reid (London, 1890).

REID, ROBERT (1863—). An American figure painter, born in Stockbridge, Mass. He was a pupil of Boulanger and Lefebvre, in Paris, and was strongly influenced by the Impressionists. His figure pieces are usually girls surrounded by flowers, out of doors, and his treatment is essentially energetic and bold. He is better known by his purely decorative works, which include "America Unveiling Her Natural Strength," in the United States Building at the Paris Exposition of 1900. There were also frescoes by him in the Liberal Arts Building at Chicago in 1893. He received the Hallgarten Prize in 1898, and a silver medal, and special gold medal for mural decoration, at Paris in 1900.

REID, ROBERT GILLESPIE (?—). A Canadian railway contractor, born at Coupar Angus (Perthshire), Scotland. In 1865 he went to Australia, where he was interested in gold-mining and other ventures, and in 1871 he emigrated to America, and had charge of the construction of the international bridge across the Niagara River, the international railway bridge over the Rio Grande, the Lachine Bridge over the Saint Lawrence, three-quarters of a mile in length, and much other important bridge work in the West. In 1893 he made a contract with the Government of Newfoundland colony whereby he was to construct a trans-insular railway from Saint John's to Port-aux-Basques, to be paid for at the rate of \$15,600 a mile and completed in three years. It was likewise arranged that he was to maintain and operate the line for a period of ten years in consideration of a grant of 5000 acres of land in alternate blocks for each mile of railway constructed. In 1898 he contracted with the Government to operate all trunk and branch railways in the island for a period of fifty years, on condition that these railways should, at the termination of the time specified, become his property. He was also to receive from the Government 2,500,000 acres of land on terms similar to those described in the previous contract; to obtain the Government telegraph lines; to build and operate seven steamers; to build and operate a street-railway in Saint John's; to buy and operate the Saint John's dry dock; to pave a designated portion of Saint John's; and to pay \$1,000,000 in cash to the Government within one year from the signing of the contract. Much opposition to this transaction was aroused in the colony and finally resulted in the resignation of the Governor, Sir James Winter, and his Cabinet, and the election of the Liberal Robert Bond. Reid then agreed

to transfer his property to the Reid Newfoundland Company, capitalized at \$25,000,000, with the understanding that the telegraphs were immediately to revert to the Government, that the land grants should be so rearranged as to protect the rights of private owners whose property had been included therein, and that at the end of fifty years the colony might take over all railways, on payment of \$1,000,000 with interest thereon, and an additional sum, to be determined by arbitration, as reimbursement for all improvements made within that time.

REID, SAMUEL CHESTER (1783-1861). An American naval officer, born in Norwich, Conn. He went to sea at the age of eleven, and on his first voyage was captured by a French frigate and confined for six months in Guadalupe. Subsequently he entered the United States Navy and served on the *Baltimore* under Commodore Truxton in the West Indies. During the War of 1812 he commanded the privateer *General Armstrong*. On September 26-27, 1814, in the neutral harbor of Fayal, Azores, the *General Armstrong* was attacked by three British vessels of much superior strength. Reid and his men defended themselves bravely in one of the most heroic conflicts of the entire war and on the second day, after having disabled one of the British ships, and inflicted a loss of 120 killed and 180 wounded on the enemy, scuttled their ship, and retreated to the shore. The entire American loss was 2 killed and 7 wounded. The violation of the neutrality of Fayal, a Portuguese port, resulted in a protracted diplomatic correspondence, and the final submission of the question at issue to Louis Napoleon, who decided against the American contention. Subsequently, however, the British Government apologized for the breach of neutrality. After the war Reid became a sailing-master in the navy, and was for many years warden of the port of New York, in which capacity he introduced many reforms, established the light-ship at Sandy Hook, perfected the signal telegraph, and reorganized the pilot system. He planned the present United States flag, adopted in 1818, providing for thirteen permanent stripes, and stars increasing with the admission of new States.

REID, THOMAS (1710-96). A leading philosopher of the Scottish school. He was born April 26, 1710, at Strachan, Kincardineshire, began his education in the parish school of Kincardine, and at the age of twelve became a student at Marischal College in Aberdeen. He took his degree of M.A. in 1726, and continued to reside in Aberdeen as college librarian, his chief studies being mathematics and the philosophy of Newton. In 1737 he was presented by the senatus of King's College to the parish church of New Machar in Aberdeenshire. The parishioners were bitterly opposed to his appointment, but his conduct and manner gradually won them over. In 1739 Hume's *Treatise of Human Nature* appeared, the perusal of which gave the impulse that determined his future philosophical career. He had fully adopted the idealism of Berkeley, but was now revolted by the conclusions drawn from it by Hume, and in consequence was led to seek a new foundation for the common notions as to a material world. In 1748 he contributed to the Royal Society of London a short essay on *Quantity*, occasioned by what he considered an abusive application by Hutcheson of the forms of mathe-

matical reasoning to ethics. In 1752 he was appointed one of the professors of philosophy in King's College, Aberdeen. Here he taught mathematics, natural philosophy, and moral philosophy. In 1763 he was chosen to succeed Adam Smith as professor of moral philosophy in the University of Glasgow. He now confined himself to teaching metaphysics and psychology. In 1764 he published his *Inquiry into the Human Mind on the Principles of Common Sense*. He continued in the duties of his chair till 1781, when he devoted his remaining strength to the publication of his works on the mind. In 1785 the *Essays on the Intellectual Powers* appeared; and in 1788 *Essays on the Active Powers*. The publication of the latter was the close of his career as an author, although to the end of his life he kept up his bodily and mental vigor, and his interest in science. He died October 7, 1796. The distinguishing feature of his philosophy was the assertion of certain irresistible convictions which are due to intuitions. Among them are the conviction as to the real existence of an external world, as to the causal connection of phenomena, as to the moral character of actions and the existence of the soul. These convictions are called axioms, self-evident truths, principles of common sense. The existence of these convictions is proved, so Reid maintains, by the testimony of experience. See COMMON SENSE. Reid's works were edited by Dugald Stewart (Edinburgh, 1804), with a *Life* by Stewart; and by Hamilton very elaborately (8th ed., ib., 1880). Consult: McCosh, *Scottish Philosophy from Hutcheson to Hamilton* (New York, 1875); A. Seth (Pringle Pattison), *Scottish Philosophy* (2d ed., Edinburgh, 1890); Sneath, *The Philosophy of Reid* (New York, 1892); Fraser, *Reid* (Edinburgh, 1898).

REID, SIR THOMAS WEMYSS (1842-). An English journalist and author, born at Newcastle-on-Tyne and educated there. Having begun journalism in 1861, he edited the *Leeds Mercury* for seventeen years. In 1887 he resigned to become manager of Cassell and Company, a well-known London publishing house. In 1890 he was appointed the first editor of the *Speaker*, founded as a Radical organ. This weekly periodical he ably conducted till his resignation (1899). Reid has made solid contribution to recent history in *Cabinet Portraits* (1872); *Politicians of To-Day* (1879); *The Land of the Bey*, an account of a visit to Tunis (1882); and especially in his *Life of the Rt. Hon. W. E. Forster* (1888); *Life of Richard Mouckton Milnes* (1891); *Life of Lord Playfair* (1899); and *Life of W. E. Gladstone* (1899), of which he was editor. His biography of *Charlotte Brontë* (1877) served as an excellent corrective to the somewhat imaginary portraits of the Brontës by Mrs. Gaskell. His novels *Gladys Fane* (1883) and *Mauleverer's Millions* (1885) were successful.

REID, WHITELAW (1837-). An American journalist and statesman, born in Xenia, Ohio, October 27, 1837. He graduated at Miami University (1856) and immediately entered into journalism and politics, making political speeches and editing the *Xenia News*. He was a captain and volunteer aide on the staff of Major-General Thomas A. Morris and afterwards on that of Rosecrans. He served as correspondent of the

Cincinnati *Gazette* during the Civil War, was present at Shiloh, Gettysburg, and elsewhere, and was afterwards chosen Librarian of the House of Representatives (1863-66). He then tried cotton planting in Louisiana and wrote *After the War* (1866). Returning to Ohio, he wrote *Ohio in the War* (1868), an elaborate and important work. He next joined the staff of the *New York Tribune*, and, succeeding Horace Greeley in 1872, became its editor and principal owner. He twice declined appointment as Minister to Germany, but he accepted the nomination for Vice-President (1892) and the appointment of Minister to France (1889-92) and Special Ambassador to Queen Victoria's Jubilee (1897). He was a member of the Peace Commission that terminated the Spanish War (1898), and Special Ambassador to Great Britain for the coronation of Edward VII. (1902). Among his collected writings are: *Schools of Journalism* (1871); *The Scholar in Politics* (1873); *Some Newspaper Tendencies* (1879); and *Town Hall Suggestions* (1881).

REID, Sir WILLIAM (1791-1858). A British soldier and meteorologist, born at Kinglassie, Scotland. He was educated at the Royal Military Academy, Woolwich, was commissioned lieutenant of engineers in 1809, and was later sent to the theatre of war in Spain. In 1815 he participated in Sir Edward Pakenham's unsuccessful attack on New Orleans. The next year he took part in Lord Exmouth's expedition against Algiers. In 1835 he commanded a brigade in the British Legion raised by the Queen Regent of Spain. In 1839 he was appointed Governor of the Bermudas, where he remained until 1846, when he was transferred to Barbadoes as Governor-in-Chief of the Windward Islands. In 1849 he was made commanding royal engineer at Woolwich. He was Governor of Malta from 1851 until 1858, and in 1856 was raised to the rank of major-general. He published several books, including *An Attempt to Develop the Law of Storms* (1838) and *The Progress of the Development of the Law of Storms* (1849).

REIFFERSCHIED, rī'fēr-shīt, AUGUST (1835-87). A German archaeologist and classical philologist, born and educated in Bonn. He received a traveling fellowship in archaeology from the University of Bonn; spent 1861-66 mostly in Italy, being part of the time charged by the Vienna Academy to make archival research for the Latin *Corpus Scriptorum Ecclesiasticorum Latinorum*; and was professor at Breslau (1868-85), and from 1885 at Strassburg. His works include *Suctoni præter Cæsarum Libros Reliquia* (1860), the standard edition of these fragments; *Bibliotheca Patrum Latinorum Italica* (1865-72); *Arnobius* (1875); an edition of Anna Comnena's *Alexias* (1878); and a partial edition of Tertullian (edited by Wissowa, 1890).

REIGATE, rī'get. A municipal borough and market town in Surrey, England, at the base of the North Downs, 23 miles south of London (Map: England, F 5). The town was incorporated in 1863; it owns a sewage farm, provides isolation for infectious diseases, and contributes to technical instruction. From early times it was considered a place of strength; and after the Conquest it was granted to the earls of Warrenne. Of the castle built by these earls only vestiges remain. The parish church is in

various styles of architecture, the oldest portions dating from the twelfth century. Trade is chiefly agricultural; Reigate has neighboring quarries of freestone and hearthstone and supplies of fullers' earth, and of silver sand for manufacturing glass. Population, in 1891, 22,646; in 1901, 25,993.

REIGHARD, JACOB ELLSWORTH (1861—). An American zoölogist, born at Laporte, Ind. He graduated at the University of Michigan in 1882, pursued graduate studies at Harvard and Freiburg, and after six years as instructor and assistant in zoölogy became in 1892 professor in the University of Michigan. He was in charge of the Michigan Fish Commission in 1890-94, and in 1898 was appointed director of the biological survey of the Great Lakes under the auspices of the United States Fish Commission. Reighard contributed to many technical journals, and in 1901 published in collaboration with Jennings *The Anatomy of the Cat*.

REIGN OF TERROR. The name commonly given to that period of the French Revolution beginning with the fall of the Girondists (q.v.) in June, 1793, and terminating with the overthrow of Robespierre (q.v.), July 27, 1794. See FRENCH REVOLUTION.

REIMARUS, ri-mä'ryus, HERMANN SAMUEL (1694-1768). A German naturalistic philosopher. He was born in Hamburg, December 22, 1694, studied at the universities at Jena and Wittenberg, traveled afterwards in Holland and England, and on his return was elected rector at Wismar (1723) and in 1728 professor of Hebrew and mathematics at the Gymnasium of Hamburg. He died there March 1, 1768. He is the author of the so-called *Wolfenbüttelsche Fragmente eines Unbekannten*, first published by Lessing in his *Beiträge zur Geschichte und Litteratur aus den Schätzen der Wolfenbüttelschen Bibliothek* (1774, 1777-78). These *Fragmente*, up to that time only known in manuscript by a few of Reimarus's most intimate friends, produced a sensation throughout Germany, since the author, in the boldest and most trenchant manner, denied the supernatural origin of Christianity. They were partially translated, as *Fragments from Reimarus* (London, 1879). Another work in the same direction is his *Vornehmste Wahrheiten der natürlichen Religion* (1754). His edition of Dio Cassius is one of the most valuable contributions to classical philology (1750). Consult his biography by Strauss (Bonn, 1862; 2d ed. 1877).

REIMS, rēms, *Fr. pron.* räns. A city of France. See RHEIMS.

REIN, rīn, JOHANNES JUSTUS (1835—). A German geographer, born at Raunheim-on-the-Main, and educated in mathematics and science at the University of Giessen. He made various scientific journeys in Europe, Asia, and America, and in 1876 was appointed professor of geography at the University of Marburg. Afterwards he held a similar appointment in Bonn. His publications include *Japan, nach Reisen und Studien* (1881-86), which was translated into English, under the title *Japan, Travels and Researches* (1884), as was also his book on the industries of Japan (1889); and *Columbus und seine vier Reisen nach Westen* (1892).

REIN, WILHELM (1847—). A German educator and author, born at Eisenach. He studied at Heidelberg, Leipzig, and Jena, for several years was teacher at Weimar, and from 1876 to 1886 was principal of a school in Eisenach. In 1886 he was appointed professor of pedagogy at the University of Jena. Rein's system of education resembles Herbart's. He ranks among the foremost of educational theorists, and has exerted great influence on the educational institutions of his country. His principal works are *Theorie und Praxis des Volksschulunterrichts* (1879-93) and *Pädagogik im Grundriss* (1892). He edited Niemeyer's *Grundsätze der Erziehung* (1878-79), and founded the educational journal *Pädagogische Studien* in 1880.

REINACH, rá'ná', JOSEPH (1856—). A French publicist, born in Paris. He studied at the Lycée Condorcet and in the faculty of law of the University of Paris, was admitted to the bar in 1877, wrote for the *Dix-neuvième Siècle* and Gambetta's *République Française*, and in 1881-82 was private secretary to Gambetta, then president of the Cabinet council. Having reëntered journalism, in 1886 he became proprietor with Deynarouse of the *République Française*, in which he supported the Union-Republican group. In 1889 he was elected as Liberal-Republican Deputy for Digne (Basses-Alpes), in 1893 was re-elected, but in 1898 failed of reelection because of opposition to his attitude in the Dreyfus case. In the Chamber of Deputies he was a member of the committees on the budget and on the army, and took a prominent part in the legislative debates. He became departmental councillor of Basses-Alpes for the Canton of Moustiers in 1896. He appeared prominently in connection with the Dreyfus case, denounced the introduction of secret documents into the trial of 1894, the forgeries of Paty du Clam and Henry, and the complicity of the latter with Esterházy, and was associated with Scheurer-Kestner in the movement for revision. He published on the case several pamphlets, including *La voix de l'isle* (1898), *Les enseignements de l'histoire* (1898), *A l'isle du diable* (1898), *Vers la justice par la vérité* (1898), *Le crépuscule des traitres* (1899), and *Les faits nouveaux* (1899), and the volumes *Les blés d'hiver* (1901), *Histoire de l'affaire Dreyfus*, *Le procès de 1894*, and *Histoire de l'affaire Dreyfus*. Esterházy (1903). The brochure *Les enseignements de l'histoire* originally appeared in the *Siècle*, and caused Reinach to be expelled from his captaincy in the territorial army for "a gross offense against discipline" and to be deprived of the decoration of the Legion of Honor. Among his further publications are: *La Serbie et le Monténégro* (1876); *Voyage en Orient* (1879); *Le ministère Gambetta* (1884); *Etudes de littérature et d'histoire* (1888-89); and *Les petites Catilinaires* (1888-89), collected articles against Boulanger. He also edited the *Discours et plaidoyers politiques de Gambetta* (11 vols., 1881-85), and *Dépêches, circulaires, décrets, proclamations et discours de Gambetta* (1886).

REINACH, SALOMON (1858—). A French archaeologist, brother of the preceding, born at Saint-Germain-en-Laye (Seine-et-Oise). He studied at the Lycée Fontanes and the Ecole Normale Supérieure, was appointed to the French Classical School of Athens (Ecole Française d'Athènes), and made interesting excavation and discoveries

at Myrina, near Smyrna, and elsewhere (1880-82). In 1886 he became attaché in the Museum of National Antiquities at St. Germain-en-Laye, in 1890-92 held the chair of assistant professor of national archaeology at the Ecole du Louvre, and in 1893 was appointed associate curator of the National Museums. He was elected to the Académie des Inscriptions et Belles-Lettres in 1896. He reviewed works on archaeology for the *Revue Critique*, edited a careful text (1877) of Saint Augustine's *De Civitate Dei*, and published among his original volumes a *Chronique d'Orient* (1885-91), cataloguing all discoveries made in Greece to that date; *La nécropole de Myrina* (with Pottier, 1887); *Description raisonnée du musée de Saint-Germain* (1890); *Les Celtes dans les vallées du Pô et du Danube* (1894); *Répertoire de la statuaire grecque et romaine* (1897-98); and *Guide illustré du musée national de Saint-Germain* (1899).

REINAUD, rá'nó', JOSEPH TOUSSAINT (1795-1867). A French Orientalist, born at Lambesc (Bouches-du-Rhône). He was a pupil of Sylvestre de Sacy, became connected with the Royal Library, and was appointed conservator of that institution in 1834. He was also president and (1838 et seq.) De Sacy's successor as professor of Arabic at the Ecole des Langues Orientales Vivantes (1838-67). He published: *Monuments arabes, persans, et turcs du cabinet de M. le duc de Blacas et d'autres cabinets* (1828), a work of great value, especially in the province of epigraphy; a version of Raymond Lully's *Livre de la loi au Sarrazin* (1831, with Michel); *Extraits des historiens arabes relatifs aux guerres des croisades* (1829); *Invasions des Sarrazins en France* (1836); the text and a French version of Abulfeda's geography (with Slane, 1840-48); *Fragments arabes et persans relatifs à l'Inde* (1834); *Relation des voyages faits par les Arabes et les Persans dans l'Inde et Chine* (1845); and *Relations politiques et commerciales de l'empire romain avec l'Asie orientale* (1863). From 1847 to his death he was president of the Société Asiatique.

REINDEER (Icel. *hreinn*, AS. *hrán*, reindeer, from Lapp *reino*, pasturage + *deer*, AS. *dēor*, Goth. *dius*, wild beast, animal, Ger. *Thier*, animal). An Arctic deer (*Rangifer tarandus*) which has long been domesticated and used as a draught animal and a beast of burden in Northern Europe. The wild race still exists in varying abundance almost everywhere from Northern Scandinavia to Eastern Siberia, wandering to the Arctic coast and throughout Spitzbergen, Nova Zembla, and the Phipps and Parry islands. They are not known much south of Lapland in the west, nor below the northern margin of the great forest region in Siberia, but in the Ural region they wander southward to the borders of Perm. Whether the caribou (q.v.) of Greenland and Canada are to be regarded as merely geographical races of the European form, thus considered as a circumpolar species, is a matter of opinion. European zoologists generally do so regard it, and assert that the differences between European and American examples are not sufficient to be deemed specific. Merriam and other recent American zoologists think otherwise and set apart no less than six 'species' in the New World. Within historic times reindeer lived in the islands north of Scotland, but became extinct there before the

twelfth century; they were much more recently numerous throughout Scandinavia. The habits of the American species are outlined under CARIBOU. Those of the plains and islands of subarctic Europe and Asia wander about the tundras and desolate treeless mountains, making periodical migrations from one feeding-ground to another. In early summer the Spitzbergen herds betake themselves to the grassy valleys of the interior, whence they return in the autumn to the coast to feed upon seaweed. The coming of the winter ice cuts off this resource, compelling them to go into the mountains, where they subsist upon the rock-lichens, which they uncover by shoveling away several feet of snow with their flat horns, or pawing it aside with their feet. The alternate thawing and freezing of spring, by forming a hard crust on the snow, interferes sadly with their welfare, and great numbers sometimes starve at this season. In Siberia, as in North America, migrations in scattered herds regularly take place from the barren coast plains southward to the less inclement region along the borders of the forest area, where food may be obtained. Not much is known of the breeding habits of the wild reindeer except that the fawns are born in the spring.

The reindeer has long been domesticated among the Laplanders and the tribes along the coast of Siberia, and used for drawing sledges and as a riding and burden animal, besides furnishing skins for tents, clothing and harness, flesh and milk for food, and horns and hoofs for various utilities. It has remarkable endurance, strength, and speed in drawing sledges, and without this animal much of Lapland and Siberia could not be permanently inhabited. These qualities led the Government of the United States to endeavor to naturalize reindeer among the Eskimos of the north coast of Alaska, who were in danger of starving through the loss of food and uneconomical habits, following the pursuit of excessive whaling and walrus-hunting by white men off that coast. The experiment was conducted under the direction of the Commissioner of Education and the personal care of the Rev. Sheldon Jackson. Agents procured a small herd of Siberian reindeer which, with Lapp attendants, were landed in Northern Alaska in 1889. The training of Alaskan attendants and drivers was begun, and more herds were annually imported. Up to 1898 550 deer had been brought from Siberia, and the stock with its increase amounted to about 5000 in 1903. Several stations were established where the deer were bred, and where Eskimos were trained in their care and use. The history of the attempt is contained in Jackson's *Annual Reports* to the Department of the Interior, from 1890 onward.

The wild reindeer is much larger than the domesticated races. It is as large as the stag, but heavier and more clumsy in appearance. It has a dark coat in summer and a lighter one in winter, with a growth of long whitish hair under the neck, while the region about the short goat-like tail and the outlines of the hoofs are nearly white. It constitutes a genus (*Rangifer*), differing from that of ordinary deer in the important particular that both sexes have horns, although those of the bucks are larger. These antlers are peculiar in their long, slender, unequally branching beams, and especially in the fact that the brow-tines are greatly produced and palmated, and one is usually aborted to allow the other to

push forward into a formidable weapon, overhanging the face.

During Pleistocene time the reindeer was more widely distributed over Europe than it is at the present day, for its fossil remains have been found as far as the Alps and the Pyrenees.

Consult: Lydekker, *Deer of All Lands* (London, 1898); id., *Royal Natural History*, vol. ii. (London, 1896); Nordenskiöld, *Voyage of the Vega* (New York, 1881); Boyd Dawkins, *Cave Life* (London, 1875); and the works of travelers and explorers in the Arctic regions and the countries where reindeer are used. For the American forms, consult: Stone and Cram, *American Animals* (New York 1902); Roosevelt, *The Deer Family* (ib., 1902); Preble, "Biological Investigation of the Hudson Bay Region," in *North American Fauna* No. 22 (Department of Agriculture, Washington, 1902); and books cited under DEER.

REINDEER MOSS (*Cladonia rangiferina*). A lichen of great importance to inhabitants of the northernmost regions of the Northern Hemisphere, where it covers great areas and furnishes the chief winter food of the reindeer. It is found in almost all parts of the world, but is most abundant and luxuriant in arctic and sub-arctic regions, often occupying the ground in pine and spruce forests. When such forests are destroyed by fire it soon reappears. It is a variable plant, but always consists of a much-branched, erect, cylindrical, tubular thallus, with small perforations in the axils, and attains a height of two inches or more. Its importance was first brought into notice by Linnæus in his *Flora Laponica*. It is sometimes used for human food. Its taste is pleasant, although attended with a slight pungency or acidity. It is generally boiled in reindeer milk. Its nutritious qualities depend chiefly on a form of starch, lichenin, which it contains.

REINECKE, rī'nĕk-e, KARL (1824—). A German pianist, born at Altona. He studied with his father, Johann Peter Rudolph Reinecke, a musical composer and director. He was Court pianist to Christian VIII. at Copenhagen from 1846 to 1848. He became teacher at the Cologne Conservatory in 1851, and occupied at later times the positions of musical director at Barmen, academie musical director and conductor of the Singakademie at Breslau, conductor of the Gewandhaus Concerts at Leipzig, and teacher at the Conservatory. His compositions are both refined and classic throughout, but possess here and there a marked touch of the romantic. Among his works are: *Serenade*, *Aus der Jugendzeit*, *Neues Notenbuch für kleine Leute*; *Nocturne*; studies, sonatas, quartets, quintets, and trios. The five-act grand opera *König Manfred* was produced in 1867; the opera *Ein Abenteuer Händel's*, in 1874; two three-act comic operas, *Auf hohen Befehl* and *Der Gouverneur von Tours*, in 1886 and 1891 respectively. He also wrote the funeral march for Emperor William I. He became widely known as an excellent conductor, and as a pianist for his interpretations of Mozart.

REINEKE VOS. See REYNARD THE FOX.

REINHART, rīn'härt, CHARLES STANLEY (1844-96). An American genre painter and illustrator. He was born in Pittsburg, Pa. From

1868 to 1870 he studied at the Atelier Suisse, Paris, and at the Royal Academy, Munich, under Streyhüber and Otto. Upon his return to the United States he illustrated for various foreign and American magazines, and frequently exhibited works in oil, water-colors, and black-and-white at the National Academy. From 1881 to 1891 he resided in Paris, exhibiting regularly at the Salon, afterwards becoming a member of the Society of American Artists, New York. Reinhart excelled in black-and-white, his oils and water-colors being mostly marine views, painted in sombre but delicate colors. In oil are: the "Old Life Boat" (1880); "Mussel Fishermen" (1886); "Washed Ashore" (1887), which won the gold medal (Philadelphia, 1888); and the "Rising Tide" (1888), purchased by the Government at the Paris Exposition, 1889. His water-colors include "Gathering Wood" (1877), "At the Ferry" (1878), and the "Spanish Barber" (1884). Among his chief series in black-and-white are the "Reichstag Sketches," "A Little Swiss Sojourn," and "Americans Abroad." Reinhart died in New York City, August 30, 1896.

REINHART, CHRISTIAN (1761-1847). A German landscape painter and etcher, born at Hof, Bavaria. First instructed by Cöser in Leipzig, he studied at the Dresden Academy under Klengel, but chiefly after the Dutch masters, and in 1789 went to Rome, where he settled permanently and under the influence of Carstens and Koch became a conspicuous exponent of the historic landscape. His best work is represented by the "Eight Historic Landscapes" (1825), in the Palazzo Massimi, Rome, and "Four Views from Villa Malta," in tempera, painted for King Louis I. of Bavaria. The New Pinakothek in Munich contains "Four Views Near Rome" (two dated 1836, 1846), the Leipzig Museum a "Wood on Seashore in a Storm" (1824) and "Landscape with Psyche" (1829), the Städels Institute, Frankfurt, a landscape with "Cain and Abel," and the Cologne Museum a "View from Tivoli." To a collection of seventy-two etchings of prospects in Italy, published conjointly with Dies and Mechau under the title *Malerisch radirte Prospective aus Italien* (1792-98) Reinhart contributed twenty-four plates, the best of the series. Besides these he etched many other Italian landscapes, and thirty-eight animal studies, in all 170 plates. Consult: Baisch, *Reinhart und seine Kreise* (Leipzig, 1882); and Andersen, *Die Deutschen Maler-Radire*, i. (ib., 1866).

REINHART VON GRÜNINGEN, fón grü'ning-en. See GRÜNINGER, JOHANN.

REINHOLD, rīn'hölt, CHRISTIAN ERNST (1793-1855). A German philosopher, son of Karl Leonhard Reinhold, born at Jena. He at first lectured on philosophy at the University of Kiel, and afterwards was appointed professor of logic and metaphysics at the University of Jena. His philosophical system resembles Kant's. He published: *Geschichte der Philosophie nach den Hauptmomenten ihrer Entwicklung* (4th ed. 1884); *Theorie des menschlichen Erkenntnisvermögens und Metaphysik* (1832-34); *Lehrbuch der Geschichte der Philosophie* (3d. ed. 1849) a work of much value; and *System der Metaphysik* (3d ed. 1854). Consult Apelt, *Ernst Reinhold und die Kantsche Philosophie* (Leipzig, 1840).

REINHOLD, KARL LEONHARD (1758-1823). A German philosopher, born in Vienna. In 1772 he entered the Jesuit College of Saint Anna, but upon the suppression of this Order in 1774 he joined the Barnabites, and was for some years an inmate of their College of Saint Michael. His religious zeal in the meantime had cooled considerably, and in 1783 he left the Order and went to Leipzig, where he devoted himself to philosophy. Afterwards he settled in Weimar. His contributions to the *Deutscher Merkur* attracted much attention, and in 1787 his *Briefe über Kantsche Philosophie* appeared in this periodical. His clear and eloquent exposition of Kant's doctrines, which at that time were being combated, resulted in his being appointed to a professorship of philosophy in Jena. In 1789 he published his chief work, *Versuch einer neuen Theorie des menschlichen Vorstellungsvermögens*, in which he attempts to broaden the teachings of Kant. He then for a time identified himself with Fichte's doctrines and even tried afterwards in his *Paradozien der neuesten Philosophie* to find a middle way between Fichte and Jacobi in order to satisfy his religious sentiments, but when Bardili's logic appeared he deserted both and joined the latter's rational idealism. The reason for this change he gives us in his treatise *Wahrheit* (1820).

REINICK, rī'nik, ROBERT (1805-52). A German painter, etcher, and poet, born and educated in Danzig. He studied painting under Begas in Berlin and at the Düsseldorf Academy, and settled at Dresden in 1844. Several pleasing pictures, either historical or romantic in subject, had come from his brush after 1830—for example, "Rachael and Jacob at the Well" (Stettin Museum), "Well Near Olevano," and several others (Danzig Museum)—but his most interesting productions are those in which his pictorial and poetic talents are blended, such as "Drei Umrisse nach Holzschnitten von Dürer mit erläuterndem Text und Gesängen" (1830). With Kugler he published the *Liederbuch für deutsche Künstler* (1833), with woodcuts by Gubitz, and then the *Lieder eines Malers mit Randzeichnungen seiner Freunde* (1838), with thirty-one etchings by himself and other Düsseldorf artists. He supplied the poetical text to Retbel's "Dance of Death," and was associated with Ludwig Richter in editing Hebel's *Allemannische Gedichte* (1851), of which he gave a High-German version. A sixth edition of his collected *Lieder*, with a biography by Auerbach, was published in Berlin in 1873. His natural ability as a juvenile poet is well exemplified by the *Lieder und Fabeln für die Jugend* (2d ed. 1849), the *Illustriertes ABC-Buch für kleine und grosse Kinder* (4th ed. 1876), and the fairy-tale *Die Wurzelprinzessin* (1848). The poetical works for young people appeared collected under the title *Märchen-, Lieder- und Geschichtenbuch* (11th ed., Leipzig, 1895).

REINICKE, rī'nik-e, PAUL RENÉ (1860—). A German painter and draftsman, born at Strenz-naundorf, near Halle. He studied at Weimar under Struys, at Düsseldorf under Gebhardt, and at Munich under Pügelheim, whom he accompanied to Palestine. Settled afterwards in Munich, he found the true field for his talent in drawing sketches for the *Fliegende Blätter*, in which his masterly delineations from the social life of the upper classes in its various aspects soon became an eagerly looked-for specialty. A selection of

his drawings was published in Munich (1890) under the title "Spiegelbilder aus dem Leben." His "Waiting Room of the First Class in the Munich Railway Station" is in the National Gallery, Berlin. He was awarded a gold medal in 1882.

REINKENS, rin'këns, JOSEPH HUBERT (1821-96). The first Old Catholic bishop. He was born at Burtscheid, near Aix-la-Chapelle; studied theology at Bonn; was ordained priest of the Roman Catholic Church; and in 1853 was appointed professor of Church history at Breslau. In 1870 he united with Döllinger in the Old Catholic movement, was suspended by the Bishop of Breslau, and the students were forbidden to attend his lectures. In 1873 he was consecrated Bishop at Rotterdam by the Jansenist Bishop of Deventer. He soon took the oath of allegiance to the Government, and was recognized by Prussia as a Catholic bishop, with his residence at Bonn, and remained there in this capacity till his death. His publications include: *Hilarius von Poitiers* (1864); *Martin von Tours* (1866); *Revolution und Kirche* (1876); *Melchior von Diepenbroek* (1881); *Lessing über Tolcranz* (1883). See OLD CATHOLICS.

REINMAR VON HAGENAU, rin'mär fôn hä'ge-nou (?-c.1210). A German poet, one of the first of the minnesingers, usually called Reinmar the Old. From Hagenau he went to Vienna and there taught Walther von der Vogelweide, with whom he may have made the Crusade of 1190. His poetry, artificial, sad, and 'pale-hued,' won him the title of the 'Nightingale of Hagenau' from Gottfried von Strassburg, a panegyric from his pupil Walther, and from Uhland high praise for its sentiment and diction. It is published in Lachmann and Haupt's *Des Minnesangs Frühling*. Consult: Schmidt, *Reinmar von Hagenau* (Strassburg, 1874); and Burdach, *Reinmar der Alte und Walther von der Vogelweide* (Leipzig, 1880).

REINSCH, rinsh, PAUL SAMUEL (1869-). An American historical writer. He was born in Milwaukee, Wis., of German-American parents. He graduated at the University of Wisconsin in 1892, at the law school of the same institution in 1894, and after being admitted to the bar practiced for some time in Milwaukee. Returning to the State University in 1895, he became an instructor and extension lecturer in history, pursuing graduate studies at the same time, and taking the degree of Ph.D. in history in 1898. In 1899 he was appointed assistant professor of political science, and in 1901 professor of political science. His publications include *The Common Law in the Early American Colonies* (1899), *World Politics at the End of the Nineteenth Century* (1900), and *Colonial Government* (1901).

REINTHALER, rin'tä-lër, KARL MARTIN (1822-96). A German composer, born at Erfurt. He studied music under A. B. Marx, and, later, in both Paris and Rome. In 1853 he was appointed teacher at the Cologne Conservatory, and in 1858 became municipal music director and cathedral organist at Bremen, where he also conducted the cathedral choir, the Singakademie, and the concert society. He retired in 1893. His best known works are the oratorio *Jephtha*, the *Bismarck-Hymne*, the choral works *In der Wüste*, and *Das Mädchen von Kolah*, and the operas

Edda (1875) and *Kätchen von Heilbronn*, which gained a prize at Frankfurt in 1881.

REIS, ris, PHILIPP (1834-74). A German physicist, born at Gelnhausen. In 1858 he became a teacher in the Garnier Institute, near Homburg, and there, after two or three years of research, in 1860 he produced the first telephone. It transmitted musical tone, but not the intelligible utterances of the voice. Reis gained no benefit from his invention. In 1885 a monument was erected to him in his native town. Consult Thomson's English version of the biographical sketch by Schenk (London, 1883).

REISEBILDER, ri'ze-bil'dër (Ger., pictures of travel). A work by Heinrich Heine in four volumes (1826-31), in which poetic descriptions of nature and powerful delineations of character are mingled with scoffs at the institutions of the age, political, religious, and social. The wit and irreverence of these attacks, which respected nothing, together with the real beauties of the work, won for it an immediate success and brought the author into popular favor. Some of the poems interspersed through the work were published later with others under the title of *Buch der Lieder*.

REIS EFFENDI, rä'is ëf-fën'di (Turk., presiding official). A title formerly given to an officer of State in the Ottoman Empire. He was the Chancellor of the Empire, and Minister of Foreign Affairs. His duties in the first-mentioned capacity was to confer with the Grand Vizier regarding the orders and instructions to be sent to the different provinces and regarding the proper decision on any subject affecting the Empire, whether internal or external; and in the latter capacity he had the sole and exclusive charge of the relations of the Porte with foreign courts.

REISKE, ri'ske, JOHANN JAKOB (1716-74). A celebrated German philologist and Oriental scholar. He was born at Zörbig, Prussian Saxony, and was educated at the University of Leipzig, where he devoted much attention to the study of the Semitic languages, especially Arabic. In 1758, after living in abject indigence, he obtained the rectorship of the Nikolai Gymnasium, in Leipzig, and he retained the post till his death. From 1758 he devoted his attention chiefly to Greek literature, in which he became a recognized authority. His works, which are very numerous and are remarkable for their learning, include his *Animadversiones in Græcos Auctores* (1757-66), and editions of Theocritus (1765-66); of the Greek orators (1770-75); of Maximus Tyrius (1774-75); of Dionysius of Halicarnassus (1774-77); of Plutarch, with notes and translations (12 vols., 1774-82); Dio Chrysostom (1784-98); and Libanius (1791-94). Reiske was also the first to call attention to the historical and æsthetic value of Arabic literature. His chief work in this field was his Latin translation of the *Annales Moslemici* of Abulfeda (1754; frequently reëdited). Some of these works, and his correspondence with Moses Mendelssohn and Lessing, were published after his death, by his wife, Ernestine Christine Reiske (1735-98). Consult: Morus, *Vita Reiskii* (Leipzig, 1777); Reiske, *Selbstbiographie* (Leipzig, 1793); and Haupt's *Opuscula* (Leipzig, 1875-76).

REISS, ris, WILHELM (1838-). A German traveler and naturalist, born at Mannheim. He

traveled in the Azores, Madeira, and Canary Islands in 1858-60, in Greece in 1866, and with Stübel in 1868-76 explored South America. In particular he visited Ecuador, Colombia, Peru, and Bolivia, and he and Stübel were the first to ascend Mount Cotopaxi. The scientific results of this journey were of much value. Reiss was president of the Berlin Gesellschaft für Erdkunde in 1885-87, and of the Anthropological Society in 1888. In addition to contributions to the publications of the Gesellschaft für Erdkunde and various scientific journals, he wrote: *Das Totenfeld von Ancon in Peru* (1880-86); *Geologische Studien in der Republik Columbia* (1892-99); and *Das Hochgebirge der Republik Ecuador* (1892-1902).

REISSIGER, rīś'sīg-ēr, KARL GOTTLIEB (1798-1859). A German musician, born at Wittenberg. He studied under Schicht at the Thomasschule at Leipzig, and dramatic composition under Winter at Munich. He taught at the Berlin Royal Institute, and in 1826 went to The Hague, where he organized a conservatory which is still prosperous. This same year he succeeded Marschner as musical director of the German Opera at Dresden, and later was appointed Kapellmeister, as Weber's successor. He wrote: *Didone abbandonata* (1823); *Die Felsenmühle von Etalières* (1829), the overture of which is still played at concerts; *Turandot* (1835); *Adèle de Foix* (1841); masses, psalms, symphonies, overtures, sonatas for violin and cello, and the oratorio *David*. *Weber's Last Thought*, a waltz, is his most popular piece.

REISSMANN, rīś'mán, AUGUST (1825—). A German writer on music, born at Frankenstein, Silesia. He studied at Breslau under Mosewius, Baumgart, Richter, Lüstner, and Kahl. From 1866 to 1874 he lectured on the history of music at the Stern Conservatory in Berlin. From 1880 at Leipzig, and later at Wiesbaden. *Das deutsche Lied in seiner historischen Entwicklung* (1861) is his best and most original work. His other historical works, mostly clever collections or extracts from original studies made by others, include: *Von Bach bis Wagner* (1861); *Allgemeine Geschichte der Musik* (1863-65); *Illustrierte Geschichte der deutschen Musik* (2d ed. 1892); and the biographies of various composers. He also composed an oratorio, *Wittekind*, two operas, symphonies, chamber music, and songs.

REITBOK (from Dutch *rietbok*, reed-duck, from *riet*, reed + *bok*, buck). One of the small antelopes, called by English sportsmen in Africa 'reedbucks.' See REEDBUCK.

REJ, rē'y', MIKOLAJ (1505-69). A Polish poet and prose writer, born in the Ukraine. He was more than sixty years of age before he produced his principal poem, *Zwierzciadlo* ("The Mirror," 1567, reprinted in 1829). Nine years previously his *Wizerunek własny zycota elowieka poczciwego* ("Picture of an Honorable Man," 1558, reprinted at Warsaw, 1881-88) had appeared, and besides metrical Polish translations of the Psalms (1533), *Postylla Polska* (Gospel Commentaries, 1556), and a catechism, he published *Zycot Józefa* (1545), *Zwierzyniec* (1562), and *Figliki* (1568). A stout Calvinist, he wrote much in defense of his chosen creed and was one of the first to use Polish as a literary language. His prose shows the language in its

purity, before the introduction of foreign words and forms.

RÉJANE, rá'zhān', MADAME (1857—). The stage name of Gabrielle Réju, a French actress, born in Paris. She made her début at the Vaudeville in 1875, and soon gained a reputation for her witty impersonations. In 1892 she married M. Porel, then her manager. In 1893 she created her best-known rôle of *Madame Sans Gêne*, written for her by Sardou. She appeared with it in London in 1894, and in the United States in 1895. Afterwards she appeared in *La douloureuse* and *Zaza*.

REJECTED ADDRESSES. Burlesque poems by James and Horace Smith, published anonymously in 1812. Ostensibly unsuccessful efforts in the competition for the opening of the new Drury Lane Theatre at that time, they were amusing parodies on the poems of Wordsworth, Southey, Coleridge, Byron, Scott and others.

REJOINER (OF., F. *rejoindre*, to rejoin, from Lat. *re*, back again, anew + *jungere*, to join). In common-law pleading, the answer of a defendant to a plaintiff's replication to his (defendant's) plea. See PLEADING.

REJUVENATION, or REJUVENESCENCE. It is supposed by Maupas and others that the process of conjugation in the Infusoria (q.v.) results in increased vigor and vitality, and is thus advantageous to those organisms in which the most primitive form of reproduction is by simple self-division. Indeed it has been observed that conjugation results in increased activity in multiplication by fission. So also sexual reproduction is a rejuvenizing process, and tends to prevent both the individual and the species from deteriorating or running out. It may be said to correspond in its effects to cross-fertilization, which is the antidote to too close in-breeding and tends to enhance the vitality of the species and prevent degeneration. In botany, a transformation of one cell into another, i.e. into a primordial cell, which afterwards secretes a new cell-wall, and forms the starting-point of the life of a new individual. Examples occur in numerous algae (*Ectogonium*), and also in certain diatoms. See GROWTH.

RELAPSE, THE; OR VIRTUE IN DANGER. A comedy by Sir John Vanbrugh, produced in 1697. It was written as a sequel to Cibber's *Love's Last Shift*, and was very popular throughout the eighteenth century. It was imitated by Lee in *A Man of Quality* (1776), and recast by Sheridan as *A Trip to Scarborough* (1777). Voltaire used it as the basis of *Le Comte de Boursoufle* (1734). Later versions were made by Hollingshead in *Man of Quality* (1870) and Buchanan in *Miss Tomboy* (1890).

RELAPSING FEVER (from Lat. *relapsus*, p.p. of *relabi*, to fall back, from *re*, back again, anew + *labi*, to slip), FAMINE FEVER, or FEBRIS RECURRENS. A specific infectious and contagious disease, generally occurring in epidemics, and due to a micro-organism, the *spirochaeta Obermeieri*. This organism is a spirillum, about $\frac{1}{10}$ of an inch in length, and undergoing constant movements of a rotary or lashing character. The disease occurs in times of famine and flourishes under conditions of overcrowding, dirt, and poverty. Individuals in constant contact with the disease, as physicians, nurses, and clergymen, are often

attacked. The peculiar nature of the malady was pointed out by Henderson in 1842 and by Sir W. Jenner, 1849 to 1851. Their views have since been confirmed by the discovery of the specific micro-organism by Obermeier.

The period of incubation of relapsing fever averages from 4 to 10 days. The fever begins suddenly with a chill or rigor, accompanied by frontal headache, and pains in the back and limbs. The temperature may be 103° or 104° F., and mounts on the succeeding days to 105° or even 108°. The general condition remains much the same for about a week, except that the symptoms increase in severity. Little sleep is obtained, but the mind remains clear until near the end of the paroxysm, when delirium supervenes. When all the symptoms are at the height, crisis suddenly occurs in 5 to 7 days, with profuse perspiration and a rapid abatement of suffering. Convalescence now sets in and is permanent in many cases. In others the patient feels comparatively well, but very weak until about fourteen days from the initial attack or seven days after the crisis, when he is again seized with chills and fever, and the whole series of phenomena is repeated. This relapse is usually shorter than the first paroxysm, and permanent recovery follows it in the majority of cases.

The spirilla are always present in the blood during the paroxysms and increase in number as the fever progresses. They disappear at the crisis and remain absent until near the advent of the relapse. During this period they may be found in the spleen and bone marrow (as proved by experiments on monkeys), where they probably break down and leave spores which germinate and thus produce the organisms which determine the relapse.

No treatment has succeeded in shortening the paroxysms or preventing the recurrence of a relapse; and although certain drugs, such as quinine, carbolic acid, and iodine, arrest the movements of the spirillum outside the body, they have no influence when given as remedies. Treatment must be symptomatic. Sponging with tepid water or packing in wet sheets will give temporary relief when the fever is very high, and headache may be relieved by cold applications. During the severe perspiration of the crisis the patient must be kept as dry as possible, and the tendency to collapse must be met by additional coverings, hot bottles, and diffusible stimulants. For the severe pains opium or morphine is given. Cooling drinks and gentle saline laxatives increase the comfort of the patient. During convalescence, fresh air, good food, and tonic medicines are indicated. The disease is rare in this country, no epidemics having appeared since 1869, when it prevailed extensively in New York and Philadelphia. It is common in India, where favorable conditions for its development seem always to be present.

RELATIONS (Lat. *relatio*, relation, reference, report, restoration, from *re-*, back again, anew + *latus*, p.p. assigned to, *ferre*, to bear, carry). In law, technically, such kindred of a person as may be entitled to share in his personal estate under the statute of distributions in force in the jurisdiction in which the meaning of the word is called in question. The word, therefore, is employed in a wider sense in some jurisdictions than in others, and the classes of persons

included vary according to the jurisdiction. It is popularly employed to describe all family connections by blood or marriage, and the law will recognize this use of the word where it is evident, a person so intended to employ it. See **AFFINITY**; **CONSANGUINITY**; **LINEAL**. See also Blackstone's *Commentaries*.

RELATIONSHIP. The exact degree of affinity existing between keys, chords, and tones. See **TEMPERAMENT**.

RELATIVITY (from Lat. *relativus*, having reference or relation), **LAW OF**. In its most general form, the law, as given by Stumpf, is that the relation of sensations to one another is essential to their very existence; so that black, e.g. can be sensed only in opposition to white, or at least only in distinction from a grayer or blacker black; a tone or noise only as alternating with other tones or noises, or with complete silence, and so on—while every sensation will disappear under the operation of uniform and continuous stimulation. Simple as this statement looks, it is capable of many interpretations, none of which can be regarded as unexceptionable.

The grain of truth which Stumpf finds in the doctrine is that the presence of sensation in the adult consciousness is almost without exception connected with certain judgments of its relation to other ideas. And these judgments (apprehensions, apperceptions), if they cannot alter the content of sensation, can at least render it confusable with other contents not now sensed. Wundt, on the other hand, has consistently maintained that our mental life is governed by a law of relativity, such that every phase of present experience is conditioned not only by other phases of the same experience, but also by the whole past history of consciousness. The laws of mind at large are of two classes: laws of relativity and laws of development. Under the heading of relativity we have (1) the law of psychical resultants, which affirms that every mental complex shows properties which, once given, can be understood from the attributes of its elements, but which cannot be regarded as a mere sum of those attributes. (2) The law of relations asserts that every dissection of a conscious whole into its constituent terms is an act of relating analysis. Finally, (3) the law of psychical contrasts maintains that mental processes of opposed direction mutually reinforce one another. The laws of mental development are (1) the law of mental growth, the application of the law of resultants; (2) the law of heterogony of ends, based upon the laws of resultants and of relations; and (3) the law of development by opposites, which applies the law of contrasts. Consult: Stumpf, *Tonpsychologie* (Leipzig, 1883); Riehl, *Der philosophische Kriticismus*, vol. ii. (ib., 1879-87); Preyer, *Elemente der reinen Empfindungslehre* (1877); Wundt, *Outlines of Psychology* (trans. Leipzig, 1897); id., *Physiologische Psychologie* (4th ed., ib., 1893); Höfding, *Outlines of Psychology*; Spencer, *Principles of Psychology* (London, 1881); Bain, *The Senses and the Intellect* (ib., 1868).

RELEASE. In the most general sense, any act, event, or instrument by which a legal right is discharged. In this sense of the term a right of action based upon a personal tort may be re-

leased by the death of the tortfeasor, or a debt released by the discharge in bankruptcy of the debtor, as well as a bond or a right of entry upon land released by the deed of the person claiming the right. Lord Coke, in his commentary upon Littleton, enumerates a considerable number and variety of releases in vogue in his day, most of which have, in the growing simplification of the law of real property, become obsolete. We may, perhaps, conveniently distinguish two separate and distinct types of releases as still existing, viz. the ordinary release of a debt or obligation and the release of an interest in or claim to land.

The former of these may be effected by act of the parties, or by operation of law—as where a contract for personal services is terminated by the death of a party thereto. At common law, however, the forgiveness of a debt, whether complete or partial, is not legally binding if made by parol or simple contract, but requires a release under seal to render it effectual and irrevocable.

The second form of release above referred to is best described as a form of conveyance of real property at common law. Its distinguishing characteristic is the fact that it is in and by itself not available for effecting a conveyance to a stranger, i.e. to one having no interest in the land in question (for which purpose the feoffment or the grant must be resorted to), but only to one in privity of estate, i.e. having an interest with the releasor in the same parcel of land, as a wife to the husband's grantee, or a landlord, remainderman, or person asserting any other claim in relation to the premises to a tenant in possession. The act of the tenant in giving up his estate to the landlord is not a release, but, involving as it does a transfer of the possession, is conceived of as of a totally different character, and is effected by a distinct form of conveyance, called a surrender.

In this form of a conveyance of the landlord's estate to his tenant in possession the release played a distinguished part in the history of conveyancing. In the effort to attain to a simpler and less notorious method of conveying freehold estates than the ancient and cumbrous process of livery of seisin, the lease and release were ingeniously combined in a single transaction. Thus, if the land to be sold by A to B was first leased to B for a year, B would by taking possession of the land come into the requisite privity of estate with A to enable the latter to complete the transfer of title by releasing his reversion to B. See Blackstone and Kent, *Commentaries*; and the authorities referred to under PROPERTY; LEASE AND RELEASE; CONVEYANCE; DEED; GRANT.

Analogous to the first form of release above described, but still operating as a common-law conveyance, is its use to convey doubtful or precarious interests in land or rights in land which do not rise to the dignity of estates, as a contingent remainder to the freeholder who was seized of the land, or the right of a disseisee to the disseisor or other person seized of the land. See DISSEISIN; ENTRY, RIGHT OF; REMAINDER.

In form the deed of release is substantially reproduced in the modern quitclaim deed. See QUITCLAIM.

RELIANCE. An American racing yacht, and the successful defender of the America's Cup in

the International yacht races of 1903. She was built by Herreshoff, for a syndicate of American yachtmen, represented by C. Oliver Iselin. Her measurements were: Length over all, 143.69; water line, 89.66; sail area as per rule, 16,159.45; sail area, 127.12. Owing to her large sail area she was required to give the challenger Shamrock III. (q.v.) a time allowance of one minute and fifty-seven seconds. She was sailed by Captain Barr, the skipper of the old Columbia, and defeated her opponent in the first three races of the series as follows: August 22d, by 7 minutes and 3 seconds, corrected time; August 26th, by 1 minute and 19 seconds, corrected time; September 3, the challenger got lost in the fog and did not finish the race. Reliance alone completed the course.

RELICS (OF., Fr. *relique*, from Lat. *reliquia*, remains, from *relinquere*, to leave behind, from *re-*, back again, anew + *linquere*, to leave, Gk. *λείπειν*, *leipein*, Skt. *ric*, to leave). In ecclesiastical usage, the remains of the bodies of saints; more loosely, objects connected with the earthly life of Christ or of the saints. At an early period miracles are described as connected with relics, as in the Old Testament (II. Kings xiii. 21). Saint Ambrose tells of a blind man's sight being restored by his touching the bodies of the martyrs Gervasius and Protasius, and similar wonders are detailed by other saints. Altars were early erected over the tombs of the martyrs, and the present practice of the Roman Catholic Church requires the inclusion of some relic or relics within every altar to be consecrated.

The veneration of relics found no important early adversary. One of the treatises of Saint Jerome, indeed, is directed against the objections of Vigilantius on this point; but even the Iconoclasts, while vehemently repudiating the use of images, admitted the veneration of relics, and, with the exception of the Waldenses, Wiclif, and some others, it was practically unchallenged until the sixteenth century, when Protestants generally repudiated it entirely as superstitious. The decree of the Council of Trent connects the question with the general one of the veneration to be paid to the saints, and regards the relics of the saints not as possessing any intrinsic virtue, but as instruments through which God bestows benefits on men. Various alleged relics of Mohammed and other Moslem worthies are preserved at Mecca, Medina, Constantinople, and other places; and several sanctuaries in India are supposed to be the resting-places of relics of Buddha. See SAINT; CROSS; HOLY COAT; PILGRIM.

RELICT PLANTS (OF. *relict*, from Lat. *relictus*, p.p. of *relinquere*, to leave behind). Plants of very restricted distribution, but formerly more widespread. For example, the big trees of California are the remnants of a former widely distributed group. The term may also be applied locally to species which belong to a former topographic condition when they were abundant. Naturally or artificially reclaimed swamps may yet retain isolated relict plants.

RELIEF (Lat. *relevamentum*). An incident of the feudal tenure of lands. It consisted in the obligation of the heir to redeem the land from the lord of whom it was held, in order to make good his right of inheritance. Unlike the

more burdensome incidents of wardship and marriage, it attached not only to lands held by knight's service, but was levied equally on the heir of socage lands. Originally of indefinite amount and depending largely on the arbitrary will of the lord, it was at an early period fixed and regulated by statute. Of all the incidents of feudal tenure, it had the longest life, not only surviving the gradual disappearance of military tenures, but being expressly saved in the statute of 12 Charles II. (1660), which abolished tenure in chivalry and relieved all tenures of their more burdensome incidents. The right of relief was never expressly abrogated, but it has fallen into desuetude in England, and there is no evidence that it was ever exercised in the United States. See FEUDAL TENURE; INCIDENT.

RELIEF SCULPTURE. That form of sculpture in which the objects represented project from the surface or background. In the fine arts the term relief is used to signify any projection of figures from the surface; it is so used in painting for the apparent projection of forms and masses from the background, in architecture for projection of decoration, and in a similar manner in ceramics, goldsmith's work, etc. The term is, however, mostly employed in reference to sculpture. Relief sculpture differs from sculpture in the round in that it is attached to the background, from which the latter stands free, being visible from all sides. It is not always possible, however, to distinguish the boundaries between these two chief classes of sculpture. See SCULPTURE.

The two principal varieties of relief sculpture are: high relief, usually known by the Italian name *alto-relievo* (q.v.), in which the objects project strongly from the background; and low relief (Italian, *basso-relievo*; French, *bas-relievo*), a surface ornamentation in which the projection is very slight. Midway between the two is semi-relief (Italian, *mezzo-relievo*; French, *demi-relief*), in which the figures are fully rounded, but without detached portions. *Stacciato* (Italian, crushed, flattened) is the slightest form of relief, being little more than scratchings upon the surface, while in the hollow relief (*cavo-relievo*) (q.v.) the contours of the figures are carved below the surface of the background. In nearly all relief work figures and background are of the same material, though there are some examples to the contrary in best Greek art, and in Chinese and Japanese decorative work. The materials generally used in larger relief work are marble, bronze and sometimes terra cotta, and in smaller decorative work the precious metal and stones, enamel, ivory, wood, etc., are more common. Reliefs were almost universally colored by the Egyptians and in classical antiquity and partly in early Christian art. This practice prevailed in wood, terra cotta and stucco work during the Gothic and Renaissance periods, while marble and stone were not usually colored.

HISTORY. Relief is that form of sculpture which most resembles painting, with which it has composition and perspective in common. In the history of relief work, therefore, the practice has swayed between purely plastic and pictorial principles. Relief was practiced contemporaneously with sculpture in the round by the early culture peoples, like the Babylonians, Assyrians, and Hittites. The Egyptians made a very wide use of *cavo-relievo*. The Greeks con-

ceived relief in a purely plastic sense and achieved the highest mastery of it. Distinguishing strictly between high and low relief, they used the former between the triglyphs, and in the tympana of the temples, but the latter in friezes, grave stones, and the like. Purely decorative principles were strictly followed, the space being adequately filled, the background never carved, and the heads of the figures at the same height. (See ISOCEPHOLY.) During the Hellenistic period a more picturesque and dramatic composition was practiced, and subjects were carved in the backgrounds—a practice which in Roman times degenerated into the use of several different planes of reliefs. Picturesque relief attained its most perfect development at Florence during the Renaissance, in such works as the Baptistery doors of Ghiberti and the marble pulpit of Santa Croce by Benedetto da Majano. In these works all the qualities of painting except color were reproduced. Donatello, Luca della Robbia and other sculptors of the Renaissance followed plastic laws more strictly, but during the entire Baroque period, picturesque principles prevailed to such an extent as to preclude any real style of relief. At the beginning of the nineteenth century Thorvaldsen, inspired by the study of Attic grave monuments, brought back reliefs to its proper plastic function. Since that time excellent relief work has been done in Europe by modern German sculptors like Rauch and Rietschel and by Frenchmen, like Jules Dalou, and also in the United States. The present tendency, however, is to neglect the distinction between high and low relief and to give rather undue emphasis to pictorial qualities.

RELIEF SYNOD. See PRESBYTERIANISM.

RELIGIO MEDICI (Lat., A Physician's Religion). A prose work by Sir Thomas Browne (1643). Written about 1635, but not for publication, which was necessitated by an unauthorized edition in 1642, this prose poem is the devout musing of a scholar and man of science, and withal a mystic, who sought a Divine presence in nature and in all conditions of his own life. The first part treats of Faith and Hope. The second, on Charity, shows a tolerance unusual in that day.

RELIGION (Lat. *religio*, probably from *re-ligare*, to bind fast, from *re-*, back again, anew + *ligare*, to bind), COMPARATIVE. The science which treats of religions from an historical and comparative point of view. Its methods are first descriptive, then historical, and finally comparative. The descriptive part of comparative religion discusses in detail the actual phenomena, or any particular phenomenon, presented by religions, and includes treatments of individual religions. Even in such an individual discussion, the comparative method must be employed if the phenomena presented by the religion in question are to be correctly interpreted. While the descriptive part of the science is confined, strictly speaking, to the statics of religion, that is, to the phenomena observable at any specified time, the historical aspect considers the development of a single faith from its origin or from its earliest ascertainable manifestation to its extinction, or absorption into other religions, or the latest development which it has attained. The historical side of comparative religion, therefore, is evolutionary in character. The com-

parative study in the strict sense of the term may, technically, be static. The value of such an investigation is, however, so much inferior scientifically to evolutionary comparison that it may practically be ignored. By far the greater number of investigations make their studies of comparative religion historical or evolutionary. Such discussions alone lead to the final object of the science. This object is to investigate the nature and development of religious beliefs and to discover if possible the origin of religion itself. Comparative religion therefore ranks as one of the historical sciences.

DEFINITION OF RELIGION. Nowhere is definition more difficult than in the sphere of religion. The manifestations are so varied, and the causes, where they can be traced, are so complex, that almost no definition of religion can be given which is altogether free from objection. The definition which seems on the whole least open to adverse criticism is as follows: Religion is the view held by man of an intelligent being or beings which is or are, or which he conceives to be, superhuman, and of the relation, modifiable by his own agency in certain respects and by certain means, which he sustains toward the being or beings in question. This definition recognizes the two-fold aspect of religion, which accounts for part of the complexity of religious phenomena, the theoretical and the practical. The theoretical side of religion is the view held by man regarding the nature and character of the superhuman being or beings in which he believes. The practical side is the power which such being or beings exert over him and the power which he has or may acquire over them.

UNIVERSALITY OF RELIGION. The statement which is still made, though with decreasing frequency, that there are races or tribes without religion is almost certainly false. It may be true that many peoples seem to possess no religion, either because these religions are so obscure as to pass unnoticed, or because they are contemptuously rejected as false. Yet even the scientific investigator may be misled in this matter. In the first place, the person questioned as to his religion may not, and in the case of savages often does not, understand the questions which are asked him. His answers, therefore, are misleading. It must also be remembered that one questioned concerning his religion will sometimes willfully give a false answer, either because he regards the inquiry as foolish, impertinent, or tiresome, or because he does not dare to reveal his religion. In giving a knowledge of his religion, one gives a part of himself, and the power thus gained by another may be used to his own detriment. If these obstacles to an accurate knowledge of a religion exist in the case of living faiths, they hold to a far greater degree in the study of extinct religions or extinct phases of them. The ancient writers who describe foreign religions were either little acquainted with them and unscientifically trained, as were even Herodotus and Plutarch, or were contemptuous and unsympathetic, as was Tacitus. Moreover, the sacred books of religions give us only a partial view of their own faiths. They represent only the officially sanctioned religion, while the popular deviations from these book-religions are either ignored altogether, or mentioned with disparagement and hostility, or must be partially reconstructed

from chance allusions scattered through the canonical works. There is also a marked tendency both in ancient and in modern investigators of religion to interpret foreign religions in terms of their own, thus leading to false identifications and to attributions of concepts to religions which they may not contain. The student of religion must also guard against mistaking an idea previously imported into a religion from a foreign source for an integral part of the faith which he studies.

CLASSIFICATION OF RELIGIONS. Still more difficult than definition of religions is classification. While one may make rough distinctions between various religions, hard and fast lines of demarcation can seldom be drawn, for religions often overlap one another in attributes common to both. Nor is it easy to classify a religion according to its salient feature. To say that Greek religion is the cult of the beautiful, or that Roman religion is legalistic, or that American religions are animistic, does not adequately describe them, for they represent the culminations of long evolutions, in which many factors from many sources have coöperated. Animism, totemism, ghost-worship, nature-worship, and other factors, all combine in different proportions. Several classifications, however, have been proposed. Of them all, the most simple and the most worthless divides religions into true and false, the first class holding the single religion adopted by him who makes the classification, the latter class containing all the rest. There are a number of other classifications which are equally unsatisfactory. Among these may be enumerated the division of religions on a linguistic basis into Indo-Germanic, Semitic, and Turanian. This classification, proposed by Max Müller, proceeds on the false premise that religion and linguistic affinity are one. A religion may indeed originate in a certain race, but it may spread with equal facility to other races, and even to other climates and entirely different systems of civilization. The division into national and universal or international religions, advocated by Kuenen, is also objectionable, since there is no real line of demarcation between the two. Comparatively primitive religions may be international, on account both of their catholicity and of the absence of any national idea, while very advanced religions, as Zoroastrianism, may be strictly national, although apparently intended to be international in scope. Hegel attempted a classification, in four divisions. The most primitive faiths, or nature religions, he regarded as spontaneous. To them he opposed the religions of spiritual individuality, which was differentiated from nature religions by the presence of reason and meditation. Within the religions of spiritual individualities there are three divisions: First, the religion of majesty, where the divine overwhelms the human; second, the religion of beauty, where the divine blends with the human; and third, the religion of design, where a divine purpose in the universe is recognized. The increased knowledge of the evolution of religion since Hegel's time has rendered this view of his useless. A marked advance was the classification of Hartmann, who made a broad division into naturalism and supernaturalism. Naturalism is characterized by a belief that deities rule in the world and require material representations, while in supra-

naturalism the deities rule over the world, and are freed from the necessity of representation. In the former class are primitive religions and such advanced ones as the Greek, Roman, Teutonic, and Egyptian, while in the second category come, among others, Buddhism, Judaism, and Mohammedanism. The final stage is a monism where the absolute spirit is a unity which is the absolute source and being of the universe. The chief weakness of the system is the tendency already noted to characterize religions only by salient features, without taking into account phases equally important though less obtrusive. A classification which combines the historical and philosophical points of view was prepared by Réville. Making a broad division into polytheistic and monotheistic religions, he included in the first category primitive nature religions, animism, and fetishism. These were followed by national mythological religions, such as the Chinese, Egyptian, Babylonian, Teutonic, Celtic, Greek, and Roman. The fourth stage is characterized by the legal element, as seen in Brahmanism, and here he also reckoned the Chinese systems of Confucius and Lao Tse. The highest point of polytheism was reached in his opinion by Buddhism. The monotheistic religions, which compose his second main division, are Judaism, Mohammedanism, and Christianity. Against this classification may be alleged that (1) there is no such sharp dividing line between animism, fetishism, and mythology as is here implied, and (2) the demarcation between polytheism and monotheism is evanescent. In the religions of Egypt, Babylonia, India, and Greece, which were admittedly polytheistic, a monotheistic trend, especially among philosophers, was marked, and conversely, in religions essentially monotheistic, such as Zoroastrianism, there is a tendency toward reversion to or survival of polytheistic cults. The important step in advance in Réville's classification is his recognition of the importance of the legal factor. Tiele set up a scale of primitive, naturalistic, animistic, national, polytheistic, nomistic, and universal religions. This scheme later was somewhat modified by him, and he finally favored a division into nature religions and ethical religions. Still another classification was proposed by Jastrow. Its division is fourfold, into the religions of savages, of primitive culture, of advanced culture, and those religions whose conscious ideal is the coextensiveness of religion with life and complete harmony between the doctrines and the practices of religion. This classification, like the others, is unclear in the distinction between the first two divisions, while the third and fourth in like manner are somewhat arbitrary. It seems, however, superior on the whole to all its predecessors, despite the credit which the classifications of Tiele and Réville deserve. Adopting this system of Jastrow's, then, with the modification of combining his first two divisions, the broad outlines of the principal forms of religion may be sketched, while the detailed treatment both of individual religions and of numerous special phases of comparative religion will be found under separate titles.

THE RELIGIONS OF SAVAGES AND OF PRIMITIVE CULTURE. The religion of the savage, connoting by this term man in the pre-cultural stage, is almost impossible to determine. The difficulties already enumerated oppose the solution of this

problem. It is, moreover, a question whether pre-cultural man, uninfluenced by cultural races, however primitive, now exists. Only within comparatively recent times has the intercommunication of ideas between the less civilized races both of ancient and modern times received due recognition. Even the most primitive religions known, such as the Australian, belong to tribes which have begun the cultural stage. We are reduced, therefore, for our knowledge of savage religions to deductions which may be made from more advanced cults, especially those of primitive peoples. This uncertainty is the more unfortunate, since it is here if anywhere, from a scientific point of view, that we are to seek the origin or origins of religion. The most that can be said of this most primitive stage seems to be that there was probably an innate germ of religious thought, a vague personification of the powers of nature, and the first beginnings of a belief in ghosts.

Turning to the religions of primitive culture, we find a wide range of cults in all parts of the world, of most varied grades. Among the most important may be mentioned the Polynesian and Australian, the diverse native religions of Africa, the Finno-Tataric, many phases of Hindu religion, especially among the Dravidians, the Mongolian Shamanism, the ancient Teutonic religions, and the American religions, including those of Mexico and Peru. The diversity of the primitive cults is evident, ranging from the rude religions of the Hottentots and Blackfellows to the elaborate mythology of Polynesia and the developed ritual and priesthood of Mexico. The religions of primitive culture, however, may all be characterized by at least four points in common: animism in belief, magic in practice, and in worship nature-worship and ancestor-worship. Of these the most primitive seems to be animism. This may be defined as a belief which ascribes conscious life to every natural object which manifests vitality or force in any way. It is the theory evolved by primitive man to account for the various natural phenomena by which he is surrounded. The ascription of life analogous to his own to trees, rivers, fire, and the like is not necessarily religious in itself, but the transition from animism in theory to animism in cult seems to involve a recognition of their superhuman powers. If a river is endowed with life as is a man, it has power to benefit, as in irrigation, or to injure, as in flood, and it becomes necessary either to propitiate the river that it may be bounteous in its waters, or to induce it to refrain from destructive floods. The primitive means of controlling the powers of nature is by magic. If the desired results do not follow the performance of magic, the fault is not with the magic itself. Either wrong magic has been employed for the end in view, or there is a strong counter-magic at work, which must first be overcome if possible. For magic is, in its last analysis, the science of primitive man, the cause, real or supposed, of a given result, which must, by its performance, produce again the desired result, and this fact accounts for its early importance and its extreme tenacity.

Within the sphere of religion proper we have, as common to all religions of primitive culture, nature-worship and ancestor-worship, the developed forms of the beliefs in animism with magic and ghosts with magic respectively. To

this same stage of development belong some of the most important aspects of religion. As an evolution of ghost-worship comes the belief in totemism, which derives whole tribes or families from an animal or plant. This animal or plant is consequently regarded as a blood-relative of the tribe or family in question, and therefore becomes sacrosanct, so that it is neither eaten, killed, nor harmed in any way by one whose totem it is. Another mixture of magic and animism is seen in fetishism, which ascribes superhuman properties to material objects. Developments of magic are seen in the important phenomena of taboo and Shamanism. To this same period belongs the evolution of the priest. While the savage was able to perform his own religious rites, the increase both in number and complexity of sacrifices and magic rites rendered necessary the presence of a body of men who stood in especially close relations with the superhuman beings, and who came in course of time to have entire control both of cult and religion. As intermediaries between the gods and men, the priests naturally came to be regarded as healers of disease by their magic arts, and the knowledge of medicine was, consequently, practically in their possession alone throughout this period and at least the earlier portion of the succeeding one.

THE RELIGIONS OF ADVANCED CULTURE. In the religions of advanced culture, which, as has already been said, are closely connected with those of primitive culture, are contained the religions of Egypt, Babylonia and Assyria, China, India (excluding Buddhism), Greece, and Rome. It is at once obvious how varied are the spirits of these religions, yet there is one common factor which may serve to characterize them all, and which may, at the same time, be made a line of demarcation between the faiths of advanced and of primitive culture. This factor is the predominance of mythology over animism and magic. While the mythological element is of importance in many of the religions of primitive culture, and while it is seen at a comparatively early stage, it is overshadowed by animism and magic, and plays relatively little part. Even in the most highly developed religions of this class, such as the Polynesian, which has a mythology almost rivaling that of the Greeks, this statement holds good. On the other hand, while the religions of advanced culture, especially the more ancient ones of Egypt and Mesopotamia, contain abundant traces and instances of animism and of magic, even in their early epochs the mythology is the most striking feature. Mythology in itself is a process and a proof of higher culture. Based in part on early tribal history and ancestor-worship, as may clearly be seen in the case of Greece and Rome, and in part on nature-worship, as is evident in India, it involves a power of abstract thought beyond the capability of primitive culture in its early stages. But, on the other hand, mythology is a check on religious growth. As the people progresses in religious life and thought, while mythology, like ritual, remains stationary or moves much more slowly than the actual popular religious faith, a constantly widening gap appears between religion and mythology. As in the religions of primitive culture the animism and magic which characterize them in their earlier stages become relatively less important

in their later developments, so in the religions of advanced culture the mythology which is at first their leading feature becomes more and more secondary in course of time. In many instances in a more refined community the old myths are felt to be immoral. Attempts are, therefore, made to explain away this immorality, to which the masses still cling tenaciously, by poetical, allegorical or esoteric interpretations as in the explanations of the erotic Krishna myths in India as mystic portrayals of divine love. Yet these explanations are in the nature of the case, inadequate, and there is thus created a division between religion and ethics, which it is the task of the next and final stage of religion to bridge over.

The priesthood undergoes a marked change in the religion of advanced culture. In the previous stage the priests had been little more than go-betweens between men and gods. With the fuller development of religions ideality, however, their place became more truly spiritual. Not alone did they conserve the rites and doctrines of religion, but they became the censors of morals as well, and in the course of time they made the important step of giving a legalistic form to religion as distinguished from its merely ritualistic aspect. Yet side by side with the religions thus officially recognized which prevailed in Babylonia and Assyria, Egypt, Greece, and Rome, and which still prevail in China and India, there was, and is, a vast amount of religion officially unrecognized. This, expressed both in belief and custom, is regarded by the religion which is formally acknowledged as superstitious. The attitude toward it, however, is one rather of contempt than of hostility. Gradually the feeling seems to have gained ground that such a distinction between religion and superstition was distinctly injurious. More and more it became evident that religion, which was outgrowing the beliefs of animism and even of the more tenacious magic, could and must progress still further. The next step marks the transition to the religions of the last type, the highest that has thus far been evolved.

RELIGIONS COEXTENSIVE WITH LIFE. Within this class fall the religions of Judaism, Buddhism, Zoroastrianism, Mohammedanism, and Christianity, with a few minor representatives, such as Mormonism. These represent, as already stated, the conscious attempt to render religion and life coextensive, whereas the religions of primitive culture had assumed them to be one, and the religions of advanced culture had finally divorced them. They thus attempt to create final harmony between religious doctrine and religious practice. There is no longer a tacit admission of the usefulness of superstition, such as exists in the religions of advanced culture, but since everything in the spiritual world not with religion is now seen to be against it, there is a deliberate resolve to annihilate all such extrareligious forces. More than this, not alone are the lower forms of religion existing within itself regarded as hostile, but all other religions are considered as lower, and therefore to be suppressed. It is an important fact that each of the five religions in this class regards itself as true and the other four, together with all lower religions of whatever sort, as false. Herein lies one of the chief characteristics of the class. The religions coextensive with life are exclusive, all

others are inclusive. Another distinction between the two types lies in the fact that if the earlier is ethical and legalistic, the latter is spiritual. The religions coextensive with life lay more weight on the spirit of man in its relation with the divine, and less, relatively speaking, on cult and ritual. A striking example of this is seen in the origin of Buddhism, which is essentially a revolt from the excessive rituality of Brahmanical Hinduism toward a deep spirituality with, in its pure form, almost no cult. As the maintenance of a priesthood is conditioned in a great measure by an elaborate cult, it is obvious that in this final type, conspicuous for simplicity of ritual, the priest occupies a far less important position than in the religions either of primitive or advanced culture. This affords in part the explanation of the fact that the reforms which have resulted in religions of the highest type have been made in every case by individuals outside the priestly code, by the Hebrew Prophets, by Buddha, Zoroaster, Mohammed, and Jesus. Nor is this in any way a reproach to the priest. For he is in the nature of things a conserver, not an inaugurator, and rightly so, and if in some instances he is shown by the results to have been over-cautious, he is not thereby to be convicted either of dishonesty or of ignorance. Finally, religions of this class go further than the individual or than the State, herein contrasting sharply even with the religions of advanced culture. They aspire to be world-religions, and three of them, Buddhism, Mohammedanism, and Christianity, are in fact the leading religions in numbers and extent. We have in this aspiration yet another characteristic distinction between the religions coextensive with life and all other forms of religious cult.

HISTORY OF THE STUDY OF COMPARATIVE RELIGION. The study of comparative religion is of modern origin. It is indeed true that we find in the histories of Herodotus, in the *De Iside et Osiride* of Plutarch, in the *De Dea Syria*, generally ascribed to Lucian, in the *Germania* of Tacitus, and in brief mention in numerous other classical authors accounts of religions other than Greek or Roman. Yet here, as might be expected, the historic knowledge was too slight to render the philosophical part of the work anything but superficial, although the descriptive part is still of value. The general attitude of the Greeks and Romans, who alone of the ancient world touched the subject of comparative religion, is one of contempt. This was succeeded by a not unnatural intolerance in the attitude of the Church Fathers and mediæval theologians. This attitude remained practically unchanged until the rise of skepticism in the eighteenth century. Yet there was no real progress in the study of religion, for dogmatism was succeeded by superficiality. It is noteworthy that the first real impulse to an historical study of religions came with the sixteenth and seventeenth centuries. To this early period belong such books as the *Pantheia*, or *View of All Religions in the World*, of Ross (London, 1653), and the *Ceremonies and Religious Customs of the World*, of Picart and Bernard (ib., 1733). This latter work is in a sense the forerunner of the historical method of religions study, and is far superior to one of its most important successors, the *Origine de tous les cultes ou religion universelle* of Dupuis

(Paris, 1795). The real founder of the historical school, however, was Herder, who outlined the history of religion, so far as it was then possible, in his *Ideen zur Philosophie der Geschichte der Menschheit*, published in 1784, although his previous writings indicate that many of his ideas on this subject had been formulated much earlier. The year after Herder's *Ideen* saw the publication of Meiners's *Grundriss der Geschichte aller Religionen*, followed twenty-one years later by his *Allgemeine kritische Geschichte der Religionen*. In the decade 1821-31 the foundations of a scientific philosophy of religion were laid by Hegel in his *Vorlesungen über die Philosophie der Religion* (not published, however, until 1832). The credit of inaugurating the study of comparative religion in a truly scientific spirit and method, however, must be given to Max Müller, even though his views are now in great part rejected in the light of later investigations. In a long series of volumes, including *Lectures on the Science of Religion* (London, 1872), *Natural Religion* (2d ed., ib., 1892), *Physical Religion* (ib., 1890), *Anthropological Religion* (ib. 1891), and *Theosophy or Psychological Religion* (2d ed., ib., 1899) he developed his system. He also aided in the establishment of the Hibbert Lectures on the Origin and Growth of Religion in 1878, and above all founded in 1879 the epoch-making series of translations entitled *The Sacred Books of the East*. A still greater name than Max Müller's is that of Tiele, of Leyden, whose *Outlines of the History of Religion* (translated from his Dutch *Hoofdtrekken der Godsdienstwetenschap* into English by Carpenter, London, 1877, 3d German ed. by Weber and Söderblom, Breslau, 1903) is by all odds the best general survey of religions from an historical and descriptive point of view, while his *Elements of the Science of Religion* (Edinburgh, 1897-99) and his *Geschiedenis van den Godsdienst in de oudheid tot op Alexander den Groote* (Amsterdam, 1891-97) are no less authoritative. In France the study of comparative religion received a powerful impetus in the establishment in 1888 of the Musée Guimet. In America there is as yet little general interest in this science, although signs are not lacking that comparative religion will receive here also the attention which it merits both from a theoretical, an historical, and a practical point of view. The activity in the science, despite the lack of recognition on the part of many universities and the unfounded suspicion with which it is viewed by certain classes even of the educated, is most promising, among the eminent investigators being Réville, of France; Saussaye, of Holland; Achelis and Edmund Hardy, of Germany; Tylor and Frazer, of England; and Toy and Jastrow, of America.

BIBLIOGRAPHY. The bibliography of comparative religion is very extensive. Among general works some of the most important are, in addition to those already mentioned: Lichtenberger, *Encyclopédie des sciences religieuses* (12 vols., Paris, 1877-83); Saussaye, *Lehrbuch der Religionsgeschichte* (2d ed., Freiburg, 1897, contains also bibliographies); Orelli, *Allgemeine Religionsgeschichte* (ib., 1899); Jastrow, *The Study of Religion* (New York, 1901, contains an excellent bibliography); Tiele, *Kompendium der Religionsgeschichte* (3d German ed., Breslau, 1903, containing abundant bibliographies). For

the philosophy of religion reference may be made to Caird, *Introduction to the Philosophy of Religion* (2d ed., London, 1889); Hartmann, *Religionsphilosophie* (Leipzig, 1888); Lotze, *Grundzüge der Religionsphilosophie* (ib., 1882, Eng. trans. by Ladd, Boston, 1885); Pfeleiderer, *Philosophy and Development of Religion* (Eng. trans., Edinburgh, 1899); Sabatier, *Esquisse d'une philosophie de la religion d'après la psychologie et l'histoire* (6th ed., Paris, 1901, Eng. trans., London, 1897); Siebeck, *Lehrbuch der Religionsphilosophie* (Freiburg, 1897). As additional general manuals may be mentioned: D'Alviella, *Introduction à l'histoire générale des religions* (Brussels, 1886); Jevons, *Introduction to the History of Religion* (London, 1896); Réville, *Prologomènes de l'histoire des religions* (Paris, 1881, Eng. trans. by Squire, London, 1884). Special topics of importance are treated in Frazer, *Totemism* (London, 1887); id., *The Golden Bough* (2d ed., ib., 1900); Hartland, *Legend of Perseus* (ib., 1894-96); Lang, *Myth, Ritual, and Religion* (2d ed., ib., 1899); id., *Magic and Religion* (ib., 1901); Taylor, *Ancient Ideals* (New York, 1896); Réville, *Les religions des peuples non civilisés* (Paris, 1883, with bibliographies); Tylor, *Primitive Culture* (2d ed., London, 1878); Roskoff, *Religionswesen der rohesten Naturvölker* (Leipzig, 1880). The two most important periodicals devoted to comparative religion are the *Revue de l'histoire des religions* (Paris, 1880 et seq.), and the *Archiv für Religionswissenschaft* (Freiburg, 1898 et seq.). Discussions of individual religions not treated under special titles are contained in Réville, *Religions du Mexique, de l'Amérique centrale et du Pérou* (Paris, 1885); Abeghian, *Armenischer Volksglaube* (Leipzig, 1899); Leger, *Mythologie slave* (Paris, 1901); D'Arbois de Jubainville, *Le cercle mythologique irlandais et la mythologie celtique* (ib., 1884); Rhys, *Celtic Heathendom* (London, 1886). See also BUDDHISM; CHINESE EMPIRE, section on *Religion*; CONFUCIUS; DEMONOLOGY; DRUID; EGYPT, section on *Religion*; FETISHISM; GHOSTS; GREEK RELIGION; INDIA, section on *Ancient Religion*; JAINISM; MAGIC; MEXICAN ARCHÆOLOGY; MOHAMMEDANISM; MYTHOLOGY; NATURE WORSHIP; PERSIAN MYTHOLOGY; PERUVIAN ANTIQUITIES; PHALLCISM; PRIEST; ROMAN RELIGION; SACRIFICE; SHAMANISM; SHINTO; SUPERSTITION; SWASTIKA; TABOO; TAOISM; TEUTONIC AND SCANDINAVIAN MYTHOLOGY; TOTEMISM; ZOROASTRIANISM; and the bibliographies and cross-references under these titles.

RELIGIOUS EDUCATION. See SCHOOLS.

RELIGIOUS ORDERS. See ORDERS; MONASTICISM.

RELIGIOUS SOCIETIES. In a legal sense, those corporations formed for the advancement of religion or the administration of church property for religious purposes. To the efforts of religious corporations in the Middle Ages to acquire vast holdings of land was due the enactment of the various Statutes of Mortmain (q.v.). Most of the States of the United States now have general laws governing the formation of religious corporations and defining their powers. Generally there is no limit to their power of acquiring land for church purposes and all their property used directly for church or religious purposes is exempt from taxation. See COR-

PORATIONS; CANON LAW; and compare CIVIL CHURCH LAW and CLUB.

RELIQUARY (ML. *reliquare*, *reliquarium*, from Lat. *reliquia*, remains). A case or box to contain relics. Reliquaries are made of all kinds of materials, such as wood, iron, stone, ivory, silver, enamel, gold, and crystal, and are frequently ornamented with costly jewels. Shrines are of the same description, but are on a larger scale and are permanent. As a class they are the most consummate masterpieces of mediæval minor artists, especially among the metal-workers. Some of the cathedral and church treasuries still possess numerous mediæval reliquaries, for example, San Marco at Venice, and the cathedrals of Aix-la-Chapelle and Cologne. The reliquary in the form of a church at the Cathedral of Orvieto is one of the most wonderful pieces of thirteenth-century goldsmith work, with exquisite details. The Romanesque and Gothic periods were the golden age of such work (eleventh to fifteenth centuries). At first the Rhenish and Flemish schools were easily pre-eminent, but in the thirteenth century Italy and France surpassed the northern schools. Reliquaries were of many shapes. They often took the form of the relic they contained, such as a hand, a foot, or a head. They were nearly always decorated with minute figures in relief or even statuettes, or with colored enamels and ornamental designs. The Renaissance led to a complete decadence.

RELIQUES OF ANCIENT ENGLISH POETRY. A collection of old ballads and lyrics (1765), taken by Thomas Percy from an old manuscript of the early seventeenth century, which he found at a friend's house in Shiffnal, Shropshire. These ballads he altered and polished to suit the taste of his age, for which he was severely criticised. Ritson charged Percy with forged and garbled versions of many ballads, and even questioned the existence of the manuscript. This, however, was proved by an edition from the original in 1868 by Hales and Furnivall. In spite of Percy's inaccurate and unscholarly work, the *Reliques* has been a source of pleasure for generations and marks the revival of taste for romantic poetry.

RELY, JAMES' (c.1722-78). A Universalist minister. He was born at Jeffreston, Pembrokeshire, Wales, was converted under Whitefield in 1741, and became an itinerant Methodist preacher. Being convinced that Universalism was true, he parted company with the Methodists, and preached independently in various places. In 1761 he settled in London and preached there, without much success. It was, however, under him that John Murray (q.v.), the Apostle of Universalism in the United States, was converted.

REMAINDER (OE. *remaindre*, remain, from Lat. *remanere*, to remain, from *re*, back + *manere*, to stay). The fee tail, the life estate, and the term of years are conceived of as being less in quantity than a fee simple (see ESTATE), and the gift of such an estate leaves something—some part of the fee simple—undisposed of, which may remain, or revert back, to the grantor (in which case it is called a *reversion*), or may be given by the same deed which creates the lesser estate to a third person as a *remainder*. There may, indeed, be any number of remainders, one

after the other, until the entire fee simple has been disposed of, as, for example, after a present, or 'particular,' estate to A for life, remainder to B for life, remainder to C for life, remainder to D in fee tail, leaving still a fee simple to be given to E as a final remainder, or to come back to the grantor as a reversion. A remainder thus given to an ascertained person, ready to go into effect upon the determination of the precedent estate, is said to be *vested*. If given to an unborn or unascertained person, or upon a further contingency (as, when B shall return from abroad), it is a *contingent* remainder. Such a remainder was at common law scarcely of sufficient importance to be regarded as an estate at all. It was incapable of alienation to a stranger and was liable to be extinguished by the accidental or deliberate determination of the precedent estate before the contingency had happened on which the remainder was to vest. But modern legislation has given the contingent remainder much of the definiteness and permanence of the vested remainder by freeing it from this dependence upon the precedent estate.

Though classified as a future estate, a remainder is conceived of as a present interest and as capable of being dealt with as such by the owner thereof. It may thus be alienated like any other property (though, being 'incorporeal,' it has always required a deed of grant to convey it), and, being real property, it will, if a remainder in fee, descend to the heirs of the owner. Although efforts have been made in some of the United States to wipe out by legislation the distinction between remainders and other future estates, these have not completely succeeded, and the distinction is still of fundamental importance in this country as well as in England. See ESTATE; FUTURE ESTATE; PROPERTY.

Consult: Digby, *History of the Law of Real Property* (Oxford, 1875); Fearne, *The Law of Remainders*; Leake, *Law of Property in Land* (London, 1874); Blackstone and Kent, *Commentaries*.

REMAINDER THEOREM. An algebraic principle of great service in factoring. The theorem may be stated thus: If $f(x)$ is a rational integral algebraic function of x , then the remainder arising from dividing $f(x)$ by $x - a$ is $f(a)$. Since the dividend equals the product of the quotient and the divisor plus the remainder, we have $f(x) = q(x - a) + r$, and if $x = a$, the equation becomes $f(a) = r$. Similarly the remainder arising from dividing $f(x)$ by $x + a$ is $f(-a)$. When the remainder is zero the division is exact, hence the divisor is a factor of the given function. E.g. $x^n + y^n$ is divisible by $x + y$ when n is odd, since the remainder $(-y^n + y^n) = 0$. The rational binomial factors of functions above the second degree are readily determined by use of the remainder theorem and synthetic division. E.g. to factor $a^3 - 6a^2 + 11a - 6$, it is only necessary to substitute, for a , factors of the absolute term -6 . Using detached coefficients (see COEFFICIENT), the division by $a - 1$ may be performed thus:

$$\begin{array}{r} 1 - 6 + 11 - 6 \\ \underline{1 - 5 \quad 6} \\ 1 - 5 + 6; 0 \end{array}$$

Whence the factors are $(a - 1)(a^2 - 5a + 6)$ or $(a - 1)(a - 2)(a - 3)$.

REMAK, rā'māk, ROBERT (1815-65). A distinguished German physiologist and embryologist, born at Posen. He studied at Berlin; in 1847 was privat-docent at Berlin, and was elected professor extraordinary in 1859. Besides important work on the physiology of the nerves, he, with Koelliker, further elaborated the germ-layer theory. His chief embryological work was *Untersuchungen über die Entwicklung der Wirbeltiere* (1851-53).

REMBRANDT, rēm'bránt, properly REMBRANDT HARMENSZ VAN RIJN, hār'mēns vān rīn (1606-69). The chief master in painting and etching of the Dutch school. The date of his birth is disputed, the most probable conclusion being that he was born at Leyden, July 15, 1606. His father, Harmen Geritsz van Rijn, a well-to-do miller, sent him to a Latin school, preparatory to the university, but finally permitted him to follow his inclinations for painting. After studying with his relative, Jacob van Swanenburgh, at Leyden, he was for six months a pupil of Pieter Lastmann at Amsterdam, from whom he learned the technique of etching, and whose influence was decisive upon his art. He was a very precocious genius, and upon his return to Leyden he soon acquired a high reputation. About 1631 he removed to Amsterdam, where he speedily became the most fashionable portrait painter, and had many pupils. Among his patrons were Frederick William, the Prince of Orange, and Burgomaster Jan Six; the foremost men of the day, like the poet Jeremiah Decker and Constantin Huygens, were his friends and associates. He bought a fine house in the Breedstraat, which he equipped with quaint costumes, weapons, and the like, and which contained his remarkable art collection, especially rich in old Netherlandish prints. He possessed paintings of Giorgione, Raphael, Michelangelo, and even antique sculptures.

A very important event in Rembrandt's life was his marriage in 1634 with Saskia Uylenburgh, a young lady of wealthy and influential Amsterdam family. Their happy married life was the inspiration of many of his best works. After her death in 1642, he drew back even more from the world, especially after his financial misfortunes, which censorious biographers have ascribed to dissipation and extravagance. But although it is true that he expended a large sum upon his art collection, his misfortunes are rather to be ascribed to the hard times then prevailing in Holland, and to the change in public taste. In 1657 his creditors sold his wonderful collection, including several of his own paintings, for the pitiful sum of 5000 florins, and in 1658 his house for 11,000. But Titus, Saskia's son, and Hendrickje Stoffels (or Jaghers), a young woman who had become his housekeeper in 1649, formed a partnership for the disposal of Rembrandt's pictures, and rented a house in the Rozengracht, paying the artist a stated yearly salary. After ten years of toil the old artist satisfied his creditors. The stories of his dissipation and low associates in later life are unfounded. His chief associates were artists and he was interested in the inhabitants of the Ghetto; but he also had more influential friends, like Jan Six. Hendrickje died in 1664, leaving a daughter Cornelia, and Titus in 1668. Rembrandt himself was buried in the Westerkerk, Amsterdam, on October 8, 1669.



REMBRANDT
"THE SYNDICS OF THE DRAPERS," FROM THE PAINTING IN THE RYKS MUSEUM, AMSTERDAM

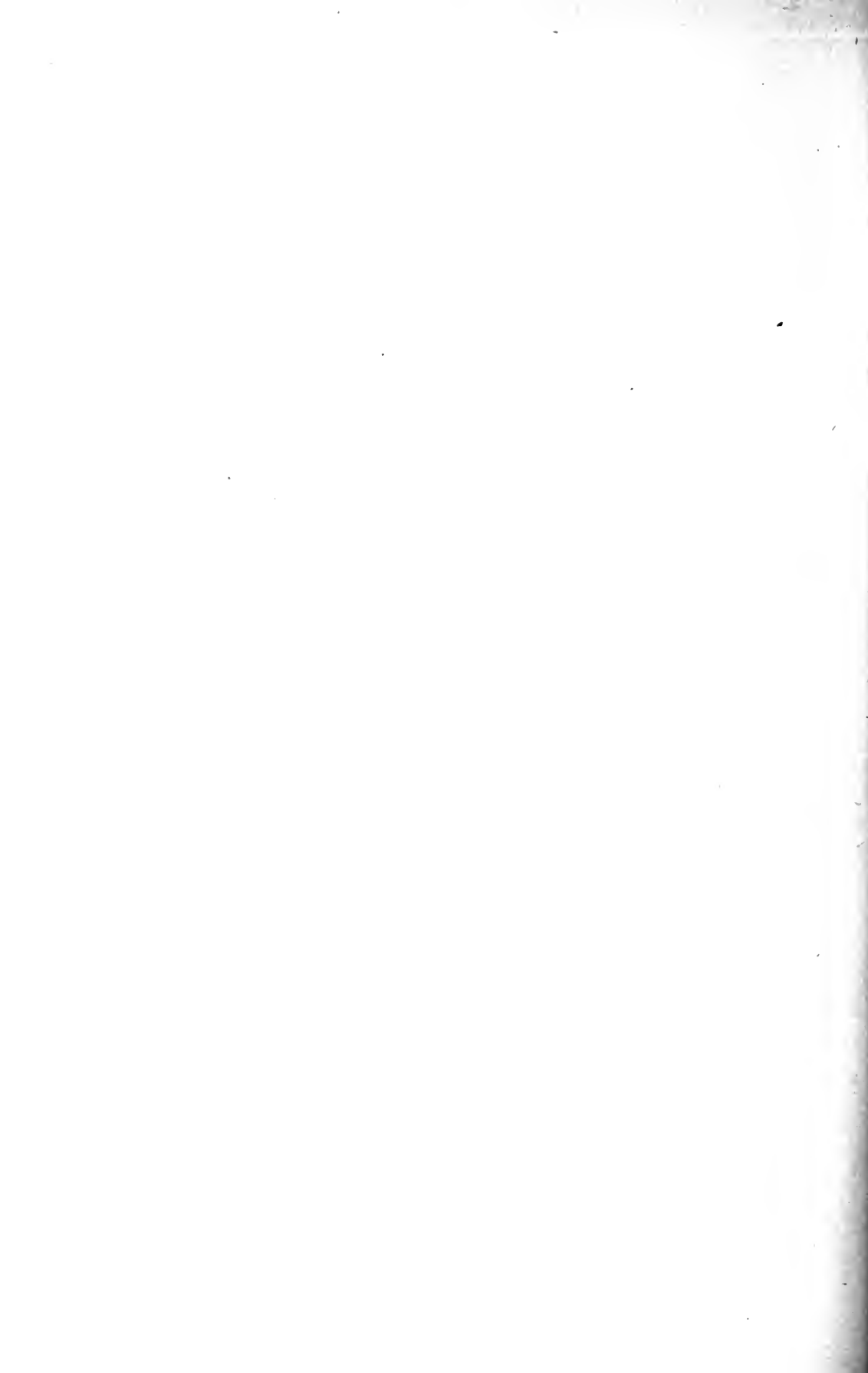

The world has never produced a more original artist than Rembrandt. In theory and in practice he was the great antipode of what was considered the standard art of his day—the Italian. He knew no model, except nature. His conception of nature was essentially poetic and picturesque, but at the same time virile. The most prominent technical characteristic of his work is a marvelous rendition of light, through which he emphasized the important part, leaving the rest in luminous shadows. At first he painted in full light, but after 1633 he preferred the inclosed light of the studio. Everything appears in subtle harmonies of gold and brown. His early pictures are painted with detailed execution and light color; but he increasingly uses a broader brush and richer color, and later in life his painting becomes highly impasto, almost decorative in character. He exercised great influence upon the art of his day, and a more lasting one upon the art of the nineteenth century. Among his many pupils were Gerard Dou, Govaert Flinck, and Ferdinand Bol.

Rembrandt was preëminent in portraiture, and no artist has succeeded better in rendering the head in a realistic, characteristic, and at the same time in a picturesque manner. Among his numerous portraits, perhaps the most interesting are those of himself and of his wife, Saskia. A charming picture is that of the young couple in an affectionate position at breakfast. The best known examples of Rembrandt's portraits are those of 1633, 1634, and 1637 in the Louvre; of 1635 in the Liechtenstein Gallery, Vienna, and in the National Gallery, London; of 1641 in Buckingham Palace. In later life he painted those in Munich (1658), National Gallery (London), and several in English private possession. The best known portraits of Saskia are at Dresden and Cassel; of Hendrickje Stoffels at Berlin; of his mother in Windsor Castle; of his son Titus and of his sister in the Imperial and Liechtenstein galleries, Vienna. Among other famous portraits are: a "Money Changer" (1627, Berlin); the "Polish Nobleman" (1631, Saint Petersburg); the poet Krul (1633, Cassel); the "Mennonite Preacher Aanslow Consoling a Woman" (Berlin Museum); the so-called "Frame-Maker" (Havemeyer Collection, New York, 1640); "Burgomaster Paneras and His Wife" (1645, Buckingham Palace); "Jan Six" (1654, Amsterdam); the "Ship Architect and His Wife" (in possession of the King of England); the so-called "Jewish Bride" (Amsterdam); and the "Architect" (1656, Cassel). Of his "Rabbis" a fine example is in Buckingham Palace; of his numerous "Old Women," the best known are in London and Saint Petersburg. Examples of his work may be seen in this country in the Metropolitan Museum, New York.

Rembrandt's most ambitious efforts in portraiture were groups similar in character to those of Hals. The masterpiece of his earlier full-light treatment is the well-known "Anatomical Lecture" (1632, The Hague). It represents the anatomist Nicholas Tulp, who ordered the picture, making a post-mortem examination before a group of his associates. The heads are wonderfully expressive, and the dead body is treated in a manner at once realistic and delicate. On a still larger scale is his masterpiece of the second period, painted for the Town Hall and now in

the Amsterdam Museum. The fine treatment of *chiaro-obscur* created the erroneous opinion that it represented a "Night Watch," by which title it is generally known, but it is, in reality, a portion of the civic guard issuing forth in broad daylight. His third chief work of this character is "De Stallmeesters" (1662), a representation of the presidents of the clothiers' guild, in the same museum—simple and harmonious in treatment, and showing the more sombre coloring of his last period.

Like the Italians of the fifteenth century, Rembrandt depicted religious subjects in apparel of the day, and chose especially the inhabitants of the Ghetto in their picturesque Oriental costumes. They are characterized by high dramatic power, and by deep religious feeling, of that homely and effective kind typical of the Dutch Calvinistic Church. Among the principal examples are the "Presentation of Christ in the Temple" (1631, The Hague); the "Descent from the Cross" (1633, Munich); "Samson Threatening His Step-Father" (1635, Berlin); the "Angel Leaving Tobias" (1637, Louvre); "Samson's Wedding" (1638, Dresden); the "Sacrifice of Manoh" (1641, ib.); "Reconciliation of Jacob and Esau" (1642, Louvre); "The Disciples of Emmaus" (1648, Louvre); "Jacob Blessing His Grandsons" (1656, Cassel); and "Return of the Prodigal Son" (Saint Petersburg). His mythological pictures make no endeavor to attain classic form or beauty, but strive for pure pictorial effects. Some of them, like the "Rape of Ganymede" (Dresden), even seem to burlesque the subjects. More serious examples are "Diana and Endymion" (Liechtenstein Gallery, Vienna); the "Rape of Proserpina" (Berlin); and "Danaë" (Saint Petersburg). The dozen landscapes which Rembrandt painted display the same poetic feeling and technical skill as his figure subjects. With emphasis of the essentials he has portrayed the beauty of the flat country about Amsterdam. The best known example is "The Mill," in possession of Lord Lansdowne (London); other examples are at Brunswick, Cassel, Dublin, etc.

Rembrandt was probably the most consummate etcher of all times, and held his rank on purely technical as well as artistic grounds. His etchings possess the harmony, tone, and poetry of his pictures, and whether sketchy or highly finished they are always masterpieces. Among his best known prints are the "Descent from the Cross" (1637); "Christ Healing the Sick;" "Christ Preaching;" "Burgomaster Jan Six;" and the well-known "Landscape with Three Trees." Examples of his prints, as well as of his admirable drawings, may be found in the Louvre, Albertina (Vienna), and British Museum, in the museums of Berlin, Dresden, Munich, Holland, and in several private collections.

BIBLIOGRAPHY. Consult the biographies by Scheltema (Amsterdam, 1853); Vosmaer (Paris, 1877), the standard authority; Lemeke, in *Dohme: Kunst und Künstler* (Leipzig, 1877); Graul (ib., 1892); Michel (Paris, 1893); Knaekfuss (Bielefeld, 1899); Malcolm Bell (London, 1899); Neumann (Stuttgart, 1900). For his etchings consult: Blanc (Paris, 1880); Seidlitz (Leipzig, 1896); and especially the reproductions of Rovinsky (Saint Petersburg, 1890 et seq.); for his drawings, Pippmann, Bode et al. (Berlin and London, 1888-90, 1902); and for reproductions of all his works, Bode (8 vols., Paris, 1897).

REMEDIOS, rá-má'dé-ós, or **SAN JUAN DE LOS REMEDIOS**. A town in the Province of Santa Clara, Cuba. It is situated 30 miles northeast of Santa Clara, and 5 miles from the port of Caibarién, with which it is connected by rail, as it is with all the important towns of the island (Map: Cuba, F 4). Population, in 1899, 6633.

REMEDY (from Lat. *remedium*, cure, from *re*, back again, anew + *mederi*, Av. *mad*, to heal). In law, the means by which the violation or invasion of a legal right is either prevented, redressed, or compensated. The term in fact is the correlative of the term legal right, there being in general no right without a corresponding remedy for its violation. The term remedy, however, does not include punishment, and therefore has no application in the criminal law.

The various forms of remedy afforded by the law may be classified as: (1) Remedy by act of the injured party, or self-help; (2) remedy by operation of law; (3) remedy by action or suit.

(1) Remedy by the act of the injured party includes all those rights conferred by law on private persons to protect themselves or their property from injury, and in certain cases to redress wrongs done, without recourse to legal proceedings. In general, remedy by act of the party, or self-help, is permitted by law whenever the remedy afforded by action would be less effective and when the privilege thus accorded to the individual to take the law into his own hands is not inconsistent with sound public policy. Thus, in general, one may defend his person and property from unlawful attacks provided he use no more force than is necessary to accomplish that result. (See SELF-DEFENSE.) One who has been unlawfully deprived of his property may upon fresh pursuit forcibly retake the property, but if the pursuit is not made immediately following the wrongful taking, or if the property has passed into the hands of an innocent holder, his only remedy is by action to recover the property or damages for its conversion. Other forms of remedy by act of the injured party are distress, right of entry, and abatement of a nuisance.

(2) There is perhaps but a single true example of remedy by operation of law, and that is the ancient doctrine of *remitter*, which may briefly be stated as follows: At common law one who was dispossessed of his real estate under certain circumstances had a mere right of action to recover his property; he had no right to reënter upon the property and thus acquire possession, his sole remedy being by action. If, however, he became entitled to the property by inheritance or purchase through the person wrongfully in possession, he was entitled to possession of the property, and upon taking possession under his new but defective title, he might then retain possession by virtue of his valid title. He was then said to be remitted to his rights under the valid title. The doctrine is of slight importance in modern practice.

(3) Remedy by action is the relief or redress afforded to one whose legal right has been invaded, by means of a legal proceeding carried on in a court having jurisdiction over the subject of the suit and the parties to it. See PROCEDURE and ACTION.

For the discussion of the varied forms of remedies, see such titles as DISTRESS; FORCIBLE ENTRY AND DETAINER; NUISANCE; EQUITY; CHAN-

CERY; COMMON LAW, etc., and consult the authorities referred to under some of these titles.

REMEDY OF LOVE, THE. (1) A poem of the sixteenth century wrongly ascribed to Chaucer, and printed in the edition of 1532. (2) A paraphrase of Ovid's *Remedy of Love* by Sir Thomas Overbury, printed in 1620.

REM'ENSNY'DER, JUNIUS BENJAMIN (1843—). An American Lutheran (General Synod) clergyman, born in Staunton, Va., and educated at Pennsylvania College, Gettysburg (class of 1861), and at Gettysburg Theological Seminary (1865). He held pastoral charges in Philadelphia, in Savannah, Ga., and in New York City; labored for the union of Lutheran sects, which was largely accomplished through his service, and published *Doom Eternal* (1880), *Luther, His Work and Personality* (1883), *Six Days of Creation* (1886), and a *Lutheran Manual* (1892), which came into common use.

REMÉNYI, RÉMÁN-YÉ, EDUARD (1830-98). An Hungarian violin virtuoso. He was born at Heves, and studied the violin under Joseph Böhm at the Vienna Conservatory, 1842 to 1845. He took part in the insurrection against Austria in 1848 and fled from Hungary. He came to the United States in 1849, but in 1853 went to Weimar, and thence to England, where he was appointed solo violinist to Queen Victoria. In 1860 he was pardoned by the Austrian Government and returned to Hungary. He afterwards traveled extensively and visited Canada, Mexico, China, Japan, France, and Germany. He ranked among the foremost musical artists of his day, although his style was frequently so exaggerated as to mar the high standard of his work. In technique he has had few rivals. He died while on an American concert tour.

REMI. A powerful people of Belgic Gaul, who alone of the Belgæ formed an alliance with Cæsar in his campaign of B.C. 57. Their capital became the modern Rheims.

REMIGIUS, RÉ-MIJ'ÛS. See REMY.

REMINGTON, FRIEDERICK (1861—). An American sculptor, artist, and author, born at Canton, N. Y. He was educated at the Vermont Episcopal Institute, the Yale Art School, and the Art Students' League, New York City. Afterwards he lived on a ranch in the West. His pictures of Western subjects, especially cowboys and soldiers, soon became very popular. His statuettes include "The Broncho Buster" and "The Wounded Bunkie." They are spirited bronzes, executed with much technical skill, and his horses are notably fine. His stories also deal with Western life, and are illustrated by himself. They include *Pony Tracks* (1895), *Crooked Trails* (1898), and *Sundown Leflare* (1899).

REMINGTON, PHIL (1816-89). An American manufacturer and inventor, born at Litchfield, N. Y. He studied at the Cazenovia Seminary and then entered his father's arms factory at Ilion, N. Y. During the Civil War the Remingtons supplied small arms to the Federal Government, and at its close they formed a corporation under the title E. Remington & Sons. Soon afterwards they began to manufacture the breech-loading rifle which bears their name. In 1873 the firm secured the right to one of the first typewriters, but subsequently the manufacture both

of typewriters and of rifles passed into other hands.

REMINGTON RIFLE. See SMALL ARMS.

REMIREMONT, re-mêr'môn'. A town in the Department of Vosges, France, on the left bank of the Moselle (Map: France, N 3). An old abbey founded in 620 is now used as the hôtel de ville. There is a trade in Vosges cheese. Cotton goods, embroideries, and ironware are manufactured. Population, in 1901, 10,322.

REMITTENT FEVER (from Lat. *remittens*, pres. part. of *remittere*, to send back, from *re-*, back again, anew + *mittere*, to send). A form of malarial fever characterized by a regular lowering of the temperature, which, however, always remains above the normal point. In this respect it differs from intermittent malaria, in which there is an interval of entire absence of fever (apyrexia); and from the continuous variety, in which the body heat remains continuously elevated. The causative agent in remittent fever is the estivo-autumnal variety of the *plasmodium malariae* of Laveran. (See MALARIA.) The severer forms of remittent fever prevail in the Southern States and in tropical countries. They are found in Southern Asia, Western Africa, Central America, and the West Indies. The disease is sometimes, though improperly, called bilious remittent fever. The symptoms of this type are very severe and characterized by typhoid or cachectic features such as occur in the worst cases of intermittent fever, viz. coma, delirium, vomiting, collapse, and hemorrhages from various parts of the body. In certain localities cases occur in which hæmoglobinuria (the presence of altered blood in the urine) is a prominent symptom. The urine assumes a port-wine color, or becomes almost black, the patient is jaundiced, and in fatal cases death takes place from suppression of urine with coma, or from collapse or syncope.

A milder type of remittent fever is seen in temperate climates, especially in the late summer and fall. The symptoms are much less pronounced than those of typical intermittent fever, and consist of loss of appetite, nausea, chill, slight jaundice, and a colorless diarrhœa. The chill is not severe and may appear only once in the course of an attack, which lasts from a few days to two or three weeks. The temperature is not unlike that of a mild typhoid fever (q.v.), and the disease is not infrequently mistaken for typhoid.

The treatment of remittent fever is the same as that of other forms of malarial fever. Quinine in doses proportioned to the severity of the attack acts as a specific. Tonics must also be given and attention paid to the general health. See INTERMITTENT FEVER.

REMONSTRANTS. See ARMINIANISM.

REMORA (Neo-Lat., from Lat. *remora*, delay, from *re-*, back again, anew + *mora*, delay), or SUCKING-FISH. A fish of the family Echeneididæ, interesting because of its commensal habit. The remoras attach themselves to sharks and other large fishes by a sucking-disk on the top of the head. They have an elongated body, covered with very small scales; one soft-rayed dorsal fin, situated above the anal fin; the head flattened and covered with an elongated disk extending back beyond it, which exhibits numer-

ous transverse cartilaginous laminae directed backward, and has a free flexible broad margin. These laminae are formed by modification of the spinous processes of a first dorsal fin, and when



THE WEST INDIAN REMORA (*Rhombochirus osteochir*).

they are raised after the margin of the disk has been closely applied to a smooth surface, a vacuum is created; and so powerful is this apparatus that great weights may be dragged by a remora, while it obstinately refuses to let go its hold. A remora thus attached to a shark or turtle may be carried about for weeks, leaving its host only to secure food, injuring the shark in no way save, perhaps, by the slight check its presence gives to the shark's speed in swimming. In Madag-

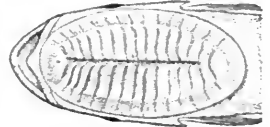

SUCKING-DISK OF A REMORA.

ascar native turtle-catchers put a ring about the narrow caudal end of the remora's body, attach a line to this ring, and thus use the fish for catching turtles. Several species of the family are known, dwelling in all the warmer seas. They are mostly small fishes, one or two feet in length, and of plain colors, or striped lengthwise in brown and white. One (*Remora brachyptera*) is occasionally caught as far north as Cape Cod. A rarer form is *Rhombochirus osteochir*, which attaches itself to spearfishes (*Tetrapturus*). More numerous is the closely related species called 'shark-sucker' (*Echineis naucrates*). (See SHARK-SUCKER.) Consult Jordan and Evermann, *Fishes of North and Middle America* (Washington, 1898).

REMPHAN. A word which occurs in Acts vii. 43 in a passage quoted from the Septuagint text of Amos v. 26. In Amos the reading is Chiun, which is evidently intended either as the name of a heathen deity or as a symbol of idolatrous worship, and is generally explained as the Babylonian name of the planet Saturn (see CHU'N). Why Remphan (Raiphon, Rephan in some texts) should be substituted in the Septuagint is hard to explain. The attempt to connect it with an Egyptian name for Saturn is not satisfactory. A plausible suggestion is that it represents a misreading or alteration of the Hebrew.

REMSCHIED, rêm'shit. A city in the Rhine Province Prussia, 19 miles northeast of Cologne (Map: Prussia, B 3). It has several fine technical schools. Remscheid's manufactures are mainly small steel and iron wares (tools, scythes, skates, etc.), in which industry it ranks first in Germany. There are also machine shops, rolling mills, and manufactures of silk ribbons. The city carries on a large export trade chiefly with America, Russia, and the Orient. Remscheid is first mentioned in 1132. Its industries were stimulated by Protestant refugees from Holland and France. Population (commune), in 1890, 40,371; in 1900, 58,108.

REM'SEN, IRA (1846—). An American chemist, born in New York City. He graduated from the College of the City of New York in 1865, from the College of Physicians and Surgeons, New York, in 1867, and received his Ph.D. from the University of Göttingen, Germany, in 1870. From 1870 to 1872 he was assistant in chemistry at the universities of Tübingen, Munich, and Göttingen, Germany; and from 1872 to 1876, professor of chemistry and physics in Williams College. In 1876 he was made professor of chemistry in Johns Hopkins University, and in 1901 succeeded Dr. Gilman as president of the university. Dr. Remsen has carried out a number of important investigations in both inorganic and organic chemistry. He is editor of the *American Chemical Journal*, founded by him in 1879. His book-form publications include the *Principles of Theoretical Chemistry* (4th ed. 1892); *Organic Chemistry* (latest edition 1899); *Introduction to the Study of Chemistry* (1885); and the *Elements of Chemistry* (1887). Remsen's text-books have passed through many editions in this country and have been republished in England and translated into several foreign languages. They form a remarkably clear exposition of the fundamental principles of the science and are well known among students of chemistry both in this country and abroad.

RE'MUS. The brother of Romulus and co-founder of Rome.

REMUS, UNCLE. A character invented by Joel Chandler Harris in *Uncle Remus; His Songs and Sayings* (1880), and other stories. He is an old plantation dandy, who entertains the son of his mistress with quaint stories of the doings of Bre'r Fox, Bre'r Rabbit, and other animals, illustrating their various traits and interspersed with shrewd philosophy. The author used the folk tales current among negroes in the southern part of the United States, and several of his stories aroused the curiosity of those interested in folklore.

RÉMUSAT, rà'my'zà', CHARLES FRANÇOIS MARIE, Count de (1797-1875). A French politician and philo-sophie historian, born March 14, 1797, in Paris. He was the son of Claire Elisabeth Jeanne Rémusat (q.v.). Rémusat studied with brilliant success, and in 1818 began his career as a journalist and supporter of Guizot. He contributed constantly to *Le Globe* from its establishment in 1824. From 1830 to 1848 he was Deputy, and for brief periods Under-Secretary of State (1836) and Minister of the Interior (1840). After the revolution of February, 1848, he was elected to the Constituent and Legislative Assemblies, and became an opponent of Louis Napoleon, by whom he was exiled after the coup d'état. He was amnestied in 1859 and devoted himself to literature and science. From 1871 to 1873 he was Minister of Foreign Affairs. The most noteworthy of his writings are *Essais de philosophie* (1842), *Abélard* (1845), *Passé et présent* (1847), *L'Angleterre au XVIII. siècle* (1856), *Bacon* (1858), *Hartley* (1874), *Histoire de la philosophie en Angleterre depuis Bacon jusqu'à Locke* (1875). After his death were published six volumes of *Correspondance pendant les premières années de la Restauration* (1883-90).

RÉMUSAT, CLAIRE ELISABETH JEANNE GRAVIER DE VERGENNES, Countess de (1780-1821). A writer of memoirs, born in Paris. She was a

grand-niece of Vergennes, Prime Minister under Louis XVI., a noted beauty of the Court of Napoleon I., and an intimate friend of Josephine. As wife of Count Augustin Laurent de Rémusat, chamberlain of Napoleon, and as *dame de palais*, she was acquainted with the intimate life of the Napoleonic Court, of which she left an account in her *Mémoires* published long after her death (1879). She was also the author of an *Essai sur l'éducation des femmes* (1824).

RÉMUSAT, JEAN PIERRE ABEL (1788-1832). A French Orientalist, born in Paris; the son of a surgeon. His father taught him Latin, which he wrote and spoke with great ease. He took up Chinese and unaided brought out in 1811 his *Essai sur la langue et la littérature chinoises*. He received his degree as a physician at twenty-five, and served in the military hospitals. A chair of Chinese having been established at the Collège de France in 1814, Rémusat was appointed to it. He was made a member of the Academy in 1816, and in 1818 succeeded Visconti as editor of the *Journal des Savants*. He was one of the principal founders of the Société Asiatique de Paris in 1822, and was long its secretary. He translated and wrote a good deal, many of his shorter productions appearing in the *Moniteur* and other periodicals, as well as in the *Journal of the Asiatic Society*. He died of cholera in Paris. His principal works are: *Livre des récompenses et des peines* (the Chinese *Kanying-pien*), with notes and illustrations (Paris, 1816); *L'invariable milieu of Tsz'-tse* (1817); *Description du royaume de Camboge* (1819); *Histoire de la ville de Khotan*, to which is appended a treatise in which he endeavors to show that jade is the jaspis of the ancients (1820); *Eléments de la grammaire chinoise* (1822); *Mémoire sur la vie et les opinions de Lao-tse* (1823); *Mélanges asiatiques* (1825); *Iu-Kiao-li*, or "The Two Cousins" (1826); *Recherches sur les langues tartares* (1829); *Nouveaux mélanges asiatiques* (1829); and *Foë Koué Ki, ou relations des royaumes bouddiques* (a translation of the travels of the Buddhist pilgrim Fa-hien, unfinished at the time of his death, but revised, completed, and supplemented by Klaproth and Landresse, and brought out in 1836). Consult Silvestre de Sacy, *Notice sur la vie et les ouvrages de Rémusat* (Paris, 1834).

RÉMY, rà'mé', CAROLINE (1855—). A French journalist, best known by her pseudonym of Séverine. She was born in Paris, and in 1880 met in Brussels the communalist Jules Vallès, with whom she wrote for Paris papers, and, after 1883, for his *Cri du Peuple*. On Vallès's death Mlle. Remy married Guebbard, a co-editor of the *Cri du Peuple*, which for several years was carried on under her supervision, in the meantime turning from socialism to philanthropic sentimentalism. Besides she appealed for many charities in the columns of the *Figaro*, *Gil Blas*, *Gaulois*, and *Petit Journal*. In the nineties she made herself famous by publishing an interview with Leo XIII., and in 1896 by a bitter personal warfare with Rochefort.

REMY, or **REMI**, SAINT. (1) The apostle of the Franks (437-c.533). He was born of noble family at Leon. He was appointed in 459, against his will, to the Bishopric of Rheims, and his episcopate is memorable for the conversion

of Clovis, who was baptized by Remy on December 24, 496. Remy lived to see Gaul almost entirely Christianized, and died in 532 or 533. Some of his letters are preserved in Migne, *Patrologia Latina*, lxxv., as also two documents under the title of *Testamenta*, the genuineness of which has been disputed. Consult his *Life*, by Aubert (Paris, 1849). (2) An Archbishop of Lyons (853-875), who sided with Gottschalk (q.v.) and whose works are in Migne, *Patrologia Latina*, cxxi. (3) A Benedictine monk, head of the episcopal school at Rheims (882-908), whose works, which are commentaries and an allegorical interpretation of the mass, are in Migne, *Patrologia Latina*, cxxxii.

RENAISSANCE (Fr., new birth), or **REVIVAL OF LEARNING**. A name usually applied to the transition from mediæval to modern methods of study and thought. As to its origin and the time at which this is to be set, literature is full of misinformation. The most common error, still repeated in text-books, is that through the capture of Constantinople by the Turks in 1453 Greek manuscripts and Greek scholars were brought into Europe in such numbers that a complete revolution in the intellectual life was thereby and at once produced. This notion takes no account of the condition of European culture which must have existed to make such a reception possible. In fact, the revival of interest in learning for its own sake followed a long and natural process. It is clearly discernible more than a century before the capture of Constantinople, and by that time had completely established itself in Italy and made great progress in other countries. The actual importation of manuscripts and teachers, doubtless stimulated by this event, had long been going on, and it had already become an established custom for Western youths to seek in Athens or in Constantinople satisfaction for the intellectual curiosity aroused by their studies at home.

It is again a popular error to suppose that we can reach a clear understanding of the great transition by undervaluing the culture of the Middle Ages. The difference is not merely or primarily in the mental power of individuals nor in the volume or range of their learning. It is in the spirit in which they approached the study of the past and applied it to the conditions of the present. Mediæval learning had been pursued almost entirely by clergymen and had been valued chiefly for its service in making clear to the increasing mental acuteness of the West the mysteries of the faith. During this period the European mind had lain under the spell of the philosophy of Realism, with its inevitable indifference to the phenomena of everyday experience and its contempt for the idea of the individual as compared with the authority of traditional institutions. With the beginning of the fourteenth century a reaction makes itself clearly felt. A new philosophy, that of Nominalism, finds expression in the Englishman William of Ockham and becomes a vital force in the political theories of Marsiglio of Padua and his school. The essence of this new way of looking at things is the importance of the individual, and hence his right to think and organize as may seem best to him. In religious affairs we see the application of this principle in the fearless criticism of the prevailing conditions by Wiclif in Eng-

land, Huss in Bohemia, and all their sympathizers, organized or not, throughout Europe. This central idea is that the most important fact of Christianity is the membership of the individual Christian in a community of which Christ alone is the head, and that consequently all organized forms of human authority in religion are non-essential and may be totally wrong. The only necessary authority is that of Scripture, and the inevitable result of this is the right of individual interpretation with all its consequences. From Wiclif on through the whole period of the Reformation, the Bible is the common source of appeal for the most diverse forms of opposition to the Roman system. Naturally men found in its infinite variety a thousand serviceable things that were not there.

Precisely parallel with this development in religion is the intellectual process we call the Revival of Learning. Wiclif's Italian contemporary Petrarca subjected to a sweeping criticism all the existing forms of the science of his day: the scholastic philosophy, the science of astrology, the study of the law and of medicine, the practice of teaching, all seemed to him to be governed by a set of conventional rules having no foundation in fact. To this mass of tradition Petrarca opposed the principle of individual study and observation of things as they were. Yet, he, too, like the religious reformers, must have his authority, and he found it in the classic literature. The 'ancients' stood to him for types of a higher manhood, with larger, freer, and truer conceptions of life. They seemed to him free from the superstitious slavery to traditions which he saw around him. His own struggling individualism found its justification in what he imagined to be the perfected individualism of the ancient world. His own poetic gift found its chief satisfaction in the poetic charm of ancient literature; even the prose of Cicero seemed to him to have a wonderful rhythm long before he could understand it. Then, precisely as the religious reformers insisted that the Bible should be studied without restraint of doctrine or tradition, so Petrarca found his chief mission in collecting, collating, copying, and publishing the texts of the classical authors. Still further, as the translations of Wiclif and others were made, not from the original tongues, but from the imperfect Latin authorized version (Vulgate), so Petrarca had to be content with Latin versions of the Greek authors. In both cases the authority they revered came to men in an imperfect form, but in both the spirit of a new time is perfectly evident. Wiclif is the first apostle of the Protestant Reformation, and Petrarca is the first great teacher of the Revival of Learning. To conclude, the Humanist was as much inclined to discover non-existent things in his classics as was ever the Reformer in his Bible.

Petrarca was at once the defender of rational thought, and, after Dante, the chief creator of the modern Italian language. The literary use of the modern tongues, the natural utterance of the free layman, is, equally with the more sympathetic study of the ancient world, an element in the great reaction against a purely clerical and Latinized culture.

This double intellectual life of Petrarca is shared by all his humanistic contemporaries and

immediate followers. Giovanni Boccaccio is known to posterity chiefly through his Italian prose tales, but his own special pride was in the service he rendered to classical learning by his laborious encyclopedic works—the *Genealogy of the Gods*, a dictionary of mythology, and his *Dictionary of Classical Geography*. These books served as a groundwork of classical studies for the youth of two centuries to come. Boccaccio died as professor of the *Divine Comedy* at the University of Florence, another illustration of the equality of the modern and ancient literatures in the estimation of Renaissance Italy.

Petrarca applied to learning for the first time what we have learned to call the 'collector's instinct.' Much of the classic literature was already known, but until Petrarca no one had thought of searching for more. Through his widely extended personal relations in all the countries of Europe he was able to employ willing hands to bring the long-forgotten manuscripts out of their hiding-places, to have them sent to him, procure copies of them, compare these with the originals, and thus learn wherein they needed correction. Many indications in already known writings pointed to others not yet discovered, and thus made possible intelligent search after these lost treasures. All this work was carried on by Petrarca and his contemporaries with the fresh enthusiasm that belongs only to an interest freed from any professional quality, but it soon became the serious pursuit of men who gave their lives to it, and thus laid the foundations for a new profession, unknown to the Middle Ages, the profession of the scholar, pure and simple. These men were devoted to learning for its own sake, and ready to leave to others the application to practical things.

The same instinct of discovery appears also in the field of archaeology. The Middle Ages had pitilessly despoiled the remains of ancient buildings to gain material for their own constructions, and had destroyed without scruple the choicest works of antique sculpture. Now, following the indications of what remained above ground, Petrarca and his followers began to seek for what was hidden. They gave the first feeble impulse to the vast activities of modern research. To them we owe the beginnings of both the libraries and the museums of modern Europe.

In the generation following Petrarca the influence of the new learning makes itself widely felt in many forms of activity. Men whose early training had been chiefly as scholars came to be sought for services of every kind. Coluccio Salutati, one of Petrarca's most ardent admirers and imitators, spent his life as secretary of the Republic of Florence, at a time when the little State was involved in the most complicated relations with all the powers of Europe. It was his duty to write the elaborate Latin essays which were then the chief medium of diplomacy, and his fame rests upon the elegance and purity of this imitated classicism. Poggio Bracciolini filled for life a similar place in the Papal chancery, and was no less approved and applauded because his caustic humor reveled in ribald obscenities. Niccolò Niccoli was the business centre of the Florentine group of scholars, the earliest type of the modern book-collector and publisher. Ambrogio Traversari, general of the Order of Camaldoli, devoted much time to studying and editing the works of the

ancients. Francesco Filelfo was the earliest specimen of the haughty pedant, learned beyond others in all the detail of scholarship, but without the creative power that had marked the pioneers. He touched the schoolmasterly stage of the Revival when the work of discovery had largely been done, and when the chief distinction of the scholar was to be gained by a kind of technical skill quite independent of any largeness of mental equipment.

It is at this stage that we begin to see the results of the great expansion of interest due to the study of Greek. Petrarca had deeply felt the importance of this study, and had bemoaned his incapacity to engage in it. Greek was still a living tongue in parts of Southern Italy, and communication with the East was frequent enough, but Boccaccio, who seems really to have made the effort, found it impossible to procure suitable instruction. The men of the next generation, however, set themselves more earnestly to work; Greek teachers began to hear of the golden opportunities in the rich Italian towns, and Italian youths sought instruction at the ancient school of Athens. The earliest and most influential of these Greek teachers was Mamei Chrysoloras, a man of distinction in the public service at Constantinople, brought over to Italy by his duties in this capacity, and then employed as teacher of Greek at Florence. He died on his way to attend the Council of Constantine in 1415. Another Greek of later influence was John Argyropulos (died c.1489), who was successively rector of Padua and professor at Florence and finally at Rome. Of Italians who illustrated the highest application of ancient culture to the development both of Italian literature and the perfection of classic learning, we may mention Guarino (d.1460), Poliziano (d.1494), and Lorenzo de' Medici (d.1492). The inherent charm of the Greek language and literature worked at once upon the highly sensitive Italian mind, revealing a new world of beauty and of meaning.

Circumstances favored a rapid spread of the new culture. The Italian cities, grown rich under democracy, but having tired somewhat of its responsibilities, had been passing into the control of that extraordinary series of despotic rulers who united with a brutal unscrupulousness of character a taste for the best in literature and art without a parallel. It was one of the chief claims to power for a new-made tyrant like Cosimo de' Medici that he provided the means of existence for talent of every sort. Even the bloody ruffians who, one after another, held power in Milan, made places for scholars and artists, maintained libraries, and encouraged learned research. The ancient universities of Bologna, Padua, and Salerno were reinvigorated by the healthful breath of the new learning and stimulated by the rivalry of the new schools founded by the younger republics. The Papacy, with a free hand after the Council of Basel (1431-49), passed into the control of a series of men like Nicholas V., Pius II., and Leo X., in whom the interest in learning and art was an absorbing passion. In fact, learning, under the Italian humanistic impulse, may be said to have taken on the form of a fine art and thus to have concealed much of its serious import. Under all these favoring conditions it is not strange that a certain flippancy of character

came to be associated with the cleverness of the fifteenth-century scholars. The lightness of Boccaccio had seeded the natural expression of exuberant joy in the natural things of human life. A century later this sincerity had largely given way to an over-refinement that knew no limits. Everything was permissible in the name of æsthetic experiment. Without in any formal way renouncing their allegiance to Christianity, many became more really interested in philosophy than in doctrine, and became increasingly lax in following the ordinary forms of devotion.

It is here that we may best notice a distinction insisted upon by recent Roman Catholic scholars—notably by Ludwig Pastor in his *History of the Popes*—between a 'true' and a 'false' Renaissance. By the former is meant the enlargement of scope and the clearing of the mental vision possible to men without departure from the traditions or the institutions of the Church. By a 'false' Renaissance is meant the exaggeration of the æsthetic and critical side of learning to a point where it must lead to indifference or even hostility to the clerical traditions.

A great change came over the spirit of the New Learning when it passed to the more serious, less artistic, and more deeply religious peoples of the North. The impulse which led young Germans and especially young Englishmen to cross the Alps and study the ancient classics under Italian teachers was largely the desire to find the very best means to acquire such training as would help them in the regular professions. There is in the North but little of the affected æstheticism of the later Italians. Such men as those whom Erasmus found in England at the end of the fifteenth century, John Colet, later Dean of Saint Paul's, founder of the most important boys' school in England and interpreter of Christianity by the method of a rational criticism; Groeyn, the most important agent in introducing the teaching of Greek into England; Thomas Linaere, founder of the London College of Physicians; and Thomas More, a busy lawyer, King's counselor, and social reformer, suggest a type of man totally different from the members of the Florentine 'Academy.' Yet all these men drew their intellectual inspiration from Italy, and were free to acknowledge their debt. Erasmus himself, with all his biting satire and his ready criticism of many serious things, was primarily the preacher of a sane rationalism based upon sound learning, and by this he always meant the learning of the New Method. 'Art for art's sake' never held the same place in the intellectual code of the North as in that of Italy, but the appreciation of learning was there none the less keen, and proved to be more lasting in its effect upon national character. One of the great services of the northern Humanism was the revival of the study of Hebrew on a scientific basis. What we have said of the mediæval study of Latin applies equally to that of Hebrew. It had been pursued by Jewish scholars with a view to the perpetuation of their racial institutions, but it had not been in any sense an instrument of culture. Johann Reuchlin, an elder contemporary of Luther and Erasmus, was the first to call attention to the importance of Hebrew in a complete scheme of Christian scholarship. He aroused a storm of opposition from the same obscurantist elements that had always been ready to persecute Jews as inevitably hostile to

all that bore the Christian name. He found his support wholly in the circle of enlightenment that had spread itself outward from the study of the Greek and Latin classics as a means of civilization. The party of the 'Reuchlinists' included all the forward-looking elements of German society and attracted the sympathy of the men of enlightenment everywhere. Its most characteristic expression is found in the *Epistolæ Obscurorum Virorum* (Letters of the Men of Darkness), the most galling satire of the Reformation period, in which the old scholastic method was held up to the derision of people who were quite ready to join in the laugh and to carry out the suggestion of reform.

The first quarter of the sixteenth century saw the capture of most of the great universities of the North by the new spirit. Even at Paris, the theological school, the Sorbonne, still defended the ancient faith, and largely by the ancient methods, while the Collège de France, founded by Francis I., became a seat of enlightened instruction. So at Louvain, one of the most solid bulwarks of the scholastic theology, a new school, established with the help of Erasmus, kept up the balance with success.

The great importance of the New Learning in its effect upon the Protestant Reformation is sufficiently shown by the studies of Luther, Calvin, Zwingli, and other leaders of the movement. No doubt the immediate effect of the Reformation was once more to turn men's minds away from purely æsthetic considerations, but the work of the New Learning had been done and could not be undone.

BIBLIOGRAPHY. The most important work on the general history of the Renaissance is Voigt, *Die Wiederbelebung des klassischen Altertums* (3d ed., Berlin, 1893). Consult also: Müntz, *Precursori e propugnatori del rinascimento* (Florence, 1902); Burekhardt, *Geschichte der Renaissance in Italien* (Stuttgart, 1890-91); id., *Kultur der Renaissance in Italien* (8th ed., Leipzig, 1901); Symonds, *The Renaissance in Italy* (London, 1877); Pater, *Studies in the History of the Renaissance* (ib., 1873); Biese, *Die Entwicklung des Naturgefühls im Mittelalter und der Neuzeit* (Leipzig, 1887); Robinson and Rolfe, *Petrarch* (New York, 1892); Seeböhm, *Three Oxford Reformers*, (3d ed., London, 1887); and the lives of Erasmus by Froude (ib., 1894), Drummond (ib., 1873), and Emerton (New York, 1899).

RENAISSANCE ART (OF., Fr. *renaissance*, from Lat. *renascens*, pres. part. of *renasci*, to be born again, from *re*, back again, anew + *nasci*, to be born). During the last decades of the fourteenth century and the first decades of the fifteenth a new spirit invaded the domain of art, asserting itself in a new enthusiasm for the study of man and the study of the antique. To the humanists in literature corresponded the realists, naturalists, and classicists in art. Antique art was rediscovered, but while the classical element preponderated in architecture and decoration, it was the element of realism that took possession of the arts of sculpture and painting. The flowering of the Renaissance into these new impulses was chiefly due to a few leading artists of Tuscany between 1390 and 1430; to the architect Brunelleschi, the sculptors Donatello, Quercia, and Ghiberti, and the painters Masolino, Masaccio, and others. Northern critics, however, have

shown that a strongly realistic school had previously developed in Burgundy, Northern France, and Flanders, especially in the sculpture of such artists as Chaux Sluter, Beauneven, and Jean de Cambrai. The age of the Renaissance, though it practically closes before 1600, was not superseded by a Græco-classical revival until about the period of the French Revolution.

Painting was the typical art of the Renaissance because it best expressed its realism. In architecture the style was far less original, its character being less constructive than decorative. The preponderance of the secular spirit led to a decadence of religious art in all forms. The previous tendency toward general types in art gave way before a new individualistic tendency, each artist creating his own personal style. Only in painting were the peculiarities of local schools very prominent.

Tuscany was followed by Lombardy in the development of the Renaissance about 1460, and shortly afterwards by Venice. Rome and Naples were simply meeting places for Tuscan and Lombard artists. France was the first foreign country to follow the example of Italy, with whom its relations of all kinds had long been of the closest. Spain, in some parts, then followed quite early in the sixteenth century. Not till the middle of the century did Germany and England accept the new style to any large extent, and even then with less of pure beauty and classic precision than in Italy and France.

Renaissance sculpture and painting are of such importance in the history of the general development of these arts that it is most convenient to treat them under the general articles.

ARCHITECTURE—ITALY. Gothic architecture had never acquired a deep-rooted hold in Italy and Italian architects had been seeking for a new style ever since the decline of the Romanesque. This they found in a study of the Roman ruins, out of whose columns, entablatures, and arches they developed a style which, sharing the pagan spirit of Roman art, was more successful in secular than in religious buildings. Coming at a time of individualism, it developed personal and local phases of style, and its history is the history of the works of individuals, not of a national style. It developed into a system of decoration and composition rather than of construction, although it made effective use of the dome and vault. Several periods of Italian Renaissance can be distinguished: (1) Early or Free Renaissance, c. 1420-1500; (2) High or Classic Renaissance, c. 1500-1580; (3) the Decline of Barocco, c. 1580-1780. The founder of the style was the Florentine Brunelleschi, the greatest designer of the early Renaissance and equaled only by Michelangelo and Bramante among later men. In the Pazzi Chapel (1425) and the two great basilican churches of Santo Spirito and San Lorenzo he revived the moldings and details of classic architecture, but neither he nor his followers, Michelozzi and Giuliano da Majano, attempted any close imitation of Roman buildings. The two great palaces of this first period in Florence, viz. the Riccardi by Michelozzo (1430) and the Pitti (1435), though Roman in scale and in minor details, were of a thoroughly modern and Florentine type. Alberti was the first to attempt strictly Roman and classic exterior design in both religious and secular architecture by the use of

superposed orders, pilasters, entablatures, and Roman arches. Florentine architects of later date, Rossellino and Francesco di Giorgio, carried the new style to Pienza, Siena, and Cortona, and others, like the Majani, Laurana, and Giuliano di San Gallo, to Naples, Urbino, and Rome. The ducal palace at Urbino is one of the most imposing masterpieces of the Early Renaissance. In Lombardy the new style developed a prolific school of design which, retaining the use of terra-cotta ornament, open arcades, and some mediæval details, was more varied and picturesque than the Florentine. Its influence was carried to Venice by the Lombards, and there gave rise to the most richly decorative of all the local Renaissance styles, through the free use of marble incrustations and surface carving. To Lombardy belongs also the most highly decorated façade of the Renaissance, that of the Certosa at Pavia; and from Lombardy came Bramante, the genius who inaugurated the Middle Renaissance, after his establishment in Rome in 1499.

While most of his predecessors had been primarily goldsmiths or decorators, Bramante was a master-builder, and became an architect in the true modern sense. He was the first to embody the genuine Roman spirit in modern design, as in his *Tempietto*, and in his designs for the Vatican and Saint Peter's (1503-06). Henceforth both the Lombard and early Tuscan systems of ornament were abandoned for plain surfaces and colossal details; the new style was severe and grandiose; only in the interiors was decoration still abundant. The design that embodied its best features was Bramante's plan for Saint Peter's. The Roman school under him now succeeded the Tuscan in the leadership, and the study of Vitruvius and the measuring and drawing of Roman ruins became an accepted part of every architect's training. Raphael, Peruzzi, and Antonio da San Gallo were among Bramante's foremost pupils; the Farnesina, Massimi, and Farnese palaces embody their ideas, the last named being the most imposing in Rome. But meanwhile the Venetian school had not lost the individual charm (see *VENICE*) of its civic and palace architecture under Guglielmo Bergamasco and his rivals and then under the neo-classic leader Sansovino, whose *Libreria di San Marco* and *Palazzo Comaro* marked an epoch in Venetian architecture.

This middle period closes with Michelangelo, whose genius, like Bramante's, also ushered in a new period, that of the scientifically developed Renaissance, based upon the deepest study of classical monuments. Remodeled by Michelangelo, Saint Peter's remained even more the type for Renaissance churches. The dome, either single or grouped, the tunnel vault and cross vault, often coffered, continued the orthodox forms of covering. Internal piers became heavier, while columns often took the place of pilasters outside. The single order after the colossal example of it given at Saint Peter's by Michelangelo reigned supreme. Vignola's works present this style under a more refined aspect and mark the beginning of the villa architecture of the Roman school. (See *LANTE, VILLA*.) In the palaces of Alessi and others at Genoa monumental staircases and vestibules are the central point for grandiose and original treatment, rather than the façades. The progressive domination of classic formulæ is observed alike in the writings and

the buildings (especially at Vicenza) of Palladio. The term Palladian is generally used for this scientific-theoretical style, whose side lights were Vignola, Serlio, and Scamozzi. Its first great embodiment in Palladio's work was the arcade around the basilica at Vicenza, which was followed by other remarkable works, such as the Palazzo Chiericati, the Palazzo Tiene, and the Teatro Olimpico. He created his highest types of religious architecture in Venice with San Giorgio Maggiore and the Redentore, and through them produced a revolution.

Hard on his footsteps came the Barocco style (q.v.) (c.1575-1780). It was a reaction from Palladian severity and reveled in broken lines, vagaries of proportions and form, defiance of tradition. Domenico Fontana, Maderna, Bernini, and Borromini were its greatest representatives. Its masters produced sometimes a grandiose work like Bernini's colonnades of Saint Peter or a logical church façade, though Maderna failed utterly in that of Saint Peter's and succeeded better only in smaller buildings such as Santa Susanna. The works of Longhena (q.v.) at Venice were exceptions to the general rule of extravagance and bad taste. As in every final style of an architectural period, the picturesque predominated over the monumental. Rich colored marbles, heavy details of cupids, scrollwork, and architectural motives, even imitations in metal and marble of stuffs, as in Bernini's famous baldachin, are prominent.

FRANCE. The close political relations of Italy with France and the habit of calling in Italian artists, consequent upon the campaigns in Italy of Charles VIII., Louis XII., and Francis I., led to the introduction of Renaissance forms into France sooner than elsewhere; at the same time the strength of French Gothic traditions not only retarded the prevalence of Renaissance forms, but led to an internal reform rather than to the adoption of an Italian style. Religious architecture had been for some time on the wane and palace architecture in the ascendant. The first indications are most evident in decoration, where Lombard models prevail. The transitional period illustrated in the Château de Gaillon and in the older part of that of Blois (q.v.) is still prevalingly mediæval; but with Francis I. Gothic outlines tend to disappear and the classic orders to prevail. But it was not the foreign but the native artists to whom the fundamental changes were now due; first to the men of North France, like Fain and Biart; then to those of the Royal Domain, like Le Breton and Lemercier, while others, like Chambige in his unique Château of Saint Germain, remain outside of the Renaissance orbit even toward the middle of the seventeenth century. The greatest achievement was the transformation of the feudal castle into a superb and artistic residence, totally unlike anything known in Italy: such were Amboise, Blois (q.v.), Fontainebleau (q.v.), and especially Chambord (q.v.), with its great corner bastions and its forest of dormer windows, chimneys, and towers, a characteristic feature in which French differs so fundamentally from Italian Renaissance. These royal residences were almost rivaled by those of the nobility like Azay-le-Rideau and Chenonceaux (q.v.).

The closing years of Francis I. (died 1547) usher in a more classic style. Some of its leaders, like Jean Bullant, Du Cerceau, and Phil-

bert de l'Orme, studied in Italy; others, like Pierre Lescot, were undoubtedly familiar, through drawings, with Italian buildings. Lescot's creation of the Louvre (q.v.) (1546) is the classical example of the new style of royal palace without a trace of mediævalism, and is if anything superior to the contemporary work of San Gallo, Vignola, and Sansovino in Italy. One of its great charms lies in the magnificent sculptures of Jean Goujon and others, which make it unique in its decorative scheme. De l'Orme's Tuileries (q.v.) and Château of Anet were his masterpieces. Under Francis I., Henry II., and Charles IX. France was covered, especially in the region of the Loire, with châteaux of similar types, with civic structures like the town halls of Beaugency and Paris, and with innumerable city houses of the nobility and bourgeoisie. The changes brought about by a further influx of Italian ideas under Maria de' Medici involved loss of charm, as well as force in later works. Additions were made to the royal palaces such as the Tuileries, the Louvre, and Fontainebleau and a new palace, the Luxembourg (q.v.), was built by one of the leaders of the new school, Salomon de Brosse, who improved upon his Italian model, the Pitti Palace. Lemercier was very successful in his additions to the Louvre and in the Sorbonne. Through all this middle period there is a constant struggle between Italian classic and barocco tendencies and the French love of the picturesque, but French architects did not go to the extreme either of scientific frigidity or lawless eccentricity.

Under Louis XIV. a more fanciful decoration mingled with the formal Palladian architecture. Mansart showed in his colossal palace of Versailles the chilling effects of this formal classicism, but he achieved greater success in his dome of the Invalides. The masterpiece of the time was, however, the superb Corinthian colonnade of the east front of the Louvre, by which the palace was completed, from the designs of Perrault. The interior decorative work of this period in France has an originality and delicacy that places it as much above contemporary work in Italy as the early decoration had been inferior. Under Louis XV. Italian ideas obtained complete possession of exterior design and of church architecture both exterior and interior, though in domestic architecture the interior decoration and furniture display a remarkable fantastic originality. The Paris Pantheon by Soufflot (q.v.) represents the formal Roman classicism that prevailed in the latter part of the eighteenth century.

GERMANY. The Renaissance as a style in art and especially in architecture made its way more slowly in Germany than elsewhere, except in England; partly, no doubt, because the movement was so largely concerned with religious questions. When the new style entered Germany it was from Carinthia, Bohemia, and Tyrol, rather than from Italy, and Italian architects were employed in Prague, Cracow, Graun, and Vienna, long before the creation of the earliest examples of the style even in South Germany, while the northern States were still slower in receiving it. The real transformation of German architecture began after the Peace of Augsburg (1555), and is to be seen in the castles of the princes and barons, the houses of wealthy burghers, and guilds, and the *Rathäuser* of the town

councils, rather than in royal palaces or in religious buildings. Indeed, Saint Michael's, Munich, is the only really important church edifice of the sixteenth century in all Germany (1582). Until the Palladian or rather the Italian Baroque style invaded Germany, late in the seventeenth century, the Germans retained in their Renaissance buildings unchanged many of their national and mediæval features—high roofs, vast stepped gables of fanciful outline, dormers running through two or three stories, spiral stair-towers, oriels, the irregular plans of the feudal castles, and a predilection for old, fantastic, and picturesque combinations of form and detail. The orders appear rarely except in portals or in pilasters, and then treated with utter disregard of classic canons, and court arcades of the classic type are not to be found, the Germans preferring stumpy columns with segmental arches to the Italian type. The style appears, therefore, at its best in the smaller street fronts of narrow houses, or the picturesque masses of castles on the hillsides, as at Torgau, or in the highly ornate Otto Heinrichsbau (1554) and Friedrichsbau (1601) of the great castle at Heidelberg, which are generally considered the masterpieces of the first period. The town halls of Altenburg, Danzig, Augsburg, Rothenburg, and Bremen (from 1562 to 1612) and others of less importance form another interesting group of examples of the style. In the later or Baroque period there were many palaces erected or enlarged of moderate architectural interest, except in the case of the Zwinger at Dresden (1711), which is one of the finest and most consistent examples of the Rococo extant; and there were also a number of interesting churches in this style (e.g. Marienkirche at Dresden). Landscape architecture after the style of Versailles was highly developed in this period.

BELGIUM AND HOLLAND. In these closely related countries Renaissance architecture developed very differently, though late in both. Belgium was strongly affected by both French and Spanish influences, as in the fantastic semi-Spanish episcopal palace at Liège by Borset (1508), and produced but one monumental edifice of classic type, the Antwerp town hall (1564). As in Germany, many of the most characteristic Renaissance works are guild halls and narrow street fronts, as on the great square at Brussels, the Boatmen's houses at Ghent, etc. Even more successful were many sumptuous choir screens, altars, and pulpits, both in Belgium and Holland. In the latter country the Renaissance produced almost no works of real importance, though some of the Dutch town halls are worthy of notice, as at The Hague (1565), Amsterdam (1655), and Leyden (1597). With these may be classed also the Amsterdam Bourse, and in Denmark the Exchange at Copenhagen. The use of brick, of stepped gables, and of a simple and naïf style of design gives a certain charm to many less important Dutch buildings.

SPAIN. Although the Renaissance in architecture entered Spain largely through the work of Flemish artists, it developed more rapidly and produced more important works than in Flanders. The exuberant decorative spirit of Spanish late Gothic and Moresque art appears in the elegant detail of the Plateresque, as the early phase of the Renaissance in Spain is called, in such structures as the Santa Cruz Hospital at

Toledo, the College at Alcañ de Henares, and the Ayuntamiento at Seville, all between 1500 and 1520. About 1525 church architecture was radically modified by the new style, as shown in the cathedrals of Jaén (1525) and Granada (1529) and San Domingo at Salamanca. But hardly had this begun when Berruguete returned from Italy and brought with him the High Renaissance in the Palladian form, which was further developed by Herrera. This second phase of Spanish Renaissance is called the Greco-Roman, and it ruled until the close of the seventeenth century. The palace of Charles V. at Granada is a noble structure by Machuca and Berruguete, rusticated below, colonnaded above, of good proportions and well planned. One building especially corresponds in its vastness to the greatness and character of Spanish power, viz. the Esocrial (q.v.), a huge rectangle, simple and uninteresting except in its domical church, which is an impressive edifice of classic style. In such works as these Italian ideas are reproduced with greater fidelity and absence of local national traits than in any other country. On the other hand, when under the leadership of Churriguera an extreme form of Baroque or Rococo pervaded Spain, the national leaning toward elaborate detail and over-decoration of surfaces ran riot as never before. Some of the royal palaces (Madrid and San Ildefonso) built in the eighteenth century escape it, but with few exceptions it prevailed.

PORTUGAL hardly holds any independent position. Its masterpiece of the sixteenth century, the group of monuments at Belem, is the *comble* of luxuriant expression of the mixed late Gothic and pseudo-Renaissance design.

ENGLAND. Latest of all countries to employ the Renaissance style was England. Under Elizabeth and James I. (1558-1625) there were sporadic examples and a sprinkling of the new style of decoration in Tudor work. There were some Italian artists like Torrigiano and Giovanni of Padua, but they had to adapt themselves to Tudor requirements, except in a few cases such as the Caius Gate at Cambridge. Inigo Jones changed the trend of architecture and led to the universal adoption of the pure Italian High Renaissance of the Palladian type before the middle of the seventeenth century, his happiest effort being the palace at Whitehall (q.v.). His work was carried forward by Wren, whose masterpiece, Saint Paul's Cathedral (q.v.), is one of the great buildings of Europe. It combined the Renaissance groups of domes with the typical ground plan of an English Gothic cathedral. Wren's sobriety and consistency gave a character of good taste to all contemporary English architecture, which continued throughout the eighteenth century under the leadership of men like Van Brugh, the designer of Blenheim, Hawksmoor, and Gibbs, who built Saint Martins-in-the-Fields and the Radcliffe Library, Oxford. These men and their successors, Chambers, Adams, Taylor, and Dance, show a progressive degeneration in point of originality up to the close of the century, when the wave of purely Greek Renaissance struck England and was embodied in buildings like the Bank of England (see SOANE), the British Museum (q.v.), the Fitzwilliam Museum, Cambridge, and the fine Saint George's Hall, Liverpool (q.v.).

BIBLIOGRAPHY. For Italy the most convenient

books of reference are: Burekhardt, *Der Cicerone* (7th edition, by Bode, Leipzig, 1898); id., *The Civilization of the Renaissance in Italy*, trans. by Middlemas (London, 1890); Müntz, *Histoire de l'art pendant la renaissance* (Paris, 1894). Consult also: Pater, *The Renaissance* (London, 1873); Symonds, *Renaissance in Italy. The Fine Arts* (ib., 1877); Vernon Lee, *Euphorion* (ib., 1884); Scott, *The Renaissance of Art in Italy* (ib., 1888); Hoppin, *The Early Renaissance and Other Essays on Art Subjects* (Boston, 1892); Philippi, *Die Kunst der Renaissance in Italien* (Leipzig, 1897); Woelflin, *Die plastische Kunst: eine Einführung in die italienische Renaissance* (Munich, 1899); and on the architecture, Anderson, *Architecture of the Renaissance* (London, 1896). For a detailed account of the Renaissance in France, the best works are: Berty, *La renaissance monumentale en France* (Paris, 1864); Pattison, *The Renaissance of the Fine Arts in France* (London, 1879); Chateau, *Histoire et caractères de l'architecture en France* (Paris, 1864); Palustre, *La Renaissance en France* (ib., 1879-89); id., *L'architecture de la Renaissance* (ib., 1892); Lübke, *Geschichte der Renaissance in Frankreich* (Stuttgart, 1886). For Germany, consult: Fritsch (ed.), *Denkmäler der deutschen Renaissance* (Berlin, 1882 et seq.), which has plates; Lübke, *Geschichte der Renaissance in Deutschland* (Stuttgart, 1882). Other works on Renaissance architecture are: Eastlake, *History of the Revival of Architecture* (London, 1871); Smith and Poynter, *Gothic and Renaissance Architecture* (ib., 1880); Gotch and Brown, *Architecture of the Renaissance in England* (ib., 1897); Jäschke, *Die Antike in der bildenden Kunst der Renaissance* (Strassburg, 1900). Consult also the articles on the principal artists referred to in the text.

RENAIX, re-nâ'. A town of Belgium, in the Province of East Flanders, picturesquely situated, 24 miles by railway south of Ghent (Map: Belgium, B 4). It manufactures principally fine linen and damasks, woolen fabrics, tobacco, and pottery. Population, in 1900, 20,090.

RENAL DISEASE. See BRIGHT'S DISEASE; CIRRHOSIS.

RENAN, re-nân', ERNEST (1823-92). A French religious historian and Semitic philologist, born at Tréguier, in Brittany, February 27, 1823. Of his childhood he told in *Souvenirs d'enfance* (1883). He lost his father in youth and owed it to a devoted sister that he could begin with neighboring priests the studies for which his frail health seemed to designate him. He was soon summoned to Paris and promoted to Saint-Sulpice, the chief training school of the French priesthood. His belief in the Catholic teaching soon began to leave him, but not his love for its beauty, nor his regard for its worthy professors. At twenty-two he abandoned his study for orders and taught Latin in a clerical school, still aided by his sister's savings, till at twenty-five he won his doctorate with such distinction as to assure a position that was already recognized by an academic prize for an essay *Sur les langues sémitiques*. He won a second prize in 1850 for an essay *Sur l'étude du grec dans l'occident au moyen-âge*, was sent by the Academy to Italy, where he prepared an epoch-making work on Arab philosophy, *Acréolo-*

et l'arabisme (1852), and to Syria (1860), where he found inspiration for his *Vie de Jésus* (1863), the first of seven volumes that occupied him from 1867 to 1881, dealing with the origins of Christianity to the death of Marcus Aurelius. To this he added as an introduction *L'histoire du peuple d'Israël* (1888-94). Though elected professor of Hebrew in the Collège de France (1862), he was not allowed to lecture, because of his expressed unorthodoxy. This gave wide popularity to his ideas and allowed him more leisure to propagate his enthusiastic belief that politics, education, and ethics itself would be regenerated by the progress of science, especially of history and philology. The *Vie de Jésus* was widely translated; 300,000 copies were sold in France alone, and for every later work of Renan there was a popular as well as a scholarly demand. *Les apôtres* (1866) and *Saint Paul* (1869) were followed by a volume of essays on contemporary questions (1868). Then came the Franco-German war, which evoked from Renan two remarkable letters to David Strauss, the radical biblical critic of Tübingen, showing a patriotism free from every taint of Chauvinism. The Republic restored his professorship and he now published *L'Antéchrist* (1873), *Les évangiles et la seconde génération chrétienne* (1877), *L'église chrétienne* (1879), *Marc-Aurèle et la fin du monde antique* (1881). Volumes of essays with the titles *Etudes* (1857), *Essais* (1859), *Mélanges* (1878), *Nouvelles études* (1884), *Discours* (1887), accompanied or followed his more connected work. His *Drames philosophiques* were first collected in 1888. A vision of *L'avenir de la science*, written in 1848, was given to the world as a sort of parting gift in 1890. During his last years Renan enjoyed all the honors, public and private, that Paris could give to a favorite scholar. He was made grand officer of the Legion of Honor and administrator of the Collège de France, dying as he had wished, at his post, October 2, 1892. Renan saw so many sides of his subject that he was never as sure of any of them as he was of his own critical wit. He was by turns hazy, cautious, mythical, ironic, idealistic, skeptic, all with a romantic sentiment and a rosy optimism that regarded the nineteenth as "the most amusing of centuries," to be contemplated with "benevolent and universal irony." He had a lofty conception of moral duty, and held that "few persons have a right not to believe in Christianity." He knew that he himself was "a tissue of contradictions, one half fated to be employed in destroying the other," and he said this fact gave him "the keenest intellectual pleasure that man can enjoy." The clew to this psychic paradox is perhaps that Renan united two races, the Breton and the Norman, and two cultures, the ecclesiastical and the scientific, neither overcoming the other, and both possessing his mind. It is this, joined to a uniquely subtle, sensuous charm, that has made his influence a powerful one in the literature of the present generation. He typifies the skepticism of modern France, its awakening religious curiosity, its dilettante shrinking from the horrible mania of certainty, its Protean inconsistency and its easy tolerance, born of a conviction that no faith is worth a struggle, much less a martyrdom. Of Renan's works there is no uniform edition. To the writings named above may be added many linguistic studies in the *Mémoires* of the Academy and in the *Journal Asiatique*, important con-

tributions to the monumental *Histoire littéraire de la France* (vols. 24-30), translations of *Job* (1858), *The Song of Songs* (1860), *Ecclesiastes* (1881), and many lesser essays. The titles and dates of the *Philosophic Dramas* are *Caliban* (1878), *L'eau de jouvence* (1880), *Le prêtre de Nemi* (1885), *1802, Dialogue des morts* (1886), *L'abbesse de Jouarre* (1887). There are English translations of the whole *Histoire du peuple d'Israël* and of the *Origines du christianisme*, of the *Etudes* and *Nouvelles études*, of *Job* and the *Song of Songs*, and of the *Souvenirs*. For Renan's life and character consult his own *Souvenirs d'enfance et de jeunesse* (1833), his *Feuilles détachées* (1892), and *Lettres intimes* (1896); also the monographs by Bourget, in *Essais de psychologie contemporaine* (Paris, 1883); Reinach (ib., 1893); Abbé d'Hulst (ib., 1894); Scailles (ib., 1895); and Mountstuart Duff (London, 1893); also Lemaitre, *Les contemporains* (Paris, 1890-92); and Monod, *Les maîtres d'histoire* (ib., 1894).

His son **ARY** (1858—), born in Paris, became known as a landscape and figure painter and artist, and was a pupil of Delaunay and of Puvis de Chavannes. He began to exhibit in the Salon in 1880, contributed many critical essays to the *Gazette des Beaux-Arts*, of which he afterwards became secretary, and in 1900 published an interesting monograph on Gustave Moreau (q.v.).

RENDSBURG, рѣнтс'бѳрк. A town in the Province of Schleswig-Holstein, Prussia, situated on the Eider and the Kaiser-Wilhelm Canal, about 15 miles south of Schleswig (Map: Germany, D 1). It has a thirteenth-century church, a gymnasium, a Realschule, and manufactures of woollens, pianos, fertilizers, meat products, leather, and artificial stone. It carries on a considerable trade in lumber and cattle. Rendsburg is first mentioned in the twelfth century. Population, in 1900, 14,757, chiefly Protestants.

RENÉ, re-nā', surnamed 'The Good' (1409-80). Count of Provence, Duke of Anjou and Lorraine, and titular King of Naples. He was born at Angers, January 16, 1409, being the second son of Louis II, of Anjou and Provence. He married Isabella of Lorraine and claimed the succession to the Duchy of Lorraine in 1431, after the death of his father-in-law, Duke Charles. Being opposed by another claimant, the Count of Vaudemont, René was defeated and taken prisoner, remaining a captive for several years. In 1434 he inherited Provence and Anjou on the death of his brother, Louis III. In 1437 he purchased his liberty and the possession of Lorraine by the payment of an immense sum. He now led an army into Italy to secure the Kingdom of Naples, the title to the succession to which had been left to him by Louis III., who had been adopted as her successor by Queen Joanna II., by whom René had been declared heir on the death of his brother. (See JOANNA II.) He had a powerful rival in Alfonso V. (q.v.). King of Aragon, who succeeded in capturing Naples in 1442. Weary of the vain struggle, René abandoned the kingdom and returned to Provence, where his Court at Aix became a famous resort for artists and poets. He sought to revive the poetry of old Provence, and his devotion to the forms of a rapidly disappearing chivalry gained him the name of the last of the Troubadours. Agriculture and manufactures

were also encouraged and he earned his title of 'the Good.' He refused the crown of Aragon when offered to him, but allowed his son to accept it. His daughter, Margaret, married Henry VI. of England. After a long and prosperous rule, René died at Aix. He had no direct heirs and his possessions, therefore, reverted to the French Crown. For his literary productions see *Œuvres du roi René*, edited by Quatrebarbes (4 vols., Angers, 1844-46); and for his life, Leroy de la Marche, *Le roi René, sa vie et ses travaux* (Paris, 1875); Villeneuve-Bargemont, *Histoire de René d'Anjou, roi de Naples* (ib., 1825); Champollion-Figeac, *Les tournois du roi René* (ib., 1826).

RENÉE (re-nā') OF FRANCE (It. *Renata*) (1510-c.1574). A French princess, daughter of Louis XII., born at Blois, and married in 1527 to Ereole II., of the House of Este (q.v.), Duke of Ferrara. With him she differed greatly on religious matters, being a zealous patron of the Reformation, of Calvin, to whom she gave refuge in 1535, and of Bruccioli, who dedicated to her his version of the Bible in Italian. Ereole's Catholicism made his wife a subject for the Inquisition. She was imprisoned in 1554, confessed and attended mass, but after her liberation resumed her allegiance to Protestantism. After her husband's death (1559) she returned to France, and there attempted to unify the forces of Reform. Calvin wrote her many letters of counsel. Consult: Fontana, *Renata di Francia duchessa di Ferrara* (Rome, 1888-93); and Rodocanachi, *Renée de France* (Paris, 1896).

RENEVIER, рѣн'вѳа', EUGÈNE (1831—). A Swiss geologist, born and educated in Lausanne. There he became professor of geology, paleontology, and mineralogy in 1857, curator of the Vaudois Geological Museum in 1864, and a founder of the Swiss Geological Society and of the Paleontological Association (1874). Besides many important contributions to periodicals and work on the international geological chart of Europe, he wrote *Description des fossiles du terrain aptien* (1854-58, with Pietet); *Notices sur les Alpes vaudoises* (1864-79); *Carte géologique des Alpes vaudoises* (1875-77); *Orographie des Hautes Alpes* (3d ed. 1881); and *Chronographie géologique* (1896).

RENFREW. A southwestern county of Scotland, bounded on the north and west by the River and Firth of Clyde, on the south by Ayrshire, and east and north by Lanarkshire (Map: Scotland, D 4). Area, 245 square miles. Renfrew is very uneven in its surface, and consequently in the nature and quality of its soil. At the Hill of Stake, on the Ayrshire border, the land rises to 1711 feet. Over two-thirds of the arable land is devoted to dairy farming. There are extensive mineral deposits in the county, and the exportation of coal, oil, and ironstone employs a large number of people. Chief towns, Renfrew, the capital, Greenock, Port Glasgow, and Paisley (qq.v.). Population, in 1801, 78,500; in 1851, 161,100; in 1891, 230,812; in 1901, 268,900.

RENFREW. A royal, Parliamentary, and municipal burgh, capital of Renfrewshire, Scotland, on the Clyde, six miles west-northwest of Glasgow (Map: Scotland, D 4). The Renfrew Grammar School and Blythswood Testimonial, originally endowed by charter of Robert III., is



GUIDO RENI

"AURORA," FROM THE FRESCO IN THE ROSPIGLIOSI PALACE, ROME

here. The inhabitants are employed in iron-works and in ship-building. Population, in 1901, 9297.

RENI, rá'né, GUIDO (1575-1642). An Italian painter, one of the chief masters of the Eclectic School (Bolognese). Born at Calvenzano, near Bologna, November 4, 1575, the son of a musician, he was apprenticed at an early age to Denys Calvaert. He then studied under the Carracci, especially under Lodovico, but aroused their jealousy, and soon parted company with them, and applied himself to the technique of fresco painting under Ferrantini. His first short visit to Rome in 1599, in company with Francesco Albani, a friend and fellow student, was given chiefly to the study of Raphael, and after some years of further study at Bologna of nature and of classic models, we find him again at Rome in 1605. His development was marked by works very dissimilar in style, those of his early years partaking of the manner of Caravaggio, as, for example, the "Crucifixion of Saint Peter" (1606, Vatican); the "Madonna della Pietà" (Pinacoteca, Bologna); and "The Hermits Saint Paul and Saint Anthony" (Berlin Museum). From this influence, however, he soon freed himself, forming a style of his own, tinged with refined idealism, in strong contrast to the coarse realism of Caravaggio, and exemplified by the "Concert of Angels" (1608), a charming fresco in the Chapel of Santa Silvia (San Gregorio, Rome), and the world-famed "Triumph of Phœbus," generally known as "Aurora" (1609, fresco in the Palazzo Rospiglioso, ib.)—his great masterpiece of this period, unequaled in nobility of line and poetry of color.

In 1610 Pope Paul V. commissioned Guido to decorate the chapel in the Quirinal and other private chapels, which works increased his reputation, as well as the number of his enemies, even the friendship of Albani turning into antagonism. After his return to Bologna in 1612, Guido painted "Saint Paul Reproaching Saint Peter" (Brera Gallery, Milan), quite Venetian in conception; the "Massacre of the Innocents" (Pinacoteca, Bologna), a work full of vigor and resplendent in that warm golden tone characteristic of the artist's middle period; the "Apotheosis of Saint Dominic," an imposing fresco in San Domenico, Bologna; and "Four Episodes from the Myth of Hercules" (Louvre). In 1620 he decorated a chapel in the cathedral at Ravenna, and in 1621 he went to Naples, commissioned to execute frescoes in the cathedral, but was compelled by the murderous jealousy of the Neapolitan painters to flee to Rome without accomplishing his task. Forced by intrigues to leave Rome, too, in 1622, he returned to Bologna, where he became the acknowledged head of the Eclectic School, and resided until his death, August 18, 1642. The tone of his pictures gradually changed to a pale silvery gray, and in the later part of his life his manner became slight and sketchy, his constant pecuniary difficulties, caused by his inveterate passion for gambling, inducing him to paint with careless haste to retrieve his heavy losses.

The most important works of the next decade were the "Triumph of Samson Over the Philistines" (Pinacoteca, Bologna), still in his purest golden tone; a "Judith" (Palazzo Adorno, Genoa); "Fortuna" (Accademia San Luca, Rome), one of his finest treatments of female

form; and, above all, the "Rape of Helen" (c.1630, Louvre). Masterpieces in his silvery manner include the famous representations of "Saint Sebastian" (the finest in the Pinacoteca, Bologna; others in the Capitol, Rome, and in the Louvre), and the "Nativity" (Lichtenstein Gallery, Vienna, an unfinished replica in San Martino, Naples), pronounced by some authorities the artist's finest creation. Favorite subjects with him and his school were the "Ecce Homo," the most celebrated specimens of which are those in the Vienna (two), London, Bologna, and Dresden galleries; the "Cleopatra," best in the Madrid Museum and the Palazzo Pitti, Florence; and the "Penitent Magdalen," of which the Louvre and the Lichtenstein Gallery, Vienna, contain each two examples, the Madrid Museum, the National Gallery, London, and the Pinakothek in Munich, each one. The type of melancholy beauty, familiar through the supposed portrait of "Beatrice Cenci" (1599) in the Palazzo Barberini, Rome, frequently recurs in his paintings. In his art, Guido is an Eclectic, lacking in originality. From a technical standpoint his works are good, both as to color, composition, and drawing; but they are full of sentimentality, and he was one of the first to introduce the soft style so disastrous to the development of art. Consult: Bolognini-Amorini, *Vita del celebre pittore Guido Reni* (Bologna, 1839); Lanzi (Roscoe), *History of Painting in Italy*, iii. (London, 1847); Janitschek, in Dohme, *Kunst und Künstler Italiens*, iii. (Leipzig, 1879); and the authorities referred to under BOLOGNESE SCHOOL OF PAINTING.

RENIER, re-nyá', LÉON (1809-85). A French archaeologist, born in Charleville (Ardennes), and educated at Rheims. For a time he was a proof-reader and then became instructor and principal in the College of Nesle in Picardy. Then he went to Paris, taught Latin and Greek for several years, collaborated with Philip Le Bas on the *Dictionnaire encyclopédique de la France* (1840-45), and on Didot's *Encyclopédie*, and was an editor of Courtin's *Encyclopédie moderne* (1845-51). In 1860, after thirteen years in the Sorbonne Library, he became its director and in 1861 became professor of epigraphy at the Collège de France. His great educational work was the foundation of the Ecole des Hautes Etudes with Duruy in 1868. A part of Borghesi's works was edited under his care, and he took a prominent part in the excavations of the Farnesi Gardens, and in the purchase of the Campana collections. His work on the inscriptions of Gaul was not completed; his most important publication was *Inscriptions romaines de l'Algérie* (1855-58).

RENNELL, JAMES (1742-1830). An eminent British geographer and explorer, born at Upcot. He early lost his father, but found a home in the family of Mr. Burrington, vicar of Chudleigh, from whom he received his early education. When fourteen years old he joined the frigate *Brilliant* as midshipman, and five years later was an officer in the British Navy. He had already developed a love for geography by study and his many opportunities for surveying harbors and drawing charts. He made such a reputation by his harbor charts that soon after he left the navy in 1763, to take service with the East India Company, he was appointed Surveyor-General of Bengal. For the next fif-

teen years he spent most of his time in the jungle and on the plains of Bengal. The large amount of map material he collected was used in the preparation of the *Bengal Atlas*, which appeared in 1779, a work of the first importance for strategical and administrative purposes. His map of Hindustan, accompanied by about 200 pages of letterpress, appeared in 1783, and marked the time when Rennell ceased to be merely a surveyor and map-maker and became a geographer in the more extended sense. Rennell lived for the remainder of his life in London, and for fifty years, from 1780 to 1830, he was one of the leading geographers of Europe, and the great critic of geographical work and elucidator of geographical problems. Comfortably established with his wife and children in London, he began the construction of the first approximately correct map of India, and many years elapsed before it was superseded by the more accurate trigonometrical survey. He then turned his attention to Western Asia between India and the Mediterranean. He had conceived a scheme for a great work on the comparative geography of Western Asia, but he never completely carried it out, his *Geography of Herodotus*, which formed only a part of the whole project, occupying him for many years. This work has been of permanent value to geographical students.

Rennell's studies of Herodotus made him a very high authority on all matters relating to African geography, and he became the coadjutor of the African Association when that body inaugurated the modern era of the exploration of that continent. His map of Northern Africa, prepared for the use of the association, was the result of immense research combined with sagacious reasoning. He elucidated the reports of explorers, and his maps illustrated their travels. He worked up, for example, the rough notes of Mungo Park, examined his daily routes with great care, compared them critically with previous work in West Africa, and brought all the materials into harmony as far as possible. He constructed the map of the discoveries of Mungo Park. As a hydrographer, also, Rennell made important advances in the study of winds and currents, and was the founder of that branch of geography which is now called oceanography. Rennell's volume on winds and currents is based upon an enormous mass of material which he collected to illustrate the subjects. The current now known as Rennell's current, a stream in the ocean moving northward athwart the mouth of the English and Irish channels, was revealed by his study of a great number of facts collected by seamen. His wind and current charts, published only after his death, contained a large amount of information of service to mariners. His body was buried in Westminster Abbey.

RENNES, rĕn. The capital of the Department of Ille-et-Vilaine, France, at the confluence of the rivers Ille and Vilaine, 155 miles east of Brest by rail (Map: France, E 3). It is divided into the upper or new town and the lower or old town. It has remains of its mediæval walls, towers, and gates, beyond which lie extensive suburbs. Bridges unite the two divisions of the town, the older portions of which lie on the left bank of the quay-lined Vilaine. The most noteworthy buildings are the modern cathedral, whose interior is a spacious hall of Grecian architecture, the stately Palais de Justice, the

Hôtel de Ville, the Lycée, the Palais Universitaire with its fine art museum, and the handsome modern university. Tree-lined boulevards, the spacious Champ-de-Mars with a war monument commemorating 1870-71, and the Jardin des Plantes, add to the town's attractions. It carries on an active trade and has manufactures of agricultural implements, stockings, lace, sail-cloths, and earthenware. The town is the seat of an archbishopric and of a university, which has an attendance of about 1150. It was almost totally destroyed by a great fire in 1720, and was rebuilt on a modern plan. Rennes is the Celtic Condate, the capital of the Gallic tribe of the Redones, whence the modern name. Under the Romans it was an important station. In the Middle Ages it was the capital of the Duchy of Brittany (q.v.). Population, in 1901, 74,676.

RENNET (from ME. *rennen*, *rinnen*, AS. *rinnan*, *yrnan*, Goth., OHG. *rinnan*, Ger. *rinnen*, to run; connected with Lat. *rivus*, stream, Skt. *ar*, to move). A substance obtained from the fourth or digestive stomach of calves living upon milk, and also from the stomachs of puppies and pigs. The active principle is obtained from the folds of the membrane lining the stomach, and is prepared commercially by soaking this lining in warm slightly salted water, filtering the resulting extract, and adding a little salt and salt-petre to preserve it. These extracts are generally used in place of the home-made preparations formerly in use. They are of uniform strength, free from taints, and retain their strength and purity for a considerable time. The active principle, rennin, an enzyme or ferment, has the power of coagulating or curdling the casein of milk. The extracts also contain more or less pepsin, the digestive ferment of the stomach. The action of rennet is impaired by heat, and the ferment is destroyed by high heat. The principal use of rennet or rennet extract is in making cheese, where it is employed to curdle the milk, and thus form the curd. See CHEESE-MAKING.

RENNIE, GEORGE (1791-1866). An English civil engineer. He was born in Surrey, the eldest son of John Rennie (q.v.), and at the age of sixteen entered Edinburgh University. He returned to London in 1811, and began the practical study of engineering under his father. In 1818 he was appointed superintendent of the machinery of the mint, and at the same time aided his father in the planning and designing of several of his later works. After his father's death, in 1821, Rennie entered into partnership with his younger brother, John (afterwards Sir John Rennie), as engineer and machinery constructor. Their operations included the construction of bridges, harbors, docks, ship-yards, and dredging machinery, steam factories, both in Great Britain and on the Continent, and the furnishing of engines for warships of England, Russia, France, Italy, Mexico, etc. Rennie in addition was engaged in the drainage of large tracts in the midland counties of England and the construction of several Continental railways. He was greatly interested in the development of the screw propeller, and after building the engines for the *Archimedes* boat with a novel form of screw, constructed the *Dwarf*, the first screw vessel in the British Navy. He was the author of various papers published in the *Philosophical Transactions*.

RENNIE, JOHN (1761-1821). A British civil engineer. He was born at Phantassie, in Haddingtonshire, and obtained his preliminary education at the Parish school of Prestonkirk, and supplemented it by two years at Dunbar, where he studied pure mathematics. After serving as a workman he studied at Edinburgh, and in 1780 secured employment at the works of Boulton & Watt at Soho, near Birmingham. Here his mechanical genius soon displayed itself; and so highly did Watt esteem Rennie that he gave him, in 1789, the sole direction of the construction and fitting up of the machinery of the Albion Mills, London; and the ingenious improvements effected in the wheel-work, shafting, and frames were so striking that Rennie at once rose into general notice as an engineer of great promise. To this mill engineering he added, about 1799, the construction of bridges; and in this branch also his talent and ingenuity were manifest. The elegance and solidity of his constructions, the chief examples of which were at Kelso, Leeds, Musselburg, Newton-Stewart, Boston, and New Galloway, were universally admired; Rennie's greatest work of this kind was the Waterloo Bridge over the Thames. Another of his works was the Southwark Bridge, which was built on a new principle, with cast-iron arches resting on stone piers. He also drew up the plan for the London Bridge, which, however, was not commenced until after his death. He superintended the execution of the Grand Western Canal in Somerset, the Polbrook Canal in Cornwall, the canal joining the Don and Dee in Aberdeen, that between Arundel and Portsmouth, and, chief of all, the Kennet and Avon Canal between Newbury and Bath. The London Docks, the East and West India docks (see DOCKS) at Blackwall with their freight sheds, the Hull Docks, the Prince's Docks at Liverpool, and those of Dublin, Greenock, and Leith, were all designed and wholly or partially executed under his superintendence. He also planned many improvements of harbors and on the dock yards of Portsmouth, Chatham, Sheerness, and Plymouth, executing at the last-mentioned port the most remarkable of all his naval works, the celebrated breakwater. (See BREAKWATER.) Rennie died October 16, 1821, and was buried in Saint Paul's Cathedral, London. Consult Smiles, *Lives of the Engineers* (London, 1861-62; rev. ed. 1874).

RENNIE, Sir JOHN (1794-1874). An English civil engineer. He was born in London of a great engineering family, being a son of John Rennie (1761-1821), with whom he studied until 1813, when he became Hollingsworth's assistant on the Waterloo Bridge. With his father he worked on the Southwark Bridge in 1815, and after studying abroad went into partnership with his brother. John Rennie was knighted in 1831 on the completion of the London Bridge after his father's plans. He also finished his father's work as engineer to the Admiralty, building the Plymouth breakwater, and draining the Lincolnshire fens. The Whitehaven and Cardiff docks and the restoration of Boston harbor are the most important of his original works. Rennie was an able hydraulic engineer and author of *Theory, Formation, and Construction of British and Foreign Harbors* (1851-54). Consult his autobiography (London, 1875).

RENO. The largest city of Nevada and the county-seat of Washoe County, 31 miles south

of Carson City; on the Truckee River, and on the Southern Pacific, the Virginia and Truckee, and the Nevada, California and Oregon railroads (Map: Nevada, D 2). It is the seat of the Nevada State University, opened in 1886; and among other features are the United States Government Agricultural Experiment Station and the Nevada State Hospital for Mental Diseases. Reno is situated in a section devoted to farming, mining, and stock-raising, and is the most important business and industrial centre in the State. Settled in 1868, Reno was incorporated in 1897, but was disincorporated two years later. It received its present city charter in 1903. Population, in 1890, 3563; in 1900, 4500.

RENO, JESSE LEE (1823-62). An American soldier, born at Wheeling, Va. (now W. Va.). He graduated at West Point in 1846; was brevetted second lieutenant of ordnance; and soon afterwards was ordered to the front in Mexico, where he fought under General Scott from Vera Cruz to the City of Mexico. From that time until 1861 he was employed in various routine duties and advanced to be captain. On the outbreak of the Civil War he was commissioned brigadier-general of volunteers and was assigned to a brigade in General Burnside's North Carolina expedition (December 20, 1861-April, 1862), with which he participated in the capture of Roanoke Island, and the actions of New Berne and Camden. For these services he was promoted to be major-general of volunteers, and in August was ordered north to Virginia, where he fought in the second battle of Bull Run and at Chantilly. During the succeeding Maryland campaign he commanded the Ninth Corps, and was killed leading his men at the battle of South Mountain.

RENOIR, re-nwâr', AUGUSTE (1841-). A French figure and landscape painter, born in Limoges. He studied in the atelier of Gleyre and with Monet and the other Impressionists, and exhibited in 1874 at the first Impressionist Salon. Renoir is one of the most distinctive of the group, and, like Degas, devoted himself principally to figures, especially portraits of young women and children, in which he renders the texture of flesh and the most fleeting shades of expression with astonishing adroitness. His figures are painted out of doors, and are subject to every variation of light and reflection. He also painted landscape, fruit, and flower subjects, and groups of figures. His paintings include: "La loge;" "La danse;" "Danse à la ville;" "Le déjeuner à Bougival;" "La balançoire;" "Le pont de Chatou;" and "Jeunes filles au piano." Among his portraits are those of Wagner and Claude Monet. Consult: Duret, *Les peintres impressionnistes* . . . (Paris, 1879), and Alexandre, *Catalogue de l'Exposition de A. Renoir* (Paris, 1892).

RENOUF, re-nōōf', EMILE (1845-94). A French landscape, marine, and genre painter, born in Paris. He was a pupil of Boulanger, Lefebvre, and Carolus Duran. His works usually represent scenes in the lives of fisherfolk or purely marine subjects. "The Helping Hand" (in the Corcoran Gallery at Washington, D. C.), a boatman rowing while his child holds the oar, is one of his best-known works. He also painted several views near Honfleur, and a picture of the

Brooklyn Bridge (in the Havre Museum), done while he was in New York City in 1887-88. He received a medal of the first class at Munich in 1883 and the Legion of Honor in 1889.

RENOUF, Sir PETER LE PAGE (1822-97). An English Egyptologist, born in the island of Guernsey, August 23, 1822. He received his early education at Elizabeth College and went later to Oxford, where he formed a lasting friendship with the Rev. John Henry, afterwards Cardinal, Newman. He took an active part in the Tractarian controversy, and in 1842 was received into the Roman Catholic Church at Saint Mary's College, Oscott, where he began the study of Oriental languages together with theology and philosophy. In 1846 he undertook the tuition of the young Marquis de Vaulehier, and until 1855 resided on the Continent, where he formed the acquaintance of many of the most distinguished scholars of the time. From 1855 to 1864 he was professor in the Catholic University at Dublin, lecturing at first upon French literature and the history of philosophy, and later upon ancient history and Oriental languages. It was during this time that he took up the study of Egyptian, and he soon became one of the foremost as well as one of the most conscientious and reliable Egyptologists of his day. In 1864 he left the university to accept an appointment from the Government as one of the chief inspectors of schools, a position which he held for over twenty years. He visited Egypt in 1875 and spent some time there studying the monuments. From March, 1886, until the end of 1891 he was keeper of the Egyptian and Assyrian antiquities in the British Museum, and in 1896 he was knighted in recognition of his distinguished scholarship. From 1887 until his death he was president of the Society of Biblical Archaeology. He died in London, October 14, 1897. Renouf was a versatile scholar, and in addition to his Egyptological attainments he possessed a knowledge of most of the ancient and modern Semitic, Indo-European, Berber, and Finnic languages. In his later years he also became a student of Chinese. He was a very prolific writer and contributed a large number of valuable articles to *Atlantis*, *Proceedings of the Society of Biblical Archaeology*, *Zeitschrift für ägyptische Sprache*, and other periodicals. He also translated a number of Egyptian texts for *Records of the Past*. In 1879 he delivered the second course of the Hibbert Lectures, and the following year he published his *Lectures on the Origin and Growth of Religion, as Illustrated by the Religion of Ancient Egypt* (1880; 2d ed. 1884). Renouf's great work was his masterly translation of the Egyptian Book of the Dead (q.v.), the study of which formed his chief occupation for nearly forty years. The translation, accompanied by a valuable commentary, was published serially in the *Proceedings of the Society of Biblical Archaeology* (vol. xiv., 1892, et seq.) and was unfinished at his death, but was completed from the author's manuscript notes by E. Naville (q.v.). A biography of Renouf and a full bibliography of his writings are to be found in *Proceedings of the Society of Biblical Archaeology* (vol. xix., London, 1897).

RENOUVIER, re-nōō'vyá'. CHARLES BERNARD (1815—). A French philosopher and politician. He became known through his *Manuel de*

philosophie moderne (1842) and his *Manuel de philosophie ancienne* (1844). After the Revolution of 1848 he published a *Manuel républicain de l'homme et du citoyen* (1848), which was condemned for its socialistic propositions. He retired from public life after the coup d'état of 1851. From 1872 until 1900 he was associate editor of *La Critique philosophique*, and he published *Essais de critique générale* (1854), *Science de morale* (1869), and *Esquisse d'une classification systématique des doctrines philosophiques* (2 vols., 1885).

RENOVO. A borough in Clinton County, Pennsylvania, 28 miles northwest of Lock Haven, on the Philadelphia and Erie division of the Pennsylvania Railroad (Map: Pennsylvania, D 2). It is of some importance as a summer resort, being situated near the Alleghany Mountains, in a picturesque region. There are valuable deposits of bituminous coal and fire clay, and manufactories of fire brick; shops of the Pennsylvania Railroad are here. Population, in 1900, 4082.

RENSELAER, rēn'se-lēr. A city in Rensselaer County, New York, on the Hudson River, directly opposite Albany, with which it is connected by three bridges, and on the New York Central and Hudson River and the Boston and Albany railroads (Map: New York, G 3). It is situated in an agricultural and dairying region, and manufactures felt, leather, ice tools, chains, shirt waists, and lumber products; but is important chiefly as a railroad town, having shops, round-houses, freight yards, etc. Rensselaer was chartered as a city in 1897, having been known formerly as Greenbush, which was incorporated as a village in 1815. In 1902 the village of Bath, with a population in 1900 of 2504, was annexed to Rensselaer. Population, in 1890, 7301; in 1900, 7466.

RENSELAER POLYTECHNIC INSTITUTE. A school of engineering and science at Troy, New York, founded by Stephen Van Rensselaer in 1824 as Rensselaer School and reorganized in 1850 under the present name on the basis of a general polytechnic institute. It was the first school of science and the first school of engineering established in any English-speaking country, and has long been famous for its engineering courses. Opportunities for investigation and research are offered by the many well-known engineering works within reach of the school. In 1902 the electrical and chemical laboratories were destroyed by fire, but were rebuilt, and with the other laboratories are equipped with machinery and appliances of the most modern type. The students in 1903 numbered 309 and the faculty 20. The Institute owns valuable collections and a scientific library of 6700 volumes and 3500 pamphlets.

RENT (OF., Fr. *rente*, It. *rendita*, income, from ML. *rendere*, nasalized form of Lat. *reddere*, to restore, return). In political economy, the term rent, when used without a qualifying phrase, refers to the payment which is made for the use of land. In the payments popularly known as rent are usually included two elements, one of which may be classed as interest on buildings and other improvements, the other as economic rent. The economic rent of any given piece of land is measured by the difference between the prices which its products obtain and the cost of

the labor and capital employed in producing them.

Assuming the conditions of a new community with an abundance of accessible land, good and bad, it is obvious that so long as the produce of the best land is more than sufficient to satisfy the community's wants there will be no rent. Producers will be on an equality, and if any difference exists between the value of the product and the costs of production in labor and capital, it will be the same for all. As population increases the product of the best grade of lands no longer suffices to satisfy the want for food. Prices of food will rise until it will pay to bring inferior lands under cultivation. Permanent prices will have to be sufficient to cover costs in labor and capital upon these inferior lands. Since the cost of production on the better land does not increase, a surplus value will emerge in the produce of these lands. This surplus value is rent. If the owner of the better land cultivate the ground not in person, but by tenants, this surplus is what the latter can afford to pay the landlord for the use of his land. If the favored producers are themselves cultivators, they receive the rent directly in the increased returns of their husbandry.

This simple illustration suffices to explain the law of rent, which may be briefly stated as follows: Rent of land is the difference between the cost of the product and its value, the latter being determined by the cost of production upon the poorest land cultivated. In an isolated community the increase of population and the resulting pressure upon the food supply must always enhance rent, as cultivation must be extended from better to poorer soils. In other words, the pressure of population upon the means of subsistence creates rent on those lands where the means of subsistence can most easily be produced. Again we may assume all the available land of the community to be in cultivation and yet the pressure upon the means of subsistence increases. Now even if all the land were uniform in quality but deficient in quantity rent must appear. No increase of product can be obtained without application of additional labor and capital to the soil. This will not be so fruitful as the first application, and hence the latter must yield a rent. In this phase the law of rent may be stated as follows: The rent of land is the difference between the value of the product and its costs, value being determined by the costs of production for the product due to the least fruitful increment of capital and labor employed in cultivation. It follows that rent is a result, not a cause of price. This principle was demonstrated by Ricardo and until recent decades was thought to establish a perfectly clear distinction between rent and other economic incomes. The rise of the Austrian school of economists (see *POLITICAL ECONOMY*) has, however, tended to break down this distinction in incomes. Labor and capital, like land, receive their value from their product. While it is true that no form of goods will long be produced which does not pay the prevailing rates of interest and wages, it is no less true that an agricultural product will not be produced unless it pays the ordinary rate of rent.

One of the most important practical principles that have been deduced from the demonstration of the law of rent is that a tax levied upon rent

or upon the value of land, which represents merely the capitalization of the rental value, cannot raise the price to the consumer of the product of the land. This principle has served as a basis for the plan of social reform of Henry George. (See *SINGLE TAX*.) The fact that every increase in population or in capital increases the return to the landlord quite without his own efforts served as an ethical justification for a plan of appropriation to the State of ground rents. Recent economic theory has widely extended the application of the theory of rent. Since the time of Senior (q.v.) the term has been frequently applied to the net income from monopoly advantages, whether natural or legal. Profits (q.v.) are frequently classed as a form of rent; and Clark applies the term to any form of income which may be described differentially.

In the language of Marshall, "the rent of land is no unique fact, but simply the chief species of a large genus of economic phenomena; the theory of the rent of land is no isolated economic doctrine, but merely one of the chief applications of a particular corollary from the general theory of demand and supply." The theory of the rent of land occupies a large space in all systematic presentations of political economy. A compact statement is found in Walker, *Land and Its Rent* (Boston, 1883).

RENT. In its most ancient as well as its modern sense, compensation payable by a tenant to his landlord for the land held of him. Rent has never been an incident of tenure, but even under the feudal system of land-holding and when due from tenant in fee simple to his lord, rent was due only as matter of contract. It was, indeed, the service agreed by the feudal tenant to be performed (*servitium redditum*), which might or might not include a money payment, and which varied according to the tenure upon which the land was held, according to the custom of the manor of which it formed a part, or according to the will of the parties.

In much the same way the obligation of the modern tenant for life or years to pay rent to his landlord is based entirely on agreement expressed in the lease or implied from the acts of the parties as to the time and manner as well as the duty of payment. This being so, a failure to pay rent does not ordinarily affect the relation of landlord and tenant so as to enable the landlord to enter and terminate the lease, nor can a tenant by terminating the relation of tenure between himself and his landlord (as by assigning his entire estate to a third person) relieve himself of the obligation to pay the rent agreed. Rent is equally independent of any other violations of duty by either party, excepting only the breach of the covenant for quiet enjoyment implied in every letting of lands.

As already indicated, a failure to pay rent does not in and of itself involve a forfeiture of the tenant's estate. The landlord's proper remedy is an action at law for the rent due. At common law, however, he was provided with a more efficacious remedy in the process known as levying a distress. See *DISTRESS*.

The rents described by Blackstone in his famous chapter on incorporeal hereditaments (Blackstone II. 41-43), as "certain profits issuing yearly out of lands and tenements corporeal," are obviously a very different thing from those which have just been described. The rent here

referred to is a right in the nature of an easement, or more accurately a profit à prendre, in the land of another, and it comes into existence, not by agreement or in connection with a lease, but, as such incorporeal rights always do, by grant or prescription. The right to take the rent is a species of real property which may be held, like any other estate, for life or years or in fee, and which is capable of alienation, and, if held in fee, of transmission by inheritance. The common law distinguished three kinds of such rents, viz. rent service, rent charge, and rent seck. The *rent service* was merely the old feudal rent surviving into a period which had forgotten its origin. It existed only when lands were held by one of another in fee, and where, accordingly, the rent due was in the nature of a feudal service. The *rent charge* is the rent just described as arising by grant of the owner of the land on which it is charged. The distinguishing characteristic of this was the fact that it was enforceable by distress. The *rent seck* was merely the rent charge without the power of distress annexed. Of these three forms of rent the rent service is obsolete, excepting, perhaps, in a few manors in England (see QUIT-RENT); rent charge survives unchanged except where distress has been abolished, and there all rents charged on land by deed or will are properly rents seck. It is to the class of rents charge, rather than of contract rents, that we must refer the so-called *fee-farm rents*. See FEE.

Consult the *Commentaries* of Blackstone and Kent; Williams, *Law of Real Property* (19th ed., London, 1901); Maine, *Early History of Institutions* (Amer. ed., New York, 1895). See INCORPOREAL; HEREDITAMENTS; LANDLORD AND TENANT; LEASE.

RENUNCIATION. In law, the disavowal or abandonment of an official or property right. Of the latter class are the renunciation by an heir, devisee, or legatee of the property, real or personal, to which by operation of law or under the will of his testator he is entitled. Of the former class is the more frequent case of the refusal by an executor, administrator, or trustee of the office conferred upon him. The formality of renunciation is in either case of the simplest character, a letter or other written expression of intention being the usual form. In Scotland the term renunciation is employed to denote the surrender (q.v.) of an estate for life or years to the landlord.

REN'WICK, JAMES (1662-88). A Scottish Covenanter, born at Moniaive, Dumfriesshire. He was a student at Edinburgh University, but received no degree there, because of his refusal to acknowledge Charles II. as head of the Church, and therefore finished his theological education at Groningen, Holland. In 1683 he returned to Scotland and began preaching at conventicles. He was outlawed for his collaboration with Alexander Shields in *An Informatory Vindication of the Covenanters* (1684). In 1687 he had become the virtual leader of the Cameronians, who were excluded from the Act of Toleration, and was finally captured and executed at Edinburgh.

RENWICK, JAMES (1818-95). An American architect. He was born in New York and educated at Columbia College. He constructed the

distributing reservoir of the Croton Aqueduct in New York City and was for some years an architect on the Erie Railroad. Among the buildings designed by him are Vassar College, Poughkeepsie, New York; Saint Patrick's Cathedral, Grace, and Calvary Church, New York; and the Smithsonian Institution and Corcoran Gallery at Washington. He left a valuable art collection to the Metropolitan Museum.

REPAIRS. In the law of real property, such acts of construction and amendment as are necessary to keep the buildings of an estate from deterioration and decay. By the common law of England and America the obligation to repair rests on the tenant in possession, whether his estate be for life or years. It is, in fact, an incident of such a tenancy and flows from the doctrine of waste, and this includes the wholesale restoration of premises destroyed by fire, as well as current repairs called for by ordinary uses or mere lapse of time, excepting where (as now generally in the United States) this harsh rule of the common law has been modified by statute. The obligation to repair does not extend to a tenant at will or at sufferance, nor to a joint tenant or tenant in common (whether in possession of the premises or not), nor generally to a mortgagee in possession.

This common-law obligation of the tenant to keep the premises in repair is sometimes varied by local custom and more frequently by agreement of the parties. See EVICTION; LANDLORD AND TENANT; LEASE; WASTE.

REPARATION (Lat. *reparatio*, from *reparare*, to restore, repair, from *re-*, back again, anew + *parare*, to prepare). In law, the redress of an injury by making compensation therefor, or by restoring something which has been unlawfully taken from one entitled to its possession. See DAMAGES.

REPEAL (OF. *rapeler*, Fr. *rappeler*, to recall, revoke, repeal, from *re-*, back + OF. *apeler*, Fr. *appeler*, to call, appeal, from Lat. *appellare*, to address, appeal, to call, summon). The obliteration or abrogation of a statute by another act of a legislative body. Where an act declares in positive terms that another shall be abrogated, it is said to be an *express* repeal, but where a statute contains absolutely inconsistent provisions with a prior one, and does not refer to it directly, it is said to repeal the latter by *implication*. It is in the latter class of cases that the greatest difficulty arises. The provisions of the subsequent act must be absolutely contrary or repugnant to those of the former, so that it is clear that they must have been intended to supersede the former, in order to work out a repeal by implication. An act may repeal only portions of another, and the provisions not thus expressly repealed will continue in force. The same is true where a subsequent statute is only inconsistent with a former one in some provisions. Where it is desired to alter some of the provisions of an act, it is usually *amended*, by striking out some part of it and substituting new provisions. An amendment, therefore, is a change or alteration, whereas a repealing act abrogates or wipes out the provisions of the statute to which it applies. Under the common law the subsequent repeal of an express repealing act has the effect of restoring or reviving the statute which had been abrogated by the latter, but this

rule has been abolished in England and many of the United States.

REPEATING RIFLE. See SMALL ARMS.

REPENTANCE (OF., Fr. *repentance*, from ML. *repentens*, repentant, from Lat. *re-*, back again, anew + *pœnitere*, to repent, frequentative of *pœnire*, *pœnire*, to punish, from *pœna*, punishment, expiation, pain, from Gk. *ποινή*, *poinë*, punishment; connected with Gk. *τίωαι*, *tinēin*, Skt. *ci*, to avenge). Sorrow for sin and renunciation of the same. It is intimately connected with faith (q.v.), since faith is the turning of the soul toward God, and repentance is the same act considered as a turning away from sin. It is synonymous with conversion when used of the original and decisive abandonment of sin which marks the beginning of the Christian life; but, unlike conversion, which occurs but once, daily repentance should follow daily sins. It is a consequent of regeneration (q.v.), which is God's act calling forth repentance and conversion. Adequate repentance embraces all sin as such, known or forgotten, and involves the condemning sentence of conscience and the voluntary activity of the will in forsaking it, and both choosing and executing acts of holiness in its place. The motive leading to an evangelical repentance must be nothing short of a perception of the evil of sin in itself, as violating the law of conscience and of God. Any lesser motive, as sense of danger or fear of the wrath of God, is not sufficient to produce a true repentance, which must embrace the love of God and sincere submission to His holy will. Every act of repentance involves a new girding up of the soul to new resistance to temptation. Such repentance is always accepted of God and followed by the divine forgiveness.

REPHAIM, *rêf'â'im* or *rê-fâ'im* (Heb. *rêph-âim*). (1) A popular name of the prehistoric inhabitants of Palestine, especially to the east of the Arabah (q.v.). The Hebrew *râphâ* means 'weak,' and hence is used of the shades of the dead (e.g. Is. xiv. 9). The term appears to have been applied to the early legendary inhabitants, whose ghosts were supposed still to haunt their ancient homes. But the myth-making process magnified them into giants, and the word received this connotation. In this sense the word may be used in II. Sam. xxi. 16 et seq. Most definite are the interesting antiquarian notes in Deut. ii. 10, 20, where reference is made to the predecessors of Moab and Ammon, and they are described as a gigantic folk; compare the tradition concerning the Anakim, whom Israel encountered in South Palestine (Num. xiii. 33). In Deut. iii. 11, Og, the King of Bashan, is recorded as a descendant of this gigantic race, and the proof of his stature is given in an enormous bedstead of iron. These notes are paralleled by the ethnology of Gen. xiv. Consult Driver, *Commentary on Deuteronomy*, p. 40 (London, 1895). (2) *The Valley of Rephaim*. The scene of the two battles in which David broke the power of the Philistines (II. Sam. v. 18, 22; xxiii. 13; I. Chron. xiv. 9 et seq.); also famous for fertility (Is. xvii. 5). The location is given in Josh. xv. 8, 9; xviii. 16, as contiguous to the Valley of Hinnom, and is identified with the broad valley running for two miles southwest from Jerusalem, a strategic vantage-point for the invaders, and also afford-

ing coöperation with the non-Israelitish city of Jerusalem. Some would associate the name with the race of the Rephaim.

REPH'IDIM (Heb. *Rêphidim*, probably refreshments, from *râphad*, to support, succor). A station in the route of Israel through the peninsula of Sinai (Exod. xvii. 1, 8; xix. 2; Num. xxxiii. 14 et seq.). It was the scene of a rebellion of the people for lack of water, which Moses supplied by a miracle, whence, according to tradition, the names Massah (tempting) and Meribah (striving) were given to the place. Here Israel routed Amalek by miraculous interposition, an account of which was recorded in writing. Here Jethro, Moses's father-in-law, paid him a visit. But, as in the case of most of the Sinaitic stations, no local tradition of the name survives. It has often been identified with the oasis of Feiran, north of Mount Serbal; it would be a fitting prize of war between Amalek and Israel, but, on the other hand, the lack of water does not agree with the nature of the oasis. The modern theory, which takes the Exodus through the northern part of the peninsula, finds there no tradition of the name. Consult: Robinson, *Biblical Researches*, vol. i. (Boston, 1841); Palmer, *Desert of the Exodus* (Cambridge, 1871).

REPIN, *ryâ'pîn*, ILIA YEFIMOVITCH (1844—). A noted Russian painter, born in the Government of Kharkov. The son of a poor Cossack officer, he was first instructed by an obscure painter in his native place, and soon earned a living by painting saints' images until enabled, in 1865, to attend the Academy at Saint Petersburg, where his "Raising of Jairus's Daughter" (1871) brought him the great gold medal, accompanied by a stipend entitling him to study abroad for six years. His real master, however, had been Ivan Kramskoy (1837-87). Before starting on his travels, he painted (1872) at Moscow a series of life-size portraits of Russian, Polish, and Czech composers for a concert hall, and in 1873 he exhibited in Vienna the "Burlaki" (Barge-men on the Tow-path), a remarkable work. His best picture, dating from his foreign sojourn, was "Szadko in the Wondrous Realm of the Sea," based upon a national legend. For this he was elected a member of the Academy (1876), where he subsequently became professor. Among a series of historical and legendary subjects and genre scenes which followed, the best known are: "The Czarevna Sofia at the Chapel-Window" (1879); "Return of the Dying Soldier" (1883); "Back from Siberia" (1884); "Ivan the Terrible and His Slain Son" (1885), and "Saint Nicholas Staying an Execution" (1889), the last two in the Alexander Museum, Saint Petersburg. After 1886 he devoted himself almost exclusively to portraiture, his subjects including Liszt, Rubinstein, Garshin, Pissemski, and Tolstoy. Characteristic of Repin's earlier work is the element of gloom and oppressiveness. He interpreted what he saw of the dumb, patient suffering around him, and, like Tolstoy, had the profoundest compassion for humanity. A happier atmosphere pervades some of his later pictures, and technically all his works exhibit great power and freedom of treatment, subsiding occasionally even into impressionism. A humorous note—unusual in this artist—is sounded in the "Holiday

Evening" (1881) and "Country Life in the Crimea" (1888). The Tretyakoff Gallery in Moscow preserves more than fifty of his paintings. Consult the monograph by Norden (Vienna, 1894); Haggood, "A Russian National Artist," in *The Century Magazine*, xxiii. (New York, 1892); and Muther, *A History of Modern Painting*, iii. (ib., 1896).

REPLEVIN (OF. *replevin*, from *replevir*, from ML. *replivire*, to warrant, pledge, from *re-*, back again, anew + *plivire*, *plegiare*, to pledge). An action brought to recover the possession of goods and chattels unlawfully taken, or wrongfully detained. Under the old common law practice it was only employed to recover back goods which had been unlawfully taken from the owner, as by the ancient proceeding of distress for rent, and *detinue* was used for the recovery of chattels unlawfully detained. To-day in most jurisdictions *replevin*, or some action of like nature, is employed for the recovery of chattels wrongfully withheld. In the action a writ is issued for the seizure of the goods, and the plaintiff is required to file a sufficient bond to cover damages which may result to the defendant. The defendant may by statute in some States give a bond and retain possession until the action is determined. Any person who is entitled to the possession of property may maintain the action, and the defendant must rely on the strength of his own rights rather than on the weakness of the plaintiff's title. The plaintiff should allege in his complaint or declaration the value of the chattels, and what damage he has sustained, and in such case is entitled to an alternative verdict and judgment commanding the return of the goods, and if that is not possible, the payment of their value, and in each case damages for their detention. The defendant must return the goods if possible, and he does not have the option of paying their assessed value instead. If the defendant is successful he is entitled to recover such damages as he has sustained, and may sue on the plaintiff's bond. *Replevin* is a possessory action and corresponds to ejectment (q.v.) as to real estate. See CHATTEL; DETINUE; TROVER; PROPERTY.

REPLICA. See COPY.

REPORT. A written or printed account of a case which has been judicially determined. Such an account, in the most complete and accurate reports, is usually composed of a brief statement of the facts of the case prepared by the editor or the reporter, a brief summary of the arguments of counsel, including a statement of the authorities cited by them on the argument or in their briefs, and the opinion of the court. The opinion also frequently contains a statement of the facts, a statement of the court's decision of the case, and the reasoning and the authorities upon which the decision is based. The report of the case may also include dissenting opinions. The value and use of precedents in the English common law (see PRECEDENT) make the careful preparation and preservation of reports of decided cases of the highest importance. Beginning with the reports of cases contained in the Year Books (Edw. II. to Henry VIII.) there is a complete series of reports of cases decided in the higher English courts down to the present time. In each of the United States there are published reports of all cases decided by the courts having appellate jurisdiction, going back to the date

of their organization; and there are also complete reports of the cases decided in the United States Supreme Court and the inferior Federal courts having appellate jurisdiction since their creation under the United States Constitution.

The Year Books were prepared at public expense by scribes of court or reporters who were appointed to that duty, a function which unfortunately was abandoned at the close of the reign of Henry VIII. After that time the reports were the work of private lawyers, and they sometimes bear evidences of hasty and inaccurate preparation. Some of them, however, prepared by lawyers of great learning, are of the highest value as authorities. The various editors of English reports number in all about one hundred. The following are a few of the more important early law reports following the Year Books: Dyer (1513-82), Coke (1572-1618), Hobart (1603-25), Croke (1582-1641), Yelverton (1603-13), Saunders (1678-84), Vaughan (1665-74), Raymond (1694-1734), Salkeld (1689-1712), Strange (1716-49), East (1800-12). The first chancery reports were published after the Restoration, although West's *Symbology*, published in the latter part of the reign of Elizabeth, contained some precedents of process, bills, and answers in chancery. The first chancery reports, entitled "Reports of Cases Taken and Adjudged in Chancery in the Reign of Charles I., Charles II., James II., William III., and Queen Anne," were inaccurate and of little value. Of the other early chancery reports the following are the more important: Vernon (1680-1719), Peer Williamson (1700-35), Vesey, Sr. (1746-1856), Vesey, Jr. (1789-1817), and Atkyns (1736-54).

In the United States generally, reports of cases are now published by public officials appointed for that purpose by the court, and in those States in which the law and equity systems have been merged, law and equity cases are published together. The increase in volume of litigation has resulted in recent years in an enormous increase in the number of reports, and has led to the consideration of various plans for curtailing their number.

Consult: Wallace, *The Reporters Chronologically Arranged with Occasional Remarks on Their Respective Merits*; Daniel, *History and Origin of Law Reports* (London, 1884); Wambaugh, *Study of Cases* (Boston, 1884). For a complete list of reports, see Soule, *Lawyers' Reference Manual of Law Books and Citations* (Boston, 1884).

REPOUSSÉ (Fr., beaten back). A process of ornamenting thin metal by producing a pattern or design with a hammer. The finest existing specimens of this work are those of Benvenuto Cellini (q.v.), made in the sixteenth century. The art was extensively practiced by the early Egyptians and Etruscans.

In repoussé work a hammer with an elastic handle is used, which is screwed to a permanent support. Many adjustable heads are provided to suit the different parts of the work. After the pattern is roughly hammered up from the inside the design is perfected on the outside with chasing tools. In order to make this possible, a bed of some soft but resisting material is used to furnish a support for the thin, pliant metal. If the work is a hollow vessel it may be filled with melted pitch, which is permitted to harden.

This art is most successfully applied to such malleable metals as gold, silver, copper, tin, and lead. A similar effect, though lacking in artistic merit and in individuality, is produced by stamping with dies. See DIES AND DIE-SINKING; EM-BOSSEING.

REPPLIER, AGNES (1855—). An American essayist of French descent, born in Philadelphia, Pa., April 1, 1855. Miss Repplier was educated at the Convent of the Sacred Heart at Torresdale, Pa. She is known for her travels and for many articles in such magazines as *Scribner's* and the *Atlantic Monthly*. Her lively essay style often deals with serious subjects in a vein of light, humorous banter, sometimes tinged with extravagant and witty irony. Her published volumes include: *Books and Men* (1888); *Points of View* (1892); *Essays in Miniature* (1892); a *Book of Famous Verse* (edited, 1892); *Essays in Idleness* (1893), perhaps her most popular work; *In the Dozy Hours, and Other Papers* (1894); *Varia* (1897); *Philadelphia: The Place and the People* (1898); *The Fireside Sphinx* (1901).

REPRESENTATION (Lat. *representatio*, from *repræsentare*, to represent, from *re-*, back again, anew + *præsentare*, to present, from *præ-sens*, present, pres. part. of *præesse*, to be at hand, to be before, from *præ*, before + *esse*, to be). In political science, the agency through which the collective will of the people is exercised. In the city States of Greece and Italy, where pure democracies prevailed, all the citizens, in theory at least, attended the public assemblies. The comparatively small geographical area of the city State and the relatively small number of persons vested with the full rights of citizenship made it possible to govern without resort to the agency of representation. Besides, government was a simple matter then as compared with the government of a modern community, and hence the body of citizens meeting at intervals could without difficulty frame the few police regulations that were necessary and administer justice among the inhabitants. The agency of representation was first extensively employed by the Church in the ecumenical councils which it called from time to time, and this may have led to its more general employment for purposes of civil government. The idea of political representation, like many other political institutions, was a contribution of the Teutonic nations, by whom it was employed in a rude way in their popular assemblies. The first European legislature founded on the principle of representation was the Parliament of England. (See PARLIAMENT.) In 1302 Philip the Fair, King of France, summoned representatives of the three estates, nobility, clergy, and commons, to form the States-General (q.v.). In Aragon the Cortes (q.v.) acquired a very important share in the government, and grew to be powerful enough to impose its will upon the monarch. In other countries of Europe about the same time national representative bodies were summoned by royal authority. The mediæval idea of representation was representation of classes and interests rather than of numbers, which is the basis of the modern idea. Each order had its own representatives, who sat apart and carried on their work independently, one class thus being able to neutralize the action of the others. A distinction was made in Eng-

land between rural and urban constituencies, each having its own representatives, and this is still perpetuated.

With regard to the principle of representation it may be said that the civilized nations have reached a consensus that the distribution of representatives, in one branch of the legislature at least, should be on the basis of the whole population, though some regard is frequently paid to permanent administrative or local divisions, partly for historical reasons and partly as a concession to local consciousness. Thus it is a common provision in national constitutions that each State or other division shall have at least one representative in the national legislature, although on the basis of population alone it would not be so entitled. (See section on *Government*, under the various countries.) In the upper chambers of lawmaking bodies throughout the world there is considerable diversity in the principle of representation. See LEGISLATURE.

As regards the relation of the representative to his constituency, a popular view is that the representative is the mouthpiece of his constituency and subject to their instructions. According to this view he has no independent judgment, and cannot follow the convictions which he may have reached from the most exhaustive study and reflection, if the will of his constituency be otherwise. Moreover, their own local interests are to be preferred to those of the country at large, and it is his first and foremost duty to champion those interests in preference to the national interests. A sounder view regards the representative as the interpreter of the common consciousness of right and reason. According to this view the representative is not bound by the will of his constituency, but by research and reason endeavors to discover what the general good requires. The question has been much discussed as to whether a system of representation based on mere numbers is an ideal one or even a just one. By many it is contended that an equitable system of representation would take into consideration various interests, economic, industrial, social, and religious as well as political. They insist that provision should be made for special representation of such classes as free-traders, single-tax adherents, labor organizations, civic federations, business leagues, chambers of commerce, the advocates of temperance and prohibition, socialists, etc. The tremendous tendency toward class differentiation and the growing popularity of independent movements in politics, it is said, make a reform of the present system of representation highly desirable so as to harmonize conflicting interests, to enable each class to show the people what its interests are, and to defend them against attack.

By the present system, the political party having a minority of voters in a given electoral district is generally unrepresented in the government, notwithstanding the fact that its numerical strength may lack but a few votes of equaling the party which secures the entire representation. As a result of this system, it frequently happens that the minority party in a State is inadequately represented in the State legislature or in Congress. To remedy these inequalities various methods have been proposed, and in some cases attempted. Of the more important of these the first to be mentioned

is the so-called 'limited vote,' according to which each voter in an electoral area is allowed to vote for a certain number of the candidates, usually one less than the number to be elected, so that if three members are to be elected from the district the minority is reasonably sure of electing one member. This method may be employed only in elections in which three or more representatives are to be chosen from the district. The chief objection to this method is that it does not allow the minority party proportional representation, but only limited representation. Moreover, it allows representation only to a very large minority and makes no provision for third parties and independent movements. Another method is the so-called 'cumulative vote,' which allows the elector as many votes as there are representatives to be chosen from the district, and which permits him to distribute them among the different candidates as he pleases, or cumulate them on one or more candidates. The advantage of this method over the first mentioned is that it enables a small minority to elect at least one member by cumulating their votes. Since 1870 it has been employed in Illinois for the election of representatives in the Legislature. The chief objection to this method is that it frequently involves a waste of votes, since a popular candidate may receive many more votes than actually necessary to elect him. As a result of this it may happen that the minority party actually succeeds in electing two representatives out of three.

What is known as the Hare or André system, so called because proposed by an Englishman named Hare, and introduced into Denmark by André, provides for the election of representatives by general ticket, and allows each elector to vote for one candidate or for a limited number, but permits him to indicate his second and third choices, etc. The total number of votes cast is divided by the number of representatives to be chosen, and the quotient is taken as the amount necessary to elect any candidate. In counting the ballots only the first choices are counted, and as soon as a candidate has received a number of votes equal to the electoral quotient he is declared elected, and no more votes are counted for him. The remaining ballots which designate him as first choice are then counted for the candidate having second choice, and so on down the list until the necessary number of persons have been declared elected. Under this system the waste of votes is insignificant, but its complexity is an objection, and the element of chance enters into the scheme. Finally there is the 'free list' system, according to which a certain number of voters may nominate a number of candidates not exceeding the number of places to be filled. Each voter casts as many votes as there are representatives to be chosen, distributing them at will, but not cumulating them on any one candidate. The number of votes necessary to elect is determined by dividing the total vote cast by the number of places to be filled. The total vote cast by each party is then divided by the electoral quotient and the result is the number of representatives to which each party is entitled. Any deficiency is supplied from those parties having the largest fractional quotas. This plan possesses the advantage of economy and secures proportional representation.

REPRESENTATION. In law, a statement or assertion as to some matter of fact. Representations have significance in a legal sense when they are acted upon. Such representations may be made as the basis of numerous legal transactions. See DECEIT; FRAUD; CAVEAT EMPTOR; CONDITION; SALE; WARRANTY, etc.

In the law of inheritance the term representation is also used to denote the principle upon which the issue of a deceased person take or inherit the share of an estate which their immediate ancestor would have inherited had he been living. Thus if one dies leaving two children and the children of a deceased child surviving him, the children will each inherit one-third of the real estate of the deceased and the other third will go to the children of the deceased child who are said to take by representation. See ADMINISTRATION (in Law).

REPRESENTATIVES, HOUSE OF. The Lower House of the Congress of the United States. See UNITED STATES; CONGRESS; COMMITTEES.

REPRIEVE (doublet of *reprove*, from OF. *reprover*, *reprover*, Fr. *réprouver*, to reprove, reject, from Lat. *reprobare*, to condemn, reject, from *re-*, back again, anew + *probare*, to test, prove, from *probus*, good). The temporary suspension of a sentence for a crime, granted by the pardoning power, which is usually the chief magistrate of a State or nation. The term is most commonly employed to denote a stay of execution of a person convicted of a capital crime. Reprieves are usually granted in order to allow an investigation into the legality of the conviction, or into alleged 'newly discovered evidence' in favor of the condemned person. They are also granted in case of pregnancy of a woman condemned to death, in cases of alleged insanity after condemnation to death, and often pending an investigation of facts urged in an application for a pardon. See PARDON.

REPRISAL (OF. *represaille*, Fr. *représaille*, from *reprise*, prize, a taking, from *repris*, p.p. of *reprendre*, to retake, from Lat. *reprehendere*, *reprehendere*, to recover back, blame, from *re-*, back again, anew + *prehendere*, *prehendere*, to take). In international law, a means of securing redress without resort to war, but at the same time with the use of force. It consists in forcibly seizing from an offending nation property or its equivalent belonging to the aggrieved nation, or in detaining the property of an adversary with the intention of compelling it to afford the necessary redress. Reprisal is resorted to when a specific wrong has been committed and the seizure is by way of compensation in value for the wrong. The things seized are held subject to the termination of the controversy and are restored if the controversy is amicably settled. Reprisal is an act of retaliation and consists in applying to the subjects of an offending State treatment analogous to that which the subjects of the offended State have received. A reprisal, though an act of war in fact, is not such in intent, and, indeed, is resorted to as a means of avoiding war by securing redress without resort to the graver alternative, although it may constitute a sufficient cause of war. The forms of reprisal most commonly employed in recent times consist in placing an embargo on such ships of the offending State as may be lying in the harbors of the aggrieved State, or in the seizure of its ships

at sea or of any property within the jurisdiction of the State, whether belonging to the State or to private citizens. Bluntschli mentions in addition the following acts of reprisal as permissible by the law of nations: interruption of means of communication, detention of subjects of the offending State as hostages, the expulsion or imprisonment of its subjects, refusal to be bound by treaty stipulations or other international agreements, and the withdrawal of privileges and protection to the subjects of the offending State. See RETORSION.

REPRODUCTION (from Lat. *re*, back again, anew + *producere*, to produce, from *pro*, before + *ducere*, to lead). The fundamental property of the organic world essential in repairing losses by death and in maintaining the earth's population. Although at the outset the result of unknown causes, it consists in a separation of a part of the body of an individual from the parent body; division of a one-celled organism into two; or a giving off of an egg-cell or sperm-cell from the parent. (See CELL; MITOSIS.) Reproduction and growth are inseparable, and the former is the result of growth. As Verworn states, the general process that constitutes growth is an increase of living substance, and the essence of reproduction likewise consists merely in an increase of living substance. Reproduction differs from growth in that a part of the substance separates from the original organism. If the quantity of the living substance increases further by growth, this results in a "growth beyond the measure of the individual," and the cell must divide, i.e. reproduce. The different forms of reproduction are: (1) Self-division, secondary forms of which are (a) fission, and (b) budding or gemmation; (2) conjugation; (3) sexual reproduction.

REPRODUCTION BY CELL DIVISION. This is the primary mode of reproduction. While that of plant and animal cells is called 'cell division,' that of the entire one-celled plant or animal is called 'self-division.' This has been observed in the amœba and other Protozoa, as well as in the white corpuscles of the blood (leucocytes). See AMŒBA.

FSSION. Many of the lower invertebrate animals multiply by fission or budding. In fission the body, as in certain planarian and annelid worms, after having reached a certain size but not sexual maturity by ordinary cell division, is constricted into two or more parts. Each of these several parts separate and regenerate themselves into independent perfect worms. Fission or self-division occurs in fully grown examples of many-celled animals, as in certain polyps and starfish.

BUDDING OR GEMMATION. The process of reproducing the persons of a compound individual or colony. Buds are outgrowths of a parent person that enlarge while in connection with the parent to form a new person. In the case of budding the products are unequal. All the higher plants are produced by budding and are colonies. Among animals the process occurs in Protozoa, sponges, cœlenterates, polyzoans, and tunicates. According to one view the tapeworm is a colony whose parts are produced by budding; even segments or rings of an annelid have been considered as produced by budding. Indeed, as there is no sharp line drawn between growth of the simple individual and growth of a compound

individual, so no sharp line exists between ordinary development and budding; nor is there any definite distinction between cell division and division in the amœba, and budding. This is seen in examples of terminal budding, when the buds appear at the end of the main axis of the parent organism, as in plants and certain Protozoa and low multicellular animals.

CONJUGATION. Though an anticipation of sexual reproduction, conjugation radically differs from it in the fact that two conjugating bodies are each an entire plant or animal. It occurs in the unicellular plants, such as diatoms and desmids, and in the Infusoria. Thus in the act of conjugation of a monad-like form (Heteromita) a free-swimming individual approaches an anchored form, the posterior ends coming in contact; they then fuse like two drops of syrup, the nuclei sharing in the fusion. The product swims around freely, then rests, loses its flagella, and becomes encysted, then bursts open at three angles of the cyst, pouring out a swarm of spores as the result of multiple internal fission. It is usually among the Infusoria a temporary process, but in *Vorticella* the fusion is permanent. The result of conjugation upon the species is to prevent its deterioration. It is a process of rejuvenation, comparable with the intercrossing of higher plants and animals.

SEXUAL REPRODUCTION. In the process, sometimes called 'amphigony,' of reproduction by means of sexual cells, two animals, the male and female, secrete in reproductive glands, one eggs, the other spermatozoa, the result being their union and the formation of a new individual. Here still more than in conjugation sexual reproduction results in a complete renewal or rejuvenescence of the organism. In those plants and animals which also reproduce by budding sexual reproduction arrests degeneration by the introduction of new blood. Sexual reproduction in animals is essentially the same in all classes above the Protozoa. There is a series of developmental processes embraced under the following heads: (1) Maturation of the egg; (2) the process of fertilization; (3) a process of cleavage or segmentation of the yolk (see MITOSIS); and (4) formation of the three germ layers. (See EMBRYOLOGY.) The essential phenomenon in the reproduction of the many-celled animals, i.e. all above the Protozoa, is the act of fertilization or impregnation of the egg. This is effected by the entrance of a single spermatozoön into the egg. After the spermatozoön has entered the egg the head and middle portion, which contains the body called the *centrosome*, can still be recognized as the chromatic and achromatic parts of the spermatozoön or sperm nucleus (male pronucleus). In the protoplasm of the egg (that enveloping the nucleus and called *cytoplasm*) the centrosome of the sperm nucleus gives rise to rays forming 'asters.' (See MITOSIS.) Preceded by these rays, the sperm nucleus travels toward the egg nucleus until it reaches and fuses with it to form a single cleavage nucleus. Then the centrosome divides into two, which migrate to opposite poles of the nucleus, while the cleavage nucleus changes to a cleavage spindle, which divides and thus initiates the embryonic development, the process being called cleavage or segmentation. At this point fertilization is complete (Hertwig). It also appears that of the chromatin particles

(chromosomes) in the newly formed nucleus of the fertilized egg, exactly one-half of the number are furnished by the egg nucleus and the other half by the sperm nucleus. These chromosomes are regarded as the bearers of heredity, forming the physical basis of heredity. See HEREDITY.

ASEXUAL AND UNUSUAL MODES OF REPRODUCTION. Budding and its various forms are examples of asexual reproduction. In certain insects and other animals the egg develops and gives rise to a mature individual without fertilization. (See ALTERNATION OF GENERATIONS; PARTHENOGENESIS.) Hertwig calls this sexual reproduction with degenerated fertilization. Different modes of reproduction (asexual, sexual, parthenogenesis, paedogenesis) may occur in the same species. The alternation of parthenogenesis with pronounced sexual reproduction is called 'alternation of generations,' or heterogony.

Consult: Hertwig, *The Cell* (New York, 1895); id., *Zoölogy* (ib., 1902); Wilson, *The Cell in Development and Inheritance* (ib., 1897).

REPRODUCTION (in plants). Although reproduction is a physiological phenomenon, it

in animals; the morphological aspect, however, deals with structures peculiar to plants. Two types of reproduction are recognized among plants, namely, *vegetative multiplication and reproduction by spores.*

(1) **VEGETATIVE MULTIPLICATION.** In this case the ordinary vegetative cells are used in reproduction. (Figs. 1, 2.) In the simplest plants the adult body consists of a single vegetative cell, and when this cell divides two new

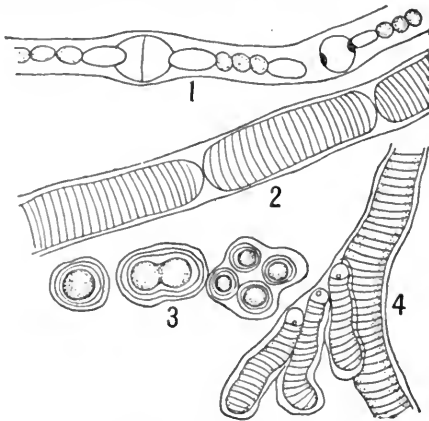

FIG. 1. VEGETATIVE REPRODUCTION.

1, *Nostoc* filament breaking into colonies; 2, *Oscillatoria* filament breaking up; 3, *Gloeocapsa* forming new individuals by dividing; 4, *Calothrix* dividing by false branches.

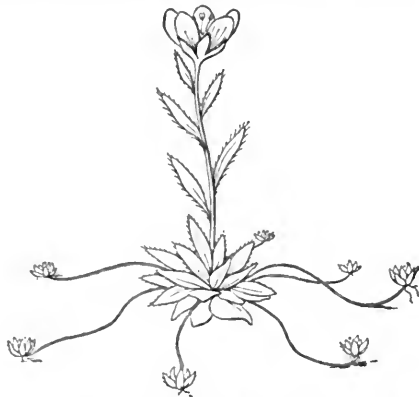

FIG. 2. VEGETATIVE REPRODUCTION IN A SAXIFRAGE.

Stolons are put forth, upon which there arise buds, capable of developing into plants like the parent.

is also a prominent morphological phenomenon in so far as it involves important structures. The physiological aspects are essentially the same as

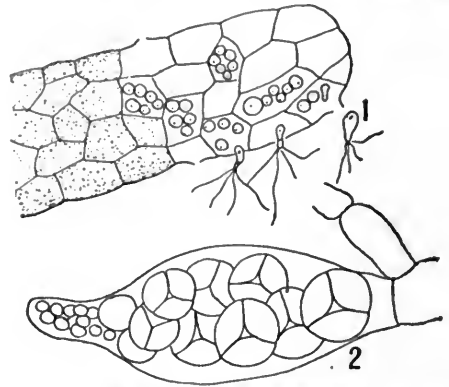

FIG. 3. ASEXUAL REPRODUCTION.

1, Tip of a green alga, showing swimming spores formed in ordinary cells and discharged; 2, branch of a red alga, containing tetraspores.

plants are produced. The same power of cell division persists in all plants, but in the complex (many-celled) plants much of it results, not in reproduction, but in the growth of the body. In such plants, however, the power of vegetative multiplication continues, as when

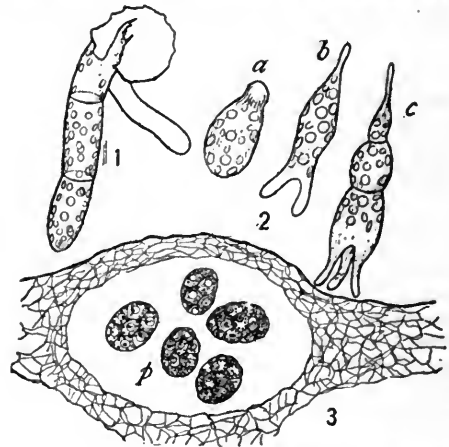

FIG. 4. ASEXUAL REPRODUCTION.

1, A fern spore germinating; 2, a, b, c, three stages in germination from the spore of an alga; 3, spores (p) germinating within a spore-case.

new potato plants come from tubers (modified stems), or new grapevines from cuttings, or new begonias from pieces of a leaf, or when buds from one plant are grafted into the stem of another. In fact, vegetative multiplication is very conspicuous in most plants, enabling them to spread with comparative rapidity, as the strawberry spreads by means of its runners, or the couch grass by its rootstocks (underground stems).

(2) **REPRODUCTION BY SPORES.** A spore, in general, is a single cell designed for reproduction and separated from the parent plant. There are two great classes of spores differing not in function, but in origin: (a) *Asexual spores* (Figs. 3-5) are usually formed by the division of the contents of a mother cell (sporangium), although

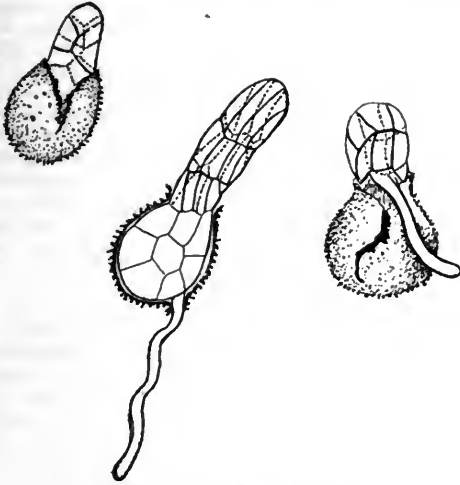

FIG. 5. ASEQUAL REPRODUCTION.
Germinating spores of a liver-wort.

(see **SEX IN PLANTS**) and the fusing process (conjugation) results in a sexual spore (zygospore or zygote). When the gametes become differentiated into sperm and egg, as in all the higher plants, the fusing process is called fertili-

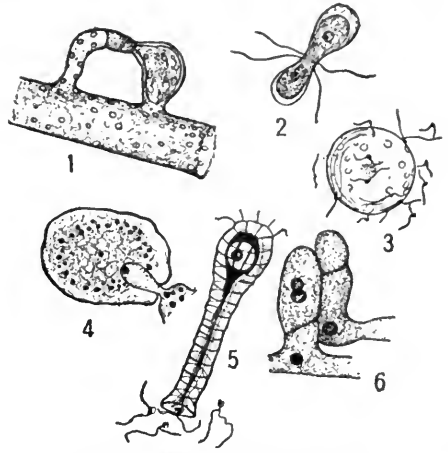

FIG. 7. SEXUAL REPRODUCTION.

1. Antheridium and oogonium of *Vaucheria*; 2. conjugation of gametes; 3. egg and sperms of a seaweed; 4. antheridium and oogonium of a fungus; 5. archegonium of liverwort, with sperms entering neck; 6. fusing sexual cells of a fungus.

they are sometimes formed free by cell division at the tip of a special cell or filament. In many cases spores are provided with cilia and can swim freely in water; in others they are light and dry, and are carried by the wind. They are the most primitive spores, and are the only kind produced by many low plants; but they are retained even

zation, and the resulting sexual spore an oöspore or fertilized egg. It is evident, therefore, that in most plants there coexist three means of reproduction, namely, vegetative multiplication, asex-

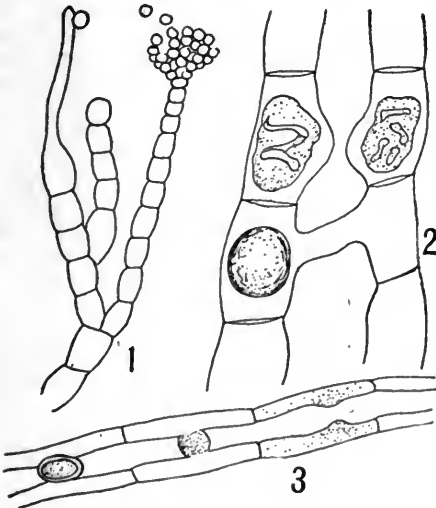

FIG. 6. SEXUAL REPRODUCTION.

1. Red alga, with male cells, one of which is attached to trichogyne of the female organ; 2. conjugation of *Spirogyra*; 3. conjugation of *Mongeaotia*.

by the highest plants, the pollen of flowering plants being an illustration. (See **SPORE**.) (b) *Sexual spores* (Figs. 6-8) are formed by the union of two sexual cells (gametes). In the first appearance of sex the pairing gametes are alike

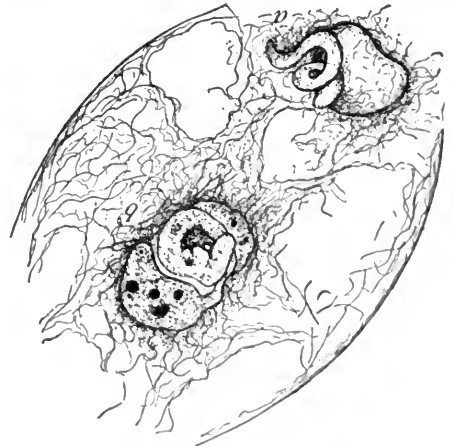

FIG. 8. SEXUAL REPRODUCTION.

Double fertilization in lily, showing one sperm uniting with egg (a), and the other with the polar nuclei (b). See **FERTILIZATION**.

ual spores, and sexual spores, which are used under varying conditions, and reinforce one another in the general work of producing new plants.

REPRODUCTION OF IDEAS. It is customary to divide the 'act of remembering' into three parts: retention, reproduction, and recognition. (See **MEMORY: RETENTION; RECOGNITION**.) The reproductive aspect of memory refers to (1) the excitation of a brain-tract that has received a functional modification by previous excitation,

and (2) the appearance of the corresponding mental processes. The word 'reproduction' is misleading. First, because it implies the 'reappearance' of mental experiences which have persisted and have maintained their identity during their absence from consciousness. An examination of the processes of retention does not warrant the implication. Secondly, reproduction is often posited where no explicit reference is made to a past event at all. Thirdly, a 'reproduced' image is usually schematic; i.e. it contains only the outlines or salient features of its counterpart. The sole definite meaning left for the term 'reproduction' is the unequivocal appearance of 'revived' sensations; i.e. of centrally aroused sensations which possess the function of referring directly to a definite period of past experience. Even when it is thus taken, the concept must not be confused with the old 'copy' theory, which made ideas weaker duplicates of sensations.

The conditions under which reproduction of ideas takes place are various. In the associational psychology, the single condition of reproduction was said to be association. Ideas were 'called forth' by the magic of association. If, however, we conceive association to mean certain conscious complexes themselves, and not their cause, we cannot say that it *conditions* reproduction. (See ASSOCIATION OF IDEAS.) Association and reproduction will have a *common* cause. The 'law' of association will be, i.e., a law of reproduction and will be stated in terms of cerebral connections. This general statement does not help us, however, to name the incentives to the reproduction of any particular set of processes. For this, we must take into account the functions of attention, feeling, will, and mental constitution (e.g. one is apt to 'reproduce' visual imagery if one's attention is directed to visual things, or if one is visually minded, or if one's mood fits in with some particular scene), and the special conditions which are enumerated under association—frequency, recency, vividness, etc.—i.e. the proximate conditions which determine the relative liability of reproduction of ideas.

Finally, a comparison of peripherally initiated sensations with the 'reproduced' sensations contained in imagery makes it possible to measure both the power of reproduction and the fidelity with which sensations, aroused without the co-operation of the sensory organs represent their 'originals.'

BIBLIOGRAPHY. Külpe, *Outlines of Psychology* (New York, 1895); Ward, *Mind, N. S.*, ii, iii. (London, 1893-94); Bradley, *Principles of Logic*, Bk. ii. (London, 1883). See authorities referred to under MEMORY; RETENTION; IMAGINATION; ASSOCIATION OF IDEAS, and for reproduction as an experimental method, see MEMORY.

REPRODUCTIVE SYSTEM, COMPARATIVE ANATOMY OF. The germ cells are not the only ones that are capable of increasing their numbers. This is a common property of all body-tissue cells, and by virtue of this fact the number of individuals may be increased by division of the body and subsequent regeneration (q.v.). In Infusoria no specialized reproductive organs are present. When the unicellular organism exceeds its size-limit, it divides into two parts or 'daughter cells.' (See REPRODUCTION; FISSION.) Reproduction of sponges is either asexual or sexual. Asexual reproduction, or budding, may

occur externally or internally. The sexual reproduction may be hermaphroditic or dioecious. Coelenterates are, for the most part, sexually separate, but some are hermaphrodites, as Ctenophora. There are no organs for the transmission of the sexual products to the exterior.

Sexual ducts occur for the first time in flat-worms. In some the entire ovary produces eggs, while in other forms a part of the ovarian cell only produces egg cells and the rest, the 'vitellaria,' is so modified that it produces only yolk. Both the female and the male glands communicate with the exterior by ducts leading to the copulatory apparatus. The sexes are almost always separate in echinoderms. In one group (Synapta) of the holothurians hermaphroditism is frequent. There are no copulatory organs nor accessory glands. The general organs of starfishes develop in five pairs of bundles. One pair lies in each arm and each pair opens dorsally to the exterior by a separate opening.

In the mollusks the generative apparatus is composed of germ glands, ducts, and copulatory organs. The sexes are separate throughout the whole phylum. Hermaphroditism is, however, wide-spread. In nearly all cases of hermaphroditism both kinds of sexual products are produced in the same gland. The gonads either have separate ducts or utilize the nephridia. The genital glands open either (1) into the pericardium, (2) into some part of the kidney or uterus, (3) into the cloaca, or (4) directly to the exterior. When there are separate ducts they may be very complicated in structure. The structure of the copulatory organ and the form of the ducts with their accessory glands and tubules vary much in detail in the different species. The sexes are distinct in many of the annelids, but Hirudinea, Oligochaeta, and some others are exceptions. The sexes of Polychaeta are separate with a very few exceptions. The ovaries or testes are segmentally repeated several or many times. The ripe eggs and sperm float in the coelomic cavity, to be picked up and discharged to the exterior by the nephridia, or by nephridia specially modified into genital ducts.

The sexes are separate in Crustacea except in a few cases. The male and female sexual glands are constructed on the same plan and have a similar position in the body. There is only one pair, and in certain species only one gland. The parts that make up the sexual apparatus are as follows: (1) The genital organ (ovaries and testes); (2) ducts (oviducts, vasa deferentia); (3) terminal parts (vulva, vagina, and receptaculum seminis in the female, and ductus ejaculatorius in the male); (4) outer copulatory organs. Except in Cladocera and some Copepoda the genital apertures are situated on the ventral side. In all hexapods they open at the end of the abdomen. In certain species there are glands whose secretion unites the sperm cells into capsules or spermatophores. A penis may also be present. The female apparatus may possess a receptacle for the penis and another for storing the sperm. The testis and ovaries consist of a varying number of long tubes which together enter the vas deferens or oviduct. The ovarian tubes are of two kinds, those with and those without nutritive cells. The nutritive cells may alternate with the egg cells or they may be collected in a bunch and furnish nutritive material to the egg cells by means of fine constricting strands. Coming to

the Chordata, we find that in *Balanoglossus* the sexes are separate, and the ovaries and testes are a row of saecular organs which open to the exterior by a series of pores, or, in the American species, by rupture. Tunicates are hermaphroditic.

In *Amphioxus* the sexes are separate. The sexual organs are horseshoe-shaped sacs which lie in 26 pairs and without ducts. The ova and spermatozoa burst the atrial cavity and reach the exterior by means of the atropore. The sexes of the lamprey are separate and the sexual organ is unpaired. The sexual products pass into the body cavity and thence to the exterior by two pores into the urinogenital sinus. There is a penis in the male.

In fishes, impregnation is internal in all the sharks except the Greenland shark. The claspers act as intromittent organs. With a few exceptions, such as the dogfish, there are two ovaries and the oviducts are separate from the ovaries. The oviducts, the Müllerian ducts, are united anteriorly and open into the body cavity. The eggs are extruded into the body cavity and then pass into the oviducts. There is a large shell gland in the oviduct. The majority of fishes lay eggs that are fertilized outside the body. Most sharks and a few teleosts are viviparous, the eggs being hatched in the oviduct or ovary. In two of the sharks the yolk-sac and the wall of the oviduct are united, suggesting the placenta of mammals. The ovaries of teleosts are continued backward into a duct. Posteriorly the two ducts fuse. The oviducts of the Dipnoi are somewhat coiled, like those found in Amphibia; each connects with the body cavity near the pericardium by means of a funnel-shaped aperture. Hermaphroditism is not uncommon throughout the Teleostei.

REPTILES AND BIRDS. The ovaries are broad in the turtles, and long and narrow in snakes and elongated lizards. The ovaries are usually asymmetrical. Only the left ovary is completely developed in birds. The oviducts open into the abdominal cavity by wide funnel-shaped apertures and in the walls of the ducts are glands for the formation of albumen and egg-shells. The ovaries, like the testes, increase in size during the breeding season. In birds the vas deferens, like the ovaries, opens into the cloaca by an independent aperture. In lizards it fuses with the ureter. There is a copulatory organ in reptiles; in birds it exists only in the ducks, geese, and Ratitæ.

The genital apparatus of mammals lies in the lumbar and pelvic regions. When the ova are mature they pass into the body cavity or are immediately caught up by the funnel-shaped opening of the oviducts. This portion is known as the Fallopian tubes. In the majority of mammals the oviducts fuse behind the Fallopian tubes to form the uterus. It is in the uterus that the ova attach themselves to the maternal tissue and develop. The fused region behind the uterus is known as the vagina. In monotremes the Müllerian duct remains distinct and there is a cloaca. In marsupials the Müllerian duct begins to fuse to form a vagina. In most other mammals an anterior fusion of the two parts of the uterus occurs. The degree of fusion varies in different species. In Primates the only evidence of the paired origin is seen in the Fallopian tubes. The testes of mammals develop in the same position as the ovaries, but they later pass out of the abdominal

cavity through an opening in the latter known as the inguinal canal, and descend into the scrotal sacs; but in many mammals the testes remain permanently in the abdomen.

External genital apparatus exists as follows: In elasmobranchs there are male 'claspers' which are inserted into the cloaca and oviduct of the female. In connection with them there is a gland which is histologically much like the uropygial glands of birds. In Amphibia the male of *Gymnophiona* alone possesses an eversible cloaca. In lizards and snakes there are two erectile penes outside the cloaca. Each is furrowed. Organs of similar nature, but much less developed, occur in the female. Chelonians and crocodiles have a copulatory organ united with the ventral wall of the cloaca. It is made up of two fibrous fused masses, and, as in the above copulatory organs, is regulated by well-developed muscles. There is a furrow on its surface. The female also has a median, less well developed organ of the same character. In most Ratitæ and some Carinatæ there is an eversible tube strengthened by two fibrous bodies. When at rest it is coiled up in the left side of the cloaca. The copulatory organ of monotremes lies between the urinogenital sinus and the cloaca, and is fused with the ventral wall of the latter. In all other mammals the organ arises on the ventral wall of the cloaca. In the female it is channeled. In the male the groove is closed to form a canal. Three bodies of erectile tissue are developed in connection with the penis of man. The greater part of one of these glands occurs at the apex of the penis and is known as the glans penis. The clitoris of the female is the homologue of the male penis.

Consult: Lang, *Text-Book of Comparative Anatomy* (London, 1891-96); Wiedersheim, adapted by W. N. Parker, *Comparative Anatomy of Vertebrates* (London, 2d ed., 1897).

REPTILE (Lat. *reptile*, neu. sg., sc. animal, animal, from *reptilis*, crawling, from *reperere*, to crawl; connected with *serpere*, Gk. *ἑρπειν*, *herpein*, Skt. *sarp*, to creep). A cold-blooded vertebrate animal of the class Reptilia, breathing by lungs and having a single median occipital condyle. In their larger, phylogenetic relationships, reptiles occupy a central position, but are closely in affinity with birds, so that the two classes were united by Huxley into a group, Sauropsida, in distinction from the Mammalia and from the Ichthyopsida, or amphibians and fishes. "On the one hand," Gadow asserts of the reptiles, "there is not the slightest doubt that they are evolved from some branch of the Stegacephali, whilst on the other hand the reptiles, probably through some branch of the Thoromorpha, have given rise to the mammals; some other reptilian branch, at present unknown, has blossomed out into the birds."

CLASSIFICATION. The history of the development of the ideas on the classification of reptiles is given under HERPETOLOGY (q.v.). The arrangement by Parker and Haswell is as follows:

Class REPTILIA:

Order I. Squamata.—This includes the Lacertilia (lizards), Ophidia (serpents), and Pythonomorpha (extinct snake-shaped forms, with paddle-like limbs and lizard-like skulls).

Order II. Rhynocephalia.—Lizard-like reptiles, often huge, scaly, with walking limbs; vertebræ amphicæalous; sacrum composed of two

vertebræ; teeth acrodont. This order has one living genus (*Sphenodon*).

Order III. *Chelonia*.—The turtles (q.v.).

Order IV. *Theromorpha*.—Sacrum composed of six vertebræ, limbs adapted for walking, four suborders: *Anomodontia*, *Placodontia*, *Pareiosauria*, *Theriodontia*—all extinct.

Order V. *Crocodylia*.—*Crocodyles* and alligators.

Order VI. *Sauropterygia*.—Extinct aquatic reptiles with a very small head, elongated neck, limbs usually flipper-like, and teeth in separate sockets.

Order VII. *Ichthyopterygia*.—Extinct aquatic reptiles with large head, no neck, long tail, flipper-like limbs, naked skin, and teeth lodged in a groove.

Order VIII. *Dinosauria*.—Extinct terrestrial reptiles, skin naked or armored, pelvis bird-like, teeth in sockets. See *DINOSAURIA*.

Order IX. *Pterosauria* (*pterodactyls*).—Extinct aerial reptiles, with long neck, sacrum composed of two or three vertebræ, skull bird-like, sternum present, fore limbs wing-like, and teeth in sockets.

An advance upon this, resulting from larger knowledge of fossil forms, has been educed by Boulanger and Gadow, so that the most complete classification now stands as follows:

Class REPTILIA:

Sub-Class I. *Proreptilia*.

Sub-Class II. *Prosauria*.—Orders: *Microsauri*, *Prosauri*.

Sub-Class III. *Theromorpha*.—Orders: *Pareiosauri*, *Theriodontia*, *Anomodontia*, *Placodontia*.

Sub-Class IV. *Chelonia*.—Orders: *Atheca*, *Thecophora*.

Sub-Class V. *Dinosauria*.—Orders: *Sauropoda*, *Theropoda*, *Orthopoda*, *Ceratopsia*.

Sub-Class VI. *Crocodylia*.—Orders: *Pseudosuchia*, *Parasuchia*, *Eusuchia*.

Sub-Class VII. *Plesiosauria*.—Orders: *Nothosauri*, *Plesiosauri*.

Sub-Class VIII. *Ichthyosauria*.

Sub-Class IX. *Pterosauria*.

Sub-Class X. *Pythonomorpha*.—Orders: *Dolichosauri*, *Mososauri*.

Sub-Class XI. *Sauria*.—Orders: *Lacertilia*, *Ophidia*.

The term sub-class is given to the larger subdivisions "to emphasize the fact," says Gadow, "that these reptilian groups are of undeniably greater morphological value than those which are generally called 'orders' in the Mammalia." This author tries to display their supposed evolutionary phylogenetic relations by the following scheme:

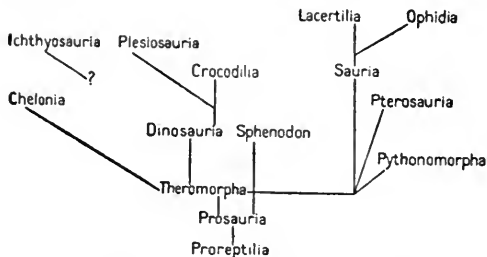

The earliest fossil reptiles are found in the Permian age. Reptiles attained their highest development in Jurassic and Cretaceous times, when

many were of gigantic proportions, and ruled the world. Since then the order has waned, only the recent and adaptive line of snakes seeming to flourish and promise continued prosperity at the present time.

CHARACTERISTICS. With the exception of modern chelonians and ancient dinosaurs, the reptiles in general are of an elongated form, the body being often nearly cylindrical and usually terminating in a very long tail. In a considerable number (as most serpents and some lizards) no traces of limbs are apparent; in some (as certain lizards) the limbs are rudimentary; while in the remainder the limbs are fully developed, although the feet rarely suffice to keep the belly from the ground. The feet are of the pentadactyl type, but not always five-toed.

The covering of the body presents several well-marked varieties. In a few of the lizards the skin is covered with regular scales, composed of a mixture of bony and horny matter, and lying over each other like those of fishes; in most lizards and in serpents scales and plates are developed on the surface of the corium or true skin, and covered over with epidermis, which is thrown off at intervals, the molt forming an accurate cast of the body of the animal; while in the crocodiles and tortoises the scales are converted into true bony plates, which in the former are imbedded in the tissue of the skin, and in the latter are united with the ribs, sternum, and other bones of the internal skeleton, to form the complete bony case into which the head and limbs of the animal can usually be retracted. See *SKELETON*, for structure of the scales.

The skeleton is completely ossified in all reptiles. The skull is small, loosely united, and articulates with the atlas, as in birds, by one condyle, which is formed mainly by the basioccipital. There is an auditory columellar apparatus within the fenestra ovalis, as in *Amphibia*. The mandibles consist of many pieces, and articulate with the cranium through quadrate bones—one of the principal characters separating this class from the mammals.

The mouth, except in the chelonians, is usually provided with conical teeth, adapted rather for seizing and holding prey than for dividing and masticating food. These teeth, like those of fishes, are successional; that is to say, new teeth are being constantly developed, while the older ones are regularly shed. (See *CROCODYLE*.) In some instances the teeth are attached solely to the jaws, while in others they are also attached to the pterygoid or palate bones. In chelonians the teeth are replaced by a horny beak, which, according to the habits of the animal, is adapted for bruising as well as cutting, and which in some species constitutes a somewhat formidable weapon.

The vertebræ, like those of other *Amniota*, are 'gastrocentrous,' that is, their centra "are formed by the pairs of intercentralia, while the basicentralia are reduced" or lost altogether; this characteristic separates reptiles wholly from amphibians. The total number is often great, especially in serpents and the tail of the lizards. The ribs form a true sternum, and the ilio-sacral connection is post-acetabular; the former of these characters separates reptiles from amphibians and the latter from mammals. Reptiles are mainly carnivorous, and swallow their prey whole. Hence the

jaws are adapted, by their mobility and subdivision into segments, to open very widely, and the œsophagus is capable of great dilatation. The tongue is commonly free, elongated, and bifid, except in the crocodiles, in which it is immovable, whence the popular idea that these animals do not possess this organ. The stomach is sometimes scarcely larger than the œsophagus and intestines (as in serpents), while in other cases it forms a sac of considerable size. In either case it is capable of great dilatation. A liver, pancreas, and spleen are always present, the two former pouring their secretions into the upper part of the intestine, which is short, wide, and not much twisted, and divided into two portions, corresponding to the small and large intestines of mammals, by a valve. It finally terminates in a wide cloaca, into which the ducts of the urinary and generative organs usually open. The kidneys differ from those of amphibians, and agree with those of birds, in having no nephrostomes, and in having each its one separate ureter. See ALIMENTARY SYSTEM, EVOLUTION OF.

Reptiles breathe air only by means of lungs, and never have gills even during embryonic life. The lungs are usually of large size; but as they are not subdivided, as in mammals and birds, into innumerable microscopic air-cells, the real aerating surface is comparatively small. In several groups they are merely capacious bags, whose vascular or aerating surface is but slightly increased by sacculi developed in their cells. In serpents one lung (usually the right one) is of extraordinary length, while the other remains altogether rudimentary. This inferiority of the respiratory apparatus of reptiles is further shown in the absence of those means for the continuous introduction and expulsion of air possessed by birds, and still more by mammals. See RESPIRATORY SYSTEM, COMPARATIVE ANATOMY OF.

This feeble respiratory system is correlated with the absence of any covering, such as hair or feathers, which might retain the bodily heat generated by the oxygenation of the blood, as is the case in the well-clothed birds and mammals; hence the blood remains at a temperature little above that of the air or water in which these animals live, and reptiles are placed with the similarly naked or scaly amphibians and fishes as 'poikilothermous' or 'cold-blooded.' (See ANIMAL HEAT.) The heart, unlike that of a bird or mammal, is divided into two atria, and an imperfectly divided ventricle; it has no conus, but semilunar valves exist at the base of the tripartite aortic trunk; the right and left aortic arch are complete and remain functional. The red corpuscles of the blood are nucleated, biconvex and oval—a point of distinction from mammals.

The brain and nervous system present no peculiarities calling for special remark; the presence of an intercranial hypoglossal nerve separates this class from the amphibia. The organs of the senses are well developed, but there are no lateral sense organs. No reptiles have external ears, but their hearing is good. See NERVOUS SYSTEM, EVOLUTION OF.

The sexes are always separate; and the male generative organs, which are far more highly developed than in amphibians, present peculiarities which, in association with the position of the anal aperture, have been adopted by zoölogists as a basis of classification of special taxonomic value

among the Ophidia. Fertilization is always internal, and most reptiles lay meroblastic eggs, from which the young hatch quickly under the influence of the warmth derived from the hot sand or decaying vegetation in which they are buried by the mother, or, in a very few cases, by her incubation. The eggs are comparatively few (except in the turtle tribe), and relatively large, containing a large quantity of food-yolk, so that the young are able to take care of themselves the moment they emerge; yet in most cases they receive some parental care. The integument of the eggs is parchment-like, containing little lime, and the color is always white. Certain reptiles, however, retain their ova in a sort of uterine cavity, formed by a dilatation of the oviduct near its termination in the cloaca, until the development of the embryo is so far advanced that the enveloping membrane bursts previously to the expulsion of the ovum, so that the young are actually born alive—a mode of generation to which the term 'ovoviviparous' is applied. An amnion and an allantois are formed in the process of development, allying reptiles with birds and mammals. See REPRODUCTIVE SYSTEM, COMPARATIVE ANATOMY OF.

In past times reptiles have dominated the earth, swarming in the seas, along the shores, on the land, and in the air. They reached huge size, and many were herbivorous, and preyed upon by others which, as they increased in size and power, must have been the principal active agency in the extermination of the fishes, amphibians and great cuttlefishes, which previous to the Mesozoic Age were the dominant animals of the earth. The alterations of physical conditions, which seem to have progressed steadily during the Mesozoic Age, toward dryness and coolness in the atmosphere, as well as toward elevation and drainage of the land, and the gradual increase of density (salinity) in the sea, were probably unfavorable to the reptilian forms of that time, both directly and indirectly, by being likewise unfavorable to the creatures upon which they fed. On the other hand, the growing clarification of the atmosphere consequent upon the draining and elevation of the land and the spread of terrestrial vegetation, which subtracted its excess of carbonic acid gas and contributed a larger amount of oxygen, stimulated the development of superior types which began in the Permian and slowly won their way in competition with the dinosaurian and other reptiles of their day until they finally overcame them in importance. That they were enabled to do so was due principally, no doubt, to their warmer covering (feathers and hair), enabling them to retain bodily heat, which gave them greater endurance of famine and climatic adversities, and promoted activity, which, in turn, reacted to stimulate and develop all the bodily parts and functions. At any rate the reptiles have steadily declined, many of their branches have become extinct, and others are approaching that end, while all have been driven by competition to the holes and corners of the world, to hiding in swamps, or amid loose rocks, or in hollow trees or among their leafy tops—places where their many enemies cannot easily get at them. Only the heavily armored turtles and crocodiles are able to survive freely in the water, land-tortoises existing only by being very small, well protected, and secretive; and lizards only by having diminished to small size and acquired

great agility. The only branch of the class that seems to be prosperous is that of the snakes, whose peculiar form, adaptive qualities, and excellent endowments for escape or defense enable them to fill a peculiar and little-contested place in the economy of the world.

Fossil Forms. The living reptiles are comparatively insignificant survivors of a mighty race, whose first appearance antedates the Permian period, since remains of two widely dissimilar groups occur in Permian rocks in Europe, North America, and South Africa. First becoming abundant in the Triassic, the rise of reptiles is coincident with the decadence of the Stegocephalia, the great armored amphibians. In the Jurassic the development of reptiles attained its highest level; they dominated land, sea, and air in forms as grotesque as the mythical griffon, dragon, and sea-serpent. It is noteworthy that the Mesozoic reptiles paralleled nearly all the adaptations which occurred ages later among the mammals. There were land reptiles of carnivorous habit, like the cats and wolves, heavy sluggish animals adapted to vegetable feeding, marine fish-like forms which strongly suggest the whales and porpoises, others which sat erect on the hind legs and tail, in some cases adapted to leaping like the kangaroo, and even 'dragons of the air' with bat-like wings. The supremacy of the reptiles extends into the Cretaceous with scarcely any diminution; in fact, it is here that several orders reach their culminating point; but toward the end of this period the dynasty of reptiles comes to an end, and at the dawn of the Eocene the mammals, which during the Mesozoic were extremely insignificant, become the reigning type.

Geographically, the reptilian fauna of the Mesozoic period was almost cosmopolitan, although the contemporary faunas of widely separated regions sometimes show considerable dissimilarity. This variation may be due to different climatic conditions, or to causes which prevent migration of animals. Regarding the general geological distribution of reptiles, it may be stated that the Karoo formations (chiefly Lower Triassic) of South Africa have yielded the anomodont land reptiles in remarkable numbers and diversity of form, while the Middle Trias and the Jurassic of Europe are especially rich in marine forms. Above the Triassic no land-reptiles are known for the Southern Hemisphere, the anomodonts having become extinct, but the northern continents, and especially North America, witnessed during the Jurassic and Cretaceous the development to gigantic size of ichthyosaurs, plesiosaurs, turtles, and especially dinosaurs. The pterodaelyls attain huge proportions in the American Cretaceous, and here for the first time appear the great sea-lizards or mosasaurs. It is certain that the true lizards, and probably snakes, existed in the Cretaceous, but as yet only a few doubtful remains have been discovered below the Eocene. None of the reptilian orders except those which exist at the present survived the Cretaceous, and the beginning of the Eocene witnessed a reptilian fauna essentially similar to that of to-day.

The origin of reptiles from stegocephalian Amphibia cannot be doubted; and as the earliest known reptile, palæohatteria, from the Lower Permian of Saxony, is already well differentiated from its stegocephalian contemporaries, it seems

probable that reptiles existed as early as the Upper Carboniferous. Some of the Microsauria, a sub-order of stegocephalians, are ranked by Gadow as reptiles. It is not improbable that the reptiles arose diphyletically, or in two parallel lines, from the Amphibia, and as far back as the Permian we find the widely divergent stems of the two great divisions of the order. Of late years the diphyletic character of the class has been noted by several writers, but it was not until 1902 that the two branches of reptilian descent were clearly differentiated by Osborn as sub-classes, under the names *Synapsida* and *Diapsida*. These names refer to the condition of the temporal region of the skull—whether primitively a single temporal arch, or separate upper and lower arches.

See special articles elsewhere in this work under the names of groups above mentioned, as DINOSAURIA, ICHTHYOSAURS, THEROMORPHIA, etc.

BIBLIOGRAPHY. Dumeril et Bibron, *Erpétologie générale* (Paris, 54); Hoffman, "Reptilia," in Bronn's *Klassen und Ordnungen des Thierreichs* (Berlin, 1859—); Boulenger, *Catalogue of Reptiles in the British Museum* (London, 1889-96); Cope, *Crocodylians, Lizards, and Snakes* (Smithsonian Institution, Washington, 1900); Holbrook, *North American Herpetology* (Philadelphia, 1842); Gadow, *Amphibia and Reptiles* (New York, 1901). Consult also authorities cited under CROCODILE, LIZARD, SNAKE, TURTLE, etc., and faunal and general works, especially Parker and Haswell, *Text-Book of Zoölogy* (New York, 1897).

For fossil forms, consult: Zittel, *Text Book of Palæontology*, pt. ii. (London, 1903); Woodward, *Vertebrate Palæontology* (ib., 1898); Nicholson and Lydekker, *Manual of Palæontology* (Edinburgh, 1889); Lucas, *Animals Before Man in North America* (ib., 1903).

REPUBLIC. A form of political organization in which the principal agents of government are chosen by qualified electors, to whom they are, in theory at least, responsible. Such electors may comprise the whole adult population of the State, or all qualified male citizens, or a small group of persons exercising a constitutional or hereditary power of election. The earlier republics were of the latter sort, ranging from the free but limited democracy of Athens to the narrow oligarchies which divided the sovereignty of Italy during the Middle Ages. The democratic movement of the last century has, in the freer political communities of the Western world, largely substituted a popular for an oligarchical electorate, thus giving to the world republics of the type of France and the United States of America, and creating a new but inaccurate definition of republic as synonymous with popular government. See DEMOCRACY.

It is not to be denied that there may be a republic in reality which is not such in name, nor that a government which masquerades under republican forms may in fact be a thinly disguised monarchy or imperialism. In limiting the term republic to the form of government, we must be understood as speaking of the form through which government is actually administered. A monarchy in which the crown has become merely the symbol of social distinction and no longer represents political authority may fairly be described as a republic in all but name; while a military autocracy, like that of the Cæsars, though veiling its assumption of arbi-

trary power under republican forms, is none the less a monarchy. That the English government is approximating to the former condition, and that the military despotisms of Central America are perilously near the latter, cannot be denied, though it would be rash to say that in either case the conversion of the government from the one type to the other has yet become complete.

It is to the growing realization of this fact—that a republican form of government furnishes no guarantee against tyranny, and that monarchy is not inconsistent with a high degree of political freedom—even more than to the conservative reaction of half a century ago, that we must attribute the change in the character and aims of the liberal movement of the last century. The widespread republican sentiment which in 1848 threatened the thrones of Continental Europe has completely died out, and in its stead we find a growing sentiment for the liberalization of the monarchical institutions which survived that revolution. England has taken the place of the United States and Switzerland as the model of political reformers, and the aim is rather to transform existing institutions than to abolish them and substitute others of the republican type.

Attempts have been made, but without much success, to classify republics according to the extent to which popular power was diffused through the mass of the people. A more valid and useful distinction among governments of the republican type is found in the form in which the popular choice, whether wide or narrow, expresses itself, and this is determined not so much by political theory as by considerations of practical convenience. From this point of view republics fall into two classes, the pure and the representative. The former, illustrated in the local town government of New England, as well as in the Athenian democracy and the early Swiss republics, was strictly a government of the people by the people, all the citizens—a small and select class in Athens, the whole body of freemen in Appenzell and Schwiz—actually taking part in the administration of the State. This form of government is, from the nature of the case, limited to small and compact communities, with simple and common interests, and does not lend itself to the solution of vast and complex problems of government. It is obviously unsuited to the great modern State, with its large population, varied interests, and extensive dominion. For a republic of this type there is no alternative but the adoption of the representative form of government. This is the indispensable condition of the existence of republics of the modern type.

Most of the leading writers on governments have treated the republic as a recurring but merely temporary stage in the cycle of political growth and decay, which moves from the stability of orderly monarchy, through oligarchy, democracy, and anarchy, back to despotism. But the conditions of modern life and the problems of modern government are so different from those of old that the reflections and prognostications of Aristotle, Polybius, Machiavelli, and Hobbes may safely be disregarded by us. What is certain is that democratic government everywhere, but especially in its republican form, calls for character as well as a highly developed political instinct in the mass of the people constituting

the State; and when these conditions exist we may reasonably believe that, in a world which has come to cherish industrial rather than militant ideals, the popular republic may have a stability, a good order, and a capacity for progress which no other form of government has yet displayed. See CABINET; CONSTITUTION; CONSTITUTION OF THE UNITED STATES; DEMOCRACY; GOVERNMENT, and the authorities there referred to.

REPUBLICAN METHODIST CHURCH.

See METHODISM; O'KELLY, JAMES.

REPUBLICAN PARTY. In the history of American politics the term Republican has been applied to political organizations representing the most diverse principles. During the years 1791-92, under the leadership of Jefferson, the opponents of centralization in the National Government were molded into an effective political party, which assumed the official name Democratic-Republican, though its members generally called themselves Republicans. Later this organization became known as the Democratic Party (q.v.). During the years 1825-29 the followers of Clay and of Adams were known as National Republicans. (See WHIG PARTY.) In ordinary usage, however, the term Republican is applied to the powerful party which was organized in 1854-56 and elected Lincoln in 1860.

The present Republican Party took its rise from one overpowering impulse—opposition to the extension of slavery. Northern Whigs acceded with great repugnance to the new Fugitive Slave Law of 1850 (see COMPROMISE OF 1850), and its enforcement became daily more odious. When the Kansas-Nebraska Bill (q.v.) became a law the revolt was instantaneous. On the very morning after the passing of this bill, May 27, 1854, a gathering of some thirty Congressmen discussed the necessity of organizing a new party, and it was agreed that 'Republican' would be its appropriate name. Previously, on February 28, 1854, a mass meeting of Whigs, Democrats, and Free Soilers, in Ripon, Wis., had resolved that if the Kansas-Nebraska Bill should pass, they would "throw old party organizations to the winds, and organize a new party on the sole issue of the non-extension of slavery." Three weeks later local organization was effected, and the name 'Republican' was suggested as the one which the party should and probably would adopt. It was in Michigan, however, that the fusion of the opponents of the extension of slavery first completed a State organization, and formally adopted the name (July 6, 1854).

The new party was formed not so much by a coalition as by a fusion of diverse elements. There were: (a) a large proportion of the anti-slavery Whigs, like Seward, Greeley, and Lincoln; (b) the Free Soilers (see FREE SOIL PARTY), like Hale, Julian, and Sumner; (c) a great body of Know-Nothings, like Wilson, Banks, and Colfax; (d) some Abolitionists, who, though impatient with the Republicans' repeated assertion that they did not purpose to interfere with slavery where it actually existed, nevertheless found in the new party the best promise of effective opposition to slavery; and finally (e) anti-slavery Democrats, such as Hamlin, Cameron, and Bryant, who brought with them a strong popularizing influence. Later the war crisis led other Democrats into the Republican ranks, though in some in-

stances, as in the cases of Butler and Johnson, their allegiance was but temporary.

Before the new party had been in existence a year it had secured a popular majority for the opponents of slavery in 15 of the 31 States, and had elected 11 United States Senators and a plurality in the House of Representatives. The first Republican national convention met at Philadelphia, on June 17, 1856, and was attended by delegates from all the Northern States, from the Territories of Minnesota, Nebraska, and Kansas, from the District of Columbia, from Virginia, and from the border States of Delaware, Maryland, and Kentucky. The nomination for the Presidency was given to John C. Frémont, whose career as an explorer and pioneer made him a magnetic leader. The platform declared it to be "both the right and the duty of Congress to prohibit in the Territories those twin relics of barbarism, polygamy and slavery;" it demanded the immediate admission of Kansas as a free State, and denounced the Ostend Manifesto (q.v.), "with its highwayman's plea that might makes right." Whig influence was apparent in its strong declaration in favor of internal improvements at national expense, including the construction of a railway to the Pacific. Frémont obtained 114 electoral votes (Buchanan, the Democratic candidate, receiving 174), and polled a popular vote of 1,341,264, carrying all the free States except New York, Pennsylvania, Indiana, and Illinois. (See ELECTORAL VOTE and UNITED STATES HISTORY for further details as to Presidential elections.) A slight falling off in Republican strength in Congress reflected the waning of the first enthusiasm and the defection of some of the least disinterested members, but their places were soon more than filled by new adherents from the shattered American Party and from Whigs and Democrats, to whom the Dred Scott decision and the Leecompton Bill were intolerable. During Buchanan's administration the Republicans devoted their efforts to protesting against the extension of slavery, and to unsuccessful attempts to secure the passage of a Homestead Bill and the appropriation of public lands for educational purposes. In 1860 the Republican national convention was held in Chicago. The platform denounced Democratic threats of disunion; insisted that the rights of the States should be maintained inviolate, especially the right of each State to order and control its own domestic institutions according to its own judgment exclusively; declared that "the normal condition of all the territory of the United States is that of freedom, which Congress is bound to preserve and defend;" demanded the prompt admission of Kansas as a free State, and the passage of a Homestead Bill; favored a protective tariff, and river and harbor improvements; and advocated a Pacific railway, to be aided by national grants. In the balloting for candidates the more prominent leaders, Seward and Chase, were soon passed over as having made too many enemies or aroused too great apprehensions, and on the third ballot the nomination fell to Lincoln, largely from considerations of 'availability,' for as yet the full measure of his strength had by no means been revealed. Governor Hamlin, of Maine, a former Democrat, was given the second place on the ticket. Out of the 303 electoral votes Lincoln received 180, and his plurality was nearly 500,000; but his strength

was exclusively in the North, and his vote fell far short of a majority.

Republican rule began even before Lincoln's inauguration, for in the closing months of the 30th Congress the withdrawal of Southern members gave the Republicans a majority in both Houses, a fact promptly signaled by the admission of Kansas, and by the passage of a protective tariff act. The conduct of the war against the Confederate States was thrown into the hands of the loose-constructionist Republican Party; yet the opposition, especially in the later years of the conflict, was vigorous. The chief war measures were enacted by Republican votes, and favorite Republican policies were also brought to realization in the Homestead Bill of 1862, and the grants in aid of railways and of education. Really 'pivotal,' however, was the party's policy toward slavery. Here Lincoln himself took the lead. The preliminary Proclamation of Emancipation (q.v.), issued upon his own responsibility, served to "unite the South and divide the North." Formidable reaction followed, and in the autumn elections of 1862 the very existence of the Union was at stake. No one could doubt that the loss of Republican ascendancy would result in the ending of the war by some compromise which would involve the dissolution of the Union, yet the great States New York, Pennsylvania, Ohio, Indiana, and Illinois all showed Democratic majorities; but the New England States, Kansas and Minnesota, California and Oregon followed the President's leading, and the border States, too, came to the support of his policy. In the resulting Congress the Republicans found themselves in control by a majority of about twenty votes. Lincoln's policy had been vindicated: he had been clear-sighted enough to recognize that the moment had come to commit the party to an aggressive policy, and on a question of right and wrong he had been willing to trust the people. But nothing less than an amendment to the Constitution could be relied upon actually to abolish slavery forever. Such an amendment was proposed in December, 1863, but went over to the next session, and therefore became one of the vital issues of the campaign of 1864. Lincoln insisted that the advocacy of such an amendment should be made the 'keystone' of the platform. In sharp contrast with the resolutions of 1860, the Republican Convention now declared that slavery was the cause and the strength of the rebellion; that it was "hostile to the principle of republican government," and that "the national safety demanded its utter and complete extirpation from the soil of the Republic;" that the Constitution should be so amended as to "terminate and forever prohibit the existence of slavery within the limits or the jurisdiction of the United States;" and that no terms but unconditional surrender should be granted to the rebellious States. Lincoln was renominated by acclamation, and, as a mark of recognition of the patriotism of the loyal men of the border States, the nomination for the Vice-Presidency was given to Andrew Johnson, of Tennessee. Lincoln's vote in the electoral college exceeded that of his Democratic opponent, McClellan, ten to one, yet it is significant that his popular majority was less than 500,000. January 28, 1865, with the aid of eleven Democratic votes, the joint resolution (v. Amend. XIII. U. S. Const.) was passed by the House.

The end of the war found the Republican Party strong and united. But a severer test awaited it in the problem of reconstruction (q.v.), and but few weeks were needed to show how irreparable a loss the party had sustained in the death of Lincoln, and what a wretched blunder, from a purely Republican point of view, it had committed in making it possible for a strict-constructionist Democrat of Johnson's personality and antecedents to become President. During Johnson's administration the Republican majority in both Houses of Congress was overwhelming. Between the President and Congress there speedily arose over the policy to be pursued in reconstructing the South a controversy which culminated in the unsuccessful impeachment. The party in its platform of 1868 sanctioned the reconstruction policy of Congress, and insisted upon "equal suffrage to all loyal men in the South." General Grant received the unanimous nomination for the Presidency. His election was made a certainty by the fact that in the South negro suffrage was protected by Federal arms, while many of the whites were still disfranchised. Consequently only four of the Southern States, Delaware, Maryland, Kentucky, and Louisiana, chose Democratic electors. Republican majorities were maintained in both branches of Congress throughout Grant's first administration, although the opposition was gradually gaining strength. As a party measure the ratification of the Fourteenth and Fifteenth Amendments was exacted from Mississippi, Texas, and Virginia as a condition precedent to readmission, and the appointment of Federal supervisors of elections was authorized. Stimulated by protests against the manipulation of office for private or party purposes, the Republicans passed the first law for the reform of the civil service. The growing sentiment in favor of universal amnesty, universal enfranchisement, civil service reform, and the limiting of the power of the Federal Government over the local affairs of the States led to the breaking away of the Liberal Republicans (q.v.), who in 1872 made these the chief planks in their platform. Their avowed failure to come to any agreement as to the tariff, and their ill-advised nomination of Greeley, made the movement but a slight menace to the reelection of Grant, whom the Republicans had unanimously renominated upon a platform consisting chiefly of a glorification of the party's past achievements and strongly advocating a protective tariff. As a result of the *Crédit Mobilier* (q.v.) and other scandals the feeling became widespread that the Republican Party's long tenure of office had lowered the ethical tone of the party, and had given it into the hands of self-seeking and overbearing leaders. Moreover, the Republicans, as the party in power, were held responsible for the panic of 1873. Hence defection grew to such an extent that many of the Northern States were carried by the Democrats, who in 1875 secured a majority of 182 to 110 in the House. The Republican national convention in 1876 indorsed civil service reform, and commended the provision already made for the resumption of specie payments. The nomination for the Presidency was given to Governor Hayes of Ohio, and in the ensuing campaign many of the Liberal Republican bolters returned to their former allegiance. The result of the election was long in doubt, but by the Electoral Commission (q.v.) all the questions at issue were decided in

favor of Hayes, who was declared to have received 185 votes to 184 for Tilden, his Democratic opponent.

With the administration of Hayes there began a new period in the history of the Republican Party. The issues which had called it into existence had passed away, and the withdrawal by the President of the Federal troops from the South at the beginning of his administration may be said to have closed the strife between the two sections of the country. The old party leaders had left the field, for the most part, and their places had been taken by such men as Blaine, Garfield, Conkling, Sherman, Sehurz, Hoar, and Edmunds. The task which faced them was new, for economic problems upon which neither party had developed well-united views had become dominant; the currency, the tariff, and commercial relations were to be adjusted to the new and rapidly expanding industrial life of the people. In the first two years of Hayes's administration the Democrats were in control of the House, and in the last two years of both branches of Congress, while from the members of his own party the President received but half-hearted support, for it was by the aid of Republican votes that the Bland Silver-Purchase Bill was passed over his veto, and that the further retirement of United States notes was forbidden. The Republican convention of 1880 favored a protective tariff, Federal aid to popular education, "the protection of the honest voter at the South," and thorough civil service reform. Grant was for a time the leading candidate, but after a long contest the convention was 'stampeded' for Garfield, who was nominated on the thirty-sixth ballot. In order to conciliate the supporters of Grant, the second place on the ticket was given to Chester A. Arthur. During the administrations of Garfield and Arthur party lines were greatly blurred. The tariff act of 1883 and also the Pendleton Civil Service Bill received support from both sides of the chambers, yet they were in the main regarded as Republican measures. In 1884 the Republican platform was unusually pronounced in its advocacy of a protective tariff and urged international bi-metallism, the regulation of interstate commerce, and the restoration of the navy to its old-time strength and efficiency. The nomination of Blaine proved in many respects to be ill-advised. A large section of the party (see *MUGWUMPS*) refused to support him, and gave their votes mainly for Cleveland, who was elected, carrying not only the 'Solid South,' but also New York, Connecticut, New Jersey, and Indiana. During his administration Democrats were in the majority in the House. Substantial gains were made in the reform of the civil service and in the regulation of interstate commerce (Act of 1887), both of which the Republican platform had urged. A protectionist faction in the Democratic Party aided the Republicans in preventing a reduction of import duties. Cleveland's message of December, 1887, made the tariff the dominant issue of the campaign of the following year. The Republican platform declared the party to be "uncompromisingly in favor of the American system of protection;" asserted its opposition to combinations organized "to control arbitrarily the conditions of trade among citizens;" favored the "use of both silver and gold as money," and the building up of a strong navy. The nomination of Harrison,

of Indiana, and Morton, of New York, helped the party to regain those States and win the election. A scanty majority was secured in both branches of Congress. The "Omnibus Bill" for the admission of the Dakotas, Montana, and Washington brought the Republicans some votes, and Speaker Reed's rules put the House under the firm control of the majority, although they aroused not a little opposition. The protectionist McKinley Tariff Bill was passed, with the addition of a reciprocity clause. But in the Congressional elections of 1890 the Republicans were overwhelmingly defeated, and the Democrats carried the Presidential election of 1892 by a large electoral majority. The Republican platform had been very similar to that of 1888, and the nominations had aroused little enthusiasm; a rise in retail prices had followed the going into effect of the McKinley tariff, and had made it unpopular. During the first half of Cleveland's second administration the Republicans were in a decided minority in both Houses. But the reaction due to the disastrous panic of 1893 and dissatisfaction with the long-deferred and inconsistent Wilson-Gorman Tariff Bill presently reversed the situation in Congress, again bringing the Republicans into control. In the campaign of 1896 the currency issue was the all-important one. Twenty-two Republican State conventions pronounced against the free coinage of silver, and the platform of the national convention asserted the party's opposition to free coinage except by international agreement. Upon the adoption of this resolution, thirty-four free-silver delegates withdrew from the convention. The platform further "renewed and emphasized the party's allegiance to the policy of protection," and promised "to all of our products" "the most ample protection;" it favored a protectorate over Hawaii, and insisted that the United States "should actively use its influence and good offices to restore peace and give independence to Cuba." In this campaign the Republicans received aid from the 'Gold Democrats;' even the 'Solid South' was broken. McKinley received a majority over all other candidates of 286,257. The appeal which the Democrats had made to class animosity had reacted in favor of the Republicans, as the party of conservatism. In the following year the Republicans found themselves in control of both branches of Congress, though their majority in the Senate was but narrow. The Dingley Bill was promptly passed, restoring the strongly protective character to the tariff. The war with Spain, in 1898, forced to the front questions of policy which had been quite unforescen, and on which clean-cut party lines could not be drawn. The annexation of Hawaii had long been a favorite measure with some Republicans, and was effected by Republican votes. In 1899 the Republicans secured a strong majority in the Senate, and forthwith enacted a law making the gold dollar unequivocally the unit of value. Upon questions relating to the government of 'dependencies,' however, there was some crossing of party lines, a few leading Republicans with most of the Democrats taking the ground that the United States could not govern alien peoples without the consent of the governed. In the campaign of 1900 the great issue was that of 'imperialistic expansion.' The Republican platform renewed the pledge of independence to Cuba; and declared it to be "the high duty of the Gov-

ernment" "to put down armed insurrection and to confer the blessings of liberty and civilization upon all rescued peoples," promising them the largest measure of self-government consistent with their welfare and our duties. Again McKinley was the Republican nominee against Bryan, and he increased his vote over that of 1896. Outside of the Southern States the Democrats secured only 13 electoral votes, all from States dominated by the silver interest. In the first Congress of the new century the Republicans increased their strength in both Houses. The pledge of Cuban independence was redeemed, but within the party there arose serious differences as to the policy to be pursued toward the Philippines and also over reciprocity, which had been strongly indorsed in Republican platforms, but to which large financial interests, of great weight in Republican councils, stood inflexibly opposed.

The Republican Party began its career through a fusion of various party elements opposed to the extension of slavery. Its original task was accomplished with the close of the reconstruction period. New tasks have caused a differentiation in the party's personnel and in its centres of influence. In the industrial agitations of the closing years of the nineteenth century it found itself forced to stand upon the defensive as the party of conservatism. It has ever represented strong nationalizing forces at home, and a vigorous foreign policy, and its principles of broad interpretation of the Constitution have led it to enter with confidence upon the solution of problems imposed upon the United States by the expansion which followed the war with Spain.

BIBLIOGRAPHY. Wilson, *Rise and Fall of the Slave Power* (Boston, 1872); Greeley, *The American Conflict* (Hartford, 1864); Baneroff, *Life of Seaward* (New York, 1900); Blaine, *Twenty Years of Congress* (Norwich, 1884); an article by Johnston, in *Labor's Cyclopaedia of Political Science, Political Economy, and United States History* (Chicago, 1881); Rhodes, *History of the United States from the Compromise of 1850* (New York, 1896); Stanwood, *History of the Presidency* (Boston, 1900); Smith, *The Liberty and Free Soil Parties in the Northwest* (New York, 1897); Nicolay and Hay, *Abraham Lincoln, a History* (New York, 1890); J. T. Morse, *Life of Lincoln* (Boston, 1898); *Autobiography of Thurlow Weed* (Boston, 1884); Geo. W. Julian, *Political Recollections, 1840 to 1872* (Chicago, 1884); H. E. von Holst, *Political and Constitutional History of the United States*, vols. iv. to viii. (Chicago, 1876-92); J. P. Gordy, *History of Political Parties and Political History of the United States* (Columbus, Ohio, 1895-98).

REPUBLICAN RIVER. One of the head-streams of the Kansas River. It is formed by two forks in east central Colorado, and flows north-east into Nebraska, then east, and finally south-east into Kansas, where it joins the Smoky Hill River at Junction City to form the Kansas River (Map: Nebraska, F 3). It is about 500 miles long.

REPUDIATION (Lat. *repudiatio*, from *repudiare*, to repudiate, from *repudium*, repudiation, rejection of what one is ashamed of, from *re-*, back again, anew + *puere*, to be ashamed). The refusal of a State or government to pay its debt. It grows out of the practical bankruptcy of the State, though it often seeks justification

in the plea that the obligations previously admitted were illegal and therefore invalid. Debt-sealing by refunding operations frequently approaches repudiation in its practical effects, though it generally escapes the reproach of the name unless there are obligations or classes of obligations which are wholly ignored in the process. Among nations and States of weak public credit the practices mentioned are only too familiar, but the odium of the name attaches particularly to the history of the financing of the American commonwealths. In 1790 all existing State debts had been assumed by the general Government, partly on the ground of justice, because they had been contracted in the prosecution of the Revolutionary War, partly on that of expediency, as a means of strengthening the public credit. For a period of 40 years thereafter the State governments remained almost free from liabilities, notwithstanding the fact that the War of 1812 had called for extraordinary expenditures, and in 1830 the aggregate debt of all the States was only \$13,000,000. Then began an era of extravagant speculation and reckless enterprise. Population was increasing, and production was increasing even faster than population. The resources of the soil were more than equal to any demands that could be made upon them. But as yet no adequate means of communication between producer and consumer had been established, and a universal need was felt for such facilities of transportation as would insure quick delivery at moderate rates. To the sanguine colonist it seemed that the construction of railroads and canals was a work of public importance which would justify almost any financial assistance on the part of the State, and would return the investment a hundredfold.

States issued bonds in aid of the construction of railroads and canals, and in the South especially subscribed to bank stock, for the purchase of which they issued bonds. In other cases they simply indorsed the bonds of railroads and banks. Nor was it difficult for the States to secure loans. The United States national credit stood high abroad. Not only had the interest been promptly paid upon the national debt, but the United States offered the extraordinary spectacle of a nation which had actually paid the principal. European money-lenders, who had not yet learned to discriminate between national and State securities, felt confidence both in the honor and in the resources of the country. The bonds of the several States were therefore easily disposed of in foreign markets, until in 1842 their aggregate debt had swollen to the enormous total of \$213,000,000, an increase of more than 1500 per cent. since 1830. The panic of 1837 and the subsequent tightening of the money market precipitated the inevitable crash. First, Indiana found it impossible to meet the interest of her debts in 1840; Ohio was saved from following her example only by extraordinary efforts. Two years later the Bank of Pennsylvania failed, and every bank south of Philadelphia suspended payment. In the panic that ensued, Pennsylvania, Maryland, Mississippi, Michigan, Florida, Indiana, and Illinois found themselves in a condition approaching bankruptcy. But though all these States suspended payment of accruing interest, all of them, except Mississippi, Michigan, and Florida, finally

weathered the storm without resorting to the repudiation of any part of the capital debt.

It was in Mississippi that the word repudiation originated, in a message by Governor McNut of that State suggesting the plan of "repudiating the sale of certain of the State bonds on account of fraud and illegality." The bonds, to the amount of \$5,000,000, had been issued in 1838 as a subscription to stock of the Union Bank of Mississippi. As the bank succumbed early to reckless management and the security of the State became worthless, the State found itself saddled with a debt from whose expenditure it had had no benefit. It is not surprising that certain apparent irregularities in the issue of the bonds should be seized upon as a pretext for denying the debt, though the courts of the State later decided that these irregularities were not so material as to invalidate the bonds. The Legislature of Mississippi promptly branded this suggestion of repudiation as "a calumny upon the justice, honor, and dignity of the State." But though for the time being the bonds were thus saved from being formally repudiated, they fell into default. Successive Governors, indeed, urged their payment, but no provision was made for the purpose until 1852, when a proposition to levy a tax to pay the bonds and interest was submitted to the people and defeated at the polls by an overwhelming majority. Florida, which in the thirties had borrowed about \$3,900,000 for the support of banks, was caught in the bank failures and refused to pay her debts. In the meanwhile Michigan had repudiated a portion of its liabilities under the following circumstances: Certain bonds had been disposed of to the Morris Canal and Banking Company, to be paid for in installments. The Bank of Pennsylvania had become surety for the payment of these installments as they fell due. But canal company and bank both failed. It was ascertained that a large amount of the bonds, for which only partial payment had been made, had been transferred from the canal company to the bank, the latter having full knowledge, of course, of all the facts. It is true that the bonds had been hypothecated in foreign markets, and were now in the possession of innocent holders. Nevertheless, the State claimed that it was bound to repay only the money it had actually received, called for the surrender of the 'part paid' bonds, and issued new certificates for the amount it had actually received, with interest thereon.

The course pursued by Louisiana was equally open to criticism. The State had raised capital for internal improvements by loaning her credit to banks whose stock was secured by mortgages on real estate. During the era of prosperity these banks discounted a great deal of business paper which turned out to be bad when the day of trial came. In 1843 the Legislature enacted that all debts due to the bank should be payable in the depreciated State bonds issued by the banks, at their par value. In ante-bellum times, however, repudiation was in its infancy. After the war it sprang to great proportions, as the Southern States generally repudiated their debts. The burden of debts had greatly increased from 1860 to 1870, while the resources of the country had been wasted by the war. Practically no interest had been paid upon the debt contracted before the war. The so-called period of reconstruction was, moreover, riotous in its expendi-

ture of public moneys and brought about a large increase of the debt. With the revival of old conditions and the return to power of the classes which nominally ruled the States, the inability to pay resulting from the impoverished condition of the country was combined with a reluctance to pay debts which in their opinion had been forced upon the States by outsiders. In this category they placed the accrued interest upon antebellum debts as well as much of the debt which had its birth in the so-called reconstruction era. It is impossible to follow the history in all its details. With pretexts of fraud, jobbing, and corruption in the issue of bonds, or on the simple plea of poverty, one Southern State after another annulled its obligations outright or so scaled them in refunding operations as to destroy a large part of their face value. The aggregate debts of the States along the coast from Virginia to Louisiana, with Arkansas and Tennessee, are computed to have reached, each State taken at its highest point, \$236,000,000, while in 1880, after the policy of repudiation had been adopted, they amounted to \$108,000,000. The Southern States were joined by one Northern State, Minnesota, which in 1880, after 22 years of agitation, denunciation, and negotiation, finally agreed to compromise the payment of certain railroad bonds (guaranteed by her as far back as 1858) at 50 cents on the dollar, and accrued interest, the plea being that the railroads had failed to comply with the conditions of the issue. The inevitable result of repudiation has been that foreign capitalists have learned to discriminate between the values of different State securities; and while the bonds of the non-repudiating States, including those Southern States which have not followed the example of their neighbors, command a premium, the bonds of the various repudiating States fluctuate at from 10 to 50 per cent. of their face value.

Repudiation has not been confined to States. During the five years immediately following the panic of 1873, numerous cities, towns, and counties, even within those States whose corporate credit remained unimpaired, finding it impossible to meet their obligations, sought to evade them by repudiation. By appeal to the United States courts, however, their creditors could command an impartial judicial determination of the question. This is impossible in the case of States, as the 11th amendment of the Constitution, adopted in 1794, expressly provides that though individuals may be sued by States, States cannot be sued by individuals. Under this amendment, and the decisions which have grown out of it, no power can legally coerce a State to keep its pledges. There is therefore no power in the United States Government to prevent a recurrence of the humiliating spectacle of repudiation. The States only can provide remedies for it. The substantial increase of wealth in all sections of the country affords a guarantee for the future. Another and perhaps more efficient safeguard against its recurrence is to be found in the innumerable restrictions upon the debt-making power of the States which have found their way into recent State Constitutions.

Consult Scott, *The Repudiation of State Debts* (New York, 1893).

REQUESTS, COURT OF. An ancient English court having minor chancery jurisdiction, and

presided over by the Lord Privy Seal. It was inferior to the Court of Chancery. It was abolished by Stat. 16 and 17 Car. 1., c. 10. Certain inferior courts for the collection of small claims were formerly called courts of requests, or courts of conscience. They have all been abolished by statute, or have become obsolete. See **COURTS.**

REQUIEM, rē'kwī-ēm (Lat., rest). In the Roman Catholic Church, the mass for the dead; so called from the first word of the introit. Requiem masses were composed by many of the older masters, such as Palestrina, Vittoria, Anerio, Colonna. The most famous works of this kind in modern times are those of Mozart (1791); two of Cherubini, C minor (1793), D minor (1836); Berlioz (1837); Verdi (1873). One of the greatest choral works ever written bears also the title requiem, although it is written to German words selected from the Bible. This is the great *Ein deutsches Requiem* by Brahms, written on the death of his mother (1868).

REQUISITIONS (Lat. *requisitio*, from *requirere*, to search for, require, from *re-*, back again, anew + *querere*, to seek). Articles of daily consumption and use levied by an invading army from the inhabitants of occupied territory. They must be distinguished from *contributions*, with which the term is often confused, the latter being properly confined to money impositions above the ordinary revenue which legitimately belongs to the invader; and from *fincs*, which are payment exacted from a district by way of punishment for some offense committed against the enemy outside the regular military operations.

The adoption by civilized nations of modern rules of warfare prohibiting pillage does not guarantee security of property to an invaded district. The experiences of the past century have authorized three methods of obtaining support for an invading army from an occupied district. (1) It may purchase provisions and like articles required for consumption; (2) it may levy them at prices fixed by the commander; (3) it may force the inhabitants to furnish them without payment and on refusal send out detachments to collect them. Thus the produce of the farmer, the goods of the merchant, and the stock of the trader may be confiscated. By the Brussels Military Code (1874), Arts. 40, 42, rules are laid down governing the making of requisitions. It is customary for the modern army to have a vast commissary train, and requisitions are relied upon only to supplement this supply. The commander of the army may levy such articles as clothing and boots, to prepare which time is required, while corps commanders may requisition food and fodder for immediate use. The collections should be made through the local authorities, if these continue, by demand in writing, and receipt should be given as evidence of the compliance and as a voucher in case the Government should subsequently recoup the inhabitants. The discretion of the invader must be employed to apportion these demands to the resources of the district. *Contributions*, on the other hand, should be imposed only "on the order and responsibility of the general-in-chief, or of the supreme civil authority, established by the enemy in the occupied territory" (Brussels Code, S. 41). In levying contributions assessment should be made on the lines of civil taxation.

Fines may be levied by the invading commander to secure the safety of his communications and his troops. Consult: "Instructions for the Government of the Armies of the United States in the Field," *General Order No. 100, Adjutant General's Office* (War Department, Washington, 1863); also "Brussels Military Code," in *Proceedings of Brussels Conference* (Brussels, 1874); and "Hague Military Code," in *Proceedings of the Hague Conference* (The Hague, 1898).

REDOS (OF., behind the back). The wall at the back of an altar, seat, or large fireplace. In churches the redos is usually in the form of a screen detached from the choir. It is of two forms: a slight movable screen, and a permanent heavier structure. The custom did not become common until the position of the priest at the altar changed, toward the twelfth century, so that his back was turned to the congregation. Early ones were often merely hanging tapestries on rods; some were screens of gold and silver reliefs rising at the back of the altar, like the Pala d'Oro at San Marco, Venice, and that at San Jacopo, Pistoia, while others were of carved ivory, like one in the Cluny Museum (Paris). The architectural screens, with niches, statues, marble reliefs, and paintings, are especially fine in English and Spanish churches. The redos corresponds somewhat to the choir-screen previously used in the West and still used in the Greek and Russian churches between the altar and the congregation.

RESBY, rēz'bī, Sir JOHN (1634-89). An English historian, born in Thribergh, Yorkshire. He entered Trinity, Cambridge, but left almost immediately for Gray's Inn; traveled on the Continent for several years, and after the Restoration served as high sheriff of Yorkshire, then for several years in the House of Commons, and (1682 sqq.) as governor of York. He was an able politician and foresaw James's fall in time to save himself and make favor with William of Orange. His *Memoirs* (1734) and *Travels* printed with the *Memoirs* (1813, 1821, 1831) are very valuable documents for the history of the time.

RESACA DE LA PALMA, rá-sá'ká dá lá päl'má, BATTLE OF. A short but hotly contested engagement, fought on May 9, 1846, during the Mexican War, between about 5000 Mexicans under General Arista and about 2300 Americans under General Taylor, which ended in the defeat of the Mexicans. The ravine in which it occurred, covered by a thick growth of palm trees, is in Cameron County, Texas, 4 miles north of Brownsville, on the Point Isabel road. The Americans lost 39 killed and 83 wounded, the Mexicans about 160 killed, 228 wounded, and 100 missing, though by some writers the total number of killed, wounded, and missing has been given as 1000. Consult: Baneroft, *History of Mexico*, vol. v. (San Francisco, 1885); and Howard, *Life of General Taylor* (New York, 1892), in the "Great Commanders Series." See MEXICAN WAR.

RÉSAL, rá'zál', HENRY AMÉ (1828-96). A French mathematician and engineer, born in Plombières (Vosges), and educated at the Ecole Polytechnique and at the School of Mines. He served for fifteen years as departmental engineer of Doubs, gaining some repute there for his work on the mathematics of geology; became

professor of mechanics in the Polytechnique in 1870; was elected to the Academy of Sciences in 1873; and in 1888 was appointed inspector general of mines. Résal wrote many valuable memoirs on mechanics and physics. His published work includes: *Traité de cinématique pure* (1862); *Traité de mécanique céleste* (1865; 2d ed. 1884); *Traité de mécanique générale* (1873-89); *Traité des surfaces* (1891); and a French version of Salmon's *Analytical Geometry* (1870).

RESCISSION (Lat. *rescissio*, a cutting off, retrenchment, from *rescindere*, to cut off, from *re-*, back again, anew + *scindere*, to cut). In law, the rescinding or setting aside of a contract, either by mutual agreement of the parties to it, or by direction of a court of equity because of some legal defect in the contract. See CONTRACT.

In the case of rescission not depending on mutual agreement, the right to rescind may be based either upon fraud or mistake in the inception of the contract. The right of rescission on ground of fraud arises as soon as the party who is entitled to rescind has notice of the fraud. If, with full knowledge of the fraud, he continues to act under the contract or pursuant to its terms, he will be deemed to have approved the contract and to have waived his right of rescission. Upon rescission of the contract he is entitled to compel a restoration of property which he has given as performance of the contract on his part or to recover its money value in a quasi-contract action. He cannot, however, recover the property so given from third parties who are purchasers for value without notice. See FRAUD; EQUITY.

A court of equity, however, will disregard the parol-evidence rule as to written contracts (see EVIDENCE) if it finds that there was actually no agreement or meeting of the minds of the parties as to the term of the contract, and it will compel a surrender and cancellation of the written contract and a restoration of the parties to the contract to their original positions. This form of relief is technically known as rescission, although its real purpose is to render non-effective written evidence which has been improperly obtained or given. In case of all verbal contracts one entitled to rescind may do so without the aid of a legal proceeding by merely giving notice. This right, although equitable in character, is recognized and enforced at law. Upon giving such notice to the other party to the contract it is thereupon deemed to be at an end; and the party rescinding the contract is entitled to receive back the money or property which he has given under the contract, the title to the money or property being revested in him by operation of law as consequence of the rescission. He may not lawfully take the property forcibly, however (see REMEDY), but may at his election bring an action in quasi contract for the value of his performance under the contract, or trover for damages for refusal to return property, or replevin to recover the property itself. As a condition precedent to rescission he should also return any money or property which he has received under the contract.

In case of all contracts, whether written or verbal, if one entitled to rescind the contract on ground of fraud is sued upon the contract, he may set up the fraud as a defense. Fraud is strictly an equitable defense, but it has been

completely adopted by the law. It does not conflict with the parol-evidence rule, as the effect of proof of fraud is not to vary the terms of the contract, but to show that on equitable grounds the contract actually entered into should not be permitted to remain operative. If, however, one who has entered into a written contract wishes to be released from its obligations at any time on ground of mistake, or if he wishes to be released from the contract at any time before he is actually sued upon it on the ground that the contract was induced by fraud, his only relief is in equity, since the primary relief which he seeks is the cancellation and surrender of the contract. See CHANCERY; EQUITY. See also REFORMATION.

RESCRIPTS (Lat. *rescriptum*, answer, from *rescribere*, to write back, from *re-*, back again, anew + *scribere*, to write). Answers of the emperors and popes to questions in jurisprudence officially propounded to them. In the Roman Empire the *rescripta principis* were one of the authoritative sources of the civil law. After the third century they increased in number rapidly and superseded the responses of the jurists as one of the most important sources of Roman law, the privilege of giving responses no longer being conferred upon the jurists. The rescripts directed to corporate and municipal bodies were known as *pragmaticæ sanctiones*, a name which has found its way into the public law of Europe. See PRAGMATIC SANCTION.

RESCUE. In criminal law, procuring or aiding in the forcible deliverance of a prisoner from lawful imprisonment, by a third person. By the common law, a rescuer was held guilty of the same degree of crime as the prisoner, if he knew that the latter was lawfully detained when he rescued him. This knowledge was presumed if the culprit was in prison, or in the custody of an officer of the law, at the time. To-day, the offence is punishable in most jurisdictions, but not with the same severity as at common law.

In maritime law a rescue is the retaking of a captured prize from the enemy by prisoners of war. The latter do not acquire any rights in the recaptured property, but must return it to the lawful owners.

RESCUE GRASS, SCHRADER'S BROME GRASS (*Bromus unioloides*). A strong-growing South American grass introduced into many parts of the world; in the United States under the name of Australian oat. Its leaves are flat, linear, slightly roughened; its panicles spreading with numerous rather large flattened spikelets resembling the well-known 'chess' or 'cheat' to which it is closely related. It grows rapidly to a height of 1 to 3 feet, seeds freely, and dies after seeding. In the Southern States it is regarded as one of the best winter grasses, as it makes its principal growth during cool weather. It is usually cut several times during the season and if prevented from seeding continues for 2 or 3 years. If properly treated it is a valuable brome grass (q.v.), excelling rye or oats as a winter grass and in the large amount of nutritious hay it yields. It withstands drought well and will grow on almost any soil; its best growth, however, is on rich moist soil.

RESECTION (Lat. *resectio*, from *resicare*, to cut off, from *re-*, back again, anew + *secare*, to cut; connected with OHG. *sega*, Ger. *Säge*, AS.

sage, *sayu*, Eng. *saw*), or EXCISION OF JOINTS. An operation in which the diseased bone of a joint is cut out, in place of cutting off the entire limb. This operation is safer in properly selected cases than is amputation, since there is diminished shock from the absence of severance of large nerve trunks, arteries, and veins. Besides this advantage there is left to the patient a fairly useful limb, though there is, of course, more or less shortening and the motility of the joint is lost. The extent of the disease process present and the possibility of extension of the disease above the joint after operation, as occurs in malignant disease (see TUMOR), are the factors that determine the surgeon in a choice between resection and amputation. In young patients, where excision of a joint often includes the epiphyses of the growing bones and interferes materially with the future growth and development of the limb, the scope of the operation is much restricted. Owing to the development of more conservative measures in dealing with diseases of the joints, formal or complete excisions are not now practiced as much as they were by surgeons of a decade ago. For a description of the operation of excision as applied to the different bones and joints, consult Stimson, *Operative Surgery* (Philadelphia, 1893).

RESERVATION (ML. *reservatio*, from Lat. *reservare*, to keep back, from *re-*, back again, anew + *servare*, to keep). In English law a term applied to a clause in a deed, lease, or grant of land, which reserves out of the estate conveyed a right or interest in a portion of it. An estate in a 'stranger,' or person not a party to the conveyance, cannot be created by reservation, which can only operate in favor of the grantor himself. In the United States the word is frequently used as synonymous with exception. (See CONVEYANCE; DEED; MORTGAGE; LEASE.) The term is also employed to describe a method of obtaining the opinion of a full bench of a court or an appellate court upon a point of law as to which the trial judge is doubtful. This often saves the necessity of making a ruling compelling the parties to appeal afterwards. The jury is usually allowed to find the facts, and the verdict or judgment is not entered until the reserved point is decided. In many code States this is accomplished by taking a verdict subject to the opinion of the court.

RESERVATIONS, INDIAN. See INDIAN AFFAIRS; TREATIES, INDIAN.

RESERVE (OF. *reserve*, Fr. *réserve*, from OF. *reserver*, Fr. *réservé*, to reserve, from Lat. *reservare*, to keep back). A term common in military affairs both as regards the material and the personnel of an army. For *reserve* in European armies, see ARMIES; LANDWEHR; MILITIA; RELIEF; VOLUNTEERS.

RESERVE, NAVAL. See NAVAL RESERVE.

RESERVED CASES. A term applied in the Roman Catholic Church to sins of a heinous character, such as heresy, simony, and sacrilege, that for their adequate treatment require the attention of an ecclesiastic superior to the parish priest, either the Pope, the bishop, or the head of an Order. The object of transferring the right to absolve such sins to the higher ecclesiastic is partly to impress upon the offender the true turpitude of his offense. Consult Hausmann,

Geschichte der päpstlichen Reservatfälle (Regensburg, 1868).

RESERVOIR. See DAMS AND RESERVOIRS; WATER-WORKS.

RESHID PASHA, *re-shēd' pā-shā'*, **MUSTAPHA MEHEMET** (1802-58). A Turkish statesman, and long the chief of the Party of Progress in Turkey. He was born at Constantinople. In 1833 he negotiated the Treaty of Kutaia with Mehemet Ali (q.v.), the rebellious Viceroy of Egypt. He subsequently represented Turkey at the courts of Great Britain and France, but was recalled in 1837, and made Foreign Minister. In this office he aided the Sultan Mahmud II. in carrying out his plans for the reform of the administration; but the Old Turkish Party forced him out of his office before the close of 1838. After this he was sent as envoy to London, Berlin, and Paris. On the death of Mahmud II., in 1839, when the Ottoman throne was tottering under a fresh onslaught by Mehemet Ali, Reshid Pasha was again called to take charge of the Foreign Office by the mother of the young Sultan, Abd-ul Medjid. He succeeded, after a debate in council of three days' duration, in obtaining the *hatti sherif* (q.v.) of Gulhane (November 3, 1839), a constitutional charter which, however, soon became a dead letter. His foreign diplomacy checked Mehemet Ali in Syria through the intervention of the Quadruple Alliance (Great Britain, Austria, Prussia, and Russia), but a seraglio intrigue led to his dismissal. From 1841 to 1845 he was the Turkish representative at the French Court. In 1845 he was once more made Foreign Minister, and in 1846 he was appointed Grand Vizier. He was repeatedly deposed, and almost immediately recalled, according as the anti-reform party gained or lost the favor of the Sultan; but the complications with Russia which arose in 1853 threw the anti-reformers into discredit, and Reshid Pasha, more powerful than ever, was again recalled to the direction of foreign affairs. In 1855 he again retired from office, which he did not resume till after the Peace of Paris.

RESHT, *rēsh't*. The capital of the Province of Ghilan, Persia, situated near the southwest shore of the Caspian Sea, 150 miles northwest of Teheran (Map: Persia, C. 3). The houses are tiled and neatly built, and the streets are paved. Water is supplied by an aqueduct. There are a vast ruined palace, numerous caravansaries, large bazaars, and about 1200 shops and warehouses. Indian wares are imported from Balfrush in Mazanderan, and European manufactures from Russian Armenia. Resht is the chief entrepôt for the Persian silk trade. Extensive manufactures of shawls and carpets are carried on. Population, about 40,000. Enzeli, the port of Resht, on the Caspian Sea, about 18 miles distant, has 1500 inhabitants.

RESICZABÁNYA, *rē'shitzs-ō-bān'yō*. A mining town in the County of Krassó-Szörény, Hungary, about 50 miles southeast of Temesvár. There are extensive iron and coal mines and iron works in the vicinity. Population, in 1900, 11,770.

RESIDENCE (ML. *residentialia*, from Lat. *residere*, to reside, remain, from *re-*, back + *sedere*, to sit; connected with Gk. ἔρθαι, *hezesthai*, OChurch Slav. *sěsti*, Skt. *sad*, Goth. *sitan*, OHG. *sizzen*, Ger. *sitzen*, AS. *sittan*, Eng. *sit*). The

obligation to perform in person the duties of a benefice whose revenue was enjoyed. It was early a complaint that this obligation was violated. The Council of Sardica (347) in its twelfth canon enjoined upon bishops and in the sixteenth upon presbyters the duty of continuous service in their proper residence. The evil continued through the centuries. In Reformation times it was a reproach that non-resident holders of benefices were so common, owing to the custom of pluralities. The Council of Trent endeavored to remedy the evil by providing in its 23d and 24th sessions, that no prelate should absent himself from his diocese more than three months, except for urgent cause. In present practice in the Roman Catholic Church parish priests cannot be absent longer than one week from their cure, except with the permission of the bishop.

RESIDUAL ROCKS (from Lat. *residuum*, remainder, from *residere*, to reside, remain). Rocks which have been produced through the decomposition and disintegration of rocks belonging to any of the larger divisions; viz. sedimentary, igneous, and metamorphic rocks. The agents which bring about these changes are in part chemical and in part physical. The active agents of chemical change at the surface of the earth are oxygen, water, and carbonic acid, all of which exist in the atmosphere and in the waters which percolate within and near the earth's surface, and the changes which they bring about are chiefly oxidation, hydration, and carbonization. The new minerals which are developed by these processes may be said to be in general lighter in weight (more bulky) and more soluble than the minerals out of which they have been formed. They are also as a class softer, and possess for the most part a fibrous or sealy texture. Particularly due to the change in volume which this recrystallization involves, a physical force is brought into play which opens fractures in the rock and permits of its solution and disintegration. The more soluble constituents of the rock are taken in solution and removed, while the less soluble materials remain as a more or less incoherent mass constituting the residual rock type. The residue from rocks of igneous and generally granitic types has been given various names such as 'waste,' 'geest,' 'Gruss,' etc. In unglaciated regions residual rocks of this type occasionally possess their original textures, lacking only the compactness characteristic of those types. Where situated on steep slopes the upper portions of the deposit of waste will by the force of gravitation slide down toward the valley, a process which is described as 'creep.' In glaciated regions, on the contrary, the surface layers of waste have been carried away by the ice mantle and the hard underlying rock has usually also been planed down. The comparative recency of the glacial epochs in a geological sense thus furnishes a certain measure of the time necessary to decompose and disintegrate compact rock masses. The final product of decomposition and disintegration of granitic rocks is a fine clay or kaolin, and this has been the source of the great deposits of porcelain clay throughout the world. Before this final stage of the alteration has been reached the residual rock has usually the structural peculiarities of a coarser or finer sand, and thus we have the residual sand of granite, etc. Calc-

reous rocks, such as limestone or dolomite, furnish in the initial stages of their solution and disintegration a granular calcareous sand. Joints and other fissure planes in massive rocks greatly facilitate the processes of decomposition and disintegration. The solutions which are active in these processes find their way along the joint planes as trunk lines, and by their more ready access to the edges and corners of included blocks of rock soon produce a spheroidal and often concentric structure. Thus are brought about spheroidal blocks of the igneous rock type, the centres of which are usually little changed, but the peripheral zones of which represent altered phases of the rock, the outermost being the most nearly disintegrated. This process goes on quite rapidly, as is shown by the fact that monuments and fence posts of basic igneous rocks have within the course of a century so far disintegrated as to be almost useless for the purposes to which they were applied.

Plant life by sending its roots into the soil protects from disintegration the underlying rocks. In arid regions, however, where little if any plant life can exist, winds are effective in removing the superficial layers of waste and continually exposing the underlying rock. The material removed by the winds on being deposited produces æolian rocks. See ÆOLIAN ACCUMULATIONS.

RESIDUARY LEGACY. A legacy of all that remains of an estate after the debts and specific legacies have been paid. Where a testator desires to give the bulk of his estate to one person, as his wife, and at the same time to make other smaller bequests, it is customary to make the latter by means of express or specific legacies, naming the amount or specific property, and then to devise and bequeath all the 'rest, residue, and remainder' of his estate to the favored person by a residuary clause. It sometimes happens, however, after the debts and minor specific legacies are paid, that the estate is exhausted, and the one whom the testator most intended to favor gets nothing. The best method of guarding against this contingency is to put a condition in each of the specific legacies to the effect that it shall be null and void if the appraised value of the estate is not in excess of a certain sum, or to make an express or specific bequest to the person who is to take precedence over the others, then make the other minor bequests, and conclude by making the first person the residuary legatee of the rest of the estate. See LEGACY; WILL.

RESINA, rà-sē'nà. A town in the Province of Naples, Italy, situated on the Gulf of Naples, at the foot of Vesuvius, 5 miles by rail southeast of Naples (Map: Italy, E 10). It is built on the site of ancient Herculaneum. Exquisite fruits are grown, and the famous *Lacrimæ Christi* wine is made in the vicinity. There are manufactures of silk, glass, and leather. The town is surrounded by country houses, and is a place of recreation for the Neapolitans. The ascent of Mount Vesuvius is begun at Resina. Population (commune), in 1901, 19,766.

RESINS (OF. *resine*, Fr. *résine*, from Lat. *resina*, *resine*, from Gk. *ῥητινῆ*, *rhētīnē*, pine-resin). A class of solid or semi-solid organic substances mostly of vegetable origin. The class

includes many minerals which are assumed to be the product of extinct vegetation. The resins are allied to the volatile oils, in which they are found dissolved when directly obtained from plants. The various resins, all composed of carbon, hydrogen, and oxygen, differ widely in their chemical behavior.

The following are the general characters of this class of compounds: At ordinary temperatures they are solid, translucent, and for the most part colored, although some are colorless and transparent. Some are devoid of odor, while others give off an aromatic fragrance from the admixture of volatile oil. In their crude state they never crystallize, but are amorphous and brittle, breaking with a conchoidal fracture; when pure several of them may, however, be obtained in the crystalline form. They are readily melted by the action of heat, and are inflammable, burning with a white smoky flame. They are insoluble in water, but dissolve in alcohol, ether, and various oils. They are insulators or non-conductors of electricity, and become negatively electric by friction. Many of them possess acid properties, in which case their alcoholic solutions redden litmus. These resins combine with the alkalies, and form frothy soap-like solutions in alkaline lyes. The resinous soaps thus formed differ from ordinary soap in not being precipitated by chloride of sodium.

The resins are generally obtained by making incisions into the wood of trees which produce them; sometimes, however, they exude spontaneously, and in other cases require to be extracted from the wood with hot alcohol or other solvents. The crude resins are separated from the volatile oils, with which they form the so-called *oleo-resins*, by distillation; and from the gummy and mucilaginous matters with the aid of alcohol, which dissolves out the pure resins.

The resins are extensively used in making lacs and varnishes. Colophony, copalia, jalap, podophyllum, and the resin of scammony are used medicinally. Colophony, or rosin, is an antiseptic and forms an excellent application for wounds and ulcers. Copaiba acts as a stimulant and disinfectant, and is often prescribed in gonorrhœa. Podophyllum, jalap, and the resin of scammony are purgatives, the latter causing profuse watery evacuation of the bowels.

Various *fossil resins* are known, of which the most important is amber. Some chemists place asphalt among this class; and among the fossil resins described by mineralogists may be mentioned copalin, hartite, xyloretin, etc.

Resins also form important constituents of the substances known as *gum resins* (see GUMS) and are contained in the so-called *balsams*, a class of liquid or semi-solid products including benzoin, styrax, and the balsams of Peru and Tolu. Resins containing benzoic or cinnamic acid are sometimes spoken of as 'solid balsams.' The common resin or rosin of commerce exudes in a semi-fluid state from several species of pine, being derived chiefly from the *Pinus australis* and the *Pinus pinaster*. The crude turpentine (an oleo-resin) obtained from these trees is distilled, leaving behind the resin, a brittle solid somewhat heavier than water. The resin soap used in the manufacture of common qualities of soap is obtained by boiling rosin for some time with caustic soda and water. Other resins most commonly known and used include copal, dam-

mar, dragon's blood, frankincense, lac, mastic, and sandarac.

Consult: Wiesner, *Die technisch verwendeten Gummiarten, Harze und Balsame* (Erlangen 1869); Theniis, *Die Harze und ihre Producte* (Vienna 1879); Cameron, *Oils, Resins, and Varnishes* (London, 1886).

RESIN WEED. See COMPASS PLANT.

RESISTANCE, ELECTRICAL. That property of a conductor which determines the intensity of an electric current flowing through it for a given difference of potential at its terminals. The resistance of a conductor varies with its temperature, but is the same for all currents. The unit of resistance, the ohm (q.v.) is such a resistance as will cause a current of one ampere to flow over a conductor when there is difference of potential of one volt between its terminals. This relation

is given by Ohm's law that $C = \frac{E}{R}$, where C

stands for the current, E for the electromotive force, and R for the resistance. The resistance of a homogeneous conductor will vary directly as its length and inversely as the area of its cross-section, or in the case of a round wire inversely as the square of the diameter. Specific resistance is the resistance of a centimeter cube of a substance in microhms, while the relative conductivity of a conductor is its relative resistance to some standard substance, generally annealed copper. Resistance may be measured by means of the Wheatstone bridge (q.v) or by substituting known resistances for unknown, so as to produce an equivalent current, which is indicated by the deflection of the galvanometer (q.v.). Another method is to use the differential galvanometer and so arrange the known resistances that the same current flows through each set of coils, while there are also methods where use is made of the condenser and ballistic galvanometer. See ELECTRICITY; CONDUCTOR; OHM; ELECTRICAL UNITS.

RES JUDICATA (Lat., thing adjudged). In law, a matter of controversy which has been finally decided and determined on its merits by a court of competent jurisdiction. This implies that there has been no fraud or collusion by which the court has been misled. The importance of this doctrine lies in the fact that if a matter is once judicially determined it cannot again be litigated. To make the entire subject-matter of an action *res judicata* all the parties interested must be made parties thereto, either as plaintiffs or defendants. Only the points actually decided come within this rule. See JEOPARDY; JUDGMENT.

RESOLUTION. In law, an act or official expression of the will of a legislative body, corporation, or organized assembly. The term is sometimes used as being synonymous with *ordinance*, when applied to an act of a municipal council or a board of aldermen. However, resolutions are usually adopted to authorize ministerial acts, or to express the sentiment or regard of a body, whereas ordinances are passed to prescribe permanent rules of conduct or law. For example: If a common council desires to regulate the speed of vehicles, it would be done by an ordinance; whereas, if the freedom of the city were to be extended to a distinguished guest, it would be done by a resolution.

In the civil law the discharge of a valid contract by consent of the parties or by decree of a court is said to be a *resolution* of the contract. This is distinguished from a *recession*, which implies that the contract was void *ab initio*.

RESONANCE (OF. *resonnance*, Fr. *résonance*, from Lat. *resonantia*, echo, from *resonare*, to sound back, from *re-*, back again, anew + *sonare*, to sound, from *sonus*, sound; connected with Skt. *svan*, to sound). A general mechanical property which has many illustrations in nature. If a large bell is to be set in motion, it is only necessary to apply a series of impulses regularly timed at intervals to correspond with the natural period of the body. The column of air in a bottle or tube may be set in vibration by waves whose period is the same as that of the column of air. (This is illustrated by the strengthening of certain sounds heard when a bottle or a large seashell is put near the ear, for in any room there are present waves of all periods.) If a train of ether-waves passes through some material medium the minute portions of which have a frequency the same as that of the waves, it will set these portions of matter vibrating. The waves thus lose energy, which is gained by the matter. See RADIATION AND ABSORPTION.

RESONATOR. A device used in acoustics (q.v.) to reinforce or strengthen a given tone. Resonators, which are used largely in the analysis of sound, consist of hollow vessels usually bulb-shaped or cylindrical. The air of such a vessel has a natural period of vibration, and when the resonator is brought near a sounding body which is emitting waves of the same frequency the former will take up the vibration and will emit the sound. In analyzing sound which is made up of numerous harmonics or overtones the resonator will select a particular sound, which it will reinforce, and if a diaphragm is placed so that it will vibrate under the action of the air in the resonator, the motion can be communicated to a small gas flame, as in Koenig's manometric capsule. Resonators in the form of wooden boxes are frequently used to mount tuning forks on and are constructed of such dimensions that the contained air will vibrate in unison with the fork and so strengthen the sound.

RESORCIN, or RESORCINOL (from *res-in* + *orein*), $C_6H_4(OH)_2$. A diatomic phenol first obtained by Hlasiwetz and Barth in 1864, by fusing resins with potassium hydroxide. It has since been obtained by various other reactions. On an industrial scale it is made by fusing the sodium salt of meta-benzene-disulphonic acid with caustic soda, resorein being thus produced according to the following chemical equation:

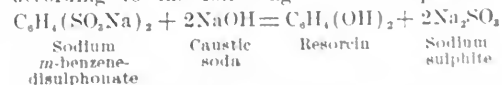

The mixture is acidified with hydrochloric acid, and the resorein is separated by means of ether or some other liquid in which it is soluble. The crude resorein thus obtained is purified by distillation. It may be added that the meta-benzene-disulphonic acid used in making resorein is obtained by heating benzene with fuming sulphuric acid. Pure resorein is a colorless crystalline substance melting at 119° C. (246.2° F.) and boiling at 276.5° C. (529.7° F.). It has a faint odor and a sweetish taste, but leaves a dis-

agreeable pungent after-taste. It is freely soluble in water, alcohol, ether, benzene, amyl alcohol, glycerin, and other organic liquids. Resorcin is largely used in the arts for the preparation of phthalein dyes, such as fluorescein, eosin, etc.; it is also employed in the manufacture of azo-colors. It is often used in medicine. When applied externally it has the effect of removing scales in chronic skin diseases; it is an excellent remedy for dandruff, a mixture of resorcin and glycerin being best employed for this purpose. Administered internally, in dilute form, it is very valuable in fermentative dyspepsia.

RESPIRATION (Lat. *respiratio*, from *respirare*, to breathe), **ORGANS AND PROCESS OF**. The two great objects of respiration are: (1) To supply that amount of oxygen to the body which is essential to its economy, and (2) to remove the carbon dioxide which has been produced as a waste product. We may consider the anatomical details of the respiratory process in man and mammals under three different heads. First, there must be a special respiratory organ—the lungs—affording by its internal arrangement an immense extent of internal surface, covered by vascular network, through which the blood flows in innumerable minute streamlets, only separated by an extremely thin membrane from the atmospheric air that has been inhaled; secondly, there must be such an arrangement of the circulating system that fresh blood may be continually driven through the lungs, and then onward to the general system; and thirdly, there must be arrangements for the frequent and regular change of air contained in the lungs. The special organs of respiration consist of the larynx, the trachea, the bronchi, and the lungs. For a description of the first two, see LARYNX; TRACHEA.

The two *bronchi* resemble the trachea in structure except that the incomplete rings are distributed on all sides of the tubes. The bronchi on entering the lungs divide into smaller and smaller branches until finally each minute branch terminates in a *pulmonary lobule*. The smaller bronchi, as they are called, lose their cartilaginous rings and the circular or transverse muscular layer forms a distinct coat. The mucous membrane is very delicate and lined with ciliated epithelium. Within the lobules of the lung the smaller bronchi divide still further into more minute branches and their structure becomes more delicate, until at last they consist only of a thin membrane lined by a single layer of squamous epithelium. At this point they widen out into small funnel-like air spaces (*intercellular passages*), the walls of which bulge irregularly in different places into small sac-like dilatations which are the *air cells* of the lungs. These air cells are from $\frac{1}{300}$ th to $\frac{1}{3000}$ th of an inch in diameter. Their walls are very thin and are lined by a single layer of flattened cells continuous with those of the intercellular passage. The air vesicles of one lobule do not communicate with those of another, nor even with those of adjacent intercellular passages as a rule. Therefore any obstruction of a bronchus cuts off the supply of air to the lobule beyond. Elastic tissue fills in the space between the air cells and within this elastic tissue ramifies a dense network of capillary blood vessels which lies close against the air cells and which is separated from their contents by only

an extremely delicate membrane. It is here that the interchange of gaseous elements between the atmosphere and the blood takes place.

The pulmonary lobules are bound together by connective and elastic tissue to form very much larger structures called lobes. Of these lobes the right lung presents three and the left two. Each lung is enveloped by a serous covering—the *pleura*—which is reflected from the lung at the point where the bronchus and great blood vessels enter and passing outward line the cavity of the chest. (See PLEURA.) In health there is no space between the layer of the pleura which covers the lung and that which lines the chest wall, but in disease or injury serum, blood, pus, or air may collect therein. These conditions are termed respectively *pleurisy with effusion*, *hæmato-thorax*, *pyo-thorax* or *empyema*, and *pneumo-thorax*.

In consequence of the great number of air cells which constitute their substance (over 600,000,000, it has been calculated), the lungs (except in the fetal state, when no air enters them) are the lightest organs, in relation to their size, in the body. Although their bulk is so great that, with the heart, they occupy almost the whole of the cavity of the chest, they only weigh about three pounds and a half in men, and two pounds and three-quarters in women. Their color varies at different ages. At birth they are of a pinkish white tint; in adult life they are of a slate color, and present a mottled appearance; and in old age they become of a still darker tint. The polygonal markings which are seen on the surface correspond to the outer surface of the lobules already noticed. Their shape is adapted to that of the cavity in which they are lodged, each lung being conical in form, with its apex rising into the neck, while its base, which is broad and concave, rests upon the convex surface of the diaphragm; and between the two lungs lie the heart and the great vessels that proceed from it. During life—except in certain diseases, as, for instance, pericarditis (q.v.)—the inner margins of the lungs nearly overlap the heart, leaving only a roundish space of that organ, less than two inches in diameter, uncovered, while their lower borders extend to the cartilages of the ribs, and fit into the angle formed between those cartilages and the diaphragm.

For the method by which the blood is perpetually changed in the lungs, see CIRCULATION.

For a description of the shape and framework of the chest, see CHEST. The chest (or thorax, as it is termed by anatomists) is so constructed as to be capable of enlargement in height (vertically), in depth (or from the front backward), and in width (or from side to side). Its height is increased mainly by the descent of the diaphragm, and to a certain extent by the elevation of the ribs and the widening of the intercostal spaces; while its depth and width are increased by the elevation of the ribs, which carry forward and elevate the breast-bone (or sternum), especially at its lowest end, and are slightly rotated on an imaginary axis, joining their extremities, by which their central portion is raised, and slightly removed from the mesial plane of the chest. It is only in forced or deep inspiration that all these means of enlarging the chest are called into play. An ordinary inspiration is attended in men with very slight elevation of the ribs (about one-twentieth of an inch), while in women the elevation is much greater, especially in the upper ribs, the

cause of this difference in the sexes probably lying in the narrower waist of the female requiring a compensation in the upper part of the chest. There are three varieties of ordinary respiration—viz.: (1) Abdominal, or that chiefly effected by the diaphragm, and seen in the motion of the walls of the belly; (2) costo-inferior, or that in which the seven lower ribs are observed to act; and (3) costo-superior, or that effected in a considerable degree by the upper ribs. The first variety occurs in infants up to the end of the third year; the second in boys after the age of three, and in men; and the third in adult females.

The following points in connection with the respiratory movements require notice. Every complete act of respiration is divisible into four parts—viz.: (1) Inspiration; (2) a short pause, not always observed; (3) expiration; and (4) a considerable pause, occupying, according to Vierordt, about one-fifth of the whole time required for one complete respiratory act. The act of expiration is always more prolonged than that of inspiration, the former being to the latter in the ratio of 12:10 in adult males, and as 14:10 in children, women, and aged persons. The number of respiratory acts performed in a minute varies at different ages. According to Quetelet, at birth there are 44 respirations in one minute; at 5 years of age, 26; from 15 to 20, 20; from 20 to 25, 18.7; from 25 to 30, 16; from 30 to 50, 18.1; so that from 16 to 20 may be taken as the ordinary range for healthy adults, although Hutchinson gives the wide range of from 16 to 40. The average ratio which the number of respirations bear to the number of pulsations in a given time is about 1:4½, and if there is any great deviation from this ratio, there is probably some obstruction to the aëration of the blood, or some disorder of the nervous system. Thus, in pneumonia (or inflammation of the lungs), in which a greater or less amount of pulmonary tissue is unfitted for its office, the number of the respirations increases in a more rapid proportion than the number of pulsations, so that the ratio becomes as 1:3, or even as 1:2. In hysteria a similar or even greater deviation from the normal ratio may occur; and Elliotson records a case in which the respiratory movements were 98, or even 106, while the pulse was 104. On the other hand, in certain typhoid conditions, and in narcotic poisoning, the respiratory acts are diminished in number, the ratio of respiration to pulsations being as 1:6, or even 1:8.

When the lungs have been emptied as much as possible of air by the most powerful expiratory effort, they still contain a quantity over which we have no control, and which may be estimated at about 100 cubic inches. To this portion of the contents of the lungs the term *residual air* is applied. In addition to this residual air, physiologists distinguish, in connection with the respiratory process, *reserve air*, which is that portion which remains in the chest after an ordinary gentle expiration, but which may be displaced at will; *breathing* or *tidal air*, which is the volume that is displaced by the constant gentle inspiration and expiration; and *complemental air*, or the quantity which can be inhaled by the deepest possible inspiration, over and above that which is introduced in ordinary breathing. The greatest volume of air that can be expelled by the most powerful expiration, which is obviously the sum of the reserve, breathing, and complemental air,

is designated as the *vital capacity*—a term originally introduced by Dr. Hutchinson, the inventor of the spirometer, who found, from nearly 5000 observations, that of all the elements or factors which might be supposed to influence it, *height* alone stood in a definite and constant relation to it, this relation being expressed by the rule that "for every inch of stature from 5 to 6 feet, 8 additional cubic inches of air (at 60° F.) are given out by a forced expiration after a full inspiration." Hutchinson found that 225 cubic inches is the average capacity of a healthy adult 5 feet and 7 inches tall. With regard to bodily weight as a factor, Hutchinson found that "when the man exceeds the average weight (at each height) by 7 per cent., the vital capacity decreases 1 cubic inch per pound for the next 35 pounds above his weight." Age and muscular development do not influence the result so much as might have been expected. It has been not unfrequently observed that the vital capacity is small in athletic men, and that it has been in excess in persons by no means remarkable for physical power. The *maximum* vital capacity met with by Hutchinson was 464 cubic inches; this was in a man 7 feet high, whose weight was 308 pounds; the *minimum* was 46 cubic inches, and occurred in the case of a dwarf whose height was only 29 inches and who weighed 40 pounds. The average inspiration in a healthy man at rest is about 30 cubic inches, and this increases with exercise of any kind. When we consider that the amount of air taken in at each respiration is only about one-seventh the capacity of the lungs, we see how slowly the air is renewed; but the law of the *diffusion of gases* (q.v.) here comes in play, for the air in the air cells and finer tubes being charged by the respiratory process with a great excess of carbonic acid, as compared with the inspired air contained in the larger tubes, a diffusion of the carbonic acid necessarily takes place in the outward direction, while the oxygen from the air, or the air itself, similarly diffuses itself in an opposite direction, toward and into the air cells themselves. The *total amount* of air which passes through the lungs in 24 hours must obviously vary with the extent and frequency of the respiratory movements. The total daily amount for a person at rest is 686,000 cubic inches. This quantity is largely increased by exertion.

The *alterations* in the inspired air effected by respiration consist essentially in the removal of a portion of the oxygen, and its replacement by a nearly corresponding bulk of carbonic acid. The amount of carbonic acid in the expired air varies inversely with the number of respirations: it reaches 5.5 per cent. (or more) when the respirations are only 6 in the minute, while it falls as low as about 2.6 per cent. when the respirations are 96 in the minute. About 4.35 per cent. of carbonic acid is, on an average, added to the air in ordinary respiration, while about 4.782 per cent. of oxygen is removed, the actual diminution of bulk of the expired air (after the removal of the moisture obtained from the lungs) being about one forty-fifth of its volume. Hence, unless where there is free ventilation, the air in an apartment containing men or animals must soon become vitiated by containing a great excess of carbonic acid (for ordinary atmospheric air only contains about one part of carbonic acid in 2500 parts),

and a deficiency of oxygen. The absolute quantity of carbonic acid (and consequently of carbon) exhaled in 24 hours is liable to great variations, caused by the temperature and moisture of the air, age, sex, muscular development, the nature and quantity of the food, muscular exercise, sleep, state of health, etc. Smith calculated that an adult man in a state of rest exhales in 24 hours an amount of carbonic acid equivalent to 7.144 ounces of carbon, and he estimated that it should be increased to 8.68 and 11.7 ounces for non-laboring and laboring persons respectively at their ordinary rate of exertion; that the total amount of carbonic acid is greatly increased by external cold, and diminished by heat; that it is increased by a moist, and diminished by a dry atmosphere; that it increases in both sexes to about the thirtieth year, when it remains stationary for fifteen years, after which it diminishes; that at all ages beyond eight years it is greater in males than in females, and that it increases during pregnancy; that it is greater in robust than in slender men, the quantity of carbon expired per diem to each one pound of bodily weight being (according to Smith) 17.07, 17.51, and 17.99 grains at forty-eight, thirty-nine, and thirty-three years of age respectively; that it is greatly increased by eating, and is diminished by fasting; that it is increased by muscular exertion (Smith found that when walking three miles an hour he excreted 2.6 more carbonic acid than when at rest, while tread-wheel labor occasioned about double the excretion that was caused by walking); that it was diminished by sleep; and that it is increased in the exanthematous fevers (measles, smallpox, scarlatina, etc.) and in chlorosis, while it is diminished in typhus and in chronic diseases of the respiratory organs. See MUSCULAR FORCE.

There has been much discussion with regard to the extent to which the nitrogen of the air is affected by respiration. Usually a small amount of this gas is given off, but the quantities absorbed and exhaled so nearly balance each other that its special action on the organism must be very trifling, further than as being a diluter of the oxygen, which would be too stimulating if breathed in a pure state. The amount of the watery vapor with which the exhaled air is saturated may range from about 6 to 27 ounces in 24 hours, its usual range being between 7 and 11 ounces. It is not pure water, but holds in solution a considerable amount of carbonic acid and an albuminous substance in a state of decomposition, which, on exposing the fluid to an elevated temperature, occasions a very evident putrid odor. See BRONCHITIS; PNEUMONIA; TUBERCULOSIS.

The well-known anatomical divisions of the lungs, known as lobes, are composed histologically of an enormous number of little lobes or lobules. Each lobule is separated from surrounding lobules by connective tissue, and the lobules which come to the surface of the lung are often distinguishable as little polygonal areas. Each pulmonary lobule consists of a single terminal bronchus and the group of air cells and spaces connected with that bronchus. The terminal bronchus on entering a lobule divides into several branches known as alveolar ducts. These open into considerably larger cavities called infundibula, from the sides of which the air sacs or

air cells open out like alcoves. The terminal bronchus is lined by a single layer of ciliated columnar epithelium. Outside of this are some elastic fibres and thin irregular bundles of smooth muscle cells. As the alveolar ducts are approached the ciliated epithelium is replaced by lower epithelium of the non-ciliated variety. In the alveolar ducts the epithelium is cuboidal, and the elastic tissue and smooth muscle are greatly reduced in amount. In the infundibulum

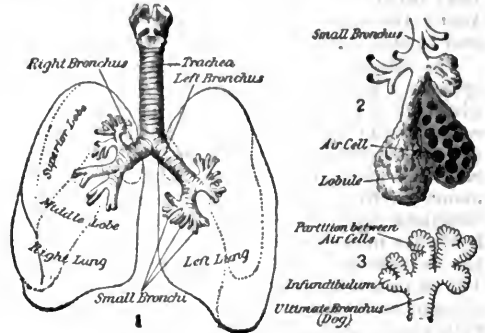

1. Trachea and bronchi. 2. Small bronchus showing air cell and lobule. 3. Ultimate bronchus of dog.

the epithelium consists mainly of large flat non-nucleated cells known as respiratory epithelium. Among these are scattered smaller polyhedral cells which are remains of fetal life and are called embryonal cells. Elastic tissue forms the supporting framework of the air sacs and forms a distinct ring around the mouth of each sac. In addition to the elastic tissue there is usually a small amount of fibrous connective tissue and some connective tissue cells surrounding the air sacs. Besides the parts just described, which may be considered as the parenchyma of the lung, there are seen in all sections of lung tissue bronchi of various sizes. The smaller bronchi are lined with a single layer of columnar ciliated epithelium lying upon a basement membrane. Beneath the latter is the stroma of the mucous membrane, outside of which is a circular layer of smooth muscle, the whole being surrounded by a connective tissue or fibrous coat. In the medium size and larger bronchi a distinct sub-mucous coat is present in which are imbedded the acini of mucous glands, while in the fibrous coat are situated various sized plates of hyalin cartilage. In the largest of the bronchi the epithelium, instead of consisting of a single layer, is made up of several layers, and there is an increase in the thickness of the muscularis mucosæ and of the fibrous coat.

The blood vessels of the lung belong to two distinct systems: one, the bronchial system, is for the nourishment of the lung proper; the other, the pulmonary system, is for the purpose of exposing the blood to the air in the lungs. Both systems of vessels enter the lung at the hilus accompanying the large divisions of the bronchus. Within the lung the pulmonary system of vessels give off branches which correspond to the divisions of the bronchi, and on reaching the septa between the infundibula, break up into an extremely rich network of capillaries which surround the air sacs. At the margins of the air sacs the blood from the capillary network enters the radicles of the pulmonary veins, which

accompany the arteries to the surface of the lung. The bronchial system of vessels accompany the bronchial tubes and supply capillary networks to them and to the other structures of the lung. The lymphatics of the lung, like the blood vessels, consist of two sets. One of these originates in the lymph spaces of the interlobular connective tissue and in the subpleural lymph spaces, communicating by means of the latter with the surface of the pleura. The second set of lymphatics, the bronchial lymphatics, originates in the subepithelial lymph spaces of the bronchi, which communicate with the mucous surfaces of the bronchi and air sacs. From these spaces definite lymphatic channels are formed which follow the blood vessels to the surface of the lung and pass thence by means of a few large trunks to the bronchial lymph glands. The nerves of the lung come from both cerebro-spinal and sympathetic systems. The main nerve trunks enter the lung at the hilus and follow the branchings of the blood vessels and the bronchi. On arriving at the smaller bronchi the nerves break up into fine non-medullated fibrils which pass to the muscular tissue and to the mucous membrane.

RESPIRATION (in plants). A series of processes by which plants release the necessary energy for growth, movement, and similar work. Although the true nature of respiration was stated by Ingenhousz before the beginning of the nineteenth century and its relation to growth and the evolution of heat was clearly set forth by DeSaussure in 1824, confusion between photosynthesis and respiration has persisted to the present day.

The method of obtaining energy in the presence of free oxygen by oxidizing and decomposing materials within the body is known as normal respiration. The process of self-decomposition in the absence of free oxygen is known (inaptly) as intramolecular respiration; while the process of securing energy by the decomposition of the surrounding medium is designated as fermentation. Under ordinary conditions, almost all plants are able to absorb free oxygen from the atmosphere at all times. But if the absorption of free oxygen is impossible, the protoplasm may set up such changes in its own substance or in media adjacent to it as to secure the necessary energy by their decomposition. Some of the very simplest plants (anaerobic bacteria) have adapted themselves to this mode of life and flourish only in the absence of free oxygen. Others (bacteria, yeasts, molds, etc.) may live and grow in the presence of free oxygen, but when deprived of this actively decompose the substances with which they are in contact, which are then said to ferment or putrefy.

Normal respiration consists essentially of four independent processes: first, the absorption of oxygen; second, the union of oxygen with the substances to be oxidized; third, the decomposition of these substances, with the formation of various end products, differing according to circumstances; fourth, the elimination of these products. Its activity varies much with different plants and different parts of the same plant, and is influenced strikingly by external conditions. Considering only respiration occurring under favorable conditions, that of organs rich in protoplasm is more active than that of watery organs. Thus

growing points (buds), flowers, seeds, and so on respire more actively than fleshy leaves and tubers. The respiration of water and marsh plants is in general less active than that of land plants. The rate of respiration in active plant organs is several times greater per unit of weight than human respiration. The most active respiration recorded is that of young wheat leaves, which consume in 24 hours one gram of oxygen for each 0.1 gram of their weight. In human respiration one gram of oxygen is consumed per 100 grams of weight. Active aerobic bacteria may consume 200 times as much oxygen as that used by man per unit of weight. When the oxygen pressure is reduced to one-third its normal, respiration is retarded. Under increased pressure the results differ according to the duration of exposure. For a short time plants may respire normally at two to six atmospheres of pure oxygen. Under a longer exposure to such pressures respiration is likely to be retarded. Variations in temperature, which are frequent in nature, exert a double effect; as the temperature rises more oxygen is absorbed and more CO₂ is eliminated. With rising temperature respiration does not, as most functions do, attain a maximum and then diminish with further increase of temperature, but it is accelerated until death ensues. Yet the respiratory rate does not increase in direct proportion to the increase of temperature. Light appears to have little or no effect upon respiration.

INTRAMOLECULAR RESPIRATION. The exclusion of oxygen from plants which normally use it produces a profound disturbance of the usual metabolism, as shown by the fact that the end products of respiration, instead of being chiefly carbon dioxide and water, are alcohol, hydrogen, organic acids, etc. For most plants, a period of intramolecular respiration seems to be a time to be tidied over, growth ceases, and most other functions are suspended. After the decomposition of the protoplasm has gone to a certain extent, death ensues. Therefore, at high temperatures, which accelerate the process, intramolecular respiration suffices to maintain life for a shorter time than at low temperatures. See FERMENTATION.

RESPIRATION, ARTIFICIAL. The exchange of air as in natural breathing (see RESPIRATION, ORGANS AND PROCESS OF), produced by mechanical means. Respiration is suspended when for any reason the muscles concerned in breathing are deprived of their wonted nervous stimulation, by poisoning of the nerve centres which govern them. This may take place in asphyxiation by poisonous gases, in drowning, poisoning, or by prematurely cutting off the placental circulation during parturition; and it is in these circumstances that artificial respiration finds its greatest usefulness. (See ASPHYXIA.) The object in resuscitation (q.v.) is to imitate as closely as possible the natural respiratory movements. These should be rhythmical and at the rate of twelve or fourteen to the minute. Several methods of carrying on artificial respiration have been devised. Of these the most generally useful is that of Sylvester. In this method the body of the person to be revived is placed upon the back, the shoulders being slightly elevated, and high enough to keep the chin from falling forward on the chest. The arms are then grasped

just above the elbows, and raised gently and steadily upward and forward to their full extent, and at the same time rotated slightly outward. This position is maintained for two or three seconds and secures *inspiration*. The arms are now lowered and pressed firmly against the sides of the chest for two or three seconds, thus bringing about *expiration*. These movements are repeated in alternation with regularity and precision, at the rate above mentioned. Sylvester's method is the one generally employed to resuscitate the drowned. Before proceeding with artificial respiration in these cases certain preparations have to be made. To drain off water from the stomach and chest, the patient is stripped to the waist and placed face downward with the pit of the stomach raised above the level of the mouth by a roll of clothing or other material placed transversely beneath the trunk. Pressure is then made upon the patient's back. The tongue must be held out, the larynx kept open, and the mouth and throat cleared of mucus. In cases of drowning efforts to resuscitate should be continued for at least an hour, apparently inanimate individuals having been brought to life at the end of that time, after having been immersed half an hour or longer. Attempts to restore respiration should be supplemented by friction, the administration of stimulants, and the application of heat to the abdomen and lower extremities.

Schultz's method, applicable especially to the resuscitation of newly born infants, is as follows: The operator stands behind the patient. The shoulders are grasped, with an index finger in each armpit, the thumbs over the shoulders, and the rest of the fingers resting obliquely over the back. The whole weight of the child's body is now allowed to hang from the shoulders. This lifts the ribs, expands the chest, and produces mechanical inspiration. Expiration is produced by swinging the child forward at arms' length to a point where the lower limbs and pelvis topple over toward the operator, thus bringing about extreme flexion of the trunk, and forcing the abdominal viscera against the diaphragm. This motion is then reversed, and the process repeated at the rate of eight or nine times a minute.

In the method of Byrd-Dew the neck is supported by one hand, the thighs upon the other, the child lying upon its back. The head is allowed to fall backward so that the glottis may remain freely open. The body is then alternately extended and flexed, which movements determine respectively inspiration and expiration.

Fell's method of artificial respiration consists in pushing a tube into the larynx and trachea, and forcing warmed air into the lungs by means of a bellows. Expiration is secured by pressure on the sides of the chest.

Gibbons's method, which is applied by its author to cases of apparent death from electricity, consists of inserting one end of a tube into a nostril of the inanimate person and then, after closing the other nostril, working two bellows alternately so as to exhaust the air in the lungs and then supply fresh air under pressure.

Laborde's method depends on rhythmical traction of the tongue. This organ is seized, as far back as possible, between the thumb and index finger wrapped in linen, and alternately pulled forcibly forward and relaxed. This method is supposed to excite breathing by reflex action.

A practicable and very useful method especial-

ly for young children is mouth-to-mouth insufflation. A piece of gauze is laid over the mouth of the child and air breathed directly into its lungs from those of the operator.

RESPIRATORY SOUNDS. Sounds produced during inspiration and expiration as perceived by auscultation, either by placing the ear upon the chest or through the medium of the stethoscope (q.v.). When the ear is placed upon the chest of a healthy adult, a soft, rustling sound is heard, comparable to the sighing of a gentle breeze among the leaves. This sound is louder and more marked during the inspiratory act, which is in health longer than expiration in the ratio of 6:5. To this sound the name *vesicular murmur* has been given. Certain areas of the chest, where the large bronchi are nearer the surface, viz. over the sternum, the junction of the first costal cartilage with the sternum, and a diamond-shaped space at the back in the middle line, the sound becomes tubular, and higher pitched, and expiration and inspiration are of equal length. This is called bronchial breathing and is significant of disease when it occurs elsewhere than over the areas above indicated. Where these two sounds shade into each other, *broncho-vesicular* breathing is heard.

In pathological conditions of the lungs, the vesicular murmur undergoes many important modifications. It is, for example, diminished or completely obliterated in pleurisy (q.v.) with effusion and in pneumothorax; it becomes louder and higher in pitch over consolidated lung tissue such as occurs in pneumonia and pulmonary tuberculosis (q.v.). One of the earliest physical signs of phthisis is a prolonged respiratory murmur, and this alteration of the normal rhythm is also characteristic of asthma and emphysema (q.v.). Interrupted breathing, sometimes called *cog-wheel respiration*, is heard in healthy but nervous individuals, but in disease it is caused by the breaking of the column of air passing through the bronchials by tenacious mucus, or by the expansion of different lobes at different times.

Certain adventitious sounds to which the generic name *râles* is applied are heard in disease, and are produced either in the bronchial tubes or air vesicles. Dry râles are whistling, squeaking sounds, caused by the passage of air through bronchial tubes narrowed in places by swelling of the lining mucous membrane, as in bronchitis, or by spasm, as in asthma; or by tough, adherent mucus. Moist râles are produced by the expansion of previously closed air cells, or by the passage of air through fluid in the bronchial tubes or in a cavity. These are heard in tuberculosis, the resolving stage of lobar pneumonia, pulmonary œdema, etc. *Metallic tinkling* is a sharp, quick sound resembling that produced by striking a glass vessel with a pin. Its presence gives evidence of the presence in the lung of a cavity of considerable size containing air, and surrounded by firm walls. A *friction sound* is produced by the rubbing together of the visceral and parietal layers of the pleura when rough from inflammation, and is indicative of pleurisy. Consult Loomis's *Physical Diagnosis* (New York, 1902). See AUSCULTATION.

RESPIRATORY SYSTEM, COMPARATIVE ANATOMY OF THE. The system of organs that have the function, in the animal body, of taking in oxygen from the surrounding mediums (water

and air) and of getting rid of carbon dioxide gas and certain other excrementitious products. In Vertebrata these organs are either gills or lungs. In invertebrates the skin always functions, more or less, as a respiratory organ, and in addition various other organs subserve this function also. Whatever form or position the respiratory organ may assume, it must be richly supplied with blood vessels so that the blood containing carbon dioxide may come in close relation with the surrounding medium. No organ may be spoken of as a respiratory organ which has not this vascular apparatus. Specialized respiratory organs do not appear in the animal kingdom until the segmented worms are reached, and even in many of the segmented worms no specific respiratory apparatus is developed. The integument of lower forms and sometimes the wall of the intestine, when this organ is present, perform the respiratory function; the integument is better able to do so, since it is the part that comes most intimately in contact with the surrounding media.

In echinoderms there are no respiratory organs that are homologous throughout the phylum. In holothurians this function is performed by the 'respiratory tree,' a mass of delicate branched tubules which open into the eloaca; by the oral tentacles; and by the entire body-wall. In the other forms various other organs perform this function.

Mollusks, as a rule, have one (in a few cases more than one) pair of breathing organs, the gills, which are covered and protected by the mantle. In some forms this gill is wanting and in others it is functionally replaced by other and phylogenetically newer organs. Blood flows into these gills and after taking in oxygen from the water it flows back again, first to the heart and then to all parts of the body. The lamelli-branch gills appear double on account of the strong development of the two rows of branchial leaflets, and in some mollusks increased surface is obtained by a folding of the leaflets. Scaphopoda and many Gastropoda do not possess true gills. In certain cases they are replaced by adaptive gills. The latter may be delicate leaflets forming a rosette around the anus; or folds to the right and left in the mantle cavity; or cerata. The dorsal finger-like processes of Nudibranchiata. Some Pulmonata have become adapted for aerial breathing. In this case the mantle cavity is richly supplied with blood vessels in its dorsal wall and gains a respiratory aperture, the so-called 'lung.'

Respiration in all Crustacea takes place in the outer integument. In small Crustacea there are no specially developed respiratory organs, and respiration is performed by the entire body surface. In the large Crustacea certain parts of the body are adapted to perform this function more actively than others. To fit such parts of the body for a respiratory function folds of the integument arise and the soft skin of the folds is functional in respiration. When this fold is transformed into a hard shield, it serves to protect the delicate breathing organs. The function of respiration is performed in most Crustacea by the thoracic limbs. Some of the crabs live more or less on land and are adapted to retain water in the branchial cavity and to breathe air directly. In the latter case the part of the branchial cavity that functions as a lung has its

integument modified into branched tufts which project into the air cavity and are well provided with vascular organs.

The respiratory organs of insects are segmentally arranged air-conducting tubules, the trachea, which connect with the exterior by means of segmental openings, the stigmata. These openings are often guarded by bristles or tufts to keep out foreign particles. Internally the tracheal tubes branch and subdivide again and again and penetrate all through the tissues of the body. The trachea are lined by chitinous spirals to keep the tubes open. This chitin is continuous with the chitin of the exoskeleton and is shed with the latter.

In Amphioxus more than the first half of the length of the alimentary tract is devoted to the purposes of respiration, since its walls are provided with gill-slits. This may be called the respiratory part of the alimentary tract (prosenteron) in contradistinction to the remainder, hinder portion, the digestive part. Gill-slits to the number of 100, more or less, are borne by it. The variability in number is due to the fact that gills continue to increase in number as the animal grows older, new ones being formed posteriorly. In Ammocoetes, of the Cyclostomi, there is a muscular fold at the posterior end of the branchial part of the œsophagus. In Petromyzon that part of the œsophagus which contains the gills is entirely cut off from the alimentary tract and the cut-off end of the latter grows forward above the gill-portion to join the mouth cavity. Thus two canals pass backward from the mouth. From Elasmobranchii onward the gills are in close relation with the skeletal parts of the visceral arches. As a rule teleosts possess four gill-arches, but certain rudimentary gills on the mandibular and hyoid arches indicate that fishes formerly possessed more gill-arches than at present. Fishes take in water through the mouth, and by a constriction of the latter force it out through the gill-slits. During the process of breathing the gill-arches rise and fall. The Dipnoi, as the name indicates, breathe both by gills and by lungs. The lung-sac of the Dipnoi is an unpaired bilobed sac.

LUNGS. The air-bladder and lungs have a similar development and the latter has developed from the former. Both are outgrowths of the alimentary tract; the air-bladder is usually formed on the dorsal, and the lung on the ventral side, however. The point at which the air-bladder arises from the œsophagus is not a fixed one, and the duct which connects the bladder with the œsophagus may remain open, may be reduced to a solid strand, or may eventually disappear altogether. In the last case the air-bladder probably gets its contained gas from its own wall. The air-bladder always lies above the alimentary tract. In a few cases it is paired. It may be transversely constricted to form several divisions, or caecal processes may be present. The internal surface of the air-bladder of fishes may be spongy, a condition similar to that of the lungs of Dipnoi and Amphibia. The lungs of some of the Dipnoi show posteriorly a paired condition, although anteriorly there is only one part. The lungs of certain Amphibia (*Menobranchus* and *Proteus*) are lower in development than those of the Dipnoi in so far as their internal surface is smooth. In reptiles and in the other vertebrates the form of the lung is determined by that of the body.

The lungs show a branched system of bronchi. In this respect the lungs of crocodiles and some other forms show a decided advance over those of Amphibia. The lungs of birds (q.v.) are in connection with large sacs, the 'air-sacs.' These air-sacs fill the interstices in the body cavity, pass between the muscles, under the skin, and even into the hollow bones.

In man the lungs of the two sides are not symmetrical; the right lung has three lobes, the left two. They are connected with the exterior by the air passages composed of the bronchial tubes, trachea, larynx, and windpipe. This system of organs arises on the ventral side of the œsophagus as a duct, and constricts off to form a distinct tube. The separation begins anteriorly. The lungs arise as lateral buds at the posterior end of the furrow. Cartilaginous supports first arise in Urodeles. Definite tracheæ appear in Sirenia, Amphiuma, and Gymnophiona. The cartilaginous bands take on the form of half rings first in the Gymnophiona. A differentiated larynx appears in the Anura, is regulated by muscles, and has vocal cords. The larynx of reptiles makes no advance over that of Anura, but in crocodiles and turtles the larynx is imbedded in a depression of the hyoid. The thyroid cartilage of mammals is supposed to have been derived from a part of the hyoid. In birds two larynges are present, the lower of which, the syrinx, is the functional voice organ and is restricted to birds alone.

Consult: Lang, *Text-Book of Comparative Anatomy* (London, 1891-96); Weidersheim, adapted by W. N. Parker, *Comparative Anatomy of Vertebrates* (London, 1897).

RESPONDENT (from Lat. *respondere*, to answer, from *re-*, back again, anew + *spondere*, to promise). A party who is called upon to answer in proceedings against him in certain courts. A person who is sued in an admiralty court, or in a court of chancery or equity, is known as the respondent. In this sense the term corresponds to the word defendant. The term is also applied to one who opposes an appeal, and in that sense it is the opposite of appellant (q.v.). In the English divorce courts the defendant is known as the respondent. See **APPEAL**.

RESPONDENTIA (Neo-Lat., from Lat. *respondere*, to answer). A term employed in maritime law to denote a loan of money on the whole or a part of the cargo of a ship, and conditioned to be paid with 'maritime interest' when the cargo is safely delivered at the port to which it is consigned. A respondentia bond is commonly given as evidence of the contract. The lender of the money assumes the risk that the goods may be lost at sea, and if such casualty occurs he loses the amount he has advanced. If there is a partial loss the lender is entitled to have the goods which are saved sold for his benefit. The loan is practically only on the personal security of the borrower, as the goods may be sold by the latter free from any lien at any time during the voyage or upon their arrival. The advantage which accrues to the lender in consideration of the unusual risk he assumes is that he may contract for practically any rate of interest which the borrower is willing to pay. See **BOTTOMRY**; **USTRY**. Consult the authorities referred to under **ADMIRALTY LAW**.

RESSEL, rês'sel, JOSEPH (1793-1857). An Austrian inventor, born at Chrudim, Bohemia, and educated at Vienna and at Mariabrunn. In the latter place he studied forestry, and from 1817 until his death he held various posts in the Austrian Department of Forestry, being stationed for some time at Triest. Ressel was an able mechanic and invented several machines. His claims to the discovery of the screw propeller, which he did not patent, owing to an unfortunate accident at the trial trip of the screw steamboat, rival those of Sauvage, Ericsson, Smith, and Wilson. Consult Reitlinger, *Joseph Ressel* (Vienna, 1863).

REST (AS. *rest*, *ræst*, Goth., OHG. *rasa*, Ger. *Rast*, rest; ultimately connected with Skt. *ram*, to rest, to rejoice). In music, an interval of silence occurring in the course of a movement between one sound and another. With the use of mensurable music (q.v.), rests began to be represented by regular fixed signs, and finally the following values were one after another decided on:

1	2	3	4	5	6	7	8	9
Pausa maxima.	Pausa longa perfecta.	Pausa longa imperfecta.	Pausa.	Semipausa.	Suspitium.	Semispitium.	Pausa. Fassa.	Pausa. Semifassa.

Ultimately the tails of the shorter notes were reversed and thus our present rest characters came into use. The following are the principal rest characters:

					Thirty-second.
Whole.	Half.	Quarter.	Elighth.	Sixteenth.	second.

For rests of a number of bars, it is now usual to draw one or two oblique lines across the staff, and write on them in figures the number of measures during which the voice or instrument is to be silent; thus 5 in common time, denotes a rest of 5 whole notes. A rest, like a note, may be prolonged by one or more dots.

REST-CURE. A system of treatment inaugurated about 1870, after the recognition of the success of Prof. Samuel Jackson, by Dr. S. Weir Mitchell (q.v.) of Philadelphia. It is calculated "to renew the vitality of feeble people by a combination of entire rest and excessive feeding made possible by passive exercise obtained through the steady use of massage and electricity." The cases most benefited by such treatment are those of women who are 'nervous,' thin, and anæmic, partial or entire invalids. Seclusion from relatives and friends; absolute rest in bed for six weeks or more; neither reading, writing, nor sewing, and often not raising the hand or turning over in bed without aid; massage of the entire body except the face every day for six weeks; the use of the induction current with slow interruptions over the whole of the body but the face and neck during forty to sixty minutes each day; together with large quantities of milk, cocoa, and malt extract combine to make up the treatment. While rest-cure is especially suitable to the thin, it also benefits cases of 'fat anæmia' and the large majority of neurasthenics. It has also been of great value in indigestion and

alcoholism, and some early cases of tuberculosis. Rest-cure is employed in modified form by many physicians. Consult Mitchell, *Fat and Blood* (Philadelphia, 1877).

REST-HARROW. A popular name for several species of European herbs and sub-shrubs of the natural order Leguminosæ. Common rest-harrow (*Ononis arvensis*) is sometimes abundant in neglected pastures, but is easily controlled by cultivation. Yellow rest-harrow, or goat's rue (*Ononis Natrix*), is sometimes grown for ornament.

RESTIGOUCHE, rēs'té-gōosh'. A river in the northwestern part of New Brunswick, Canada, forming for about 50 miles the boundary between that province and the Province of Quebec (Map: New Brunswick, B 2). It is 200 miles in length, and falls into Chaleurs Bay in the Gulf of Saint Lawrence. For the last 18 miles it is navigable for the largest ships.

RESTITUTION (Lat. *restitutio*, from *restituere*, to restore, from *re-*, back again, anew + *statuere*, to place, from *stare*, to stand). In law, return to the rightful owner of property which has been unlawfully detained. The term is applied alike to cases where the property has merely been converted to the use of some one under a claim of title, and where it has been stolen. In the United States, where there is doubt as to the identity of the property, the issue should be decided by a replevin action. (See REPLEVIN; EXECUTION.) The term is also applied to the restoration of a part of a cargo which has been lost by jettison. See MARITIME LAW.

RESTORATION (Lat. *restauratio*, from *restaurare*, to restore, from *re-*, back again, anew + **staurus*, Gk. *σταυρός*, firmly fixed, stake; connected with *stare*, to stand, Skt. *sthāvara*, fixed, *sthā*, to stand). A term employed in the history of England and France in connection with the reestablishment of monarchical government. In England it is applied to the accession of Charles II. In France the term is applied to the accession of Louis XVIII. in 1814, after the abdication of Napoleon (First Restoration), and after the 'Hundred Days' in 1815 (Second Restoration).

RESTORATIONISTS. A sect which, under a new name, has revived a very ancient doctrine, which has found advocates at all times since the days of Origen (q.v.). One of the most remarkable doctrines of that Father was his belief of a general *apokatastasis*, or 'restoration' of all things, in which, after a purgation proportioned to the various moral conditions of their souls at the time of death, all men, however wicked, and all the evil angels, even Lucifer himself, would be restored to the favor of God, and reunited to Him in heaven. This doctrine was condemned at the time, and has since been repeatedly rejected by the churches of the East as well as of the West. The doctrine has been renewed in more than one form since the Reformation by various classes, who have taken the name of Universalists (q.v.). The particular title of Restorationists was given in the United States to the followers of the Rev. Hosea Ballou (q.v.), who, in addition to the tenet above explained, held that all retribution is confined to this life, and taught that at the resurrection all men will be admitted to everlasting happiness.

RESTORATION OF PAINTINGS. To restore a painting to its original condition is a delicate operation, requiring great knowledge and skill. By the operation of ignorant restorers of the past many of the most important paintings have been destroyed; indeed, it is a question whether restorers have not inflicted more damage than time itself. In former times the process was chiefly one of repainting and it was then that the chief damage was done, even though the artist himself was often a man of ability. One of the most difficult tasks of the modern restorer is to remove these outer coatings of paint.

The first step in the process of restoration is to clean the picture—i.e. to remove the coating of dust with which it has become encrusted, or the varnish originally applied, which in the course of time becomes dust color or opaque. The usual process is to dissolve the varnish by means of brandy, weak alcohol, or some similar substance applied with the sponge, oil also being frequently applied to prevent deleterious action upon the colors. In Germany the process invented by the celebrated Bavarian chemist Max von Pettenkofer (q.v.) is often applied, which consists in subjecting the painting to cold fumes of alcohol. Unvarnished paintings are in like manner carefully washed with brandy, vinegar, or some similar substance.

The transferring of a painting from a damaged canvas, panel, or wall is effected by gluing it to a paper plaque fastened on gauze. The canvas or wood is then carefully removed by means of instruments and chemicals, and the painting is glued to a new canvas, after which the paper is removed from the surface of the painting. In case of a fresco the paper is rolled upon a cylinder while the plaster is being removed with a chisel. The retouching of the parts of the painting damaged during the restoration with dry color is an important process, which should be intrusted to most skillful hands. The glass plates now used instead of varnish in most modern galleries, though superior as a protection to the painting, have the disadvantage of preventing the study of the ensemble of the picture by their reflective powers.

RESTRAINT OF TRADE, CONTRACTS IN.

It has always been regarded as contrary to the policy of the common law that one should deprive himself of the right to engage in business or trade, and all contracts entered into for that purpose have with certain limitations been regarded as illegal and consequently null and void. Thus a contract that one would never engage in his business or trade within ten miles of London was deemed valid and enforceable, but a contract not to engage in any particular trade or business in England for five years was considered illegal as against public policy. The later tendency of the English courts is to test the validity of the contract by its reasonableness in view of all the circumstances of the case irrespective of any arbitrary rule as to time and space. The early decisions of the United States followed the early rule of the English courts. Later decisions recognize that the United States constitute practically one country for purposes of trade, and consequently do not hold contracts in restraint of trade invalid when the restraint extends over an entire State, or indeed over nearly all of the United States. The Sherman Act of 1887, which

is applicable, however, only to persons and corporations engaged in interstate commerce, forbids pools or combinations for the division of traffic. The modern tendency in the United States is, as in England, to make the test of reasonableness of the restraint depend on the character of the business and the special circumstances of the case. Contracts for the purpose of creating so-called corners in the market of any commodity of general or necessary use have always been held void as unlawfully restraining trade, and contracts unreasonably in restraint of commerce are deemed void on the same principle. See *TRUSTS*.

Congress, acting under the constitutional power to regulate commerce, has passed an act known as the Sherman Act (26 U. S. Statutes at Large, 209) declaring that all contracts and combinations in restraint of interstate or international commerce are illegal and void. In construing these statutes the United States Supreme Court has held that all contracts directly restraining commerce, interstate or international, whether such restraint be reasonable or unreasonable, are illegal, thus changing the common-law rule, that the restraint must be unreasonable in order to invalidate the contract. See *CONSPIRACY; COMBINATION; COMMERCE; MONOPOLY; STRIKE; TRUSTS*.

Consult the authorities referred to under *CONTRACT*; and Jolly, *Contracts in Restraint of Trade* (2d ed., London, 1900); Matthews, *Covenants in Restraint of Trade* (London, 1893); Shelling, *Trusts and Monopolies* (Boston, 1893); Stickney, *State Control of Trade and Commerce* (1897).

RESTREPO, rã-strã'pó, JOSÉ MANUEL (c.1775-c.1860). A South American historian and politician, born in New Granada (Colombia). He wrote *Historia de la revolución de la república de Colombia* (1827), which includes an appendix containing several original documents. As he took a personal part in the events described, the work has an especial value, and it is written in a judicious and impartial style. Restrepo was Secretary of State under Bolívar.

RESTRICTIVE COVENANTS. Covenants in conveyances which bind the purchaser to use the land conveyed thereby in some particular way, or which prohibit him from making use of it for certain designated purposes. Common examples of such covenants are: the restrictive clauses in deeds prohibiting purchasers from building beyond an imaginary 'house line' on the land, that is, within a certain distance from the street; or prescribing the character of the buildings which they shall be permitted to erect thereon. Restrictive covenants create equitable easements in favor of the owner of the land for the benefit of which they are made; and "run with the land," that is, continue to operate in favor of all subsequent owners of that land. It is by restrictive covenants that the character of the improvements on real estate in suburban towns and additions is fixed. The class of people, the character and minimum cost price of buildings, and the purposes for which they may be used, may thus be regulated. Consult Washburn *On Real Property*, and *On Easements*; Jones *on Easements*.

RESURRECTION (Lat. *resurrectio*, from *resurgere*, to rise again, from *re-*, back again, anew + *surgere*, *surrigere*, *subrigere*, to rise, from *sub*, under + *regere*, to direct, rule). The

restoration of man after death to the full possession of his powers and faculties. In one form or another, this conception is found among Mazdayasnians, Jews, Christians, and Mohammedans. As to the time, manner, and subjects of the future change there has been much difference of opinion. While the prevailing view has generally been that the dead will rise simultaneously on the last day, there are great religious teachers who have regarded the resurrection as taking place in the case of each person immediately upon death. The resurrection has been conceived of as an awakening from the sleep of death; a reanimation of the body; a restoration of the body by the coming together of the particles that constituted it at the moment of death; a creation of a new body in harmony with the perfected spiritual character; a clothing of the departed spirit with a spiritual body descending from heaven; or a development of the germ of a spiritual organism already existing within the physical body before death. Some have maintained that all men, regardless of nationality, religious belief, or character, will be raised from the dead, while others have held that only members of a particular nation, the adherents of a certain form of religion, or the possessors of a good character will be deemed worthy to share in the resurrection.

Whether the idea of a resurrection originated with Zarathushtra, already existed before his time in Iran, or was developed by his disciples cannot be determined with certainty. In its most concrete form it is met in the later parts of the Avesta (q.v.) and in the Bundahish. Here all men are to be raised on the last day by the Saoshyant (q.v.), or Saviour, and those who are living at that time are to be endowed with immortality, the bodies of the dead being brought together from the different elements in the course of fifty-seven years. It is on the whole most probable that there existed a popular belief in a future resurrection already before the time of Zarathushtra. The custom of leaving the dead in the field to be consumed by wild beasts, without building for them a house, goes back to extreme antiquity. While such a practice might seem to preclude ancestral cult and the hope for immortality, the unimpeded return of the body to the different elements of nature apparently made the worship of ancestral spirits less a matter of ceremony, and in connection with the idea of a coming destruction and renovation of the world, led the Iranian mind to expect a reconstruction of each human being from its constituent parts scattered among the elements. That this occurred at a very early period is rendered probable by the emphasis put upon the future life by such Iranian peoples as the Scythians and the Thracians, who must have left the common home at a remote epoch. We have positive evidence that this doctrine was taught in the Achaemenian period in a work of Theopompus, the historian of Philip of Macedon, used and quoted by Diogenes Laertius, Æneas of Gaza, and probably Plutarch. Herodotus and Xenophon probably also heard of it, though they emphasized only the belief in immortality on the part of the Persians.

In early Hebrew thought there is no trace of this conception. It is unknown alike to prophets, legislators, and poets. The third chapter of Genesis no doubt reflects the attitude of large

circles in Israel; if man had been allowed to remain in the Garden of Eden he might have continued his existence indefinitely by the magic virtue of the life-giving fruit; but as he was driven out of the garden, he returns to dust and is no more. Nevertheless, the survival of ancestral worship and necromancy shows that to many minds there were exceptional personalities rising above the average lot of the shades in Sheol (q.v.), still possessing high rank, power over the living, and supernatural insight. The valley of bones in Ezekiel xxxvii. does not suggest, but rather precludes, familiarity with the doctrine of a resurrection. In Job xix. 25-27 the text has evidently suffered much in transmission, but the whole trend of the thought clearly shows that there can be no reference to either a life beyond or a resurrection. The possibility of such a return to life is emphatically denied in chapter xiv. The first reference in Hebrew literature to the resurrection is found in the Book of Daniel, written in B.C. 165. According to Daniel xii. 2, some of those that sleep in the dust are to be raised. Evidently the Maccabean martyrs and the apostates are intended. An apocalypse written c. 110 B.C. and preserved in Isaiah xxvi. declares that Yahweh's dead shall live and his dead bodies shall arise, for his dew is a dew of healing and the earth shall cast forth the dead. Whether all Israelites are meant is uncertain. Within the canonical Old Testament these are the only passages that show an acquaintance with the doctrine. How long before the year B.C. 165 it became known in Israel we have no means of determining. In the earliest part of the Book of Enoch, written c. 108 B.C., there is an allusion to some who are neither slain on the judgment day nor raised from the place of torture (xxii. 13). The resurrection is apparently limited to righteous Israelites. This is clearly the conception in Enoch xci. 10; xcii. 3-5, written c. 88 B.C.; in the Psalter of Solomon iii. 12, xiii. 11, xiv. 9, xv. 13, written c. 60 B.C.; in II. Maccabees vii. 9, 14, 23, 29, 36, xii. 43, 44, written c. 20 A.D.; and in the Testaments of the Twelve Patriarchs, Jude xxv., and probably originally in Benjamin x. A number of apocalyptic works written apparently in the reign of Domitian seem to contemplate a universal resurrection. This is most clearly the case with IV. Ezra vii. 32; probably also with Baruch xlii. 7, l. 2, li. 1 (though in xxx. the resurrection is limited to the just), and with Enoch li. In the Apocalypse of Moses, which in reality is a life of Adam and Eve, the resurrection of the whole human race is clearly taught (x., xiii., xxviii., xli., xliii.), the addition "all that are a holy people" in xliii. being probably an interpolation; also in Sibylline Oracles ii. 214-237, written c. 200 A.D. The prevailing view, however, in the Talmudic and Midrashic period was that the heathen would not rise from the dead, but that the resurrection would be only for the righteous. Whether this would include all Israelites was a mooted question, the opinion being frequently expressed that some classes would be excluded. Thus the Mishna tract *Sanhedrin* xi. 1 excludes from the world to come those who deny the resurrection of the dead and the divine origin of the law as well as the Epicureans, while it records the opinions of Rabbi Akibah, who excluded also those reading non-canonical books, and of Abba Shaul, who added any person pronouncing properly the name of Yahweh (see JEROVAH), and *Kethub-*

hoth 111 b distinctly states that "the people of the land [i.e. the unlearned] shall not be raised to life." Before the third century A.D. the resurrection is always a work of God Himself. But Rabbi Samuel taught in the name of Rabbi Jonathan that the righteous would raise the dead (*Pesachim*, 68). Later it was held by many teachers that the Messiah would raise the dead. The general opinion was that resurrection would occur in Palestine. Even the Jews who had died outside of the holy land were supposed to be led through subterranean passages to Palestine, where they were to be raised (*Pesikta rabbath i.*). Many supposed that of the human body one bone would never molder into dust, and that from this 'almond of the spine,' or *os sacrum*, the resurrection body would be formed (*Bereshith rabba* xxviii.).

There probably never was a time when the belief in a resurrection was universally held in Israel. While it was championed in one form or another by the Pharisaic party, it was strongly opposed in many circles. It is not known or accepted by the authors of Ecclesiasticus, Judith, Tobit, and I. Maccabees, and it is of course emphatically denied by Ecclesiastes. The Sadducees adhered to the old idea of Sheol and rejected the doctrine of a resurrection. The Samaritans seem to have maintained the same attitude in earlier times, though they subsequently accepted the doctrine. (See SAMARITANS.) The Essenes cherished a view concerning the nature of the soul and the future life closely resembling that of the Pythagoreans, ultimately due to Indian or Persian influences, according to which the soul has existed before birth and will exist eternally after its bondage to the body is ended. A similar view was held by Jewish Gnostics. Where Greek thought prevailed the idea of immortality (q.v.) was accepted rather than that of a resurrection. This may be seen not only in the Wisdom of Solomon iii. 1-9, iv. 7, v. 16, vi. 20; IV. Maccabees xvii. 5, 18, xviii. 3; and Philo, *De vita Mosis* ii. 633, *De Abr.* 385; *De Somn.* 586; *De migratione* 407, but also in Palestinian works like Jubilees xxiii., xxv., and Slavonic Enoch lxx. 8, 9, 10, lxxvi. 7. Even where the term was kept, the idea of a resuscitation of the physical body was abandoned, as by Josephus (cf. especially *Bel. Jud.* iii. 8, 5) for the thought of an endowment with a spiritual organism. As a result of contact with Arabic learning, there was an unmistakable tendency to substitute the doctrine of a natural immortality of the soul for that of a resurrection of Israel only. It was not wrongly that Maimonides was accused of having set aside completely the doctrine of a resurrection in his *Mora Nebuchin* or "Guide of the Erring." Modern Judaism has been largely determined in this as in other respects by Moses Mendelssohn, whose work, *Phädon oder über die Unsterblichkeit der Seele* (1767), made a profound impression on his age.

The attitude of Jesus on this question cannot be determined with certainty. Aside from Luke xiv. 14, which, if genuine, shows that Jesus looked forward to a recompense at the resurrection of the just, there is but one saying of His recorded in the Synoptic Gospels that has any direct relation to the subject. This is found variously reported in Matthew xxii. 23-32, Mark xii. 18-27, and Luke xx. 27-38. Jesus evidently rejects the view of the Sadducees on the ground

that they do not understand the Scriptures and fail to appreciate the power of God. On the other hand, He clearly does not accept the current Pharisaic doctrine of a resurrection on the last day, since He based His argument for the fact that the dead are raised on the words of Yahweh to Moses in which He speaks of Himself as the God of Abraham, Isaac, and Jacob. The point of the argument is that, according to the Scriptures, these patriarchs were addressed as living several centuries after their death, and therefore must have been raised from the dead; and the natural inference is that Jesus believed in a spiritual resurrection by which those to whom God stands in relation as their God are immediately after death raised into life to be in His presence forever. Concerning those who shall be accounted worthy to share in the resurrection, He further stated His conviction that they would neither marry nor be given in marriage, but be like the angels. His warning, "Fear ye him who is able after he has killed to slay both body and soul in Gehenna," also seems to indicate that He limited the resurrection to those who should be accounted worthy. See GEHENNA; HELL.

A new assurance of a resurrection to a blessed life beyond was given to those who became convinced that Jesus had been raised from the dead. Unless it can be proved that certain of the older Epistles ascribed to Paul are not genuine, there is positive evidence that not much more than twenty years after the death of Jesus a glorious figure appeared in a vision to Paul and was identified by him as the crucified Nazarene and that Paul had heard of similar visions seen by Peter, James, and others (I. Cor. xv. 4-8). This conviction revolutionized Paul's life and caused him to see in the resurrection of Jesus the guarantee of an eternal life and the sole reason for righteous conduct in this life. While the important passage in I. Corinthians xv. contains no intimation of an empty tomb, and cannot be pressed as proving a physical resurrection or an appearance to women, the earliest Gospels, Matthew and Mark, written in the main before the end of the first century, suggest that Jesus first appeared to His disciples in Galilee, and that some women had found the tomb empty, but said nothing about this because of fear. The later Gospels, Luke and John, make Jerusalem the place of the first appearance of Jesus to His disciples and strongly emphasize the physical character of the resurrection body while ascribing to it functions impossible to a physical body.

In the conflict with Gnosticism, which denied the resurrection, the Church found it necessary to give added emphasis to the resurrection of the flesh. Hence the earlier creeds, which simply affirmed a belief in a resurrection or an eternal life, were gradually changed into the formula 'the resurrection of the flesh' found in the Apostles' Creed. Since the thought of a resurrection of the wicked as well as the good sporadically occurs in the New Testament (as in John v. 28, Acts xxiv. 15, Heb. vi. 2, Rev. xx. 13), the idea of an interval between a first resurrection of believers and a second resurrection of the rest of mankind developed, and was especially cherished by those who looked forward to a thousand-year period of Messianic rule. See MILLENNIUM.

Through the influence of Greek philosophy the doctrine of the natural immortality of the human soul (see IMMORTALITY) became so important a

part of Christian thought that the resurrection naturally lost its vital significance, and it has practically held no place in the great systems of philosophy elaborated by Christian thinkers in modern times.

The doctrine of the resurrection was adopted by Mohammed from Jewish or Christian sources and adhered to both by Sunnites and Shiites. It was subjected to grave doubts by Moslem thinkers in the times of the Bagdad caliphate, but is to-day generally accepted.

BIBLIOGRAPHY. Süderblom, *La vie future dans le Mazdéisme* (Paris, 1901); Stave, *Ueber den Einfluss des Parsismus auf das Judentum* (Haarlem, 1898); Tiele, *Geschiedenis van den godsdienst in de oudheid* (Amsterdam, 1895-1901); Böcklen, *Die Verwandtschaft der jüdisch-christlichen mit der parsischen Eschatologie* (Göttingen, 1902); Bertholdt, *De Christologia Judæorum* (Erlangen, 1811); Böttcher, *De Inferis Rebusque Post Mortem Futuris ex Hebræorum et Græcorum Opinioniibus* (Dresden, 1846); Schultz, *Alttestamentliche Theologie* (Göttingen, 1869); id., in *Jahrbücher für deutsche Theologie* (Gotha, 1867); Dillmann, *Handbuch der alttestamentlichen Theologie* (Leipzig, 1895); Smend, *Lehrbuch der alttestamentlichen Religionsgeschichte* (2d ed., Freiburg, 1899); Stähelin, in *Jahrbücher für deutsche Theologie* (Gotha, 1874); Drummond, *The Jewish Messiah* (London, 1877); Stanton, *The Jewish and Christian Messiah* (Edinburgh, 1886); Charles, *A Critical History of the Doctrine of a Future Life* (London, 1901); Wünsche, in *Jahrbücher für protestantische Theologie* (Leipzig, 1888); Castelli, in *Jewish Quarterly Review* (London, 1889); Atzberger, *Die christliche Eschatologie* (Munich, 1890); Schwally, *Das Leben nach dem Tode* (Giessen, 1892); Tausch, in *Jahrbücher für protestantische Theologie* (Brunswick, 1891); Stade, *Geschichte des Volkes Israel* (2d ed., Berlin, 1889); Schürer, *Geschichte des jüdischen Volkes*, vol. ii. (3d ed., Leipzig, 1898); Zeller, in *Theologische Jahrbücher* (Tübingen, 1847); Gfrörer, *Philo und die alexandrinische Theosophie* (Stuttgart, 1831); Grätz, *Geschichte der Juden* (3d ed., Leipzig, 1896); Holtzmann, *Lehrbuch der neutestamentlichen Theologie* (Freiburg, 1897); Strauss, *Leben Jesu* (Bonn, 1835); Keim, *Geschichte Jesu von Nazara* (Zurich, 1867); Borndt, *Evangelische Geschichte* (Leipzig, 1893); Reville, *Jésus de Nazareth* (Paris, 1897); N. Schmidt, *The Son of Man and the Son of God in Modern Theology* (New York, 1903); Bousset, *Die Religion des Judentums* (Berlin, 1903); Harnack, *Das apostolische Glaubensbekenntniss* (Berlin, 1892); id., *Dogmengeschichte* (Berlin, 1898); Barnard, article "Resurrection," in the *Hastings Bible Dictionary* (New York, 1902).

RESURRECTION. A sombre and powerful novel by Tolstoy (1899), treating of the problems of Russian life of to-day, and arraiging especially the Russian judicial prison system. The theme is the repentance of a nobleman who as a jurymen is called on to try a girl whom he had previously ruined. Impressed with the injustice of their relative conditions, he gives up his life to atonement with the result that both he and his victim are regenerated.

RESURRECTION PLANT. See ROSE OF JERICHO.

RESUSCITATION (Lat. *resuscitatio*, from *resuscitare*, to raise again, revive, from *re-*, back again, anew + *suscitare*, to raise, from *sus-*, up, under + *citare*, to call, rouse). The revival of the apparently dead. The apparently dead to whom efforts to restore are of use are those asphyxiated by drowning, by breathing illuminating gas, or by suffocation, and those suffering from syncope or the effects of electricity. In syncope, or fainting, the head and heart should be placed on a low level, while the lower extremities are elevated. If this manipulation is not rapidly successful, respiration may be excited by sprinkling the face suddenly with water and applying to the nostrils some pungent volatile substance such as spirits of camphor or weak ammonia. Victims of electric shock may sometimes be resuscitated by the use of artificial respiration by means of Gibbons's instrument. This consists of two bellows so arranged that one pumps air into the lungs through a nostril while the other exhausts the lungs of respired air. In the case of asphyxiation from inhaling either illuminating gas or carbonic dioxide, artificial respiration should be employed together with administration of oxygen through the nostril. Apparently drowned persons may often be resuscitated by syphoning the water out of the stomach and then using artificial respiration and keeping the body warm by means of artificial heat. See HALL, MARSHALL; RESPIRATION, ARTIFICIAL.

RESZKE, řěsh'ke, EDOUARD DE (1856—). A Polish opera singer, brother of Jean de Reszke, born at Warsaw. After studying with his brother, he received instruction from Ciaffei, Steller, Coletti, and Sbriglia. Originally he had studied scientific farming in Silesia, and had devoted himself to the care of the family estates. It was at the suggestion of Jean, then in the first flush of his success, that he took up the study of music. He made his first public appearance in 1876 at the Italiens in Paris, as the King in Verdi's *Aida*, which was so successful that Massenet intrusted to him the creation of *Le roi de Lahore* at La Scala in Milan. From 1880 to 1884 he sang with the Royal Italian Opera Company in London, where he became famous as one of the greatest dramatic basses of his time.

RESZKE, JEAN DE (1853—). A Polish dramatic tenor, born at Warsaw. Through the influence of his father, a prominent State official, and his mother, who was possessed of remarkable musical talent, he saw much of the world's great artists, the family salon possessing an attraction for the most celebrated musicians of the day. When but twelve years of age, De Reszke was singing in the Cathedral, where the quality of his voice aroused the interest of the city. Afterwards he took up the profession of law, and obtained his degree and license. But the attraction of music proved too strong, and he began to study for the stage under Ciaffei and Cotogni. In 1874 he made his debut at Venice, as Alfonso in *La Favorita*, under the name of De Reschi. Soon afterwards he appeared in London in the same rôle, where the critics complained that his voice lacked the deep quality and resonance of a barytone. He attained considerable celebrity, however, but his physical strength began to suffer from the wear and tear

of singing parts too low for him, and acting upon the advice of Sbriglia, he retired from the stage, and prepared himself in a tenor repertoire. On the completion of two years of study he made his second debut before the public, in 1879, this time in the tenor rôle of *Robert le Diable*, at Madrid. His success was instantaneous, and his career a continuous artistic triumph. His repertoire includes *Faust*, *Lohengrin*, *L'Africaine*, *Aida*, *Le Cid* (written for him by Massenet), *Les Huguenots*, *Elaine*, *Romeo and Juliet*, and *Tristan*. He is conceded to be one of the most artistic singers and actors known to the operatic stage. Since 1891 both De Reszkes have, with short interruptions, been favorite members of the Metropolitan Opera House Company in New York.

RETAINER (from Lat. *retinere*, to retain, hold back, from *re-*, back again, anew + *tenere*, to hold). The employment of an attorney, counselor, or other legal practitioner, to prosecute or defend an action, or represent a person, in his professional capacity. It is not necessary that a retainer be in writing; a mere verbal request is sufficient. Upon being retained an attorney has full powers incidental to professional representation. The term is also applied to a fee paid to a legal practitioner for his services, usually in advance, and constituting only a part of his whole fee. See ATTORNEY; COUNSELOR.

The act of an executor, to whom the estate is in debt, in retaining in his hands a sufficient amount to satisfy his claim, is also technically known as retainer.

RETAINER. See LIVERY.

RETAINING WALLS. Walls built to retain earth or other incoherent substances in positions and forms which, without such artificial aid, they could not maintain. Most earths, if left to themselves, will not stand with vertical sides, but will fall or slide down until they assume a certain slope. The angle which this slope makes with the horizontal is called the 'angle of repose,' and it varies according to the nature of

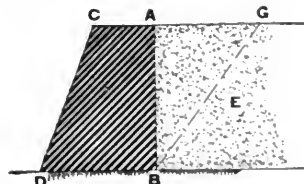

DIAGRAM OF RETAINING WALL.

the material, the amount of water it contains, etc. The same earth will have different angles of repose under different conditions. In the accompanying figure, E represents a section of a mass of earth which it is desired to retain by the wall ABDC. If the line BG represent the angle of repose, then it is evident that the duty of the retaining wall is to keep in position the wedge-shaped mass of earth ABG. This mass tends to destroy the retaining wall, (1) by overturning it by rotation along the front edge D; (2) by the crushing of the stone along the front edge; and (3) by sliding the wall forward on its base, DB, or along some horizontal plane above the base. In designing a retaining wall the engineer seeks to fix its dimensions so that it is safe against destruction by any or all of these

destructive tendencies. The difficulty of doing this arises from the fact that the pressures exerted by the wedge-shaped mass of earth vary so greatly with the character and physical condition of the material that they can only be roughly approximated. Engineers have worked out numerous formulas for calculating the dimensions of retaining walls, which are designed to meet the varying conditions of the load, but these formulas have to be based on so many hypotheses that their practical value, except for general indications, is quite limited. The greatest difficulty arises from the action of water, which accumulates behind the wall and may transform the earth to a semi-fluid state, thus enormously increasing its pressure, and one of the chief desiderata in retaining-wall construction is that this water shall be kept drained away. This is usually accomplished by having drainage holes, commonly called 'weep holes,' through the wall at intervals, by means of which the water runs off as fast as it accumulates.

Retaining walls are generally made trapezoidal in section, as shown by the diagram, but they are also built with rectangular sections and with concave faces. Danger from crushing seldom exists except in very high walls, and danger from shifting can be easily avoided by laying the masonry with its courses dipping slightly from the front toward the rear. Careful workmanship and perfect drainage are the essentials of good retaining-wall construction.

BIBLIOGRAPHY. For a discussion of the theory of retaining-wall construction for various forms of walls and various conditions of loading, consult: Howe, *Retaining Walls for Earth* (New York, 1896); Merriman, *Retaining Walls and Masonry Dams* (New York, 1892); Cain, *Practical Designing of Retaining Walls* (New York, 1888); and Baker, *Treatise on Masonry Construction* (New York, 1900). See MASONRY.

RETALIATION (from Lat. *retaliare*, to retaliate, from *re-*, back again, anew + *talis*, such). Properly, the return of like for like; usually, the infliction upon a wrong-doer of an evil similar to that which he has wrought. In early law, when wrongs are redressed by the act of the injured party or kinship group, such redress often takes the form of retaliation. The retaliatory idea sometimes assumes peculiar forms; as when the man whose father has been slain seeks to slay in return not the offender himself, but the offender's father. The clearest expression of the *lex talionis*, or law of retaliation, is found in the Jewish rules, "An eye for an eye and a tooth for a tooth," and "Whoso sheddeth man's blood, by man's hand shall his blood be shed." In the Roman XII. Tables *talis* is authorized as a penalty for mayhem (*membrum ruptum*) if the injured party refuses to accept pecuniary compensation. Retaliation is sanctioned in the Visigothic laws, but this (according to Brunner, who asserts that there is practically no retaliatory element in old German law) was due to the influence of the Old Testament. A modern parallel was afforded in colonial Connecticut, where the penalty of castration was imposed in at least one instance on the authority of the Mosaic rule.

When public punishment begins to take the place of private vengeance, penalty may be, and often is, measured according to the degree of

wrath which the offense commonly arouses, but purely retaliatory penalties tend to disappear. To punish a perjurer by hewing off the hand which he has raised in swearing, or a slanderer by cutting out the tongue, is not properly retaliation. Such penalties may originate in a sort of personification of the offending member, or they may be based, as Brunner suggests, on the desire to make the relation of crime and punishment obvious: "the penalty itself is to declare why it is imposed." Retaliation may be based, in part, on this idea, but such symbolic penalties are not in themselves retaliatory. More closely akin to retaliation is the infliction upon a false accuser of the penalty which would have been inflicted on the accused if the charge had been sustained.

The term retaliation is sometimes loosely employed to describe the return of evil for evil even when there is no similarity between the offense and the punishment. In this broad sense, retaliation includes all extra-legal vengeance and all legal punishment. It is in this sense that we speak of 'the retaliatory theory' of punishment, meaning the theory which bases the right of the community to punish criminals on the fact that they have injured the community by their crimes.

RETBERG, rət'bĕrk, RALF VON (1812-85). A German writer on art, born at Lisbon, where his father was then stationed as a captain in the German-English Legion. From 1829 to 1845 Retberg served as an officer in the Hanover Army, and then settled in Munich. His works are of especial value for the knowledge of art and culture at Nuremberg, and include: *Nürnbergers Briefe zur Geschichte der Kunst* (1846); *Nürnbergers Kunstleben in seinen Denkmälern* (1854); *Kulturgeschichtliche Briefe* (1865); *Albrecht Dürers Kupferstiche und Holzschnitte, kritisches Verzeichnis* (1871). Posthumously, *Die Geschichte der deutschen Wappenbilder* (Vienna, 1888) was published from his manuscripts.

RETENTION (Lat. *retentio*, from *retinere*, to retain, hold back), or CONSERVATION. In psychology, the effect which is left upon the organism by psychophysical processes. One is said to retain one's experiences and to 'live them over' again and again. Retention is, therefore, the presupposition of memory. In Hertzian psychology (see HERBERT) ideas are supposed to maintain their existence even after they have left consciousness. But most recent writers on psychology regard retention as a physical function. It is, they assert, the brain that 'retains.' This view is based partially on the observation of pathological cases, which reveals the fact that both general and specific disturbances of memory are connected with definite changes either in the cortex as a whole or in some limited area of it. (See APHASIA.) These pathological facts have told us something of the 'seat' of retention. Lesions in one region of the cortex affect retention of visual sensations and ideas; lesions in another region, that of auditory sensations and ideas. There is, however, still much doubt as to the extent of the differentiation of cerebral functions. Concerning the actual physiological changes which are left over from excitation there is also some difference of opinion. Most psychologists agree, however, that the activity which a stimulus produces ceases with the passing of the stimulation, but that some kind of modification remains.

Wundt maintains that the exercise of nervous elements leaves a tendency toward repetition of the same function whenever the same elements are reëxcited.

The conditions under which retention takes place are both general and special. The general conditions are health, plasticity of the nervous system (retention is much easier in childhood and youth than in old age), mental disposition, attention, and the formation of associations. Among special conditions influencing retention stand emotion and mood; vividness, intensity, and duration of the impression; repetition and the concreteness or abstractness of the material composing the experience.

BIBLIOGRAPHY. Wundt, *Physiological Psychology* (Leipzig, 1893); Kuelpe, *Outlines of Psychology* (New York, 1895); Ribot, *Diseases of Memory* (ib., 1882); Bain, *Senses and Intellect* (ib., 1888); Maudsley, *Physiology of Mind* (ib., 1883); Ladd, *Elements of Physiological Psychology* (ib., 1892). See MEMORY; MENTAL CONSTITUTION; REPRODUCTION OF IDEAS.

RETENTION OF URINE. A lack of power to evacuate the bladder. This may be either complete or partial. It should be carefully distinguished from *suppression*, in which there is a failure on the part of the kidneys to secrete urine, and consequently the bladder is empty. The causes of retention may be *organic* or *functional*. Among the chief organic causes are: (1) Urethral stricture, (2) injuries resulting in contraction or rupture of the urethra, (3) tumors within the urethra or pressing upon it from without, (4) foreign bodies in the urinary canal, such as small calculi, clotted blood, pieces of bougies, catheters, etc., (5) enlargement of the prostate gland, acute or chronic, especially in aged men, abscesses in the perinaeum, the pressure of a loaded rectum, the head of the child during labor, or pelvic tumors of any kind. The functional causes of retention are spasm of the urethra or the neck of the bladder, partial or complete paralysis of the bladder, and hysteria.

The symptoms of retention consist of an urgent desire to pass water, with partial or entire inability to accomplish the desire; restlessness, discomfort, and even violent pain accompany the straining efforts to evacuate the bladder. On percussion above the brim of the pelvis, the bladder is found to be distended in proportion to the amount of accumulated urine. If relief is not speedily afforded the bladder may give way and discharge its contents into the peritoneal cavity, in which case death soon follows; or the urethra behind the stricture may give way, and the urine be extravasated into the surrounding tissues, provoking severe inflammation and gangrene.

Treatment will depend in its details upon the cause operative in each case. Only general principles can be given here. Spasmodic retention can nearly always be relieved by warm baths, heat to the perinaeum, purgation, sedatives, or in extreme cases by a few whiffs of chloroform. Attempts should be made to draw off the urine through a small catheter. If this measure fails, recourse must be had in a few hours to aspiration of the bladder, through a hollow needle thrust into it through the abdominal wall above the pubes. This measure, however, is rarely

necessary. Paralysis of the bladder may arise from the general weakness of old age, from a depressed state of the nervous system in fevers of the typhoid type, in spinal disease, apoplexy, etc. Retention from paralysis is often accompanied by a dribbling away of the urine, so that it may at first be mistaken for incontinence. In chronic prostatic cases the urine has to be regularly drawn off with the catheter.

RETHEL, rä'tel, ALFRED (1816-59). A German historical painter. He was born near Aix-la-Chapelle, May 15, 1816. His artistic training began at the age of thirteen under Schadow in the Düsseldorf Academy; but, dissatisfied, he repaired in 1836 to Frankfort to work under Philip Veit and Schwind. At Düsseldorf he had earned reputation with episodes from the life of Saint Boniface, one of which (1832) is in the National Gallery in Berlin, and in Frankfort he painted a "Nemesis" (1837); a "Daniel in the Lions' Den" (1838, Städels-Institut); "Guardian Angel of Emperor Maximilian" (fresco, ib.); "Resurrection" (Church of Saint Nicholas); the portraits of Emperors Maximilian I. and II., Charles V., and Philip of Suabia, for the Römer (1838); "Saints Peter and John Healing the Lame" (1840-41, Leipzig Museum); and "Finding of the Body of Gustavus Adolphus" (Stuttgart Museum). In the competition for a cycle of eight frescoes from the life of Charlemagne to adorn the city hall at Aix-la-Chapelle he carried off the first prize, and after a visit to Italy (1844-45), executed (1847-52) four of the subjects, to wit: "Otho III. in the Tomb of Charlemagne"; "Destruction of the Irminsul;" "Defeat of the Saracens at Cordova;" and "Conquest of Pavia in 774." The cartoons for these are in the National Gallery, Berlin, and the cycle was afterwards completed from Rethel's designs by Josef Kehren. This monumental work, imbued with the spirit of grandeur and simplicity, was the greatest achievement of historical painting in Germany during the first half of the nineteenth century. Attacked by a nervous disease, Rethel in vain sought relief in a second visit to Italy in 1852-53, and died insane at Düsseldorf, December 1, 1859. A series of six water colors depicting the "Expedition of Hannibal Crossing the Alps" (1844-45), and his illustrations to the "Danée of Death" (1848, with poetical text by Reinick, 13th ed. 1902), deserve special mention. His brother and pupil, ORTO (1822-92), who also studied under Karl Sohn and Schadow at the Düsseldorf Academy, painted at first Scriptural subjects, such as "Boaz Meeting Ruth" (1855, Leipzig Museum), and afterwards chiefly portraits and genre scenes. For Alfred Rethel's biography, consult: Müller von Königswinter (Leipzig, 1861); Valentin, in *Aesthetische Schriften*, i. (Berlin, 1892); *Art Journal* (London, 1865); and Peeht, *Deutsche Künstler*, ii. (Nördlingen, 1879).

RÉTIF DE LA BRETONNE, rä'téf' de la bre-tôn', NICOLAS EDMÉ (1731-1806). A French novelist, nicknamed by Grimm the "Gutter-Rousseau," born in Sacy. The discovery of his love-letters to another woman than his wife in 1765 led to the first recognition of his literary talent. From the first his fiction was the work of observation and largely of personal experience. Its success was gradual, but steady. *Le pied de Fanchette* (1769) made him known, *Le paysan*

perverti (1775) made him famous and sought by distinguished men. Of his other writings the *Monsieur Nicolas* and the 42 volumes of *Les contemporains* (1780-85) are most noteworthy. The novels are declamatory and rhetorical, but they offer the first serious treatment of the petty bourgeois in fiction. A fair idea of his manner and merits may be obtained from Assezat's selection (3 vols., Paris, 1875).

RETIMO, rā'tē-mō. A seaport town of the island of Crete, on the north coast, 38 miles west of Candia (Map: Greece, F 6). Population, in 1900, 9311.

RETINA. See EYE.

RETINITIS (Neo-Lat., from *retina*, so called because like fine network, from Lat. *rete*, net). Inflammations of the retina are primary or secondary to inflammation of other parts of the eye. Both eyes are usually affected. Sight is impaired, the size or form of objects seems altered, the field of vision is contracted; there is a feeling of discomfort in the eyes and at times dread of light. The ophthalmoscope shows a fundus hazy from swelling, tortuous, and dilated veins, a disk with indistinct margins, sometimes hemorrhages. Recovery may be complete or partial. Atrophy of the retina and the optic disk may result in loss of sight partially or completely. Treatment includes absolute rest of the eyes with protection from light, use of atropine locally, and constitutional treatment of the cause of the retinitis. This depends upon the variety. *Simple retinitis* may result from overuse of the eyes in any way or may be the beginning of other forms. *Albuminuric retinitis*, which occurs during nephritis, is characterized by the presence in the retina, in addition to hemorrhages, of white spots. At the macula lutea these are often arranged in a star-like form. Treatment is that of the kidney disease. *Diabetic retinitis* presents a picture similar to the preceding form, but with the white spots arranged irregularly around the macula, and the treatment is directed to the cause. *Syphilitic retinitis* occurs in the hereditary form and in the secondary stage of acquired syphilis. The fundus is hazy, the disk red and hazy; there are scattered grayish and white spots, often with pigmented borders, especially near the macula, and white marks along the vessels. The course is slow, relapses frequent, and though early and thorough treatment of the constitutional disease gives good results, there is likely to be some permanent diminution of vision. *Hemorrhagic retinitis*, as its name indicates, is characterized by the occurrence of numerous hemorrhages. It occurs in persons with diseases of the arteries and heart, and frequently precedes cerebral hemorrhage. Treatment of the arterial disease is very important. *Leukæmic retinitis* causes pallor of the disk with white and yellow spots, sometimes with a pink border, and hemorrhage areas.

RETINOSPORA. A tree. See CYPRESS.

RETIREMENT (from *retire*, from OF., Fr. *retirer*, to draw back, from *re-*, back + *tirer*, to draw, from ML. *tirare*, to draw). A statutory provision or age limit by which officers in the military or naval services cease from active duties, and are placed on the retired list. In the United States Army the compulsory age

limit is sixty-four, but the President may retire an officer at sixty-two. In the United States Navy the retiring age is sixty-two years. Army regulations provides that when an officer becomes disabled or unfitted for the performance of duty by reason of wounds, sickness, or improper habits, a retiring board will convene and action be taken according to the verdict. Officers on the retired list are permitted to wear the uniform of their actual or highest brevet rank when retired, except that the number or insignia of the regiment, corps, or department will not be worn. Retired officers receive 75 per cent. of pay (salary and increase) of their rank. A limited number may be assigned at their request to duty with full pay to militia or schools as instructors, or in time of war to other duty. In the British Army officers are permitted to retire voluntarily with gratuities or pensions, and are also obliged to retire according to age limit (which varies according to rank held), or after a period of non-employment, on half pay. Regulations similar in effect obtain in all countries.

RETORSION (ML. *retorsio*, *retortio*, a bending or twisting back, from Lat. *retorquere*, to bend or twist back, from *re-*, back again, anew + *torquere*, to twist). A term of international law signifying an act of retaliation by one nation against another. Unlike reprisal (q.v.), it is not a sufficient justification for war, but is rather a political measure intended to compel one nation to accord equality of treatment to the subjects of the other residing within its jurisdiction. Thus, where one nation imposes restrictions upon aliens residing within its territory, as by unequal taxes, or by differential import duties, or fails to observe the rules of international comity, as by refusing to grant the accustomed privileges to ambassadors and other diplomatic agents, the aggrieved nation is justified in applying the same kind of treatment to the offending nation or its subjects. The increasing commercial relations of modern States have greatly extended the field in which the principle of retorsion may be applied, and it is now most frequently resorted to by those nations which depend largely upon tariffs or import duties for their revenue.

RETREAT (OF. *retréte*, *retraicte*, Fr. *retraite*, from ML. *retracta*, retreat, from Lat. *retrahere*, to draw back, from *re-*, back again, anew + *trahere*, to draw). In military tactics and strategy, a retirement before, or in the face of, an enemy. It is one of the most difficult as well as important manoeuvres of modern warfare. The most important feature of the retreat, and the one on which rests its ultimate success, is the rear guard (q.v.). In barrack, army post, or camp life and routine in the United States Army, the bugle call 'retreat' signifies sunset, and is played by the field music (See BUGLE AND TRUMPET CALLS.) There is usually a parade or roll-call at that hour known as the evening parade, at which time extra duty details, guards or pickets, are paraded and go on duty. The ceremony of the retreat is observed throughout the armies of the world and is usually accompanied by gun fire and the lowering of the national color, which is hoisted again at reveille (q.v.).

RETREAT. A term used in the Roman Catholic and Anglican churches to designate a time of temporary retirement from active life

for the sake of prayer, meditation, and spiritual exercises. The practice is very ancient in the Church, as a following of the practice of Christ himself. The stricter retreats, especially those which the clergy of most Roman Catholic dioceses make every year, involve the giving up of the whole time to spiritual exercises, and usually silence is observed during them; but in the case of those who cannot leave their employment, services in the early morning and evening are provided; in their case the order of observances does not materially differ from that of a mission (q.v.).

RETRENCHMENT (from *retrench*, from OF. *retrencher*, *retrancher*, Fr. *retrancher*, to cut off, from *re-*, back + *trancher*, to cut, from Lat. *truncare*, to lop, from *truncus*, maimed). A defensive work in military fortification. It closely resembles the redoubt (q.v.) in construction and is usually built across the gorge of a redan or bastion, or from shoulder to shoulder, when it is apprehended that the salient angle may fall into the hands of the enemy. See FORTIFICATION; REDAN; REDOUBT.

RETRIEVER. See FIELD DOG; and Plate of DOGS.

RETROACTIVE (from Lat. *retroactus*, p.p. of *retroagere*, to turn back, from *retro-*, back + *agere*, to do, act, drive) or **RETROSPECTIVE LAWS.** These terms are used interchangeably to denote statutes which apply to a state of facts which existed before their enactment. Retroactive laws that are of a criminal or penal nature are specifically known as *ex-post-facto* laws, and are expressly forbidden by the United States Constitution. The Constitution also prohibited laws impairing the obligations of contracts. With these exceptions Congress, or the legislatures of the various States, are free to enact retrospective statutes whenever they may deem it advisable to do so. Although retroactive laws are in disfavor where they have the above effect, there are many which are necessary to remedy defects in the law theretofore existing. For example, statutes making valid deeds of married women executed within a certain time prior to their passage, or conveyances which did not bear a certain stamp required by law at the time of their execution, may have a most salutary effect. See EX-POST-FACTO LAWS; LAW; STATUTE; INTERPRETATION.

RETROGRADE (OF. *retrograde*, Fr. *rétrograde*, from Lat. *retrogradi*, to go backward, from *retro-*, back + *gradi*, to walk). A term applied to the motion of the planets among the fixed stars when they appear to move in the reverse order of the signs of the zodiac (q.v.). All the planets move in the same direction round the sun, and therefore apparent retrograde motions must be due to their motion relative to the earth. In the case of comets, however, we have instances of motion about the sun in the opposite direction to that of the planets, and in such orbits the motion (referred now to the sun, not to the earth) is said to be retrograde. In the case of the planets, let S be the sun, and let the two circles represent the orbits of two planets. First, let the planets be, at P and Q, toward the same side of the sun. The planet nearer the sun has of course the greater velocity, and therefore, if *p* and *q* repre-

sent their positions after the lapse of a given time, Pp is greater than Qq, and therefore the direction of the line pq (in which one is seen from the other) has rotated in the *opposito*

direction to that in which either planet revolves about the sun. Hence, when a superior planet is in opposition (i.e. if Q be Jupiter, and P the earth), it appears to move backward among the stars. When an inferior planet is between the earth and sun (i.e. if Q be the earth, and P Venus), it appears to move backward also. If the planets be on opposite sides of the sun, as at P and R in the figure, let *p* and *r* be their positions after a given time; then *pr* has turned from the direction PR in the direction in which the planets revolve about the sun. Hence any planet, superior or inferior, appears to move directly when the sun is between it and the earth. Between these two opposite cases, there must, of course, be points at which the apparent motion is neither retrograde nor direct—then the planet is said to be *stationary*. This case occurs whenever, for an instant, the lines PQ and pq are parallel; that is, when the two planets are moving with equal velocities transverse to the line joining them, these velocities being parallel, and toward the same side of the joining line.

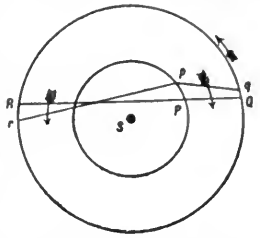

RETURNING BOARDS. In the United States, official bodies designated by law for canvassing the results of popular elections. The general rule is that a returning board in canvassing the returns sent to it acts in a ministerial capacity and must leave the correction of error or fraud to the courts unless the return be void on its face, in which case, of course, the returning board must reject it. The board for canvassing the returns of State elections usually consists of certain designated State officers including the Secretary of State and the Attorney-General. In some States the returns are canvassed by the presiding officers of the Legislature in the presence of the two Houses. In the case of members of the Legislature the returns are usually sent to the Secretary of State, though sometimes to a returning board, but all contests are decided by the Houses themselves in pursuance of a constitutional privilege everywhere allowed. In the case of local officers contested returns are settled by the courts acting as a canvassing authority, or in a *quo warranto* proceeding. In the case of Presidential electors Congress provided by the Act of 1887 that disputed returns in any State might be settled by such organs and according to such procedure as State law might provide. If this be not done within six days of the meeting of the electors, the two Houses of Congress have the final determination of the election.

RETZ, rĕts, GILLES DE LAVAL, Seigneur de. See BLUEHEARD.

RETZ, rĕs. JEAN FRANÇOIS PAUL DE GONDÏ, Cardinal de (1614-79). A French politician and author, born at Montmirail. His early education was intrusted to Saint Vincent de Paul, and he

later attended the Jesuit College at Clermont. It is said that he was compelled by his family to enter the Church in the expectation that he would become Archbishop of Paris, a position which had been held by two members of his house. He was brilliant in his studies, but dissolute in private life. He engaged in political intrigues with the Count of Poissons, but after the death of that nobleman resumed his theological studies and was made coadjutor of the Archbishop of Paris in 1643 by Louis XIII. He devoted himself to his duties with zeal and won popularity by his profuse distribution of alms. At the time of the Fronde (q.v.) he was at first of great assistance to the royal cause, but soon aroused the distrust of the Court, and became the leader of the popular party, displaying consummate talents for intrigue. In 1651 he became reconciled with the Queen mother, Anne of Austria, and with her aid he succeeded in obtaining a cardinal's hat. After the return of the Court to Paris, in 1652, a mission to Rome was offered to Gondi which he seemed disinclined to accept. Mazarin was determined that his rival should be silenced, however, and managed to have Cardinal de Retz arrested and imprisoned at Vincennes. The Cardinal thereupon resigned the Archbishopric of Paris, which had come to him by the death of his uncle, and was allowed to retire to Nantes, whence he made his escape to Spain (1654) and repaired to Rome. There, in spite of his previous renunciation, he again claimed the Archbishopric of Paris, and in 1662 he succeeded in bartering the Archbishopric for profitable benefices. At the same time he became reconciled to Louis XIV. and returned to France, but abstained from further political intrigue. He sold his estates, paid his heavy debts, and devoted his life to charity and religion. His *Œuvres*, which cover the years 1643-55, are described by Voltaire as displaying the grandeur, impetuosity, and inequality of genius. They are not, however, trustworthy, on account of political bias. The best edition of his works is that by Feillet in the *Collection des grands écrivains de la France* (Paris, 1870-96. Consult: Chantelauze, *Le cardinal de Retz, étude historique* (Paris, 1878); id., *Le cardinal de Retz et ses missions diplomatiques à Rome* (ib., 1879).

RET'ZIUS, MAGNUS GUSTAV (1842—). A Swedish histologist, born in Stockholm. He was for some time professor of histology and anatomy in the Caroline Institute. His printed works on anthropology include: *Finska Kranier* ("Finnish Skulls," 1872); *Biologische Untersuchungen* (1880-81); and *Gehörorgane der Wirbelthiere* (1881-84). With Prof. Axel Key he published *Studien in der Anatomie des Nervensystems und des Bindegewebes* (1875). In 1890 he became editor of the *Biologische Untersuchungen*.

RETZSCH, rēch, MORITZ (1779-1857). A German painter and engraver. He was born in Dresden, December 9, 1779, and studied at the academy of his native city, where he became a professor in 1824, and died July 11, 1857. Although treating romantic subjects, he belongs to the followers of Mengs. His chief celebrity rests upon his illustrations in outline of the great German poets, Schiller, Goethe, etc., whom he interpreted with great vigor and sympathy. His etchings of Goethe's *Faust* (26 plates, 1884)

are particularly well known, not only in his own country, but also in France and England. Among other important works are the outline illustrations of Schiller's *Lied von der Glocke* (43 plates, 1884); his *Shakespeare Gallery* (80 plates, 1860); and his outline drawings of Bürger's *Ballads* (15 plates, 1872). His oil paintings, treating classical subjects, are of little interest, but he succeeded better with portraits.

REUHLIN, roik'lén, JOHANN, known also by the Greek form of his name, CAPNIO (1455-1522). The first humanist of Germany and one of the earliest promoters of Hebrew studies in that country. He was born at Pforzheim, in Baden, February 22, 1455. He began his studies at his native place, continued them at Freiburg, and in 1473 accompanied Prince Frederick of Baden to Paris, where he made the acquaintance of Johann Wessel (q.v.) and began to study Greek. The next year he went to Basel, where he took his bachelor's degree in 1475 and his master's in 1477. He then revisited France, studied law at Orleans and Poitiers, and gave lectures in Greek and Latin. In 1481 he established himself at Tübingen as teacher of jurisprudence and literature. He entered the service of Eberhard, first Duke of Württemberg, accompanied him to Italy in 1482, and was employed in a number of public services. He visited Italy again in 1490. In 1492 the Emperor made him a count of the German Empire, and about the same time he began the study of Hebrew under a learned Jew who was Imperial physician. In 1496, after Eberhard's death, he went to Heidelberg, and made a third visit to Italy in the service of the Elector Palatine in 1498. At Rome he applied himself with renewed vigor to the study of Hebrew and Greek. He returned to Württemberg in 1499, and in 1502 was made a member of the Swabian confederate tribunal, retaining the office till 1513. In consequence of a quarrel between Ulrich, Duke of Württemberg, and the Swabian League, he went to Ingolstadt in 1519 and taught Greek and Hebrew at the university. When the plague broke out at Ingolstadt two years later he returned to Tübingen, intending to devote himself exclusively to study, but soon fell sick, and died at Liebenzell, June 30, 1522. Reuchlin is justly regarded as the father of Greek and Hebrew studies in Germany. He had great ability as a teacher, and, although for most of his life he held no professorial chair and was not always free to lecture openly, nevertheless he directed and encouraged the study of both languages in his generation. His devotion to Hebrew was the cause of the most interesting and important incident of his life. In 1510 one Johann Pfefferkorn, a baptized Jew, called upon princes and subjects to prosecute the religion of his fathers, and especially urged the Emperor to burn or confiscate all Jewish books except the Bible. Reuchlin remonstrated, maintaining that only books directly written against Christianity should be destroyed. This attitude drew upon him the enmity of the Dominicans, and particularly of the Inquisitor Jakob van Hoogstraten (q.v.). Reuchlin's opponents controlled the universities of Paris, Louvain, Erfurt, and Mainz; but many of the distinguished and independent thinkers of Germany were on the side of the scholar. Ulrich von Hutten and Franz von Sickingen in particular gave him support and pro-

tection, the latter threatening Hoogstraten and the monks with terrible vengeance if they did not cease to persecute "his teacher, Doctor Reuchlin, that wise, experienced, pious, and ingenious man." The *Epistolæ Obscurorum Virorum* (q.v.) was an outcome of the contest. While there was much in Reuchlin's character and experience to draw him toward the Reformation, he never openly joined the movement, and late in life declared against Luther. Melancthon was his great-nephew. Reuchlin's works include editions and Latin translations of Greek texts: a *Vocabularius Latinus Breviloquus* (1475); a manuscript Greek grammar (not published); the *Rudimenta Linguae Hebraicæ* (1506), which, with pardonable pride, he declares to be "the first attempt to execute a grammar of the Hebrew tongue," and made "without any foreign help;" *De Accentibus et Orthographi Hebræorum Libri III.* (1518); an edition of the seven Penitential Psalms (1512), the first Hebrew book printed in Germany; *De Verbo Mirifico* (1494); and *De Arte Cabbalistica* (1517), works on the Cabbala; *Scenica Progymnasmata* (1497), and *Sergius* (1507), Latin satirical comedies, not without humor and literary merit; the *Augenspiegel* (1511; ed. by Mayerhoff, Berlin, 1836), a reply to a book by Pfefferkorn (the *Handspiegel*). Two of Reuchlin's Greek treatises, the *De Quatuor Idiomatibus* and *Colloquia graeca*, have been published by Horawitz under the title *Griechische Studien* (Berlin, 1884). The best biography of Reuchlin is Geiger, *Johann Reuchlin; sein Leben und seine Werke* (Leipzig, 1871); consult also: id., *Johann Reuchlins Briefwechsel* (Tübingen, 1875); Horawitz, *Zur Biographie und Korrespondenz J. Reuchlins* (Vienna, 1877); Holstein, *J. Reuchlins Komödien* (Halle, 1888); Strauss, *Ulrich von Hutten* (6th ed., Leipzig, 1895), for the controversy about the Jewish books.

REULEAUX, rē'lō', FRANZ (1829—). A German mechanical engineer, born at Eschweiler, near Aix-la-Chapelle, where his father had machine shops. After finishing his apprenticeship in Koblenz, he worked in his father's shops, studied at Karlsruhe, and for a year was head of a factory in Cologne. Then he taught in Zurich (1856-64) and in Berlin (1864-96), where from 1868 until retirement he was director of the Industrial School. Reuleaux was intimately connected with German machinery exhibits at Philadelphia in 1876 and at Sydney and Melbourne (1879-81). His *Briefe aus Philadelphia* (1877) voice a sharp criticism on German methods of construction and especially on the lack of artistic design. To remedy this fault Reuleaux gathered a great collection of kinematic models in Berlin. His works are: *Konstruktionslehre* (with Moll, 1854-62); *Der Konstrukteur* (1860-62, and often); *Kurzgefasste Geschichte der Dampfmaschine* (1891); and *Thomassche Rechenmaschine* (2d ed. 1892).

REUMONT, rē'mōn', ALFRED VON (1808-87). A German historian. He was born at Aix-la-Chapelle, studied at Bonn and Heidelberg, and in 1832 traveled through Greece and the Ionian Islands. In 1835 he entered the diplomatic service, and subsequently was Minister Resident in Italy, principally at the Papal Court. His historical works include: *Ganganelli, seine Briefe und seine Zeit* (1847); *Beiträge zur italienischen*

Geschichte (1853-57); *Die Jugend Katharinas de' Medici* (1854); *Die Grafen von Albany* (1860); *Zeitgenossen* (1862); *Geschichte der Stadt Rom* (1867-70); *Lorenzo de' Medici il Magnifico* (1874); *Geschichte Toscanas* (1876-77); *Vittoria Colonna* (1881); and *Charakterbilder aus der neueren Geschichte Italiens* (1886). Upon art he wrote biographies of Michelangelo (1834), Andrea del Sarto (1835), and Benvenuto Cellini (1847), and other works.

REUNION, CHAMBERS OF. See LOUIS XIV.

RÉUNION, rā'ūnyōn', ILE DE LA. formerly called ILE DE BOURBON. An island in the Indian Ocean belonging to France, and situated 400 miles east of Madagascar and 100 miles southwest of Mauritius, in latitude 21° S., longitude 55° 36' E. (Map: World, M 26). It is of nearly regular oval shape, 34 miles long by 22 miles broad, and has an area of 775 square miles. It is entirely of volcanic origin, and very mountainous, with numerous extinct craters, the highest peak being the Piton des Neiges, with an altitude of 10,069 feet. In the region known as the Pays Brûlé rises the only active volcano, the Piton de la Fournaise, 8713 feet above the sea. The plateau composing the island is fissured on all sides by deep cañons through which numerous mountain torrents run to the sea. The climate is generally pleasant and healthful, but the island is occasionally visited by devastating hurricanes. The flora and fauna resemble those of Madagascar. There are luxuriant tropical forests.

Over one-third of the total area is under cultivation. The principal products are sugar, vanilla, coffee, cacao, and spices. The imports and exports in 1900 amounted to \$4,250,825 and \$3,367,850 respectively. About 60 per cent. of the exports consists of sugar, and about 90 per cent. of the total commerce is with France and the French colonies.

The administration of the colony is in the hands of a Governor, who is assisted by a privy council and an elective council-general. The island is represented by one Senator and two Deputies in the French Parliament, and its towns are administered under the municipal code of France. The local budget for 1901 balanced at about \$900,000, and the subvention from France amounted to over one-half of the revenue. The population in 1897 was 173,192, including over 15,200 Indian coolies, 4500 natives of Madagascar, about 9000 Africans, and nearly 1000 Chinese. The white population is far from pure. The capital is Saint-Denis.

The discovery of the island at the beginning of the sixteenth century is usually assigned to the Portuguese navigator Mascarenhas, after whom it was named originally. It was acquired by France in 1649. From 1810 to 1815 the island was held by Great Britain. Consult: *Annuaire de l'île de la Réunion* (Saint Denis, annually); Oliver, *Crags and Craters: Rambles in the Island of Réunion* (London, 1896); Garsault, *Notice sur la Réunion* (Paris, 1900); Hermann, *Colonisation de l'île Bourbon et fondation du quartier Saint-Pierre* (ib., 1901).

RÉUS, rā'ūs. A town of Catalonia, Spain, in the Province of Tarragona, five miles northwest of the town of Tarragona (Map: Spain, F 2). The principal buildings are the Gothic Church of San Pedro, rebuilt in 1512-69,

with a high octagonal tower, and the handsome modern Fortuny Theatre. There are also a large hospital, several colleges, and an academy of fine arts. Cotton-spinning, which was introduced by English manufacturers in the latter part of the eighteenth century, and silk-spinning are the principal industries. The exports are wines, fruit, grain, and confectionery. Population, in 1887, 28,780; in 1900, 26,220.

REUSCH, roish, FRIEDRICH (1843—). A German sculptor, born at Siegen. He studied in Berlin at the Academy and under Albert Wolff, whom he assisted on the equestrian monument to Frederick William III. After his return to Berlin from a visit to Italy in 1874, he fashioned the marble group of "Market-Traffic" (1879) for the Belle-Alliance Bridge, and the "Genius of Steam" for the Technical Academy at Charlottenburg. In Königsberg, where he was appointed professor at the academy in 1881, he executed the large group of "Strength, Justice, and Moderation" for the Government building, the statues of "Albert, First Duke of Prussia" (1891), and of Emperor William I. (1894), both outside the royal palace, besides several other memorials, many busts and decorative figures for public buildings. At Siegen are a "Soldiers' Monument" (1877), the equestrian statue of "William I." (1892), and a bronze statue of "Bismarck" (1900), and there are also several charming mythological genre groups to his credit.

REUSS, rois. Two sovereign principalities of Germany, situated between the Prussian Province of Saxony, the Kingdom of Saxony, Bavaria, and some of the Saxon duchies, and separated from each other by the outlying district of Neustadt of the Grand Duchy of Saxe-Weimar (Map: Germany, D 3). They are: Reuss Elder Line, or Reuss-Greiz, and Reuss Younger Line, or Reuss-Schleiz. Reuss-Greiz covers an area of 122 square miles and is largely mountainous. Its principal products are woolens and knit goods. The Constitution of 1867 provides for a legislative assembly of 12 members, of whom three are nominated by the Prince, two by the nobility, three elected by the towns, and four by the rural districts. The capital is Greiz. The principality is represented by one member in the Bundesrat and sends one deputy to the Reichstag. Population, in 1900, 68,287, almost entirely Protestants.

Reuss-Schleiz consists of a number of detached parcels of territory with a total area of 319 square miles. It is a mountainous country with deposits of marble and salt. The chief manufactures are woolen and cotton goods, machinery, musical instruments, and leather. The legislative body consists of 16 members, of whom three are elected by those paying the highest taxes, and 12 by the rest of the qualified voters, the head of the House of Reuss-Köstritz being an hereditary member. The executive and in part the legislative powers are vested in the Prince, who is assisted by a cabinet of three members. The principality sends one member to the Bundesrat and one deputy to the Reichstag. The population in 1900 was 138,993, almost entirely Protestant. The capital is Gera. Consult: Mauke, *Heimatkunde des Fürstentums Reuss* (Halle, 1877); Gaul, *Beiträge zur Landeskunde des Fürstentums Reuss* (Greiz, 1900).

REUSS, EDUARD WILHELM EUGEN (1804-91). An Alsatian Protestant theologian. He was born at Strassburg, July 18, 1804, was educated at the seminary of his native town, studied theology and Oriental philology at Göttingen, Halle, and Paris, and took orders in the French Protestant Church. He returned to Strassburg as privat-docent, was made professor extraordinary at the university in 1834, and held different positions there till 1888. He died April 15, 1891. His principal works are: *Die Geschichte der heiligen Schriften des Neuen Testaments* (1842; 6th ed. 1887; Eng. trans. 1884); *Histoire de la théologie chrétienne au siècle apostolique* (1852; 3d ed. 1864; Eng. trans. 1872-74); *Histoire du canon des Saintes Ecritures* (1862; Eng. trans. 1884); *Die Geschichte der heiligen Schriften des Alten Testaments* (1881; 2d ed. 1890). He was one of the editors of the great edition of Calvin's works (59 vols., 1869-1900), and published a complete French translation of the Bible with commentaries (19 vols., 1875-81). Consult the memorial address by Lobstein (Strassburg, 1891).

REUSS, RODOLPHE (1841—). An Alsatian historian, born in Strassburg and educated there, at Jena, at Berlin, and at Göttingen. He became professor at the gymnasium of Strassburg in 1865, and after the Franco-Prussian War resumed this position, retiring from the Protestant seminary. From 1872 to 1896 Reuss was librarian of the Strassburg library. In 1896 he was appointed professor at the Ecole des Hautes Etudes in Paris. His historical writings in both French and German deal with Alsace; among them are: *Beiträge zur Geschichte des dreissigjährigen Krieges im Elsass* (1868); *Vieux noms et rues nouvelles de Strasbourg* (1883); and the important *Alsace au XVIIIème siècle* (1897 et seq.).

REUTER, roi'ter, CHRISTIAN (1665-1712). A German author, born at Kütten, near Halle. He was a witty and gifted writer, and was especially effective in character delineation. In his *L'honnête femme; oder die ehrliche Frau zu Pflissine* (1695) he skillfully uses Molière's fable in *Les précieuses ridicules*. His chief work is the novel *Schelmuffsky Reisebeschreibung* (1696), which was reedited by Schullerus in 1885, and his other writings include *Der ehrlichen Frau Schlampampe Krankheit und Tod* (1696) and *Letztes Denk- und Ehrenmahl der Frau Schlampampe* (1697), which were republished in 1890.

REUTER, FRITZ (1810-74). A German humorist, who wrote in Low German (Plattdeutsch). He was born at Stavenhagen, in Mecklenburg-Schwerin, and was educated there and at Rostock and Jena, where he was arrested for political agitation (1833), and condemned to death, a sentence commuted to thirty years' imprisonment. He was confined in various fortresses till 1840, when he resumed legal studies at Heidelberg, afterwards managing his father's estate till 1850, when he became a private tutor at Treptow in Pomerania. Here he first began to write Low German sketches in prose and verse, the first volumes of which, *Läuschen un Rimels* (1853), showed such charming blending of humor and pathos in anecdotes and genre pictures as to achieve an immediate success, which was confirmed by the reception of *Polterabendgedichte* (1855) and *De Reiss' nah Belligen* (1855). In 1856 Reuter moved to Neubrandenburg and gave

himself wholly to writing. The best of his many volumes are *Schurr-Murr* (1861) and *Olle Kamellen* (1860-66). This latter contains the partly autobiographical *Ut mine Festungstid* and *Ut mine Stromtid*. (his greatest work); and the vigorous picture of Germany in 1813, *Ut de Franzosentid*, with other work of less value. In 1863 Reuter moved to Eisenach, where he died, July 12, 1874. Reuter is one of the most realistic of the greater German writers. It is the realism of the Dutch genre painters, minute, good-humored, bourgeois, as artistic in pathetic as in comic scenes. Reuter's works are in 13 volumes (Weimar, 1863-68), with two volumes of *Remains* and *Biography* (ib., 1875), and a comedy, *Die Drei Langhänse* (1878). Consult: Glagau, *Fritz Reuter und seine Dichtungen* (2d ed., Berlin, 1875); Ebert, *Fritz Reuter, sein Leben und seine Werke* (Güstrow, 1874); Romer, *Fritz Reuter in seinem Leben und Schaffen* (Berlin, 1895).

REUTER, HERMANN FERDINAND (1817-89). A German theologian, born at Hildesheim. He studied in Berlin and Göttingen; in 1843 became lecturer in the University of Berlin; from 1853 to 1876 was successively professor at Breslau, Griefswald, and again at Breslau; and in 1876 was called to Göttingen. His writings in Church history show thorough and scholarly research, and his criticisms are well grounded and clearly expressed. His publications include *Geschichte Alexanders III.* and *der Kirche seiner Zeit* (1845-64) and *Geschichte der religiösen Aufklärung im Mittelalter* (1875-77). He founded the *Zeitschrift für Kirchengeschichte*, in which he published his *Augustinische Studien* (1876).

REUTER, PAUL JULIUS, BARON (1821-99). A pioneer in the business of news-gathering, born at Cassel, Germany. He was connected with the electric telegraph system from its earliest establishment in Europe, and was the first to organize a central bureau for the systematic collection and dissemination of telegraphic news. This office was opened at Aix-la-Chapelle in 1849. In 1851 he transferred his office to London. Reuter established agencies in all parts of the world to supply him with news; and, by using all available means of communication, and serving all papers impartially, he built up a noteworthy news service. In 1865 he transferred his business to a limited liability company, of which he was manager until 1878. In the same year he obtained from the Hanoverian Government a concession for the construction of a cable line between England and Germany. The title of baron was conferred upon him by the Duke of Saxe-Coburg-Gotha in 1872.

REUTLINGEN, roit'ling-en. A town in the Kingdom of Württemberg, Germany, on the Echatz, at the foot of the Swabian Alps, 20 miles south of Stuttgart (Map: Germany, C 4). The thirteenth-century Gothic church, partly rebuilt in 1844, is now undergoing a thorough restoration. There are a gymnasium, a weaving school, a school of women's work, and a pomological institute. The town is an important centre of the yarn, woolen, cotton, and cloth industry. In 1240 Reutlingen became a free Imperial city. Subsequently it was a member of the Swabian League, and was annexed to Württemberg in 1803. Population, in 1890, 18,542; in 1900, 21,481.

RÉVAI, rá'voi, NICHOLAS (1750-1807). An Hungarian poet and philologist, born at Szent Miklós (Toronto). He entered the Piarist Order when he was seventeen, taught drawing, philosophy, poetics, and rhetoric in the schools of the Order, and in 1802, after several years devoted entirely to literature, was appointed professor of Hungarian philology in the University of Pesth. He had begun to write poetry even before joining the Piarists, and in 1778 and 1787 published volumes of elegies, and versions from the Latin elegiasts, the Alexandrine poets, the Anacreontics, and a part of the *Iliad*. But his chief title to remembrance lies in his work in the realm of comparative grammar, his discovery that Lapp, Finnish, Estonian, and Ostiak are nearly akin to Hungarian, and his researches in Magyar etymology, as contained in *Antiquitates Literaturæ Hungariæ* (1803) and *Grammatica Hungarica* (1803-06).

REVAL, rév'al (Russ. *Revel*). An important Baltic seaport of Russia, and capital of the Government of Esthonia, situated on the Bay of Reval, an inlet of the Gulf of Finland, about 230 miles west-southwest of Saint Petersburg (Map: Russia, B 3). The town consists of two parts, the upper town or Domberg (Cathedral Hill), with the old castle, the administration buildings, and the residences of the aristocracy, and the lower town, mediæval in appearance and containing the old town hall, the House of the Schwarzhäupter (an association of merchants), dating from the time when the town was a member of the Hansa, and a guild house with a museum of Baltic antiquities. The educational institutions include three gymnasias, a Realschule, and a technical railway school.

The manufactures are machinery and beer. The harbor of Reval is one of the most spacious in Russia and freezes but seldom. The annual value of the commerce is over \$30,000,000, giving Reval the third rank among the Baltic ports of Russia. The principal exports are spirits, grain, flax, and animals; the chief imports, cotton, coal, and petroleum. Reval is the seat of an admiralty and of the administration of the Baltic light-houses. The sea baths in the vicinity are well patronized. Population, in 1897, 64,600, about one-half Esthonian, and over one-fourth German. The foundation of Reval is ascribed to the Danish King Waldemar II., who built there a castle in 1219. The town joined the Hanseatic League in 1285 and soon attained considerable commercial importance. In 1346 it passed from the overlordship of the Danes to that of the Teutonic Knights. Sweden acquired it in 1561, and Peter the Great annexed it to Russia in 1710. Consult: Amelung, *Revaler Altertümer* (Reval, 1884); Rottbeck and Neumann, *Geschichte und Kunstdenkmäler der Stadt Reval* (Reval, 1896).

RÊVE, râv, LE (Fr., The Dream). One of the Rougon-Macquart series of novels by Emile Zola (1888). The story is in strong contrast with others of the series, the life of cathedral establishments forming the background of an idyllic tale of mysticism and human love.

REVEILLE, re-väl'yá, or (more usually in United States military service) rév'á-lé' (OF. *reveil*, Fr. *rêveil*, awakening, from OF. *reveiller*, to awake again, from *re*, again + *veiller*, to awake, from Lat. *ex*, out + *vigilare*, to awake, from *vigil*, wakeful, from *vigere*, to be lively;

ultimately connected with Eng. *wake*). A military trumpet, bugle, or drum call sounded at break of day, or such time afterwards as may be ordered, to rouse the men from sleep. Officially, it is the commencement of the day's routine. The military day is from reveille to retreat (q.v.); and the night from retreat to reveille. See BUGLE AND TRUMPET CALLS.

REVELATION (Lat. *revelatio*, from *revelare*, to reveal, unveil, from *re*, back again, anew + *velare*, to veil, from *velum*, veil, cloth, sail, from *vehere*, to carry along). In theology, a term used in both a general and a specific sense. In its broadest signification it expresses the unveiling or manifestation of the Divine to the human. In the narrower sense it is applied to one form of this manifestation, viz. the written word of God.

Using the term in the first or general sense, God manifests Himself in nature, in history, in the moral government of the world, in reason, and in the old ethnic religions and certain of the pagan philosophers. It seems impossible to believe in man and in a personal God without believing in a Revelation. The aspirations of the soul demand it. Man himself, as reflecting the Divine image, warrants it. Nature is the speaking and acting of God. It is Divine language in cipher. The universe is a manifestation of God's glory, a disclosure of His power. Specific revelation does not contradict these indications of Divine truth in nature. It gives them articulate expression. *History* and revelation are inseparable. The march of events and the development of ideas are but parts of a moving panorama of Divine creation and guidance. History is a chapter in the book of man's evolution. Behind the veil of external contingency there are the moral order of the life of nations, the rise and fall of dynasties, the progressive history of the human race, the development of man's religious consciousness in thought and in civilization. *Reason* and revelation are not antagonistic. Reason grasps and discerns and even defines the supersensuous. It is part of the Divine image in man, and so is naturally predisposed to the reception of the revealed. Many truths sometimes held not to be discoverable by reason are perfectly agreeable to it when discovered. The *ethnic religions* were clearly media of Divine revelation. They were partial disclosures of God to man—a feature in His gradual unveiling of Himself. They were preparatory to Christianity. *Pagan philosophy*, in the persons of some of its brightest lights, was a forerunner of the written word. Men like Socrates, Plato, and Aristotle among the Greeks, and Cicero, Epictetus, and Marcus Aurelius among the Romans, had wonderful glimpses of truth, and formulated admirable moral codes. They have been described as Christians without knowledge of the Christ. In fact, natural and revealed religion are now widely viewed as parts of a great whole, and not as distinct and separate manifestations of the Divine. Much of the teaching of revelation, technically so called, consists in the unveiling to us of nature and of life. Revelation does not merely superadd to the achievements of human knowledge. It penetrates to the moral and spiritual meaning of the world in which we live.

The advocates of a special revelation maintain that, despite all this, the fact remains that

the disclosure of the Divine in revelation generally was but partial, and therefore preparatory to a specific revelation. Man in his intellectuality was painfully sensible of the soul-sickness of the world, but he had no cure. To break the power of sin and quicken the higher and spiritual life he needed a revelation of fatherly love. The deepest discoveries and loftiest achievements of the human intellect needed to be supplemented by a special revelation. "The world by wisdom knew not God." The specific revelation was given in the written word. It may be divided into three epochs, the primitive revelation or protevangelium, the covenant revelation to Israel, and the revelation in the appearance of Jesus Christ. The Incarnation (q.v.) is held to be the culmination of every Divine manifestation, the central point of all history, sacred and profane (Heb. i. 1 and 2). The Old Testament represented a gradual process of education, as evinced, for instance, in the voice in the garden, the theophanies, the burning bush, and dreams and visions. God gave to men as they were able to receive. But the message became more and more explicit as the history of the ancient people was developed, until it culminated in Jesus Christ, in whom men saw "God manifest in the flesh" (John i. 18). The Old Testament is meaningless without the New. The Bible message is incomplete without the story of the Christ.

In discussing the specific revelation of the Scriptures it should be borne in mind that revelation and inspiration are not synonymous terms. Scientific theology distinguishes between them as to both authorship and function. The author of revelation, in the Old Testament and the New, is held to be the Divine Word, the *Logos* (John i. 1 et seq.). The author of inspiration is the Holy Spirit (II. Peter i. 21). *Revelation* has been limited to the direct communication from God to man of (1) such knowledge as man could not attain to in and of himself, and (2) information which, though attainable in the ordinary way, was not, in point of fact, known to the person who received the revelation. *Inspiration* is explained as the actuating energy of the Divine Spirit, under whose guidance the human agents chosen by God have officially proclaimed His will either by (1) word of mouth, or (2) the committal to writing of the several parts of the Bible.

BIBLIOGRAPHY. Christlieb, *Modern Doubt and Christian Belief* (Eng. trans., New York, 1875); Flint, *Theism* (Edinburgh, 1876); Wordsworth, *The One Religion* (Bampton Lectures, London, 1881); Harris, *The Self-Revelation of God* (New York, 1887); the articles "God" and "The Holy Spirit and Inspiration," in *Lux Mundi* (London, 1890); Westcott, *Introduction to the Study of the Gospels* (New York, 1896); Illingworth, *Reason and Revelation* (New York, 1902); and the works mentioned under **INSPIRATION**.

REVELATION OF SAINT JOHN, THE. The name given in the English Bible to the last book in the New Testament. In early lists and manuscripts it is called the Apocalypse of John, the current English title, Revelation, being from the Latin equivalent of the Greek word *Apokalypsis*, the first word of the book.

I. THE NATURE OF APOCALYPTICAL LITERATURE. The Book of Revelation belongs to a distinct class of literature, which has been called,

after the title of this book, apocalyptic. (See APOCALYPTIC LITERATURE.) Only in the light of this classification can the book be understood. The purpose of an apocalypse is usually to explain the present dominion of evil in the world, and to encourage faith by foretelling the approaching end of evil and the fulfillment of the prophetic hopes. The explanation of evil is usually found in the angel-world, and the consummation hoped for is a new world-age, which will come by a miraculous deed of God. Man can do nothing but wait for it with patient faith, and the seer's art consists chiefly in discovering the time and manner of its coming. This he does by such a fitting together of ancient prophecies and apocalyptic images with the events of his own time as shall give assurance that the longed for end is at hand.

Turning to the Book of Revelation, there can be no doubt that it is an apocalypse in the sense just defined, and the presumption that it is to be interpreted as such is strong. Like Daniel, it was written in a time of religious persecution at the hands of the ruling kingdom of the world, and its aim was to encourage the faithful to resist the allurements and endure the violence of the world power in view of the speedy coming of judgment and deliverance. Like Daniel, it has the course and end of world-history in view, and not principally the destiny of the individual soul. Other apocalyptic features of the Book of Revelation are its constant use of the vision form with angelic interpreters; its abundance of highly wrought and fantastic imagery, derived in large part from the Old Testament and from apocalyptic traditions, though freely combined and applied to new conditions; its explanation of the present dominance of evil as due to angel powers, whose malign rule is embodied in the Roman Empire; and its general scheme of the future, which with slight exceptions runs parallel to that of Jewish apocalypses. The mark that distinguishes the book as Christian is the identification of the Messiah with Jesus. We do not find, however, that this involves differences great enough to justify us in separating the book from the class and applying to it different methods of interpretation. It is, then, to be assumed that the predictions of the book concern the immediate and not the distant future, as indeed the writer explicitly affirms (i. 1, 3, xxii. 10-12). There is every probability that the earthly representative and agent of the power of evil is the Roman Empire. We shall expect to find visions or fragments from earlier writings or traditions, and to be able to distinguish between their earlier setting and application and the meaning our author gives them. Furthermore, we shall expect to find the value of the book to lie not in disclosures of the course of Church history down to the present, nor in predictions of still future events, but, historically, in its fitness to meet a great crisis in the life of the early Church, and permanently in its underlying faith in God and the certain victory of His cause.

II. CONTENTS AND PLAN. After the opening admonitions, in the form of letters, to resistance and endurance, the book sets forth the approaching judgments which will lead up to the destruction of Rome and of the satanic beings that inspire and sustain it, and to the final blessedness of the faithful. The progress of the successive visions is not, however, simply chronological, for

we seem to have reached the final judgment and consummation already in chs. vi.-vii. The movement is rather toward greater concreteness and detail, and the writer is interested in accumulating a variety of figurative and prophetic materials for the expression in stirring and impressive ways of his one message that the day of God's coming to bring evil to an end and good to its rights, and its glory, is close at hand. The first suggestion of a plan is found in the successive sevens, the seals, the trumpets, and the vials, but these do not include various important sections of the book. The contents of the seventh seal seems to be set forth in the new series of seven angels with trumpets (viii. 1-5), and the seventh trumpet (xi. 15-19) is followed, but not at once, by the seven vials of God's wrath (xv.-xvi.). But chs. vii., x.-xi. 14, xii.-xiv., xvii.-xxii. have no proper place in this scheme, and justice is not done to the new beginning in ch. x. It is therefore better to divide the book somewhat as follows: Introduction (i. 1-8) I. The Seven Letters (i. 9-iii. 22). II. Preliminary Judgments (iv.-ix.). (1) The actors: God (iv.); Christ (v.); Destructive Powers (vi.); (2) Promises (vii.); (3) Judgments (viii.-ix.). III. Final Judgments (x.-xx.). The Prophet's new commission (x.); Promises (xi. 1-14); Summary or Prelude (xi. 15-19); the Actors: Satan (xii.) and the Roman Empire and emperor-worship (xiii.); Summary promises and warnings (xiv.); Judgments culminating against Rome and its Satanic upholders (xv.-xx.). IV. The Consummation (xxi.-xxii. 5). Conclusion (xxii. 6-21). There are departures from any strict order, which are probably due in part to the use of unrelated sources, and in part to the author's practical aim, which leads him by anticipation to introduce encouraging voices and visions here and there before the end.

III. THE INTERPRETATION. The curious history of the interpretation of this book cannot here be reviewed. It has been supposed to have been written against Mohammed and the Turks; against the Pope and the Roman Catholic Church; against Luther and the Reformation; against Napoleon, etc. Many still hold that the book predicts the whole course of Church history past and to come. The form in which this so-called *Church historical* or *continuously historical* interpretation has still some advocates among scholars (Auberlen, W. Milligan, Benson) is that according to which the book contains in its symbols, not the definite events, but the conflicting powers or principles, good and evil, of Christian history. Almost all scholars, however, seek for the meaning of the book in the conditions of the writer's own time.

The Roman Empire is recognized as the persecuting and godless power, the agent of Satan, whom the book assails and whose fall it announces. Isolated scholars of far older times knew this, but it was especially the work of Lileke, Bleek, and Ewald that established it. With this is commonly connected the view that Nero was the wounded head (xiii. 3), the name signified by 666 (xiii. 18), and the one whose return from Hades and attack upon Rome in alliance with the Parthians is predicted in chapter xvii. The number 666 may, however, stand, as Clemen has recently argued, for ἡ ἑξάρτη βασιλεία, the Latin Kingdom.

In different parts of the book different periods

and different types of religious and Christian thought appear to be indicated. These facts, together with the breaks in the plan of the book already referred to and the composite character of some Jewish apocalypses, have led to the effort to solve the remaining obscurities by literary analysis, and the theory of various dates and authors. Weizsäcker suggested in 1882 that the writer incorporated some older oracles, Jewish or Christian, such as vii. 1-8, vii. 9-17, xi. 1-13, xii., xiii., xvii. Vischer, on the other hand, proposed the view that the book is a Jewish apocalypse (iv. 1-xxii. 5, omitting obvious Christian amendments), set in a framework (i.-iii., xxii. 6-21) and slightly revised by a Christian hand. This theory came out in 1886 with Harnack's indorsement and was accepted by several German critics. More elaborate analyses followed. Two Jewish apocalypses were found in the book by Weyland, and Spitta (1889) made the original book a Christian apocalypse by John Mark (A.D. 60), to which a later Christian added two Jewish apocalypses of the times of Caligula and Pompey. Against this method there has been a reaction in favor of the simpler view of Weizsäcker. The unity of the book is maintained, but the writer is believed to have made use of materials already shaped by earlier hands, and in part Jewish in origin. The Jewish character of vii. 1-8 and of xi. 1-13, with its date before A.D. 70—Jewish oracles applied in a figurative sense to Christians as the true Israel—and some of the peculiarities of xii., xiii., xvii., and other passages, may thus be explained in a way consistent with the ascription of the book to a Christian writer of Domitian's reign.

The next problem naturally is concerned with the first meaning of these incorporated materials. The most important study in this direction is that of Gunkel in reference to chapter xii. (1895). His theory is that the dragon who seeks to kill the child and persecutes the mother is ultimately derived from a Babylonian account of the birth of Marduk, the sun-god, destined to destroy the chaos-dragon and to create the world. Many who have not accepted Gunkel's reconstruction of an otherwise unknown part of the Babylonian myth have approved in general his emphasis on tradition as a great factor in the production of an apocalypse, and many have assented in particular to his theory that a sun-myth underlies chapter xii., whether Babylonian or Greek (Dieterich) or Egyptian (Bousset) in origin. Wellhausen has objected to the method and declared that the writer's own meaning is all we need to inquire after, and that he has shaped his figures to represent current events to a much greater degree than Gunkel allows. Bousset, one of the most important recent writers on the subject, adheres in general to Weizsäcker's idea of the composition of the book and to Gunkel's view of the significance of tradition. He put forth the hypothesis that an apocalypse of Antichrist, of Jewish origin, was current in New Testament times and on into the Middle Ages, that it was not dependent on Revelation, but that several of the fragmentary (Jewish) traditions which Revelation incorporates were derived from it (vii. 1-8, xi. 1-13, xiii., 11-17, xiv. 14-20).

Over against the fixity of apocalyptic tradition, rightly emphasized by Gunkel and Bousset, it is necessary to recognize the fact that the writer of Revelation used Old Testament ma-

terial with much freedom, and in the spirit of a poet, rather than in that of a hide-bound scribe. This is illustrated by such passages as i. 12-20, iv., xviii., xxi.-xxii. 5. The author writes as one whose mind is filled with Old Testament prophetic language; one who is almost limited to it for the expression of his thoughts, yet uses it freely and puts into it the emotions of his own soul. That his emotions were intense is a fact that must be seriously reckoned with in studying his book, whatever one may think about the question of actual ecstasy.

IV. HISTORICAL OCCASION, PURPOSE, AND DATE. The Seven Letters (chapters i.-iii.) are the most original part of the book and contain the most specific references to concrete conditions. Though addressed to actual churches whose conditions the writer knows, they are evidently meant, taken together, to give the message of the spirit of Christ to all His churches. The seven cities are named in geographical order, moving from Ephesus north, east, and south. The worship of the Emperor had been enforced in this region for a long time. Pergamum had a temple to Augustus in B.C. 29 and remained the centre of the cult in Asia (cf. Rev. ii. 13). The Book of Revelation was written chiefly to encourage Christians to resist this worship at whatever cost and to warn those who were falling away under its pressure and the enticements of the heathen thought and life that went with it. This cult is the second beast of chapter xiii., and all who take part in it are threatened with the impending fate of Rome itself, while those who resist it even to death will receive a glorious reward. Some persecutions of Christians had already been endured (ii. 3, 13, iii. 8), but far more severe trials were at hand (ii. 10, iii. 10) for which the book would prepare the way. The glory and reward of martyrdom are its theme. An official persecution of Christianity such as is here contemplated points to a time not earlier than Domitian. The relaxation of earlier zeal, the loss of love, the adoption of heathen ways of living, which the letters condemn, indicate the same period, as does the fact that Paul's position as founder of the church at Ephesus appears to be wholly a thing of the past. It is true that xi. 1-13 dates from before A.D. 70, but it is no less certain that it was originally a Jewish oracle. Its application in a figurative sense to the safety of the true worshippers of God, that is Christians, in the approaching crisis shows that the literal siege and fall of Jerusalem had long ago proved the oracle to be in its literal sense—which was indeed contrary to the word of Jesus—untrue. In xvii: 10, Vespasian seems indicated, but verse 11 is probably meant to carry us over into Domitian's reign. If the Nero myth is referred to in chapter xvii., this also, in this form, belongs to the close of the century. We may therefore conclude that the book was written, as Irenæus says, "near the end of the reign of Domitian," that is about A.D. 93-96.

V. THE CHRISTIANITY OF THE BOOK. The relation of the book to Paulinism is an unsolved problem. The stress it lays upon the transcendence of God, and upon the kingly and judicial functions of Christ, its view of salvation as a reward for overcoming the world and keeping the commands of God, are Judaistic aspects of the religion of the book. Its attitude toward Rome, also, is not that of Christ (Mark xii. 17) and

of Paul (Rom. xiii. 1-7, cf. 1 Pet. ii. 13-17). Yet an anti-Pauline tendency need not be inferred. Circumstances had changed, and Rome had become the power of lawlessness, instead of the one who restrained that power (11 Thess. ii. 7), so that Antichrist would inevitably take on a Roman in place of a Jewish form. Furthermore, over against the Jewish-Christian traits of the book we find a Christology not unrelated to Paul's (cf. i. 5, iii. 14, with Col. i. 18, and Rev. v. 9 sqq. with Phil. ii. 5 sqq.), an eschatology at many points in striking agreement with his, and a universality which at least is totally different from the exclusiveness of Paul's Judaistic opponents (vii. 9 sqq.). We cannot therefore with Baur regard Revelation as a simple product of the Jewish Christianity which opposed Paul. It is probably best to say that the book represents a late development of primitive Christianity, not much influenced either way by Paul.

VI. CANONICITY AND AUTHORSHIP. The place of Revelation in the canon has been much disputed. It was accepted in the Western Church after Hippolytus wrote in its defense against Caius, a Presbyter of Rome (c.215). For a long time the Eastern Church refused to recognize the book as canonical. Eusebius records and sympathizes with the objections of its critics. It was not in the original Syriac New Testament. The pressure of the Western Church finally secured its place in the canon. In the West only Jerome shows some sympathy with Eastern doubts. Its place in the canon was again somewhat insecure at the beginning of the Reformation—Luther in the first edition of his New Testament expressed a strong aversion to it, because of its obscurity, and especially because he did not find in it the Pauline gospel. Later he expressed a more favorable judgment. Zwingli did not accept it as canonical. Calvin at least did not comment upon it.

The writer calls himself John (i. 1, 4, 9; xxii. 8), and says that he saw his visions on the island of Patmos (q.v.), where he was, it would seem, in banishment. Justin Martyr is the first to identify this John with the Apostle, and from Irenæus and Tertullian onward this view was almost unquestioned. Yet Dionysius of Alexandria (c. 255) argued on the basis of a comparison with the fourth Gospel that the author of Revelation was another John; and Eusebius suggested the Presbyter John, of whom Papias speaks. The earliest opponents of the canonicity of the book, the Alogi, ascribed it to the Gnostic Cerinthus, an idea adopted by Caius. The author himself does not say that he is an Apostle (see on the contrary, xxi. 14; xviii. 20), and nowhere reveals any personal knowledge of the earthly life of Jesus. It cannot quite be said that he assumes a position of personal or official authority over the seven churches. He is their brother and fellow in trial (i. 9), but the authority that speaks through him is Christ. He claims only to be a true prophet, truly to convey the message of Christ. For his book he makes great claims, but not for himself. Of the three possibilities: that it is by the Apostle; that it is a pseudonymous writing, in the Apostle's name; and that it is by another John—the second can with some confidence be rejected. For though pseudonymity characterizes all Jewish apoca-

lypses, we find here none of the familiar signs of it, no references to known events in the life of John such as we should expect. If the Apostle were the recognized head of the churches of Asia, centring in Ephesus, during the last quarter of the first century, the expression "John to the seven churches" (i. 4) would suggest him. If that place was occupied by John the Presbyter, he would be the one indicated. The most serious difficulty in the way of accepting the Apostle's authorship is the radical difference in style and in conception that separates the Apocalyptic from the Gospel. Though minor points of likeness exist, the difference is so great that it seems almost impossible to ascribe them to one mind. The difficulty is greater now that it is no longer probable that they can be separated widely in date by putting Revelation before A.D. 70. The question of authorship must therefore remain open, but this question does not affect our view of the value of the book and the way in which it is to be understood.

BIBLIOGRAPHY. The Church-historical view can be read best in Milligan, *Commentary on the Apocalypse*, Baird Lectures (London, 1886); id., *Discussions on the Apocalypse* (ib., 1893); id., *The Book of Revelation*, Expositor's Bible (New York, 1899); and in Benson, *The Apocalypse* (London, 1900); the older critical view (contemporary-historical), in the commentaries of Lücke (2d ed., Bonn, 1848-52); Bleek (Berlin, 1862); and Ewald (Göttingen, 1862). Consult also the commentary of Alford (London, 1867). The best recent commentaries are those of Bousset (Göttingen, 1896) and Holtzmann (Freiburg, 2d ed., 1893), and in English, Simeox, Cambridge Bible (Cambridge, 1898), and Scott, Century Bible (Edinburgh, 1902). Consult further the introductions to the New Testament by Weiss (London (1887); Holtzmann (Freiburg, 3d ed., 1892); Zahn (Erlangen, 1897-99); Jülicher (Tübingen, 3d ed., 1901), and Moffatt, *Historical New Testament* (New York, 1901); the New Testament theologies by Weiss (Edinburgh, 1885); Holtzmann (Freiburg, 1896); Stevens (New York, 1899); Wernle, *Beginnings of Christianity* (London, 1903); and Histories of the Apostolic Age by Weizsäcker (London, 1894), McGiffert (New York, 1897), and Bartlett (London, 1900). Consult further Gunkel, *Schöpfung und Chaos in Urzeit und Endzeit* (Göttingen, 1895); Bousset, *The Antichrist Legend* (trans. by Keane, London, 1896); articles by Bousset, "Apocalypse," in *Encyclopædia Biblica* (London, 1899); Porter, "Revelation," in the *Hastings Dictionary of the Bible* (New York, 1898).

REVENUE, PUBLIC. See FINANCE; TAXATION.

REVENUE CUTTER SERVICE, UNITED STATES. A military service, organized by act of Congress in 1790, for the enforcement of navigation and customs laws. It was the first armed maritime force of the Government, having been constituted about eight years before the United States Navy. There being no naval establishment at that time, the service, as a matter of convenience, was attached to the Treasury Department, then presided over by Alexander Hamilton, where it has since remained. Its first fleet consisted of 10 small, single-masted, light-draught sail-

ing vessels, manned with 10 masters, 30 mates, 40 mariners, and 20 boys. By degrees, and as occasion arose, the service was augmented in strength and armament, and on July 1, 1799, Congress authorized the President to "cause the revenue cutters to be employed to defend the sea-coast and to repel hostility to vessels and commerce within their jurisdiction." The rapid growth of foreign trade, and a shipping interest that was constantly developing at home, created the necessity for more efficient means of protection, and swifter cruisers, better armed, manned and equipped, were gradually added to the force. The duties of these vessels were extended to the suppression of piracy that had become common on account of the many adventurers attracted to American waters. A distinctive revenue ensign and pennant were provided by law. (See Colored Plate in article FLAG.) Beginning in 1843, steamers were introduced, and they have entirely superseded the old type of sailing cutters.

Revenue cutters have participated in all the wars of the United States except the Algerine war, and have been prompt to respond to any emergency. In 1797, when France assumed a belligerent attitude, and during the troublous times that followed, the cutters aided in maintaining the dignity and position of the Government. Seven of them were employed in the waters of the West Indies. The Embargo Act of 1807, intended to countervail Napoleon's decrees, put the service into special requisition in guarding the seaboard and preventing the departure of unauthorized merchant ships. In the War of 1812 its force was actively engaged in patrolling the coast and repelling foreign invasion. During the nullification troubles of 1832-33 several revenue vessels were stationed off Charleston ready to enforce the execution of the tariff laws. At the time of the Seminole War, in 1836, they transported troops and munitions, and afforded protection to settlers along the coast. In the war with Mexico eight vessels shared in the naval attacks on Alvarado and Tabasco and cooperated with the naval squadron. In 1858 the steam cutter *Harriet Lane* took part in the naval expedition to Paraguay, and was considered one of the most efficient ships of the fleet. During the Civil War the cutters were busily engaged conveying dispatches, pursuing blockade-runners, doing guard and reconnaissance duty, and joining in attacks on the enemy's forts and batteries. Throughout the war with Spain 20 vessels of the service, carrying 71 guns, 131 officers, and 725 men, were employed with the army and navy, while 3, just constructed, with 25 officers and 210 men, were under orders to go to the front when the war closed. Eight cutters were in the North Atlantic squadron on the Cuban blockade, 4 cooperated with the navy on the Pacific coast, while one was in the Battle of Manila Bay.

In 1903 there were in the service 44 vessels, 17 of them harbor and anchorage boats, steam launches, etc., 1 a practice bark, and the remaining 26 steamers ranging from 152 to 869 tons burden. Those built of steel in recent years are admirable models of marine design and architecture and are among the fastest of their class afloat. Nearly all have been constructed under the immediate supervision of officers of the corps and devised with special reference to the general needs of the service. They are usually armed

with from 2 to 9 improved rapid-fire guns, and are provided with necessary small arms for the use of the crews. In time of war their equipment may be readily augmented. The vessels are kept prepared, as far as possible, for prolonged voyages and the performance of any duty that may be legally assigned them. In this connection it may be stated that about all the early authentic information concerning the natural features of Alaska, its climate, the characteristics of the natives, and the resources of that country, were obtained by explorations made by officers of the revenue cutter service. Several vessels make cruises each year into the Bering Sea and Arctic Ocean for the protection of the fisheries and Government interests.

The active list of the service comprised, in 1903, 37 captains, 37 first lieutenants, 37 second lieutenants, 37 third lieutenants and cadets, 1 captain of engineers, 35 chief engineers, 17 first assistant engineers, 18 second assistant engineers, and 1 constructor, and in addition about 1000 petty officers and seamen. The officers of the engineer corps rank with line officers of corresponding grades, and the constructor has the rank of first lieutenant. All are commissioned by the President, by and with the advice and consent of the Senate, and, under the law, rank is held as follows: Captains with majors in the army and lieutenant-commanders in the navy; first lieutenants with captains in the army and lieutenants in the navy; second lieutenants with first lieutenants in the army and lieutenants (junior grade) in the navy; third lieutenants with second lieutenants in the army and ensigns in the navy. When revenue cutters serve in cooperation with the navy, pursuant to law, their officers hold rank with and next after naval officers of the grades named. The commissioned officers of the service receive the same pay and allowances as officers of corresponding rank in the army, and are retired for physical disability or on reaching the age of 64 years. Promotions are made, in the order of seniority, to fill vacancies which may occur in the various grades, after the candidates have qualified by a professional examination.

In 1876 Congress enacted a measure permitting the Secretary of the Treasury to appoint cadets to fill vacancies occurring in the grade of third lieutenant. The object was to provide means for educating young men for deck officers. Under the operation of this system nearly two-thirds of the active list of the line in 1903 were composed of cadet graduates. Some 10 additional appointments have been made from graduates of the Naval Academy. Before the cadet system was organized candidates from the merchant marine and volunteer navy were admitted directly to the grade of third lieutenant. An applicant for a cadetship must be not less than 18 nor more than 25 years of age, of vigorous constitution, physically sound and well formed, not less than 5 feet 3 inches in height, of good moral character, and unmarried. He is required to pass a satisfactory entrance examination in spelling, geography, general history and Constitution of the United States, grammar, composition and rhetoric, arithmetic, algebra, geometry, trigonometry, physics, English literature, one modern language (either French, German, or Spanish), and general information. The examination, which is open to all qualified

persons, is held annually under the direction of the Civil Service Commission. From those passing highest, provided they reach the required standard, a class is formed which is ordered to report for instruction on the practice ship *Chase*. The term on the practice ship covers a period of three years and comprehends a strict course of discipline and instruction in all matters pertaining to the professional requirements of an officer. A cadet receives \$500 per annum and one ration per day, and must provide himself with the prescribed uniforms. At the expiration of his probationary term of three years, if his deportment and progress have been satisfactory, he is rewarded with a commission as third lieutenant. Original appointments in the engineer corps are made from civil life upon thorough examinations.

The work of the Revenue Cutter Service, as defined by law, consists in the enforcement of about every statute bearing upon the maritime interests of the nation. Its duties embrace the protection of the customs revenue; the enforcement of the laws against smuggling, those pertaining to national quarantine, the neutrality laws, the navigation laws, including vessels' documents, and all requirements in regard to the rules for preventing collisions, officers' papers, steamboat inspection, and passenger service; the laws in suppression of piracy, robbery, and mutiny on the high seas; those for the protection of the seal fisheries and sea-otter hunting grounds in Alaska, and for the prevention of illegal traffic in firearms, ammunition, etc., in that territory; the laws for the protection of wrecked property and the timber reserves of the United States; the laws for the suppression of the slave trade; those that require necessary life-saving appliances to be kept on board merchant vessels; the laws in regard to the anchorage of vessels in the ports of New York and Chicago, in the Saint Marys River, Michigan, etc., and the regulations to insure the safety of observers of and participants in regattas on navigable waters. During the dangerous and inclement season, from December 1 to April 1 of each year, revenue cutters are, by direction of the President, required to cruise actively along the coast to afford aid to vessels in distress. Those detailed for such duty are provided with special supplies, including extra provisions for the shipwrecked, and are instructed to extend to all requiring relief such assistance as may be adapted to their condition and necessities. The cutters on the Great Lakes are, during the period of open navigation, charged with similar important work. An important function of revenue cutter officers is their connection with the Life-Saving Service (q.v.). They are detailed to do the inspection work of the latter and to drill the surfmen in the use of life-saving apparatus, and to see that the equipments of the stations are kept in efficient condition. Several officers are also assigned to superintend repairs and the construction of new stations. Besides the fixed duties of the service there are numerous others which it is called upon to perform from time to time, such as aiding the Public Health and Marine Hospital Service, the Lighthouse Establishment, the Coast Survey, the Fish Commissioner, the ocean telegraph lines, etc. Each vessel has assigned to her a certain district, within which she carries out her specified duties. The districts on the Atlantic and Pacific seaboard and the Great

Lakes are contiguous and therefore cover the entire coast of the United States.

REVERBERATORY FURNACE. See IRON AND STEEL; LEAD.

REVERE, rē-vēr'. A town, including three villages, in Suffolk County, Mass., five miles north by east of Boston; on the Boston and Maine and the Boston, Revere Beach and Lynn railroads (Map: Massachusetts, E 3). It is finely situated on the Atlantic coast, and is an attractive residential place and a summer resort. Revere Beach has a bath-house built and maintained by the State, and is one of the most popular bathing resorts on the Massachusetts coast. It has also a splendid boulevard. There are a handsome town hall and a public library with 7000 volumes. Revere was settled in 1626 and, under the name of Rumney Marsh, formed a part of Boston until 1738. Incorporated as Chelsea in 1739, it was set off and reincorporated as North Chelsea in 1846, and received its present name in 1871. Population, in 1890, 5668; in 1900, 10,395.

REVERE, rā'vā-rā, GIUSEPPE (1812-89). An Italian poet, born at Triest. He wrote for *La Concordia*, a liberal journal of Turin; took part in the events of 1848; and afterwards lived in Turin, Genoa, and Rome. He began his career as a dramatist with a series of historical plays, in the form made popular by Niccolini. He also wrote the historical works, *La cacciata degli Spagnuoli da Siena* (1847); the poetical works, *Sdegno e affetto* (1845), *Nuovi sonetti* (1846), *Persone ed ombre* (1862), *Ossiride* (1879); and two volumes of sketches, *Bozzetti alpini* (1857) and *Marine e paesi* (1858).

REVERE', PAUL (1735-1818). An American patriot, born in Boston, Mass. He learned from his father the trade of a goldsmith and soon became skillful as an engraver on silverware. In 1756 he served as a lieutenant in the Crown Point expedition, and, returning to Boston, established himself as a goldsmith and a copper-plate engraver. He was a member of the grand jury which in 1774 refused to serve on account of the act of Parliament making judges independent of the legislature as regards salary. He engraved the plates and printed the paper money ordered in 1775 by the Provincial Congress, and in the same year established a powder mill in Boston. He early took an active interest in the disputes with the English Ministry, participating in the "Tea Party" (1773) and carrying the news of it to New York and Philadelphia, and in 1774 became a member of a society organized to watch the British in Boston. On April 18-19, 1775, at the request of Joseph Warren, he made his memorable midnight ride to Lexington to warn Hancock and Samuel Adams of the approach of English troops, arousing the people on the way. Then, passing on toward Concord with William Dawes and Dr. Samuel Prescott to warn the people there, he was captured by a party of British soldiers and was brought back to Lexington, where he was released on the next day. This ride has been made the theme of a celebrated poem, *The Midnight Ride of Paul Revere*, by Longfellow. Subsequently becoming lieutenant-colonel of State artillery, Revere accompanied the unsuccessful Penobscot expedition in 1779.

REVERIE, or **REVERY** (Fr. *rêverie*, OF. *resverie*, from *resver*, *rêver*, *rever*, to rave, from

Lat. *rabies*, rage, from *rabere*, to rage). A word borrowed from the French, and somewhat loosely used to signify a state of mind obtaining during waking life and characterized by neglect of present surroundings, meditateness or abstraction. True reverie, like the dream of sleep, is marked by a condition of discursive, passive attention. There is, to be sure, abstraction, forgetfulness of one's environment, but the trend of consciousness is not toward any definite goal. Like the dream, too, the reverie is apt to be fleeting and easily forgotten. Its fancifulness and fleetingness is but another evidence of the lack of control by active attention. Consult: Titchener, *Outline of Psychology* (New York, 1899); James, *Text-Book of Psychology* (New York, 1892); Carpenter, *Mental Physiology* (London, 1888). See ASSOCIATION OF IDEAS; ATTENTION; DREAMING; HYPNOTISM.

REVERSION (Lat. *reversio*, from *revertere*, to turn back, from *re*, back again, anew + *vertere*, to turn; connected with Skt. *varṭ*, Ochurch Slav. *vrātĭti*, *vratiti*, to turn, Goth. *vaírþan*, AS. *veorþan*, OHG. *werdan*, Ger. *werden*, to become). A form of heredity (q.v.). Cases occur where an individual inherits not its parents' physical or mental characteristics, but those of its grandparents, or more remote ancestors. This happens in cultivated plants and domestic animals artificially bred from wild forms. If such forms are neglected or return to free nature, i.e. run wild, they tend to 'revert,' 'throw back,' i.e. to transmit the characteristics of the original wild species or variety. Darwin remarks that reversion may be divided into two classes: (1) Those occurring in a variety or race which has not been crossed, but has lost by variation some character that it formerly possessed, and which afterwards reappears; (2) all cases in which an individual with some distinguishable character, a race, or species, has at some former time been crossed, and a character derived from this cross, after having disappeared during one or several generations, suddenly reappears. He gives extensive examples in illustration, and concludes that a tendency to atavism is "an integral part of the general law of inheritance." In breeding zebra-hybrids by crossing mares of various sizes with a male zebra, the hybrids, says Ewart, showed a curious blending of characters, derived apparently partly from their actual and partly from their remote ancestors. As the result of Ewart's experiments some of the hybrids in make and disposition strongly suggest their zebra sire, others their respective dams, but even the most zebra-like in form are utterly unlike their sire in their markings, probably taking after an ancestor thousands of generations removed. Consult: Darwin, *Variation of Animals and Plants Under Domestication* (London, 1888); Ewart, *The Penycuik Experiments* (London, 1899). Compare ATAVISM.

REVERSION. The residue of an estate or interest remaining in a grantor of real property who has conveyed away one or more estates in it, amounting to less than a fee simple in quality and duration. A reversion is said to arise by operation of law, that is, without special act of the parties to a conveyance, and in this respect it differs from a remainder, which must be created by express words in a conveyance. See REMAIN-

DER. Consult the authorities referred to under REAL PROPERTY.

REVETMENT (Fr. *revêtement*, from *revêtir*, OF. *revestir*, to line, from *re*, again + Fr. *vêtir*, OF. *vestir*, to clothe, from Lat. *vestire*, to clothe, from *vestis*, garment). An important device in both permanent and field military fortifications. In the former, it is usually a retaining wall of masonry, built for the purpose of holding back or strengthening the earth of which the works are composed. Revetments are ordinarily used for the escarp (q.v.) and counterescarp (q.v.) of the ditch (q.v.), the more important being the escarp, which has to hold back the great mass of earth represented by the rampart, parapet (q.v.), and banquette. It is usually of solid brickwork or stone, about 5 feet thick at the top, and sloping outward as it descends (on the ditch side only) about 1 in 6. Additional strength is obtained by reinforcing the revetment wall by massive buttresses at intervals of 15 feet, called *counterforts*, and these again are sometimes connected and strengthened by masonry arches outside the revetment. In field works the amount of resistance offered by a redoubt or similar fortification to the artillery fire of an enemy will greatly depend on the character of the revetments, which may be of sods, timber, hurdles, or gabions (q.v.). See FORTIFICATIONS; REDOUBT; and SIEGE AND SIEGE WORKS.

REVIEW (OF., Fr. *revue*, from *revoir*, to review, from Lat. *revidere*, to see again, from *re*, back again, anew + *videre*, to see). A military parade, followed by inspection and review, the latter usually consisting of a salute tendered to the reviewing officer as the troops 'march past.' This ceremony to-day is merely an exhibition of number, equipment, bearing, discipline, physique, and general condition, and consequently is treated almost exclusively as a compliment to a distinguished visitor, or as the finale to a field day. In the United States Army, reviews may be held by a battalion, regiment, brigade, division, or corps; but only on such occasions and for such purposes as are authorized by army regulations.

REVIEW. See PERIODICAL.

RÉVILLE, rā'vêl', ALBERT (1826—). A French Protestant clergyman and author, born at Dieppe (Seine-Inférieure). He studied at Dieppe, Geneva, and Strassburg; was for a time vicar at Nîmes, later pastor at Luneray, near Dieppe, and in 1851 became pastor of the Walloon Church at Rotterdam. In 1873 he returned to Dieppe, where he pursued philosophical studies until his appointment as professor of the history of religions in the Collège de France. He also became president of the section of religious sciences in the Ecole Pratique des Hautes Etudes. He ranked as one of the most advanced representatives of the French liberal Protestantism of his time. His publications include a translation (1849) of Whately's *Introductory Lessons on the History of Religious Worship* (London, 1849), *Essais de critique religieuse* (1860; 2d ed. 1869), *Théodore Parker, sa vie et ses œuvres* (1865), *Douze sermons* (1874), *Protégomènes de l'histoire des religions* (1881), and the *Histoire des religions* (1883-89), his most extensive and important work.

REVILLOUT, rā'vê'voo', EUGÈNE (1843—). A French Egyptologist, born at Besançon. He

was educated for the Church, but preferred Oriental studies, entered the department of Egyptian antiquities at the Louvre as an assistant in 1869, aided in founding the Ecole du Louvre in 1880, and in 1881 became professor and curator of the Egyptian collection of that museum. Revillout's great work was the publication of the *Chrestomathie démotique* (1878-80), supplementing Brugsch's discoveries in the demotic language. Besides, he specialized on Egyptian law, founded, with Brugsch and Chabas, the *Revue Egyptologique* in 1880, and published: *Papyrus coptes* (1876), *Le roman de Setna* (1880), *Corpus Papyrorum Ægypti* (1885-92), *Cours de droit égyptien* (1885), *Cours de langue démotique* (1885), *Lettres sur les monnaies égyptiennes* (1895), *Mélanges sur la métrologie, l'économie politique et l'histoire de l'ancienne Égypte* (1897), and *Précis du droit égyptien* (1899-1903).

REVISED STATUTES. The acts of the legislatures of the various States and of Congress are usually printed and bound into volumes after each session of those bodies. This is done by an authorized printer under the supervision of a State official, usually the Secretary of State, who compares the acts as thus printed with the original copies thereof, and certifies as to their accuracy. Such publications are known as the *statutes at large*, and include all acts whether general or local in character. After a large number of these volumes have been issued, covering a considerable number of sessions, it naturally follows that many of the acts found in the earlier volumes are repealed or amended by acts reported in the later ones; and that some statutes have become practically obsolete by reason of changed conditions. Where this state of facts exists, it is necessary to examine all the 'year books,' as such volumes are usually called, in order to determine the statute law on any given subject. In order to render the statute law more accessible, settle positively any questions as to the intention of the legislature in passing acts repealing former ones, and to cure any defects in form or substance which have become apparent in existing statutes, most of the States have at some time authorized thorough revisions of their statute law. The work is usually done by a committee of the State legislature, who arrange the existing statutes under proper general heads, and draft such amendments and alterations as they may deem advisable. Strictly local or special statutes, not of general interest, are sometimes omitted in the revision. The general laws as thus collected, arranged and amended, are reenacted by the legislature and then constitute the official revised statutes of the State, superseding all original acts on the same subject. There have been several revisions of the statutes of the United States. For acts supplementary to or amendatory of the revised statutes, the Statutes at Large, published after each session, should be consulted.

REVIVALS (from *revive*, from Lat. *revivere*, to live again, from *re*, back again, anew + *vivere*, to live), RELIGIOUS. A term widely used among Protestants since early in the eighteenth century, to denote periods of marked religious interest, when church-members are quickened to a new sense of responsibility and privilege, and others are for the first time brought openly to

confess their faith. By an extension of its meaning, the term is sometimes applied to various important religious movements of the past, like that of the Day of Pentecost (Acts ii.), of the Wiclifites in England, the Hussites in Bohemia, and the Reformers of the sixteenth century. In a similar way it might be used of the religious zeal which led to the First Crusade, the work of the great monastic Orders in some periods of their history, the Oxford Movement, and so on. But it is more accurate and better to limit the application of the term 'revival' to the history of modern Protestantism, especially in Great Britain and America, where such movements have flourished with especial vigor. Yet in so doing, one should not forget that there were similar revivals of religion in Scotland as early as the end of the sixteenth century (under Wishart, Cooper, and Welsh), and again, both there and in the north of Ireland, about a generation later, when Bruce and Livingstone were prominent as leaders (the Stewarton Movement).

Seasons of religious quickening occurred in the colony of Massachusetts Bay between 1704 and 1718, but in importance and influence they were far overshadowed by the work of Jonathan Edwards (q.v.) at Northampton in 1734. His preaching so deeply affected his hearers that about three hundred persons were converted. The movement spread through a large part of New England in the next two years, and formed a suitable introduction to 'The Great Awakening,' a revival which extended through almost all the colonies and influenced either directly or indirectly almost all the churches. This movement began about the same time as that of John Wesley in England. Its most active agent was George Whitefield (q.v.), a preacher of singular power and inexhaustible energy, who came from England to America in 1739, and traveled through the country, preaching in the open air to audiences of thousands, and winning a large number of converts. The Great Awakening proper occupied the years 1740-42. Several evangelists were enlisted in its service, notably the zealous but censorious Gilbert Tennent (q.v.), a Presbyterian, who had begun revivalist work in New Jersey before Whitefield's arrival. Among the most obvious results of the Awakening were the addition, between 1740 and 1760, of 150 churches to the number already established in New England and the doubling of the number of Presbyterian ministers in the middle colonies. Princeton College grew out of the movement, and the plan for a school for the education of the Indians was conceived about the same time, from which later came Dartmouth College (q.v.). The Wesleyan movement did for England what the Great Awakening did for America, but with a new and permanent ecclesiastical organization as its product.

Toward the end of the eighteenth century a fresh series of revivals began, lasting intermittently from 1797 to 1859. The beginning of this long period was called, in New England, the 'evangelical re-awakening.' The work was carried on at first by parish ministers, not by traveling evangelists, and the churches soon came to depend upon revivals for their growth and even for their life. As time went on, the work was taken up by itinerant preachers also. Among the prominent leaders were Nathan Strong, Edward Dorr Griffin, Jeremiah Hallock, Timothy

M. Cooley, and Charles G. Finney. The early years of the nineteenth century were marked by great missionary zeal, reaching out beyond the boundaries of New England, and even to foreign lands. See MISSIONS, CHRISTIAN.

Toward the southwest, in Tennessee and Kentucky, we meet for the first time with 'camp-meetings,' great open-air assemblies, which since 1800 have played an important part in the evangelistic work of the Methodist Church. (See CAMP-MEETING.) Ministers of other denominations at first participated in this movement, special sympathy being manifested by the Presbyterians, but the extreme excitement soon alienated them from it. A considerable number of Presbyterians, however, who continued to believe in the revival theory as there illustrated, withdrew from communion with the main body, and formed the nucleus of what has since become the Cumberland Presbyterian Church. (See PRESBYTERIANISM.) One of the most valuable products of the camp-meeting idea is the Chautauqua Assembly, a highly successful educational enterprise, which is still closely connected with religious work. (See CHAUTAUQUA.) One of the most noteworthy revivals of the whole series was that of 1858-59, which, like the Great Awakening, affected nearly all branches of Protestantism, and was nowhere more successful than in New York City. No account of modern revivals would be complete without prominently mentioning the work of Dwight L. Moody, who for many years exerted a large influence in Great Britain and America, reaching all classes of society.

What is commonly called the revival period of American religious history may be said to have closed soon after the middle of the nineteenth century. Horace Bushnell's work on *Christian Nurture*, published in its completed form in 1861, was undoubtedly a sign of the changing religious temper. Men's minds were turning to other ways of extending the Church's influence as being at once more normal and more promising. The establishment of several theological schools, like Andover, Bangor, Hamilton, Newton, and others, due largely to the interest evoked by the revivals early in the century, tended to promote this very change.

Although revivals mark a temporary departure from the historic method of propagating Christianity, which is by religious training accompanying the sacrament of baptism, yet they are a natural incident in the development of Protestantism. Most of the Protestant churches require some evidence of regeneration before admitting members into their fellowship, and this evidence is most naturally sought in religious experience, especially in the process of conversion. This is commonly understood to mean such a change of heart and disposition, often sudden, as can be wrought only by the operation of Divine grace. This idea laid firm hold upon many American churches, so that conversion came to be regarded as the normal mode of entrance upon the religious life. Baptism continued to be administered, but the significance of infant baptism was largely lost sight of, and the historic system of catechetical instruction generally disappeared. No student of the subject can doubt that large numbers of the conversions were genuine, or that the system of evangelizing, in the hands of earnest and sincere men, has been productive of great

benefit to humanity; but, on the other hand, it is impossible to doubt that grave abuses have appeared in connection with it. Such purely physical phenomena as swoons, outcries, and convulsions were confounded with spiritual experiences. These are now known to belong to the domain of pathology, and to indicate a psychophysical condition, often met with elsewhere in the history of religion and of civilization.

BIBLIOGRAPHY. Duncan, *History of Revivals of Religion in the British Isles* (London, 1840); Tracy, *The Great Awakening* (Boston, 1842); Porter, *Letters on Religious Revivals* (New York, 1850); Bacon, *History of American Christianity* (ib., 1897); Walker, *Aspects of Religious Life in New England* (ib., 1897); Starbuck, *Psychology of Religion* (London, 1900); James, *Varieties of Religious Experience* (ib., 1902).

REVOCATION (Lat. *revocatio*, from *revocare*, to revoke, recall, from *re-*, back again, anew + *vocare*, to call). In law, the annulling, vacating, or cancellation of a legal instrument with intent to make it null and void in effect, or the withdrawal of an authority previously conferred. Where an instrument is made in good faith, and without wrongfully affecting the rights of third parties, it is generally held to be irrevocable, if it conveys property or rights to some one who pays for the same or accepts them as a gift. Powers not coupled with an interest in the donee are revocable.

REVOLT OF ISLAM, THE. A poem by Shelley (1818). The original title was *Laon and Cythna*, the names of the chief characters of the story, telling of a nation roused to freedom by a young poet. His triumph is brief, for the hero, Laon, is condemned to be burnt, and his martyrdom is shared by Cythna. The regeneration of society, an echo of the French Revolution, is the leading idea.

REVOLUTION (Lat. *revolutio*, from *revolvere*, to turn over, from *re-*, back again, anew + *volvere*, to turn; connected with Goth. *walwjan*, AS. *walcean*, Eng. *wallow*). In politics, a radical change in the fundamental constitution of a State, as opposed to reform, which implies a gradual transformation carried out in accordance with established principles and through legal forms. Usually, though not of necessity, it connotes a popular upheaval in which the will of the masses replaces for the time all laws and authority. The history of every nation presents instances where the organic growth of years and centuries has within a brief space of time been altered or destroyed by a people that has lost faith in the efficacy of orderly evolution. The English Revolution of the seventeenth century once for all established the rights of the nation as against its ruler. The American Revolution, so called, freed the united English colonies on the Atlantic seaboard of North America from the sovereignty of the English Crown and made them free and independent States. The French Revolution of 1789 overthrew the Bourbon monarchy and after three generations of sequential struggles brought in the sovereignty of the French people. It produced a profound effect on the constitution of society and the relation of peoples and sovereigns throughout Europe. On the technical aspect of revolutions in the science of politics, consult: Locke,

Essay on Government; Burgess, *Political Science and Comparative Constitutional Law* (2 vols., Boston, 1896). On its historical aspects, see the history of different nations. See also Lilly, *A Century of Revolution* (London, 1890).

REVOLUTIONARY TRIBUNAL. The name given to the court for the trial of political offenses instituted by the French Convention on the night of March 10, 1793. The name was proposed by Cambacérès. Danton and his associates considered that such a court had become necessary, inasmuch as the disasters which had befallen the national armies on the frontiers had led to dangerous conspiracies against the revolutionary Government. Its members were chosen from the various departments, and their appointment was ratified by the Convention. Their function was to sit in judgment on all persons accused of crimes against the State, and from their sentence, delivered with appalling promptitude, there was no appeal. During the Reign of Terror, when Fouquier-Tinville (q.v.) was the public prosecutor, this tribunal acquired a fearful notoriety by doing away with almost all forms of justice, and making itself the willing instrument of the Committee of Public Safety. After several changes in organization, the Revolutionary Tribunal was finally abolished, May 31, 1795. See FRENCH REVOLUTION.

REVOLUTIONARY WAR. See UNITED STATES.

REVOLVER, MILITARY. The military revolver is a weapon of much disputed value, as is shown by its varying relative importance in the armies of the world. It has, perhaps, found a greater sphere of usefulness in the United States cavalry than with any other troops in the world. The ordinary range of usefulness of the service revolver—if judged by the sighting of those now in general use—is practically limited to 50 yards, the weapon itself being required to be strong enough to stop a man, and if possible a horse. The responsible authorities of the great military powers remain officially faithful to revolvers of over .40 calibre, and bullets of from 180 to 313 grains; although their officers are often supplied, or supply themselves, with lighter and less bulky weapons of reduced calibre. This is especially true of British officers. The United States Colt, calibre .38, fires a bullet lighter by nearly 30 grains than that of any other power, with the exception of those used by the Swiss dismounted officers, French officers, and the revolvers of the new Russian model. Its cylinder contains six chambers, and in order to facilitate the loading of cartridges and the simultaneous ejection of the emptied shells the cylinder is mounted upon a crane pivoted in the frame below the cylinder, so that on drawing the cylinder latch to the rear the cylinder swings to the left and downward out of its seat in the frame. Thus, all the chambers are exposed for loading, while the pressure against the end of the ejector rod under the barrel forces out the shells. This done, the cylinder is returned to its position in the frame and is automatically secured by the cylinder latch. One of the most important American revolvers is the *Smith and Wesson*. Formerly, Smith and Wesson revolvers were constructed in calibres from .22 to .45, but about the year 1890 the .22 calibre was discon-

tinued. These revolvers are equipped with an automatic shell ejector, so that when the revolver is opened by its clasp the barrel and cylinders tip downward, an action which simultaneously ejects the empty shells. This mechanism is one of the most important inventions ever made in connection with revolvers, and has been adopted by practically all the revolver manufacturers throughout the world, since the patents covering the invention expired. The Army Model Number 3, made by Smith and Wesson, weighs 2½ pounds, is central fire, with a calibre of .44. It takes six cartridges and has a length of barrel of 6½ inches.

All American pistols and revolvers use metallic cartridges. Although it is conceded that if loaded a certain way the breech-loading revolver has no advantage over the muzzle-loader, and even though it is admitted that the muzzle-loading pistol charged as are dueling pistols gives better results than a breech-loading pistol of the same weight, length of barrel, and bore, loaded with a factory metallic cartridge, yet, owing to the great amount of labor necessary to load them, they are, as a rule, unpopular with pistol-shots, and naturally are out of the question for military purposes. The mark IV, .445 service model revolver of the Webley and Scott Revolver Company was adopted in 1893 by a joint War Office and Admiralty committee for the exclusive use of the British Army and Navy, as well as the Indian and Colonial forces. It weighs 2 pounds 3 ounces, and has a 4-inch barrel. The cylinder may be locked or free as desired, a good feature of the weapon being its combination of the trigger action with the cocking action. As already stated, the British officer selects and purchases his own weapon, and since the advent of the automatic pistol a general need was felt for a revolver which should be capable of approaching the rapidity of fire of the automatic pistol. Since 1901 the Webley-Fosbery revolver has made its appearance, and has the great advantage of taking the regular service ammunition. See PISTOL; and Plate of PISTOLS AND REVOLVERS.

REVUE DES DEUX MONDES, *revu' dâ dē mônd* (Fr., Review of the two Worlds). The most important French magazine, founded in 1831 by F. Buloz, and now conducted by Brunetière. It is a bi-monthly and numbers among its contributors the leading French writers in literature, art, politics, and history.

REWA KANTHA, *rā'wâ kân'thâ*. A collection of 61 native States, constituting a British political agency, in the Gujarat division of Bombay, India. The combined area is 4980 square miles, and the population in 1901 was 478,889 having fallen off from 733,506 in 1891.

REWARD (OF, *rewarder, reswarder, regard-er, regarder, to regard, from re-, back + warder, garder, to watch, mark, heed, guard, from OHG. warden, Ger. warten, AS. wærdian, Eng. ward; connected ultimately with Gk. ὥρα, horan, to see*). A compensation or premium offered by a government or a private individual to the public in general for the performance of a particular act specified therein. In England, statutes forbid the offering or receiving of a reward for the return of stolen property under conditions protecting or sheltering the thief. In the United States compounding a felony is a crime, but the English

statute prohibiting the receiving back of property believed to have been stolen, without investigation, is not generally followed. The offer of a reward may be made verbally, by writing, or in the newspapers, and when made to the public indefinitely, may be accepted by any one who may see the offer. The various States differ as to whether one performing the service without having seen the offer is entitled to the reward. Where the offer of a reward is made in the newspapers, it may be withdrawn or revoked in the same way, and one who saw the offer, but did not see the revocation and performed the service called for, is not entitled to recover. The general principles of contracts govern, and the performance of the service requested completes a unilateral contract, on which an action can be maintained. One who goes to great trouble and expense to get the desired information, but does not succeed in doing so until after the offer is revoked, is without remedy. A police officer cannot recover a reward offered for the detection of a criminal, if his efforts were in the line of his duties; but if his services were not in any sense official, and were performed in his leisure time, he may claim such a reward just as any other individual could do. Consult the authorities referred to under CONTRACT.

REWARI, or **RIWARI**, rē'wā-rē'. The chief commercial town of the District of Gurgaon, Punjab, British India, 48 miles southwest of Delhi, at the junction of two railways (Map: India, C 3). It has a fine town hall, handsome Jain temples, and the interesting ruins of the fort of Gokulgarh. It is an important grain-distributing centre; sugar and salt are also exported, and great quantities of iron are imported for manufacturing purposes. Rewari dates from about n.c. 1000, when it was built near the site of an older town, ruins of which exist on the east. Population, in 1891, 27,900; in 1901, 27,300.

REWBELL, rē'bēl'. **JEAN FRANÇOIS** (1747-1807). A French politician, born at Colmar, Alsace. He practiced law, became president of the corporation of advocates, was elected as a Deputy of the Third Estate to the States-General for the District of Colmar, and in the National Assembly became known for his knowledge of jurisprudence, his bold Republicanism, and his denunciations of Royalist conspiracies. In 1791 he became president of the Assembly, afterwards was general secretary to the directory of Haut-Rhin, and in 1792 was elected to the Convention. He was an opponent of the Jacobin Club, to whose suppression in November, 1794, he greatly contributed; was a member of the Committee of Public Safety and was elected to the Council of Five Hundred. In November of 1795 he became a member of the Directory, in which he exercised great influence on matters of finance and justice. He was elected president of the Directory in 1796, and was chosen by lot to retire in May, 1799. He sat in the Council of Ancients, but after the coup d'état of the Eighteenth Brumaire (November 9, 1799) withdrew from public life. Consult the standard works on the French Revolution, and Sciout, *Le Directoire* (4 vols., Paris, 1895-97).

REYBAUD, rā'bō'. **LOUIS** (1799-1879). A French author and politician, born at Marseilles. He entered journalistic work, and settled in Paris

in 1829. Besides editing a *Histoire scientifique et militaire de l'expédition française en Egypte* (10 vols., 1830-36), he published *Etudes sur les réformateurs ou socialistes modernes* (1840), which won the Montyon prize; a satirical romance, entitled *Jérôme Paturot à la recherche d'une position sociale* (1843); and a satire on Revolutionary ideas, *Jérôme Paturot à la recherche de la meilleure des républiques* (1848).

REYER, rā'yār', **LOUIS ETIENNE-ERNEST** (1823—). A composer of the modern French school. His real name was Rey. He was educated in the municipal schools. In 1850 he produced *Le Sélam*, a symphonic ode with chorus, set to a poem by Théophile Gautier. Several operas followed, one of the most conspicuously successful being *La Statue* (1861). He was elected to the Académie in 1876, and about the same time succeeded Berlioz as librarian at the Paris Opéra. Meanwhile he gained considerable reputation as a feuilletoniste on the *Journal des Débats*, and through his essays published in 1875 under the collective title of *Notes de musique*. In 1862 he was made a chevalier of the Legion of Honor, and he became an officer of that order in 1886. His compositions include: operas, *Maître Wolfgram* (1854), *Sacountal* (1858), *Erostrate* (1862), *Sigurd* (1884), *Salammô* (1890); cantatas, *Victoire* (1859), *L'Union des arts* (1862), *L'Hymne dur Rhin*; and male choruses.

REYKJAVIK, rik'yá-vék'. The capital of Iceland, situated on the southwest coast of the island at the head of the Faxa Fjörður (Map: Denmark, F 1). It consists chiefly of wooden houses, and has a small cathedral, a classical college, a theological seminary, and a medical school. In the house of the Althing are a library and a collection of Icelandic antiquities. During the summer there is steam communication with Copenhagen. Population, in 1901, 6682.

REYNARD (rā'nērd) **THE FOX**. The greatest mediæval beast epic, in which animals become the mouth-pieces of human society. Versions of this epic are found in the chief languages of Western Europe. The narrative is made up of stories derived from European folk-lore and of more or less literary survivals of the Æsopic fable. Though the first extant signs of the epic date back to 940 (*Ecbasis Captivi*), the various elements of the tale did not group themselves into a whole until the twelfth century. In the Latin *Isegrimus*, which is, however, mainly of literary origin, the animals already have specific names. The principal character is Reynard (from the Germanic Raginohard, meaning 'the wily, the crafty one')—the fox, whose deadly enemy is Isegrim (probably German *eisen* and *grimm*, signifying 'strength,' 'endurance')—the wolf. About these two and their bitter feud are found grouped: Noble the lion, Bruin the bear, Tibert the cat, Baldwin the ass, Chanticleer the cock, Kyward the hare, etc. The fact that *Isegrim* was used in 1112 as the epithet of a man (one of the conspirators against Gaudry, Bishop of Laon) shows that the tale was popularly current at an early date. The French *Roman de Renard*, a lost version of which was probably the source of most of the other European versions, is a cycle of episodes in octosyllabic verse, compiled by various authors at various epochs. The narrative is there divided into 'branches,' thirty in number;

which together constitute over 30,000 verses. The oldest manuscript of this compilation is of the end of the thirteenth century, but we have a German poem of the twelfth century, modeled on an earlier version of the same French work. Various 'Trouveres' attempted to give shape to this material, though the romance never attained genuine unity. The names of three alone of these compilers have been handed down: Pierre de Saint Cloud, Richard de Lison, and a clerk who called himself *Prestre de la Croix en Brie*. These names indicate that the Ile de France, Champagne, Normandy, and Flanders are the localities where the various parts of the poem took shape. The gist of the tale, in this completed form, is that the Fox has given offense to the Wolf and to several other animals, for which reason he is called before the court of justice held by the Lion. At first he refuses to come and through trickery rids himself of those sent after him. Finally, when forced to appear, he pretends repentance and is pardoned by the Lion. The offense, however, is repeated in a different form and again the Fox goes free. At last the Wolf in despair challenges him to single combat. Here again the craft of the Fox gains a complete victory, which ends in his being recognized as the real master of beasts.

In the fourteenth century the story was again taken up and given a number of remodelings on French soil; chief among these are *Renart le Nouvel*, by Jacquemard Gelée, and the famous *Renart le Contrefaite*, by an unknown clerk of Troyes. Here the romance has become a veritable compendium of moral, historical, and political ideas expounded by Reynard in conversation.

The romance was very popular in foreign lands. It was translated into Middle High German in 1180 by the minnesinger Heinrich der Glicheære; it was imitated in Catalonia by Raymond Lulle and given an English form (published by Caxton) and a Flemish form. Goethe modernized the German version in his *Reinecke Fuchs* (translated by T. J. Arnold). Mediæval art delighted in depicting scenes from the *Renard*.

For a detailed bibliography, consult: Ernest Martin, *Le roman de Renart* (Strassburg-Paris, 1882-87), and Potvin, *Le roman du Renard* (Paris, 1891). The best edition of the French version is that of Martin, *op. cit.*; the German *Reinhart Fuchs* is edited by Reissinger (Halle, 1886), the Flemish verse version *Reinaert de Vos*, by Van Helten (Groningen, 1887), and Caxton's English version is edited by Thoms, Percy Society (London, 1844). For questions of sources, etc., consult: Sudre, *Les sources du roman de Renart* (Paris, 1893); id., in *Petit de Julleville, Histoire de la langue et de la littérature française*, vol. ii. (Paris, 1896); G. Paris, *Le roman de Renard* (ib., 1895); F. S. Ellis, *History of Reynard the Fox* (London, 1894); and T. Jacobs, *Reynard the Fox* (ib., 1895).

REYNAUD, řá'no', JEAN ERNEST (1806-63). A French philosopher and author, born at Lyons. He was at first a mining engineer, but came into public notice as an opponent of Saint-Simonism, his previous creed, in a series of articles in the *Revue encyclopédique*. His chief works, *Terre et ciel* (1854), is a résumé of the ideas he had already set forth in the *Encyclopédie nouvelle*, which he and M. Pierre Leroux had founded in 1835, and he published also *Minéralogie des gens du monde*

(1834); *Considérations sur l'esprit de la Gaule* (1847); *Vie et correspondance de Merlin de Thionville* (1860); and *Etudes encyclopédiques* (1866).

REYNOLDS, řen'oldz, GEORGE WILLIAM MAC-ARTHUR (1814-79). An English politician and author. He was educated at the Royal Military College at Sandhurst (1828-30). Disliking the prospect of a military career, he left before completing his studies and traveled on the Continent, acquiring a wide knowledge of the most modern French literature. *The Youthful Impostor* (1835), his first novel, was followed by a volume of translations from Hugo (1836), and by two volumes of essays entitled *Modern Literature of France* (1839). In 1846 he became editor of the *London Journal*, for which he wrote *The Mysteries of London* in imitation of Eugène Sue's *Mysteries of Paris*. In the same year he started *Reynolds's Miscellany*, to which he contributed during the twenty-three years of its life many sensational tales. He took a leading part in the Chartist movement and was one of the last to abandon its cause. In 1850 he started the still existing *Reynolds's Weekly Newspaper*, an organ of the laboring classes.

REYNOLDS, HENRY ROBERT (1825-96). An English Congregational minister, born at Romsey, Hampshire. He studied at Coward College and at the London University (1841), and five years afterwards was ordained to the charge of a church at Halstead, Essex, but continued his studies, and graduated in 1848. His second pastorate was in Leeds (1849), with intervals of Continental travel until he became president of Cheshunt College (1860-94). He was associate editor of the *British Quarterly Review* in 1866-74, edited the *Evangelical Magazine* in 1877-82, and published: *The Philosophy of Prayer* (1881); *Buddhism* (1886); and *Athanasius* (1889).

REYNOLDS, JAMES EMERSON (1844-). An Irish chemist, born in Booterstown, County Dublin, and educated at Dublin University. He was chosen professor of chemistry to the Royal Dublin Society in 1870, to the Royal Irish College of Surgeons in 1873, and in Dublin University in 1875. Reynolds discovered thiocarbamide and many other compounds of the same class, and published *Lectures on Experimental Chemistry* (1874) and *General Experimental Chemistry* (1880).

REYNOLDS, JOHN. See RAINOLDS, JOHN.

REYNOLDS, JOHN FULTON (1820-63). An American soldier, born at Lancaster, Pa. He graduated at West Point in 1841, was assigned as brevet lieutenant to the artillery, and during the Mexican War participated in the defense of Fort Brown and the battles of Monterey and Buena Vista. At the outbreak of the Civil War he was commandant at West Point. He was commissioned brigadier-general of volunteers in August, 1861, and was given a brigade of the Pennsylvania Reserve Corps before Washington. The next year he took part in both the Peninsula and Northern Virginia campaigns, and during the succeeding Maryland campaign commanded the Pennsylvania Volunteer Militia for the defense of his native State. In November he was given the command of the First Corps of the Army of the Potomac and was promoted to be major-general of volunteers. He took part in Meade's at-

tack on the Confederate left at Fredericksburg, and at Gettysburg arrived on the field about two hours after the fighting had begun on the first day of the battle and was in chief command on the field until late in the morning (July 1st), when he was shot and instantly killed by a Confederate sharp-shooter.

REYNOLDS, JOHN HAMILTON (1796-1852). An English poet, born at Shrewsbury, Shropshire. After a secondary education, he entered in a minor capacity an insurance office, and in 1814 published two books of verse, *Sadie, an Eastern Tale*, inscribed to and qualifiedly praised by Byron, of whose manner it was a frank imitation; and *The Eden of Imagination*, in the style of Wordsworth and Hunt. In 1818 he obtained a post in a solicitor's office, and in the year following published a moderately skillful parody of Wordsworth's style a poem called *Peter Bell* (thus antedating the actual publication of Wordsworth's poem of the name). He was at one time a proprietor of the *Athenaeum*, and about 1638 removed to the Isle of Wight, where he was clerk of the county court. His best work is to be found in *The Garden of Florence, and Other Poems* (1821).

REYNOLDS, JOSEPH JONES (1822-99). An American soldier, born at Flemingsburg, Ky. He graduated at West Point in 1843, was brevetted second lieutenant of artillery, and from 1846 to 1855 was a member of the faculty at the Military Academy. In 1857 he resigned and became professor of mechanics and engineering at Washington University, Saint Louis, but three years later gave up this position to become a merchant at Lafayette, Ind. At the outbreak of the Civil War he entered the Federal service as colonel of the Tenth Indiana Volunteers and a month later was commissioned brigadier-general of United States Volunteers. In January, 1862, he again resigned, in August was again commissioned colonel, and in September was again promoted to brigadier-general. In November he was advanced to be major-general, and in 1863 participated in the battles of Chickamauga and Chattanooga. From January 6 to June 16, 1864, he commanded the defenses of New Orleans. He was mustered out of the volunteer service in 1866, and was reappointed colonel of the Twenty-sixth Regular Infantry. A year later he was brevetted major-general and in 1877 retired from active service.

REYNOLDS, SIR JOSHUA (1723-92). The most celebrated English portrait painter. He was born at Plympton, Devonshire, July 16, 1723. His father was the Rev. Samuel Reynolds, rector of Plympton, Saint Mary, and master of the grammar school. He intended his son for the medical profession, but Joshua, having manifested from an early age an ardent desire to be a painter, was, in 1741, placed under Hudson, the principal portrait painter of the day. After being in the studio of this artist two years he commenced on his own account as a portrait painter at Plymouth Dock, now Devonport, and met with great encouragement. In 1745 he went to London and established himself in Saint Martin's Lane; but on the death of his father in 1746 he returned to Plymouth Dock. Upon the invitation of Commodore Keppel, who was in command of the Mediterranean squadron, he sailed for Italy from Plymouth in 1749, and on his arrival in Leghorn,

proceeded to Rome. He stayed about three years in Italy, most diligently employing his time in visiting the various cities where the chief art collections are to be found. Upon his return to London in 1752 his works attracted great attention, eclipsing everything that had been done there since Van Dyck's time. When the Royal Academy was instituted in 1768 he was elected president; he was knighted by George III., and on Ramsay's death in 1784 succeeded him as painter to the King. He founded the Literary Club (1764) for Dr. Johnson's benefit. To him Goldsmith dedicated his *Deserted Village*. He died in his palatial house in Leicester Square on February 23, 1792, and after lying in state at the Royal Academy, was interred in the crypt of Saint Paul's.

Sir Joshua was very prominent in the social world and lived in friendly intercourse with Johnson, Burke, Goldsmith, Gibbon, Garrick, and other leading men of his period. His principal literary works consist of fifteen *Discourses Before the Royal Academy* (1778), treatises on the history of art of a high critical and artistic value. They are written in a precise, good style, and inculcate those maxims of art commonly known as academic.

The formative influence in Reynolds's art was the great Italian masters, especially the Venetians, Correggio, the Bolognese Eclectics, and Michelangelo. He was much of an eclectic himself, and there was little that was strikingly original about his work. His composition and brush work were learned, but his drawing, especially of the limbs, was often faulty. The strong point of his paintings was their color, showing the influence of Titian; but Sir Joshua's technical experiments had a disastrous result upon their preservation. His portraits are admirable realistic representations; the men are strong in action and character, the women gentle and pure, the children innocent and natural. They form an epitome of London society of his day.

He is estimated to have painted from two to three thousand portraits, most of which are in English private collections. The National Gallery, however, possesses a number of his best works, including those of Admiral Keppel, Lord Heathfield, the Hero of Gibraltar, Goldsmith, Dr. Johnson, Garrick, the members of the Dilettante Society, and three portraits of himself. The National Portrait Gallery (London) and the Royal Academy are rich in his works, as are also the London private galleries and the University of Oxford. Especially worthy of mention are the portraits of Lady Cockburn and her children, the Duchess of Devonshire (Devonshire House), Nelly O'Brien (Hertford House), and "Mrs. Siddons as the Tragic Muse" (Dulwich Gallery).

Although Sir Joshua preferred historical painting, his works of this character are less important. There are good examples in the Hermitage Collection, Saint Petersburg, including the "Continence of Scipio;" the best, perhaps, is "Ugolino and His Sons in the Tower." Among his few genre pictures are the "Girl with the Mouse-trap" (Holland House), and the "Strawberry Girl." His beautiful and well-known "Angels' Heads" (National Gallery) are in reality portrait studies. There are also good examples of Reynolds's work in the principal American collections.

BIBLIOGRAPHY. The older biographies of Rey-

nolds, those of Malone (1798), Northcote (1813), Farrington (1819), Beeche (1835), and Cotton (1856), have been superseded by the comprehensive *Life* by Tom Taylor (London, 1865), which also includes the researches of Leslie. Other good biographies are those of Chesnan (Paris, 1887), Phillips (London, 1893), and Gower (ib., 1902).

REZONVILLE, re-zôn'vel'. A village of German Lorraine, 10 miles west-southwest of Metz and 2 miles southwest of Gravelotte. The battle of Gravelotte (q.v.) is sometimes called the battle of Rezonville.

RHACHITIS, rá-kí'tis. See RICKETS.

RHAD'AMAN'THUS (Lat., from Gk. ῥαδάμανθος). In Greek legend, a son of Zeus and Europa, and brother of Minos (q.v.). In Homer and the older epic, Rhadamanthus is a hero, who by special favor of the gods has been translated, with others, to Elysium or the Islands of the Blest. In later story these islands become the kingdom of Cronos and the released Titans, and Rhadamanthus, married to Alcmene, mother of Hercules, holds high rank and sits as judge. Another conception of the other world prevailed later, in which Rhadamanthus, with Minos, Æacus, and Triptolemus, because of their justice in this life, sit in judgment on the souls of the dead, and assign them their due meed of bliss or punishment.

RHADAMES, rád'a-méz. An oasis and town in North Africa. See GADAMES.

RHÆTIA, rē'shí-à, or better, **RÆTIA**. A Roman province lying in the Alps, north of Italy and east of Helvetia, and bounded north by Germany and east by Noricum, thus embracing the Grisons and part of Tyrol. It was watered by the Rhine, Athesis (Ádige), and Ænus (Inn). The natives were chiefly engaged in herding sheep and cattle. They were a hardy and warlike race, but were conquered about B.C. 15 by the Romans under Tiberius and Drusus. Later Vindelicia, to the north, was united with Rætia. The chief town of Rætia proper was Tridentum (Trent); and of Vindelicia, Augusta Vindelicorum (Augsburg).

RHÆTIC BEDS. A series of strata forming the uppermost portion of the Triassic system, which is extensively developed in the Rætian Alps.

RHAMNACEÆ (Neo-Lat. nom. pl., from Lat. *rhamnos*, from Gk. ῥάμνος, buckthorn, Christ's-thorn), **BUCKTHORN FAMILY**. A natural order of about 40 genera and 500 species of dicotyledonous, often spiny trees or shrubs, natives of and widely distributed in temperate and tropical countries. They have simple leaves; small, generally green flowers; and either fleshy fruit, not opening when ripe, or dry and separating into three parts. Some species have been used in dyeing (buckthorn), some in medicine (red root), and the fruit of some for food. (See **JUJUBE**.) The sweet red pulp of the thickened flower stalks of *Hovenia dulcis*, a native of China and Japan, is edible. In flavor they resemble the pear. The chief genera are *Rhamnus*, *Ceanothus*, *Zizyphus*, *Hovenia*, *Phytica*, and *Gouania*.

RHAMNUS. A genus of shrubs and trees. See **BUCKTHORN**.

RHAMPHORHYNCHUS, rám'fó-rín'kūs (Neo-Lat., from Gk. ῥάμφος, *rhamphos*, curved

beak + ῥύγχος, *rhyngchos*, snout). A fossil flying reptile of Upper Jurassic age. See **PTERODACTYL**.

RHAMPHOSUCHUS, rám'fó-sū'kūs (Neo-Lat., from Gk. ῥάμφος, *rhamphos*, curved beak + σείχος, *souchos*, crocodile). One of the largest fossil crocodiles, known by fragmentary bones found in the Pliocene deposits of the Siwalik hills of India. The animal must have attained a length over all of about 50 feet.

RHAMPSINITUS (Lat., from Gk. Ῥαμψινίτης). A King of Egypt, the subject of a remarkable tale related by Herodotus. According to the Greek historian, Rhampsinitus possessed enormous wealth, and wishing to store it securely, caused a treasure house of stone to be built. The architect who constructed the building left a secret entrance concealed by a movable stone, and on his death bed informed his two sons of the fact. The sons repeatedly entered the treasury, and each time carried away as much of the treasure as they were able. Finally, the elder brother falls into a trap set by the King, and the younger brother, at his request, cuts off and carries away his head that he may not be recognized. The headless body is exposed, guarded by soldiers, but the younger brother, by a clever stratagem, makes them drunk and obtains possession of it. The King then attempts to capture the thief by the aid of his daughter, who is ordered to receive all who desire to visit her, promising her love to him who can relate the most remarkable adventure experienced by himself. The thief visits the princess and tells her the story of the theft, but when she attempts to seize him he slips into her hands his dead brother's arm, which he has brought under his cloak, and makes his escape. Thereupon the King, admiring his cleverness, grants him immunity for his theft, and gives him his daughter in marriage. Rhampsinitus is to be identified with Rameses III., whose treasury at Medinet Habu is the building referred to in the story of the thief. The accounts of Herodotus are derived from the popular tales and legends which, in his time, were current in Egypt.

Consult: Herodotus, ii., 121-124; Wilkinson, *Manners and Customs of the Ancient Egyptians* (London, 1878); Clouston, *Popular Tales and Fictions* (Edinburgh, 1887); Budge, *A History of Egypt* (New York, 1902).

RHAPSODISTS (from Gk. ῥαψῳδός, *rhapsōdos*, bard, from ῥάπτειν, *rhaptein*, to stitch together + ᾠδή, *ōdē*, song, from ἄδειν, *adēin*, to sing). A name applied in ancient Greece to professional reciters of poetry, and especially to a class of wandering minstrels who recited the Homeric poems. So long as the Homeric lays were handed down by oral transmission, the rhapsodists were a highly respected class, and there can be little doubt that they often exercised a considerable influence upon the text of the poems. But with the commission of the poems to writing and the circulation of manuscript copies, the character of the rhapsodists gradually changed, so that in the fourth century they are represented as stupid persons, with nothing to commend them but a retentive memory. Their recitations, however, continued to be popular until a comparatively late period. The rhapsodist carried a staff, and when reciting wore a crown as a mark of his office. He did not confine himself to mere recitation, but commented upon the poet's meaning and discussed questions of interpretation.

Each recitation was known as a 'rhapsody,' and hence this term is often applied to the separate books of the *Iliad* and the *Odyssey*. The most important source of information concerning the rhapsodists is Plato's *Ion*.

RHAPSODY (Lat. *rhapsodia*, from Gk. *ῥαψωδία*, recital of poetry, portion of an epic recited at one time, from *ῥαψωδός*, *rhapsódos*, bard). A term in modern music, applied to an instrumental composition written in the form of a fantasia usually upon folk-songs or national melodies. The rhapsodies of Raff and Lalo, and especially the Hungarian rhapsodies of Liszt, have become famous.

RHATANY (Brazilian, Port. *ratanhia*, from Quichua *ratana*, the native name), or **RATANY**, *Krameria triandra* and *Krameria Ixina*. Half-shrubby plants of the natural order Polygalaceae, natives of the cold sterile tablelands of the Andes in Peru and Bolivia. Their roots have been used medicinally as an astringent and tonic. When powdered and mixed with orris root or charcoal the roots are used as a tooth-powder. Rhatany root is exported chiefly from Lima, Peru. It is extensively employed in Portugal to color wines, the coloring matter in the roots being known as rhatanic acid.

RHAZES. The Latin name of **ABU BEKR MOHAMMED IBN ZAKARIYA AL-RAZI**. The most important of the mediæval Mohammedan physicians. He was born about the middle of the ninth century in the Persian city of Rai. Up to his thirtieth year he devoted himself to music, and then took up the study of medicine at Bagdad. He became the head of a hospital at his native place and later at Bagdad. After his reputation was made he traveled, visiting different courts. He died either in 923 or 932. Much of Rhazes's knowledge was drawn from Greek sources, but he was more than a mere borrower and is famed as the first to describe smallpox and measles (in his book *Al-jardari ical-hasba*, several times translated into Latin, and into English by Greenhill, London, 1848). He is said to have written more than two hundred works; the most famous was the *Kitâb al-tibb al-Manşûri*, a general treatise on medicine in 10 books. The *Kitâb al-hâwi (liber continentis)*, a cyclopædia of medicine, was edited from his papers after his death. Both these works were translated into Latin in the fifteenth century. Consult: Wüstenfeld, *Geschichte der arabischen Aerzte und Naturforscher* (Göttingen, 1840); Leclerc, *Histoire de la médecine arabe* (Paris, 1876).

RHEA (Lat., from Gk. 'Ρέα). A Greek goddess representing the productiveness of nature and anciently identified with Cybele. She was the daughter of Uranus and Gæa, wife of her brother Cronus, and mother of Zeus, Hades, Poseidon, Hera, Hestia, and Demeter. She had an ancient place of worship in Crete, where she gave birth to Zeus on Mount Ida.

RHEA, or **REA SILVIA**. In Roman tradition, a Vestal virgin, the daughter of the Alban Numitor, and mother of Romulus and Remus, by Mars. When Amulius usurped the throne, the infants were exposed and Rhea Silvia was condemned to be buried alive for breaking the vow of chastity required of the Vestals. She was also called Ilia.

RHEA (Lat., from Gk. 'Ρέα, daughter of Uranus and Gæa). The generic and English name of a family of South American ratite birds allied to the ostrich, from which they differ in having the feet three-toed, and each toe armed with a claw; also in being more completely feathered on the head and neck; in having no tail; and in having the wings better developed and plumed, and terminated by a hooked spur. The wings are, indeed, more efficient than in any other of the Ratitæ, although unfit for flight.

Rheas are known to Brazilians as 'ema' and to Argentines as 'nandu,' 'avestruz,' or 'chueke.' There are two species, of which the best known (*Rhea Americana*) is considerably smaller than the ostrich, standing about three feet high. It is uniform gray, except on the back, which has a brown tint. The male is larger and darker



NANDU (*Rhea Americana*).

colored than the female. The back and rump are furnished with long feathers, much inferior to those of the ostrich in beauty as plumes, but marketable as material for dust-brooms and the like. The skins are made up into rugs, of which large numbers are fabricated in the neighborhood of Mendoza, Argentina. The rhea inhabits the great grassy plains of South America, southward of the equator, and abounds on the banks of the La Plata and its more southern tributaries. It is generally seen in small troupes, usually associated with guanacos, and eating grass, seeds, berries (especially of *Empetrum*), worms, snails, and almost anything else it can swallow. It runs with great celerity, using its wings in aid. It is polygamous, one male securing possession of two or more females, which lay their eggs together in a mere hollow, where, when 20 or 30 are gathered, they are incubated by the cock.

A smaller and more recently discovered species (*Rhea Darwini*) has light brown plumage, each feather tipped with white. It inhabits Patagonia, and extends northward along the base of the Andes to the edge of Peru, and differs from the other in many particulars. A third species has been catalogued, but it is now considered a dark, local race (variety *Macrorhyncha*) in Northeastern Brazil of the ordinary nandu.

Excellent portraits and descriptions of the three forms may be found in the *Transactions* of the Zoölogical Society of London, vol. iv. (1862). Consult also: Darwin, *A Naturalist's Voyage* (London, 1860); Selater and Hudson, *Argentine Ornithology* (ib., 1889).

RHEA FIBRE. See RAMIE.

RHEGIUM, rē'ji-üm. The ancient name of a city of Magna Græcia, Italy, now known as Reggio di Calabria (q.v.).

RHEGIUS, rē'ji-üs (Latinized form of his family name, *Rieger*; the form *Regius*, as if from *König*, king, is incorrect), URBANUS (1489-1541). A Protestant Reformer. He was born at Lange-nargen, on Lake Constance, studied at Freiburg, and at first was professor of rhetoric and poetry at Ingolstadt; later he turned to theology, entered the priesthood of the Catholic Church, and became a doctor of theology at Basel. In 1520 his views underwent a change and while cathedral preacher at Augsburg he wrote satirical pieces against the Church and openly preached Lutheran views. In 1521 he was removed, but in 1524 was again preacher in Augsburg, and so remained till the diet held there in 1530. When the Emperor had silenced the evangelical preachers of the city, he entered the service of Ernest, Duke of Brunswick-Lüneburg, and removed to Celle, where he died. In the Eucharistic controversy he wavered, but finally decided for Lutheran views. His Latin works appeared at Nuremberg in 1561, three parts; his German in four parts, in 1562; again at Frankfort, 1577. Of these works the best known are: *Formulæ Caute Loquendi* (1535; in German, 1536; last ed. by Steinmetz, Cella, 1880); *Dialogue von der trostreichen Predigt* (1537), a devotional work much read even in the seventeenth century; *De Restitutione Regni Israelitici* (1536; Ger. trans.). Consult his *Life* by Uhlhorn (Elberfeld, 1861); and Steitz, *Die Theologie des Urbanus Regius, speziell sein Verhältnis zu Luther und zu Zwingli, 1521-23* (Gotha, 1898).

RHEIDT, rīt. A town of Prussia. See RHEYDT.

RHEIMS, or **REIMS**, rēmz, Fr. pron. rāns. The capital of an arrondissement in the Department of Marne, France, situated on the Vesle, 107 miles by rail east-northeast of Paris (Map: France, L 2). The vine-clad Montagne de Rheims and adjacent hills rise on the south and west, and detached forts at various points surround the city. The mediæval ramparts have been replaced by tree-lined boulevards, but some of the ancient gateways have been preserved, of which the most noteworthy is the Porte de Paris. The town is well built, the material used being limestone, of the district, which, with the prevalence of the older style of domestic architecture, gives the place a picturesque appearance. There are many quaint old houses. The most striking public building is the thirteenth-century cathedral, which, although it still lacks the towers of the original design, is one of the finest extant specimens of Gothic architecture. It is 453 feet long. The elaborate west façade has 500 statues and a splendid rose window, and is flanked by two towers. Scarcely less beautiful is the north portal, with its sculptures. The cathedral is famous as the church in which the French kings were crowned. The eleventh-century Romanesque Abbey Church of Saint Remy is of nearly equal

size. Other interesting buildings are the hospital occupying the ancient Abbey of Saint Remy, the fifteenth-century archiepiscopal palace with a museum of sculpture, and a handsome hôtel-de-ville, begun in 1627, containing the public museum and library of over 80,000 volumes. The Porta Martis, a Roman relic, is a fine triple triumphal arch of the fourth century in a fair state of preservation. The chief modern educational institution are the lyceum and a preparatory school of medicine and pharmacy. Rheims is one of the principal entrepôts for the wines of Champagne. It is a great centre of woolen manufactures.

Rheims is built on the site of *Durocortorum*, or *Civitas Remorum*, the capital of the Remi. On the Montagne de Rheims, south of the city, are a number of Gallo-Roman remains. Under the Frank rule Rheims was a place of much importance, and it acquired a religious interest from its having been the scene of the baptism of Clovis and his chief officers by the Bishop, Saint Remy, in 496. In the eighth century it became the seat of an archbishopric, and from 1179, in which year Philip Augustus was solemnly crowned there, it was the place for the coronation of the kings of France down to the time of Charles X. The town suffered severely during the campaign of 1814, and on September 4, 1870, was occupied by the Germans. Population, in 1901, 108,385. Consult: Marlot, *Histoire de Reims* (Rheims, 1843-45); Justinus, *Reims, la ville des sacres* (Paris, 1860); Gosset, *Cathédrale de Reims* (ib., 1894).

RHEINBABEN, GEORG, Baron von (1855—). A Prussian statesman, born at Frankfort-on-the-Oder. He studied law and political science at Heidelberg and Berlin, became referendary at the district court at Erfurt, in 1877, government assessor in Schleswig, in 1882, was appointed to an assistant position in the ministry of finance in 1885, and promoted rapidly to higher offices until, in 1896, he became president of the government-board at Düsseldorf. Made Prussian minister of state and secretary of the interior in 1899, he succeeded Miguel as minister of finance in 1901.

RHEINBERGER, rīn'bērk-ēr. JOSEPH (1839-1901). A German organist and composer, born in Vaduz, Liechtenstein. He received the greater part of his musical education at the Royal School of Music, Munich, where he subsequently taught the organ, counterpoint, and composition. He was organist of Saint Michael, conductor of the Oratorio Society, repititor at the Court Opera, and Court kapellmeister, and he was regarded as one of the greatest theory and organ teachers of his time. His music is essentially German in character, but somewhat too heavy to be popular. His organ sonatas and other compositions for that instrument are especial favorites in America. His compositions include: *Christophorus*, oratorio; *Toggenburg* and *Waldmorgen*, cantatas; *König Erich*, ballad for chorus with pianoforte; *Wittekind*, and *Das Thal des Espingo*, chorus; the *Wallenstein* and *Florentine* symphonies; overtures, pianoforte, chamber, organ, and orchestral music; and the operas *Die sieben Raben* (1896) and *Türners Tochterlein*.

RHEINE, rī'ne. A town in the Province of Westphalia, Prussia, on the Ems, at the head

of navigation, 24 miles by rail north-northwest of Münster (Map: Germany, B 2). It is known principally for its manufactures of cotton, jute, linen, tobacco, and machinery. Population, in 1900, 10,371.

RHEINFELS, rīn'fēls. The largest and one of the most beautiful of the ruined castles on the Rhine. It was built in 1245 by the Count of Katzenbogen, one of the petty barons of the Rhine. In modern times it was a strong Hessian fortress. In 1794 the French gained possession of it and blew it up in 1797. It is now the property of the Emperor of Germany.

RHEINGOLD, rīn'gōlt, DAS. The first division of Richard Wagner's music drama *Der Ring des Nibelungen*. It was first given in Munich, September 22, 1869. See RING OF THE NIBELUNGEN.

RHEINHOLD, rīn'hōlt, HUGO (1853—). A German sculptor, born at Oberlahnstein, Hesse-Nassau. For several years he pursued a mercantile career in San Francisco and in Hamburg, before devoting himself to art in Berlin, under Max Kruse, and at the Academy under Herter, with signal success, as proved by his marble group, "By the Wayside," in the National Gallery, Berlin, and the large group in bronze, "Dynamite in the Service of Civilization," at the Nobellhof, Hamburg.

RHENANUS, rā-nā'nūs, BEATUS (1485-1547). A German classical scholar, whose real name was Bild von Rheinau. He was born at Schlettstadt, Alsace, and after studying at the University of Paris, spent most of his life in his native city. He was an intimate friend of Erasmus. His works, which show great critical acumen, include editions of *Plini Epistolæ* (1514); *Tacitus* (1519); *Tertullian* (1521); and *Livius* (with Gelenius, 1535), the *editio princeps* of *Villojus Paterculius* (1522); and an historical work, *Rerum Germanicarum Libri Tres* (1531), which was considered the finest piece of historical research of his day. He was the first to question the authenticity of the *Dialogus* of *Tacitus*. Consult: Horowitz, *Beatus Rhenanus* (Vienna, 1872); *Des Beatus Rhenanus litterarische Thätigkeit* (ib., 1872); *Die Bibliothek und Korrespondenz des Beatus Rhenanus* (ib., 1874); and Knod, *Aus der Bibliothek des Beatus Rhenanus* (Leipzig, 1889).

RHENISH ARCHITECTURE. See ROMANESQUE ARCHITECTURE.

RHENISH CONFEDERATION. See CONFEDERATION OF THE RHINE.

RHENISH PRUSSIA. A province of Prussia. See RHINE PROVINCE.

RHENSE. A village of Prussia in the circle of Coblenz, on the Rhine, noted historically as the meeting-place of a diet, which, in July, 1338, during the struggle between the Emperors and the Papacy, took a firm stand for the former by declaring that whoever had received a majority of electoral votes was *ipso facto* German King and Holy Roman Emperor without further Papal confirmation.

RHEOTROPISM (from Gk. 'ρείν, *rhein*, to flow + τροπή, *tropē*, turn). The imperfectly understood sensitiveness which enables plant organs, especially roots, to bend their tips either toward or away from the source of a

current of water in which they are placed. Negative rheotropic curvatures are often merely gross mechanical effects of the force of the stream. But positive curvatures (i.e. toward the source) are undoubtedly due to a specific reaction on the part of the organ. Positive rheotropism of roots, is exhibited well by seedlings of the radish, maize, and *Vicia sativa*. To demonstrate this phenomenon seedlings with roots about 2 centimeters long need only to be affixed to the sides of an inclined wooden trough in which a current of water is flowing. In spite of the tendency of gravity and the force of the moving water to cause roots so immersed to grow downward, they will, after a few hours, bend up stream.

RHESUS (Lat., from Gk. 'Ρῆσος). (1) A Bithynian river god, son of Oceanus and Tethys. (2) A Thracian ally of the Trojans, of whom the oracle declared that if his white horses should drink the waters of the Xanthus or feed on the grass of the plain of Troy, the city would not be taken. As soon as Rhesus in his journey reached the Trojan territory, he was surprised and slain in his camp by Odysseus and Diomedes, and his horses were carried off.

RHESUS (from Lat. *Rhesus*, Gk. 'Ρῆσος, name of a river in the Troad, another in Bithynia, a King of Thrace, etc.). A small brown monkey (*Macacus rhesus*), common all over India. It is known as the Bengal monkey, or 'bandar' of the Hindus. It moves about in large bands, ascending to the height of 8500 feet in the Himalayas, and is often protected and fed in the neighborhood of temples, by the Hindu priests, although not universally regarded as sacred. This monkey is one of those most familiar in menageries, where it may be recognized by the straightness of its moderately long hair, by the tapering tail, about one-half the length of the head and body, and by the nakedness of the buttocks, for some distance around the callosities. This is the monkey commonly carried about by Hindu jugglers, who teach it amusing tricks; and many stories are told of its superior intelligence. Compare MACAQUE.

RHETORIC (Lat. *rhetorica*, from Gk. ῥητορικῆ, *rhētorikē*, rhetorical art, fem. sg. of ῥητορικός, *rhētorikos*, relating to an orator, from ῥήτωρ, *rhētōr*, orator; connected with εἶπειν, *erein*, to say, and ultimately with Eng. *word*). Taken broadly and philosophically, the science and art of communication in language, including all the processes and technical means by which, through language, the members of a community react one upon another. The general tendency of modern textbooks has been to broaden the scope of rhetoric to include everything pertaining to the art of composition, and even to annex adjoining territories, such as poetics, and stylistic and literary criticism. But although rhetoricians are still far from agreement, the goal of recent thought is fairly well expressed in the definition here given.

Regarded from the scientific point of view, rhetoric properly belongs to that branch of knowledge which is concerned with the relations of men in society. The place and rationale of the science may be indicated as follows. In every community a great variety of activities go on simultaneously. One important group of

these activities consists of all the processes by which, through a variety of media, men express themselves and convey their thoughts and feelings to their fellows. This group may be called the expressive-communicative group of activities. It includes not only the more primitive modes of thought-conveyance, such as gesture, grimace, picture writing, the histrionic dance, and the like, but also the most highly elaborated modes, such as the arts of architecture, sculpture, music, painting, and oral and written speech. This large class may be subdivided in two ways: (1) according to the medium employed in the process of thought-conveyance, and (2) accordingly as the emphasis is thrown upon the individual or the social phase of the process. The first method of classification leads to the differentiation of the several arts; the second to the distinction of processes mainly self-expressive from processes mainly communicative. The subject matter of rhetoric is thus seen to be distinguished from that of allied sciences by the fact (1) that its medium is language, and (2) that the emphasis is thrown upon the phase of communication; that is, upon prose. The proper subject matter of the science may therefore be summed up in the phrase 'Expression in language for communication's sake,' just as the proper subject matter of poetics may be summed up in the phrase 'Communication in language for expression's sake.' But it should not be forgotten that although rhetoric is the science of communication, it is still concerned to a large extent with questions of expression.

If we regard rhetoric as it has been outlined above, its underlying problem is seen to concern the reciprocal speech relations of the individual and the community. Of this problem there are three principal phases, as follows:

I. *Psychological problems* relating (1) to the nature of the writing or speaking man, (2) to the mental activities involved in the process of composing. Here arise questions regarding (a) the nature and genesis of expression, (b) the characteristics of genius, (c) the acquirement and cultivation of the speech habit, and (d) the factors operating in the experience of the individual to turn his self-expression into the communicative channel. The first of these questions has been treated at some length by Darwin in his *Expression of the Emotions*, and by those who have sought to controvert him; the second, by Lombroso and others; and the third, by many recent psychologists. The fourth is as yet practically unexplored. It is obvious, however, to touch upon it briefly, that every successful writer or speaker is on one side receptive, on the other productive. As receptive he is a product of heredity and of the social environment. Through imitation of his fellows, this native impulse results in the acquirement of the resources of language, and the individual thus develops a writing or speaking personality. On the other hand, as productive, the writer exhibits the faculties of invention and social imagination. He creates by combining old ideas in new ways that suit better the needs of his contemporaries. He has a sympathetic imagination, which enables him to penetrate into the minds of his hearers, to read their desires, and to conceive how his words will act upon them. His expression is thus, in a sense, drawn from him, and shaped, by his keen realization of

the needs of his hearers. He produces in order to satisfy these needs.

II. *Social problems*, relating to the dynamic effect of speech upon the community of hearers or readers. The assumption which underlies discussion of the subject from this point of view is that language is preëminently the social bond—the connective tissue by which society is held together in organized forms. The main questions relate (1) to the typical modes of response on the part of individuals and groups of individuals in the community, (2) to the formation of social or public opinion. Dially, *Psychology of the Aggregate Mind of an Audience*, has endeavored to show that the minds of an assemblage listening to a powerful speaker undergo a curious process called 'fusion,' by which the members of the audience, losing their individual traits, are reduced, as it were, to a single individual, whose characteristics are those of an impulsive youth of twenty, imbued in general with high ideals, but lacking in reasoning power and will. But it is important here to distinguish, as Tarde has done (*L'Opinion et la foule*), between a 'crowd' and a 'public,' the associative principle of the former being physical, of the latter psychological. The rise of printing, which enables communication of the same matter simultaneously to persons widely separated in space, tends to the formation of a true public, which is not 'fused,' but can freely exercise both reason and volition.

III. *Formal problems*, relating to the medium of communication, namely, language, or, more precisely, discourse, that is, language in organized form. The main problems concern: (1) the nature and origin of discourse; (2) the peculiar function of discourse as (a) on one side, the expression of the individual, and (b) on the other side, the means of social interchange; (3) the structure or morphology of discourse in (a) its minuter forms (words, phrases, sentences, paragraphs, figures, rhythms), (b) its larger forms (whole compositions), (c) its typical modes (description, narrative, exposition, argument, persuasion); and (4) the typical methods of distribution (books, newspapers, conversation, etc.). The formal aspect of rhetoric has been developed in considerable detail in ancient and modern treatises, but has not been consistently unified or properly connected with the other two phases. It has been the practice of rhetoricians to make certain postulates of a formal character, such as the principle of unity in variety, of symmetry, or of purity, and upon these, by a process of deductive reasoning, to build a structure of theory. Of all the principles that have been advanced to explain the structural side of rhetoric, that of organic unity is perhaps most fundamental, and from it may be derived all of the usual rhetorical qualities. But the truth is that all such principles are derivative, not primary. A truly scientific exposition would demonstrate that the peculiar forms and qualities of any piece of discourse are the natural outcome of the interaction of the individual and society in the process of communication. An oration, for example, is the product of two forces, (1) the impulse of the individual to a certain kind of self-expression, and (2) the demand of the social mind for a certain kind of communication. The oration is the meeting point of these two forces. It is the path of least resistance traced by the language of the orator in adapt-

ing his utterance to the hearers' needs and desires.

RHETORIC, FIGURES OF. A term popularly applied to a large and heterogeneous class of language-forms, all characterized by the fact that they are deviations from what is plain, literal, and straightforward. From ancient times figures have been regarded by rhetoricians as 'embellishments' of speech; that is, as conscious devices and ornaments. Figures are commonly said to give life, strength, and beauty to style, but it would perhaps be truer to say that they have the power of arousing in the reader or hearer the same emotional and imaginative processes which gave birth to them in the mind of the writer.

Since the conceivable modes of departure from literal statement are almost infinite in number, it is obvious that an exhaustive enumeration of figures is difficult, and a classification of them well nigh impossible. The ancients, for whom the subject had a peculiar fascination, enumerated as many as 250 distinct species, and although modern writers, generally speaking, have been less prodigal in their invention, the *Arto of Poesie*, attributed to Puttenham (1589), names and defines 107. In recent text-books the tendency is to limit the number to 10 or 12. The important figures are as follows:

I. FIGURES OF IMAGERY. These are figures which arouse concrete images in the mind of the hearer. (a) *Metaphor* is a form of expression in which one object is made to appear under the image of another which it resembles in some particular. Thus in the sentence, "The ice makes daggers at the sharpen'd eaves," icicles are presented to us under the image of daggers, which resemble them in shape and color. Sometimes a metaphor contains two images which fail to blend, as in "With swift rapier-thrusts of irony, the prosecuting attorney applied the thumbscrews to the unwilling witness." Such figurative jumbles are called mixed metaphors. Akin to the metaphor, though distinct as being a legitimate development of semasiology (q.v.), is catachresis, in which a word is extended in meaning beyond its strict sense, as 'a silver drinking-horn.' (b) An extended metaphor in narrative form is called *allegory*. Bunyan's *Pilgrim's Progress* is a famous example. A short, pointed allegory in which animals are represented as speaking and acting is called a fable. The brief allegories of the Bible are known as parables. (c) *Simile* differs from metaphor in that the resemblance between object and image which is assumed in metaphor is in the simile expressly stated by means of the word *like* or *as*. Thus "His face was a withered moon" is metaphor, but "All his face was white And colorless, and like the wither'd moon, Smote by the fresh beam of the springing east," is simile. (d) *Synecdoche* is a kind of metaphor in which the image is related to the object as a part to the whole, as the whole to a part, as genus to species, etc. Thus in "All hands on deck," *hands* is used for *men*. (e) In *metonymy* the image is an accompaniment of the object; that is, what contains it, stands for it, as, "The poorest man may in his cottage bid defiance to all the force of the Crown," the *Crown* standing for *the King*. Metonymy and synecdoche are, however, so nearly alike that the distinction is hardly worth preserving.

II. FIGURES OF ARRANGEMENT. In these figures, words, phrases, clauses, or sentences are disposed in some peculiar and striking way to correspond to peculiar sequences of thought. (a) *Climax* consists in the arrangement of words, clauses, or sentences in the order of their importance, the least forcible coming first and the others rising in importance until the last; as in this example: "It is an outrage to bind a Roman citizen; it is a crime to scourge him; it is almost parricide to kill him; but to crucify him—what shall I say of this?" (b) *Antithesis* occurs when corresponding parts of a sentence are so juxtaposed as to give force to contrasting ideas; as, "To err is human, to forgive divine." Both climax and antithesis may appear also in the arrangement of the larger units of composition, as paragraphs and complete essays, as well as in the smaller units of words, clauses, and sentences.

III. FIGURES OF CONTRADICTION. In these figures there is an apparent contradiction between the form of expression and the idea to be expressed. (a) In *irony* the speaker's words seem to convey one meaning, but in reality convey just the contrary, the real meaning being suggested by the tone of the voice or the implication of the words. (b) *Epigram* is a brief, pointed sentence. Talleyrand's saying, "Language was given to man to conceal his thoughts," is a good example of epigram. (c) In *hyperbole* an object is greatly exaggerated in size or importance, for impression on humorous effect; as, "Swifter than the winds and the wings of the lightning." Hyperbole may also be looked upon as a kind of metaphor. Of the figures defined above, four—metaphor, metonymy, synecdoche, and irony—are often called 'tropes,' because in them a word is turned from its ordinary meaning or application. But the word is also applied to a figure of any kind expressed in a single word.

Among the figures which are less easy to classify may be mentioned the following: *Apophysis*, *paraleipsis*, or *omission* is the pretended omission or passing over of what one is really mentioning. *Apostrophe* is a turning aside to address an inanimate object, or a person not present. *Asyndeton* consists in the omission of connectives, as "I came, I saw, I conquered." *Epanorthosis* is an effective correction of something which has just been said, as "His fault—perhaps I should rather say his crime." *Epi-plexis* is a figure in which a person seeks to move or persuade by means of gentle upbraiding. *Epitlocce* is a climax consisting of several clauses so framed that the last part of one clause is repeated as the beginning of the next, as "He not only spared his enemies, but continued them in employment; not only continued them, but even advanced them." *Epistrophe* is a figure by which successive clauses or sentences end with the same emphatic word or phrase, as "Are they Hebrews? So am I. Are they Israelites? So am I. Are they the seed of Abraham? So am I." *Euphemism* is the use of mild, softened language on unpleasant subjects, for the purpose of avoiding the directness of plain speech. *Interrogation* is the asking of questions, not to gain information, but to assert more emphatically the opposite of what is asked. *Litotes* is a figure in which the author denies one thing instead of directly affirming the opposite. *Onomatopœia* is the use of a word, phrase, or clause to imitate

the sound of the thing signified as 'rat-tat-tat,' 'bow-wow.' *Personification* or *prosopopœia* is the representation of inanimate objects as living beings, as "Necessity is the mother of invention."

RHETT, rêt, ROBERT BARNWELL (1800-76). An American politician, born at Beaufort, S. C. His name was originally Smith, but after entering public life he changed it for that of a prominent colonial ancestor. He received a liberal education, studied law, and in 1826 became a member of the State Legislature. In 1832 he was elected Attorney-General of the State, and during the Nullification agitation attracted wide attention by his radical advocacy of the theory of State's rights, in which he outstripped Calhoun himself. In the fall of 1836 he was elected as a Democrat to Congress, sitting by reelection until 1849, and taking a leading part in the acrimonious slavery debates. In 1850 he was elected United States Senator to fill the vacancy caused by the death of John C. Calhoun and took his seat January 6, 1851. He at once took the most extreme position in regard to slavery, and stoutly opposed all compromises as only temporary expedients to put off for a short time the inevitable secession. In the heated campaign of the year 1852 he advocated the immediate withdrawal of South Carolina from the Union without consultation with other Southern States. The Union candidates were generally successful at the ensuing election. Rhett took the defeat as a personal rebuke, resigned his seat in the Senate, and retired to his plantation. In the Charleston *Mercury*, in which he purchased a controlling interest, he continued to advocate his extreme views, and in 1860 again came into prominence as one of the most radical members of the South Carolina convention which adopted the ordinance of secession, and was the author of its address to the people. In the Montgomery convention which met to organize a provisional government for the seceding States he was one of the most active delegates, and was chairman of the committee which reported the Confederate Constitution. Subsequently he was elected a member of the Lower House of the Confederate Congress. After the war he settled in Louisiana.

RHEUMATISM (Lat. *rheumatismus*, from Gk. *ῥευματισμός*, liability to rheum, a flux, from *ῥεματίζεσθαι*, *rheumatizesthai*, to have a flux, from *ῥεῦμα*, *rheuma*, flux, flow, from *ρεῖν*, *rheîn*, Skt. *sru*, to flow). An acute or chronic disease characterized by painful local inflammations. It may be divided for convenience of description into the articular (that involving the joints) and the muscular varieties. Either form may be acute or chronic. Acute articular rheumatism is a constitutional disease, not contagious, and characterized by fever, pain, and inflammation in and around the joints and a tendency to involvement of the pericardium and endocardium. The joints are apt to be attacked in succession. Rheumatism is a disease of moist and temperate climates, and the acute articular form usually occurs in young adults, although children are not by any means exempt.

The close analogy that exists between acute rheumatism and certain of the infectious diseases has led many investigators to believe that it is due to a specific germ, in spite of the fact that no microorganism has as yet been found constantly associated with the disease. A more generally

accepted theory is that it is due to some morbid material produced in the system as a result of defective metabolism. It has been suggested that this material is lactic acid. Others believe that the disease is due essentially to some nervous disturbance. The immediate exciting causes are exposure to wet and cold, or a chilling of the body such as occurs from sitting in a draught. The symptoms often begin quite suddenly, at night, with pain and stiffness in the joints, with nausea and vomiting, followed by all the manifestations of a high fever. The latter may reach as high as 108° F. in severe cases. The pulse is comparatively slow, there is great thirst, profuse acid sweats, and the urine becomes high-colored, scanty, and abnormally acid. The affected joints are painful and tender, hot, red, and swollen. Swelling is apt to be most apparent in joints scantily covered with muscle, viz. the knee, wrist, elbow, ankle, and the joints of the hands and feet. One or more joints may be affected, and the disease travels from joint to joint. Acute rheumatism is distinguished by the number and severity of its complications. These affect principally the serous membranes of the body. Pericarditis (q.v.) is a common complication. Endocarditis (q.v.), which often results in chronic cardiac trouble, is also of frequent occurrence. Pleurisy (q.v.) with effusion is often seen in association with pericarditis. Less often, bronchitis, pneumonia, and inflammation of the cerebral arteries occur. In itself, acute articular rheumatism is not a fatal disease, and the majority of cases recover within a week or ten days. Relapses, however, often occur, and weeks or months may elapse before entire cure is attained.

Chronic articular rheumatism may result from an acute attack, but most frequently it arises independently in persons of advanced middle age. The causative elements are similar to those of the acute form, but the onset is insidious. It is most apt to attack those whose occupation exposes them to cold and damp. The joints gradually become painful and stiff, and the condition varies from time to time. It is worse in the morning and is aggravated by damp weather. Late in the disease the joints become greatly distorted and ankylosis may supervene.

Muscular rheumatism is an affection of the voluntary muscles and of the fasciæ and periosteum to which they are attached. It is inflammatory in character and may be acute or chronic. In contrast to the articular variety, muscular rheumatism is never complicated by cardiac disease. It is a malady of adult life; is almost always due to cold and damp; and one attack predisposes to another. The first attack is generally acute. The onset is sudden with pain in the affected muscles, with slight tenderness, and considerable stiffness and difficulty of movement, by which the pain is increased. Fever is absent or slight. The acute attack lasts about a week. When the disease reaches the chronic stage the attacks return frequently and finally become constant and aggravated when the weather is damp. This form of rheumatism is prone to involve particular groups of muscles, and different names have been applied to it according to its location. When situated in the occipito-frontal muscles it is called *cephalalgia* and may be mistaken for neuralgia of the trifacial or occipital nerves. The eye or jaw muscles may be affected, giving rise to pain when these parts are used. *Torticollis* (wry-

neck) is an affection of the muscles of the side of the neck usually rheumatic. It is generally limited to one side, toward which the head is twisted. *Cervicodynia*, involving the muscles of the back of the neck, is comparatively rare. *Pleurodynia* is applied to a rheumatic affection of the thoracic muscles. Pain is excited by forced breathing, coughing, or sneezing. It is often mistaken for pleurisy or intercostal neuralgia, which it closely simulates. A very common form of muscular rheumatism is *lumbago* (q.v.).

For the efficient treatment of even mild cases of acute rheumatism rest in bed is imperative; indeed, in severe cases the patient cannot do otherwise than lie still. Local measures to relieve pain consist in wrapping the affected joints in cotton wool, upon which some anodyne liniment, such as belladonna or opium, or oil of wintergreen, may be sprinkled freely. The drugs now used internally consist of salicylic acid and its derivatives, with acetanilid, antipyrin, or morphine to relieve severe pain. It is agreed, however, among the best authorities that no medicine has much control over the course or duration of the disease. The diet should consist of milk chiefly, either alone or diluted with barley water, lime water, or vichy. Lemonade is beneficial as a drink. In acute muscular rheumatism hot poultices applied to the parts affected will afford great relief. The treatment of *lumbago*, wry-neck, *pleurodynia*, etc., is dealt with fully under those titles. Chronic rheumatism is best treated locally by friction with stimulating liniments. Much relief is obtained both from pain and loss of function by exposure of the joints to superheated air in a specially devised apparatus. Electricity and hydrotherapy (q.v.) are useful in improving the circulation and nutrition of the joints. Internally the most constantly employed drug is potassium iodide. The alkaline waters may be taken habitually. The greatest attention must be paid to the general health, and good food, warm clothing, and tonics, particularly cod-liver oil, iron, arsenic, and strychnine, are necessary to prevent relapses and recruit the strength.

RHEYDT, rit, or **RHEIDT**. A town in the Rhine Province, Prussia, on the Niers, 28 miles northwest of Cologne (Map: Prussia, B 3). It has a handsome new town hall, statues of William I. and of Bismarck, and a fine Hohenzollern fountain in the market-place. It manufactures silks, woollens, velvets, machinery, cigars, paper, etc., and has dye-works. Rheydt received municipal privileges in 1856. Population (commune), in 1890, 26,830; in 1900, 34,034.

RHIN, rān, BAS- (Fr., Lower Rhine). A former frontier department of France, corresponding nearly to the present German administrative district of Lower Alsace in the Imperial territory of Alsace-Lorraine (q.v.). It was ceded to Germany in 1871 by the Treaty of Frankfurt.

RHIN, HAUT- (Fr., Upper Rhine). A former frontier department in the east of France, with the exception of the Territory of Belfort (q.v.), since 1871 comprehended within the German District of Upper Alsace. The Territory of Belfort is often called Haut-Rhine. See ALSACE-LORRAINE.

RHIND PAPYRUS. A mathematical manuscript written by an Egyptian scribe, Ahmes, who lived before B.C. 1700. It is now deposited in

the British Museum. See AHMES; ALGEBRA; EISENLOHR.

RHINE. The principal river of Western Europe. It rises in Southern Switzerland, and flows in a general northwest direction through Western Germany and Holland, emptying into the North Sea after a course of 760 miles (Map: Germany, B 3). The Rhine proper is formed in the Canton of Grisons, Eastern Switzerland, by two main headstreams, the Vorderrhein and the Hinterrhein. The former is the larger of the two. It rises on the north slope of the Saint Gotthard group within two miles of the source of the Rhone, at an altitude of 7690 feet, and passes northeast along the base of the Glarner Alps till it meets the Hinterrhein coming from the south from the glaciers of the Rheinwaldhorn. The combined stream, swelled by numerous mountain torrents to a width of 45 yards, flows northward, separating Switzerland from Liechtenstein and Austria, and enters the Lake of Constance. It leaves the main body of the lake at the town of Constance, and passes into the Unter See (Lower Lake) a short distance farther on. The Rhine now flows westward, becomes narrow and very rapid, finally (below Schaffhausen) plunging over a rocky precipice 70 feet high. Another and smaller fall is encountered at Zurzach, below which the Rhine receives its first great tributary, the Aar, which brings to it the waters of Northwestern Switzerland. The river bed continues for some distance to be narrow and rocky with several rapids. It continues its westward course to Basel, where it makes a sharp turn to the north and enters wholly into German territory, having formed the boundary between Germany and Switzerland from the Falls of Schaffhausen to this point. At Basel the river is 190 yards wide and is henceforth navigable without obstructions. It now flows on the boundary between Baden and Alsace through a wide and level flood-plain bordered by the Vosges Mountains on the west and the precipitous and romantic Black Forest on the east. In this valley it passes Strassburg, just below which city it receives the Ill, which drains Upper Alsace. After forming for about 50 miles the boundary between Baden and the Palatinate it is joined at Mannheim by the Neckar from the east. It continues its course northward through Hesse, passing the town of Worms, and at Mainz receives the Main, its principal affluent from the right. At Mainz the river makes a short turn to the west, and then at Bingen an abrupt turn to the northwest. It now enters upon the most romantic and celebrated part of its course, reaching from Bingen to Bonn, a distance of about 80 miles, all through Prussian territory. Here the river is much narrowed and winds between steep mountains rising often from the water's edge. The heights are crowned by the famous ruined castles and the slopes are covered with vineyards, this stretch being well known for the Rhenish wines. The chief town on the Rhine in this part of the course is Coblenz, at the confluence of the Moselle, the largest tributary from the left. After passing the Siebengebirge at Bonn the river and its valley again widen out, and from Cologne to its mouth the Rhine flows through a low, level country, turning gradually westward as it enters Holland. The largest city on its banks below Cologne is Düsseldorf. A short distance below

Düsseldorf the Rhine is joined by the Ruhr from the right, and a little farther down it receives the Lippe, also from the right. Shortly after passing the Dutch boundary it divides into two arms, the southern and larger of which, known as the Waal, flows into the great delta of Southern Holland, where it merges with the Meuse and the Scheldt. The northern arm divides again at Arnhem, the Yssel coursing north into the Zuzyder Zee, and the other arm flowing westward, parallel with the Waal. This latter arm, called Lek (Leek) below Wijk, pours its waters into the North Sea through the Nieuwe (New) Maas. At Wijk a narrow arm, which at first bears the name of the Crooked Rhine, branches out northward and flows past Utrecht, below which it is known as the Old Rhine. At Utrecht the Vecht branches out from this arm and flows into the Zuzyder Zee. The Old Rhine, which has barely the dimensions of a river, flows past Leyden, and discharges into the North Sea, a few miles north of Scheveningen.

Commercially the Rhine is probably the most important river of Europe, its valley being densely populated, with numerous important industrial cities, especially along its middle course. Canals connect the Rhine with the Meuse, the Seine, the Saône, the Danube, and the Ems. The Rhine-Rhone Canal follows the course of the river from Strassburg almost to Basel, and is generally used instead of the river, whose current here is very swift. The shipping at the principal ports on the Rhine amounts to nearly 8,000,000 tons annually, and the river is visited every year by more than 1,000,000 tourists. The legends of the Rhine figure prominently in German folk literature.

BIBLIOGRAPHY. Hugo, *The Rhine* (trans., Boston, 1874); Hunt, *The Rhine: Its Scenery and Historical Legendary Associations* (London, 1845); Mellis, *Der Rhein* (Berlin, 1876-79); Stieler, *The Rhine from Its Source to the Sea* (London, 1888); Simrock, *Das malerische und romantische Rheinland* (Bonn, 1865); id., *Rheinsagen* (Bonn, 1891).

RHINE, CONFEDERATION OF THE. See CONFEDERATION OF THE RHINE.

RHINE-HESS. A province of the Grand Duchy of Hesse (q.v.), Germany.

RHINE/LANDER. A city and the county-seat of Oneida County, Wis., 103 miles northwest of Green Bay, on the Wisconsin River, at the Pelican Rapids, which afford large water power, and on the Chicago and Northwestern and the Minneapolis, Saint Paul and Sault Ste. Marie railroads (Map: Wisconsin, D 3). It is the centre of a region noted for its extensive lumber output, and has several saw and planing mills, a refrigerator factory, a veneer factory, boiler and iron works, etc. Population, in 1890, 2658; in 1900, 4998.

RHINE PROVINCE (Ger. *Rheinprovinz*, or *Rheinland*), or RHEINISH PRUSSIA. The most densely populated province of Prussia, bounded by the Netherlands on the north, Westphalia and Hesse-Nassau on the east, Lorraine on the south, and Luxemburg, Belgium, and the Netherlands on the west (Map: Prussia, B 3). It covers an area of 10,423 square miles. About 43 per cent. of the total area is under tillage. The chief agricultural products are rye, wheat, barley, oats, and potatoes. There are extensive vineyards

along the Rhine and Moselle, and wine is exported on a large scale. The large coal fields to which the province mainly owes its industrial development are situated chiefly along the Ruhr and the Saar. The province produces annually upward of 25,000,000 tons. Iron, zinc, lead, copper, quicksilver, and manganese are mined. Salt, sulphur, and several kinds of stone and useful earth are also produced in considerable quantities. The production of different metal articles from locomotives and guns to needles and small tools ranks first among the manufacturing industries of the province. The textile branches have also attained a high state of development. Some of the textiles, such as the woolen fabrics of Aix-la-Chapelle or the silks of Krefeld, are foremost in the world. The Rhine Province has also extensive glass works, paper mills, chemical works, and tanneries, besides a number of sugar refineries, distilleries, and breweries.

The extensive trade of the province is greatly promoted by the excellent transportation facilities, especially the railways. There are about 2400 miles of railways. The chief commercial centres of the province are Cologne, Düsseldorf, Aix-la-Chapelle, Coblenz, and Duisburg. It is divided into the five districts of Coblenz, Düsseldorf, Cologne, Treves, and Aix-la-Chapelle. The capital is Coblenz. The province is represented in the Prussian Landtag by 28 members in the upper and 62 delegates in the lower chamber. It returns 35 members to the German Reichstag. The population of the Rhine Province more than trebled during the nineteenth century. In 1819 it was only about 1,871,000; in 1900 it was 5,759,000, showing an increase of 12.8 per cent. since 1895. Over 70 per cent. is Roman Catholic.

BIBLIOGRAPHY. Proudhon, *France et Rhin* (Paris, 1868); Mehlis, *Studien zur ältesten Geschichte der Rheinlande* (Leipzig, 1875-79); Treutlein, *Die neuern deutschen Rheinstromstudien und ihre Ergebnisse* (Stuttgart, 1893); Tille, *Uebersicht über den Inhalt der kleineren Archiv der Rheinprovinz* (Bonn, 1899-1902); Schwann, *Die Rheinlande von Mainz bis Koblenz* (Leipzig, 1900); Kerp, *Am Rhein* (Bielefeld, 1901).

RHINITIS (Neo-Lat., from Gk. *ῥίς*, *rhis*, nose). Inflammatory disease of the mucous membrane of the nose; nasal catarrh. Low temperature, air in motion and moisture, or mechanical irritants, together with certain bacilli combine to cause a hyperæmic swelling with first a dryness, then an increased production of mucus and a transudation of serum into the blood vessels. Emigration of leucocytes may follow (see INFLAMMATION) and desquamation of epithelium from the mucous membrane may occur. The disease is commonly known as 'cold in the head.' The mucous membrane may remain thickened permanently or may become atrophic, so that an ordinary attack of rhinitis may terminate in three or four days, or may pass into a chronic condition, continuing for months. Some cases are caused by reflex irritation, the primary seat of trouble being in over-stimulated sexual organs. In the treatment of acute rhinitis preparations of ammonium, belladonna, potassium citrate, ipecacuanha, camphor, carbolic acid, and saline cathartics are used, as well as alkaline or astringent topical applications. Similar treatment is used in cases of chronic rhinitis, besides surgical

interference in the way of removal of hypertrophic tissue, both mucous membrane and bone, as well as the correction of intra-nasal deformities. Hay fever (q.v.) is sometimes termed 'pruriginous rhinitis.' *Rhinitis ulcerosa* is considered under OZÆNA. For a study of the bacteriology of nasal inflammation, see Howard, in *American Journal of the Medical Sciences*.

RHINOCEROS (Lat. *rhinoceros*, from Gk. ῥινόκερος, *rhinokērōs*, rhinoceros, nose-horned, from ῥίς, *rhīs*, nose + κέρας, *kerōs*, horn). An animal of a family of perissodactyl ungulates (q.v.), the Rhinocerotidae, closely allied to the tapirs, and containing the largest and most powerful of terrestrial mammals, except the elephants. There are five existing species, all natives of the warm parts of Asia, the Indian Archipelago, and Africa. The form of the rhinoceros is massive and uncouth. The limbs are thick and strong; each foot is terminated by three nearly equal toes, covered with broad, hoof-like nails, with a fourth non-functional toe on the front feet. The tail is small and terminated by a small tuft. The head is large, the muzzle prolonged, ears moderately large, eyes small, and nasal bones combined into an arch for the support of a horn or horns. The upper lip in most species is prolonged, pointed, and prehensile. The incisors are defective in the Asiatic species, and, as well as the canines, wanting altogether in the African species; the molars and premolars are alike and highly effective as grinders. The skin is extremely thick and smooth, but soft and sensitive, although in the Asiatic species it has the appearance of a rigid armor, studded with tubercles and jointed in folds or wrinkles where necessary to permit movement of the head and limbs. The hide is used for making whips, harness, ropes, and so on, and when dried and hardened forms a material for shields capable of resisting spear thrusts and old-fashioned bullets. When properly dried and prepared it has the translucency and mottled appearance of tortoise-shell, and from it are made various ornamental objects by East Indian artificers. The nasal horn or horns are formed of a solid mass of agglutinated bristles which spring from the skin of the nose, but are rooted upon a bony plate surmounting the skeleton of the nose. This horn is not only a powerful weapon, but with it the animal can root up and overturn bushes and small trees whose leaves and roots it seeks to eat.

The Indian rhinoceros (*Rhinoceros Indicus*) formerly ranged over most of the peninsula, but is now restricted almost entirely to the Assam plain, and lives chiefly in grassy jungles. It is the largest known species and sometimes exceeds five feet in height and ten feet in length. The single horn is sometimes two feet long and eighteen inches in circumference at the base. The Javanese or Sondaic rhinoceros (*Rhinoceros Sondaicus*) is a much smaller species, also one-horned, found from Bengal to Java. Its armor has a tessellated appearance, and the female is hornless. The Sumatran or hairy rhinoceros (*Rhinoceros Sumatrensis*) is so distinct that some naturalists have placed it in a separate genus (*Cetorhinus*). It ranges from Northeastern India to Borneo, has a more hairy coat than the others, and two short blunt horns, one behind the other. A hairy-eared race (var. *lasiotis*) inhabits Assam.

The two species of African rhinoceros differ from the Asiatic ones mainly in the absence of incisor teeth and in the smoother, unfolded skin; and they have been put into a separate genus (*Atelodus*) by some naturalists. Possibly a third species exists, of which nothing very definite is known. The more familiar and widespread of the African rhinoceroses is the 'common' or 'black' one (*Rhinoceros bicornis*) formerly abundant all over the eastern and south-central parts of the continent, but now become rare and restricted. It is not black, but bluish lead-color, if anything rather lighter than the other species usually called 'white.' This rhinoceros stands 5½ feet at the withers in the case of large males or 'bulls,' and has two horns. The front one, usually much the longer in South African examples, sometimes attains a length of 40 inches, but is always less in northern specimens. The rear horn varies from a mere knob to a length almost equal to its fellow, and is usually straighter and much compressed. The upper lip is pointed, extensible, and prehensile, and this species feeds almost wholly on leaves, twigs, and roots. It frequents bushy and rocky districts rather than open plains. It spends the day in an accustomed lair well hidden from observation, and starts at sunset for a drinking-place along a well-trodden path. Having drunk it will wander about feeding during the night, will drink again at daybreak, and then return to its resting-place. Some hunters regard this rhinoceros as naturally ferocious and vindictive, while others consider it stupid and timid, but subject to sudden panics, in which it is as likely to rush headlong toward the hunter as away from him. At best, however, it is dangerous, and its speed and agility are extraordinary. The other African species, the white, Burchell's or square-mouthed rhinoceros (*Rhinoceros simus*), is larger than the 'bicornis,' the biggest, indeed, of the entire tribe, and differs from the other prominently in having a blunt, squarish muzzle, the upper lip not being at all prehensile. In conformity with this it is a grazing, not a browsing animal.

Fossil RHINOCEROSSES. The existing species are the lone remnants of a once numerous group that abounded in North America from Eocene to late Miocene time, and in Europe from Eocene to Pliocene time. The fossil and living species may be grouped under three families. The Hyracodontidae, represented by the genera Hyrachyus and Hyracodon of Eocene and Oligocene time, comprised hornless, lightly built animals adapted for running on the uplands. They show a tendency to reduce the number of functional digits of the feet from five to three and thus to parallel the evolution seen in the horse's hoof. The Amynodontidae, comprising the American genera Amynodon, Metamyndon, and the European Cadurocotherium, were heavily built, short-bodied animals adapted to more or less aquatic habits of life. The skull was hornless and the eyes were situated high on the head. The upper incisors are reduced and the canine teeth are enlarged to form tusks for use in uprooting water plants. The true rhinoceroses (*Rhinocerotidae*) began as light-limbed runners without horns, that lived at the same time as the members of the two preceding families. After the hyracodonts and amynodonts had become extinct the rhinoceroses began to adapt themselves to

the habits of life of their predecessors and evolved along six different lines of descent. A gigantic animal, *Elasmotherium*, found in the Pleistocene deposits of Northern Asia, thought to have descended from *Aceratherium*, attained a length of 15 feet, and had two large horns in tandem and prismatic teeth. The woolly rhinoceros (*Atelodus antiquitatis*) is found fossil in the Pleistocene deposits of England and in the cave deposits of Europe, and its complete carcasses have been obtained from the frozen mud banks of the tundras of Northern Siberia. It was a large two-horned species, with a heavy fur of coarse woolly hair.

BIBLIOGRAPHY. The best general account of the tribe is by Lydekker in *Royal Natural History*, vol. ii. (London, 1896). Consult, also: Blandford, *Fauna of British India: Mammals* (ib., 1888-91); Baker, *Wild Beasts and Their Ways* (ib., 1890); Hornaday, *Two Years in the Jungle* (New York, 1885); Drummond, *Large Game . . . of Southeast Africa* (Edinburgh, 1875); and similar books of naturalists and sportsmen relating to Southern Asia and Africa; Osborn, "Phylogeny of the Rhinoceroses of Europe," *Bulletin of American Museum of Natural History*, vol. xiii. (New York, 1900); id., "The Extinct Rhinoceroses," *Memoirs of the American Museum of Natural History*, vol. i., part iii. (ib., 1898). See Colored Plate of **PACHYDERMS**.

RHINOCEROS BEETLE. A name in the South for a large scarabæid beetle (*Dynastes tityus*). It is most abundant in the southern Atlantic States, but extends west to New Mexico and north to Cape May and southern Pennsylvania. It is a large beetle, nearly 2½ inches in length, and is stout. The male has two long



A MALE RHINOCEROS BEETLE.

horns, one extending forward from the head and the other from the thorax, from which fact it derives its popular name. The female resembles the male, but lacks the horns. It is pale bluish gray in color and the wing-veins are marked with darker irregular spots. The egg is an eighth of an inch in length and is laid in rich earth or decaying trunks of old trees of several varieties. The insect in all stages has a very strong and disagreeable odor.

RHINOCEROS-BIRD. (1) An oxpecker or buffalo-bird (qq.v.) which settles upon the backs of rhinoceroses. (2) A hornbill.

RHINOCEROS HORNBILL. See **HORNBILL**.

RHINODERMA (Neo-Lat., from Gk. *ῥίς*, *rhis*, nose + *δέρμα*, *derma*, skin). A small frog (*Rhinoderma Darwini*) of Chile, remarkable for

its bell-like voice, and for the fact that the internal vocal sacs in the throat of the male are converted into nests for the eggs, which hatch there, whereupon the sacs become nurseries for the 5-15 tadpoles until they reach maturity. The process is not wholly known, but has been studied by Espada, an outline of whose investigations is given in English by Gadow, *Amphibia and Reptiles* (London, 1901).

RHINOPLASTIC OPERATION (from Gk. *ῥίς*, *rhis*, nose + *πλασσειν*, *plassein*, to mold). When a portion or the whole of the nose has been destroyed by accident or disease the deficiency may be restored by a transplantation of skin from an adjoining healthy part. After paring away any remains of the old nose, a flap of skin of the required shape is carefully dissected from the forehead until it hangs by a narrow strip or pedicle between the eyebrows. Then after all bleeding is stopped the flap is twisted on itself so that its skin surface remains out, while its base is brought down in position to correspond to the original base of the nose. The edges of the flap are then sutured accurately to the denuded edges of the former membrane, spaces being left on either side of the lower end of the flap for the nostrils. As practiced at the present time the operation has received two important modifications: The first consists in the use of a permanent frame of gold or aluminum or platinum, which is fastened into the bony framework surrounding the nasal aperture and which gives shape and profile to the nose; the second consists in the employment of skin-grafts to cover the unsightly area in the forehead and prevent the deforming cicatrix that would otherwise result. See **AUTOPLASTY**; **SKIN-GRAFTING**.

RHINS, rān, JULES LÉON DUTREUIL DE (1846-94). A French geographer and explorer, born at Saint Etienne. He took part as a midshipman of naval volunteers in the expedition to Mexico and was an ensign during the Franco-Prussian War. From 1871 to 1876 he was captain of a foreign-going ship, in 1876-77 commanded the *Scorpion* of the King of Annam's navy, and in 1882 was Egyptian correspondent of the *Temps*. From 1891 to 1894 he explored Chinese Turkestan (Eastern Turkestan), and the most inaccessible and least-known regions of Northern and Western Tibet. He was murdered by natives at a small town of Eastern Tibet. His publications include *Le royaume d'Annam* (1879), *Carte de l'Indo-China orientale* (1881), *Levé du cours de l'Ogooné* (1884), and *L'Asie centrale* (1889). The results of his last journey were edited by his assistant, Grenard, *Mission scientifique dans la Haute-Asie* (3 vols., 1897-98).

RHINTHON, rīn'thōn (Lat., from Gk. *Ῥίνθων*). A Greek comic poet of Tarentum who lived about n.c. 300. He was the first to develop in a written form and to introduce into Greek literature the so-called Hilarotragedia (*Ἱλαροτραγῳδία*), a species of burlesque tragedy in which the tragic myths were treated in the spirit and style of comedy. He is frequently quoted by Cicero and Varro, and by Athenæus, Hesychius, and other Greek writers, but of his 38 dramas only insignificant fragments are extant. Consult *Völker, Rhinthonis Fragmenta* (Halle, 1887).

RHIZOCARPEÆ. See **PALEOBOTANY**.

RHIZOCEPH'ALA (Neo-Lat. nom. pl., Gk. *ῥιζοκέφαλος*, *rhizokephalos*, having the flower growing immediately from the root, from *ῥίζα*, *rhiza*, root + *κεφαλή*, *kephalē*, head). An order of most degraded cirripeds, the root-barnacles, especially of the genera *Sacculina* and *Peltogaster*. The few forms known are parasitic on the abdomens of various crabs.

RHIZ'ODON'TIDÆ (Neo-Lat. nom. pl., from Gk. *ῥίζα*, *rhiza*, root + *ὄδους*, *odous*, tooth). A family of carnivorous Paleozoic fishes of the crossopterygian suborder Rhipidistia, in which the median fins are always more or less subdivided by a process of concentration analogous to that prevalent among dipnoans. The notochord was persistent, and the jaws bore many peculiar teeth. These teeth were highly complicated in

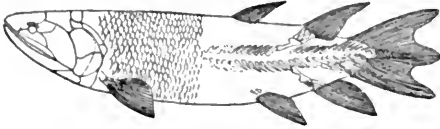

EUSTHENOPTERON FOORDI.

the Holopterychida, less so in the Rhizodontida, with a larger central cavity. A well-known example, found in an unusually good state of preservation, is *Eusthenopteron Foordi*, herewith figured, which abounds in the Devonian rocks of Quebec, and whose pectoral fin has only one stout basal cartilage—an 'archipterygium.' All were small fishes. Consult Woodward, *Vertebrate Paleontology* (Cambridge, 1898).

RHIZOIDS (from Gk. *ῥιζώδης*, *rhizōdēs*, root-like). Colorless, hair-like structures developed by liverworts, certain algae, mosses, and fungi (toadstools and molds). Their function is to anchor the plant in favorable situations and in some cases perhaps to absorb water. The ferns have rhizoids only in connection with the very small prostrate sexual plant (gametophyte, q.v.).

RHIZOP'ODA (Neo-Lat. nom. pl., from Gk. *ῥίζα*, *rhiza*, root + *πούς*, *pous*, foot). The first and lowest class of Protozoa (q.v.); a large assemblage of varying forms agreeing in the possession of projections of the body-protoplasm called 'pseudopodia.' These pseudopodia are used as organs of locomotion and also for ob-

dosarc,' which is granular and more opaque. Most of the numerous species are spherical with radiating pseudopodia, but the lowest forms have no constant shape. Most rhizopods are provided with some sort of shell, but the lowest forms have no such covering. The simplest shells are those made up of particles of dirt or foreign material of some sort, united together by some secretion of the ectosarc; in other cases the shell is formed of a horny material called 'acanthin' or of carbonate of lime or silica, often in a very remarkable and elaborate pattern. Generally rhizopods are freely moving animals, but some are attached in adult life by stalks. The individuals are usually distinct, but colonial rhizopods are known, and such colonies are sometimes half an inch across.

The only internal organs of the Rhizopoda are the 'vacuoles,' those which contain more or less digested food and those which contain the waste matter or excreta of the body. The latter are the larger and more conspicuous, and, owing to the sudden collapse when the excreta are thrown out of the body, are known as 'contractile' vacuoles. Reproduction takes place by simple budding or fission, the two processes differing only in the relative size of the resulting individuals. The formation of spores, however, occurs in many cases, especially after a resting period. Such resting periods occur during unfavorable conditions such as prolonged cold or drought, or when an unusual amount of food has been taken. In most cases during such a resting period the rhizopod surrounds itself with a firm, impervious coat, called a 'cyst.' When the unfavorable conditions cease the sarcode divides up into several minute spores, each of which on the dissolution of the cyst becomes a new individual. The growth of these individuals is rapid when food is abundant. For further information, see Bütschli's *Protozoa in Bronn's Klassen und Ordnungen des Thierreichs* (Leipzig, 1887); concerning fresh-water forms, see Leidy *Fresh Water Rhizopods of North America* (Washington, 1879).

RHODE ISLAND. A North Atlantic State of the United States, belonging to the New England group, and situated between latitudes 41° 18' and 42° 3' N. and between longitudes 71° 8' and 71° 53' W. It is bounded on the north and east by Massachusetts, on the south by the Atlantic Ocean, and on the west by Connecticut. Rhode Island is the smallest in area of the United States. It has an extreme length from north to south of 48 miles, and an extreme width from east to west of 36 miles. Its area is 1250 square miles, of which 1053 square miles, or 673,920 acres, are land surface.

TOPOGRAPHY. The greater part of the State belongs to the eastern Appalachian belt known in the Southern States as the Piedmont Plain. It is rough and hilly, though the general elevation is not great, being less than 600 feet throughout the State, with the exception of a few monadnocks. The highest point is Durfee Hill, near Gloucester, in the northwestern part; its altitude is 805 feet. The western part of the coast-line is bordered by lagoons and marshes, while the eastern part of the State is separated from the main portion by Narragansett Bay, a large, irregular, and branching inlet extending 28 miles inland, with a breadth of from 12 to 3 miles. It incloses a number of islands, the

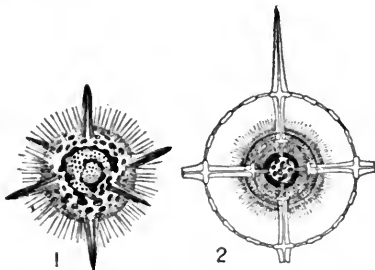

1. A radiolarian, showing the interior; 2, cross-section of the same through the processes.

taining food. They may be of very irregular and constantly changing shape or comparatively rigid, independent of each other, or forming a very complex network. The protoplasm or 'sarcodē' of a rhizopod consists of an outer layer called 'ectosarc,' which is thin, transparent, and homogeneous, and an inner portion called 'en-

71° 45' Longitude

West 71 30' from

Greenwich 71 15'

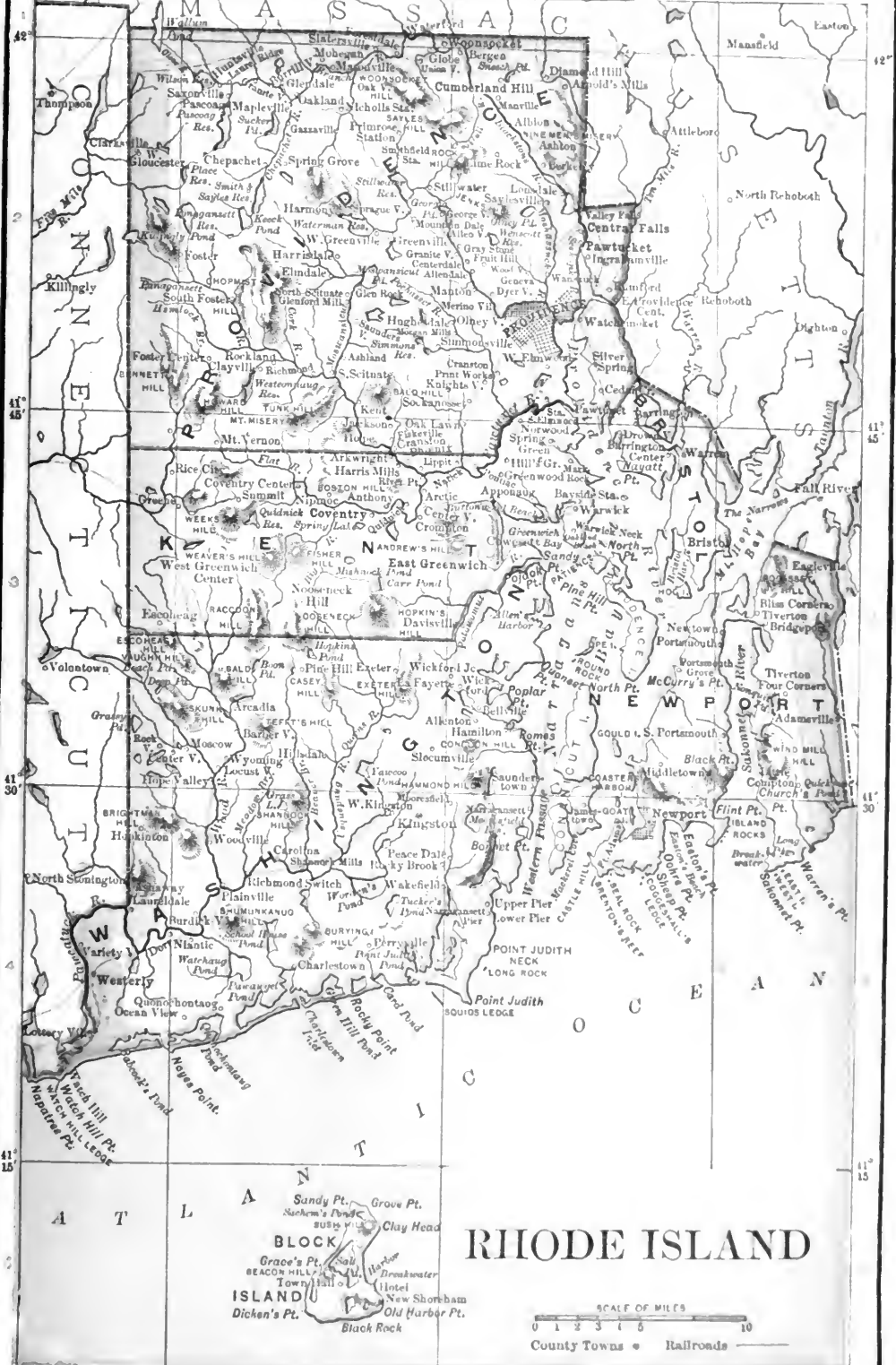

RHODE ISLAND

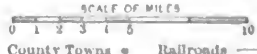

71° 45'

71 30'

71 15'

AREA AND POPULATION OF RHODE ISLAND BY COUNTIES.

County.	Map Index.	County Seat.	Area in square miles.	Population.	
				1890.	1900.
Bristol	C 3	Bristol.....	25	11,428	13,144
Kent.....	B 3	East Greenwich.....	169	26,751	29,976
Newport.....	C 3	Newport.....	117	28,552	32,599
Providence.....	B 2	Providence.....	411	255,123	328,683
Washington.....	B 4	Kingston.....	331	23,649	24,154

largest of which are Aquidneck or Rhode Island, Conanicut, and Prudence Island. Aquidneck, containing the town of Newport, is a beautiful island, 15 miles long and 3 miles wide. It is lined with bold cliffs and fine beaches, and is known as the 'Eden of America.' Nine miles off the coast lies Block Island, a sandy reef inclosing a salt lagoon. The rivers of the State are small. The three largest are the Blackstone and the Pawtuxet in the north, flowing into the upper part of Narragansett Bay, and the Pawcatuck in the south, flowing into the Atlantic Ocean on the Connecticut boundary. All of these are rapid streams, with a number of falls supplying considerable water-power. Like all glaciated areas, the State is studded with numerous small lakes.

CLIMATE AND SOIL. The climate is mild and equable compared with that of the rest of New England. It is influenced chiefly by winds coming from the Gulf Stream. The cold winds striking the eastern coast of New England are almost unfelt here. The mean temperature for January is 36° and for July 76°. The average relative humidity ranges between 80 and 95 per cent. throughout the year. The average rainfall is about 45 inches, ranging in localities from 40 inches in the north to nearly 50 on the coast. The soils are in general coarse, stony, and not well adapted for agriculture, and there is very little alluvial land.

GEOLOGY AND MINERAL RESOURCES. Archæan rocks, chiefly the Montalban gneisses, form the surface of the western half of the State to within three miles of Narragansett Bay. The Narragansett Basin, including the bottom of the bay, its islands and both shores, together with a region running northeast into Massachusetts, forms an interesting patch of Carboniferous deposits. It seems to have been a shallow trough undergoing a continual subsidence as the coal beds and intervening strata were laid down, until the whole deposit attained a thickness of several thousand feet. The basin has since been subjected to folding movements, in which process the strata were crushed and faulted, and the coal converted into graphitic anthracite, and locally almost or wholly into pure graphite. These anthracite beds form the principal mineral deposits of the State, but access to large portions of them is difficult, owing to the proximity of the bay. Along a part of the western edge of the Carboniferous area runs a dike of magnetite iron ore containing considerable deposits, while limestone and granite are the most important of the other mineral resources.

FISHERIES. The fisheries employed in 1898 about 1700 persons. The value of the product for that year was \$955,058, to which the oyster catch contributed more than \$500,000. Next to oysters the most important fish are scups and squeteagues.

AGRICULTURE. In Rhode Island the number of acres included in farms decreased 17.8 per cent. between 1850 and 1900, the acreage in the latter year being 455,602, or 67.6 per cent. of the total land surface. The number of farms meanwhile remained almost the same, so that the average size decreased from 103 acres in 1850 to 83 in 1900. The improved land in 1900 (41.1 per cent. of the farm acreage) was only a little over one-half as great as the improved area in 1850. In the census year 1900 the most important cereal, corn, represented only 8149 acres, and the next

in rank, oats, only 1530 acres. Hay and forage form by far the most important crop, amounting in 1899 to 69,776 acres; but this was a decrease from 94,111 in 1889. Potatoes are relatively important, representing, in 1899, 5817 acres. Sweet corn and other vegetables are grown for the local markets. Much attention is given to the growing of apples, peaches, and pears. The number of peach trees increased over four-fold between 1890 and 1900. Considerably over half the fruit trees are in Providence County. Cranberries, strawberries, and other small fruits are grown.

STOCK-RAISING. Significant increases were made in the number of dairy cows and horses in the last half of the nineteenth century, but there was a very great decrease in the number of other cattle, sheep, and swine. The following table shows the number of domestic animals on farms:

	1900	1890
Dairy cows.....	23,660	23,943
Other cattle.....	12,374	10,834
Horses.....	11,390	9,864
Mules and asses.....	43	51
Sheep.....	6,629	11,400
Swine.....	11,508	12,055

In 1899 the value of dairy products was \$1,923,707. Of this amount 89.2 per cent. was realized from sales, mainly of milk. In the decade of 1890-1900 there was a decrease of 49.4 per cent. in the quantity of butter produced on farms, and an increase of 21.8 per cent. in the quantity of milk.

MANUFACTURES. Since 1870 over 22 per cent. of the total population have been engaged as wage-earners in this line of industry. The number in 1900 was 96,528, of whom 26,984 were women, and 5036 children under sixteen years of age. The total value of products increased 29.2 per cent. from 1890 to 1900, being in the latter year \$184,074,378. The shallow depth of the water at the port of Providence has prevented the development of ocean traffic and thus has withheld from the State a great advantage. The raw materials of manufacture are transported long distances, and the centralization of the railroads has in a measure deprived the State of the advantages of competitive rates. Rhode Island has become well known for the superiority of certain of its products. The State has ranked second in cotton manufacture from the beginning of the industry, as estimated by the number of spindles employed. The spinning of cotton by the factory system began in 1790 at Pawtucket, and it was here that cotton was first spun by water power in the United States. As early as 1815 there were 140,000 spindles within a radius of 30 miles of Providence. Since 1890 a very slight decrease has taken place in the number of spindles, the number in 1900 being 1,920,522.

The manufacture of wool in the State by the factory process began in 1804; here the first power loom used in the manufacture of woolens in the United States was installed in 1814. Between 1890 and 1900 the production of worsted goods increased enormously, and the State ranks second in this branch of the woolen industry. But the value of other kinds of woolen goods has greatly decreased. The dyeing and finishing of textiles are industries which have increased enormously

since 1890, as has also been the case with the silk and silk goods industry. Next in importance to the textiles are jewelry and silverware. The State ranks first in each of these and second in the reducing and refining of gold and silver not from the ore. These industries are almost wholly concentrated in Providence. They began here prior to the Revolution, but the prominence of the city in this respect dates from about 1894, when improved machinery was applied. All three of these industries made large gains in the decade 1890-1900. The foundry and machine-shop industry mainly turns out engines and boilers, for which the State has an established reputation. The manufacture of rubber boots and shoes (not included in the appended table) amounted in 1900 to \$8,034,417 in value, and the manufacture of electrical apparatus reached \$5,113,292 in the same year.

The following table shows the relative importance of most of the leading industries:

INDUSTRIES	Year	Number of establishments	Average number wage-earners	Value of products, including custom work and repairing
Total for selected industries for State..	1900	614	66,381	\$116,440,265
	1890	514	60,084	90,433,113
Increase, 1890 to 1900.....		100	6,297	26,007,152
Per cent. of increase.....		19.5	10.5	28.8
Per cent. of total of all industries in State..	1900	14.7	68.8	63.3
	1890	15.2	74.1	63.5
Foundry and machine shop products.....	1900	149	8,799	\$13,269,086
	1890	101	6,876	10,170,286
Gold and silver, reducing and refining, not from the ore.....	1900	10	70	3,484,454
	1890	10	70	1,419,553
Jewelry.....	1900	214	4,877	13,320,620
	1890	179	4,092	8,011,067
Liquors, malt.....	1900	6	296	1,880,171
	1890	3	82	436,846
Rubber and elastic goods.....	1900	9	1,039	2,518,268
	1890	4	438	629,000
Silverware.....	1900	8	1,540	3,834,408
	1890	4	969	2,509,869
Textiles—total.....	1900	218	49,760	78,133,258
	1890	213	47,557	68,355,207
Cotton goods (including cotton small wares).....	1900	87	24,032	26,435,675
	1890	94	24,576	27,310,499
Dyeing and finishing textiles.....	1900	24	5,942	8,484,878
	1890	22	3,619	4,743,561
Hosiery and knit goods.....	1900	15	1,594	2,713,850
	1890	16	1,504	2,516,664
Shoddy.....	1900	9	131	515,643
	1890	10	132	1,350,792
Silk and silk goods.....	1900	6	455	1,311,333
	1890	3	186	229,062
Woolen goods.....	1900	26	2,710	5,330,550
	1890	40	5,912	9,884,945
Worsted goods.....	1900	51	14,896	33,341,329
	1890	28	11,628	22,319,684

TRANSPORTATION AND COMMERCE. The railroad mileage increased from 108 in 1860 to 217 miles in 1890 and decreased to 209 in 1900. All the important lines are under the control of the New York, New Haven and Hartford Railroad. The value of foreign imports at the port of Providence for the year ending June 30, 1901, was \$1,146,511. The exports are altogether insignificant. Of greater importance is the coastwise traffic, there being a considerable trade with the important North Atlantic ports. Newport and Bristol and Warren are also customs districts, but the trade of both is small.

BANKS. The first bank of Rhode Island was

the Providence Bank, founded in 1791. The early banking history of the State, however, centres around the Providence Institution for Savings, which dates from 1819. It has been the tendency during the past few years for the national banks and savings institutions either to liquidate or become trust companies. The report of the Comptroller of the Currency for the year ending June 30, 1902, gives the following statistics:

	National Banks	State	Savings
Number.....	36	3	24
Capital.....	\$12,305,000	\$395,000
Surplus.....	3,788,000	\$3,338,000
Cash, etc.....	1,523,000	92,000	2,343,000*
Loans.....	27,472,000	1,003,000	31,789,000
Deposits.....	19,154,000	735,000	71,900,000

* Including amount due from banks and bankers.

GOVERNMENT. The State Constitution was adopted in 1842, replacing the original charter granted by King Charles II. An amendment proposed in the General Assembly must receive the votes of a majority of all the members elected to each House at two consecutively elected Assemblies, and then be approved by three-fifths of the electors present and voting in the town and ward meetings.

Since 1888 a residence and home in the State for two years and in the town or city for six months preceding an election have been required for voting, with a small additional property qualification for those voting for the city council of any city or upon any proposition to impose a tax or for the expenditure of money in any town or city. The capital of Rhode Island is Providence.

LEGISLATIVE. According to the amendment of 1900, the General Assembly meets on the first Tuesday of January in each year at Providence. Each town or city has one representative in the Senate, and one or more in the House of Representatives, but no town or city can have more than one-sixth of the 72 members to which the House is limited, and no town or city can be divided for purposes of representation. Senators and Representatives are paid according to time of actual attendance, with a maximum limit of 60 days, plus mileage. The House impeaches and the Senate tries all cases of impeachment.

EXECUTIVE. The Governor, Lieutenant-Governor, Secretary, Attorney-General, and Treasurer are annually elected at the same time and place as are Senators and Representatives, namely, at the town, ward, and district meetings, on the Tuesday next after the first Monday in November. They hold office one year. The Lieutenant-Governor succeeds to the Governorship in case of a vacancy, and in case of further vacancy the position is filled by appointment by the General Assembly acting in grand committee. The pardoning power is exercised by the Governor with the advice and consent of the Senate.

JUDICIAL. The judicial power is vested in one Supreme Court and such inferior courts as the General Assembly may establish, the powers of the several courts being prescribed by law. Judges of the Supreme Court are elected by the General Assembly in grand committee, and their term of office continues until their positions are declared vacant by a resolution of the General Assembly.

FINANCES. The paper money system, which was prevalent throughout all the colonies, kept Rhode Island's finances in a continual state of disorder. The Revolution left the State with a large debt and heavy taxes, and this condition of affairs was not remedied until Rhode Island joined the Union. In 1789 the Revolutionary debt was repudiated by the passage of the compulsory tender act compelling creditors to accept paper money at an arbitrary rate. On January 1, 1902, the balance on hand in the treasury amounted to \$158,272.71. The total receipts during the year were \$1,490,621.96 and the expenditures \$1,537,502.41. There was a balance on hand of \$111,392.26 on January 1, 1903. The total debt was \$2,998,000. From this sum, however, there should be deducted a sinking fund of \$444,451.56.

MILITIA. In 1900 there were 95,737 men of militia age. The militia in 1901 numbered 1413.

POPULATION. The population increased from 68,825 in 1790 to 147,545 in 1850, 345,506 in 1890, and 428,556 in 1900. As to population, the State stood 34th in rank in 1900. There were in that year 407 inhabitants to the square mile, which figure exceeded that for any other State. There was a foreign-born population (1900) of 134,519, Ireland, Canada, and England being chiefly represented. The percentage of city population is very large. In 1900 Providence had a population of 175,597; Pawtucket, 39,231; Woonsocket, 28,204; Newport, 22,034; and Central Falls, 18,167.

The State sends two members to the National House of Representatives.

RELIGION. The principal Protestant denominations are the Baptist, with one-third of the total Protestant church membership, and the Protestant Episcopalians, with about one-fifth. The Roman Catholics have about one-fourth of the population.

EDUCATION. The public school system was established in 1828 and was greatly improved under the administration of Henry Barnard (q.v.). The proportion of illiteracy, due in large part to the numbers of foreigners, is greater than in any other of the North Atlantic States—8.4 per cent. in 1900. In 1900-01 the school population (5-15 inclusive) of the State was 85,084, of whom 69,067 were enrolled in schools. Of the 1960 teachers employed in the public schools in 1900-01 the male teachers constituted only 9.1 per cent. The average monthly salaries of male and female teachers in the same year were \$115.32 and \$51.14 respectively. The school fund is insignificant. The State has only one normal school. It is situated at Providence. The State maintains a college of agriculture and mechanic arts. For Brown University, see article.

CHARITABLE AND PENAL INSTITUTIONS. There are a State hospital at Providence and a soldiers' home at Bristol. There are two insane hospitals, one at Providence and the other at the State farm, Cranston. Other State institutions located at the State farm are the almshouse, workhouse, reformatory, and penitentiary. In 1901 the State appropriated \$259,000 for the maintenance of the State institutions and \$136,891 for construction.

HISTORY. The stories of Norse exploration within the present limits of the State rest upon slight foundation. True history begins when Roger Williams (q.v.) was banished from Massachusetts Bay, and settled with a few com-

panions, at 'Providence Plantations,' on land purchased from the Narragansett Indians, probably in June, 1636. Already, however, William Blackstone, who had fled from the tyranny of the 'lords brethren' in Massachusetts, as he had left England to escape the 'lords bishops,' had settled near Pawtucket River. In March, 1638, a band of Antinomians banished from Massachusetts Bay, under the leadership of William Coddington and John Clark, made a settlement at Poanasset (Portsmouth), on Aquidneck Island (Rhode Island). The next year a secession from this settlement founded Newport, but in 1640 these two towns were united under William Coddington as Governor. In 1643 Samuel Gorton (q.v.) founded Warwick upon the mainland. At Providence the government was at first a pure democracy, "ignoring any power in the body politic to interfere with those matters which alone concern man and his maker." Each of these settlements was at first independent. In 1642 it was determined to seek a patent from England, and the next year Roger Williams went to England for this purpose. Through the influence of the Earl of Warwick, Parliament granted (1644) a charter uniting the settlements as the "Incorporation of Providence Plantations in the Narragansett Bay in New England."

The towns, at first, from jealousy and exaggerated ideas of individual importance, refused to enter into the confederation, but finally through fear of revolutions within, and of Massachusetts without, the union was formed in 1647. This jealousy lasted well into the nineteenth century and explains much of the peculiar conduct of the colony and of the State. Complete religious toleration was granted together with the largest measure of political freedom. William Coddington sought to bring the Island into relations with the United Colonies of New England, while President. In 1650 he went to England, and in 1651 secured a grant of the islands within the colony. Williams was able to have this grant vacated in 1652, but not until 1654 were the settlements again united. In 1663 the charter of Rhode Island and Providence Plantations was secured, and this served as a constitution until 1843. During the war waged on charters by James II., the charter of Rhode Island was abrogated by Sir Edmund Andros (q.v.), 1686-89, but on his deposition the old government was quietly renewed under it, though a property qualification for suffrage was added in 1724.

Relations with the other New England colonies were unpleasant. The colony suffered severely in King Philip's War (q.v.), though opposed to the policy which caused it. Connecticut and Massachusetts claimed practically all of the territory included in the charter limits. The Connecticut boundary, after much wrangling, was finally settled in 1727, and the Massachusetts boundary was confirmed in 1746-47, but was not finally settled until 1862. Both of these colonies looked on Rhode Island as a nest of heretics and a refuge for the disaffected. The colony was shut out from the United Colonies of New England, and in every way made to feel her slight influence. Nevertheless the growth of the colony in population and wealth was steady, and many of the inhabitants turned to the sea for a livelihood. In the colonial wars Rhode Island privateers inflicted much damage, and some of her

citizens were accused of piracy. In 1775 an army of observation was organized for the defense of the colony, and two of the thirteen ships ordered by Congress were built here. Rhode Island renounced allegiance to Great Britain on May 4, 1776, and united with the other colonies for defense. During the Revolution Newport was held (1776-79) by British troops, and in 1780 the French fleet was stationed there. The famous soldier of Rhode Island was General Nathanael Greene (q.v.). After the Revolution the State blocked every attempt to give increased power to Congress. This was partly due to the prevalent exaggerated individualism and partly to the desire to retain the right to levy import duties and to force her paper money into circulation. Much paper money had been issued early in the century and in 1786 another era of inflation began. The paper issued on land mortgages depreciated, but many attempts were made to make it a legal tender. A debtor might deposit with a judge of the court the sum owed and upon notice to the creditor the debt was legally satisfied. The notices began, "Know Ye," and hence the epithet applied in derision to residents of the State. The country or paper money party was in complete control, and a test act requiring all to regard the paper as equal to specie was passed.

The State refused to send delegates to the convention which drew up the Federal Constitution, and when that instrument was submitted for approval it was overwhelmingly rejected by the town meetings. Many attempts to call a convention to consider the Constitution failed, and it was not until threats of coercion had been made that the instrument was ratified, May 29, 1790. Though the commercial and manufacturing interests of the State grew rapidly, the power still lay in the country districts, as the basis of representation had not been changed since the granting of the charter, except to admit new towns. Dissatisfaction finally culminated in Dorr's Rebellion in 1841. (See DORR, THOMAS WILSON.) A new State constitution was adopted as a result in 1842, which has been frequently amended since. The property qualification for suffrage was not abolished until 1888, and election by a plurality has been allowed since 1893. Previously the election of Governor and State officers was often thrown into the Legislature. Until 1900 the Legislature met in Newport in April to canvass the vote and adjourned to Providence in January to transact business. Now all sessions are held in Providence. A prohibitory amendment to the Constitution was adopted in 1886, but was repealed in 1889. During the Civil War the State furnished more than her quota of troops. In national politics the State has been erratic. From 1792 to 1800 she gave her vote to the Federalist electors, but in 1804 was Democratic. In 1808 and 1812 the Federalists again secured control, but in 1816 and 1820 the State was once more Democratic. Rhode Island supported the tariff wing of the Democracy in 1824, but in 1828 was National Republican (the name originally borne by the Whig Party) and in 1832 Whig, only to be Democratic again in 1836. From 1840 to 1848 the Whig candidates received her votes, and in 1852 the State went back to Democracy. Since 1856, however, the State has been Republican in national elections:

GOVERNORS

Providence had no chief executive from its organization until the union under the patent in 1647.

PORTSMOUTH (Pocasset)

William Coddington.....Judge.....1638-39
William Hutchinson.....".....1639-40

NEWPORT

William Coddington.....Judge.....1639-40

PORTSMOUTH AND NEWPORT

William Coddington.....Governor.....1640-47

PRESIDENTS OF COLONY UNDER PATENT

John Coggeshall.....".....1647-48
William Coddington.....".....1648-49
John Smith.....".....1649-50
Nicholas Easton.....".....1650-51

THE DIVISION 1651-54

PROVIDENCE AND WARWICK

John Smith.....President.....1651-53
Gregory Dexter.....".....1653-54

AQUIDNECK (Portsmouth and Newport)

John Sanford.....President.....1653-54

THE REUNION; PRESIDENTS

Nicholas Easton.....".....1654
Roger Williams.....".....1654-57
Benedict Arnold.....".....1657-60
William Brenton.....".....1660-62
Benedict Arnold.....".....1662-63

UNDER THE ROYAL CHARTER

Benedict Arnold.....".....1663-66
William Brenton.....".....1666-69
Benedict Arnold.....".....1669-72
Nicholas Easton.....".....1672-74
William Coddington.....".....1674-76
Walter Clarke.....".....1676-77
Benedict Arnold.....".....1677-78
William Coddington.....".....1678
John Cranston.....".....1678-80
Reley Sanford.....".....1680-83
William Coddington, Jr.....".....1683-85
Henry Bull.....".....1685-86
Walter Clarke.....".....1686
Charter suspended by Governor Andros.....".....1686-89
Henry Bull.....".....1690
John Easton.....".....1690-95
Caleb Carr.....".....1695
Walter Clarke.....".....1696-98
Samuel Cranston.....".....1698-1727
Joseph Jenekes.....".....1727-32
William Wanton.....".....1732-33
John Wanton.....".....1733-40
Richard Ward.....".....1740-43
William Greene.....".....1743-45
Gideon Wanton.....".....1745-46
William Greene.....".....1746-47
Gideon Wanton.....".....1747-48
William Greene.....".....1748-55
Stephen Hopkins.....".....1755-57
William Greene.....".....1757-58
Stephen Hopkins.....".....1758-62
Samuel Ward.....".....1762-63
Stephen Hopkins.....".....1763-65
Samuel Ward.....".....1765-67
Stephen Hopkins.....".....1767-68
Josias Lyndon.....".....1768-69
Joseph Wanton.....".....1769-75

STATE GOVERNORS UNDER THE CHARTER

Nicholas Cooke.....".....1775-78
William Greene, Jr.....".....1778-86
John Collins.....".....1786-90
Arthur Fenner.....Federalist-Republican.....1790-1805
Paul Mumford (acting).....".....1805
Henry Smith.....".....1805-06
Isaac Wilbour.....".....1806-07
James Fenner.....".....1807-11
William Jones.....".....1811-17
Nehemiah R. Knight.....Democratic-Republican.....1817-21
William C. Gibbs.....".....1821-24
James Fenner.....Whig.....1824-31
Lemuel H. Arnold.....".....1831-33
John B. Francis.....".....1833-38
William Sprague.....".....1838-39
Samuel W. King.....".....1839-43

GOVERNORS UNDER THE CONSTITUTION

James Fenner.....Whig.....1843-45
Charles Jackson.....".....1845-46
Byron Diman.....".....1846-47
Elisha Harris.....".....1847-49
Henry B. Anthony.....".....1849-51

Phillip Allen.....	Democratic-Free Soil.....	1851-53
Francis M. Dimond (acting).....	1853-54
William W. Hoppin.....	American.....	1854-57
Elisha Dyer.....	Republican.....	1857-59
Thomas G. Turner.....	1859-60
William Sprague.....	1860-63
William C. Cozzens.....	1863
James Y. Smith.....	1863-66
Ambrose E. Burnside.....	1866-69
Seth Padelford.....	1869-73
Henry Howard.....	1873-75
Henry Lippitt.....	1875-77
Charles C. Van Zandt.....	1877-80
Alfred H. Littlefield.....	1880-83
Augustus O. Bourn.....	1883-85
George P. Wetmore.....	1885-87
John W. Davis.....	Democrat.....	1887-88
Royal C. Taft.....	Republican.....	1888-89
Herbert W. Ladd.....	1889-90
John W. Davis.....	Democrat.....	1890-91
Herbert W. Ladd.....	Republican.....	1891-92
D. Russell Brown.....	1892-95
Charles W. Lippitt.....	1895-97
Elisha Dyer.....	1897-1900
William Gregory.....	1900-01
Charles Dean Kimball.....	1901-03
Lucius F. C. Garvin.....	Democrat.....	1903

BIBLIOGRAPHY. Richman, *Rhode Island: Its Making and Meaning* (New York, 1902); Field, (ed.), *State of Rhode Island and Providence Plantations at the End of the Century* (Boston, 1903); Arnold, *History of the State of Rhode Island and Providence Plantations* (New York, 1859-60; 4th ed., Providence, 1894); Greene, *Short History of Rhode Island* (Providence, 1877); Bartlett (ed.), *Letters of Roger Williams* (Providence, 1882); Rhode Island Historical Society, *Collections* (9 vols., ib., 1827-97); *Proceedings* (21 vols., ib., 1872-92); *Publications; Rhode Island Historical Tracts, 1st series* (20 vols., ib., 1877-84).

RHODES (Lat. *Rhodus*, from Gk. Ῥόδος). An island now belonging to Asiatic Turkey and long an important, wealthy, and independent State of ancient Greece. It lies off the southwest coast of Asia Minor, from the nearest point of which it is distant about 12 miles. It is 49 miles long and 21 miles in greatest breadth, and is traversed in the direction of its length—from northeast to southwest—by a chain of mountains, which reach in Mount Atayros (the ancient Atabyrion) a height of 4070 feet. The present population is about 30,000, of whom two-thirds are Greeks. The island is governed by a Turkish pasha, but is in general neglected, and shows few traces of its ancient prosperity. Its climate is temperate and its valleys are fertile, producing oil, oranges, citrons, etc.

Rhodes rose into importance at a very early period. It is certain that Ialysus was a place of trade during the second millennium B.C., for Mycenaean vases have been found in its necropolis. When the island first appears in history it is peopled by Dorians who dwell in three cities, Lindus, near the centre of the east coast, with a good harbor, and still a town; Camirus, on the west coast; and Ialysus, also on the west coast, near the northern end of the island. These cities, with Calymna, Cos, and Halicarnassus, formed the Doric Hexapolis which later, by the expulsion or withdrawal of Halicarnassus, became a Pentapolis. During the seventh and sixth centuries B.C. the island shared in the commercial prosperity of the Greek States of Asia Minor. A colony was planted at Phaselis, on the east coast of Lycia, and, alone of the Asiatic Greeks, the Rhodians took part in the first colonizing of Sicily, where they settled Gela, according to the tradition, about B.C. 690. A hundred years later,

after an unsuccessful attempt at Lilybæum, another band settled the Lipari Islands. Secure from attack by land, and on friendly terms with the unaggressive naval powers of Phœnicia and Egypt, the island maintained its independence till the Persian conquest, and did not finally yield till after the Ionian revolt, at the beginning of the fifth century B.C. The Rhodians were among the Greeks who served with Xerxes, though their contingent was small. After the Greek victories, they joined the Delian League, thus passing ultimately into the Athenian empire. They revolted in B.C. 411, and in 408 the three cities combined to found a new capital of the island. This city, Rhodes (q.v.), henceforth represents the island. Excavations were begun on the Acropolis of Lindus in 1902 by Danish scholars, and in the first season the Propylæa and ancient Temple of Athena were discovered.

RHODES. The capital of the island of the same name, situated at its northern extremity, with harbors on the east side, and the Acropolis on a hill which rises abruptly from the west coast. The modern city, called Kastro, has a picturesque appearance from the sea as it rises gradually from the two harbors, now choked with sand. In ancient times the main harbor was fortified and could be closed. The present fortifications only include about one-fourth of the ancient city, and date largely from the fifteenth century. The place has preserved its mediæval aspect, and there are many traces on the stone houses of its occupation by the Knights of Saint John, besides the great castle, the hospital, and especially the straight and picturesque Knights' Road, lined with ancient buildings bearing coats of arms. The earthquakes of 1851, 1856, and 1863 wrought great destruction in the town. By the powder explosion of 1856 the Church of Saint John, built in 1500, and the Grand Master's palace, were badly damaged, and the two edifices were destroyed by the earthquake of 1863.

Rhodes was founded in B.C. 408, and was girt by strong walls, surmounted by towers, and provided with two excellent harbors. It soon attained wealth and a very important commercial position. The early years of the fourth century were marked by struggles between democracy and aristocracy, leading to interventions by Sparta and Athens. Rhodes joined the second Athenian League, but in B.C. 356, with Byzantium, Chios, and Cos, withdrew, thus bringing about the Social War, which ended in Athens conceding the independence of the allies. Rhodes, however, soon fell under the control of Mausolus of Caria, but again became free, though in B.C. 332 it voluntarily acknowledged Alexander. This King greatly favored the city, whose trade rapidly increased, though it was occupied by a Macedonian garrison. On the death of Alexander, B.C. 323, the Rhodians rose and expelled the intruders. The third and second centuries B.C. were the acme of Rhodian prosperity. Wealth had not corrupted the dignity and morality of the people. Art flourished, filling the city with statues and planting at the mouth of the harbor the famous Colossus (q.v.). A later school of art, probably in the first century B.C., produced the Laocoön. In the wars of the period the Rhodians seem to have sought to hold aloof unless their trading interests were threatened. Like the kings of Pergamum, they appealed to Rome as a better ally than their

powerful neighbors, and joined in the war against Philip V. of Macedon. Later, during the war with Perscus, they endeavored to check the Roman advance, and the Roman Senate punished this presumption by making Delos a free port, with damaging effect on the Rhodian trade. After the death of Caesar, whose side the Rhodians had taken against Pompeius in the civil war, they were defeated in a naval engagement by Cassius, who in B.C. 42 entered the city by force, massacred the hostile leaders, seized the public property, and rifled the temples. This visitation broke the power of Rhodes, but it long continued to maintain its prestige as a seat of learning. Even under the Roman Empire, Rhodes continued to maintain a nominal independence and was not attached to any province, except for brief periods, when in disgrace with the reigning Emperor. In the reorganization of the Empire by Diocletian this position was abolished, and Rhodes became the centre of the Province of the Islands. It was afterwards attached to the Byzantine Empire and shared its fortunes till in 1309 it was occupied by the Knights of Saint John of Jerusalem, who for over 200 years maintained themselves against the Turks, and even gained some foothold on the mainland. They withstood several sieges, notably one in 1480, but were attacked again in 1522 by Sultan Solymán the Magnificent, and after the most heroic resistance finally found their position untenable, and were forced to abandon the island. Consult: Berg, *Die Insel Rhodus* (Brunswick, 1862), with fine illustrations; Newton, *Travels and Discoveries in the Levant* (London, 1865); Guérin, *Voyage dans l'île de Rhodes* (2d. ed., Paris, 1880); Salzmann, *Nécropole de Camiros* (ib., 1875); Biliotti and Cottret, *L'île de Rhodes* (Rhodes and Compiègne, 1881); Tarr, *Rhodes in Ancient Times* (Cambridge, 1885); id., *Rhodes in Modern Times* (ib., 1887); Schumacher, *De Rhodiorum Republica* (Heidelberg, 1886); Gelder, *Geschichte der alten Rhodier* (The Hague, 1900).

RHODES, COLOSSUS OF. See COLOSSUS.

RHODES, CECIL JOHN (1853-1902). A South African statesman and financier, born at the vicarage of Bishops Stortford, Hertfordshire, England, July 5, 1853. In 1870 his name was entered at Oriel College, Oxford, but an affection of the lungs compelled him in the same year to sail for Natal, whence, in 1871, he made his way to the diamond fields at Kimberley. He speedily acquired a large fortune, and, with his health well restored, returned to matriculate at Oxford in 1873. From 1876 to 1881 he spent one half of the year at Oxford and at the end of that time took his B.A. and M.A. Early in life Rhodes gave evidence of the blending in him of the materialist and the dreamer. Shrewd in the advancement of his own interests, and not entirely unaffected by the loose ethics of the mining camp, he was possessed at the same time of a profound conviction of the virtues of the British imperial system, and he made it his life plan to extend the sway of the British Empire over South Africa. In 1880 he entered the Cape Parliament; there he directed his efforts toward the establishment of cordial relations between the English and the Dutch in the Colony, and was instrumental in bringing about the annexation of Bechuanaland in 1884. This was a forward step in the extension of British supremacy in South

Africa, and brought the young statesman into conflict with the Boer Republic of the Transvaal, whose policy was guided by the ambitious and astute 'Oom Paul' Kruger, Rhodes's one formidable rival to the end. In 1888 Rhodes obtained from Lobengula, King of the Matabele, the cession of the immense region north of the Limpopo, which speedily came to be known as Rhodesia (q.v.); and in October, 1899, the British South Africa Company was incorporated, with almost full rights of sovereignty over that territory. Rhodes was in fact the sole manager of the company's affairs, and he devoted to the development of the country the resources of the De Beers Consolidated Mines, a corporation controlling the entire diamond industry at Kimberley, organized by Rhodes in 1888.

In 1890 Rhodes became Premier of Cape Colony, retaining at the same time his post as managing director of Rhodesia. He effected much salutary legislation within the Colony, first definitely entered upon the scheme of a British Cape-to-Cairo railway; found time to crush a formidable insurrection of the Matabeles in 1893; yet found time, too, to play an unscrupulous game of politics in the Transvaal, where the discontent prevailing among the foreign inhabitants of Johannesburg afforded him the opportunity for plotting the overthrow of the South African Republic. The Jameson raid in December, 1895, coming before his schemes were fully matured, was a crushing blow for Rhodes, who now appeared before the world as the instigator of a piratical attempt on the government of a friendly nation. (See SOUTH AFRICA; JAMESON, LEANDER STARR.) He was forced to resign the Premiership of Cape Colony, and for a time his political influence was gone. For the next three years he devoted himself to the affairs of the Chartered Company, suppressed a second insurrection of the Matabeles in 1896-97, and hastened the northward advance of his transcontinental railway and telegraph lines. In 1898 he reëntered the Cape Parliament, and had made some progress toward regaining his predominant position in South African affairs, when the Boer war broke out. During the early part of the war he was besieged at Kimberley, where he was attacked by his old illness. He went to Egypt in the early part of 1901, but failing to find health there, returned in February, 1902, to Cape Colony, and died at Cape Town, March 26, 1902. He was buried on his estate in the Matoppo Hills, near Buluwayo, in Matabeleland.

Rhodes's character was the subject of much diverse criticism. By some he was regarded as preëminently a man of money, actuated entirely by selfish motives, and one who for the attainment of his ends did not scruple to plunge South Africa into war. To those of British inclinations he appeared rather as one of the great builders of empire, a descendant of Clive and Warren Hastings. This lineage, in great measure, cannot be denied Rhodes, though there may have been in him also a touch of Sir John Hawkins and Sir Francis Drake. Rhodes's will, by which he left almost his entire fortune for the purpose of educating the Anglo-Saxon youth to the idea of empire, radically modified previously formed estimates upon his character. (See RHODES SCHOLARSHIPS.) The various biographies of Rhodes naturally are prejudiced to a greater or lesser extent. "Vindex," *Political Life and*

Speeches of Cecil Rhodes (London, 1900), is eulogistic, but contains much original material; "Imperialist," *Cecil Rhodes, a Biography and Appreciation* (ib., 1897), is favorable and well written. The best life on the whole is that by Hensman, *Cecil Rhodes* (ib., 1902), favorable, but not altogether apologetic. Stead, in the *Review of Reviews* (1902), gives a remarkable study of the psychology of Rhodes.

RHODES, JAMES FORD (1848—). An American historian, born in Cleveland, Ohio, May 1, 1848. He was educated in the public schools and at the universities of New York and Chicago, but he did not graduate, though the degree of LL.D. was afterwards conferred upon him. He was Paris correspondent of the *Chicago Times* (1867-68) and made journeys of industrial investigation in Germany and England, which he continued afterwards in the Southern United States. Then he engaged in business in Cleveland, Ohio, until 1885, when he retired and devoted himself to a *History of the United States from the Compromise of 1850*, a political narrative and analysis of the events growing out of slavery, the Civil War, and the reconstruction era, giving special prominence to Congressional and other political debates and to characterizations of public men, and emphasizing the influence of public opinion. The first two volumes (1892) carry the narrative to 1860; the third (1895) to 1862; the fourth (1901) to the close of the war. He became president of the American Historical Association in 1899 and was awarded an important German prize for his researches. His narrative, although based mainly on Northern sources, is impartial and sober, and is generally considered to be the best work covering the period treated.

RHODES, LAW OF. A code apparently drawn up by the Rhodians at the time of their great naval power in the third century B.C., though it is only known from the references in Roman law. The code was declared binding by Antoninus Pius, in so far as it did not conflict with Roman law, but its provisions are not known, except that "if cargo is thrown overboard to lighten a ship, all must contribute to make good the loss incurred for the benefit of all," a doctrine still accepted in maritime law. The treatise, *Ius Navale Rhodiorum*, is nothing but a group of mediæval forgeries. See CONSOLATO DEL MARE; OLERON, LAWS OF.

RHODESIA, rōd'zi-ā or rō-dē'shī-ā, NORTH-ERN. A division of British Central Africa, under the administration of the British South Africa Company. It comprises the territory bounded by the Congo Free State and German East Africa on the north, the British Central Africa Protectorate and Portuguese East Africa on the east, the Zambezi River on the south, and Portuguese West Africa on the west (Map: Congo, E 6). It is divided into Northeastern and Northwestern Rhodesia, the latter being also known as Barotseland. Unlike Southern Rhodesia, Northern Rhodesia has been only slightly explored and is still practically held by the natives. Barotseland or Northwestern Rhodesia is under the rule of King Lewanika, who, however, is advised by a resident of the British South Africa Company. His chief kraal is on the eastern bank of the Zambezi, at Lialui. Gold and coal have been found. Barotesland is well watered and fer-

tile, but its climate is unhealthy. Northeastern Rhodesia is divided into nine districts, with Fort Jameson as the seat of administration. The population of Northern Rhodesia is estimated at about 400,000. The Europeans in Northeastern Rhodesia numbered 165 in 1901.

RHODESIA, SOUTHERN. A British South African protectorate under the administration of the British South Africa Company. It occupies the territory between the Zambezi on the north, the Limpopo on the south, Portuguese East Africa on the east, and the British Bechuanaland Protectorate on the west, comprising the countries of Matabeleland and Mashonaland and the districts of Banyai, Manica, and Makalaka (Map: Cape Colony, H 1). Its area is estimated at 175,000 square miles. The larger part of the country is an elevated veld, well wooded and studded with granite kopjes which attain a considerable height in Mashonaland. The country is well watered by the tributaries of the Zambezi and the Limpopo and is covered with a luxuriant vegetation. The climate is healthful in the elevated districts, which occupy the larger part of the country, but is malarial and oppressive in the valleys of the Zambezi and the Limpopo.

The mineral deposits of Southern Rhodesia include gold, coal, copper, silver, antimony, arsenic, and lead. Gold is found principally in the central part of Mashonaland in the valleys of the Umtali and the Imbesi rivers. The gold deposits of Southern Rhodesia show traces of ancient workings. Their exploitation has been hindered by the lack of transportation facilities and of labor. The total output from 1890 to 1902 amounted to 194,170 ounces. Extensive coal deposits were discovered in 1900 in the Wankies district, in the western part of Mashonaland, and a company has been formed for its exploitation.

Apart from its rich mineral resources, Southern Rhodesia possesses a fertile soil and is well adapted for grazing. From 1890 to 1901 there were surveyed over 18,000,000 acres of land. Good crops of European cereals are raised. But the development of agriculture as well as that of the mineral industries is crippled by the scarcity of labor. Salisbury, the capital, is connected by rail with Cape Colony as well as with Beira, on the coast of Portuguese East Africa. From Bulawayo the line is being extended through the Wankies coal fields to Victoria Falls on the Zambezi and from there it is proposed to continue the road through Northern Rhodesia to Lake Tanganyika. A light railway line has also been completed from Salisbury to the Ayrshire mine in the Lomagundi district. The roads are over 3000 miles long. Salisbury and Bulawayo have been organized into municipalities and are provided with all the institutions of modern cities.

The administration of Southern Rhodesia is vested in the British South Africa Company, but there is also a resident commissioner appointed by the Secretary of State for the Colonies. The executive council is composed of the resident commissioner, the administrators of the company, and not less than four members appointed by the company with the approval of the Secretary of State. The legislative council is made up of the administrator of the company, the resident commissioner, five members appointed by the company, and four members elected by the registered voters, two for each of the provinces of Mashona-

land and Matabeleland. The judges of the High Court are appointed by the Secretary of State from a list submitted by the company. The native affairs are under the control of a secretary who is assisted by native commissioners. The military police of the territory is under the control of the High Commissioner for South Africa. According to an informal census taken in 1901 Mashonaland contained 4021 Europeans, 328,729 natives, and 187 Asiatics; and Matabeleland 7011 Europeans, 162,211 natives, and 906 Asiatics.

In the first half of the nineteenth century the territory now known as Southern Rhodesia was held by the Matabeles, who were forced by the Boers to retreat north of the Limpopo. With the discovery of gold in that part of the continent Cecil Rhodes succeeded in concluding a treaty with Lobengula, under which the chief of the Matabeles bound himself not to enter into any agreement with any power without the approval of Great Britain. In 1880 the mining rights over the territory were also secured by Cecil Rhodes (q.v.) for a consideration of a monthly salary of £100 to Lobengula, 1000 rilles, and a large quantity of ammunition. A royal charter was obtained for the British South Africa Company in 1889, and a considerable military force was sent to explore the interior of the country. An uprising of the Matabeles in 1893 ended in the overthrow of Lobengula and the formal annexation of Matabeleland. A more serious uprising occurred after the withdrawal of the white police to Bechuanaland, in 1896. The rebellion soon spread to Mashonaland, and it was only with the assistance of troops dispatched from Natal and Mafeking that peace was restored in 1897.

BIBLIOGRAPHY. Greswell, *Geography of Africa South of the Zambezi* (London, 1893); Keane, *South Africa* (ib., 1895); Keltie, *Partition of Africa*, contains bibliography (ib., 1895); Thomson, *Rhodesia and Its Government* (ib., 1898); Dawkins, *Précis of Information Concerning Southern Rhodesia*, with bibliography (n.p. 1899); Hall and Neal, *The Ancient Ruins of Rhodesia* (New York, 1902).

RHODES SCHOLARSHIPS, THE. A number of stipends established under the will of Cecil John Rhodes (q.v.), who died in 1902, bequeathing a large part of his estate in trust for the purpose of maintaining a certain number of British, American, and German students at Oxford University, in the belief that "a good understanding between England, Germany, and the United States will secure the peace of the world, and that educational relations form the strongest tie." The founder suggested the following basis for awarding these scholarships: (1) Proficiency in literary and scholastic attainments, which was to count three-tenths; (2) success in outdoor sports, two-tenths; (3) qualities of manhood, etc., three-tenths; (4) qualities of leadership, two-tenths. Qualifications second and third were to be decided upon by a vote of the fellow students, first and fourth by the masters of the respective schools where candidates prepare. The number of scholarships to be thus distributed are as follows: Rhodesia, 9; Cape Colony, 12; Natal, 3; Australia, 18; New Zealand, 3; Canada, 6; Newfoundland, 3; Bermuda, 3; Jamaica, 3; two to each State and Territory of the United States, and 15 to Germany. The annual value of the Colonial and American scholarships is

£300, tenable for three years. Only one-third of the Colonial and one-half of the American scholarships are to be filled each year. The disposal of the German scholarships is at the pleasure of the Emperor.

In the United States the first qualifying examination, based on the Oxford Responsions, or the first Oxford public examination, was set down for 1904, and was to consist of Latin, Greek, and elementary mathematics. These examinations are to be held under the auspices of the State committees designated by the trustees for selecting suitable candidates for the scholarships. The chairmen of these committees are either the presidents of the State Universities, as is the case in most of the Western and Southern States, or the Presidents of certain prominent universities, as is the case in most of the New England and Eastern States. In California, Maine, Vermont, and Washington, appointments are to be made by the several chartered universities and colleges in rotation. Candidates must be from 20 to 25 years of age and must have attended two years at a recognized institution of higher learning. Scholars must be unmarried and citizens of the United States.

RHODIUM (Neo-Lat., from Gk. *ῥόδιος*, rose-like, from *ῥόδον*, *rhodon*, rose). A metallic chemical element that was discovered by Wollaston in 1804. It occurs with other members of the platinum group and alloyed with gold as 'rhodium gold,' or *rhodite*, a mineral found in Mexico. The element is separated by adding iron to the mother liquors from which platinum has been extracted. The precipitate thus obtained is fused with lead and litharge, after which lead, copper, and palladium are removed by dilute nitric acid, and the residue heated with barium dioxide, then washed and distilled with aqua regia to remove osmium. The remaining solution contains the rhodium, which is then isolated by a somewhat complicated process.

Rhodium (symbol, Rh; atomic weight, 103.01) is a white, hard, malleable metal that fuses at about the same temperature as platinum, and absorbs oxygen like that metal. It combines with oxygen to form a monoxide, a sesquioxide, a dioxide, and probably a trioxide. The metal itself, when added in small quantities to steel, is said to form an alloy that has exceedingly valuable properties.

RHO'DODEN'DRON (Neo-Lat., from Gk. *ῥοδδενδρον*, oleander, from *ῥόδον*, *rhodon*, rose + *δένδρον*, *dendron*, tree). A genus of about 200 trees and shrubs, including *Azalea* (q.v.), of the natural order Ericaceae. The species of *Rhododendron* proper have evergreen leaves, and many of them are of great beauty both in foliage and in flower. They vary in size from a few inches in height to trees 50 to 60 feet high and 18 inches in diameter. A few small species are natives of Continental Europe and of Siberia, but the greater number are found in temperate North America, and in the mountains of India. *Rhododendron maximum*, so designated when the far larger Indian species were unknown, is a common American ornamental shrub or small tree which forms impenetrable thickets in the Alleghany Mountains, and is magnificent when in flower. The flowers are large, in umbellate corymbs, varying in color from pale carmine to lilac. *Rhododendron ponticum*, a very

similar species with narrower and more pointed leaves, of the same color on both sides, is a native of Western Asia, and apparently also of Southern Spain. *Rhododendron cataebense*, a native of the southern Alleghanies, with large purple flowers, and *Rhododendron arboreum*, a native of Nepal, with very dense heads of large scarlet flowers and leaves 12 to 18 inches long, attaining a height of 30 to 40 feet in its native



RHODODENDRON (*Rhododendron ponticum*).

country, are fine and well-known species; *Rhododendron Californicum* and *Rhododendron macrophyllum* are among the most conspicuous species of the Pacific Coast region. Most of the extremely numerous varieties common in gardens and shrubberies have been produced from them. In many if not most of the hybrids, *Rhododendron Cataebense* enters, and in a list published in 1871, 250 named hybrids of this species are mentioned. Since that time the number has undoubtedly greatly increased.

Many splendid species of *Rhododendron* have been discovered in the Himalaya, the Khasia Hills, and other mountainous parts of India, by Hooker and others; and some of them have been introduced into cultivation. *Rhododendron grande* has very beautiful flowers $4\frac{1}{2}$ inches in diameter. *Rhododendron Maddeni*, *Rhododendron Griffithianum*, *Rhododendron Edgeworthii*, and others have white flowers. *Rhododendron Dalhousiae* is remarkable as an epiphyte, growing on magnolias, laurels, and oaks. It is a slender shrub, bearing from 3 to 6 white lemon-scented terminal bells, $4\frac{1}{2}$ inches long. *Rhododendron Nuttallii* has fragrant white flowers, said to be larger than those of any other species. All these belong to the Himalayas. In more southern latitudes, as on the Neilgherry Hills and on the mountains of Ceylon, *Rhododendron barbatum* prevails as a timber tree, a blaze of crimson when in flower. *Rhododendron Keysii* and *Rhododendron cinnabarinum*, natives of Northern India, have flowers with nearly tubular corollas. *Rhododendron ferrugineum* and *Rhododendron hirsutum* are small Alpine shrubs from 1 to 3

feet in height with umbellate clusters of carmine-colored flowers among the finest ornaments of alpine scenery. They are called *alpenrose* (alpine rose) by the Germans, and are not easily cultivated in gardens. The flora of the Himalaya contains a number of similar small species. *Rhododendron setosum*, a dwarf shrub with strongly scented leaves, clothes the mountains in Eastern Nepal at an elevation of 12,000 feet and upward, with a green mantle, brilliant with flowers in summer. *Rhododendron nivale* is the most alpine of woody plants, spreading its small woody branches close to the ground, at an elevation of 17,000 feet in Sikkim. *Rhododendron lapponicum*, a procumbent shrub, with small flowers, grows as far north as human settlements have reached in Europe and Asia. An oil obtained from the buds of *Rhododendron ferrugineum* and *Rhododendron hirsutum* have been used by the inhabitants of the Alps under the name *olio di marmotta*, as a remedy for various ailments. The flowers of *Rhododendron arboreum* are said to be eaten in India, and Europeans make a jelly of them. The wood of some of the larger species is white, hard, and close-grained, and has been recommended as a possible substitute for boxwood. *Rhododendrons* are not of difficult culture, a soil containing plenty of leaf mold and protection from drought and winter scalding being the prime necessities for growing the hardier species in shrubberies and parks. See Colored Plate of AZALEAS AND RHODODENDRONS.

RHODONITE (from Gk. *ῥόδον*, *rhodon*, rose).

A mineral manganese silicate that crystallizes in the triclinic system, has a vitreous lustre, and is usually red, although sometimes green or yellow. It occurs frequently in association with iron and zinc ores, and is found in Sweden, the Harz, the Urals, and in the United States at various localities in Massachusetts, and in Sussex County, N. J., where part of the manganese is replaced by zinc, giving rise to a variety known as *fowlerite*. The massive varieties of this mineral, especially those found in the Ekaterinburg District in the Urals, are used for ornamental purposes, as for table tops, etc., while varieties from other places are used to a limited extent as gems.

RHODOPHYCEÆ (Neo-Lat. nom. pl., from

Gk. *ῥόδον*, *rhodon*, rose, + *φύκος*, *phykos*, seaweed). The red algae. The most beautiful of the four great groups of algae. Some are very complex in structure, but in general they show less vegetative differentiation than do the brown algae (Phaeophyceæ, q.v.). Their peculiarities lie chiefly in a highly developed method of sexual reproduction, resulting in a complex fruit (cystocarp), which contains the carpospores. (Figs. 1, 2.) The male cells (spermatia) are non-motile, and fuse with a thread-like female receptive organ (trichogyne). There is also a form of asexual reproduction generally of four special spores (tetraspores). (Fig. 1.) Most Rhodophyceæ are red or reddish brown, a color due to a peculiar pigment (phycoerythrin) which obscures the green pigment (chlorophyll).

The form of the body ranges from minute filaments of great delicacy to broad membranes and thick cartilaginous fronds. Some of the membranous forms are several feet long (Delesseria), and may be differentiated into a stem and leaf-like out-growths. Others form filamentous branching tufts (*Callithamnion*, *Dasyu*). Some groups bear

protruding fruits resembling urns (Polysiphonia, Fig. 2), others are pinnately branched (Ptilota), others with incurved tips (Cerami-

Pflanzenfamilien (Leipzig, 1887 et seq.); Murray, *Introduction to the Study of Seaweeds* (London, 1895).

RHODO'PIS (Lat., from Gk. Ῥοδῶπις). A famous Greek courtesan, a native of Thrace. At one time she was a fellow slave of the poet Æsop. Later she was carried to Naucratis, in Egypt. While she plied the trade of hetæra there Charaxus, brother of Sappho, fell in love with her and ransomed her at a great price. She was attacked by Sappho in a poem. After her liberation she continued to reside in Naucratis.

RHOMBOID. See PARALLELOGRAM.

RHOMBUS. See PARALLELOGRAM.

RHONDDA, rôn'd'dâ. An important and populous coal-mining district, now a municipality of Glamorganshire, Wales. It is situated amid picturesque valley scenery on the Rhondda River, near Merthyr Tydfil. Population, in 1891, 88,350; in 1901, 113,700.

RHONE, rôn (Fr. *Rhône*; Lat. *Rhodanus*). The principal river of Southeastern France. It rises at an altitude of 7550 feet in the Rhone Glacier on the south slope of the Dammastock, a peak of the Urner Alps in South Central Switzerland (Map: France, L 7). It flows first in a general southwest course through Southern Switzerland and into France as far as Lyons, then due south until it empties into the Gulf of Lyons in the Mediterranean Sea, 25 miles west of Marseilles. Its length is 504 miles. Its upper course is through the great valley lying between the Bernese and the Pennine Alps, which forms the Swiss Canton at Valais. Here it grows rapidly by taking up a number of short but voluminous mountain torrents fed by the great glaciers which cap the mountain ranges on either side. At Martigny the valley is narrowed and the river makes a sharp turn to the northwest, becomes then navigable below Saint-Maurice, and enters the eastern end of Lake Geneva. It leaves the lake at its western end at Geneva, resuming its southwest direction, quits Swiss territory, and soon after passes through the Jura Range in a deep and narrow gorge, where its width is decreased from 350 to 25 yards. Here it formerly disappeared through a subterranean channel known as the Perte du Rhône, but the rocks which covered it were removed in 1828. After leaving the gorge it becomes again navigable, and remains officially so to its mouth.

Its fall from Lyons to the sea, a distance of 208 miles, is over 500 feet, or 2½ feet per mile. Its course below Lyons lies in a broad, fertile, and beautiful valley between the Alps and the Cévennes. It receives here two large tributaries, the Isère and the Durance, the latter joining it at Avignon, below which town the river flows through a sandy and arid tract which was formerly a gulf of the sea. Its delta, whose main arms are the Grand and the Petit Rhône, which form the Ile de la Camargue (see BOUCHES-DU-RHÔNE), is growing at the rate of nearly 200 feet annually, owing to the large quantities of sediment carried by the stream. The navigation of the Rhone, owing to the swift current, the shifting of the bed, and the numerous islands, is very difficult even for steamers, and especially on the upstream route. Extensive regulating works have to some extent improved the waterway above the delta, and the shifting and sand-barred mouths of the latter have been obviated by a short canal

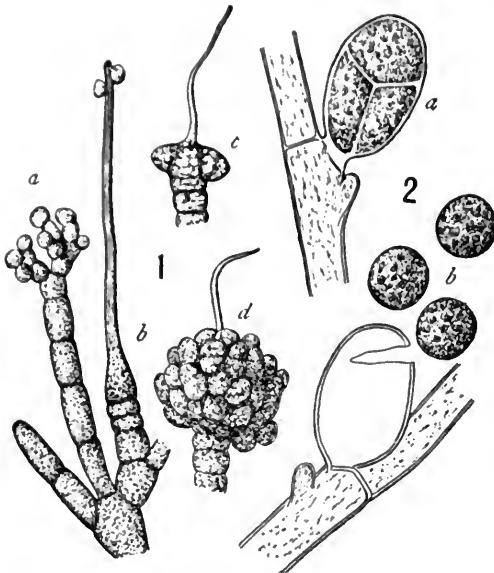

FIG. 1. RED ALGÆ.

1, *Nemallon*, sexual branches, showing antheridia (a) and carpogonium (b) with trichogyne to which two spermatia are attached, beginning of a cystocarp (c), and an almost mature cystocarp (d); 2, *Callithamnion*, showing sporangium (a) and three discharged tetraspores (b).

um). Most of the filamentous and membranous species, especially those which grow in quiet waters, are very delicate. Many forms on surf-beaten coasts develop large and strong cartilaginous fronds. Several of these firmer forms yield a jelly when placed in hot water; for instance, agar-agar is derived from species found in Ceylon, Java, and Madagascar, and *Chondrus crispus* furnishes most of the 'Irish moss' used in cookery. These preparations consist mainly of mucilage of little or no nutritive value, derived from intercellular spaces and swollen cell-walls.

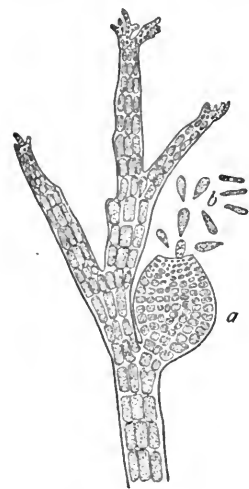

FIG. 2. POLYSIPHONIA.

Showing branching, a cystocarp (a), and escaping spores (b).

Perhaps the most remarkable group of the Rhodophyceæ is the Corallines, with highly specialized fructifications and tetraspores borne in differentiated conceptacles. Some are branched, with jointed segments, others have the form of convoluted nodules. They are so incrustated and pervaded with lime as to resemble coral.

Consult: Engler and Prantl, *Die natürlichen*

running from the Gulf of Foz to the main stream, while other canals connect the latter with several ports on the Gulf of Lyons, one being projected to the port of Marseilles. Canals also connect the Saône with the Loire, the Seine, and the Rhine.

Consult: Barron, *Les fleuves de la France: Le Rhône* (Paris, 1900); Lenthéric, *Le Rhône, histoire d'un fleuve* (ib., 1892); Wood, *In the Valley of the Rhone* (London, 1899); Lombard-Gerin, *Notes sur le tonage du Rhône* (Paris, 1900).

RHÔNE. A southeastern department of France (Map: France, L 6). Area, 1077 square miles. It lies almost wholly in the basin of the Rhone and its great affluent the Saône, its eastern boundary being formed by these rivers. The surface is almost entirely mountainous or hilly, the chief level stretches being the valley of the Saône and the district about Lyons. The principal productions are wine and silk. The wines are famous for their excellent quality. About one-tenth of the surface is in vineyards. Silks are manufactured extensively, and numerous other branches of manufacture are actively carried on. Capital, Lyons (q.v.). Population, in 1896, 839,239; in 1901, 843,179. Consult: Varnet, *Géographie du département du Rhône* (Lyon, n. d.); Lenthéric, *La région du Bas-Rhône* (Paris, 1881); Joanne, *Géographie du département du Rhône* (ib., 1900).

RHÔNE, BOUCHES-DU-. A department of France. See BOUCHES-DU-RHÔNE.

RHUBARB (ML. *rhubarbarum*, *rheubarbarum*, *reubarbarum*, *rheum barbarum*, from Gk. ῥῆον βάραβαρον, *rhubarb*, from ῥῆον, *rheon*, *rhubarb*, and βάραβαρος, *barbaros*, barbarous, foreign), or PIE PLANT (*Rheum*). A large, coarse genus of Asiatic herbs of the natural order Polygonaceæ, closely allied to *Rumex* (dock and sorrel). The rhubarb of commerce, which comes from inland parts of China or Chinese Tartary, is produced by an unknown species.

The leafstalks of rhubarb contain an agreeable mixture of citric and malic acids, and when young and tender are highly esteemed for stewing and preserving, for which purpose the plants are widely cultivated in temperate and cold countries. Several species have been introduced into cultivation for their leafstalks. *Rheum Palmatum*, the first species known, and once believed to yield Turkey rhubarb, has roundish green leafstalks and half-palmate leaves. Its stalks are inferior for the table. *Rheum undulatum*, *Rheum rhaponticum*, and *Rheum hybridum* have broad, heart-shaped, undivided leaves, upon flattened, often reddish leafstalks grooved on the upper side. In some of the finest varieties the flesh is red. In Continental Europe rhubarb is grown more as a foliage plant than as a vegetable. Rhubarb is propagated by seed, or by dividing the roots. It prefers a light rich soil, which should be heavily manured every year. The plants are placed three or four feet apart, according to the size of the variety. Rhubarb is forced in winter and early spring by having pots or barrels inverted over it, and fresh litter or horse manure heaped around. It is also forced under greenhouse benches and in cellars, the roots being frozen before removal to the heat. As a medicine rhubarb roots are considered to be cathartic, astringent, and tonic. See Plate of VEGETABLES.

RHUMB LINE, or **LOXODROMIC LINE.** The course of a ship which is sailing in an oblique direction always to one point of the compass. It is a curve on the surface of the terrestrial sphere which has the property of cutting all meridians at the same angle. The rhumb line appears as a straight line on Mercator's projection. (See MAP.) A ship sailing obliquely to the direction of the North Pole (say, two points off) would wind round it in infinite circuits, always approaching nearer, but never reaching it. In this property, as well as in others, the loxodromic line is analogous to the common logarithmic spiral. See LOXODROME; NAVIGATION; SAILINGS.

RHUS. A genus of shrubs and trees. See SUMACH; POISONOUS PLANTS.

RHYL, ril. A popular tourist and sea-bathing resort in Flintshire, Wales, at the mouth of the Clwyd, 10 miles northwest of Denbigh (Map: Wales, C 3). It has a fine beach, esplanade, promenade pier, aquarium, and winter garden, golf links, etc. Zinc ore is mined in the vicinity. Much municipal activity has been evinced in public improvements to add to the natural attractions. The town owns its water-works, gas, and electric lighting plants, markets, and cemetery; maintains promenades, marine walks, and recreation grounds; and has installed modern sewage disposal works. Population, in 1891, 6500; in 1901, 8500, with a transient summer population of 20,000.

RHYME, or **RIME** (AS., OIG. *rim*, number, Ger. *Reim*, rhyme). In the broader meaning, a poem, or numbered or versified composition, as when we speak of the "Mother Goose Rhymes;" also, by a slight extension, a synonym for poetry in general. In the more technical sense rhyme is the recurrence of the same sound, in a verse or verses, in syllables having corresponding metrical values. Rhymes are of three general types: they may be formed by the correspondence of the initial sounds of the rhyming syllables, in which case they are called head-rhyme or alliteration; they may be formed by the correspondence of the vowel element, in which case, if the succeeding consonant sounds differ in the rhyming syllables, we have assonance, while if the succeeding consonants are the same in sound, or if there are no consonants, we have true rhymes. Alliteration was the characteristic rhyme of the ancient Teutonic poetry, while assonance was first systematically developed in the early Romance literatures. In modern literature both of these types have yielded in large measure to the more perfect music of the true rhyme, but they have not, as is sometimes stated, ceased to be in good form. Most commonly, in modern poetry, they are used in connection with rhyme. Thus, in *The Symphony*, Sidney Lanier combines rhyme and alliteration:

Woe hilt that cunning trades in hearts contrives!
Hase love good women to base joving slaves,
If men loved larger, larger were our lives;
And wooed they nobler, won they nobler wives.

And in the same poem rhyme and assonance are combined in:

Vainly might Plato's brain revolve it;
Plainly the heart of a child could solve it.

The placing of rhyming words in the verse structure varies with the different kinds or with varying types of verse-composition. Alliteration is characteristically complete in a single verse,

and in Anglo-Saxon poetry usually consisted of a three-fold repetition of the alliterated sound, as in the third and fourth lines of the first quotation above given. End-rhymes, on the other hand, may be completed within a single verse, but are ordinarily between two or more verses, the number being determined by the stanzaic structure or the taste of the poet; in the rondeau, for instance, one rhyme is repeated eight times and the other five. Not infrequently poems are constructed having both styles of rhyme, as in Shelley's *Cloud*:

I bring fresh showers for the thirsting flowers,
From the seas and the streams;
I bear light shade for the leaves when laid
In their noonday dreams.

Rhymes, of whatever sort, are in modern poetry always placed upon accented syllables, and end-rhymes are characteristically placed either at the end of the verse or at the end of the colon, as in the first and third verses here given. They may, however, be placed elsewhere, even at the beginning of the verse, as in the second citation from Lanier's *Symphony*. In complicated structures they are often used with less regard to regularity, internal rhymes being carried on in verse endings, or placed within the verse itself without regard to caesural pauses. In general, however, internal rhymes irregularly placed convey an effect of assonance rather than of true rhyme, and many poets make use of assonance in preference to it, when so placed. As to the relation of rhyming verses, this is determined either by the form of the stanza or in non-stanzaic rhymed composition by some set order, as the couplet, which the poet may determine, or again the rhymes may occur irregularly. Stanzas are of indefinite variety, and the poet is at liberty to invent whatever forms may please his ear.

Not all languages agree as to the nature of the adequate rhyme. In English, words which rhyme perfectly must agree in all the sound elements succeeding the initial element of the last accented syllable, and in this element they must differ. In French, on the other hand, such a rhyme is only *suffisante*, the *riche* or perfect rhyme having identical *all* the elements in the rhyming syllables. Thus, *grows* and *rose* form a perfect rhyme in English, *rose* and *arrose* in French. Rarely in English an identical rhyme is used provided the sense be changed, as *reign* with *rein*, *lo* with *low* (change of sense is also always necessary in French), but the change must be more than a mere negation; in no case should *close* and *disclose* be rhymed, nor words having the same root, as *compute*, *dispute*. When a word is repeated to rhyme with itself, as is frequently the case in Poe's poems, for example, it has the value of a refrain rather than of a true rhyme, and in all such cases there should be at least one other word rhymed with it. There are a few words in English the pronunciation of which may be altered to suit the needs of rhyme; thus, *wind* (noun) may be rhymed with *blind*, etc., but this is only a form of poetic archaism, reverting to the original pronunciation of the word. Rhymes are 'masculine' and 'feminine;' masculine when the rhymed syllable is also the chief accent of the word, *aver*, *deter*; *mar*, *tar*; feminine when it is followed by unaccented syllables, *marry*, *tarry*; *tenderly*, *slenderly*. Sometimes a secondary accent is made to carry the rhyme, but in such cases it is generally rhymed

with a word having no great rhetorical stress or having other words rhymed with it. The use of feminine rhymes is the less common in English, and they are never to be found in the complicated form to be met with in some other languages. (Compare the Persian under RUBAIYAT.) They occur most freely in satirical verse, which often takes liberties with rhyme that no serious poetry could tolerate. An example from Lowell is:

Though you brag of your New World, you don't
half believe in it;
And as much of the Old as is possible weave in it.

Rhyme was of relatively slight value in verse which depended upon quantity rather than accent and in languages which abounded in elaborate inflections. It was not until the classical Latin gave way to the vulgar speech that rhyme became the rule, first in the early hymns of the Christian Church. It is possible that an ancient Celtic influence may have aided this development, since the Celts used rhyme in the oldest Celtic poetry preserved to us. Rhyme was elaborately developed among the Persians and Arabs of mediæval times, but it is not known from what influence it was derived. It seems most probable that the simple repetitions, in which most primitive poetry abounds, form the basis from which rhyme naturally arises. Consult: Corson, *Primer of English Verse* (Boston, 1893); Gummere, *Handbook of Poetics* (Boston, 1895); Schipper, *Englische Metrik* (Bonn, 1881-88).

RHYNCHOCEPHALIA, *rîŋ'kò-sě-fā'li-á* (Neo-Lat. nom. pl., from Gk. ῥύγχος, *rhynchos*, snout + κεφαλή, *kephalē*, head). An order of primitive reptiles, represented in modern times by a single survivor, Sphenodon or Hatteria, which lives on islands off the coast of New Zealand, and in ancient times by a large number of creatures whose fossil remains are found in Permian, Mesozoic, and Eocene rocks. This order received its name from the beak-like rostrum on the skulls of some of its typical species. It includes the earliest and most primitive reptiles, and also the birds. The suborder Proterosauria;

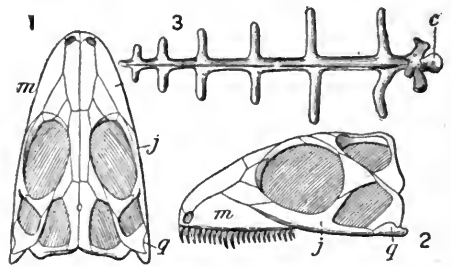

RHYNCHOCEPHALIA.

1, Skull of Paleohatteria, superior aspect; 2, the same, lateral aspect; 3, a dorsal vertebra of *Nassaurus claviger*: c, center; j, jugal; m, maxilla; q, quadrate bone.

or Proganosauria, includes the most primitive forms, in which the teeth are of uniform shape and parts of the skeleton are still cartilaginous. Palæohatteria from the Lower Permian of Saxony is the earliest known reptile. It had a lizard-like body about 18 inches long, with a long tail, large head, very large eyes, and numerous large conical teeth that are fused with the jaw bones, and also small teeth on the palate. The

legs were strong and the feet were provided with five clawed toes and adapted to progress on land. A suborder, Pelycosauria, includes several curious though imperfectly known genera in which the anterior teeth are different from the posterior and the dorsal vertebræ are furnished with greatly elongated neural spines. The *Rhyncho-*

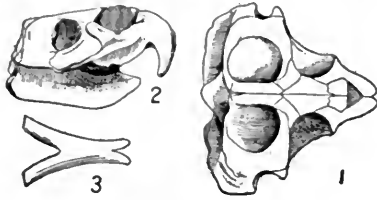

THE RHYNCHOCEPHALIC SKULL.

Cranium of *Hyperodapedon Gordoni*: 1, superior aspect; 2, lateral aspect; 3, mandibular symphysis.

cephalia vera includes the most highly specialized forms, which attain their maximum of evolution and widest geographic distribution in late Triassic time. They are characterized by more complete ossification of the skeleton, by reduction of the abdominal ribs, and by having uniform marginal teeth.

BIBLIOGRAPHY. Von Zittel and Eastman, *Text-book of Paleontology*, vol. ii. (London and New York, 1902).

RHYNCHONEL/LA (Neo-Lat. nom. pl., from Gk. ῥύγχος, *rhynchos*, snout). A genus of brachiopods, scarce but widespread in modern seas, but very abundant anciently, and represented in almost every geological formation from the Ordovician upward. About 600 species have been described, mostly from the Mesozoic rocks, of which the Jurassic and Cretaceous groups are especially prolific. Most of the ancient forms are doubly convex shells with prominent though small ventral beaks, and with surfaces marked by strong, usually angular radial plications, and with a more or less elevated median fold and sinus. The structure of the shell in most genera is non-punctuate, a character by which the species may most readily be distinguished from the closely similar species of Terebratulidae. Consult: Hall and Clarke, *Paleontology of New York*, vol. viii., part ii. (Albany, 1894); Davidson, "Monograph of the Recent Brachiopoda," *Transactions of the Linnean Society*, vol. iv. (London, 1886-88).

RHYOLITE (from Gk. ῥυαξ, *ryhax*, stream, especially of lava, from ῥεῖν, *rhein*, to flow + λίθος, *lithos*, stone), LIPARITE, NEVADITE. An igneous rock of porphyritic texture and siliceous composition, generally with a crumpled, banded (rhyolitic) texture, due to the arrangement of its constituent minerals by flowage. Rhyolites are also frequently glassy, vesicular, scoriaceous, or pumiceous. When compact and massive, rhyolites are designated as rhyolite porphyries (formerly called quartz porphyries, and then supposed to be of geological age older than the Tertiary). In chemical composition rhyolites have about the same range as the granites. They average: Silica, 75 per cent.; alumina, 13 per cent.; sesquioxide and protoxide of iron, each 1 per cent.; oxide of lime, 1 per cent.; oxide of sodium, 3 per cent.; oxide of potassium, 6 per cent. Varieties rich in oxide of sodium are designated soda-rhyolites

(pantellerites). Rhyolites are for the most part surface lavas or are intruded in other rocks as dikes or sills. Very extensive areas of rhyolite are found in the Cordilleran mountain system of the Western Hemisphere. Rhyolites when of unusually coarse grain are now designated by the variety name, Nevadite.

RHYS, rës, ERNEST (1859—). An English author, born in London, July 17, 1859. He was educated at schools in Carmarthen, South Wales, at Bishop-Stortford and at Newcastle-on-Tyne, and became a mining engineer (1877). In 1885 he abandoned the profession for general literature. In 1887 he came to the United States on a lecturing tour. His writings on Welsh subjects are popular and are to be distinguished from those of the profound Celtic scholar John Rhys (q.v.). He edited the Camelot series of popular reprints and translations (65 vols., 1886-91); Dekker's *Plays* for the Mermaid Series (1888); *The Lyrio Poets* (12 vols., 1894-99); *Literary Pamphlets* (1897); and other works. His writings include: *The Great Cockney Tragedy* (1881); *A London Rose and Other Rhymes* (1894); *Welsh Ballads and Other Poems* (1898); *Frederick Lord Leighton*, a biography (1898, which had been preceded by an earlier study in 1895); and two romances, *The Fiddler of Carne*, having a Welsh heroine (1896), and *The Whistling Maid* (1900).

RHYS, JOHN (1840—). A Welsh author and professor of Celtic at Oxford since 1877. He was born in Cardiganshire in 1840 and educated at Bangor Normal College, Jesus College, Oxford, the Sorbonne, Heidelberg, and Leipzig. In 1871 he became school inspector for Flintshire and Denbighshire; fellow of Jesus College in 1881; Hibbert lecturer, 1886; Rhind lecturer on archæology in Edinburgh, 1889; and has seen service on numerous commissions on education, reforms and land movements connected with Wales. His works are: *Lectures on Welsh Philology* (1877); *Celtic Britain* (1882); *Celtic Heathendom* (1886); *Studies in the Arthurian Legend* (1891); *Inscriptions and Language of the Northern Picts* (1892); *Rhind Lectures on the Early Ethnology of the British Isles* (1890-91); *Celtic Folk-Lore* (1901); and in conjunction with Mr. D. Brynmor-Jones, *The Welsh People* (1900). Professor Rhys has also coöperated in the production of several important editions of Welsh texts and his contributions to Celtic scholarship have been various and important. To his native and unsurpassed knowledge of Wales and of the Welsh language he has added wide research in the other languages of the Celtic group, and in the history and antiquities of the Celtic peoples. Besides doing valuable linguistic work in early Welsh and Manx, he has made himself the chief living authority on the Ogam inscriptions. His studies on folk-lore, mythology, and religion have been learned and brilliant, but rather bold in conjecture. The editions of Welsh texts which he has brought out in collaboration with Professor Morris Jones and Mr. J. Gwenogvryn Evans are models of accurate editing.

RHYTHM (Lat. *rhythmus*, from Gk. ῥυθμός, *rhythmos*, rhythm, time, measure, from ῥεῖν, *rhein*, Skt. *aru*, to flow). A complex mental process which has been defined, from different points of view, as a temporal perception and as a regulated emotion. Objectively regarded, it is a regularly measured and regularly stressed movement in

time. Regarded as preception, it is a series of auditory or tactual (never of visual) sensations, which recur at regular intervals and show a regular variation of intensity. In other words, our interpretation of rhythm as a perception simply translates the objective definition into subjective terms. There are, however, certain phenomena of the rhythmical consciousness which have led some psychologists to accept the other view, that rhythm is a kind of emotion. (1) If we subject an observer to a series of regularly recurring and similar sounds, we find (within definite time limits) that in the majority of cases the series is apprehended as rhythmical. The most familiar instance is that of listening to the ticking of a clock; the beats of the pendulum are heard, not as tick, tick, tick, but as *tick, tick, tick, tick*, etc. (2) We can produce the effect of rhythm not only by changing the objective intensity of regularly recurring stimuli, but also (a) by changing their duration, (b) by changing the interval between them, and (c) by changing their quality. That is to say, the intensities may remain constant throughout, and yet (if some one of these three variations is introduced into the series) the observer will have the illusion of intensive fluctuation, and will therefore be constrained to hear the series as rhythmical. (3) There is a strong tendency to 'express' rhythm, to accompany a

first beat of every bar has an accent, while in examples 2 and 3, although every bar retains its own accent, there is no special accent or emphasis at the beginning of the rhythmic figure. Accent thus deals with the notes of a single measure; rhythm with groups of notes extending over one or (generally) more measures. Music becomes intelligible only when these larger rhythmic divisions are clearly grasped. A cultivated ear soon tires of constant regularity of rhythm. To avoid monotony, composers resort to various means of breaking the rhythm, such as inserting an odd bar between the regular number of bars composing a rhythmic group, alternating two-bar with three-bar rhythms, or making the weak ending of a phrase coincide with the strong beginning of a new phrase (thus really causing the elision of a bar).

The only simple rhythms are those consisting of a group of notes filling two or three measures (duple and triple rhythm). All rhythms extending over more than three bars are compound. Thus every four-bar rhythm can be resolved into two groups of two bars each. A six-bar rhythm may consist of two groups of three bars each or three groups of two bars each. The Scherzo of Beethoven's *Ninth Symphony* (Ex. 4) begins with a theme in quadruple rhythm (two groups of duple rhythm).

Example 4.



series of rhythmical sounds by movements of head, foot, or hand.

RHYTHM IN MUSIC. The regular recurrence of tone-groups in which the individual notes are symmetrically arranged according to accent and time-value. Rhythm is entirely independent of melody or harmony (q.v.) and can, therefore, be indicated by notes without reference to pitch.

While every bar retains its own accent (marked —), there is a particular emphasis (marked ≡) upon the first and fifth bars (the beginnings of the rhythmic group) and a less emphasis (marked =) upon the third and sixth bars. The effect produced is the same as if the phrase were written in more moderate tempo as follows:

Example 5.



The following examples illustrate this:

After a number of bars Beethoven changes this

Example 1.—POLONAISE. 3/4



Example 2.—FANDANGO. 3/8



Example 3.—BEETHOVEN (Symphony No. 7). 6/8



In the first example the characteristic rhythmic quadruple to triple rhythm:



figure is contained within the limits of a single which produces the following effect:



measure; whereas in the other two examples it fills two measures. It is evident from this that rhythm is not synonymous with accent; for the

A loose use of language has created a great deal of confusion in regard to the meaning of the term rhythm. The word is often carelessly

employed instead of *accent* or *time*, both of which terms are only subdivisions of rhythm. See ACCENT; SYNCOPATION; TIME.

RIAD, rē-ād', or **RIYAD**. The Wahabi capital in the Sultanate of Nedjed, Central Arabia (Map: Turkey in Asia, R 11). It is built on an extensive open plain in a well-cultivated region. In the centre of the city is a large square containing the market-place and the great mosque. The city is a resting-place for pilgrims on the way from Persia to Mecca and Medina. Riad dates from 1824. Population (estimated), 30,000.

RIALL, rī'əl, Sir PHINEAS (1775-1851). A British soldier. He was born in Ireland, entered the British Army as an ensign in 1794, and soon rose to be major. In 1804 he was attached to the Fifteenth Foot, served for several years with distinction in the West Indies, and in 1810 was brevetted colonel. Three years later he was promoted major-general, and was sent to Canada to operate against the forces of the United States. In the following winter he destroyed Black Rock, Buffalo, and other villages on the American border, and during the next summer commanded the troops which opposed the invading army under General Jacob Brown. On July 5th he was defeated in the battle of Street's Creek, or Chippewa. On July 25th at the battle of Lundy's Lane (q.v.), where he held the immediate command of the British forces, he was severely wounded and was taken prisoner. In 1816 he was appointed Governor of Grenada, and administered the affairs of that island for several years. He was promoted lieutenant-general in 1825, was knighted in 1833, and was made a full general in 1841. Consult Morgan, *Sketches of Celebrated Canadians and Persons Connected with Canadian History* (Quebec, 1862).

RIALTO, rē-āl'tō (It., from *rio*, *rivo*, brook + *alto*, deep, high). The chief bridge of Venice, a graceful structure spanning the Grand Canal by a single marble arch 74 feet in length, and 32 feet high. The name is derived from Rivoalto, the island on which Venice was founded. Two rows of shops divide the bridge into a broad road and two narrow side passages. The bridge and adjacent district are referred to in Shakespeare's *Merchant of Venice*.

RIANT, ré-ān', PAUL EDOUARD DIDIER, Count (1836-88). A French scholar and historian, born in Paris. He was known as the foremost scholar of his day on the subject of the Crusades, possessed of a keen historical sense, skill in research, and marked scholarship in the interpretation of documents. In 1875 he founded the Société de l'Orient Latin, whose object was the publication of geographical and historical documents appertaining to the Crusades and Palestine. He collected an excellent library in the history of the Crusades, and in Scandinavian literature, of which Harvard University obtained the former portion, and Yale the latter. Among the numerous volumes written and edited by him are *Expéditions et pèlerinages des Scandinaves en Terre Sainte au temps des croisades* (1865); *Magistri Thadei Neapolitani Historia de Desolatione et Consecratione Civitatis Aconensis 1291* (1874); and *Le changement de direction de la quatrième croisade* (1878). The *Catalogue de la bibliothèque de feu H. le Comte Riant* appeared at Paris in 1896-99 (3 vols.).

RIAZAN, rē-ā-zān'y'. A government and a city of Russia. See RYAZAN.

RIB (AS. *ribb*, OHG. *rippi*, Ger. *Rippe*; connected with OChurch Slav. *rebro*, *rib*, and probably with Ger. *Rebe*, tendril, OHG. *hirmireba*, brain covering, skull). An elastic arch of bone, which, with its fellows, constitutes with the vertebral column behind, and the sternum or breastbone in front, the osseous part of the walls of the chest. In man there are 12 ribs on each side. The first seven are more directly connected through intervening cartilages with the sternum than the remainder, and hence they are termed *vertebro-sternal* or *true ribs*; while the other five are known as *false ribs*, and the last two of these, from being quite free at their anterior extremities, are termed *floating ribs*. A glance at a skeleton, or at a plate representing the articulated bones, will show that the ribs vary very considerably both in their direction and size. The upper ribs are nearly horizontal, but the others lie with the anterior extremity lower than the posterior, this obliquity increasing to the ninth rib, and then slightly decreasing. They in-

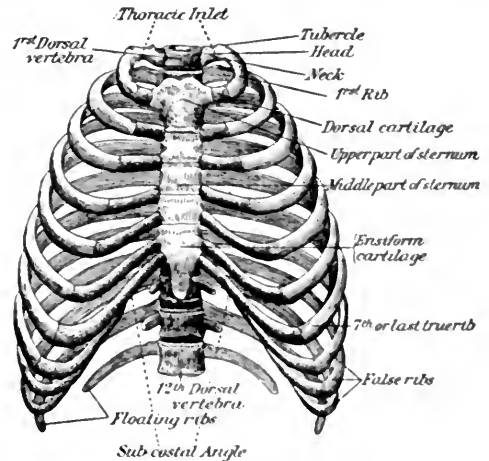

FIG. 1. THORAX, FRONT VIEW.

crease in length from the first to the seventh, and then again diminish. The spaces between the ribs are termed the *intercostal spaces*. On examining a rib taken from about the middle of the series, we find that it presents two extremities (a posterior or vertebral, and an anterior or sternal), and an intervening portion, termed the body or shaft. The posterior extremity presents a head, a neck, and a tuberosity. The head is marked by two concave articular surfaces divided by a ridge, the lower facet being the larger. These surfaces fit into the cavity formed by the junction of two contiguous dorsal vertebrae, and the ridge serves for the attachment of a ligament. The neck is a flattened portion proceeding from the head; it is about an inch long, and terminates at an eminence termed the tuberosity or tubercle, whence the shaft commences. On the lower surface of this tubercle is a small oval surface, which articulates with a corresponding surface on the upper part of the transverse process of the lower of the two contiguous vertebrae. The shaft presents an external convex and an internal concave surface. A little in front of the tubercle the rib is bent inward, and at the same time up-

ward, the point where this bending takes place being called the angle. The upper border of the rib is thick and rounded, while the lower border is marked by a deep groove, which lodges the intercostal vessels and nerve.

The ribs of mammals are mostly connected, as in man, with the bodies of two vertebrae, and with the transverse processes of the posterior one. In the Monotremata, however, they articulate with the vertebral bodies only; while in the Cetacea the posterior ribs hang down from the transverse processes alone. Their number, on each side, corresponds with that of the dorsal vertebrae. The greatest number, 23, occurs in the two-toes sloth, while in the Chiroptera 11 is the ordinary number. In birds each rib articulates by means of a small head with the body of a single vertebra near its anterior border, and with the corresponding transverse process by means of the tubercle. Moreover, each rib possesses a

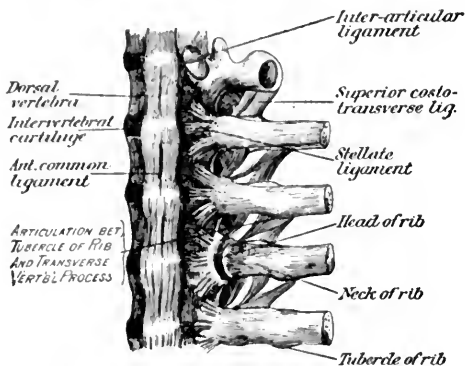

FIG. 2. ARTICULATION OF THE RIBS WITH THE SPINAL COLUMN, FRONT VIEW.

'diverging appendage,' which projects backward over the next rib, so as to increase the consolidation of the thoracic framework, necessary for flying. The dorsal vertebrae here never exceed 11, and are commonly 7 or 8 in number, and the ribs proceeding from them are connected with the sternum, not by cartilage, as in mammals, but by true osseous sternal ribs, which are regularly articulated at one end with the sternum, and at the other with the termination of the spinal ribs. In the chelonian reptiles the ribs (as well as the vertebrae and the sternum) deviate remarkably from the normal type, the lateral parts of the carapace consisting mainly of ankylosed ribs united by dermal plates. In the crocodiles there are only twelve pairs of true or dorsal ribs; while in the other saurians, and in the ophidians, the ribs are usually very numerous. In the frogs there are no true ribs, the reason probably being that any bony element in their thoracic walls would interfere with the enormous thoracic-abdominal enlargement which these animals periodically undergo at the breeding period. See SKELETON; SPINAL COLUMN.

RIB. In architecture, a projecting band or molding on an arched or flat ceiling. It is of universal use in all styles of Gothic architecture and it is the key-note of the Gothic system of construction. (See GOTHIC ARCHITECTURE.) Ribs were first used in certain Romanesque schools during the eleventh and early twelfth centuries, especially those of Lombardy, Normandy, and the Rhine. They simply followed the diagonal lines

of intersection of two barrel vaults on a square plan. But the Gothic system, by using the pointed arch in the ribbing, by making a complete framework of diagonal, transverse, and longitudinal ribs, not only self-sufficient, but capable of sustaining weight and transmitting thrust, and by turning the shell of each vaulting compartment into a concave surface, made of the combination the basic unit of the structure. The ribs were at first heavy and simply molded, becoming in the thirteenth century more slender and elaborately molded. Their intersection at the crown of the vault was commonly decorated with carved ornamentation in the form of floral bosses or pendants. In late Gothic, especially in England and Germany, intermediate ribs of no constructive use were added in the vaulted fields for decorative effect, some of which were called *lierne*. The fan-tracery vaults and paneled vaults are two of the most elaborate of these styles of ribbing. Cusping and tracery were used in late Gothic ribbing, and the ribs often wandered in curved lines across the vaulting.

RIB, FRACTURE OF THE. A very common surgical accident, resulting usually from blows or falls upon the chest. It is not uncommon, however, for ribs to be broken by indirect violence, such as a crushing or squeezing force which springs the convexity of the ribs outward until fracture occurs. Instances are on record where the ribs of very old persons have been actually broken by very violent coughing.

The treatment for fractured ribs consists in the application of broad strips of adhesive plaster which encircle the chest wholly or in part and which by their pressure steady the broken fragments and prevent their moving upon one another in the act of respiration.

Where the sharp extremity of a broken rib penetrates the layers of the pleura and enters the lung and escape of air occurs from the lung substance into the pleura, and thence through the wound in the parietal layer of the pleura into the subcutaneous connective tissue, it is made evident by a puffiness of the skin and a peculiar crackling sensation to the touch. This condition, which is known as *surgical emphysema*, may extend over the entire trunk and occasionally has been known to invade nearly the entire body.

RIBAUT, rē'bô', or RIBAULT, JEAN (c.1520-65). A French navigator and colonizer, born at Dieppe. In 1562 he was given command of an expedition organized by the Huguenot leader, Admiral Coligny, which had for its object the founding of a Huguenot colony in America. With his two vessels he explored the Florida coast, and finally, anchoring at Port Royal, built Fort Charles, near the present Beaufort, S. C. Leaving twenty-six colonists, he went back to France, from which, on account of the civil wars, he was unable to return for some time. Meanwhile the colony had been abandoned. Another settlement of French Protestants, however, had been made in 1564 under Laudonnière at Fort Caroline, on the Saint John's River, and in August of the next year Ribaut came over with seven vessels and assumed command of the colony. The appearance of a Spanish squadron, which had been dispatched with orders to kill all the Protestants in the settlement, drove him to sea. He planned to attack the Spaniards in their new settlement at Saint Augustine, but his fleet was wrecked and

the project was abandoned after a slight initial success. Meanwhile, the Spanish leader Menendez had taken Fort Caroline, on the Saint John's River, by rapid and skillful tactics. Over one hundred of the garrison were murdered by the Spaniards, as well as others of the French forces who later fell into the hands of Menendez. Ribaut traveling toward the settlement was met by Menendez, and with most of his party surrendered unconditionally. All but a few were put to death, Ribaut himself meeting his fate bravely. Consult: Winsor, *Narrative and Critical History of America*, vol. ii. (Boston, 1886); Parkman, *Pioneers of France in the New World* (ib., 1885); Gaffard, *La Floride française* (Paris, 1875).

RIBBECK, OTTO (1827-98). A German classical philologist. He was born in Erfurt, studied in Berlin under Lachmann, Böckh, and Bopp (1845), and in Bonn under Welcker, the 'last Hellene,' and with Ritschl, whose critical method he so closely followed. After receiving his degree in Berlin he went to Italy, where he spent a year. In 1853 he became a member of Böckh's seminar at Berlin, and from 1854 to 1877 taught successively at Elberfeld, Bern, Basel, Kiel, and Heidelberg. He became Ritschl's successor at Leipzig in 1877. Ribbeck's peculiar province was Latin poetry, and his great fame was as a bold textual critic. Besides many contributions to the *Rheinisches Museum*, of which he became an editor in 1876, his more typical works are the valuable collection of Latin comic and tragic fragments (1852-55; enlarged 1871-73; 3d ed. 1897-98); the text of Juvenal (1859), which is very radically reconstructed on the general principles of his essay, *Der echte und unechte Juvencal* (1865), in which Ribbeck held satires 1-9 and 11 as original and all else of the *textus receptus* late additions; the great text of Vergil (1859-62; prolegomena 1866), based on a minute study of the interrelations and history of the manuscripts, but marred by a subjective and fanciful, if brilliant, criticism, which is also to be found in the Horace of 1869; and an edition of Plautus's *Miles Gloriosus* (1881). But his most valuable works were the *Geschichte der römischen Dichtung* (1889-92; 2d ed. 1897-1900) and the masterly *Life of Ritschl* (1879-81). Mention should also be made of his series of classical character sketches, *Alazon* (1882), *Kolax* (1883), and *Agroikos* (1885), patterned somewhat on Theophrastus.

RIBBED VAULTING. A form of arched vaulting in which the masonry of the vault is sustained by ribs, which form a sort of skeleton, upon which the concave surfaces forming the shell of the vault rest. The ribbed vault is a development of the quadripartite groined vault, in which the groins are strengthened by means of ribs of masonry, but differs from it in that the concave surfaces of the vault are independent structures, transmitting the thrust to the ribs. (See GROINED VAULTING.) For the different varieties of Ribbed Vaulting, see VAULT. It is the basal unit of Gothic architecture, under which title its development is fully discussed.

RIBBON. See SILK.

RIBBON (OF. *riban*, *ruban*, *rubant*, Fr. *ruban*; perhaps connected with Ir. *ribin*, ribbon, Welsh *rhibin*, streak, Gael. *rib*, hair, rag). In heraldry (q.v.), a diminutive of the ordinary called the bend.

RIBBON-FISH. (1) Any of a variety of pelagic fishes characterized by a much elongated and compressed body, especially those of the sub-order Taniostomi, including three families, represented by very few species. They are of very delicate structure, with naked and silvery skin, a long dorsal fin often uniting with the tail-fin, a small mouth, and a protractile snout. They are widely distributed from polar to tropical seas, but are nowhere found in abundance, being deep-sea fishes, and mere occasional visitants of the coasts. Owing to the delicacy of their frame, perfect specimens are seldom obtained. Specimens 20 feet long with a depth of 12 inches and a thickness of only an inch or two have been taken. See OARFISH.

(2) One of the roneadors (q.v.) of the Gulf of Mexico and West Indies, *Eques lanceolatus*. Its

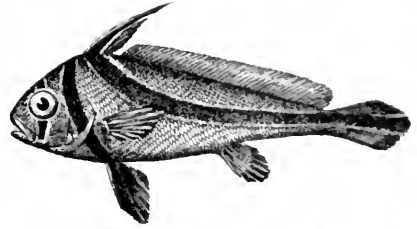

GULF RIBBON-FISH (*Eques lanceolatus*).

generic name is due to the long dorsal spines, suggesting a rider; and its common name to blackish-brown bands which curiously ornament its yellowish-gray body.

RIBBON GRASS. See CANARY GRASS.

RIBBONISM. The name given to a movement which originated in Ireland about 1808, and took the form of secret associations of Catholics banded together for the purpose of combating the activity of the Orangemen (q.v.), and known as Ribbon societies. The name was derived from the green ribbon which was the badge of the organization. The societies appeared chiefly in Armagh, Down, Antrim, Tyrone, and Fermanagh, and seem never to have gained a footing in the purely Catholic counties. The members of the Ribbon societies belonged almost exclusively to the poorest classes, and the religious purposes of the organization soon became merged with social and agrarian. The Catholic clergy seem consistently to have opposed the movement.

RIBBON SNAKE. One of the American garter-snakes (*Eutania saurita*) common from Massachusetts to Louisiana, but rare west of the Alleghanies. It is a light chocolate brown above, with three yellow stripes and greenish below. The only peculiarity in its habits is its fondness for water. Two closely similar species are *Eutania Sackenii* of Florida, which is clear olive with straw-colored stripes; and *Eutania proxima*, of the Mississippi Valley and Texas, which is blackish brown, with dull yellow stripes. See GARTER-SNAKE.

RIBEIRO, rā-bā'ro, BERNARDIM (c.1486-c.1550). A Portuguese poet, born at Torrão, in the Province of Alentejo. There is little positive information about this poet. He was a gentleman of the chamber at the Portuguese Court for several years, and there had an unfortunate love affair with a relative of the King, who is said by some to have been Donna Joanna de Vilhena. His best known work is the pastoral

romance *Menina e Moça* (1554), the correct title of which is *Saudedes* or *Tristeszas*. It introduces his own love affair and a number of the personages of the Portuguese Court. Although very obscure and confused as to plot, it contains passages of descriptive beauty. The *Obras de Bernardino Ribeiro* were published in 1645, 1785, and 1852. The best modern edition is that of Dom José Pessanha, the *Menina e Moça* with a *Pre-facio* (1891).

RIBEIRO-FERREIRA, fār-rā'ê-rá, THOMAS ANTONIO (1831-1901). A Portuguese poet and statesman, born at Parada de Gonta, and educated for the bar at Coimbra. In 1870 he became secretary general of the Portuguese colonies. He received the Colonial portfolio in 1878, that of the Interior in 1881, in 1885 and in 1890 was Minister of Public Works, and in 1895 and 1896 served as Minister to Brazil. In prose he wrote for the press and published two volumes of travels, but he was best known as a poet, with a typically Portuguese languor and grace, but much patriotism withal, as in *Dissonancias* (1891). Earlier poems are: *Sons que passam* (1854) and *Vesperas* (1858), both lyric collections; *Don Jaime* (1861; 6th ed. 1880), a national epic; and *Delfina do mal* (1868; revised 1881), a narrative.

RIBERA, rê-bā'râ, JUSEPE DE, called LO SPAGNOLETTO (1588-1656). An historical painter and etcher, Spanish by birth and training, but one of the leading masters of the Neapolitan school and the greatest colorist of Italy in the seventeenth century. He was born at Jativa, Province of Valencia, January 12, 1588. First instructed by Ribalta at Valencia, he received most of his training and spent the greater part of his life in Italy. He studied after the works of the great masters in Rome, then especially after Correggio and the Venetians, from whom he derived his vivacity of color. He formed his style, however, chiefly after Caravaggio, of whom he seems to have been an independent follower, rather than a direct pupil. After years of vicissitude, he settled at Naples, where he secured a patron in the rich picture dealer Cortese, whose daughter he married. Like Caravaggio's pictures Ribera's exhibit a wild, extravagant fancy, but great vigor, and, although imbued with the darkness of shadow masses peculiar to the Neapolitan "Tenebrosi" (Darklings), they show a much finer instinct of the chiaroscuro. He delights in scenes of horror, such as tortures and martyrdoms of all kinds, but occasionally shows also poetic charm and was the first to combine realism with the Roman Catholic spirit. He painted numerous heads and half-figures of hermits, saints, and philosophers with great anatomical exactness. Especially good are his various representations of the "Martyrdom of Saint Bartholomew," examples of which are in the museums of Madrid, Berlin, and Dresden. Among his finest paintings are the "Immaculate Conception" (1635), in the Convent of the Augustine Recollets at Salamanca, excelling in splendor of color and light and in the charm of the Virgin's figure the representations of this subject by Murillo, Guido Reni, and Rubens; the "Descent from the Cross" (1637), admirable for its delineation of pain, and "Communion of the Apostles," both in San Martino, Naples; the "Adoration of

the Shepherds" (1650), in the Louvre; the "Martyrdom of Saint Lawrence," in the Vatican; a "Pietà" in the National Gallery, London; and "Saint Mary of Egypt Praying at Her Grave" (1641), in the Dresden Museum, of exceptional charm in the expression of the head. Of the fifty pictures in the Madrid Museum, the best are: "Jacob's Dream;" "The Immaculate Conception;" "Isaac Blessing Jacob;" "Magdalen;" "Saint Rochus;" "Prometheus;" and "The Blind Sculptor of Gambazo." Of singular interest is a half-figure of "Homer, as Improviser with the Violin," in the Turin Gallery, and his latest work, the "Saint Sebastian" (1651), in the Museum of Naples. Of his twenty-six etchings the best-known are "The Drunken Silenus with Satyrs" (1628), the equestrian portrait of "Don Juan d'Austria" (1648), two of "Saint Jerome," and "Satyr Scourged by Cupid." Consult: Bermudez, *Diccionario histórico . . . de las bellas artes*, iv. (Madrid, 1800) Eisenmann, in Dohme, *Kunst und Künstler Italiens*, iii. (Leipzig, 1879); Woermann, in *Zeitschrift für bildende Kunst* (ib., 1890); and *Diccionario enciclopédico hispano-americano*, xvii. (Barcelona, 1895).

RIBHUS (Skt. *ṛbhū*, dexterous, from *rabh*, Gk. *λαβάνειν*, *lambanein*, to take; ultimately connected with Ger. *Alp*, AS. *ælf*, Eng. *elf*). In Vedic mythology, a group of divine artificers. They are usually three in number, and were originally mortals. They are closely associated with Indra, and also with Savitar, the sun, while in their appearance they are like the sun, and ride in a bright car drawn by fat steeds. They are most frequently mentioned as the artisans of the gods. The physical basis of the divine aspect of the Ribhus is doubtful. Some scholars regard them as the three seasons which are at a standstill during the twelve days of the winter solstice. Consult: Nève, *Essai sur le mythe des Ribhavas* (Paris, 1847); Macdonell, *Vedic Mythology* (Strassburg, 1897); Ryder, *Die Ribhū's im Rgveda* (Gütersloh, 1901).

RIBOT, rê'bô', AUGUSTIN THÉODULE (1823-91). A French genre and portrait painter of the realistic school, born at Saint-Nicolas-d'Attez (Eure). He first painted mirror frames, and then worked for a while under Glaise and studied Chardin and the Dutch and Spanish masters in the Louvre. He began his exhibits at the Salon by a series of still-life pictures and kitchen scenes, painted broadly with strong Rembrandt-like effects of light and shade. These include "Cooks at Dinner Time" (1861), and "Chickens Roasting" (1861). His "Saint Sebastian" (1861) showed his powerful, if somewhat coarse, talent, in another manner. This picture, with "The Good Samaritan," and "Jesus in the Temple," is in the Luxembourg. His later works were mainly portrait heads, chiefly of old people, which are wonderful studies of wrinkled flesh and startling expression. He was decorated with the Legion of Honor. Consult Muther, *The History of Modern Painting* (New York, 1896).

RIBOT, ALEXANDRE FÉLIX JOSEPH (1842-). A French statesman, born in Saint Omer (Pas de Calais), and educated for the law in Paris. He was one of the founders of the Société de Législation Comparée, was for two years (1875-77) at the head of a department in the Ministry of Justice, and in 1878 was elected a Deputy.

He became a member of the Left Centre, defended Dufaure's policy, and in his general conservatism was especially prominent as opposed to the colonial policy of the Ferry Cabinet. In 1890 he became foreign Minister in Freycinet's Cabinet, a portfolio which he also held under Loubet. From December 1892 to March 1893, he was president of the Cabinet, and on Faure's election, in 1895, was again called to form a Cabinet, which did not last the year out. After Fashoda, Ribot again urged his conservative colonial policy of prudent waiting. In the Dreyfus affair, although he had previously urged all possible publicity, he successfully opposed the prosecution of Mercier. Ribot made a special study of English politics, and in 1866 wrote a *Biographie de Lord Erskine*.

RIBOT, THÉODOLE ARMAND (1839—). A French psychologist. He was born at Guingamp, December 18, 1839, and was educated at the Lycée de Saint Briere and at the Ecole Normale, Paris, where he graduated in 1862, and whence he received a doctor's degree in 1875. After teaching for several years as professor of philosophy at various lycées, he came to Paris and turned to the investigation of experimental and physiological psychology in the histological and physiological laboratories and at the clinics of the insane asylums. In 1876 he founded the *Revue philosophique*, of which he became the editor. In 1885 he was given charge of a course in experimental psychology at the Sorbonne, and in 1888 was called to the chair of experimental and comparative psychology in the College of France. Ribot has taken a leading part in the recent development of psychology in France, adopting the best methods of both the German and the English psychologists, while at the same time his work has been characteristically French in breadth of view. Especially valuable have been his psychopathological studies and the analytical and comparative treatment of distinctive types or fields of mental phenomena in his later books. Best known are *La psychologie anglaise contemporaine* (1870; trans., London, 1873); *L'hérédité psychologique* (1873, 5th ed. 1889; trans., London, 1875); *Philosophie de Schopenhauer* (1874; 7th ed. 1896); *Psychologie allemande contemporaine* (1879, 13th ed. 1898; trans., New York, 1886); *Les maladies de la mémoire* (1881, 13th ed. 1898; trans., International Scientific Series, xli, New York, 1882); *Les maladies de la volonté* (1883, 14th ed. 1899; trans., New York, 1884); *Les maladies de la personnalité* (1885, 8th ed. 1899; trans., Chicago, 1895); *La psychologie de l'attention* (1889, 3d ed. 1897; trans., Chicago, 1896); *Psychologie des sentiments* (1896, 3d ed. 1899; trans., London, 1897); *L'évolution des idées générales* (1897; trans., Chicago, 1899); *Essai sur l'imagination créatrice* (1900).

RICARDO, RĀ-KĀR'DŌ, DAVID (1772-1823). An eminent English political economist, born in London. His father, a Jew from Holland, gave him an education in a commercial school in that country. When fourteen years of age Ricardo left school to engage in his father's business on the stock exchange, for which he showed remarkable aptitude. At nineteen he entered the Church of England and was renounced by his father. Thrown upon the world without resources, he set up as a broker, with such success that he was reckoned a man of

wealth by the time he was twenty-five years of age. It was about this time that he was attracted to the works of Adam Smith, and he began to devote himself to economic studies, though he did not wholly withdraw from business life until 1818. His first publication on economic studies was a pamphlet issued in 1809, and entitled *The High Price of Bullion a Proof of the Depreciation of Bank Notes*. This work created considerable stir, and received, as it were, official confirmation in the famous Report of the Bullion Committee in 1811, in the drafting of which Ricardo is reported to have had great influence. A series of pamphlets on financial subjects followed this first venture, and in 1817 appeared his *Principles of Political Economy and Taxation*, on which his fame chiefly rests. In 1819 he entered the House of Commons, and while his diffidence prevented him from becoming a notable speaker, he maintained there a high authority upon all matters pertaining to finance and taxation until his death.

Ricardo exercised a greater influence upon economic thought than any other of the earlier writers except Adam Smith. His writings cover the fields of abstract theory, currency, taxation, and protection, in each of which he contributed much that was of permanent value. In economic theory his name is associated with the law of rent (q.v.), which he did not originate, but expounded so forcibly that it became generally known through his works; the so-called "iron law of wages," that wages in the long run cannot exceed the minimum of subsistence, for which he is, however, no more responsible than Adam Smith; the labor theory of value, according to which commodities tend to exchange in proportion to the quantity of labor that has been expended upon them. None of these theories receives unqualified acceptance at the present day, although existing theories have been profoundly influenced by them. His writings on taxation are abstract, and throw considerable light upon the problems of incidence of taxes. The most complete part of his work is his discussion of currency. His is the first adequate and clear statement of the quantity theory of money. (See MONEY.) The doctrine of comparative costs (see INTERNATIONAL TRADE) is one of his most important discoveries in the realm of international trade.

In addition to the works mentioned in the text, he was author of a large number of pamphlets on taxation, currency, and protection, and of numerous controversial letters to Malthus, J. B. Say, McCulloch, and other economists.

RICASOLI, RĀ-KĪ'ZŌ-LĒ, BETTINO, Baron (1809-80). An Italian statesman, born at Florence. He was a descendant of an ancient Lombard family, studied at Pisa and Florence, and passed the early years of his life on his estate devoted to the study of agriculture, on which subject he wrote a number of useful works. In 1847 he appeared in politics as a leader of the Moderate Liberals and an advocate of Italian unity, and was elected Mayor of Florence. In 1849 as a member of the executive commission he was instrumental in recalling the Grand Duke Leopold, trusting to the constitutional promises given by the latter. Leopold returned accompanied by the Austrians, and Ricasoli, indignant at this treachery, retired into private life.

In 1859 he assumed the leadership of the liberal movement in Tuscany, and after the flight of the Grand Duke was made dictator (August 1). In this office he exerted himself for the union of Tuscany with Sardinia. His firmness strengthened the hands of Cavour and Victor Emmanuel, and on the 20th of March, 1860, he was able to announce to the Tuscan assembly that its work was done. In the same month he was made Governor-General of Tuscany. On the death of Cavour (June, 1861) Ricasoli was called to the head of the Ministry. His Cabinet, however, could not withstand the Radical assault, and he resigned in March, 1862. He returned to power in June, 1866, and retired in April of the following year, when he was succeeded by Ratazzi. Consult his *Lettere e documenti* (10 vols., Florence, 1888-95); Ongaro, *Bettino Ricasoli* (Turin, 1861); Passerini, *Genealogia e storia della Famiglia Ricasoli* (Florence, 1861).

RICCI, rit'chè, FEDERIGO (1809-77). An Italian dramatic composer, born in Naples. He was educated in music at the Conservatory of San Sebastiano, after which he followed his older brother to Rome. His first great success was won by the opera *La prizione d'Edimburgo* (1837), which was followed by the scarcely less successful *Un duello sotto Richelieu* (1839); *Michelangelo e Rolla* (1841); and *Corrado d'Altamura*. In 1853 he went to Saint Petersburg as inspector of the vocal classes in the Theatre School, and about 1870 left that city to superintend personally his own musical productions in Paris. One or two of his operas had been translated and adapted for the French stage, and their success led him to bid for French favor with the more ambitious operas *Docteur Rose* (1872), and *Chi dura vince*. He was disappointed, however, and in 1876 returned to Italy. Additional compositions included masses, cantatas, songs, as well as several other operas. He died at Conegliano.

RICCI, LUIGI (1805-59). An Italian dramatic composer. He was born in Naples, and, like his brother Federigo, was educated at the Conservatory of San Sebastiano, Naples. He composed several very successful operas which he presented in rapid succession, and in 1836 became maestro di capella at the Cathedral of Trieste, and vocal director of the city theatre. After this much of his work was done in collaboration with his brother until 1859, when he was stricken with disease of the brain, and after confinement in the Prague asylum died there. He wrote about 30 operas, of which perhaps *La festa di Piedigrotta* (1852) and *Il diavolo a quattro* (1859), written jointly with his brother, are among the best. His masterpiece, however, was *Crispino e la Comare* (1850), one of the best comic operas of Italy and the only one still performed outside of it. Other compositions include masses, sacred and secular songs, and duets.

RICCI, MATTEO (1553-1610). The founder of the Jesuit missions in China, and a celebrated astronomer, born at Macerata, Italy. After studying law at Rome he entered the Society of Jesus in 1571. In 1577, while still a scholastic, he went on the mission to India. There he was ordained, and because of his ability in Eastern languages, especially in Chinese, selected to found the mission in China. Ricci published

several works in Chinese which attracted the attention of Chinese literati by the purity of their style. He resolved to make his way to Peking, and in the dress of a Chinese scholar succeeded in reaching Nanking (1595), but was not allowed to remain long. Later he wrote a series of didactic works in Chinese, one a *Dialogue of Friendship*, in imitation of Cicero, which so pleased the Chinese mandarins that he obtained the permission to go to Peking. He presented to the Emperor a telescope and various astronomical instruments, which were still in the palace when the Allies forced an entrance in 1900. After this he was allowed to reside at Nanking. In 1601 he obtained permission to build a church and found a mission in Peking itself. Before long his mathematical teaching and classical Chinese style obtained for him great prestige. He became a special favorite of the Emperor, and through his influence Christianity was introduced into the principal cities of China. There is an important work by him which contains a number of valuable observations on the geography and history of China. His book *On The Nature of God*, written in Chinese, has been admitted into the number of Chinese classics. Consult biographies by Sainte-Foi (Paris, 1859) and Werfer 2d ed., Regensburg, 1870).

RICCI, SCIPIONE DE (1741-1810). An Italian bishop, born at Florence. He was ordained a priest in 1766. For some time he was auditor to the Papal Nuncio at Florence, and in 1780 was appointed Bishop of Pistoja and Prato. He attempted to introduce certain reforms in the Church, but though he was supported by the Grand Duke Leopold, brother of Emperor Joseph II., and his reform measures were approved by the diocesan synod of Pistoja in 1786, he was opposed at the general Tuscan Synod, held at Florence in 1787. When Leopold left Tuscany, Ricci was forced by the anger of the populace to flee from Pistoja (April, 1790), and he formally renounced his episcopal dignity in June, 1791. Consult his *Life* by Potter (Brussels, 1825), and his autobiography, *Memorie* (Florence, 1865).

RICCI, SEBASTIANO (1659-1734). An Italian painter of the Venetian school, born at Cividale di Belluno. He was a pupil in Venice of Cervelli, with whom he painted in Milan, Bologna, and Venice. Afterwards he visited Austria and England, where he remained ten years. His works in England include the decorations of the chapel at Bulstrode for the Duke of Portland, of the hall at Burlington House, and those in the chapel of Chelsea Hospital. "The Continence of Scipio," and "The Dinner at Simon's House," two of his best productions, are at Hampton Court. He executed a large number of works distinguished for vivacity of conception, grace of form, and fine color.

RICCIARDELLI, rit'châr-dè'l'è, DANIELE. See VOLTERRA, DANIELE DA.

RICCIO, DAVID. See RIZZIO.

RICCIO, rit'chè, DOMENICO, called BRUSA-SORCI (1494-1567). An Italian painter of the Venetian school, born in Verona. He was the pupil of Caroto, but was strongly influenced by Giorgione and Titian. Most of his works, chiefly frescoes, are to be found in his native city. Those which depict mythological subjects are better than his purely religious pieces. He painted the façade of the Casa Murari, now al-

most destroyed, and "The Entry of Clement VII. and Charles V. into Bologna," in the Palazzo Ridolfi. This last, his most celebrated work, is notable for the dramatic expression of the figures and its fine color. Domenico's son FELICE (1540-1605), also called BRUSASORCI, studied under Ligozzi in Florence. A number of his religious paintings are in the Verona churches, and there is a "Holy Family" by him, in the Louvre. His style is refined, and his coloring rich and pleasing.

RICCOBONI, rik'kô-bô'nê, LODOVICO, called LELIO 1677-1753). An Italian dramaturgist, born at Modena. In 1699 he became director of a company of players, by whose aid he did away with the traditional Italian comedy of masks, and presented the *Pastor fido* and other dramas of importance. Opposition to him at Venice and in the Lombard towns caused him to withdraw to Paris, where from 1716 to 1729 he conducted an Italian theatre in the Hôtel de Bourgogne. He returned thence after a brief residence at Parma (1729-31). His publications include the *Histoire du théâtre italien* (1728-31).

RICCOBONI, MARIE JEANNE LABORAS DE MÉZIÈRES (1714-92). A French novelist, daughter-in-law of the preceding. She was born in Paris. She wrote the once popular novels of society, *Histoire du marquis de Crécy*; *Lettres de milady Catesby*; *Ernestine*, etc., but she is best known as the continuator of *Marianna*, by Mari-vaux (q.v.).

RICE (OF. *ris*, Fr. *riz*, from ML. *orysum*, Lat. *oryza*, from Gk. *ορίζα*, *oryza* *ορίζων*, *oryzon*, rice; connected with Afghan *vrizi*, Skt. *vrihi*, rice). A genus of grasses of which the only important species is the common rice (*Oryza sativa*), one of the most useful and extensively cultivated grains, supplying the principal food of one-half of the human race. It seems to have been originally a native of the East Indies, but has spread to all quarters of the globe, wherever the conditions of warmth and moisture are suitable. It is adapted to subtropical climates, rather than tropical or cold temperatures. Rice is an annual, varying from two to five feet in height. The seed or grain grows on little separate stalks, springing from the main stalk; and the whole appearance of the plant, when the grain is ripe, may be said to be intermediate between that of barley and oats. Rice requires a moist soil, artificially flooded at certain seasons. There are, however, varieties called upland rice that do not require flooding. The cultivation is most extensively carried on in India, China, and other southeastern parts of Asia, Japan, Egypt, the southern countries of Europe, South Carolina, Georgia, and the Gulf States of North America. The best of all rice known in the market is that of Carolina, yet the introduction of rice into that country occurred only about the end of the seventeenth or the first part of the eighteenth century. Rice is known in India as Paddy—a term also used to designate rice in the husk. See Plate of CEREALS.

In China, where, as in other warm countries, two crops may be obtained in a year, rice is generally sown thickly on very wet land, and afterwards transplanted to the land which it is finally to occupy. The plants tiller or spread at the root very much, so that each sends up several or many stalks. The rice-grounds are

carefully weeded, although often so wet that the workmen may sink to their knees.

The origin of the regular production of rice in America is referred to the latter part of the seventeenth century, when a vessel from Madagascar is said to have brought a sack of the grain to Charleston, S. C. This yielded well, the culture spread, and eventually rice became the staple product of that State, until the War of the Rebellion checked it. The mode of cultivation best adapted to the plant in South Carolina has been found to be by irrigation, and it is chiefly grown where the land was formerly overflowed by the tides. The cultivation of rice spread rapidly to most of the Southern States, but of late years Louisiana and Texas have been the most successful in its cultivation. The prairies of the southern parts of the States have proved to be well suited to the cultivation of rice. The land is irrigated by pumping water from rivers and wells and so regulated as to permit of the use of machinery as in growing other small grains. The ground is plowed, harrowed, and rolled, and the seed planted with drills. The ground is allowed to dry sufficiently at harvest time to enable the use of binders and the grain is afterwards threshed with steam threshers. It is also grown on lowlands subject to overflow from the river, with due precautions against a possible crevasse. The water is conveyed by ditches and laterals, and is alternately turned on and drained off, as the condition of the plants' progress may demand. When mature the water is drained off, the grain cut and left to dry. After threshing, it is winnowed and placed in sacks, ready for the mill or market. The 'upland' rice is dry-cultivated, and is claimed by some planters to be better than the lowland. It is grown upon high and dry land, and, after the manner of other grain, the yield is not so generous as on the lowland. The milling of rice consists in removing the outer husk or coat. From the thresher the rice is sent to the mills in barrels holding 162 pounds each. From this quantity of rough rice, the mills secure 95 pounds of clean rice, 8 pounds of polish, 30 pounds of bran, and 29 pounds of waste. The rice polish and rice bran are mixed and sold as a feeding stuff under the name of rice feed or rice meal. It is very nutritious and is largely employed as a food for pigs.

The production of rice in the United States in 1899, as given in the Twelfth Census, was as follows:

	Pounds
Georgia.....	11,174,562
Louisiana.....	172,732,430
North Carolina.....	7,892,580
South Carolina.....	47,360,128
Texas.....	7,186,863

The amount did not supply the home market, and in addition 204,177,000 pounds were imported. The world's production of rice in 1899 was:

	Pounds
North America.....	283,722,627
Europe.....	1,507,368,000
Asia.....	72,386,748,000

Canada rice (*Zizania aquatica*), the wild rice of North America, is a species of a different genus of grass quite different from the true rice. It is particularly abundant in the Northwest, growing in miry places or shallow water, often in the margins of lakes. The seeds are about

half an inch long, slender, farinaceous, affording very good meal, and used to some extent by the Indians where the plant abounds. Owing to its tendency to shatter its seed, its production has not reached any economic importance.



WILD RICE (*Zizania aquatica*).

Aside from its use as food (see below), rice is subjected to fermentation in many countries. The beer made from it (*saki*) is in general use among the Japanese. Several kinds of highly esteemed and very intoxicating wines are made from rice by the Chinese. A spirit is distilled from the lees. Rice starch is made in considerable quantity and is used in laundries and muslin factories. Rice straw is used to make bonnets, and also to some extent as a feed for cattle.

FEEDING VALUE. The rice grain is not directly used as a food for farm animals. However, its by-products, chaff-meal, bran, and polish, are fed especially in regions where rice is grown. The straw also has a feeding value.

Rice bran and rice meal contain more or less of the germ, and are fed to dairy cows and pigs.

According to recent experiments rice meal has practically the same value for pigs as corn meal when fed in addition to skim milk. Rice polish is a fine powder of high nutritive value and is very valuable for cows, pigs, etc. As it is rich in both nitrogen and potash, it produces a valuable manure. Rice hulls are too woody to be of much food value. They are largely used for packing around breakable articles. Unlike most cereal grains, rice is seldom made into bread or cakes, but is eaten boiled. In China, Japan, and other countries where the majority of the people cannot obtain animal food, rice, which is rather deficient in protein (see table), is supplemented by special products made from the soy bean (q.v.), which are rich in protein. In Europe and America rice is used as a vegetable, for making soups, puddings, cakes, etc.

Rice flour has the following percentage composition: Water, 8.5; protein, 8.6; fat, 6.1; nitrogen-free extract, 51.9; crude fibre, 16.1; and ash, 8.8. Flaked rice, a breakfast food, has the following average percentage composition: Water, 9.5; protein, 7.7; fat, 0.4; nitrogen-free extract, 81.7; crude fibre, 0.2; and ash, 0.3. Rice is believed to be very thoroughly digested. Judged both by palatability and wholesomeness, it is worthy of the high esteem in which it is held.

RICE, ALLEN THORNDIKE (1853-89). An American editor, born in Boston, Mass. He graduated at Oxford University in 1875, and in 1876 bought the *North American Review*, of which he subsequently became the editor. In 1879 he promoted the Charnay expedition, which, under the patronage of France and the United States, was sent to investigate the remains of primitive civilization in Central America and Mexico. He was the first to recommend the introduction into the United States of the Australian ballot system. He edited *Reminiscences of Abraham Lincoln* (1886) and was a contributor to *Ancient Cities of the New World* (1887).

RICE, JAMES (1843-82). An English novelist, born at Northampton, September 26, 1843. He studied at Queen's College, Cambridge, and was called to the bar at Lincoln's Inn (1871). Never taking very seriously to his profession, he gave most of his time to literature. As editor and proprietor of *Once a Week*, from 1868 to 1872, he made the acquaintance of Walter Besant, with whom he collaborated on several remarkable novels, as *Ready Money Mortiboy* (1872), which was successfully dramatized (1874); *The Golden Butterfly* (1876); *The Monks of Thelema* (1877); and *The Seamy Side* (1881). Besides these and other novels, they wrote in conjunction several Christmas stories for *All the Year Round* and the *World*. There had been no literary partnership as successful as this since that of Erckmann-Chatrian (q.v.). Rice also wrote a gossipy *History of the British Turf* (1879).

RICE-BIRD. The name in the Gulf States of the bobolink (q.v.).

AE The New international
5 encyclopaedia
N524
v.14

PLEASE DO NOT REMOVE
CARDS OR SLIPS FROM THIS POCKET

UNIVERSITY OF TORONTO LIBRARY

UNIVERSITY OF TORONTO LIBRARY

