

UF  
575  
F8  
75 mm  
E5

UC-NRLF



\$B 313 234

YB 49769



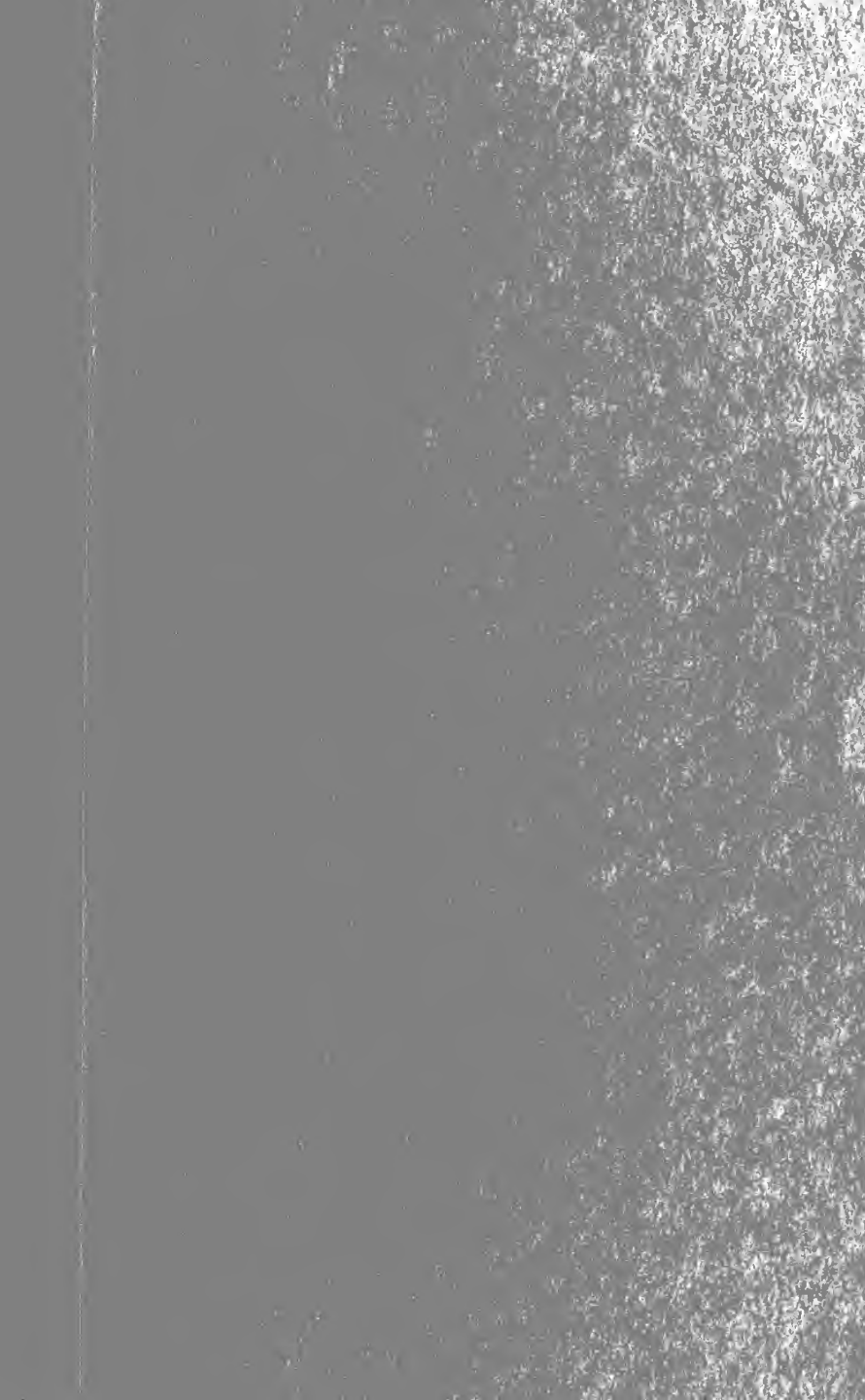

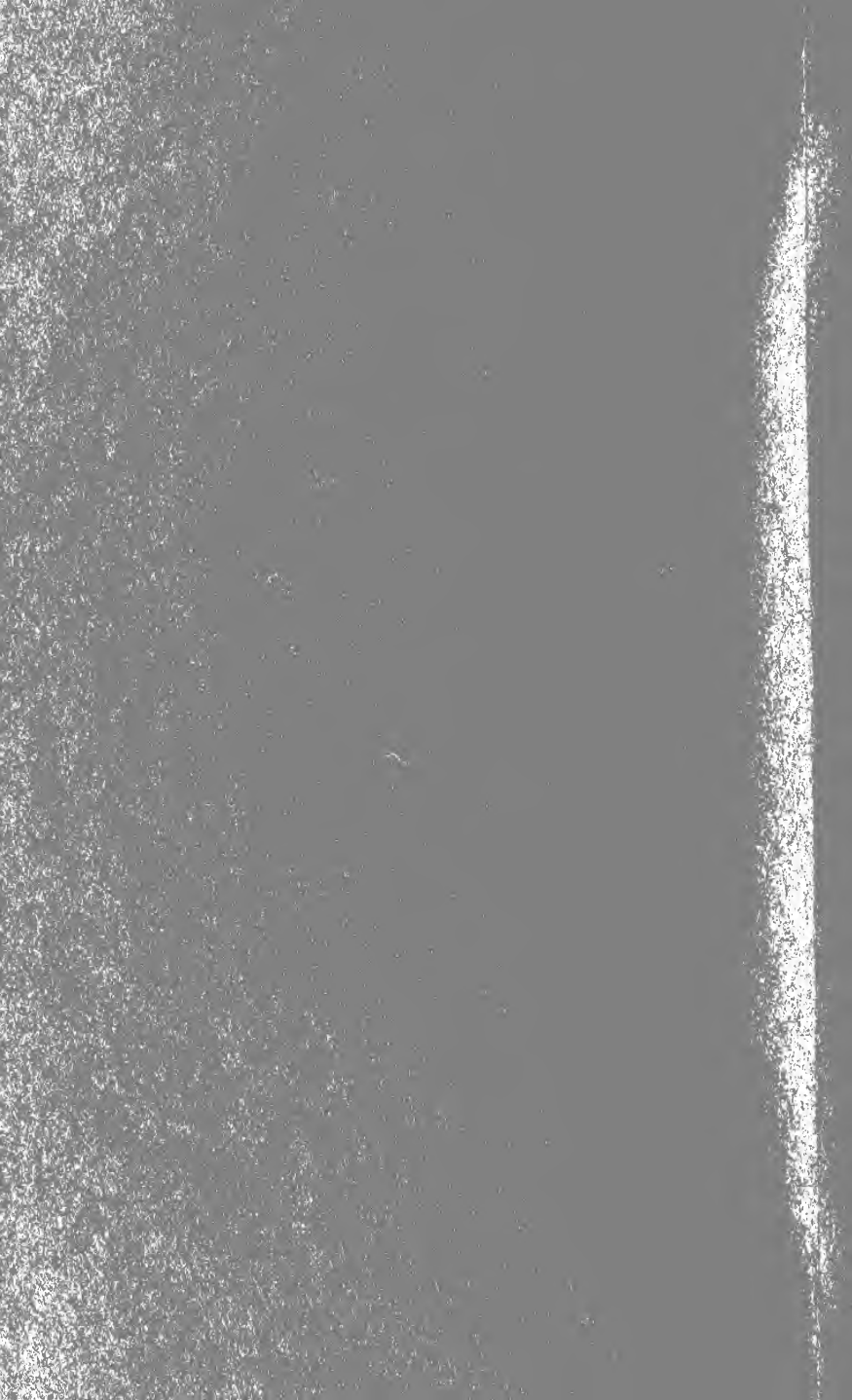

JUL 19 1918

**NOTES**  
ON THE  
**FRENCH 75-MM. GUN**



---

**EDITED AT THE ARMY WAR COLLEGE**  
**OCTOBER, 1917**



**WASHINGTON**  
**GOVERNMENT PRINTING OFFICE**  
**1917**

UF575  
F8  
75 mm  
E5

WAR DEPARTMENT.  
Document No. 687.  
*Office of The Adjutant General.*

NO. 687  
ADJUTANT GENERAL

WAR DEPARTMENT,  
WASHINGTON, *October 22, 1917.*

The following pamphlet "Notes on the French 75-mm. Gun," reprinted from an article in "The Engineer" (London), January 22, 1915, is published for the information of all concerned.

[062.1 A. G. O.]

BY ORDER OF THE SECRETARY OF WAR:

TASKER H. BLISS,  
*General, Chief of Staff.*

OFFICIAL:

H. P. McCAIN,  
*The Adjutant General.*

21868°—17

(3)

377776

Digitized by the Internet Archive  
in 2008 with funding from  
Microsoft Corporation



## THE FRENCH 75-MM. GUN.

---

With the exception of the German "42," no gun in the war has created more interest than the famous French 75-mm. field gun, popularly known as the soixante-quinze. That it did magnificent work in the early stages of the war can not be doubted, and if its influence is at present not so great as it was, the reason is to be found in the siege conditions that prevail and to the momentary need of heavier pieces. We do not doubt, however, that the "75" will come by its own again soon, when this interminable trench war reaches an end and more rapid movements begin.

It will surprise many of our readers to learn that the "soixante-quinze" is not a new gun. It was invented as far back as 1897, and two such famous artillerymen as Deport and Sainte-Claire Deville had a hand in its design. Studying it in detail, as we are now able to do, through an admirable article recently written by M. Dumas for *Le Génie Civil*, we are struck by the excellence of the design. In all respects it is far ahead of any gun not only of its time but of later years. It represents the first real attempt to produce a fieldpiece that could quite correctly be called a quick firer, and it was probably the earliest in which independent recoil was combined with independent training, a quick-action breech mechanism, and fixed loading—that is to say, loading in which the projectile and the charge are united in a single cartridge, just as they are in the charge of a rifle.

The gun proper consists of a barrel rifled with cuneiform grooves and strengthened by a breech hoop pressed on cold; its bore is 75 mm.—practically 3-inch—and its length is 2.475 m., or 33 calibers. The breech is not closed by a block with an interrupted thread, nor by a sliding block, as in most other guns, but by a revolving block, the axis of which does not coincide with the axis of the gun. At one place a deep notch is cut into this block, which, in a certain position, coincides with the bore of the gun and permits the cartridge to be pushed in. By giving half a revolution to the block the notch is moved out of the way and the breech is closed by the solid part. The block is screwed

on the outside, so that not only is it strongly supported against the pressure of explosion, but presses the rim of the cartridge hard up against the gun face in the closed position. It is turned from one position to another by a lever projecting on top, as shown in Fig. 1. In the lever is a grip bolt, which locks it in either the closed or open position. In Fig. 1 are also seen the two arms which extract the cartridge case and automatically throw it to the rear when the breech is opened. They are operated by a

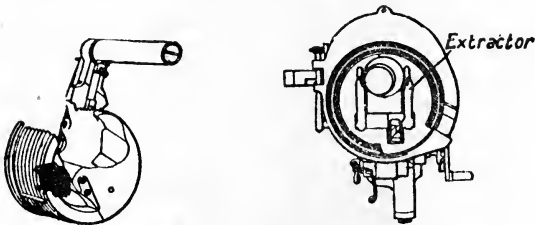

FIG. 1.—Breechblock.

short lever or heel which engages in a fixed groove or cam. Firing is effected by a spring trigger acting on a striker which passes right through the block. A safety cam is provided to hold the trigger out of action when desired.

The details of the recoil cylinder can not, according to *Le Génie Civil*, yet be published, but from the sketch given and here reproduced—fig. 2—it is clear that the form is one now fairly well known. The recoil cylinder, which is a brake and running-out gear combined, is supported in a cradle carried by



FIG. 2.—Recoil cylinder.

trunnions on the gun carriage. It consists of two parts, the cylinder C and the cylinder R. The former of these, C, is attached rigidly to a projection L on the breech of the gun, and when the gun recoils—toward the left—this cylinder is drawn back with it. The other cylinder R is attached to the cradle and remains at rest. In it is a diaphragm or piston D. Solid with R is a hollow piston rod provided with a piston which fits the cylinder C. The end of the hole in the rod is closed by a spring-loaded valve S, beside which, through small holes pro-

vided for the purpose, some leakage is permitted. The whole space to the left of the piston D is filled with a nonfreezing mixture of glycerin and water. On the right of D there is air. When the gun is fired the cylinder C is drawn to the left and the glycerin and water is forced, following the arrows, through the valve S, driving back the piston D and compressing the air behind it. The smallness of the passages, the pressure of the loaded valve S, and the resistance of the air to compression cause this action to take place quietly and bring the gun to rest at the end of about 1 m. 20 cm., say 4 feet. The compressed air then expands again, drives the liquid back into the cylinder C, and returns the gun to the firing position.

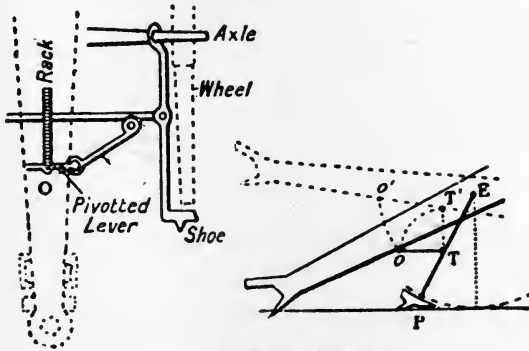

FIG. 3.—Wheel-brake gear.

It is claimed for the carriage of the "soixante-quinze" that it has three essential points of difference from any carriage that preceded it. They are: (1) The combination of a trail-spade with wheel brakes; (2) the possibility of training the gun without moving the wheels; and (3) a mechanism which permits aim to be taken during recoil. We shall take them in the order given. In the firing position the carriage rests on three points, namely, the end of the trail and the two brake blocks, which are forced under the wheel. All three have spades, so that they attach themselves firmly to the ground. The wheels, it will be seen, are entirely out of action and the carriage is borne by a three-point suspension, which, as everyone knows, is ideally the best possible. The method of raising the wheels onto the shoes is shown diagrammatically in Fig. 3. Each shoe is attached to the extremity of a radius rod centered

on the axle, and the two rods are connected together by a cross piece, and to the trail by rods represented by O T. On the under side of the trail is fixed a rack, shown in the plan view, Fig. 3. When the gun is to be brought into action the trail is raised as shown dotted, and the end O of the rod O T slides along the rack to the point T<sup>1</sup>. On lowering the trail O engages with the rack and prevents E P from closing up on the trail, with the consequence that as the latter descends rotation takes place about P and the wheel mounts the shoe.

Having got the carriage into position with the gun pointing as nearly as possible in the right direction training is effected by lateral movement of the gun, not about a point on the axle as center of rotation, but about the trail spade as center of rotation. This is a very important point, because it results in the thrust of the recoil always being carried in a straight line

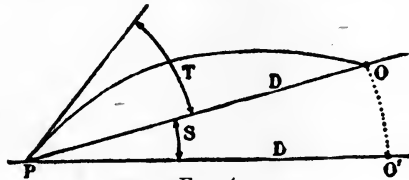

FIG. 4.

through the trail and there is very little tendency to throw off sideways. The desired movement is effected by cutting a screw on the central portion of the axle and fitting it with a nut which can be rotated by a handwheel. The nut is suitably attached to the upper end of the trail and consequently carries the latter with it. It follows from this movement that one wheel tends to go back and the other forward in the endeavor of the axle to remain normal to the trail, and the arrangement of the rods seen in the plan view of Fig. 3 permits this small displacement to take place.

Turning now to the aiming mechanism, we direct attention to Fig. 4. Suppose a gun placed at P and desiring to strike a target at O. It must obviously be given an upward inclination equal to  $S+T$ , S being the angle which makes it point direct at O and T the angle necessitated by the curved trajectory of the projectile. It is desired to make the adjustment of these two angles independent of each other. How this is affected will be gathered readily from Fig. 5, which is purely diagrammatic.

Centered on the trunnions of the gun cradle is a pair of arms B fitted with toothed sectors D. A pinion R rotated by a hand-wheel on the left side of the trail moves the rack. A spirit level coupled to this apparatus is placed in front of the operator, whose whole business is to keep the bubble in the center. The effect on perfectly level ground and with the gun at no degrees elevation would be absolutely horizontal fire. On uneven ground the effect is to bring the gun back to level and so provide a fixed datum for the adjustment of the angle of elevation. On the right side of the trail is another handwheel, which turns the nut M upon the fixed screw V. The nut is coupled to the rear end of the cradle, and as it rises or falls it raises or depresses the muzzle relatively to the horizontal. One member of the gun

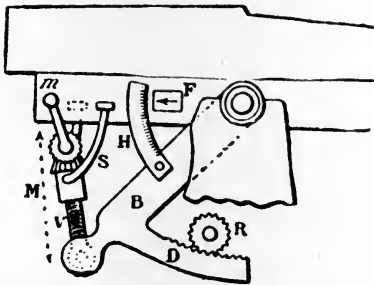

FIG. 5.—Elevating gear.

crew looks after one handwheel and another looks after the other, and the two work quite independently, the one always maintaining the angle S of the piece while the other gives the necessary elevation. The procedure probably is to put the elevating gear at zero, angle  $T = 0$ , and then direct the gun point blank at the target by turning the pinion R. This will incline the level, which must be again brought back to the horizontal and fastened in that position. The necessary degrees of elevation are then fixed on the graduated quadrant H, or rather on its equivalent, a drum which gives a magnified reading.

Its ammunition wagon is almost as interesting as the "soixante-quinze" itself. A perspective drawing is given in Fig. 6. It consists of two compartments separated by a locker and space for a fuze-setting appliance. It is shown in Fig. 6 in position for use with the covers open as shields for the men behind. On the road the covers are closed and the wagon is

returned to the horizontal with the projectiles resting point downward. The fuze-timing appliance was one of the innovations introduced with the "soixante-quinze" and is known as the *débouchoir*, the "uncorker"—Fig. 7. It consists of a plate with two depressions O formed to the ogive of the projectile, a handle M passing over a dial marked in distances and two levers L actuating two punches P. The distance at which the shell is desired to burst is set on the dial and each shell, as it is taken out of the caisson, is held nose downward in one of the recesses. Pressure is then put upon the lever. By this means the fuze is set very rapidly.

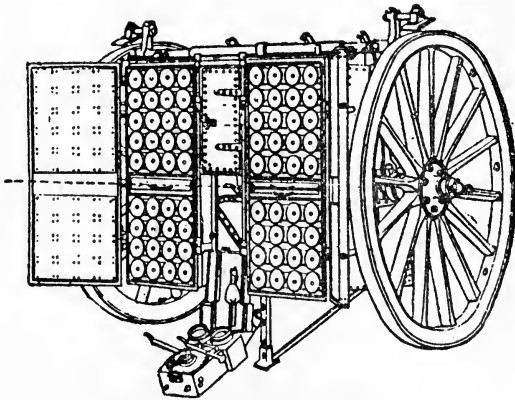

FIG. 6.—Ammunition wagon.

To understand more fully what happens we must look at the fuze itself—see Fig. 8—which again is diagrammatic. Inside the body piece is a conical chamber containing a hammer M pressed to the front by a light spring *r*. At *c* is a detonating cap and at X a block of compressed powder. Outside the cone is a spiral groove filled with fuze mixture communicating with a chamber below, which is open to the explosive charge inside the shell. When the gun is fired the inertia of M causes it to compress the spring V and strike the detonator *c*; this ignites X, the flame from which passes through a hole Y pierced by the "uncorker." The fuze mixture then takes fire, burns round the spiral, reaches the interior, and explodes the bursting charge. It will be seen that the shorter the length of fuze mixture from

the hole pierced by the *débouchoir* to the interior the earlier is the burst, and *vice versa*. Hence by piercing the hole at different points the time of bursting can be adjusted. We gather that with this fuze there is no timing scale as in our own and German shell. This is a feature of some value, for if the nose of a German shell be picked up the distance from which it has been fired may be estimated by examination of the scale on the fuze.

The fuze shown in figure 8 is also percussive—that is to say, if it fails to explode either accidentally or intentionally in the

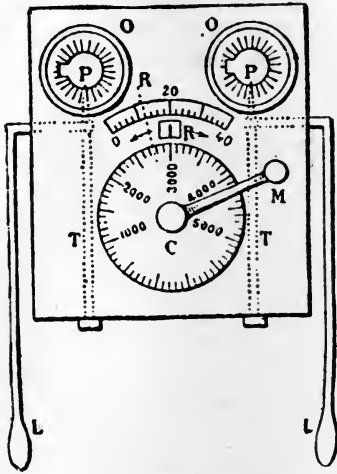

FIG. 7.—Fuze setter.

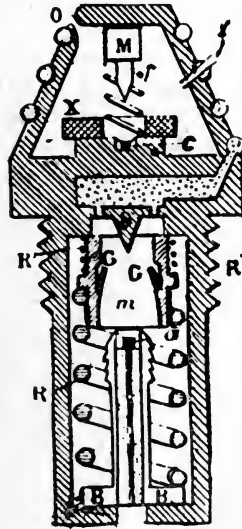

FIG. 8.—Time and percussive fuze.

air it bursts on impact with the ground or other obstacle. The essential parts are the fuze tube B held downward by the spring R and provided at its point with the detonating cap A; and the sleeve m fitted inside with pawls G. The striker S is fixed to the body of the fuze. When the gun is fired the sleeve m, by its inertia, compresses the spring R and the pawls engage with the serrations on the outside of the fuze tube B. The spring is thus held in compression and m, R, and B move as one piece. On impact their momentum carries them forward, compressing the light spring R', and drives the cap A against the striker S.

When using the explosive shell, which, while weighing less than the shrapnel—5.3 kilos, as against 7.2 kilos—appears to be very destructive, a delaying fuze is used. It contains a slow-burning mixture, which is ignited by the impact fuze, and in its turn fires a charge of melinite, which explodes the shell. The object is to allow the shell to enter the target some distance before bursting, the effects being more pronounced than when the explosion takes place on the surface.

The range of the "soixante-quinze" is 6,500 meters—nearly 4 miles—the projectile, shrapnel, weighs 7.2 kilos, and the charge 0.7 kilo. The muzzle velocity is 529 meter-seconds; the velocity at 1,000 meters, 413 meter-seconds; at 2,000, 334 meter-seconds; and at 3,000, 290 meter-seconds. The shrapnel contains 300 balls weighing 12 grams each. The weight of the piece ready for action is 1,100 kilos, and of the ammunition wagon, with 72 rounds, 1,950 kilos.







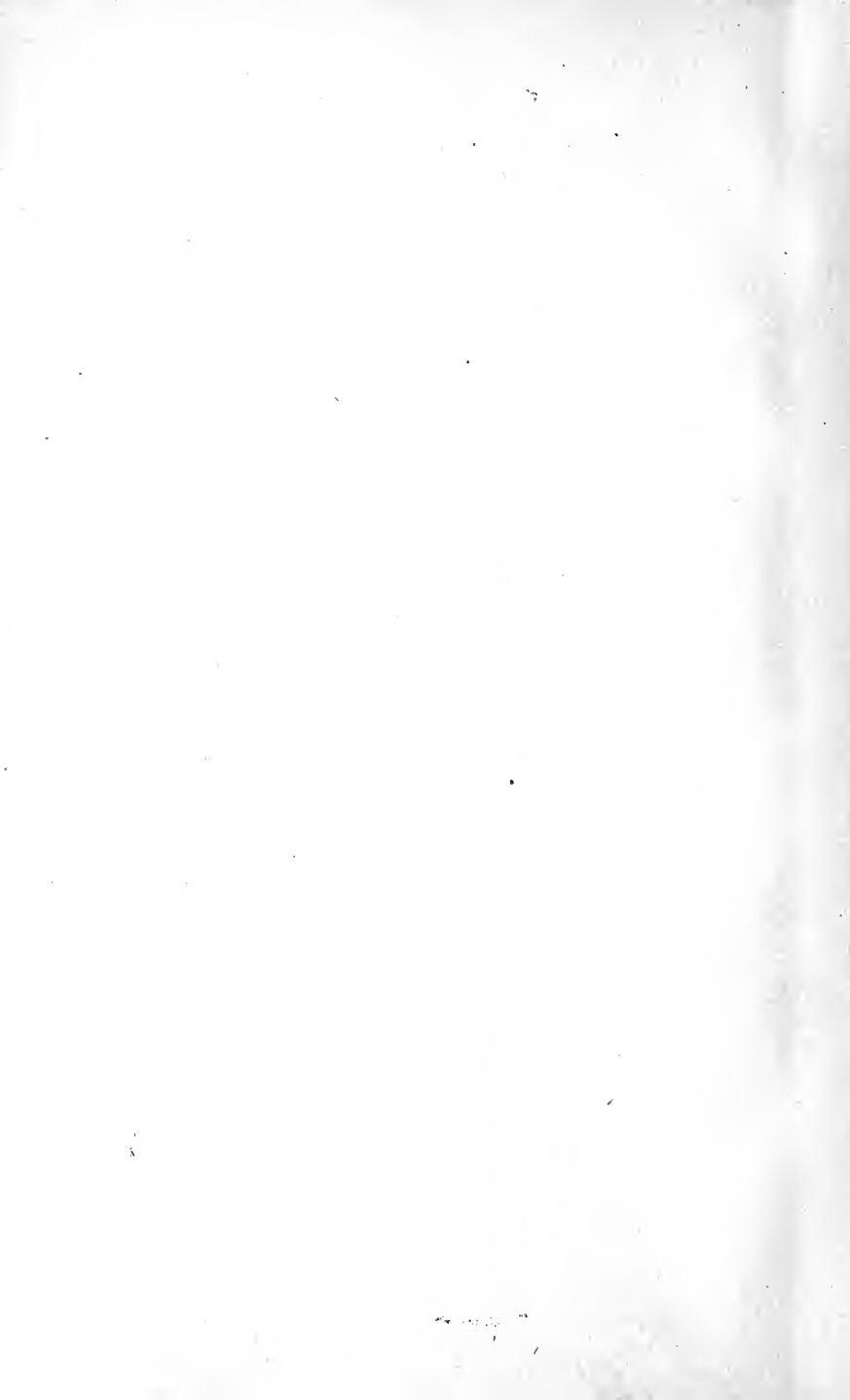

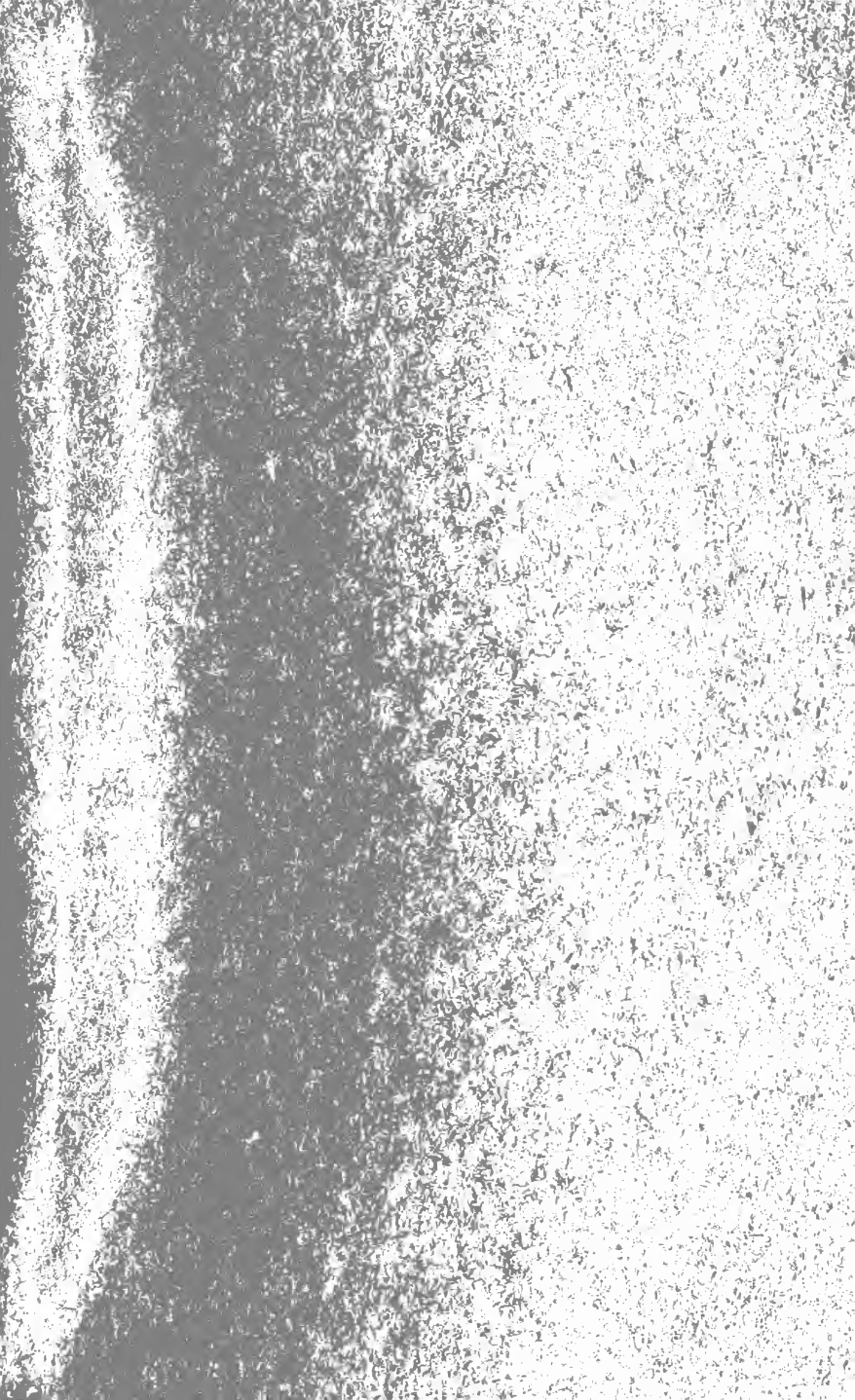

14 DAY USE  
RETURN TO DESK FROM WHICH BORROWED  
**LOAN DEPT.**

RENEWALS ONLY—TEL. NO. 642-3405

This book is due on the last date stamped below, or  
on the date to which renewed.

Renewed books are subject to immediate recall.

JAN 14 1969 2 8

REC'D LD

JAN 7 1969 5 PM

JUL 16 1988

AUTO DISC. JUN 28 '88

AUG 12 1990

AUG 7 1990

LD 21A-38m-5,'68  
(J401s10)476B

General Library  
University of California  
Berkeley

10/10

U.C. BERKELEY LIBRARIES



C006068165

