



Oceanus

Volume 21, Number 1, Winter 1978

The
Deep
Sea

Oceanus[®]

The Illustrated Magazine of Marine Science

Volume 21, Number 1, Winter 1978

William H. MacLeish, *Editor*
Paul R. Ryan, *Associate Editor*
Deborah Annan, *Editorial Assistant*

Editorial Advisory Board

Edward D. Goldberg, *Professor of Chemistry, Scripps Institution of Oceanography*
Richard L. Haedrich, *Associate Scientist, Department of Biology, Woods Hole Oceanographic Institution*
John A. Knauss, *Dean of the Graduate School of Oceanography, University of Rhode Island*
Robert W. Morse, *Associate Director and Dean of Graduate Studies, Woods Hole Oceanographic Institution*
Allan R. Robinson, *Gordon McKay Professor of Geophysical Fluid Dynamics, Harvard University*
David A. Ross, *Associate Scientist, Department of Geology and Geophysics, Woods Hole Oceanographic Institution*
John G. Sclater, *Associate Professor, Department of Earth and Planetary Sciences, Massachusetts Institute of Technology*
Allyn C. Vine, *Senior Scientist, Department of Geology and Geophysics, Woods Hole Oceanographic Institution*

Published by Woods Hole Oceanographic Institution

Charles F. Adams, *Chairman, Board of Trustees*
Paul M. Fye, *President of the Corporation*
Townsend Hornor, *President of the Associates*

John H. Steele, *Director of the Institution*

The views expressed in *Oceanus* are those of the authors and do not necessarily reflect those of Woods Hole Oceanographic Institution.

Editorial correspondence: *Oceanus*, Woods Hole Oceanographic Institution, Woods Hole, Massachusetts 02543. Telephone (617) 548-1400.

Subscription correspondence: All subscriptions, single copy orders, and change-of-address information should be addressed to *Oceanus* Subscription Department, 1172 Commonwealth Avenue, Boston, Mass. 02134. Urgent subscription matters should be referred to our editorial office, listed above. Please make checks payable to Woods Hole Oceanographic Institution. Subscription rates: one year, \$10; two years, \$18. Subscribers outside the U.S. or Canada please add \$2 per year handling charge; checks accompanying foreign orders must be payable in U.S. currency and drawn on a U.S. bank. Current copy price, \$2.75; forty percent discount on current copy orders of five or more. When sending change of address, please include mailing label. Claims for missing numbers will not be honored later than 3 months after publication; foreign claims, 5 months. For information on back issues, see page 72.

Postmaster: Please send Form 3579 to *Oceanus*, Woods Hole, Massachusetts 02543.

Contents

COMMENTARY: BENTHIC OCEANOGRAPHY

by Wallace S. Broecker **3**



PLASTERING AND DECORATING IN THE NORTH ATLANTIC

by Charles D. Hollister, Roger Flood, and I. Nicholas McCave

Scientists are studying abyssal bed forms to gain better understanding of sediment transport throughout the oceans – information having important bearing on exploration for fossil fuels and the disposal of toxic wastes. **5**

MIXING IN THE DEEP OCEAN – THE IMPORTANCE OF BOUNDARIES

by Laurence Armi

Mixing of water in the abyss was once thought due to uniform stirring. Recent work shows the process dominated by near-bottom turbulence where water contacts topographic features. **14**

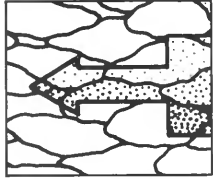

PARTICLES AND PARTICLE FLUXES IN THE OCEAN

by Derek W. Spencer, Susumu Honjo, and Peter G. Brewer

Recent data show the rain of particles from surface waters, nurturer of life on the deep seabed, can be quite rapid. **20**

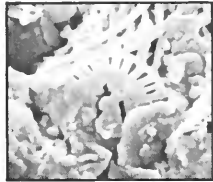

SEDIMENTS IN THE ABYSSAL BOUNDARY LAYER

by I. Nicholas McCave

The nepheloid layer, the suspension of cloudy material hovering over the bottom in some areas of the ocean, is attracting increasing attention. It can provide answers to questions of seabed erosion and deposition. **27**



BIOTURBATION IN DEEP-SEA DEPOSITS: RATES AND CONSEQUENCES

by Karl K. Turekian, J. Kirk Cochran, and David J. DeMaster

Mixing of sediment by organisms, bioturbation, must be well understood if science is to read the bottom record correctly when seeking, among other things, to reconstruct the history of climatic trends. **34**

DIVERSITY AND POPULATION DYNAMICS OF BENTHIC ORGANISMS

by J. Frederick Grassle

Scientists are finding that while there is a great diversity of life in the deep sea, the ecosystems there are fragile. Man-made disturbances, such as dumping of wastes or mining, could have dire consequences for abyssal organisms. **42**

DEEP-SEA MICROBIOLOGY

by J. Frederick Grassle

Microorganisms in deep-sea environments can tell us much about decomposition of organic matter under conditions of high pressure and low temperature. **50**

DEEP-SEA MANGANESE NODULES

Commercial mining of deep-sea manganese nodules probably less than a decade away. There are still many important questions to be answered about how the nodules form and their mineral makeup. **60**

INTERNATIONAL AGREEMENTS ON FREEDOM OF SCIENTIFIC RESEARCH IN THE DEEP SEA?

International negotiations this year could produce agreements hobbling scientific research in the deep sea. **68**

Deep-sea sponges in the Sargasso Sea. Photo by Vicky Cullen. BACK COVER: sponges and other organisms near the crest of the Mid-Atlantic Ridge at a depth of 2,629 meters. Photo by the Biological Observatory.

Woods Hole Oceanographic Institution. Published quarterly by Woods Hole Oceanographic Institution, 2543. Second-class postage paid at Falmouth, Massachusetts, and

DON'T MISS



1930

THE BOAT

Oceanus[®]

The Illustrated Magazine of Marine Science

Volume 21, Number 1, Winter 1978

William H. MacLeish, *Editor*

Paul R. Ryan, *Associate Editor*

Deborah Annan, *Editorial Assistant*

Editorial Advisory Board

Edward D. Goldberg, *Professor of Chemistry, Scripps Institution of Oceanography*

Richard L. Haedrich, *Associate Scientist, Department of Biology, Woods Hole Oceanographic Institution*

John A. Knauss, *Dean of the Graduate School of Oceanography, University of Rhode Island*

Robert W. Morse, *Associate Director and Dean of Graduate Studies, Woods Hole Oceanographic Institution*

Allan R. Robinson, *Gordon McKay Professor of Geophysical Fluid Dynamics, Harvard University*

David A. Ross, *Associate Scientist, Department of Geology and Geophysics, Woods Hole Oceanographic Institution*

John G. Sclater, *Associate Professor, Department of Earth and Planetary Sciences, Massachusetts Institute of Technology*

Allyn C. Vine, *Senior Scientist, Department of Geology and Geophysics, Woods Hole Oceanographic Institution*

Published by Woods Hole Oceanographic Institution

Charles F. Adams, *Chairman, Board of Trustees*

Paul M. Fye, *President of the Corporation*

Townsend Hornor, *President of the Associates*

John H. Steele, *Director of the Institution*

The views expressed in *Oceanus* are those of the authors and do not necessarily represent those of Woods Hole Oceanographic Institution.

Editorial correspondence: *Oceanus*, Woods Hole Oceanographic Institution, Massachusetts 02543. Telephone (617) 548-1400.

Subscription correspondence: All subscriptions, single copy orders, and checks should be addressed to *Oceanus* Subscription Department, 1172 Commonwealth Avenue, Woods Hole, Massachusetts 02543. Urgent subscription matters should be referred to our editorial office, checks payable to Woods Hole Oceanographic Institution. Subscription rate: \$18. Subscribers outside the U.S. or Canada please add \$2 per year handling charge. Foreign orders must be payable in U.S. currency and drawn on a U.S. bank. A 10 percent discount on current copy orders of five or more. When sending change, include mailing label. Claims for missing numbers will not be honored later than 3 months. For information on back issues, see page 72.

Postmaster: Please send Form 3579 to *Oceanus*, Woods Hole, Massachusetts

HAS THE SUBSCRIPTION COUPON BEEN DETACHED?

If someone else has made use of the coupon attached to this card, you can still subscribe. Just send a check — \$10 for one year (four issues), \$18 for two, \$25 for three* — to this address:

Oceanus

Woods Hole Oceanographic
Institution

Woods Hole, Mass. 02543

Please make check payable to
Woods Hole Oceanographic
Institution

*Outside U.S. and Canada, rates are \$12 for one year, \$22 for two, \$31 for three. Checks for foreign orders must be payable in U.S. dollars and drawn on a U.S. bank.

Contents

COMMENTARY: BENTHIC OCEANOGRAPHY

by Wallace S. Broecker **3**



PLASTERING AND DECORATING IN THE NORTH ATLANTIC

by Charles D. Hollister, Roger Flood, and I. Nicholas McCave

Scientists are studying abyssal bed forms to gain better understanding of sediment transport throughout the oceans – information having important bearing on exploration for fossil fuels and the disposal of toxic wastes. **5**

MIXING IN THE DEEP OCEAN – THE IMPORTANCE OF BOUNDARIES

by Laurence Armi

Mixing of water in the abyss was once thought due to uniform stirring. Recent work shows the process dominated by near-bottom turbulence where water contacts topographic features. **14**

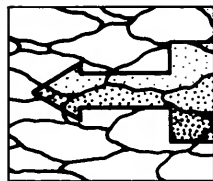

PARTICLES AND PARTICLE FLUXES IN THE OCEAN

by Derek W. Spencer, Susumu Honjo, and Peter G. Brewer

Recent data show the rain of particles from surface waters, nurturer of life on the deep seabed, can be quite rapid. **20**

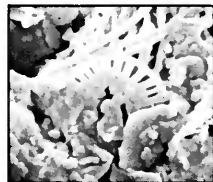

SEDIMENTS IN THE ABYSSAL BOUNDARY LAYER

by I. Nicholas McCave

The nepheloid layer, the suspension of cloudy material hovering over the bottom in some areas of the ocean, is attracting increasing attention. It can provide answers to questions of seabed erosion and deposition. **27**



BIOTURBATION IN DEEP-SEA DEPOSITS: RATES AND CONSEQUENCES

by Karl K. Turekian, J. Kirk Cochran, and David J. DeMaster

Mixing of sediment by organisms, bioturbation, must be well understood if science is to read the bottom record correctly when seeking, among other things, to reconstruct the history of climatic trends. **34**

DIVERSITY AND POPULATION DYNAMICS OF BENTHIC ORGANISMS

by J. Frederick Grassle

Scientists are finding that while there is a great diversity of life in the deep sea, the ecosystems there are extremely fragile. Man-made disturbances, such as dumping of wastes or mining, could have serious effects on abyssal organisms. **42**

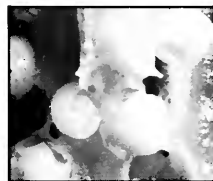

EXPERIMENTS IN DEEP-SEA MICROBIOLOGY

by Holger W. Jannasch

Study of microorganisms in deep-sea environments can tell us much about decomposition of organic materials under conditions of high pressure and low temperature. **50**



DEEP-SEA MANGANESE NODULES

by G. Ross Heath

With the widespread commercial mining of deep-sea manganese nodules probably less than a decade away, there are still many important questions to be answered about how the nodules acquire their mineral makeup. **60**



THREAT TO THE FREEDOM OF SCIENTIFIC RESEARCH IN THE DEEP SEA?

by David A. Ross

International negotiations this year could produce agreements hobbling scientific research in the depths. **69**

COVER: research camera ready for lowering in the Sargasso Sea. Photo by Vicky Cullen. BACK COVER: sponges and gorgonians grow attached to rock outcrops near the crest of the Mid-Atlantic Ridge at a depth of 2,629 meters. Photo courtesy Bruce Heezen, Lamont-Doherty Geological Observatory.

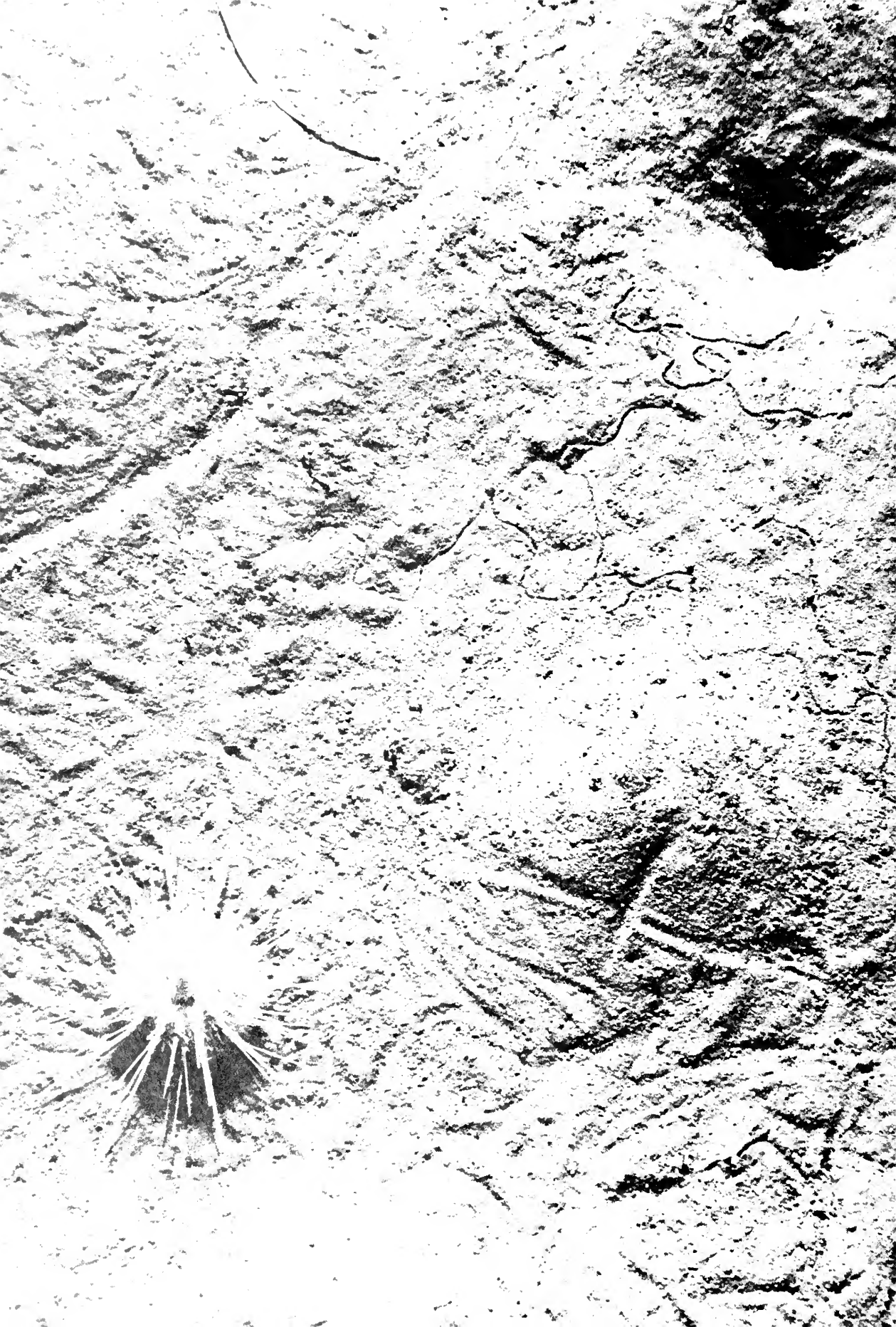

COMMENTARY:

Benthic Oceanography

Readers of this issue of *Oceanus* may suspect that the editor had to search long and hard to find a group of authors excited about research on the so-called "benthic boundary layer." A decade ago, this certainly would have been true, but he had no trouble finding candidates to write for this issue. These articles cover an area that has suddenly come into vogue as one of the major thrusts in oceanography. The question to be asked is rather "Why has a profession that has for so long almost purposely avoided any detailed studies of the region that separates the water realm from the sediment realm suddenly done an about-face?" Why are physical oceanographers, biological oceanographers, geochemists, paleontologists, and marine geologists currently clamoring for a piece of the boundary layer action?

One conceivable explanation would be that we in the field of oceanography are particularly vulnerable to research fads. Like the flotsam and jetsam in the ocean we study, our interests drift in unison with the tide of what is fashionable in the eyes of our funding agencies. Is such a tide currently moving toward the benthic boundary?

Fortunately for our intellectual reputation, which has always been marginal, this argument can be shown to be invalid. Although the interest in the benthic boundary layer has certainly been fattened by "band-wagon joining," the initial confluence of interest was quite genuine.

The origins of interest in the benthic boundary layer can be traced to our ability to measure things near the sea floor. The development of the continuous Salinity-Temperature-Depth probe (STD) enabled physical oceanographers to demonstrate that an isothermal benthic boundary layer (much like the surface mixed layer) several tens of meters thick is found almost everywhere at the base of the deep-water column. The manner in which this layer is generated and maintained immediately became a pressing theoretical question. During the same period, isotope geochemists found that the vertical distribution of various short-lived daughter products in the uranium-thorium decay series in the abyssal sea, and also in the bioturbated layer at the top of the

sediment column, allowed them to make quantitative estimates as to the rates of stirring in these realms. The manned submersible and its associated sea-floor navigation systems permitted the marine biologist not only to observe the organisms in action on the sea floor, but, even more important, it permitted him to bring experiments to the sea floor designed to quantify the metabolic and reproductive rates of these organisms. Meanwhile, the interest of marine geologists, the only group in the past to have shown a consistent concern with regard to these phenomena, was spurred by the development of new sonar systems, cameras, nephelometers, current meters, and other instruments.

By coincidence, a surge of activity in benthic research occurred almost simultaneously in all the major subdivisions of oceanography. As a sign that the age-old boundaries that have fragmented our discipline are at last breaking down, this interest in a common problem has fostered true cooperation among scientists with quite different training. It seemed clear to everyone that this was an area where progress would require the pooling of knowledge and techniques.

Of course, the ability to measure phenomena cannot by itself lead to a major shift of effort. There must be major unresolved scientific questions whose answers might be achieved through the application of the new technology. In this case, indeed, there are such questions. For example, most paleoclimatologists believe that if we are ever to crack the problem of the cause of glacial cycles it will be through studies of deep-sea sediments. One limitation in such studies is the loss of fidelity in the record generated by bioturbation. Since organisms stir the sediments to a depth of about 10 centimeters, and since the cores normally selected for climate studies have accumulation rates of only several centimeters per 1,000 years, events of several thousand years or less in duration have been badly smoothed by the movement of organisms through the upper sediment column. Studies of the physics of bioturbation will allow us to "deconvolve" the record.

Another major problem involves the planetary budget of chemical substances. All materials in the earth's upper realm (for example, its crust) are being carried around a grand geochemical circuit that involves erosion of continental material, passage through the sea to marine sediments, and, finally, regeneration into continental material

Sea urchin on clayey-silt bottom (2,086 meters) at 39°40.5' N, 70°38'W. Note the numerous tracks denoting animal activity on the surface and the burrow at upper right. (Photo courtesy David M. Owen)

through tectonic movement. By monitoring the flow of this material at a single point in this cycle, we can gauge its overall rate. The obvious monitoring point is its passage through the sea. There are, of course, many problems associated with such attempts. Among these are the non-uniformity of deposition that results from erosion, drifting, and the chemical recycling of material that falls to the sea floor. If we are to improve our knowledge of rates at which the cycle runs today and if we are to use the information obtained from long borings into the marine record to say how this rate has changed with time, then we must become more adept at reading the information stored in sediments. This can only be done by understanding the physics and chemistry associated with today's deposits.

Both the marine biologist and the physical oceanographer are eager to understand the rate of oxygen utilization in the deep sea. To the biologist, it would provide an estimate of the overall metabolic rate. To the physical oceanographer, it would provide estimates of the rate of ventilation (renewal by mixing) of the water in that particular region of the deep sea. Despite years of effort, these rates still evade our grasp. Two new approaches are being tried. The catchment rate of organic material by near-bottom sediment traps and the rate of oxygen utilization in sediment helmets* can yield such estimates provided, of course, we can develop traps and helmets sufficiently free of bias.

These examples by no means complete the list of important scientific questions whose answers depend at least in part on observations made within the benthic boundary layer. They do, however, demonstrate how our past inability to study this region effectively has held up the development of our science along several important fronts.

Perhaps more than any other science, oceanography has received the message of the 1970s. The golden era during which science was given a blank check by the public to pursue its whims has come to a close. More and more we are required by our "sponsors" to demonstrate the benefits of our efforts to mankind. This being the case, one might ask what benthic boundary layer work has to offer.

Again, a rather firm positive answer can be given. The knowledge gained from these studies can be directly applied toward resolving several critical issues. Major among these are the soon-to-come environmental impacts of oil exploration in deep waters, recovery of manganese nodules, and disposal of radioactive wastes on or into the sea floor. It is no longer a question of whether these things will be done, but rather to what extent and under what restrictions.

Half the globe's surface lies in the benthic boundary category, yet we know almost nothing about its ecology. It is easy and perhaps even logical to say that since the "earthworms" of the continents have handily survived the onslaught of urban development, farming, and forestry, their brothers — the abyssal sea worms — are unlikely to be threatened by our more modest deep-sea enterprises. Sane planning demands that we develop a more rigorous understanding of these remote systems before rather than after subjecting them to new pressures. Our intuition is not always correct.

Already we have learned that even these creatures are working on our behalf. They stir the toxic products of our civilization, which already reach the sea in copious amounts, into a layer of highly absorbent sediment several tenths of centimeters thick — and thereby render them far less likely to return via the food chains of the sea to our dinner plates. Furthermore, during the coming century, when we will be forced to burn enormous amounts of fossil fuels, these organisms will churn back to the interface a continuous supply of sedimentary calcium carbonate (CaCO_3). By neutralizing the sea's excess acidity, this CaCO_3 will accelerate the removal of carbon dioxide added to the atmosphere as a product of combustion. Thus even if we take our usual selfish view of the biosphere, we cannot so easily dismiss our abyssal friends as curiosities unworthy of serious attention. The articles in this issue provide some background on a new and exciting effort in oceanography — a hard look at the processes associated with the benthic boundary layer. As a side benefit, these studies provide a base from which to assess the possible environmental impacts of pending activities that promise to alter the world's largest wilderness area.

Wallace S. Broecker

The author is Professor of Geochemistry at Lamont-Doherty Geological Observatory, Columbia University, New York.

*A container designed to intercept the ions escaping from the sediments at the sediment/water interface.

Plastering and Decorating in the North Atlantic

by Charles D. Hollister, Roger Flood,
and I. Nicholas McCave

Vast areas of the deep-sea floor are decorated with distinctive sediment bed forms that have been produced by strong, near-bottom currents. These forms and currents are important because, on a practical level, our understanding of their construction and routes can have a direct bearing on the selection of sites for the disposal of toxic wastes in the deep sea, and may also be applied to exploration for minerals, oil, and gas. On a theoretical level, the features provide a long-term geological record of seabed current activity, a record that would be impossible to obtain through conventional measurement techniques, such as current-meter moorings. Bed and current records are obtained by using a combination of observations from submersibles, surface ships, and such vehicles as Scripps Institution of Oceanography's *Deep Tow* device (see *Oceanus*, Spring 1977). The bed forms range in size from regular, sinusoidal mud waves several kilometers between crests and tens of meters high to very small lineations measured in centimeters. Ripple patterns also have been detected in bottom photographs at depths of more than 5,000 meters.

When these patterns were first observed, it was thought that the abyss was generally a tranquil region with little to disturb the gentle rain of particles from above. It did not seem possible to some that these patterns were produced by strong, near-bottom currents. There are, of course, vast areas (in the middle of great oceanic plates and beneath the major surface circulation gyres) where tranquility, perturbed only by the gentle probings of a wide variety of benthic organisms, is the rule. But recent observations, utilizing sophisticated deep-sea instruments, reveal that considerable commotion prevails near the edges of ocean basins and in regions where bottom water is produced.

Abyssal Ocean Commotion

Because of the earth's rotation, moving particles are deflected to the left in the Southern Hemisphere and to the right in the Northern Hemisphere by what is known as the Coriolis effect.* In general, near-bottom currents follow this pattern in harmony with the bottom terrain. For example, in

*The effect or force is proportional to the speed and latitude of the moving particle and cannot change the speed of the particle.

the circumpolar Antarctic region of the Pacific, bottom water originates through the cooling of surface waters, which then flow downslope from the Antarctic continent toward the equator (where the Coriolis force is zero). At high latitudes, where the deflecting force is greatest, the bottom water moves toward the left as it winds northward around the rugged sea-floor landscape. In fact, the deep-sea floor in the Pacific is well-scoured along its western edge — the New Zealand continental rise is an example, as is the Samoan Passage.

In both the Pacific and Indian Oceans, bottom water is produced only at the southern ends. Thus their basins are similar in that they are affected solely by deep Antarctic bottom currents flowing from the south. The Atlantic Ocean alone has bottom water production at its northern and southern ends. In both source areas, cooling takes place over water with relatively high salinity values, thus producing water dense enough to sink to the bottom while heading toward the equator.

In all oceans, strong bottom current activity is concentrated on the western side of basins. This is exactly where we find the most dramatic and most abundant current-produced abyssal bed forms; this is where the most turbid bottom water exists (see page 27). Erosion of vast areas of the sea floor is happening today as a result of very strong currents (more than 20 centimeters per second), which remain steady over periods of years as opposed to other oceanic areas dominated by transient eddies (see *Oceanus*, Spring 1976). In fact, in order to produce huge geologic features, the flow of bottom water *must* follow the same path for periods of hundreds to thousands of years. In some regions, we have evidence that this has occurred for tens of millions of years. In a way, these geologic effects are the longest current-meter records available. It is true they do not record all, or even most, of the current variations, yet some features record the strongest events, while others indicate the average conditions of sediment deposition. These are the events in which marine geologists have the greatest interest.

Atlantic Sediment Redistribution Patterns

Shortly after underway seismic profiling was perfected by Lamont-Doherty Geological Observatory in the early 1950s, the concept of

Sediment Drifts



GREENLAND

Hudson Strait

CANADA

Labrador

Newfoundland

Nova Scotia

LABRADOR SEA

EIRIK RIDGE

S.E. NEWFOUNDLAND RIDGE

This portion of the
contour was
published in 1977 by Marie Ther...

in the North Atlantic



North Atlantic Panorama excerpted from the World Ocean Floor by Bruce C. Heezen and Marie Tharp that was recently published by the Lamont-Doherty Geological Observatory of Columbia University and sponsored by the United States Navy through the Office of Naval Research. Copyright © 1977 by Marie Tharp.

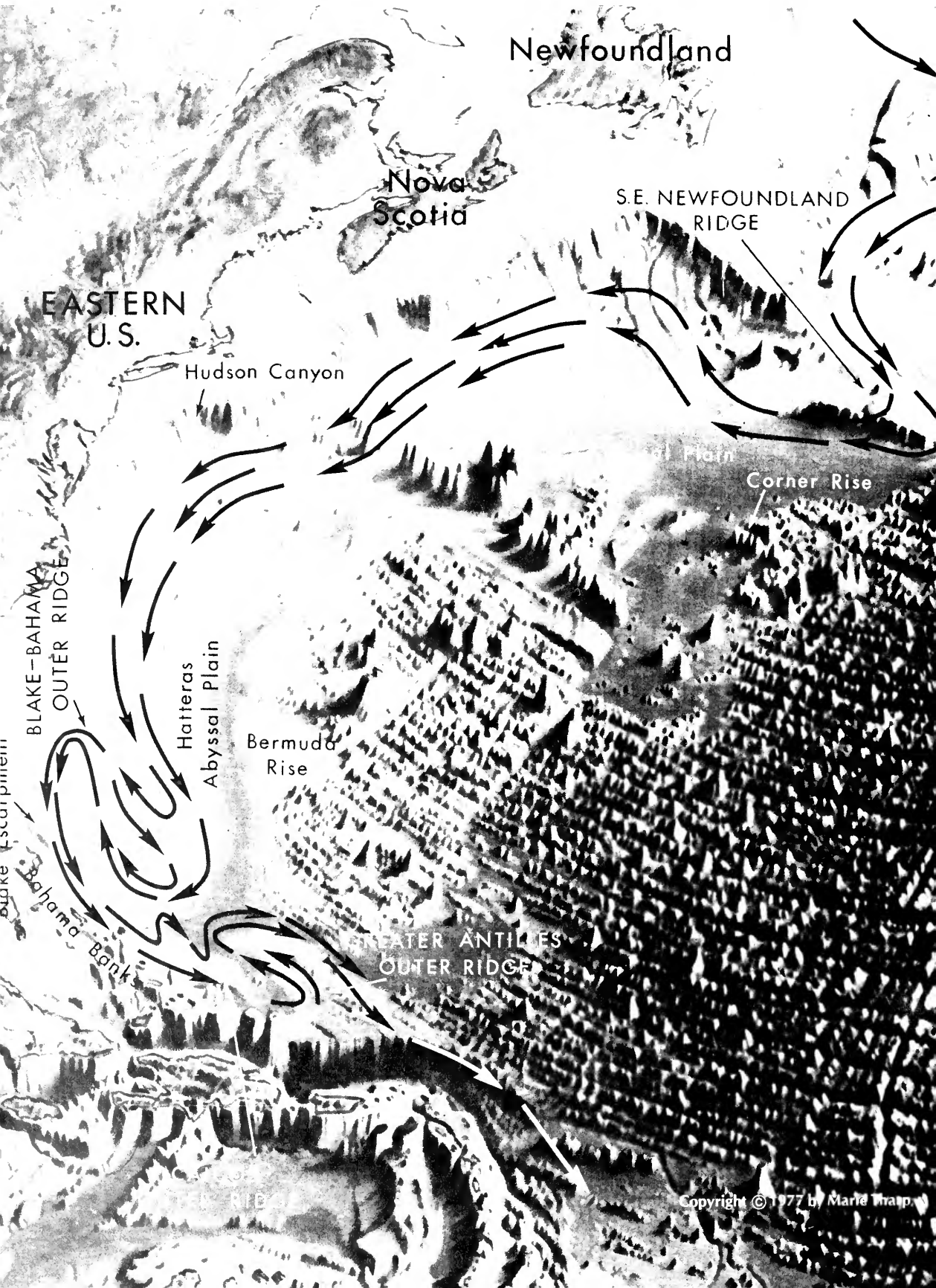

tranquil ocean basins evenly blanketed by pelagic sediment required major revision. The profiles, laboriously created using quarter-pound blocks of TNT, gave the first indication that a number of the major topographic features of the deep sea are composed entirely of sediment rather than consisting of thin sediment veneers over volcanic basement. During the subsequent two decades, our observations of regional topographic patterns as well as distribution patterns of unconsolidated sediments have shown that the north and northwestern Atlantic are particularly interesting places with respect to sediment drifts.* The distribution patterns in the North Atlantic of these thick linear bands of sediment showed a general correlation with the spreading direction of dense water masses, particularly those that could be traced to the northeastern North Atlantic and the Norwegian Sea.

During the last five years, the authors and their colleagues, particularly Peter Lonsdale, Brian Tucholke, Edward Laine, Sandy Shor, and Herman Zimmerman, have collaborated in trying to understand the apparent correlation between the spreading of water masses, near-bottom currents, and sediment distribution. From this effort, a significant amount of information has been amassed, and some very interesting patterns have emerged.

Sediment Drifts

As one descends the scale from thousands of meters to centimeters, one's viewpoint of long-term and shorter-term current activity changes from broad regional effects to very local ones. In our efforts to understand the northeastern and northwestern North Atlantic and its attendant sediment drifts, it seems logical to start from the northern source region of bottom water — the Norwegian Sea, from which cold water overflows at several points along the ridges between Iceland, Scotland, and Greenland. This water source first became available about 35 million years ago, when construction of most of the drifts was initiated. Let us follow the currents from the overflow as they move toward the Equator and examine the major sediment accumulations they have produced.

Feni Drift

The sediment pile affected by the easternmost overflow of Norwegian Sea water as it cascades down the various shallow channels between Iceland and Scotland is located in the Rockall Trough and is called the Feni Drift. A small portion of the overflow water comes through the Wyville Thompson Ridge and into the Rockall

Channel, where it is responsible for shaping the drift. This region was recently studied using Scripps' *Deep Tow* vehicle. The drift, like many others, is composed of silty clay, consisting of approximately 10 to 30 percent biogenic components; the rest is contributed by various insular and continental sources. It is a region of about 75,000 square kilometers, variously decorated by downslope debris flows, turbidity current channels, and large-scale mud waves that are migrating upslope. The construction of the drift probably was the result of a redistribution of terrigenous debris coming off the Scotland/Iceland shelf, biogenic components from highly productive surface waters, and scoured and eroded portions of the sea floor upcurrent of the region.

Hatton Drift

The deep current continues around the toe of the Rockall Bank, hugging the contours, but moving to the right at every opportunity. It breaks around the corner of the Rockall Bank, and heads back toward the north-northeast. Here, there is a relatively even bank of sediments that is not deposited in the form of a ridge like the Feni, but rather is a wedge of mud — the Hatton Drift — plastered up against the foot of the western flank of the Rockall Bank. Again, data show a very strong near-bottom current flowing parallel to the contours, apparently smoothing and shaping this sedimentary deposit, which is approximately 20 kilometers wide by 130 long.

Katla Ridges and Gardar Drift

At the head of the basin south of Iceland, the northeasterly flowing component of the Norwegian Sea overflow water is joined by water pouring through the Iceland-Faeroes Channel. Over extensive periods of time, explosive under-ice volcanism on Iceland has generated a large amount of debris, which has contributed a great deal of sediment to this vigorous current flow. With relatively high velocity and in a position approximately parallel to the contours, it flows toward the west along the Insular Rise of Iceland, where it constructs the massive sedimentary deposits of the Katla Ridges. The muddy current is then forced to make a turn to the south as it hits the Reykjanes Ridge. Banked against this mid-ocean spreading center (see *Oceanus*, Winter 1973) is a sediment pile of 250,000 square kilometers, called the Gardar Ridge or Drift. It has a number of subsidiary curved ridges that are covered with sinusoidal sediment waves.

The complex interaction of currents and original topographic elements from sea-floor spreading events appears to be responsible for the formation of the Gardar Drift. The origin of the curved ridges is unclear; it is possible that eddies

*A large topographic feature (tens to hundreds of kilometers) composed entirely of sediment.

have caused this unusual sedimentary physiography.

Charlie-Gibbs Fracture Zone

The Norwegian Sea overflow current system appears to lose most of its suspended sediment on the Gardar Drift before finding a conduit through the Mid-Atlantic Ridge, located at about 53 degrees North in a region called the Charlie-Gibbs Fracture Zone. This zone contains a relatively small (5-by-15 kilometer) sediment pile stacked up against its northern wall, probably originating from local sources of biogenic and ridge-crest-derived sediment, as well as from material left in suspension after the transit around the Gardar Drift. Currents measured in the Charlie-Gibbs Fracture Zone have been steady, with up to nine months of record indicating strong flow from east to west.

Erik Ridge

The Norwegian Sea overflow water next flows north-northeast along the western flank of the Reykjanes Ridge, leaving little trace of its passage because of a lack of significant sediment source. The flow continues to the northern extent of the Irminger Basin or Irminger Sea, where it is deflected on a reverse course by the sill of the Iceland-Greenland Ridge. At this point, additional Norwegian Sea overflow water joins the flow and, with renewed vigor, moves southwesterly along the continental rise of eastern Greenland. Here, it encounters new bottom sources: turbidity current sediments coming down the margin, glacially-eroded material dumped onto the continental margin; and sediment picked up by the erosional action of the rejuvenated current. Along the extent of the Greenland Rise, new sediment is put into a thick nepheloid layer. The current is forced to make a sharp bend to the right around the tip of Greenland, where a massive deposit — the Erik Ridge — is found.

The Norwegian Sea overflow water is joined here by additional deep, cold water from the Irminger and Labrador Seas. The resulting water mass is called North Atlantic Deep Water. It begins to flow around the southern tip of Greenland up into the Labrador Sea toward the north until it encounters the sill at the northern end of the Labrador Sea, where once again it is forced by topography to reverse its course and flow in a southerly direction along the continental rise of Labrador. The continental rise of eastern Greenland and the Erik Ridge appears to be the site at which debris eroded from Greenland and resuspended from the bottom by the Norwegian Sea overflow water is deposited, while the continental rise on the western side of Greenland is relatively sediment-starved, a situation similar to that on the west side of the Reykjanes Ridge. Apparently most of the sediment load is deposited on Erik Ridge, so

that only a small amount remains by the time the flow reaches the rise off western Greenland. However, some resuspension must occur along this rise because bottom photographs show erosional bed forms (Figure 1).



Figure 1. Bed forms at 57°33'N, 48°46'W, on the continental rise off southwestern Greenland. Erosional nature of sea floor with remnant sediment "tails" behind obstacles indicates sediments are resuspended from this area. The eroded sediments are transported downstream in the nepheloid layer. (Photo courtesy National Science Foundation)

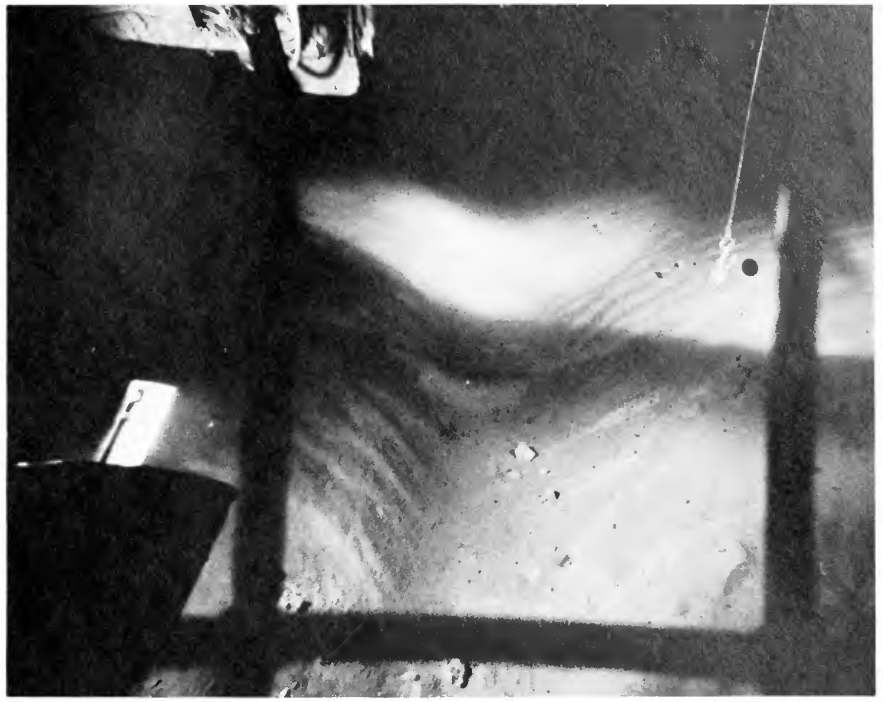

Figure 2. View of a small furrow on the Blake-Bahama Outer Ridge from the bathyscaphe Trieste II. (Photo courtesy U.S. Navy)

Labrador Rise and Southeast Newfoundland Ridge

Sediments from the Hudson Strait and from the Labrador shelf and land mass form an exceptionally thick continental rise off Labrador. Some of this terrigenous debris is injected (mostly by the movement of turbidity currents) into the contour-following North Atlantic Deep Water along the Labrador Rise.

Once again the current, still in high northern latitudes (north of 50 degrees North), is forced to turn right around the tip of Newfoundland, where a large mass of sediment is deposited against the rugged topographic relief of the southeast Newfoundland Ridge. This ridge extends in a southeasterly direction from the Grand Banks off Newfoundland. The deep current then flows along the base of the continental rise, sculpturing and reshaping the sediments supplied through the Laurentian Channel, Nova Scotia, and the Gulf of Maine.

Eastern U.S. Continental Rise

As the current flows south of the Hudson Canyon off New York, it is augmented by some of the northernmost vestiges of Antarctic bottom water that has flowed north along the western Bermuda Rise and has joined the southerly flow of North Atlantic Deep Water. Apparently, a large amount of North American sediment, swept from the continent over the last tens of millions of years, has been incorporated into this flow and has been modeled into a feature resembling a continental rise — the Blake-Bahama Outer Ridge* — covering

an area of 400,000 square kilometers southeast of Cape Hatteras. For reasons not yet understood, it has developed in the Atlantic rather than along the continental margin. This may be due to an interaction between the deep, southward-flowing Western Boundary Current and the shallower, northward-flowing Gulf Stream system. Blake-Bahama is built almost entirely of sediments from north of Cape Hatteras. A vast amount of the continental United States has been deposited here, and the deep currents have formed some very dramatic abyssal furrows (Figure 2). When the current returns to the continental margin along the steep Blake escarpment, after flowing in a sinuous pattern around the Blake-Bahama Outer Ridge, it again flows to the south, but at an increased rate (more than 30 centimeters per second). The escarpment feature is due to the combination of increased velocity and lack of a nearby sediment source.

Caicos and Greater Antilles Outer Ridges

The deep current continues its journey to the south, where it will finally approach the equator. Now a combination of northern and southern sources, the water picks up a significant amount of fine carbonate sediment from the Bahama Banks, depositing a drift called the Caicos Outer Ridge.

The last of the large sedimentary deposits produced by the flow is the Greater Antilles Outer Ridge.* Here, much of the sediment left in suspension is deposited as a sediment drift. Once again, as on the Blake-Bahama Outer Ridge, the current is forced to detour in a snake fashion

*A new name for this ridge has been proposed by Marie Tharp — the Heezen Drift.

*Marie Tharp has proposed a new name for this ridge — the Hollister Drift.

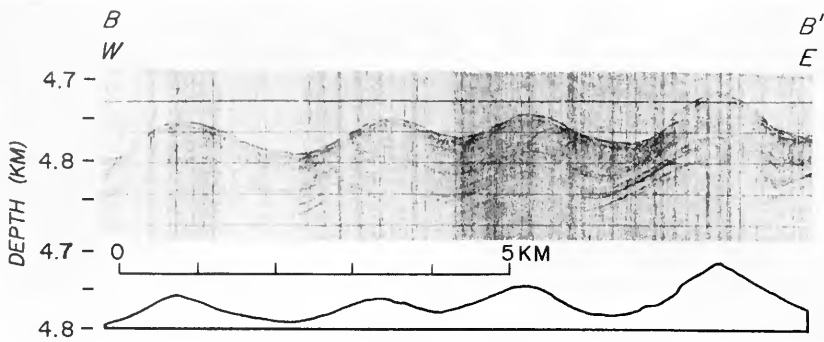

Figure 3. A 3.5-kHz echo-sounding profile of a mud wave on the Blake-Bahama Outer Ridge, showing migration of wave upslope. Below is a near-bottom bathymetric profile of the same area. Note the sharpness of peaks in comparison to the echo-sounding profile.

around a sediment drift of its own making. The current continues to the southeast, decreasing in intensity, suspended sediments, and velocity as it sluggishly approaches the equator in the vicinity of northern South America.

Bed Forms Associated with Regional Drifts

In general, large mud waves (Figure 3) are found on sediment drifts, particularly down-current from regions of high sediment input. They appear to be produced by depositional processes within deep-current circulation patterns. These mud waves, which can be identified from surface ship echo-sounding profiles, are common features. They are well developed on the Feni and Gardar Drifts, and have a patchy distribution on the Erik Ridge. They are known as "lower continental rise hills" along the base of the continental rise off the central Atlantic states.

Small hyperbolic echoes (Figure 3) are generally believed to be the side-echo reflections

from furrows. These hyperbolae have a spotty distribution on the flanks of the Feni and Erik Ridges and are very well developed on the Blake-Bahama Outer Ridge. The furrows, an order of magnitude smaller than the mud waves of the Blake-Bahama Outer Ridge, are incised on the mud waves themselves (Figure 4). On Blake-Bahama, the furrows appear to be related to post-glacial, or modern current activity. Near-bottom observations from the bathyscaphe *Trieste II* indicate that some furrows are presently being eroded, while others may be depositional. Small (centimeter-scale) asymmetric ripples (Figure 5) are found on the side of depositional furrows. These ripples are developed in fine-grained cohesive sediments and appear to be in equilibrium with the present flow pattern.

The Importance of the Work

Over the years, the origins of many of these bed forms and drifts that we have just outlined have

Figure 4. Abyssal mud waves bathymetric map of Blake-Bahama Outer Ridge area. The shaded areas of map are the furrows detected by side-scan sonar that trend southeast to northwest. Arrows indicate direction of highest velocity currents, approximately 10 centimeters per second. The contour interval is 10 meters. The Figure 3 bathymetric profile was taken in the middle of this area.

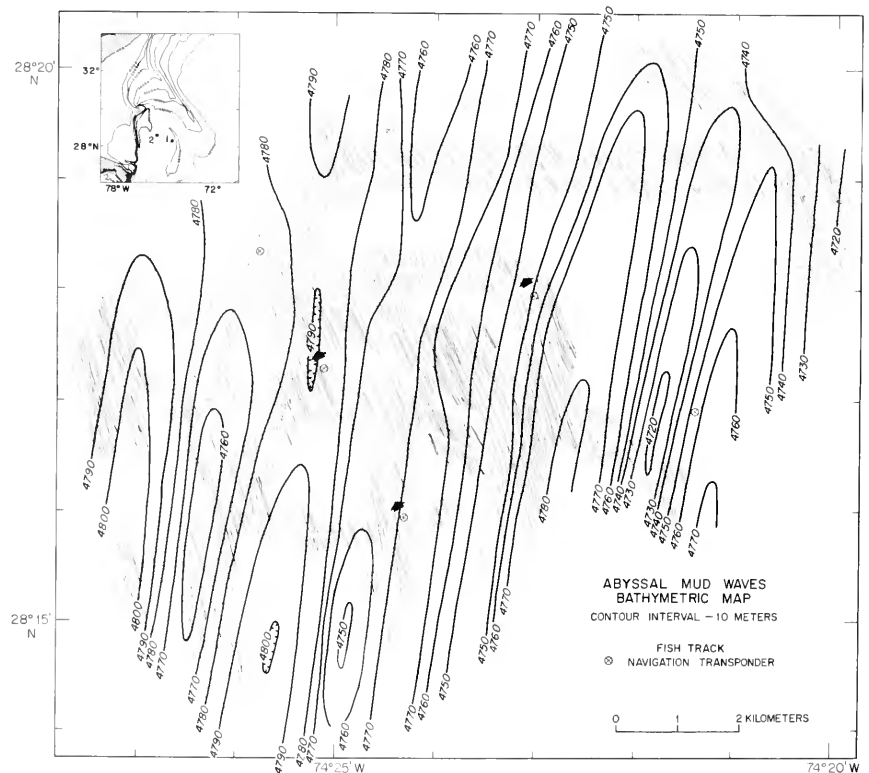

Figure 5. Ripples in fine-grained sediments on the edge of a furrow on the Blake-Bahama Outer Ridge. The spacing between ripples is about 20 centimeters. The current here is about 10 to 15 centimeters per second. This photograph was taken by Roger Flood, from the bathyscaphe Trieste II in September, 1977.



been the subject of considerable speculation among marine geologists. Although some theories had been proposed to account for their origins, few hard facts were available until recently. One of our major efforts at present is directed toward determining the conditions that are necessary for the formation and maintenance of the various bed forms. Once we know the specific conditions necessary for the formation of these features, we will be able to construct a better picture of deep-ocean circulation around the world.

The drifts of the North Atlantic provide an easily accessible natural laboratory in which bed forms can be studied. The knowledge gained in this area will help us appraise the role of deep currents in other areas of the ocean, where detailed investigations have not yet been made — such as the South Atlantic, Indian, and South Pacific Oceans, as well as the continental rise off Antarctica.

Determination of the origin of the sediments, such as on the continental rise off eastern North America, is also important in assessing the economic potential of the area. Current-deposited sediments are generally fine-grained with few coarse sand beds, whereas the products of downslope sediments are commonly coarse sand beds, which can accumulate hydrocarbons. Thus we would expect that drifts built largely by currents would be unsuited for the development of rich liquid hydrocarbon accumulations but might possibly hold important gas deposits, whereas areas under the influence of downslope sediment transport would be good candidates for hydrocarbon accumulations.

Knowledge of the distribution of bed forms and sediment drifts in the oceans also provides information on the regional paths of active bottom currents. Thus relatively tranquil regions of the

ocean can be identified, regions that might prove suitable sites for the disposal of such toxic materials as high-level nuclear waste (see *Oceanus*, Winter 1977).

Finally, from an oceanographic point of view, one of the most important results expected from the study of deep-sea bed forms is a better understanding of the way in which sediment is eroded and transported throughout the oceans, as well as the frequency of the current events that form or maintain these features.

Charles D. Hollister is an Associate Scientist in the Department of Geology and Geophysics, Woods Hole Oceanographic Institution. Roger Flood is a graduate student in the Massachusetts Institute of Technology/Woods Hole Oceanographic Institution Joint Program in Oceanography. I. Nicholas McCave is a Visiting Investigator in Geology and Geophysics, Woods Hole Oceanographic Institution.

Further Reading:

- Heezen, B. C., and C. D. Hollister. 1971. *The Face of the Deep*. New York: Oxford University Press.
- Heezen, B. D., ed. 1977. Influence of abyssal circulation on sedimentary accumulations in space and time. *Mar. Geol.* 23: 1-215.

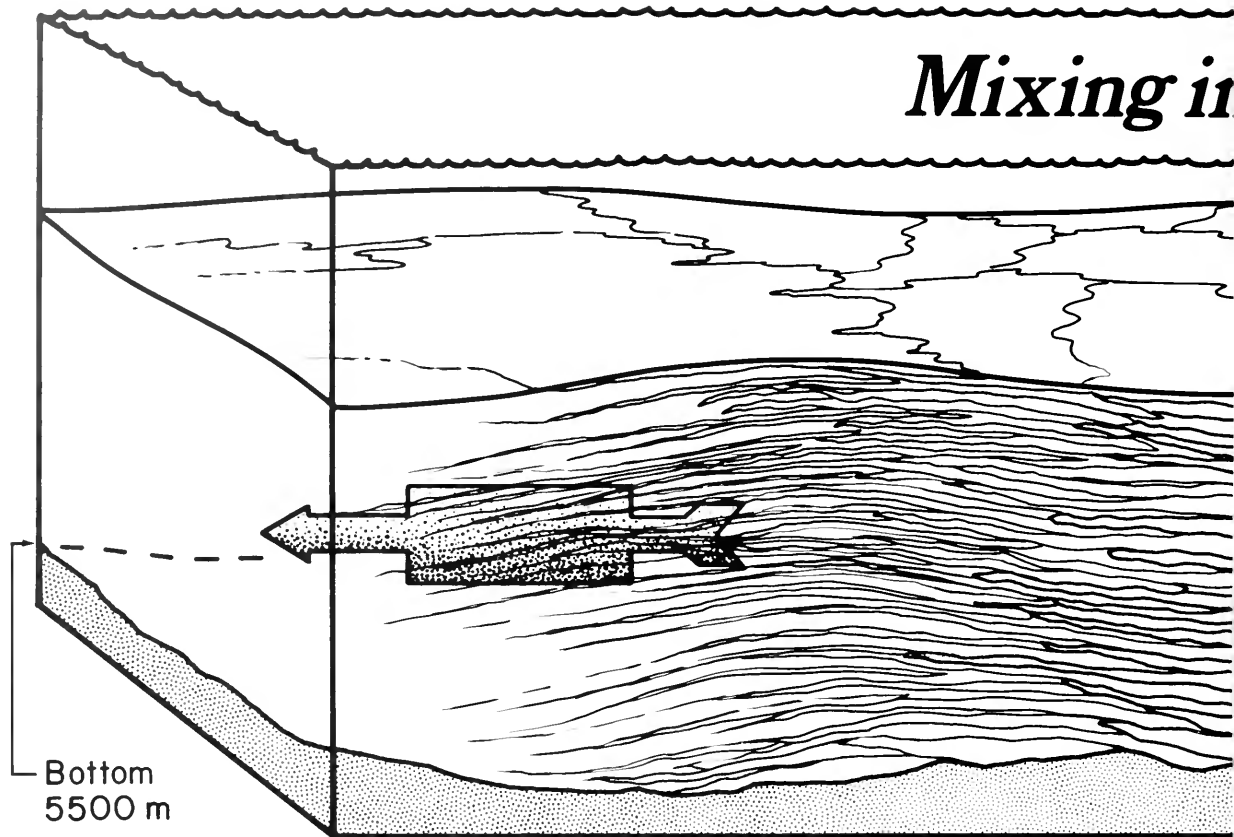

The Importance of Boundaries

by Laurence Armi

Recent data on deep-ocean mixing are forcing some revisions in our thinking about the importance of near-bottom processes. Just as at the surface of most parts of the ocean there are mixed layers of water affected by such factors as weather and geographical location, so in the abyss there are also mixed layers of water near the bottom that are influenced by the seabed terrain and the horizontal movement of currents and eddies. The study of these deep-water mixing processes is important for a number of practical and theoretical reasons. A better understanding of these processes can be applied to the siting of gas and oil exploration rigs, especially where data are needed about silting rates around drill holes. Bottom mixing also would be a factor in any considerations pertaining to disposal of toxic wastes in the deep seabed. Then, too, the study of these layers has its military applications, particularly in the acoustics field.

In the past, oceanographers did not have a clear picture of what was happening at the bottom in respect to mixing processes because they were limited by sampling devices — Nansen bottles — that could only give sparsely spaced point-by-point data. At present, our picture of the bottom is becoming more precise, thanks to the recent development of instrumentation that has allowed

us to obtain temperature, salinity, and light-scattering measurements nearly continuously from the surface of the ocean to the bottom.

Whereas at one time it was thought that mixing in the abyss was due to uniform stirring, it is now becoming evident that mixing is dominated by near-bottom turbulent processes where water contacts topographic features, such as seamounts, islands, and basin boundaries.

Continuous Stratification

In the deep ocean, temperature, salinity, and other properties of the water column, such as dissolved tracers, appear at first to vary slowly and continuously from below the permanent thermocline to the bottom. On closer inspection, however, deviations from the typical continuous stratification are found. It is the location and character of these deviations that provide the important clues necessary to understand the mixing processes taking place.

An example of continuous stratification and a simple perturbation on it, due to the bottom, is shown in the Figure 1 profiles of potential temperature and salinity as a function of pressure. Since atmospheric pressure is approximately the pressure exerted by 10 meters of water, a decibar

the Deep Ocean

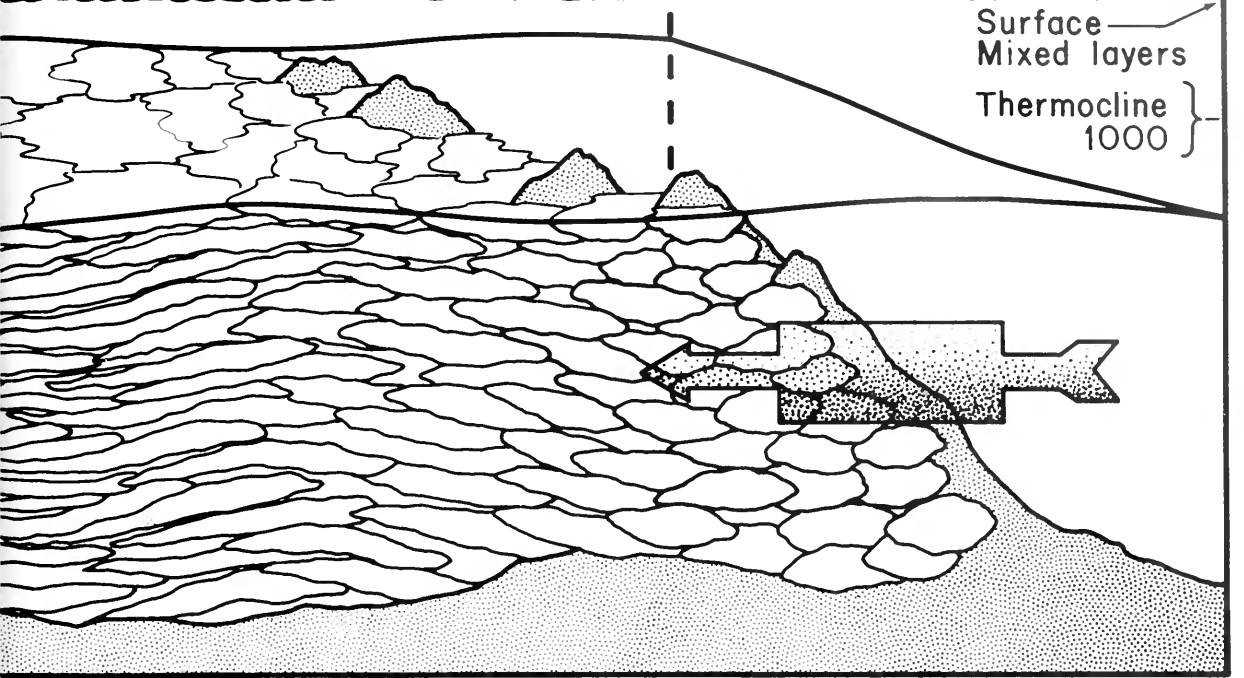

Simplified sketch of boundary mixing of continuous stratification into layers and subsequent transport of mixed layers into interior of basin. Bottom generated turbulence due to the motion of the water itself is the mixing mechanism for the layers (arrow at right). They then collapse, flatten, and intermingle to form a continuous stratification again in the interior (arrow at left).

(.1 atmosphere), the unit of pressure used, is approximately 1 meter (at 5,000 meters, the pressure is 4,908 decibars). Also, since seawater is compressible at these pressures, the temperature shown is potential temperature, θ , the temperature the water would have been if brought to the surface in an insulated container. Above the bottom first 60 decibars, the usual deep-ocean continuous stratification is found. The least saline but coldest water is found at the bottom; the stratification is stable since density is a function of both temperature and salinity. These profiles were taken with the profiler shown in Figure 2.

Deviations From Continuous Stratification

The first indication of the importance of topographic boundaries in respect to continuous stratification is shown in Figure 1. In the first 55 meters or so above the bottom, the water is well mixed. This signature of a well-mixed region near the bottom is both ubiquitous and distinctive. In the profile shown, it appears that the continuous stratification, represented by a dashed line, was stirred to form the well-mixed region, which is bounded by a sharp interface. A signature like that of Figure 1 is also seen in laboratory experiments, where a uniformly stratified fluid in a tank is stirred

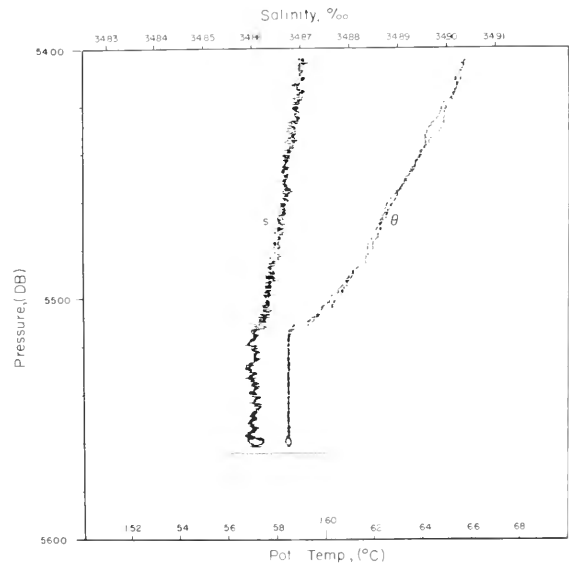

Figure 1. A salinity, potential temperature profile from the middle of Hatteras Abyssal Plain. Above the bottom mixed layer, the usual deep-ocean stratification is seen. The dashed line indicates the mixed layer was formed by mixing a continuous stratification. Traces obtained during both the lowering and raising of the profiler are shown. (From Armi and Millard, 1976.)

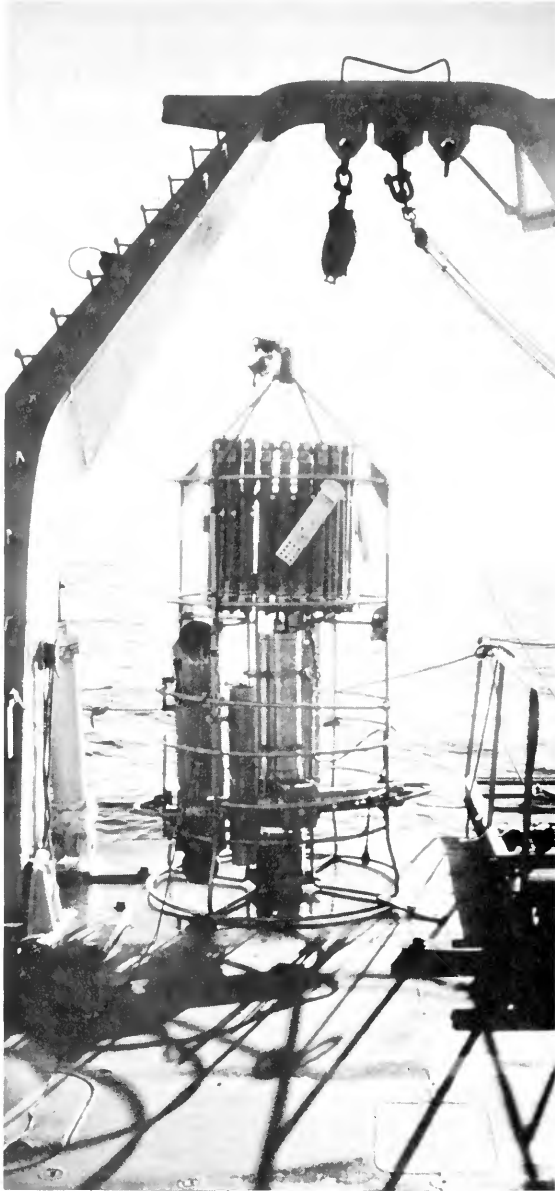

Figure 2. The instrument package used to obtain the continuous profile data. Included are a high resolution digitizer for Conductivity, Temperature, and pressure (Depth) sensors (called a CTD); a nephelometer to measure forward angle light-scattering from small particles (nephelo is the Greek word for cloud); a rosette sampler for collecting water used in calibrating the continuous measurements; an acoustic pinger for finding the height of the package above the bottom; and a transponder to acoustically locate the position of the package relative to mooring arrays.

with a grid or by a moving screen at the bottom. In the deep ocean, it is the water itself that is moving; at the bottom, a turbulent boundary layer forms and

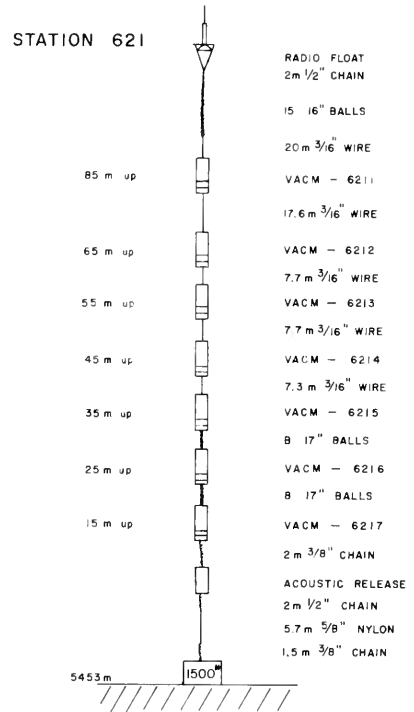

Figure 3. The Bottom Boundary Layer mooring placed at 28° 30' N, 70° 30' W on the Hatteras Abyssal Plain. VACM (Vector Averaging Current Meter) instruments average the current speed and direction as well as the temperature over 7 1/2-minute intervals. The mooring was in place for 3 1/2 months. It was recalled acoustically by commanding the release of the anchor line.

the resultant stirring mixes the continuous stratification.

In an effort to learn more about the details of the stirring and how the extent of the stirred or mixed region evolves, a combination current/temperature mooring was placed so that the mixed layer shown in Figure 1 was spanned by measuring sensors. The mooring is shown in Figure 3.

The outputs of all temperature and velocity sensors are shown in Figures 4a and b. Figure 4a shows what we might have expected from sensors imbedded in and above the mixed layer shown in Figure 1. The temperature signal of any instrument above the mixed layer is variable due to the internal wave movement of the continuous stratification shown in Figure 1. Within the layer, such variability is absent because the vertical oscillation produces a constant temperature output. The height of the mixed layer can be easily figured by counting the number of instruments that indicate the same, slowly varying temperature.

A different structure, however, is indicated in Figure 4b; sensors above the bottom sensor record a steady but different temperature than that of the

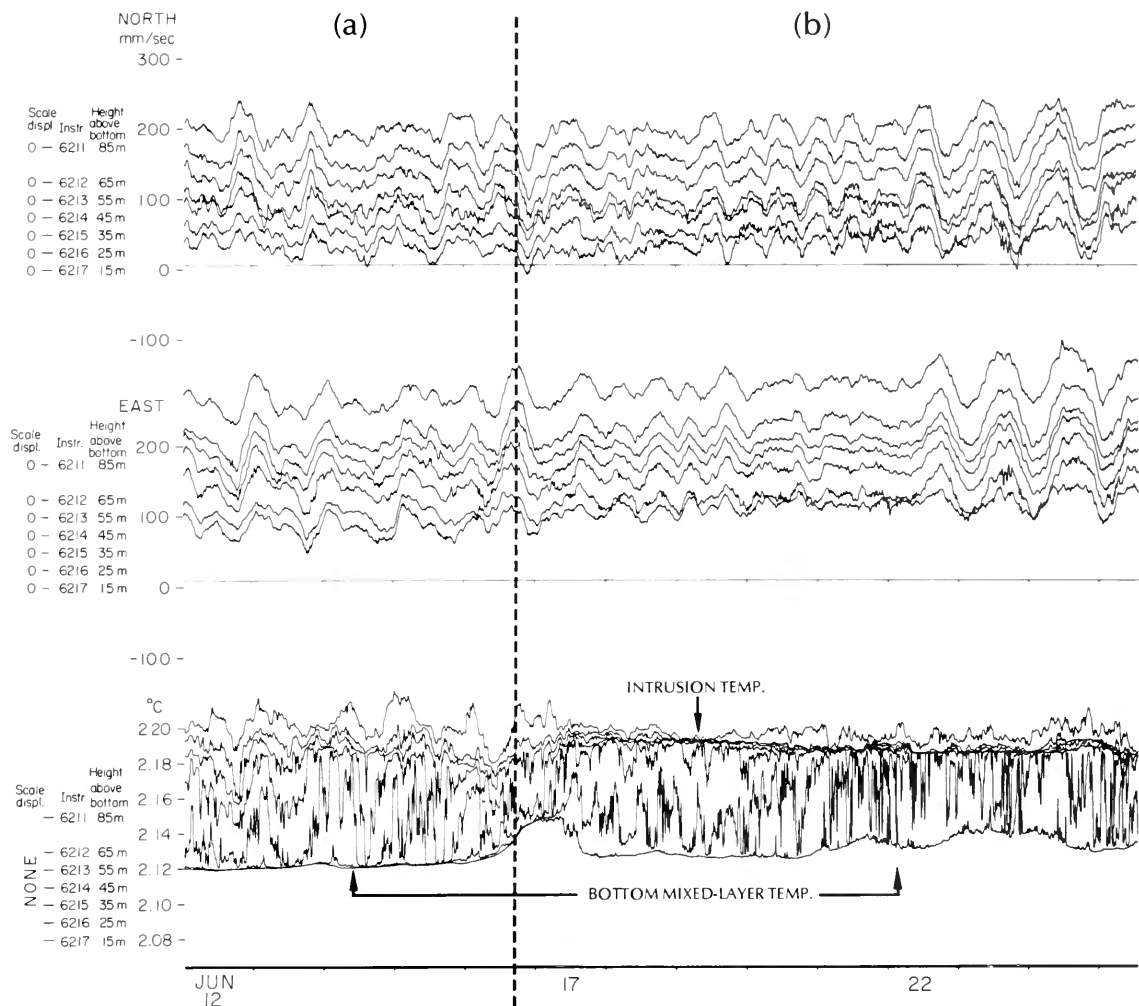

Figure 4a and 4b. Temperature and velocity data from the Bottom Boundary Layer mooring (Figure 3), indicating mixed-layer temperature and height variations vs. time and velocity. The temperature signal of any instrument above the mixed layer (see Figure 1) shows fine structure and internal wave variability; within the layer this variability is absent. Mixed-layer height is obtained by counting the number of instruments indicating the same temperature at any time. In 4b, temperature and velocity data show mixed-layer intrusion and differential motion between intrusion layer and bottom layer. Note the temperature of the intrusion layer is warmer and nearly constant, being independent of the bottom layer.

bottom mixed layer. During this period, there are actually two mixed layers, one above the other; the temperature of the upper one is nearly constant (2.19 degrees Celsius) and independent of that in the bottom layer. This upper layer is an intrusion and has a velocity different from the bottom layer. We will now explore the effect of intrusions on continuous stratification.

Layered Structure

The double-layer structure evident in the current-meter and temperature records of Figure 4b often can be seen in profiling records. In Figure 5, many layers are situated one on top of the other. This profile, taken over the Sohm Abyssal Plain off Newfoundland (see page 8) at the location shown in the inset map, differs from most of those taken over abyssal plains. It is the clarity of the multiple-step structure that is atypical (contrast this profile with that shown in Figure 1); it appears as

though an existing stratification has been mixed into many layers.

When this profile was taken, a mean current of 30 centimeters per second (about 30 kilometers per day) to the west had been recorded for several days at a nearby current meter. The profile was made about 100 kilometers downstream from the Corner Rise to the east; the layered structure had formed three days earlier as the continuous stratification of the deep-ocean water column moved by and was stirred at the Corner Rise. We see the advected signature of mixed layers like that shown in Figure 1, but now they are mixed layers formed at various depths on the Corner Rise.

The vertical extension of each layer is controlled by the stratification, and the limited energy available at the boundary for stirring the stratification. As the flow moves by the Corner Rise, these layers become detached and are carried laterally into the interior water column of the basin.

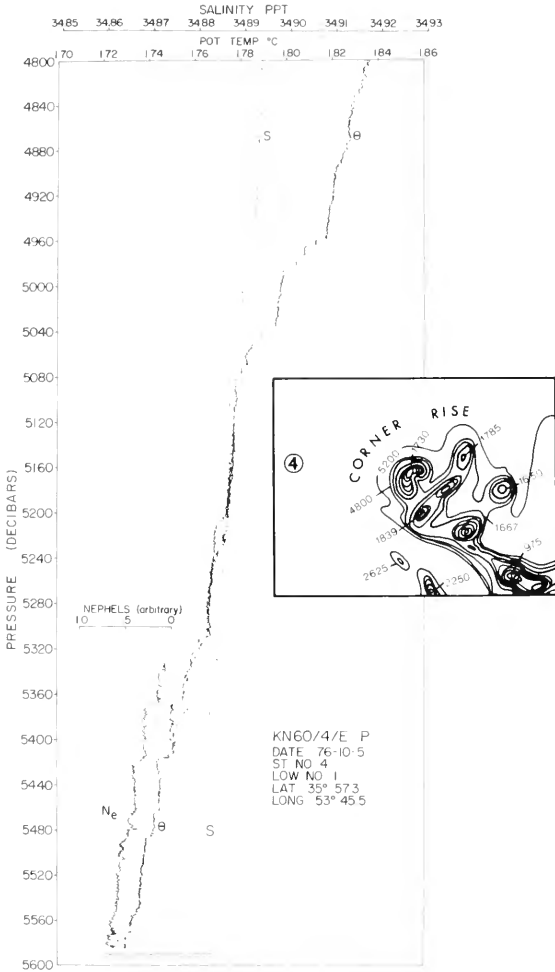

Figure 5. Profiles taken 100 kilometers downstream from the Corner Rise shown in inset. At the time of the profile, a steady current of 30 centimeters per second to the west had carried the many mixed layers, formed at their respective depths on the Corner Rise, into the interior water column of the basin. Both down and up traces of potential temperature, θ , light-scattering, and nephels are shown; the up traces are dotted and only shown below 5,200 decibars. Note the structure of the particulate matter profile is, in this case, identical to potential temperature and salinity.

They are still distinct at this location because they are only 3 to 4 days old. Later, many will "disappear" or collapse as they intermingle with other, similar layers.

We do not understand how these layers disappear, but we get a preliminary idea by comparing the up and down profiles shown in Figure 5. The character of the profile obtained as the package was raised is identical to that obtained while lowering: multiple layers are again found. The depth and number of layers, however, differed as

the profiler moved farther above the bottom. In the approximately 20 minutes between crossing 5,400 decibars on the way down and the subsequent crossing on the way up, advection by the current caused a separation of about half a kilometer. In this case, the mixed-layer structures have a limited horizontal extent. One possibility that would explain how continuous stratification is again formed in the interior of the water column is that layers of different origins and densities interleave as they decay and flatten. With enough interleaving, a nearly uniform stratification can form again.

The nephelometer (light-scattering) profile included in Figure 5 shows a structure identical to the profiles of salinity and potential temperature. The small, 1- to 2-micron particles, the concentration of which the nephelometer is most sensitive to, have a very slow settling rate of about 10 meters per year (see page 20). For the processes we are dealing with, they are essentially passive tracers, such as dye or smoke. It appears that the particulate matter was also mixed — forming the various nepheloid layers shown — from a background gradient of particulate matter, just as was the potential temperature and salinity.

Water Mass Anomalies

We have attempted to show the importance of the boundaries on mixing in the interior of ocean basins. Now, we will try to show that in the interior water column very little vertical mixing takes place. Primarily, stirring occurs horizontally — along constant density surfaces.

Some evidence for the absence of stirring in the interior water column can be found in the persistence of a concentrated 20-meter-thick layer over large distances. This layer is evident at 5,240 decibars in the profile shown in Figure 6. There is a midwater maximum in particulate matter and an anomalous temperature/salinity signal. Warm water is found beneath cold water, although the stratification is stable. This warmer, dirtier water is slightly saltier than the background water at this temperature. Although this profile was taken over the northern Hatteras Abyssal Plain, this layer also can be found some 3,000 kilometers away over the Sohm Abyssal Plain (see page 8). The layer is apparently patchy, sometimes clearly present, sometimes not. What is its origin?

In the Norwegian Sea, cold water forms, sinks, and flows down as a large undersea river through the Denmark Straits, under and around the Labrador Sea and past the tip of the Grand Banks off Newfoundland onto the Sohm Abyssal Plain (see pages 6-7). This water is always flowing down through water of lower density; it could not flow downhill if the interceding water was denser. On the Sohm Abyssal Plain, the Norwegian Sea water finally encounters water that has its same density. It then forms a layer at this density that can be found

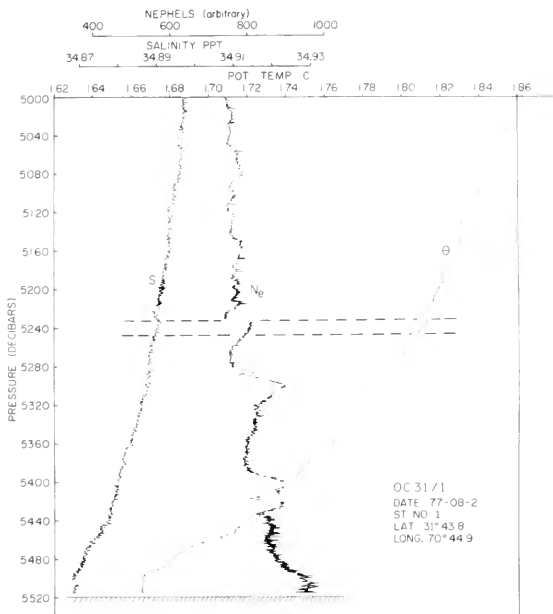

Figure 6. Profile taken over the northern Hatteras Abyssal Plain. The deep-ocean continuous stratification is marked with irregularities. At the bottom is a well-mixed bottom boundary layer. Above this, there are many intrusions or advected features marked by midwater maxima in light-scattering. Of particular importance is the midwater maximum at 5,240 decibars, marked with the dashed lines. This water is anomalous in temperature and salinity (warm water is found beneath cold water); this layer is found over large parts of the western North Atlantic.

throughout the basin. It is the persistence of this layer over large horizontal distances — sometimes more than 3,000 kilometers — that is striking. Its existence means little vertical exchange is occurring in the interior of the basin.

A Dynamic Duo

The sparsely distributed sampling of the past emphasized a nearly continuous stratification in the deep ocean. This continuous stratification was often consistent with simple conceptual mixing models, involving a one-dimensional or horizontally uniform balance between a slight upward movement of cold water and a downward diffusion, or mixing, of warmer water. The upward movement of about 1 to 4 centimeters per day, due to deep cold-water sources such as the Norwegian Sea and Antarctic bottom waters, was balanced by uniform mixing of warm, saltier water downward. These are the so-called “thermocline” models (for example, Veronis, 1969, and Munk, 1966).

We are presently learning that the mixing is essentially the result of two complementary processes, sort of a dynamic duo. The largest contribution to the vertical mixing occurs when 50- to 100-meter-thick layers are mixed by contact with

bottom topography. The layers are then moved, and mixed laterally by large eddies and the general circulation — the second process — until they contact another boundary where the first mixing process begins again. In the interior of the water column, some of the layers collapse, resulting in continuous stratification once again.

One is reminded of arguments offered many years ago by Columbus O’Donnell Iselin (1939) on the importance of lateral mixing for surface waters in forming the permanent thermocline. In the deep ocean, the importance of lateral mixing lies in the fact that mixed water produced by small-scale vertical turbulence generated at boundaries is transported horizontally away from these boundaries, eventually forming the continuous stratification found in the water column.

The implications of this conceptual framework are both practical and interdisciplinary. For example, if we understand how deep water moves and mixes, we will also understand how toxic wastes might disperse. The chemist, too, will be able to better understand the distribution and mixing of chemically reactive substances, and the decay of radioactive materials. Similarly, biologists are interested in mixing processes because of their bearing on the distribution of nutrients. And for marine geologists, it may mean that the distribution and resuspension of sediments — for example, in the nepheloid layer — is not caused locally by mixing processes but by processes that may have begun thousands of kilometers away.

Laurence Armi is an Assistant Scientist in the Physical Oceanography Department, Woods Hole Oceanographic Institution.

References

- Armi, L. Some evidence for boundary mixing in the deep ocean, *J. Geophys. Res.* In press.
- Armi, L., and R. C. Millard, Jr. 1976. The bottom boundary layer of the deep ocean. *J. Geophys. Res.* 81: 4983-90.
- Iselin, C. O’D. 1939. The influence of vertical and lateral turbulence on the characteristics of the waters at mid-depths, *Nat. Res. Council, Amer. Geophys. Un., Trans.*, 414-17.
- Munk, W. H. 1966. Abyssal recipes. *Deep-Sea Res.* 13: 707-30.
- Veronis, G. 1969. On theoretical models of the thermocline circulation. *Deep-Sea Res.*, Suppl. to Vol. 16, 301-23.

Particles and Particle Fluxes in the Ocean

by Derek W. Spencer, Susumu Honjo, and Peter G. Brewer

Particles in the ocean range in size from the smallest of colloids, less than a micrometer, to whales of many meters in length. Some particles are living, most are not, and they originate from several sources. Biological processes are a major source in the surface waters of the ocean, termed the "euphotic zone," which extends to a depth of 80 meters or more. There, the growth of phytoplankton, using energy from the sun, is limited principally by the rate at which nutrients are supplied by diffusion or advection from deep water. In some areas of the world, particularly off the western edges of continents, active upwelling of deep water supplies nutrients at high rates, sufficient to support enormous growth of microscopic algae. The existence of a permanent thermocline,* however, throughout most of the ocean, prevents a rapid influx of the nutrients from below, and consequently the rate of plant growth is much lower.

Phytoplankton occur in many shapes and sizes; some have no skeletons, some build hard skeletons, consisting of such minerals as calcium carbonate, silica, or strontium sulphate, but all act as primary sources of food for zooplankton, fish, and other organisms in the ocean. During its grazing for food, an individual zooplankton will ingest many thousands of the smaller phytoplankton and detrital particles. After extracting some organic material and nutrients, the zooplankton ejects the indigestible remains. Often these remains are in the form of intact particles, measuring up to a few hundred micrometers. The fate of most particles appearing in the surface of the ocean is probably to be eaten at least once, and some possibly several times. Figure 1 illustrates a typical fecal pellet produced by zooplankton.

*A thermocline is a layer of water with a more intensive vertical gradient in temperature than that found in the layers above or below it. There are permanent, seasonal, and diurnal (daily) thermoclines. The "permanent" thermocline is generally the deepest in the sea with its upper surface residing from 100 to 700 meters below the surface. The term "permanent" is used because its changes do not appear to be related to seasonal or shorter periods.

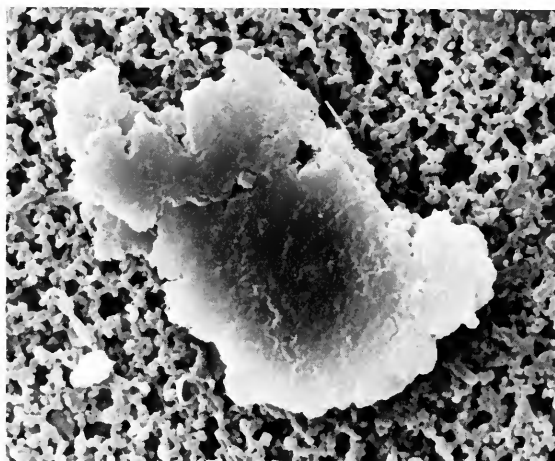

Colloidal clay particle collected from Sargasso Sea. The diameter is approximately 10 microns. Background is a filter. (Photo by Goreau)

Figure 2 is a highly magnified view of the surface of the pellet, showing the remains of a myriad of smaller phytoplankton and detritus.

The biological growth and grazing cycles of the biota in the surface ocean have an important impact on the distribution of the components of seawater. Growing plants actively incorporate many chemicals into their structures, the most common being phosphate and nitrate ions, which are required nutrients. Trace metals also are needed for plant growth, and many other trace constituents are taken up passively by organisms. Dead organic particles are known to be able to adsorb trace constituents onto their surface. Both active and passive uptake mechanisms transfer chemical elements from a "dissolved" to a "particulate" state. The force of gravity then becomes a significant direct factor in their distribution.

Zooplankton grazing and bacterial decay are responsible for recycling most of the organic particulate matter produced in the surface ocean before it sinks to greater depths. Some elements that form integral parts of the organic matter, such as phosphorus, also are recycled in the upper layers of the ocean. However, those elements that are

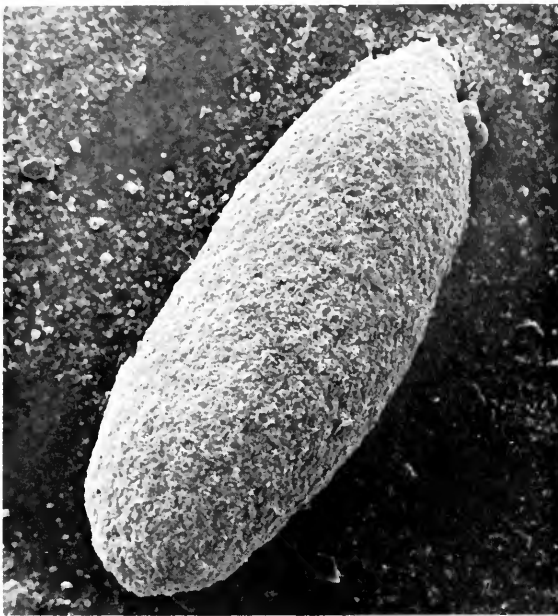

Figure 1. Fecal pellet produced by zooplankton. The pellet is 200 microns long.



Figure 2. View of the surface of fecal pellet in Figure 1, showing the remains of a myriad of smaller phytoplankton and detritus.

incorporated into indigestible material, such as the calcium carbonate and siliceous skeletons, sink into deep water, and then are recycled at much slower rates. In the deep ocean, their fate depends, to some extent, on the rate the particles settle through the water column, which is a function of particle size and density.

In addition to the particles of biological origin, the ocean contains many inorganic particles that have been transported from the continents. At one time, it was believed that rivers were the major agents involved in this process. It is presently realized that the world's rivers currently have little input to the interior of the deep ocean. Their effects are largely confined to estuarine and continental shelf regions. Most detrital terrestrial material that is input to the surface of the interior oceans results from transport of dust by winds in the troposphere. The arid desert regions of the continents are one source of this dust.

The GEOSECS Project

On an ocean-wide scale, knowledge of the distribution and composition of particles suspended in the ocean has been obtained only recently. The GEOSECS (Geochemical Ocean Section Study) project has enabled us to collect and analyze small particles (forming most of the standing crop of particles in seawater) from large areas of the major ocean basins. Figure 3 shows the concentrations of particulate material (collected by filtering about 10 liters of seawater through 0.5-micron pore size filters) from 75 degrees North in the Greenland Sea down the Western Atlantic deep basins to 55 degrees South in the Scotia Sea. In this section, it can be seen that high concentrations of particles, in general, are restricted to the

near-surface and the near-bottom regions in high-latitude areas. The surface concentrations are the result of biological growth that is greatly increased in the high-latitude areas. The high concentration of near-bottom particles that form the nepheloid layer* results from resuspension of the bottom sediments by active current regimes (see pages 5 and 27). This layer is more extensive than indicated on this section, which runs down the central regions of the deep-ocean basins. Pierre Biscaye and Stephen Eitrem have shown that, at mid-latitudes, the western boundary regions of both the North and South Atlantic have extensive bottom nepheloid layers.

In addition to the total mass of particles, we now have information on the specific composition of elements as determined by neutron activation analysis.** Figure 4 shows the distribution (along the same Atlantic Ocean western basin section as Figure 3) of two elements — aluminum and calcium. Their distribution reflects different origins and processes in the ocean. Aluminum particles are principally input into the ocean as detrital clay

*A region of increased suspended material forming a cloudy (nepheloid) layer above the seabed.

**When an analytical sample is exposed to a flux of neutrons in a nuclear reactor, the individual atomic species may undergo nuclear reactions with the neutrons, giving rise to one or several reaction products, which may be radioactive. These radioactive reaction products, each specific for a particular type of parent isotope in the analytical sample, differ in their radioactive properties, such as half-life, type of radiation emitted, and energy of the radiation. It is thus possible to identify each radioactive neutron activation product by its radioactive properties, and thus in turn identify the parent element present in the analytical sample.

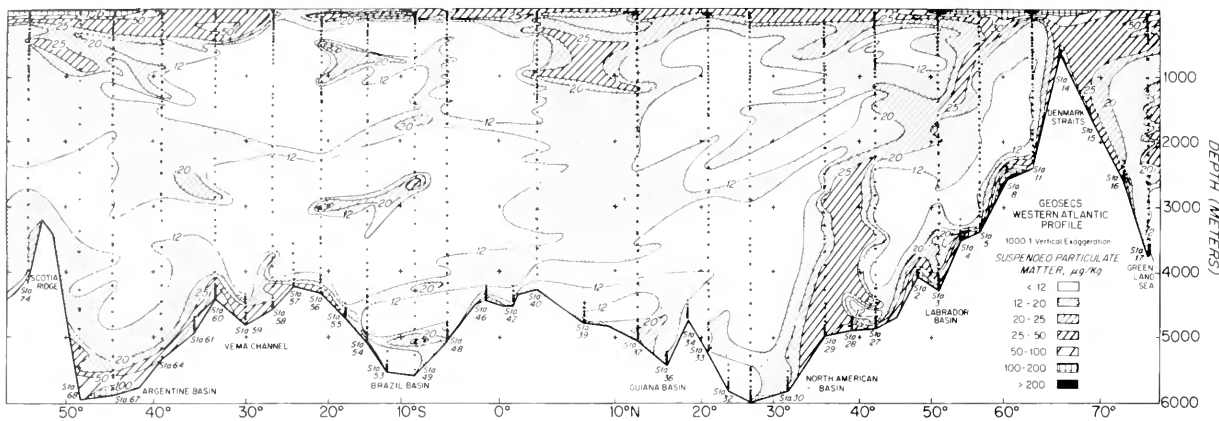

Figure 3. Profile of suspended particulate matter in the Western Atlantic, showing concentrations from 75 degrees North in the Greenland Sea to 55 degrees South in the Scotia Sea. Note the high concentrations of particles in the near-surface and near-bottom regions in high-latitude areas. The surface concentrations stem from the rapid biological growth in high-latitude areas, whereas the near-bottom concentrations forming the nepheloid layer result from the resuspension of bottom sediments by strong current regimes.

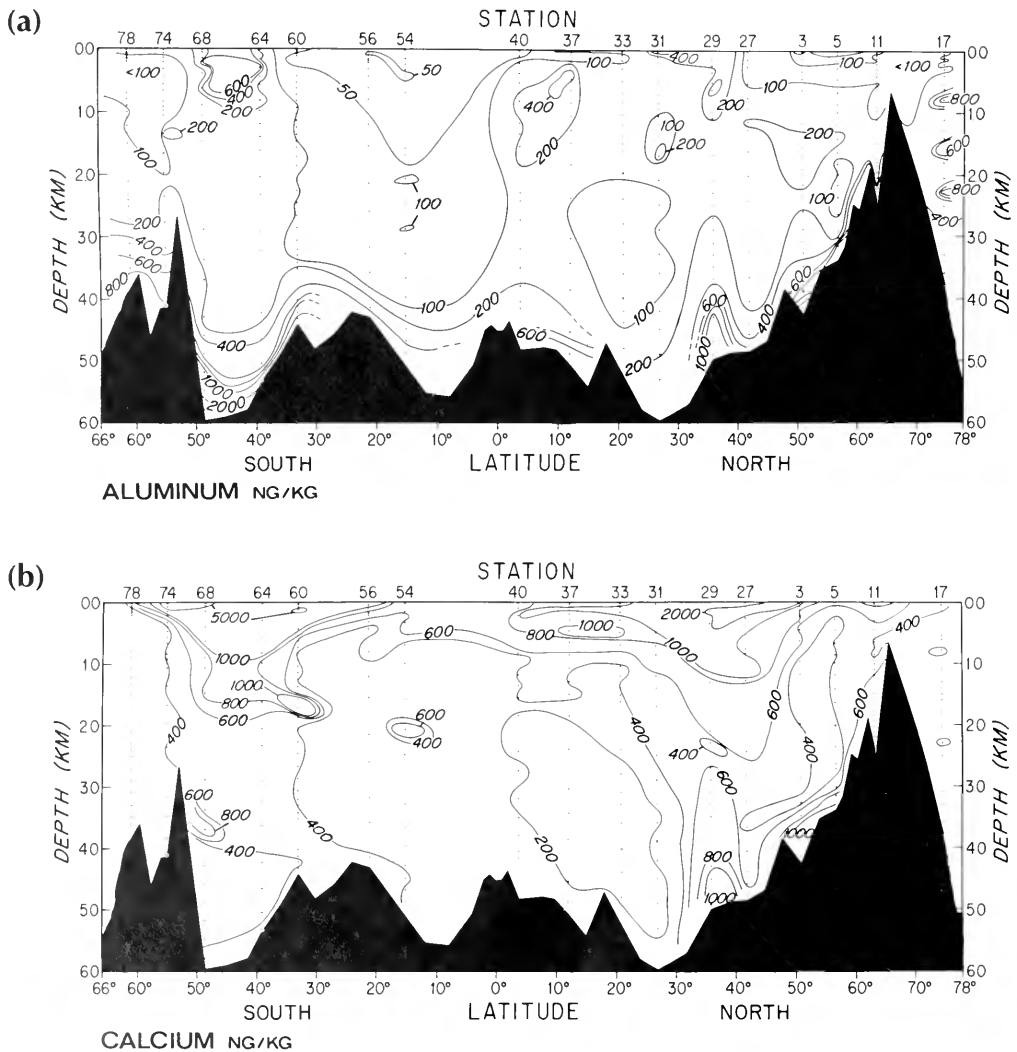

Figure 4. Distribution of aluminum and calcium particles in the Western Atlantic (the same section as Figure 3). The distribution of these elements reflects different origins and processes in the ocean. For example, the aluminum concentrations at the surface reflect the input of terrestrial dusts from the atmosphere. In contrast, calcium particles are produced in surface waters by the growth of such organisms as coccolithophorids.

minerals that do not form or dissolve, to any great extent, in seawater. At the surface, the high aluminum concentrations reflect the input of terrestrial dusts, whereas, in the near-bottom regions, the resuspension of clay minerals results in the increased concentrations seen in high-latitude regions. In contrast, calcium particles as CaCO_3 are produced in the surface waters of the ocean by the growth of organisms, such as coccolithophorids. Calcium carbonate producing organisms most commonly occur in mid- and low-latitude regions of the ocean; this is clearly seen in the section where most of the particulate calcium in the surface ocean occurs at latitudes of under 40 degrees.

In the near-bottom water, an increase in particulate calcium can be seen in the North but not in the South Atlantic. This is due to the fact that deep water in the South Atlantic dissolves calcium carbonate, but in the North Atlantic, the deep water is saturated with calcium carbonate (calcite), and these particles are resuspended along with the clay.

A feature of both the aluminum and calcium sections is that surface concentrations of the particulate elements in several areas of the ocean are much higher than the concentrations seen in intermediate waters. If the data that we have collected are reasonably representative of a steady-state situation, then such a decrease in concentration with depth must be due to either dissolution of the particles as they sink, or to an acceleration of the settling rate. We know that seawater at shallow depths in the Atlantic Ocean does not dissolve either clay minerals or calcium carbonate. Thus the decreased concentrations of these particles in intermediate waters are probably due to processes that accelerate their settling rates.

The data in Figures 3 and 4 describe the distribution of the mass of fine particles suspended in the ocean. James K. G. Bishop, formerly a student in the Woods Hole Oceanographic Institution/Massachusetts Institute of Technology Graduate Program, filtered particles from large volumes of seawater (greater than 1,000 liters), concluding that, while the fine particles (less than 53 millimicrons) account for most of the mass concentration, it is the larger, rarer particles that account for most of the mass flux toward the ocean floor. This result is predictable from Stokes' Law, which shows that the settling velocity of a particle increases with the square of the particle size — $S = \frac{2}{9} \cdot \frac{g}{\eta} \cdot (\rho_s - \rho) r^2$ where S is the settling velocity, g the gravitational constant, η the viscosity of seawater, ρ_s the density of the particle, ρ the density of seawater, and r the radius of the particle.

Particle Fluxes

Knowledge of the fluxes of particulate materials through the ocean has a significant impact on our

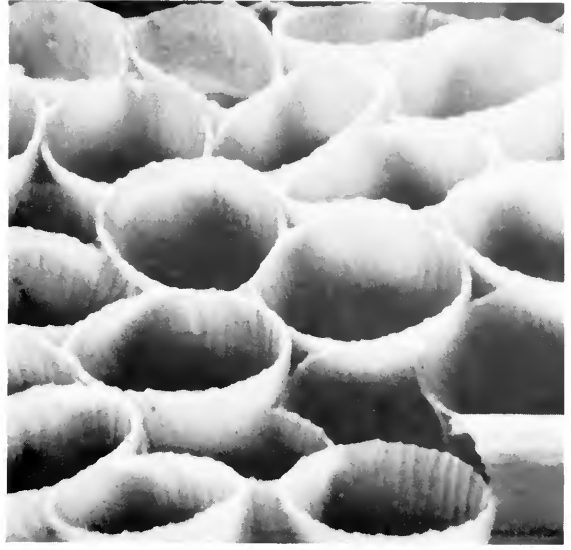

Scanning Electron Micrograph of coccoliths (Syracosphaera, sp.). The diameter of one coccolith is approximately 4 microns. (Photo by Honjo)

understanding of many areas of oceanography. The composition, structure, and rate of accumulation of marine sediments are dependent upon these fluxes. Moreover, benthic biological communities are ultimately dependent upon the supply of food energy in the form of organic particle fluxes.

The formation of particles in the surface waters of the ocean, their settling and dissolution at depth (on the sea floor, or in the water column) is a major mechanism affecting the composition of seawater. Many pollutants introduced into the ocean quickly become associated with particles. Our ability to predict the consequences of the input of such materials depends upon the extent to which we understand particle formation, transport, and dissolution processes.

At one time, it was believed that the principal particle fluxes (from the surface to the deep ocean) consisted of a rain of fine biogenous debris and detritus. This material — a few micrometers in diameter — was envisioned as slowly settling (while undergoing oxidation and dissolution) until it reached tranquil abyssal depths, where it gently deposited on the sea floor. Such small particles settle at a rate of only a few hundred meters per year and would take 10 to 50 years to travel from the ocean surface to the abyssal sediments. In this time, a current of only 1 centimeter per second would laterally transport particles a distance of 3,000 to 15,000 kilometers. It seemed unlikely that patterns in the composition of the deep-ocean sediments would reflect the variations of particle distributions in the surface waters of the ocean. Evidence that all was not well with this "slow settling" hypothesis began to emerge from the work of R. Rex and

Edward Goldberg of Scripps Institution of Oceanography in 1958, and others in the 1960s. Distinctly identifiable constituents in deep-sea sediments, such as wind-blown quartz and dolomite, are found almost directly underneath the area of their introduction to the sea surface. Other anomalies were apparent; for example, data published by Victor Noshkin and Vaughan T. Bowen of the Woods Hole Oceanographic Institution showed that significant traces of plutonium exist in the tops of sediment cores taken in the Atlantic Ocean, where the depth is greater than 5,000 meters. The plutonium was not introduced into this ocean until the nuclear weapons testing programs of the 1960s, when fallout from the atmosphere resulted in its input into the surface waters. The plutonium in the deep-sea sediments, reported by Noshkin and Bowen, was not only present at the surface, but also was found in cores as deep as 15 centimeters. Bioturbation — the mixing of bottom sediments by burrowing organisms — could have accounted for its burial, but the process takes time (see page 34); it was clear that the plutonium arrived at the ocean bottom a short time after its introduction into surface waters. Studies by Susumu Honjo have shown that the diversity (the relative amounts of different species) of coccoliths present in surface waters of the Pacific Ocean closely match those in the bottom sediments, but that samples from the deep-water column have a much different diversity.

These results can be explained only if we invoke a mechanism in the surface waters of the ocean that aggregates fine particles into large particles, then transports them rapidly (at least partly intact) to the sea floor. The work of T. Smayda of the University of Rhode Island, C. L. Osterberg of the International Laboratory of Marine Radioactivity, Monaco, and others has suggested that the fecal pellets of zooplankton might be the settling mechanisms. Bishop and his colleagues have recently made estimates of the relative mass fluxes involved in small and large particles. On the assumption that Stokes' Law applies, these authors estimate that 99 percent of the vertical mass flux through a depth horizon of 400 meters in the equatorial Atlantic Ocean is carried by large (greater than 53 millimicrons) fecal matter and fecal pellets, which contribute only 4 percent of the total suspended mass concentration. They also estimate that about 90 percent of the particulate organic matter produced by the growth of plants in surface waters is utilized and recycled in the upper 400 meters, but that the distributions of biogenous silica and calcium carbonate particles are controlled by fragmentation and aggregation. Small carbonate and opal particles are progressively enriched in the large particles with increasing depth to 400 meters. The transit time for the fecal material through a 4-kilometer-deep water column is estimated at

about 10 to 15 days. In such a short time, the resulting sediment distributions could reflect the variability of the surface water of the ocean on a scale of less than 100 kilometers.

Recently, direct measurements of the chemical fluxes in large particles have been obtained by both the authors, and W. Gardner, a student in the Woods Hole Oceanographic Institution/Massachusetts Institute of Technology Graduate Program. Utilizing sediment traps moored in the ocean for various time periods, we have attempted to catch the rapidly settling large particles (Figure 5). Although the amount of information is still meager, and despite the fact that we are uncertain of the efficiency of the sediment traps in intercepting the flux of particles in different size ranges, several important conclusions have been drawn.

In a sediment trap located about 700 miles east of Bermuda at a depth of 5,367 meters (214 meters off the sea floor) we measured a total flux of 1.68 milligrams per square centimeter per year, which compares with sedimentation rates in this area of about 1 to 5 milligrams per square centimeter per year. Analyses of the sample show that it consists of about 50 percent clay, 20 percent calcium carbonate, 20 percent silica, and 5 percent organic matter. The larger particles were the remains of various calcareous organisms, fecal matter, and fecal pellets (Figure 1). Two distinct kinds of fecal pellets were recognizable. One, which appeared green when observed under the microscope, contained about 50 percent calcium carbonate, 30 percent organic matter, and 20 percent clay. The other, which appeared red, consisted of about 80 percent clay, with only 5 to 10 percent of calcium carbonate and organic matter. We, together with S. Krishnaswami and Y. Nozaki of Yale University, analyzed the trap sample for 21 elements and nine radioisotopes in the uranium-thorium decay series. We interpret these data to suggest that, of the total flux, only 5 percent of the clay, most of the calcium carbonate, and 90 percent of the organic matter were contributed by rapidly settling large particles recently derived from the surface waters of the ocean.

This flux includes the green fecal pellets and carbonate materials, such as tests of foraminifera and pteropods, which, although caught at a depth where the water is undersaturated with calcite and aragonite, show little evidence of dissolution. The larger part of the total flux appears to be from resuspended bottom sediments that are aggregated and sedimented from the nepheloid layer, probably by a population of benthic-pelagic organisms that produce the red fecal pellets.

The radioisotope data indicate that most of the measured flux of the short-lived nuclides (half-lives of less than 22 years) is derived from the upper part of the water column in particles that

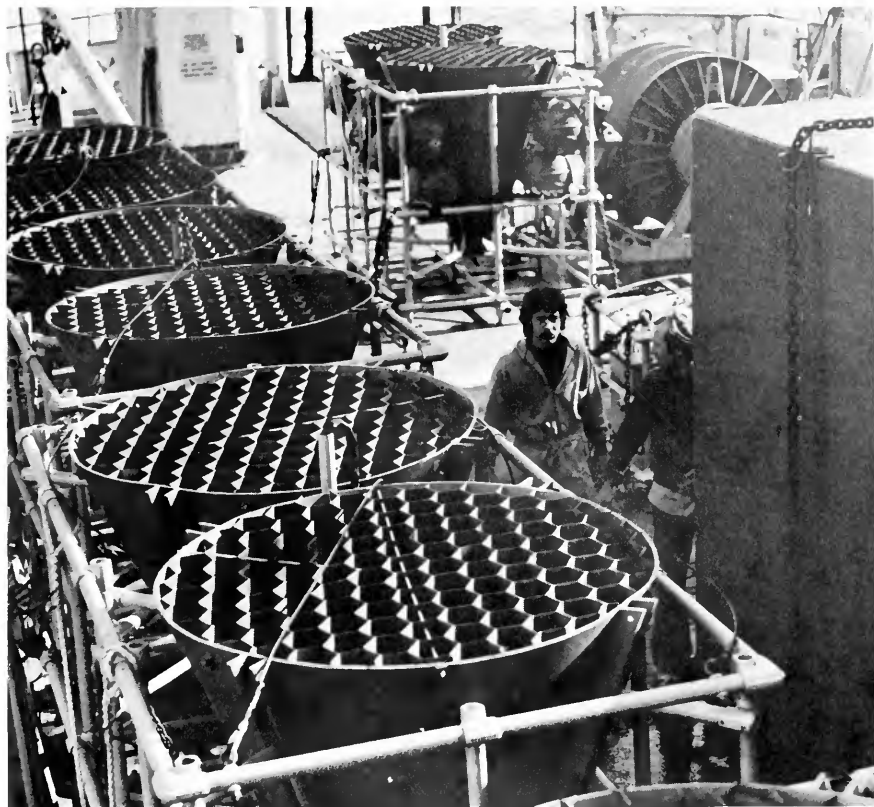

Figure 5. Sediment traps, such as these just recovered aboard the Woods Hole Oceanographic's research vessel Knorr, are moored at great depths above the seabed to intercept the flux of particles from the surface.

settle at a rate of about 10,000 to 50,000 meters per year. Particles settling at this rate would only require from 40 to 200 days to travel the 5,367 meters from the surface to the trap.

The Work Ahead

It is obvious that the sea floor can no longer be considered remote from the surface. These two regions are coupled by a large particle flux, which operates at a rate so that the deep ocean floor may respond to changes that take place in the surface waters of the ocean on time scales of weeks to months.

Materials introduced into the surface ocean, if they can be taken up by growing plants or adsorbed onto particles, can ride the "fecal express" to the sea floor in a few days. The zooplankton grazing cycles, together with bacterial reactions, form a major filter for the chemical fluxes to the deep ocean. Organic matter and its contained elements are rapidly remineralized in the near surface, but sufficient organic carbon escapes (by means of the accelerated large particle fluxes) to provide food for the benthos. Indigestible materials, such as terrigenous dusts, and carbonate and silica particles, are fragmented and aggregated by the same zooplankton grazing. The aggregates settle rapidly to the sea floor while the fine fragments of carbonate and silica that escape the aggregation process (being eaten) sink slowly, undoubtedly dissolving long before reaching the bottom. Determination of the geographical and depth variations in the large and small particle

fluxes is an important part of the work to be accomplished in the next several years by marine biologists, chemists, and geologists.

Derek W. Spencer is a Senior Scientist and Chairman of the Chemistry Department, Woods Hole Oceanographic Institution. Susumu Honjo is an Associate Scientist in the Department of Geology and Geophysics. Peter G. Brewer is an Associate Scientist in the Chemistry Department.

References

- Bishop, J.K.B., J.M. Edmond, D.R. Ketten, M.P. Bacon, and W.B. Silker. 1977. The chemistry, biology, and vertical flux of particulate matter from the upper 400 meters of the equatorial Atlantic Ocean. *Deep-Sea Res.* 24: 511-48.
- Brewer, P.G., D.W. Spencer, P.E. Biscaye, A. Hanley, P.L. Sachs, C.L. Smith, S. Kadar, and J. Fredericks. 1976. The distribution of particulate matter in the Atlantic Ocean. *Earth Planet. Sci. Lett.* 32: 393-402.
- Lal, D. 1977. The oceanic microcosm of particles. *Science* 198: 997-1009.

Animal Sponges and Flowers of the Deep Sea

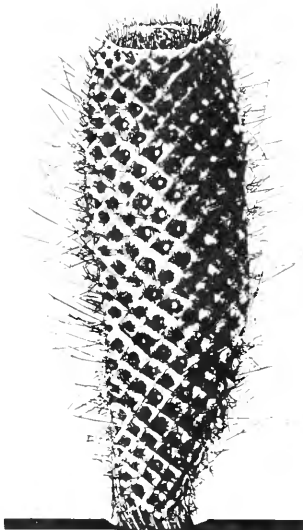

Venus flower basket sponge
(*Euplectella suberea*).

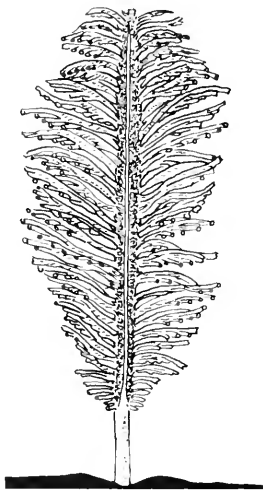

The feather. *Pennatula aculeata*,
a common sea pen.



Stalked crinoid.

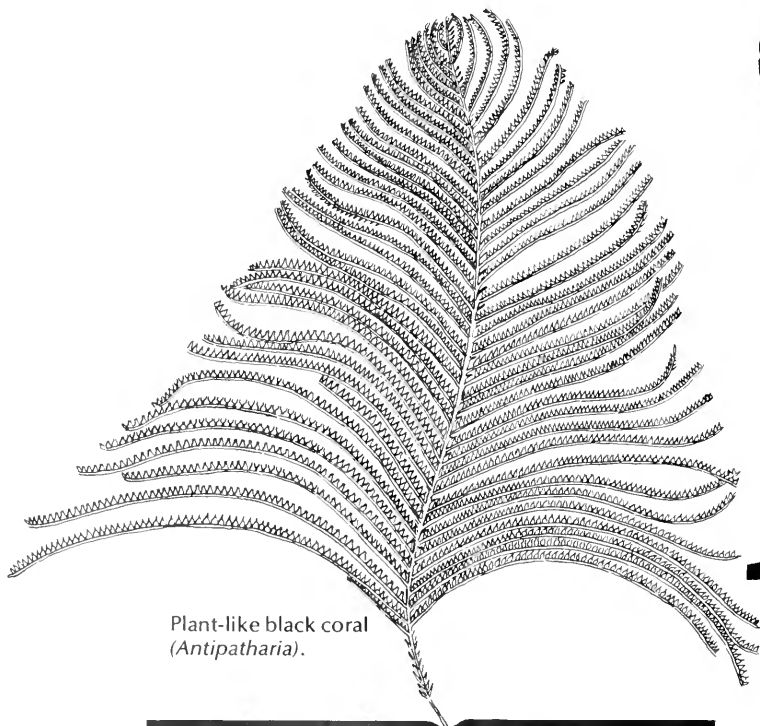

Plant-like black coral
(*Antipatharia*).

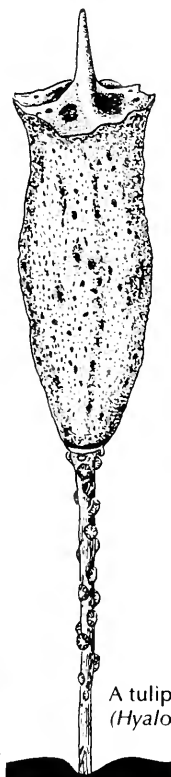

A tulip-shaped deep-sea sponge
(*Hyalonema thomsoni*).

Representative selection
by Charles D. Hollister.

Drawings by Hester Haring.
(Not to scale.)



by I. Nicholas McCave

As we enter the era of ocean mining and the possible disposal of radioactive wastes in the deep sea, it is essential that we know more about bottom processes, especially those "clouds" that hover just above the ocean floor. These clouds are suspensions of relatively high concentrations of sediment (50 to 100 micrograms per liter). Although

Turbid antarctic water flowing over lineated bottom at 4,080 meters along Mid-Oceanic Ridge. (Photo courtesy National Science Foundation)

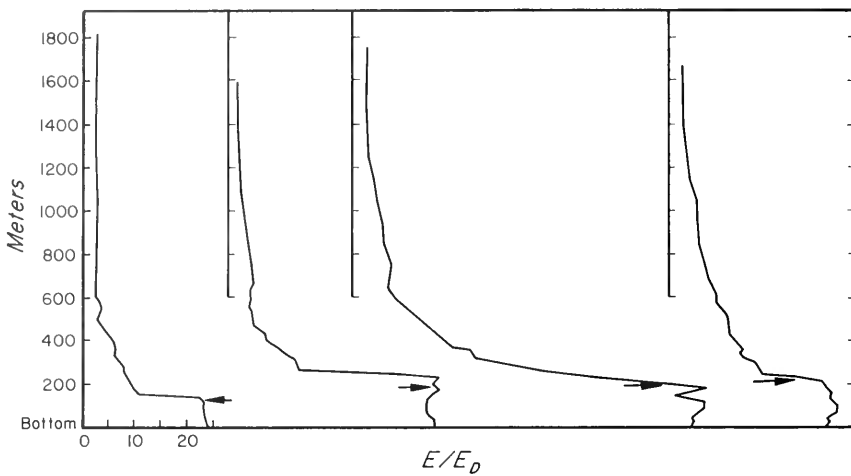

Figure 1. Four light-scattering curves, showing the nepheloid layer on the Blake-Bahama Outer Ridge. Note the correlation with the thickness of a bottom isothermal layer whose top is marked by the arrows. (After Biscaye and Eitrem)

only about two-millionths of that of dissolved salts in the sea, these concentrations serve as important indicators of the bottom regime because they are actual participants in it. They are considered relatively high concentrations because, in the waters two to three kilometers above the seabed, less than 10 micrograms per liter is the rule. Monitoring the behavior of the suspension (changes in load and composition) yields important information about the rate of sediment deposition (proportional to the concentration near the bed) and erosion events (which increase the load in suspension).

Clearly the seabed and the suspensions above it are partners in erosion/deposition events. The boundary layer is the region both within the bed and within the lower part of the water column whose properties are influenced by proximity to the interface, which is the seabed surface. The fluid part of this abyssal boundary layer may be characterized by specific temperatures and chemical properties, but, as we are concerned here with sediments, we first need to know about the detection and measurement of these turbid "nepheloid layers."

Detection of Nepheloid Layers

The region of increased suspended material near the seabed — the nepheloid (cloudy) layer — was first detected optically through light-scattering measurements taken by K. Kalle in 1938 and N. G. Jerlov in the late 1940s. Because light-scattering meters or nephelometers are very difficult to calibrate in absolute terms of radiant intensity and irradiance, generally simple instrumental parameters are used. One such device developed at the Lamont-Doherty Geological Observatory of Columbia University in New York has a light source, baffle, and camera with continuous slow film transport. The film receives scattered light and a band of the direct beam (attenuated in intensity by one-thousandth). The film is developed and its density is determined. The ratio of the exposure due to scattered (E) and direct light (E_D) is formed (E/E_D) and plotted as a function of depth (Figure 1). The majority of light-scattering profiles in the sea have been obtained by using this device, though we

are beginning to gather data from laser nephelometers.

There is both a theoretical and empirical justification for these light-scattering measurements being related to suspended sediment content. Figure 2 shows that although there is scatter, there is a good relationship

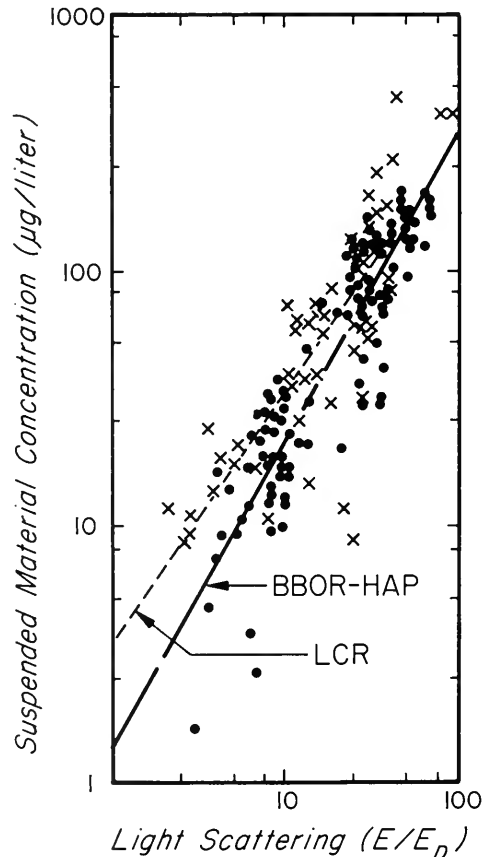

Figure 2. Correlation between light-scattering and suspended material concentration. Note the two different correlations, one for the Lower Continental Rise (LCR, crosses) and the other for the Blake-Bahama Outer Ridge and Hatteras Abyssal Plain (BBOR-HAP, dots). (After Biscaye and Eitrem, 1977)

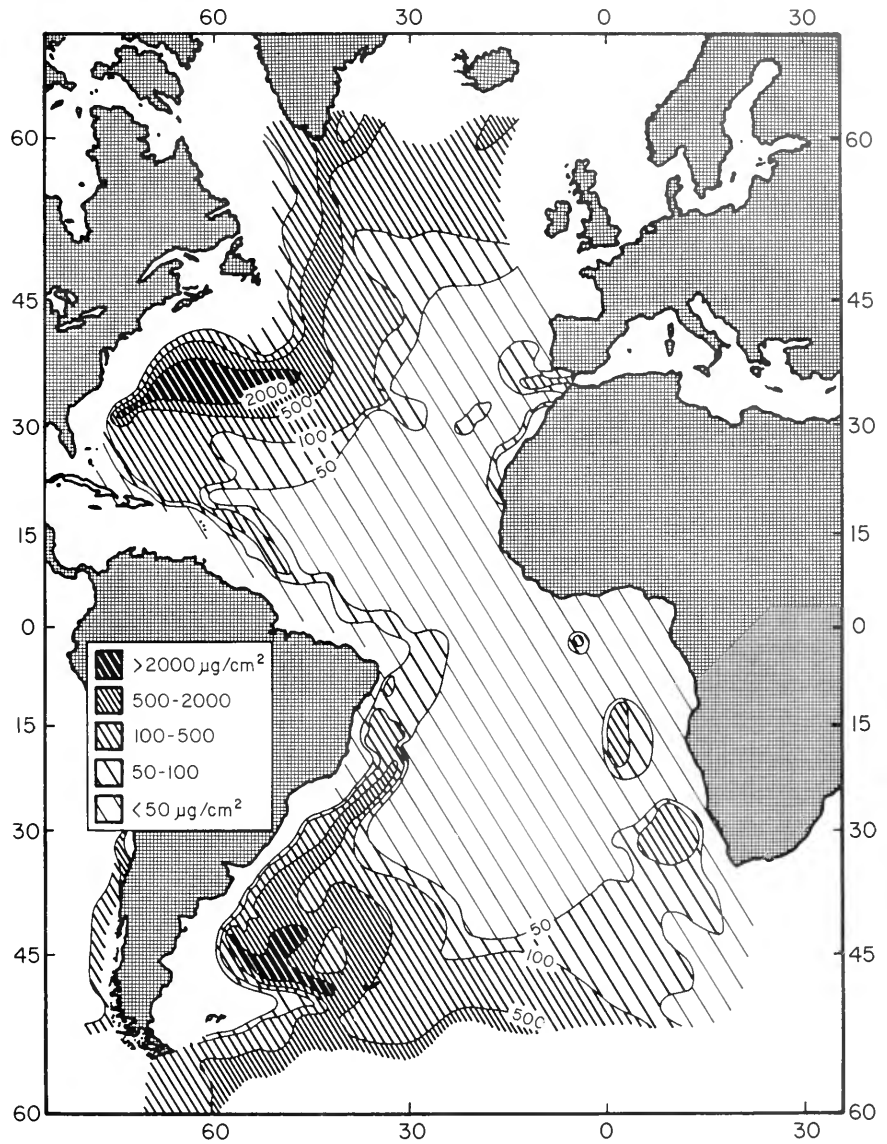

Figure 3. Distribution of suspended material in the nepheloid layer in the Atlantic. Material settling from above into the layer has been subtracted. (After Biscaye and Eitrem, 1977)

between concentration measured gravimetrically and the exposure parameter from the photographic nephelometer. Unfortunately, there is not a single line, and samples from various areas of the oceans with suspensions of different composition or size distribution will yield different, though equally well-correlated, lines. Presently, reliable gravimetric data are obtained by filtering about 10 liters of water through Nuclepore filters with a pore size of 0.4 microns. However, in the clearest part of the water column above the nepheloid layer, where concentrations are less than 5 micrograms per liter, the weighing errors of plus or minus 25 micrograms mean a large percentage error. Nevertheless, the combination of optical and gravimetric techniques uncovers the existence of nepheloid layers in various parts of the ocean.

Location of Nephels

So we know that nepheloid layers exist and are due to the presence of light-scattering particles

(nephels), but where, geographically, are they concentrated? An immediate response might be: in the currents flowing near the bed on the western boundary of the oceans. Mapping of suspended material content of nepheloid layers could be done on the basis of concentration, but a map of the distribution of sediment load in mass per unit area of sea floor would be more instructive. Such a map is shown for the Atlantic in Figure 3. Clearly most of the sediment in the nepheloid layer can be found in a strip along the western side of the ocean. It is interesting to compare this with the map showing a model of the deep-water circulation of the oceans proposed by Henry Stommel of the Woods Hole Oceanographic Institution some years ago (Figure 4). The picture is one of strong western boundary bottom currents with weaker flows elsewhere. Fair correspondence is also seen in the Indian Ocean (Figure 5).

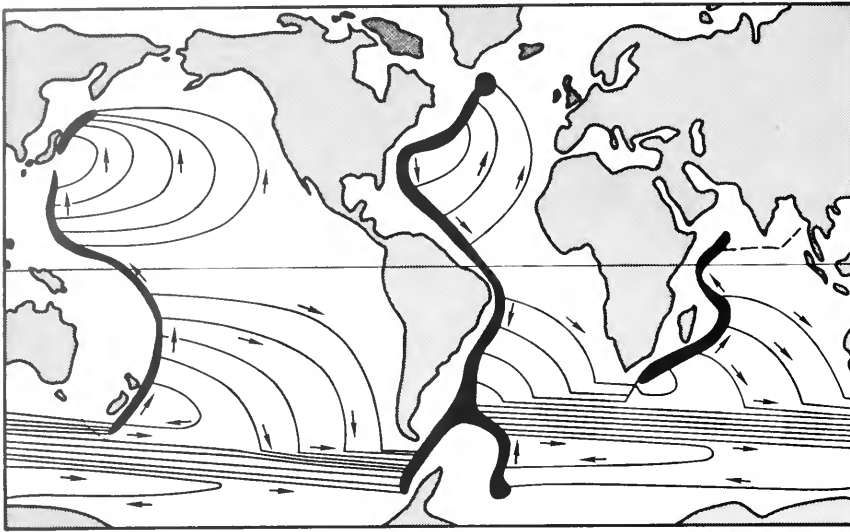

Figure 4. A model of the deep-water circulation of the world ocean. Heavy black lines mark the major western boundary bottom currents. (After H. Stommel, 1958)

How Did It Get There?

Most of the material in nepheloid layers has come from land. Some scientists have suggested that the layers are presently fed from land by the fine tail of turbidity currents. It is true that layers are found in submarine canyons and probably are slowly moving down these canyons to abyssal plains beyond (Figure 6). However, the abyssal plains off the major supply points for the United States — Cascadia abyssal plain and the Gulf of Mexico off the Columbia and Mississippi Rivers — do not have well-developed and heavily loaded nepheloid layers. The same is true of abyssal areas off the Indus, Ganges, Congo, Niger, and Amazon Rivers. There is one major supply point in the world, the Antarctic continent, which appears to feed material into the nepheloid layer in the southwestern Atlantic.

However, there are *increases* in sediment load in places along the transport paths on the western side of the Atlantic. This suggests some input to the layer, and as most of the increases are not below zones of high organic primary productivity, one suspects that they are due to erosion of the seabed by bottom currents. This raises the interesting possibility that changes in suspended sediment load in the abyssal boundary principally reflect erosion and deposition of sediment — particularly that increases indicate erosion.

What Are the Conditions for Erosion?

Detailed studies on cohesive sediments from estuaries have shown that erosion is controlled by the strength of the sediment aggregates forming the bed. For erosion to occur, these have to be stripped off the bottom. It is a very difficult matter to measure these strengths in the laboratory, and an impossibility in the field. In fact, much work on estuarine muds uses the generalized curve of C. Migniot, relating the drag force applied by the flowing water to the yield strength, a soil-mechanics property of the bed (Figure 7). Migniot's

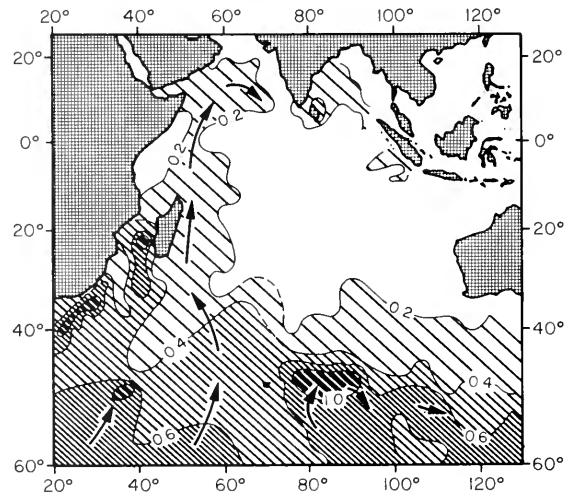

Figure 5. Distribution of excess turbidity ($\log E/E_0$ where E_0 is the exposure value at the clearest water in the water column) in the Indian Ocean bottom water. (After Kolla, et al., 1976)

measurements were not made with undisturbed bed material, so in his graph a relationship between the undisturbed strength of the surface layer and the flow drag is not shown. In fact for deep-sea sediments, the only data available relate to the water content of the sediment, a less satisfactory parameter because it is not uniquely correlated with sediment erodibility (Figure 8). The data do suggest that there is considerable variation in erodibility according to the composition of the sediment and that some erosion may occur under drag forces (τ_b) as low as 0.25 dyne per square centimeter. For flow over a flat smooth bottom, forces of that magnitude are exerted by currents whose speed measured at 1 meter above the bed is about 12 centimeters per second. It seems that we can bracket the erosion condition between friction velocity values [$u_* (= \sqrt{\tau_b/\rho})$] of .5 and 1.5 centimeters per second, corresponding to flow speeds of 12 to 40

Figure 6. Profiles of light-scattering along the axis of Astoria Canyon. The dashed line marks the top of the bottom nepheloid layer. (After Plank, et al., 1974)

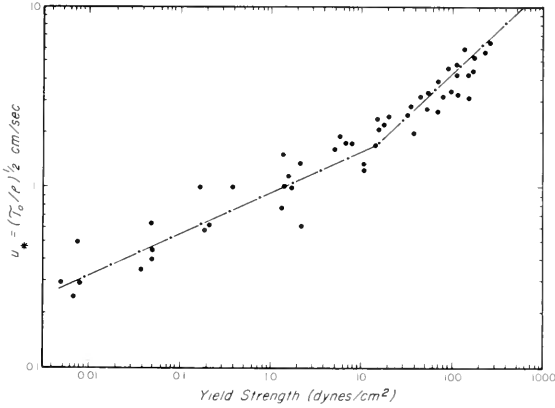
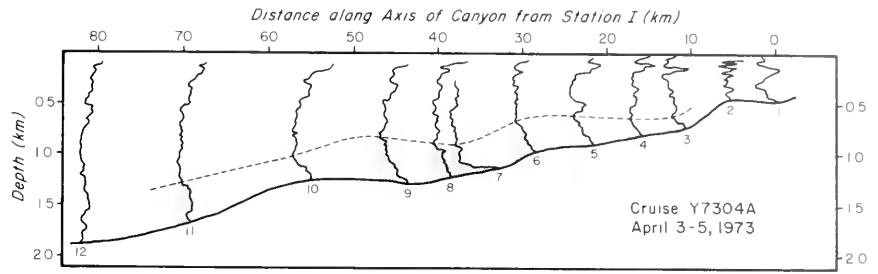

Figure 7. Correlation between the yield strength of cohesive sediments and the drag force applied by the fluid to the bed (τ_0) at which movement of the bed begins. (The drag is expressed as a speed obtained by dividing it by the density of the water and taking the square root of the quotient.) (After Migniot, 1968)

centimeters per second, the precise value depending on the roughness of the bed.

There are not many areas where the nepheloid layer sediment load increases in the direction of current flow. Therefore, over the areas of decrease, stresses only rarely exceed the critical erosion value. Second, we do not know the erosion rate constant for deep-sea sediments. This relates

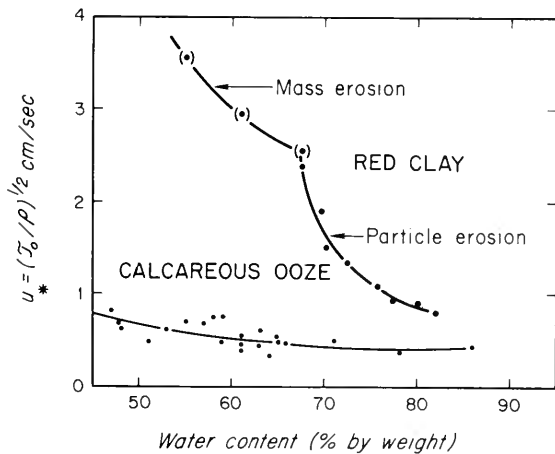

Figure 8. Critical erosion conditions for two deep-sea materials, red clay and calcareous ooze, in a remoulded state. The y axis is the drag expressed as in Figure 7. (Calculated from data of J. Southard of the Massachusetts Institute of Technology.)

the rate of erosion to applied shear stress over the critical value. For estuarine muds it is in the range of 0.01 to 0.2 grams per square centimeter per second per dyne per square centimeter. Clearly at the lowest rate, with the shear stress only fractionally over critical, it would not take long to strip off an amount equal to the highest nephel load of 0.003 grams per square centimeter in Figure 3. So even in those areas where there is erosion, it is not likely to occur very often or over a large area at any one time. Of course, if we knew what the critical erosion conditions and erosion rate constants in situ actually were, these speculations would gain more authority. Still, we are left with the interesting conclusion that some aspects of seabed morphology may reflect an erosional process that occurs for a minute or two in every year.

What About Deposition?

Surely, more erosion might occur, since some of the material is quickly deposited and does not contribute to the nephel load for long. This depends on the rate of deposition (R_d), which in still water is given by the concentration of a suspended sediment (C_b) multiplied by its settling speed (W_s). In a current, material will only be deposited when the drag on the bottom exerted by the current (τ_0) is below a certain limiting value (τ_1). As the bottom drag increases (current speed increases) so the rate of deposition decreases until, when τ_0 equals τ_1 , there is no longer any deposition [$R_d = C_b W_s (1 - \tau_0 / \tau_1)$, for the mathematically minded] (Figure 9). Now, if we insert reasonable values of the parameters, $C_b = 100$ micrograms per liter, $W_s = 10^{-3}$ centimeters per second, $\tau_1 = 0.25$ dynes per square centimeter and say $\tau_0 = 0.1$ dynes per square centimeter, then the rate of deposition is 6×10^{-11} grams per square centimeter per second, or about 2 milligrams per square centimeter per year.

Another way of looking at it is to consider the half-life of the suspension, which is the time it would take for the particle concentration in the nepheloid layer to decrease by half, assuming continuous deposition with no erosional events. This half-life is also controlled by the settling speed of the particles and, of course, becomes longer as the rate of deposition becomes slower with increased flow speed and drag on the bed. Also, the thickness of the layer (D) is important; the thicker the layer, the longer its half-life [$T_{1/2} = 0.693 / (1 - \tau_0 / \tau_1) (W_s / D)$]. Using the same values as before and 200 meters as the thickness, the half-life is about nine months.

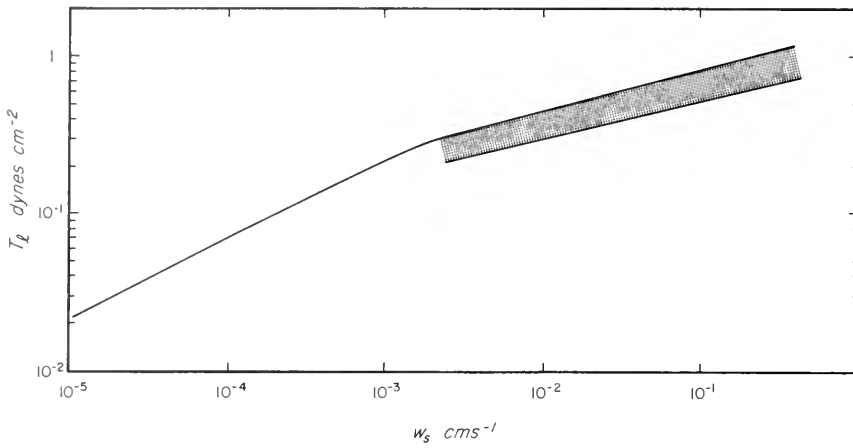

Figure 9. The limiting shear stress for deposition of suspended material (estimated theoretically). Despite the line given, there is great uncertainty about this parameter. (After McCave and Swift, 1976)

This shows us that although material may be eroded quickly, deposition involving the entire nepheloid layer is a slow process. However, bottom photographs have shown the existence of sediment clouds scudding along the bottom at concentrations certainly greater than those cited for the abyssal region as a whole. If these contain about 10 milligrams per litre of material with $W_s = 10^{-2}$ centimeters per second, then with $\tau_o = 0.1$ and $\tau_l = 0.5$ dynes per square centimeter, the rate of deposition is about 7 milligrams per square centimeter per day. This is still not very fast, but if erosion takes place over a small area, and if the material is deposited over a larger area, it may only take a few days to deposit much of the coarser part of the material resulting from a few minutes of erosion. Under these conditions, the nepheloid layer as a whole would not have a great increase in concentration. Again it must be noted that we do not know what values of W_s and τ_l actually are at the bottom of the sea; they have not been measured.

On a large scale, erosion and deposition are responsible for large furrows and mud waves that also shed light on what is happening in the abyss (see page 5).

The Impact of the Layer

There is not a great deal of lateral sediment transport in the deep sea. The areas in which it is most pronounced are on the western sides of ocean basins, often along continental margins. Therefore, the lateral transport that does occur moves the products of continental erosion, which have moved down the continental slope to the deep sea. At the present time, not much sediment escapes the continents, but this was not always the case. During low sea levels at glacial maxima in the ice ages, sediments were taken right to the edge of the continental shelf by rivers and then shed directly into the deep sea. If we had lived 18,000 years ago, we would have found more heavily loaded nepheloid layers and greater transport rates.

Nevertheless, in this layer some very long-distance transport occurs, as exemplified by the Antarctic diatoms found in bottom sediments off northern Brazil (Figure 10). Particular species of diatoms, for example *Nitzschia kerguelensis* and

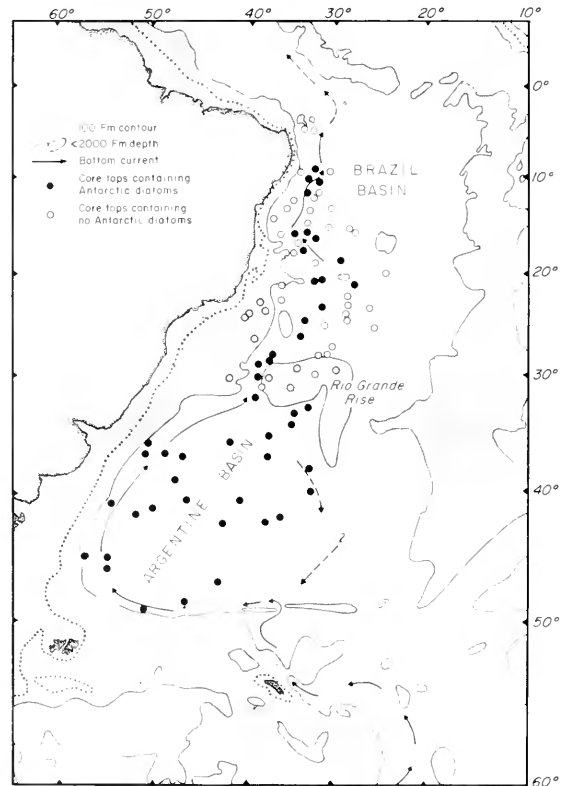

Figure 10. Distribution of Antarctic diatoms in Brazil and Argentine basins. Solid dots indicate core tops containing diatoms, whereas blank dots indicate cores containing no diatoms. Arrows designate the direction of flow of Antarctic bottom water. (After David A. Johnson, Michael Ledbetter, and Lloyd H. Burckle, *Marine Geology*, Vol. 23, 1977)

Coscinodiscus lentiginosus, are produced in Antarctic waters and are entrained in Antarctic bottom water in its region of formation. They have been found in the equatorial Pacific, in the western Indian Ocean, and even in the North Atlantic off Cape Hatteras, testifying to the long-distance transport of sediments in bottom nepheloid layers. However, it is important to realize that the majority



Common "pillbox" diatom, about 50 microns in diameter, found in wide areas of the ocean.

of the area of the oceans is not characterized by the intense transport found in western boundary currents.

The distribution of material is partly controlled by turbulent diffusion of material away from the boundary. Figure 1 shows how the thickness of the basal maximum zone of the nepheloid layer corresponds strikingly to the thermally well-mixed bottom layer. Thus the distribution of suspended material is an indicator of physical processes in the layer. If we knew the settling velocity distribution of the material, we would also be able to give estimates of the diffusivity for the sediment and compare them with those obtained from profiles of dissolved radon, which is diffused upward in the water column after escaping from the seabed, where it is produced by radioactive decay of radium 226. Better knowledge of critical erosion and deposition stresses would allow us to use the nepheloid layers, their thickness and variability, as indicators of physical processes occurring at the seabed.

Finally, a word on the amount of material moved in nepheloid layers — the horizontal flux of sediment. It is not very much. P. E. Biscaye and S. L. Eittrheim calculate annual northward fluxes on the west side of the Mid-Atlantic Ridge to be 8.1×10^6 metric tons through 24 degrees South and 1.3×10^6 tons through 8 degrees South, leaving about 7 million tons per year deposited in the Brazil Basin. To put these numbers into perspective, the annual load of the Mississippi River is about 300 million tons, and the rivers of the world transport 18 billion tons annually. These figures are likely to be matched by transport in the world abyssal boundary

layer only if the transport from Antarctica and in the circum-Antarctic current system are included. But this, like many features of the oceanography and marine geology of the Southern Ocean, is poorly known. Elsewhere, our crude estimates of fluxes suggest erosion and deposition rates on the order of 1 milligram per square centimeter per year. Not very much for all that "muddy" water.

I. Nicholas McCave is a Reader in the School of Environmental Sciences of the University of East Anglia, Norwich, England, and a Visiting Investigator in Geology and Geophysics, Woods Hole Oceanographic Institution.

References

- Biscaye, P.E., and S.L. Eittrheim. 1977. Suspended particulate loads and transports in the nepheloid layer of the abyssal Atlantic Ocean. *Mar. Geol.* 23: 155-72.
- Kolla, V., L. Sullivan, S.S. Streeter, and M. Langseth. 1976. Spreading of Antarctic bottom water and its effects on the floor of the Indian Ocean inferred from bottom-water potential temperature, turbidity, and sea-floor photography. *Mar. Geol.* 21: 171-89.
- McCave, I.N., and S.A. Swift. 1976. A physical model for the rate of deposition of fine-grained sediments in the deep sea. *Geol. Soc. Am. Bull.* 87: 541-46.
- Migniot, C. 1968. Etude des propriétés physiques de différents sédiments très fins et de leur comportement sous des actions hydrodynamiques. *La Houille Blanche* 23: 591-620.
- Plank, W.S., J.R.V. Zaneveld, and H. Pak. 1974. Temporal variability of suspended material in Astoria Canyon. *J. Geophys. Res.* 79: 4536-41.
- Stommel, H. 1958. The abyssal circulation. *Deep-Sea Res.* 5: 80-82.

BIOTURBATION IN DEEP-SEA DEPOSITS:

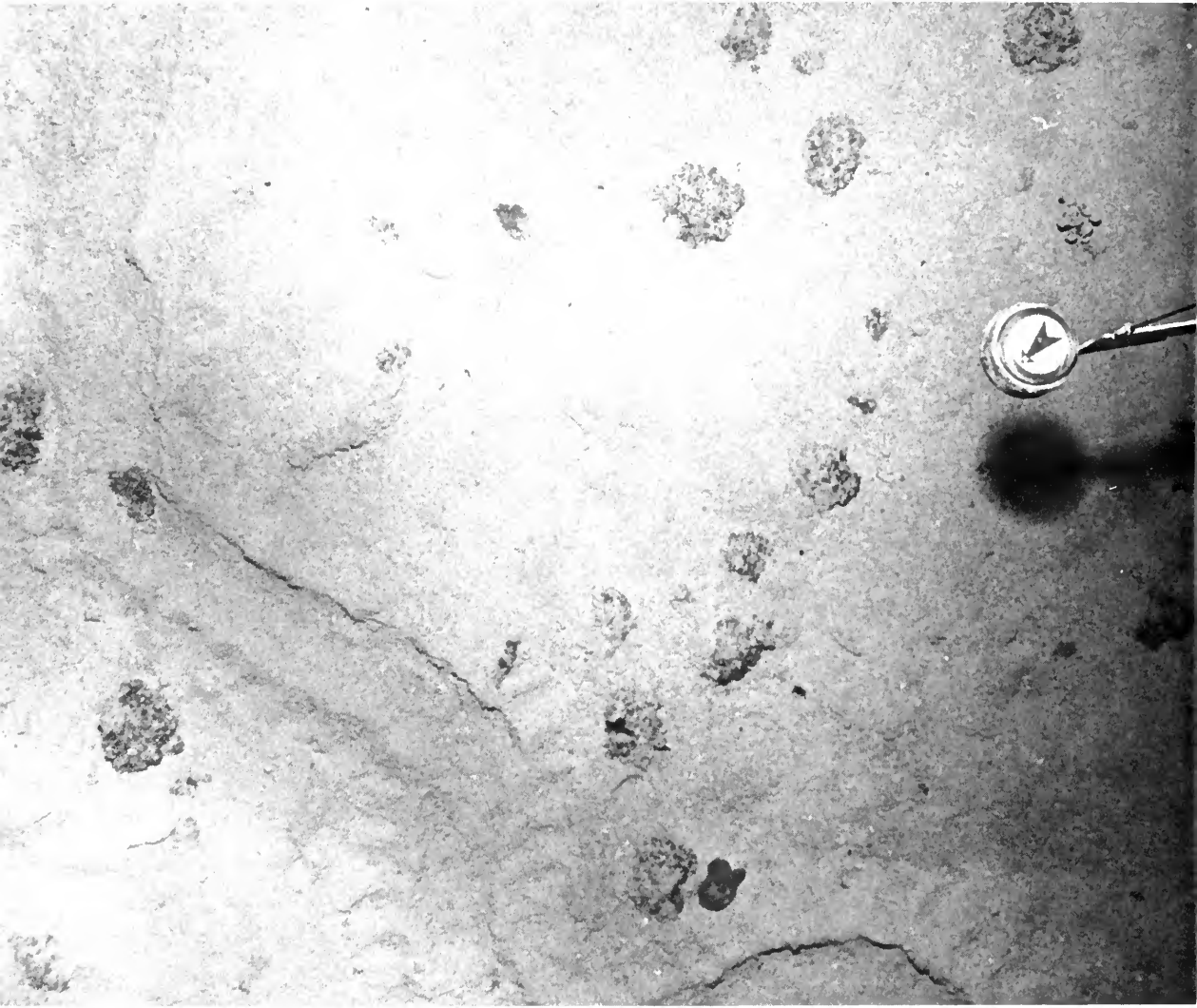

Rates and Consequences

by Karl K. Turekian, J. Kirk Cochran,
and David J. DeMaster

Figure 1. A track made by an organism crawling on the deep ocean floor. This photograph was taken in the ferromanganese nodule field southeast of Hawaii at a depth of about 5,000 meters. The irregular black objects are manganese nodules averaging about 8 centimeters in diameter. A box core obtained from this area is one of those used for bioturbation rate studies (Table 2). (Photo courtesy NOAA)

The ocean bottom is the resting place of materials passing through the water column. But it is not the *final* resting place. We know that the sediments on the ocean floor are younger than 200 million years, and, given the age of the earth as 4.6 billion years, we infer that the older material must have been obliterated in some way. Indeed one of the consequences of the plate tectonic model (see *Oceanus*, Winter 1974) for the history of the outer sphere of the earth's crust is the continual obliteration of the deposits on the ocean floor.

The ocean floor is far from quiescent, and the deposits laid down there, while awaiting their final demise, are subject to various shorter time scale perturbations. These are of two general types. The

first is the physical disruption of the sediments, resulting in loss from one area and deposition in another. This can occur either by the continuous winnowing of bottom currents or by episodic transport, such as slumps or turbidity currents.

The second type of disruption of the sediment pile is caused by the burrowing activity of organisms living in and on the deep-sea floor. The diversity and abundance of life in the great, dark, cold depths of the deep ocean have been amply demonstrated through photographs (Figure 1), dredge and sled hauls, cores, and visual observations from submersibles.

The mixing of the sediments by organisms is called *bioturbation*. It takes place in soil profiles on land (thanks to earthworms and other burrowing creatures), and it also occurs in the sediments of aqueous reservoirs in which the bottom water is not markedly depleted of oxygen. Lakes, estuaries, and the deep ocean generally fulfill this condition. No bioturbation occurs where the waters in contact with the sediment are virtually devoid of oxygen. Under this condition, a continuous undisturbed sedimentary record is preserved, provided that no physical disruption has occurred. These sediments, commonly varved, are found in anoxic marine and freshwater basins like the Black Sea, the Carriaco Trench, Lake Tanganyika, parts of the Gulf of California, and in certain upwelling regions of the eastern parts of the ocean basins.

Bioturbation is effected by different kinds of organisms: clams, worms, crustacea, echinoderms, and coelenterates. Most of the bioturbation that occurs near the sediment/water interface is done by deposit feeders, who rework the sediment as they ingest its edible organic matter. Other organisms, such as many of the crustacea, burrow into the sediment for safety while still others, such as the anemone, anchor themselves in the sediment as they feed on suspended material in the water column.

All of these processes have been described in detail by oceanographers and marine biologists. They give rise to questions that can only be answered when we have some way of determining the time scale of events on the sea floor. These are: (1) What are the rates of bioturbation in the various parts of the deep ocean, and how do they compare with estuarine rates? (2) What is the primary control on these rates? (3) How deep do organisms burrow into the sediment pile, and how does this influence geochronometric and paleoecological studies of deep-sea cores?

One way of determining the time scale of bioturbation is to follow the distribution of a foreign, easily identified material that has been added to the sediment-water interface. Two examples of this approach exist. One of these tracers is man-made, and the other was produced by a cosmic event.

Plutonium and Microtektites as Tracers

Plutonium from atmospheric fallout of nuclear bomb debris has been introduced into the ocean floor since 1962. At the Woods Hole Oceanographic Institution, Vaughan T. Bowen, Victor Noshkin (now at Lawrence-Livermore Laboratory) and Hugh Livingston have shown that this long-lived refractory radionuclide has been worked into the sediments by organisms to depths of about 10 centimeters over the last 15 years.

About 700,000 years ago another type of marker was placed on the deep-sea floor around Australia as the result of a cosmic encounter. This tracer is related to *tektites*. These are aerodynamically-shaped glassy objects, which are probably formed when a meteorite or comet impacts on the Earth. If the impact is of sufficient force to drive molten crustal debris high above the stratosphere, these droplets will freeze as glass beads that acquire their secondary shapes on descending through the atmosphere. They range in size from a button to a baseball. A large tektite-strewn field resulting from such an event 700,000 years ago has been found in Australia and Southeast Asia. This event is also recorded in the deep-sea sediments of that region as small (0.1 to 1.0 millimeter) glass spheres — called *microtektites* (Figure 2). William P. Glass of the University of



Figure 2. Microtektites. These tiny drops of sculptured glass fell into the Indian Ocean 700,000 years ago. These range from 0.2 to 0.8 millimeters. (From *The Face of the Deep*, Bruce C. Heezen and Charles D. Hollister. Copyright © 1971 by Oxford University Press, Inc. Reprinted by permission.)

Delaware discovered that this microtektite layer had been spread through the accumulating sediment pile, giving evidence of bioturbation.

Norman Guinasso and David Schink of Texas A&M University have recently modeled the observed distributions of both plutonium and microtektites in deep-sea deposits and have obtained quantitative estimates of the rates of bioturbation.

Uranium Decay Series Nuclides as Tracers

However, one is not always able to find such useful historical marker horizons in sediments. In addition, some markers may not be narrowly defined in time. Plutonium delivery to the ocean floor, for example, is not truly episodic, being subject to variabilities in production by atmospheric testing over time, and dependent both on the delivery pattern from the stratosphere and the rate of transport through the water column. Thus, although these methods have proved to be extremely useful in understanding the rates of bioturbation, there is a need for a universal tracer not subject to these problems.

Such tracers are provided by the shorter-lived members of the uranium decay series (Table 1), and in particular thorium-234 (24-day half-life) for estuarine sediments, and lead-210 (22-year half-life) for the more slowly depositing deep-sea sediments. The use of either of these nuclides depends on a continuous production rate and a continuous rapid removal to the sediment/water interface. Thorium-234 is produced directly by the radioactive decay of uranium-238, which is homogeneously distributed in the oceans at a remarkably high concentration of 3.3

micrograms per liter. In estuarine waters with high particle densities, thorium-234 is removed from the water column by adsorption and sedimentation so that the mean life in such systems is commonly between one and ten days. This continuous production and rapid removal of thorium-234 makes it an ideal tracer in estuarine bioturbation studies.

Lead-210 is of use primarily in studies of sediment mixing in the deep ocean, and has two origins. One source is the atmosphere, where it is produced by the radioactive decay of gaseous radon-222 (which reaches the atmosphere through emanation from soils). Lead-210 has a very short residence time in the atmosphere and Karl K. Turekian, Yoshiyuki Nozaki, and Larry K. Benninger of Yale have been able to model the expected delivery rate of lead-210 from the atmosphere to the ocean surface. Its residence time in ocean surface waters is about 1 year (varying with location). It is removed by particles to the deep water and probably directly to the ocean bottom. This source of lead-210 can supply half or even more of the excess lead-210 delivered to deep-sea sediments. In addition, settling particles scavenge lead-210 produced from the decay of radon-226 and thus can provide another important flux of this nuclide to the ocean bottom. This was demonstrated by Harmon Craig, S. Krishnaswami, and B. L. K. Somayajulu of Scripps Institution of Oceanography (the latter two also from the Physical Research Laboratory, Ahmedabad, India), and has since been confirmed by others. Thus the deep-ocean bottom is supplied continuously with excess lead-210 of both atmospheric and oceanic origin.

Table 1: Natural radionuclides useful in determining rates of bioturbation in marine deposits.

Radionuclide	Mode of production	Half-life	How transported to sediments	Where useful
Thorium-234	Radioactive decay of uranium-238 dissolved in sea water.	24 days	Adsorption on suspended and resettling particles and biogenic debris.	Estuarine deposits
Lead-210	Radioactive decay of radium-226 (via radon) dissolved in seawater; atmospheric flux from radon-222 decay and precipitation.	22 years	Adsorption on settling particles derived primarily from the ocean surface.	Deep-sea deposits of all kinds
Silicon-32	Cosmic ray produced in atmosphere and subsequently precipitated.	300 years	Incorporated in siliceous tests (e.g. diatoms and radiolaria).	Deep-sea siliceous deposits

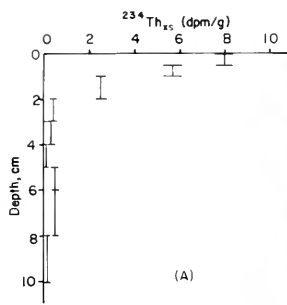
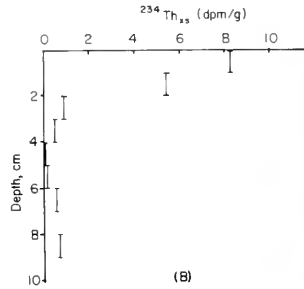

Figure 3. X-rays of cores raised from estuarine floors, showing bioturbation activity and its effect on the distribution of thorium-234. From the exponential decrease rate of this nuclide with depth the rate of bioturbation can be calculated. (A) is a core from Long Island Sound and (B) is a core from the New York Bight.



Longer-lived refractory radionuclides can be used, but their distributions with depth in a sediment pile are sensitive to both the sediment accumulation rate and the bioturbation rate. In estuarine sediments that accumulate at a rate of about 0.3 centimeters per year, the thorium-234 distribution is overwhelmingly due to bioturbation because of its very short half-life. Similarly, in deep-sea sediments accumulating at a rate of approximately 0.3 to 3.0 centimeters per thousand years, the longer-lived lead-210 distribution predominantly records the effects of bioturbation. Note, however, that the half-life of lead-210 is sufficiently long so that in a fast-accumulating sediment pile, as found in estuaries, its distribution is determined by both sediment accumulation and bioturbation. Hence, it is difficult to derive the rate of either one of these processes in an estuary from a lead-210 profile alone.

The equation commonly used to describe the mixing by organisms is in the form of a classical diffusion equation (assuming that the time scale of sediment accumulation is much longer than that of mixing). The measure of the efficiency of the biological mixing of sediment particles carrying the tracer is called the biological mixing coefficient: K_B . This coefficient is determined by fitting the observed data points to the diffusion equation. The higher the calculated value of K_B , the faster the mixing rate in the bioturbated zone.

Although a primary aim of this article is to discuss the geochemist's contribution to the understanding of bioturbation in the deep sea, there are compelling reasons for looking at the estuarine system first. It was in this environment that, at Yale University, Robert C. Aller (now of the University of Chicago) and J. Kirk Cochran first

demonstrated the power of these natural radionuclides in bioturbation studies. Cores can be obtained by divers in these relatively shallow waters in a manner that guarantees total recovery, especially of the critical sediment/water interface. X-radiographs of cores so obtained permit direct comparisons of the distributions of thorium-234 with biogenic sedimentary structures (Figure 3). Thus much can be learned of theory and procedure from studying a rapidly accumulating, shallow water sedimentary system, such as Long Island Sound.

Figure 3 also shows a similar study made by the Yale group in the New York Bight. The sediments in the Bight are subject to much more intensive physical reworking than sheltered basins like Long Island Sound. The finer-grained sediment patches in the New York Bight apparently are resuspended on a 10-year-cycle at least, if not more frequently. The exponential decrease of thorium-234 demonstrates that this sediment pocket has been stable for at least five months and, regardless of its previous history, the top 5 centimeters is being reworked on a rapid time scale.

The Project FAMOUS Study

Another problem arises when attempting to get the rates of bioturbation in deep-sea sediments — that of obtaining suitable cores, those whose sediment/water interface has remained intact during sampling. We cannot use divers to obtain the necessary cores; we must depend on protected vehicles for the transport of the human samplers to the deep ocean floor, or on remote sampling devices. As the zone of rapid particle mixing is restricted to the top few centimeters of the sediment column, any coring device that is



Figure 4. The Alvin preparing to take a punch-type core in the FAMOUS area of the Mid-Atlantic Ridge near the Azores. This type of coring guarantees the recovery of the sediment/water interface. It is by the analysis of a core taken in this way that the data displayed in Figures 5 and 6 were obtained.

ambiguous about whether it has preserved this critical zone is undesirable. The problem has been effectively solved by using one of four kinds of samplers: very large-diameter piston corers, slowly inserted gravity corers, box corers (all deployed from surface ships), and punch corers manipulated from a research submersible.

We (Nozaki, Cochran, and Turekian of Yale, and George Keller of Oregon State University) made our first detailed study of the rates of bioturbation using the research submersible *Alvin* during Project FAMOUS (French American Mid-Ocean Undersea Study). Cores were obtained by visual observation, using the *Alvin's* remote sampling arm (Figure 4). We thus were guaranteed a perfect core of the top part of the sediment column in the chosen area. The sediment is predominantly calcium carbonate with fine basaltic fragments. Figure 5 shows the

distribution of lead-210 with depth in the core. Note that the same exponential decrease occurs for excess lead-210 in this slowly accumulating deep-sea core as was observed for thorium-234 in the rapidly accumulating estuarine cores, and that the decrease takes place in both places with approximately the same depth scale. Since lead-210 has a radioactive time constant 300 times longer than thorium-234, the biological mixing rate in deep-sea sediments must be about two to three orders of magnitude smaller than in estuarine sediments.

Bioturbation Rates in Deep-Sea Sediments

Indeed the K_B obtained from the Project FAMOUS core was not very different from those estimated by Guinasso and Schink based on the distribution patterns of microtektites and plutonium. The question arises: How variable is the bioturbation rate in deep-sea sediments and how is the rate related to sediment type or sediment accumulation? In order to answer this question, David DeMaster and Cochran at Yale determined the distribution of lead-210 in remotely obtained cores using one of the several acceptable sampling devices. These were taken from virtually all the major sedimentary environments having different sediment types and sediment accumulation rates. The summary of the results is shown in Table 2.

Two major observations can be made from the data of Table 2. One has been alluded to already — the rates in the deep sea are two to three orders of magnitude slower than in estuaries. The second is that in the deep-sea sediments sampled, there is no apparent correlation between the mixing rate and the sediment type or the sediment accumulation rate. The range of deep-sea K_B values is an order of magnitude between the lowest and the highest values. This range is comparable to the range found in nearshore regions.

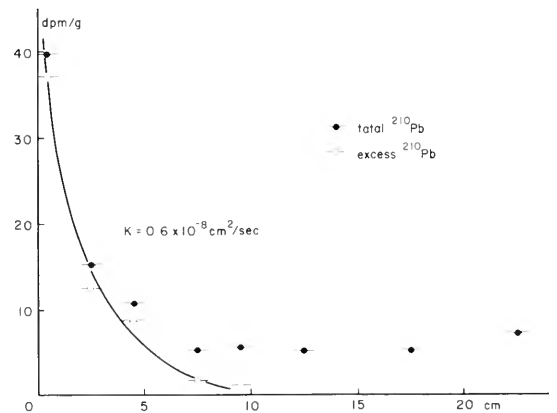

Figure 5. The distribution of excess lead-210 with depth in core 527-3 obtained by the Alvin (Figure 4) during Project FAMOUS. The value of K_B is determined by fitting an exponential curve to the data points.

Table 2: Mixing rate data for marine sediments obtained from uranium decay series radionuclides.

Location	Water depth (m)	Sediment type	Sediment accumulation rate (cm/1000 y)	Mixing coefficient, K_B (cm ² /sec)
NEARSHORE (Based on thorium-234)				
Long Island Sound				
41°10'N, 72°56'W	15	silt-clay	100-300	0.2 x 10 ⁻⁶ (summer/winter) 1.2 x 10 ⁻⁶ (fall)
41° 3'N, 72°53'W	34	silt-clay	100-300	0.1 x 10 ⁻⁶ (fall)
New York Bight				
40°25'N, 73°54'W	23	silt-sand	*	0.5 x 10 ⁻⁶ (winter/spring)
DEEP SEA (Based on lead-210)				
North Atlantic				
36°49'N, 38°15'W	2705	calcareous ooze	2.9	6 x 10 ⁻⁹
South Atlantic				
41°33'S, 20°12'E	4910	calcareous ooze	—	2 x 10 ⁻⁹
North Equatorial Pacific				
9° 2'N, 151°11'W	5050	clay-siliceous ooze	0.15	14 x 10 ⁻⁹
11°15'N, 139° 4'W	4830	clay-siliceous ooze	0.31	8 x 10 ⁻⁹
15°20'N, 125°54'W	4640	clay-siliceous ooze	0.14	10 x 10 ⁻⁹
Antarctic				
53° 0'S, 35°38'E	4340	siliceous ooze	1	1 x 10 ⁻⁹
52°59'S, 35°43'E	4730	siliceous ooze	1	7 x 10 ⁻⁹
53°16'S, 35°54'E	4540	siliceous ooze	1	8 x 10 ⁻⁹
66°47'S, 30°08'E	4080	clay	0.4	2 x 10 ⁻⁹

*The silty sediments of New York Bight are frequently resuspended as indicated by the depth distribution of plutonium in cores; thus sediment accumulation rates cannot be readily determined.

These results may be related to the productivity in surface waters and ultimately, delivery of edible organic material to the ocean floor. The rate of bioturbation is greater in estuarine sediment than in the deep sea not only because the biological productivity is generally higher in estuaries than in the open ocean, but also because the shallower water depth enables more edible organic material to reach the sediment/water interface. In the deep sea, a large amount of the organic matter produced in the euphotic zone (from the surface to 80 or more meters) is cycled in the water column. A smaller fraction descends to the deep ocean floor, where it sustains the life there.

There are several possible explanations for the observed range of mixing rates. The dominant control in the nearshore environment seems to be by patchiness in trophic groups. In near-interface sediments of Long Island Sound, for example, Aller has shown that shallow protobranch-inhabited areas are mixed more rapidly than deeper regimes characterized by the more sedentary fauna. The deep sea, characterized by low abundance but high diversity of fauna, displays a variability in benthic biomass of about an order of magnitude. The variation in primary productivity in the surface

waters of the major ocean basins has a range of only about a factor of *three* from the highest to lowest values (excluding the extremes of high productivity areas and biological "deserts"). Thus the range of deep-sea bioturbation rates is related to variability in benthic biomass and surface productivity, and possibly other factors.

Although we can determine the rate of bioturbation in sediments by using thorium-234 or lead-210, we cannot determine the depth of biological reworking using these nuclides alone. This is because the depth limit of detection of these nuclides need not correspond to the depth to which bioturbation is active. It is only with the help of longer-lived radionuclides that we can establish the depth in the sediment pile to which the biological mixing coefficient can be applied.

Biological Mixing of Sediment Properties

From the K_B values in the deep sea given in Table 2, it can be deduced that particle-associated radionuclides, which have half-lives greater than several thousand years and are supplied at a constant rate to the ocean bottom, will be homogenized in the mixed zone. That is, the specific radioactivity of such long-lived radionuclides will be constant in the mixed zone,

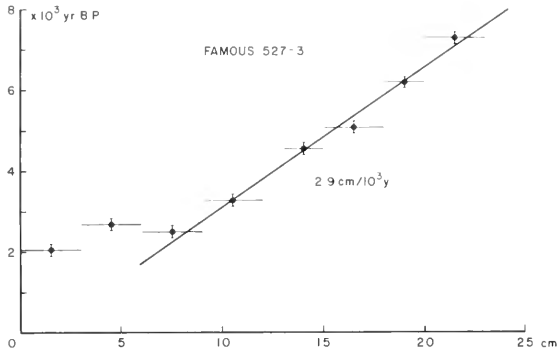

Figure 6. The distribution of carbon-14 with depth in core 527-3 shows a homogeneous value in the top 8 centimeters and a linearly increasing age at greater depths. From this, the depth of bioturbation and the sediment accumulation rate can be determined.

and only begin to decrease exponentially with depth due to radioactive decay as the sediment accumulates below the zone of bioturbation.

An example of this is carbon-14 (half-life 5,700 years) found in the shells of calcium-carbonate-depositing organisms in the sediment. Figure 6 shows how carbon-14 is distributed in the FAMOUS core whose lead-210 profile is given in Figure 5. Clearly, by the criteria previously discussed — the fact that the carbon-14 specific radioactivity is constant in the top 8 centimeters of the core and then decreases systematically due to radioactive decay below that depth — indicates that rapid mixing is indeed limited to 8 centimeters, and does not extend throughout the entire sediment column.

This has several consequences, all of which bear on the use of radio-carbon in dating deep-sea cores and in using the properties of the calcareous shells in inferring ancient climates. First, it explains how the tops of cores can have apparent old ages (Figure 7). Second, it explains why rates of accumulation can be determined from data below the zone of bioturbation. Once a sediment layer is submerged by sediment accumulation below the active bioturbation zone, all changes in the carbon-14 content are due to radioactive decay and therefore directly relatable to an age. Finally, it shows the maximum resolution that paleontological indicators can have. For the FAMOUS area (3 centimeters per 1,000 years sediment accumulation rate and 8 centimeters mixing depth), this means that a roughly 2,500-year running mean for paleontologic indicators must be assumed in the sedimentary record. That is, we cannot hope to resolve climatic changes on a time scale much shorter than 2,500 years by looking at the foraminiferal record of the sea floor (Figure 8).

In non-calcareous cores, the long-lived radionuclides that can be used to determine depth of mixing by the same criteria are protactinium-231

(32,000 year half-life) and thorium-230 (75,000 year half-life). Measurements of these nuclides as a function of depth in a core show that the depth of mixing even in "red clay" cores is about 10 centimeters. Since clay cores accumulate at one tenth the rate of calcium carbonate cores, a running mean of about 25,000 years is predicted for sedimentary properties.

A special consequence of the effects of bioturbation on this time scale is the nature of the preserved magnetic reversal stratigraphy.* That part of the sediment column subject to bioturbation will always maintain the contemporary polarity. Only after it is buried below the depth of bioturbation will its acquired magnetic orientation be preserved. Magnetic reversal patterns will appear to be about 25,000 years older than they actually are in red clay cores. Such an offset is not terribly important if one identifies the first major magnetic reversal event as having occurred 700,000 years ago (Brunhes-Matuyama Boundary), but it can influence our ideas about the time scale of several younger magnetic reversal events that have been suggested (such as the proposed LaChamps and Blake events at about 15,000 and 150,000 years ago, respectively).

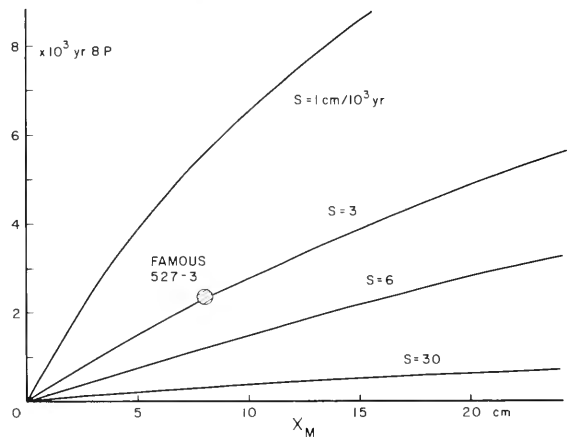

Figure 7. A set of curves relating the depth of bioturbation, the carbon-14 "age" in the mixed layer (due to bioturbation), and the rate of accumulation (inferred from the carbon-14 age distribution with depth below the mixed layer) can be drawn. If any two of these three parameters is known, the third can be determined.

A corollary of the mixing model previously mentioned is that if a sediment is buried below the critical zone of rapid bioturbation, it is "home-free!" The only things that can happen to it are chemical transformations, affecting the mineralogy, chemical composition, or chemically

*Magnetic reversals of the earth's poles occurring over geologic time are recorded by magnetic parts of sediment deposited on the ocean floor. The time scale of these reversals is known from dated lava flows on land, thus the record in the sediments can be assigned a chronology.



Figure 8. Foraminifer, a minute, one-celled marine organism that secretes a calcareous shell in sediments. This one is 350 microns in diameter. (Photo by Goreau)

dependent magnetic properties of the sediment (all three of these perturbations have been reported). This picture, however, is not completely true. On a longer time scale, deeper burrowing organisms, possibly in self-defense maneuvers, can disturb the sedimentary record. These are often (but not always) clearly identified as discrete burrows. The redistribution of tracers under these circumstances cannot be treated as behaving in a diffusion-like manner because of the low frequency of occurrence in standard-sized cores. Although these events are infrequent, some caution is required when interpreting the geological and historical records preserved in sediments.

Karl K. Turekian, J. Kirk Cochran, and David J. DeMaster are members of the Department of Geology and Geophysics at Yale University, New Haven, Connecticut. Professor Turekian was a Visiting Scholar this past summer at the Woods Hole Oceanographic Institution.

This research on deep-sea sediment processes is funded by the National Science Foundation.

Diversity and Population Dynamics of Benthic Organisms

by J. Frederick Grassle



Despite periods of intense popular interest and a number of major expeditions, the organisms in the deep sea are still the least known creatures on the planet. The extent of the variety of life at great depths is only beginning to be realized. Over the last decade, research vessels from the Woods Hole Oceanographic Institution have taken many samples of bottom life, which are then subjected to systematic studies. Technological developments, such as the use of fine screens and closing doors on trawls, make it possible to obtain single samples containing many times more animals than were collected on the entire *Challenger* expedition (1872-1876). The collection of these samples has resulted in several major taxonomic monographs and numerous publications describing a myriad of previously unknown species. What used to be

regarded as a vast, barren region is now seen to be an uncharted reservoir of tremendous biological variety.

In recent years, considerable progress has been made in understanding the evolution and maintenance of animal and plant diversity. Temporal stability, spatial configuration, the amount of energy available for growth and metabolism, and the time span over which the evolutionary process occurs are the primary determinants of animal diversity. Secondary considerations are the geographic distribution of species and the kinds of biotic interactions that take place between species.

The deep sea is particularly interesting because of its unusual combination of environmental conditions: it is a large area that is



Figure 1. Although a few large species are visible on the surface, most of the diversity of life in the deep sea is found in the mud. Here, a holothurian, *Pelopates gigantea*, an urchin, *Echinus affinis*, and brittle stars, *Ophiomusium lymani*, share the sediment surface.

relatively stable over long time spans, has little topographic complexity, and receives low inputs of energy. A few large animals are visible on the sediment surface, but most animals are small, mud-dwelling creatures (Figure 1). Though the organisms that reside there are small, the variety is great. The diversity of life in the deep sea is comparable to that found in rain forests and on coral reefs, where communities evolve in environments that receive abundant supplies of energy from the tropical sun, are relatively stable, have physical barriers between areas of greatest diversity, and have long evolutionary histories. The features that the deep sea shares with rain forests and coral reefs are relative stability and a long evolutionary history. This observation, along with a number of smaller-scale correlations between

diversity and stability, led to the formulation of a stability-time hypothesis, proposed by Dr. Howard Sanders at the Woods Hole Oceanographic Institution. This simply states that species' diversity depends on environmental stability and the length of time over which evolution occurs.

Correlation with physical features of the environment provides only a partial explanation: how can these correlations be understood in terms of biological mechanisms that contribute to the evolution and maintenance of species' diversity? For coexisting species, differences evolve in the type and proportion of resources used. The mud habitat of deep-sea species is comparatively homogeneous, and most species obtain food by ingesting mud. Although there are likely to be differences between species in the type of food

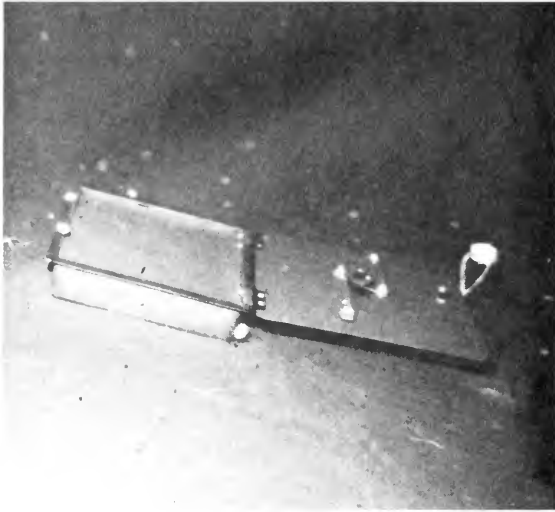

Figure 2. Mud sediment tray resting on permanent bottom station at 1,800 meters.

removed from the ingested mud, this has proven difficult to pinpoint. Even if differences in food exist, it is unlikely that there will be enough variation to account for the very high diversity of species. A better understanding of the evolution of high diversity in the deep sea will require analysis of the dynamics of populations and the interactions between species. This is also the information needed to predict rates of recovery following man-made perturbations, such as deep-sea mining or waste disposal.

Experiments on the Sea Floor

We cannot simulate deep-sea conditions in the laboratory at the present time, so experiments must

be done on the sea floor. The low frequency of disturbance and the generally uniform nature of the deep-sea environment make it an ideal laboratory in which to study how various life history characteristics are likely to have evolved. Many of our experiments take years to complete. We have used the research submersible *Alvin* to place, manipulate, and retrieve experiments at permanent bottom stations established at 1,800 and 3,600 meters off the northeastern United States, and at 2,000 meters in the Tongue of the Ocean, near the Bahamas (designated as DOS #1, DOS #2, and TOTO, respectively).

My experiments have involved the use of unoccupied sediments to follow rates of species colonization and growth. Sediments are collected from the deep sea, frozen and thawed to hasten decomposition of animals, and then placed in trays measuring a quarter of a meter squared. These trays of sediments are placed on the bottom by the submersible, opened, and left for varying intervals of time (Figure 2). At each of the three stations, we have retrieved trays that have been exposed for periods ranging from two months to three years. Figure 3 shows traces of burrowing animals on the surface of a sediment tray that was left on the bottom for three years. More recently, we have launched trays of sediment as free vehicles that can be recalled to the surface by acoustic commands (Figure 4). Immediately after retrieval, the contents of each tray, as well as the control samples from surrounding sediments, are gently washed over fine screens. The materials retained on the screens are then sorted under a microscope, a process that may take months for a single sample.

Although we have not yet processed all samples; thus far, the results indicate very low rates

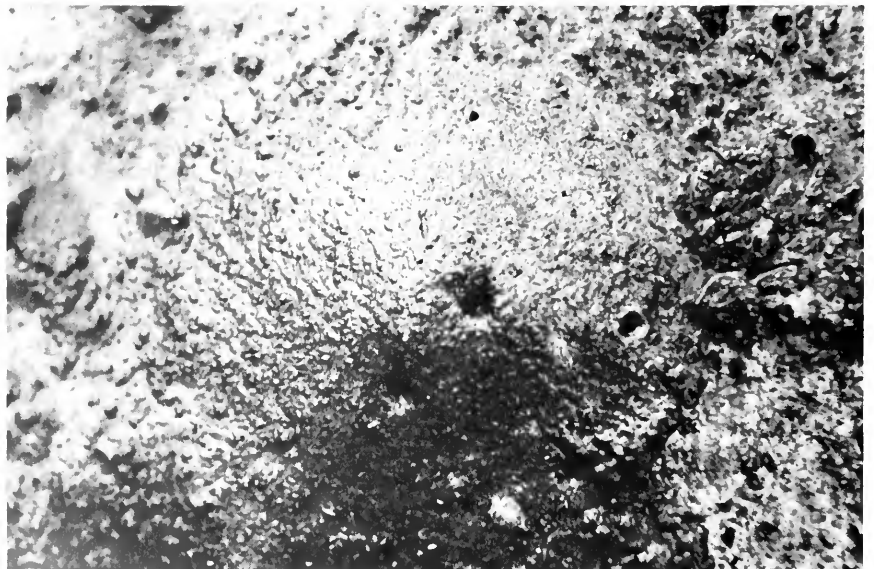

Figure 3. Traces of the activities of mud-dwelling species appear on an approximately 4-centimeter by 5-centimeter surface of a tray. The tray has been on the bottom for three years at our permanent bottom station near Bermuda. (Photo by John Porteous)

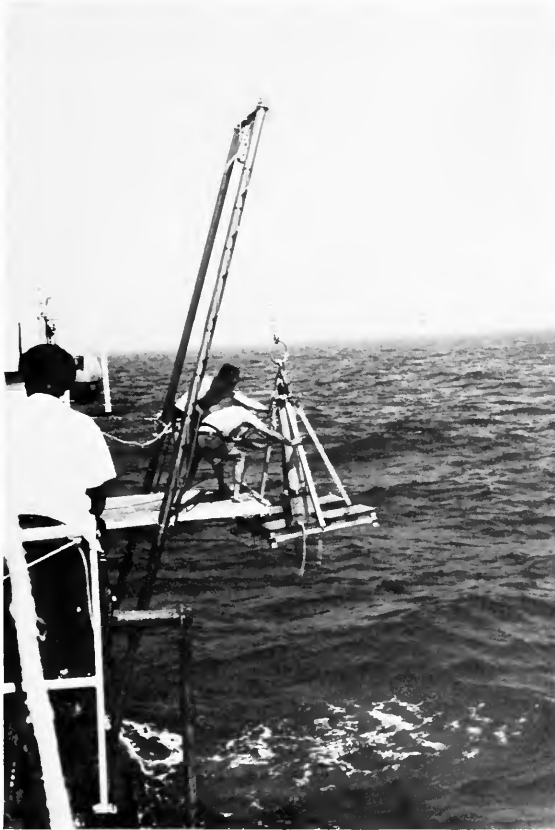

Figure 4. Free-vehicle sediment tray experiment being retrieved aboard the research vessel Lulu, mother ship of the submersible Alvin.

of colonization in comparison with shallow-water experiments (Grassle, 1977). After exposure of two years, densities of life are an order of magnitude lower than those of surrounding sediments. Table 1 shows the most common animals colonizing sediment trays compared to the most common

species found in the surrounding sediments. Deep-sea animals colonize the sediments by means of larval dispersal stages carried by bottom currents. Most of the animals settling in the trays are still juveniles after two years — with one exception, a species of polychaete worm belonging to the genus *Capitella*. These organisms are known for their ability to increase in number following disturbances in shallow water (see *Oceanus*, Fall, 1977). They are generally rare in the deep sea, although dense populations have been reported in a deep-sea area disturbed by the influence of freshwater aquifers off the coast of California. The unoccupied sediment of the experimental tray simulates the disturbances that favor such opportunistic species. Natural sources of disturbances frequently affecting small areas are mud slumps, fish and invertebrate activity, and large objects settling from the surface — especially carcasses of animals, sargassum weed, and wood.

Population Processes

For the most part, the growth rates of the fauna sampled indicate times to maturity of longer than two years. One of the deep-sea relatives of the sea squirt (a simple ascidian) and the most common of the Continental Slope bivalves, *Nucula cancellata* grows to maturity in about two years. At the other extreme, another species of bivalve, *Tindaria callistiformis*, found on the Continental Rise, reaches maturity in about 50 years, with the oldest age class living to about 100 years (Figure 5). These dates were obtained by Professor Karl Turekian and co-workers at Yale University, using radium-228 chronology (see page 34). The shortest time to maturity reported for a deep-sea bivalve is about three months, discovered by Professor Ruth Turner of Harvard University. This is a wood-boring species that grew in and devoured wood panels that had been placed on the ocean bottom by *Alvin* (Figure 6). Most deep-sea bivalves have from 2 to 1,000

Table 1: Species contributing more than 2.3 percent of the individuals in the 26-month experimental boxes and 25 control cores.

25 Control cores (.09 m ²)		26-month box DOS #1 (.25 m ²)	
<i>Prochaetoderma</i> sp.	7.5%	Gnathiid isopod	13.5%
Spionid (undescribed)	5.1%	<i>Neopodarke woodsholea</i>	12.8%
<i>Aricidea abbranchiata</i>	4.4%	<i>Capitella</i> sp.	11.4%
<i>Glycera mimica</i>	4.2%	<i>Glycera mimica</i>	11.4%
<i>Pholoe anoculata</i>	3.7%	<i>Nucula cancellata</i>	9.9%
<i>Priapulus atlantisi</i>	3.3%	<i>Nucula cortica</i>	5.0%
<i>Nucula cancellata</i>	3.1%	<i>Pholoe anoculata</i>	3.6%
<i>Polycarpa delta</i>	2.9%	Ampharetid	3.6%
<i>Tharyx</i> sp.	2.6%	Holothurian	2.8%
<i>Poecilochaetus fulgoris</i>	2.4%	<i>Polycarpa delta</i>	2.8%
Total	103 Species	Total	31 Species

From *Nature*, Vol. 265, 1977.

Mud-Dwelling



Protobranch bivalve,
Malletia cuneata, 4.9 mm.



Protobranch bivalve,
Silicula mcalesteri,
8.3 mm.



Protobranch bivalve,
Microgloma yongei,
1.0 mm.



Aplacophoran mollusk,
Prochaetoderma, 3.0 mm.

Creatures of the Deep

*Isopod (crustacea),
Mesosignum, 1.7 mm.*



*Cumacean (crustacea),
3.0 mm.*



*Ostracod (crustacea),
1.5 mm.*

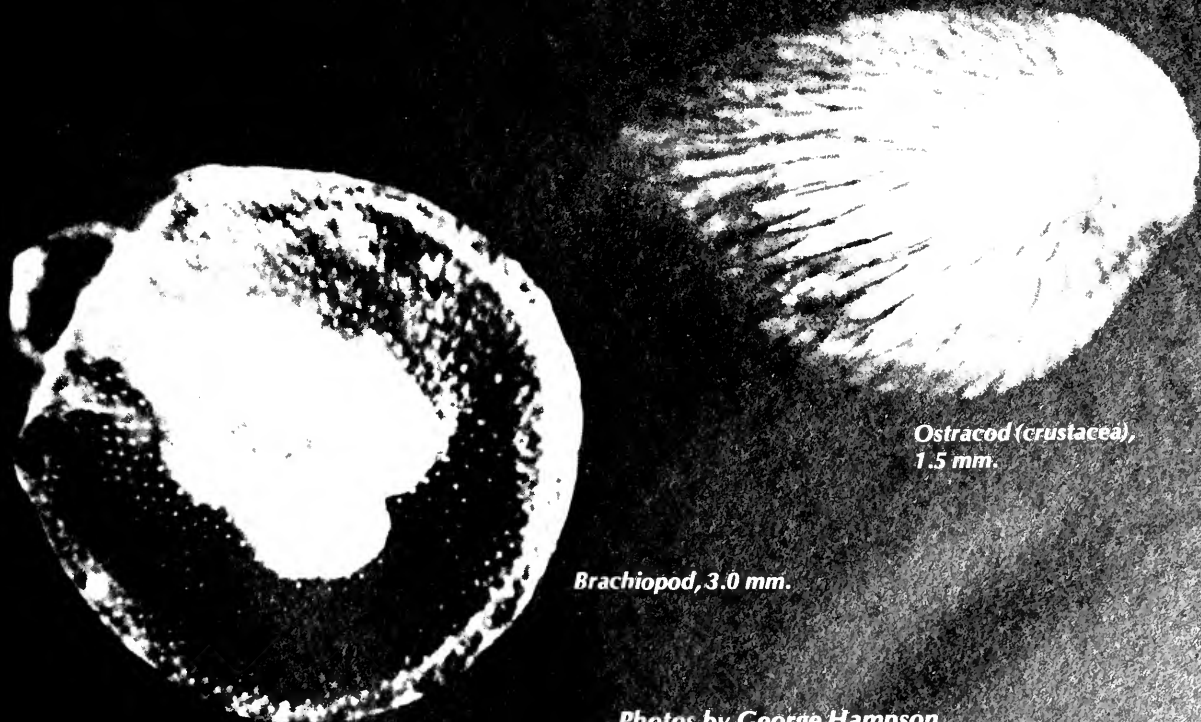

Brachiopod, 3.0 mm.

Photos by George Hampson

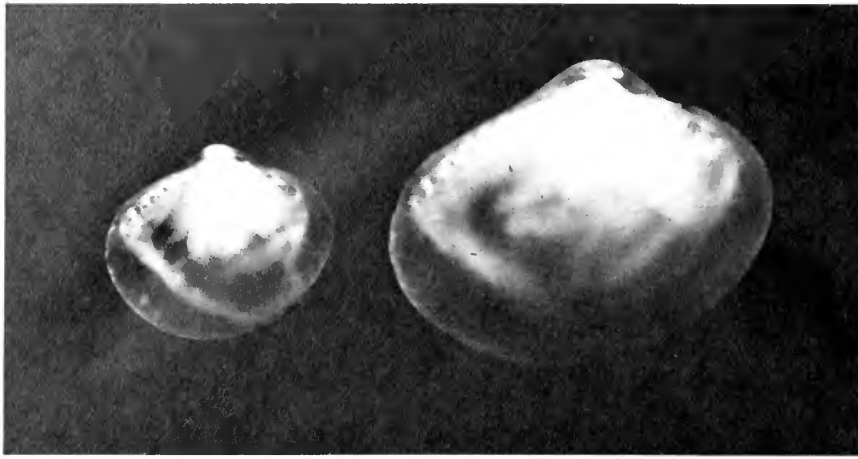

Figure 5. Deep-sea bivalves, *Tindaria callistiformis*. The largest of these species (8 millimeters) are estimated to be 100 years old. These are 1.5 millimeters and 2.4 mm. (Photo by George Hampson)

eggs. Within this range, a 50-year-old female *Tindaria callistiformis* produces about 230 eggs. In contrast, each wood borer produces approximately 30,000 eggs.

These data provide strong support for current theories on the evolution of the rates of population processes. Studies of a variety of terrestrial forms indicate that species found in ephemeral habitats have greater capacity for population increase, and shorter maturation times and life spans. Since the deep sea is a relatively constant environment, we expect most species there to have low reproductive potential, and long maturation and life spans.

The evolution of low rates of population processes in relatively constant environments may also explain the low rates of microbial activity in the deep sea (see page 50). Microorganisms in shallow water increase rapidly, exploiting concentrations of organic matter. In the deep sea, concentrations of organic matter are infrequent and distant from one another. The more mobile animals arrive at the sites and use up the food long before bacterial and fungal spores can increase to large numbers. Since most of the organic matter is utilized by higher organisms, evolution may favor species of microorganisms that can survive on constant supplies of low amounts of organic matter. A deep-sea environment that



Figure 6. Wood-boring bivalves in wood panel, showing burrowers entering from both sides. The panel diameter is 20 millimeters. It was on the bottom 104 days at one of our permanent deep-ocean bottom stations. (Photo by Ruth Turner, *Science*, Vol. 180, pp. 177-79, 1973)

provides a rich supply of food for microorganisms in the guts of animals, where rapid increases in microbial populations may occur.

Species adapt to most environmental changes through the physiological and behavioral responses elicited from each individual in the population. However, sudden catastrophic changes in the environment may not be within the tolerance range of each individual, and thus population adjustments are required for the species' survival. Species that survive in environments that receive disturbances must have the ability to increase rapidly under favorable conditions, producing sufficient numbers of juveniles, which can then colonize new areas when the local environment becomes uninhabitable. These opportunistic species are well-adapted for life in short-lived, unpredictable habitats; characteristically they have short maturation times and produce large numbers of eggs. If disturbance is frequent, a premium is placed on a local increase in numbers. In the deep sea, disturbance is highly localized and rare, favoring the dispersal of young that have the ability to settle and grow rapidly once a favorable habitat is reached. For most animals living on the sea floor, dispersal is accomplished by the passive spread of planktonic larval stages. The opportunistic wood borer, whose only habitat is the piece of wood that occasionally sinks to great depths, consumes the wood, thus ensuring a short-lived habitat. The large number of young produced by the wood borer remain in the water as larvae until the next piece of wood is located.

The experiments utilizing *Alvin* provide the first direct information on how the deep-sea community functions, allowing the coexistence of an enormous variety of species. Although disturbance is infrequent, when it does occur, a few species slowly colonize. The species' composition in the disturbed area remains different from the surrounding environment for years. This is in sharp contrast to high-latitude, shallow-water environments where recovery occurs in months or less. The very slow rates of colonization in the deep sea mean that an environmental mosaic is created. Each small patch differs, depending on the length of time following disturbance and the particular species that happen to settle there. The infrequent small disturbances (as described previously) are the sources of environmental heterogeneity. These disturbances are so localized and occur so infrequently that the patchiness they produce is seldom demonstrated in quantitative samples.

The heterogeneity resulting from disturbance may be further magnified by interactions between species. Since each individual is relatively long-lived, there are greater possibilities for species to adapt to one another in symbiotic relationships. Negative relationships between species, such as predation and parasitism,

prevent single species from monopolizing areas and favor evolution of dispersal so that offspring do not grow up with the same natural enemies as the adults (Connell, 1975).

The Road Ahead

The deep-ocean floor represents the greatest part of the surface of the earth inhabited by organisms (see page 50). This huge area has a potential impact on the major geochemical cycles of the planet. Our studies of diversity and the preliminary information on rates of population processes indicate that the deep sea is an extremely fragile ecosystem. Most species evolve in relatively unchanging environments and are ill-equipped to deal with broad-scale disturbances. Environmental changes in the deep sea that have little or no effect on land or in shallow water are likely to severely affect deep-sea communities by interfering with the fine-scale structure of the community that develops over tens of years. Our future measurements on the response of populations to disturbance will be of practical value in predicting the effects of human perturbations, such as dumping wastes into the ocean, and sea mining. Further experiments on the sea floor are needed in order to predict more accurately the rates of recovery following such disturbances, and the rates at which organisms facilitate the spread of toxic wastes.

J. Frederick Grassle is an Associate Scientist in the Biology Department at the Woods Hole Oceanographic Institution.

References

- Connell, J.H. 1975. Some mechanisms producing structure in natural communities. In *Ecology and evolution of communities*, eds. M.L. Cody and J.M. Diamond. Cambridge and London: Belknap Press of Harvard University Press.
- Grassle, J.F. 1977. Slow recolonization of deep-sea sediment. *Nature* 265: 618-9.
- Sanders, H.L. 1977. Evolutionary ecology and the deep-sea benthos. In *The changing scenes in the natural sciences, 1776-1976*, ed. by C.E. Goulden, pp. 223-43. Phila., Pa.: Academy of Natural Sciences.
- Turner, R.D. 1973. Wood-boring bivalves, opportunistic species in the deep-sea. *Science* 180: 1377-9.

Experiments in Deep-Sea Microbiology

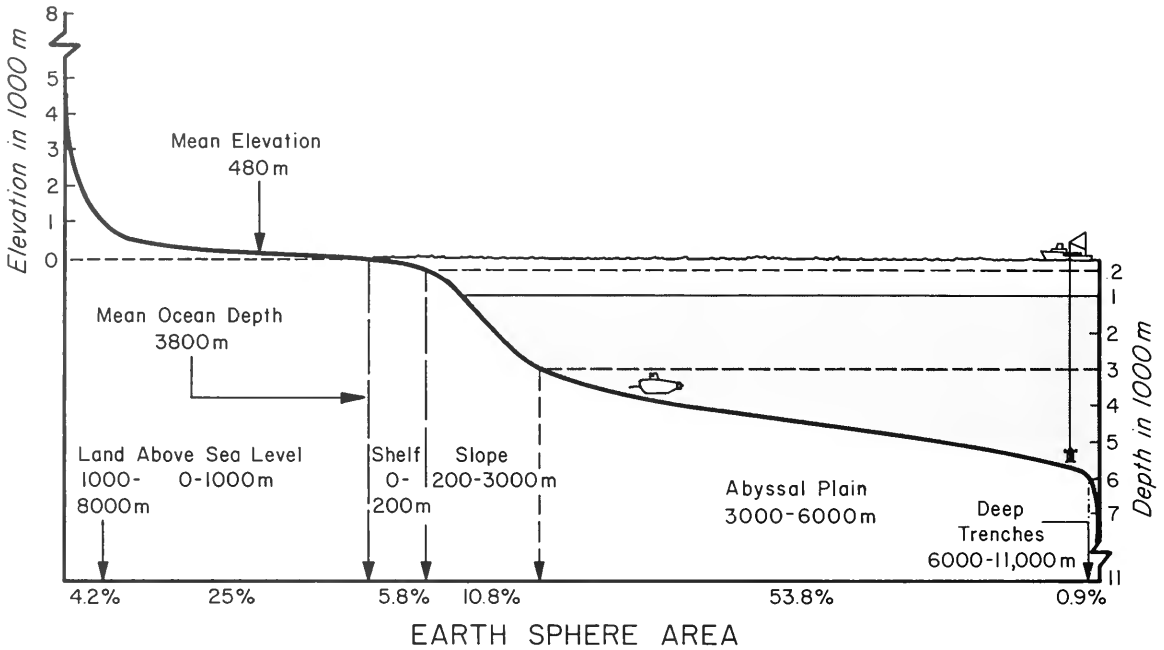

Figure 1. The deep sea (below a depth of 1,000 meters) covers 63 percent of the earth's surface and represents about 75 percent of the total volume of seawater. Permanent experimental stations have been established on the deep-sea floor that are periodically revisited by the research submersible *Alvin*, which can dive to a maximum depth of 3,700 meters. Special water samplers lowered from ships are used for the retrieval of microorganisms under pressures of up to 600 atmospheres, which corresponds to a depth of about 6,000 meters. (The mean depth of the ocean and the mean elevation of the land mass above sea level are determined by dividing volume by area.)

by Holger W. Jannasch

About 99 percent of the world's biosphere is seawater. A dive in the submersible *Alvin* convinces an observer quickly that this is not just an academic figure. Planktonic life is surprisingly dense in the water column from the surface to a depth of several thousand meters. The benthic populations — although less abundant in deep than in shallow waters — indicate a substantial flow of energy in the form of organic food materials from the productive surface waters to the deep-sea floor.

The biological activity of the remaining 1 percent — the plant productivity and the recycling of organic matter within the terrestrial biosphere — still has an edge over that of the oceans. Yet, in contrast to our knowledge of life processes in soil and surface waters, we know very little about biological activity in the deep sea.

If the deep sea is arbitrarily defined as starting at a depth of 1,000 meters, it still represents about three quarters of the biosphere (Figure 1). There is no light and the temperature is a few degrees above freezing. The hydrostatic pressure increases about one atmosphere with every 10 meters of depth. The populations of animals and microorganisms depend upon organic food materials sinking down from the photosynthetically productive surface layer, and those introduced by

land runoff, although there is a recently discovered exception to this rule, which will be discussed later.

The rates at which essential nutrients are recycled in the benthic environment are still largely unknown, as are the rates of deep-sea organism growth, metabolism, and reproduction under the effects of high pressure and low temperature. Along with future research in these areas, it also will be important to study in situ the effects of man's dumping organic wastes into the deep sea, specifically the interactions between these materials and deep-sea organisms.

During the last two decades, microbiological research has contributed to the founding of molecular biology, the major advances in genetics, and aspects of ecology and the environmental sciences. The efforts in looking for life on the moon and Mars are essentially the same as those that microbiologists use for looking at microorganisms,

or for testing the larger variety of biochemical processes indicative of microbial life.

Microorganisms, mainly bacteria, can be found in practically every drop of seawater. They offer ideal experimental possibilities for studying basic biological phenomena under the special deep-sea conditions of extreme food limitation, high hydrostatic pressure, and low temperature. When deep-sea sediment or water from any depth is brought to the surface and streaked on suitable bacteriological media, microorganisms usually grow profusely. Experiments subjecting such organisms to hydrostatic pressures equivalent to those existing at various depths in the ocean were first conducted by F. H. Johnson and C. E. ZoBell in the late 1940s. It was found that bacterial metabolism and morphology, as well as the activity of isolated enzymes, were affected by increasing pressure, but that the degree of pressure tolerance varied greatly from organism to organism.

The early research on this subject left one problem unattacked. Prior to studying the effect of high pressure on deep-sea bacteria, the organisms have to be isolated from water or sediment samples that are brought up to normal atmospheric pressure, thereby undergoing a decompression of several hundred atmospheres. Many of the organisms survive, but how many? And are the survivors active in the deep sea? Further, are there any microorganisms that do not survive decompression during retrieval, and, if so, are they specifically adapted to life in the deep sea, and what are their metabolic rates under deep-sea conditions?

There are "psychophilic," or cold-loving, bacteria that tolerate low temperatures and grow in the range of -1 to about 18 degrees Celsius. There also are indications that "barophilic," or pressure-loving, bacteria exist. These organisms are defined as growing faster at higher pressure than at normal atmospheric pressure. The growth rate of bacterial deep-sea organisms studied thus far has been slowed when subjected to increased pressure, which makes them "barotolerant." Organisms tolerating low temperatures may be killed at moderate temperatures (about 20 degrees Celsius), and, therefore, have to be isolated at low temperature. By analogy, the unavoidable decompression might defy the detection of barophilic bacteria.

The *Alvin* Sandwich

In 1968, a launching accident provided us with an idea of how to overcome this basic problem. The research submersible *Alvin*, operated by Woods Hole Oceanographic Institution, sank (without loss of life) in 1,540 meters of water about 100 miles south of Nantucket, Massachusetts (see *Oceanus*, Vol. 16, No. 3, 1972). She could not be recovered until 11 months later. We then learned that an



The Alvin sandwich.

unplanned experiment had taken place on the biodegradation of some organic materials. Inside the submersible was a plastic box that excluded larger than microscopic organisms. It contained samples of carbohydrates in the form of starch and sugar, proteins in liquid and solid form, lipids, and even packages of intact plant cells, representing live membrane structures. In other words, a crew member's box lunch, containing bread with mayonnaise and bologna, bouillon, and fresh apples. When retrieved, these foodstuffs appeared to be in a well-preserved state, but they spoiled within a few weeks when kept under refrigeration at deep-sea temperatures of about 3 degrees Celsius.

These observations were intriguing, but the evidence was not conclusive enough. It occurred to us that similar experiments could be repeated under well-defined conditions. We prevailed upon physical oceanographers to attach sample packages to their retrievable mooring lines, incubating a variety of organic materials for periods of two to six months at a depth of 5,300 meters. In this way, microbial growth and metabolic activity took place under deep-sea conditions prior to retrieval, fixing, and measuring the degree of substrate conversion.

Pure cultures and natural populations of bacteria with a variety of dissolved and solid organic substrates were thus submersed. Control samples were incubated at normal atmospheric pressure, and at temperatures equal to those at the depths of submersion — from 2.0 to 3.5 degrees Celsius. Fresh fish meat is an example of the complex, highly degradable material that decomposed much slower at a depth of 5,300 meters than in the control. Other substrates used in these experiments were agar, as a product of marine algae; chitin, as the skeletal material of many marine invertebrates; gelatin, as a proteinaceous material; and starch, as a common plant polysaccharide. In addition, chemically defined substrates (radioactively labeled) gave us an opportunity for quantitative measurements. From this, the respiration and incorporation of carbon from carbohydrates, amino acids, and fatty acids into microbial cells could be determined. In all

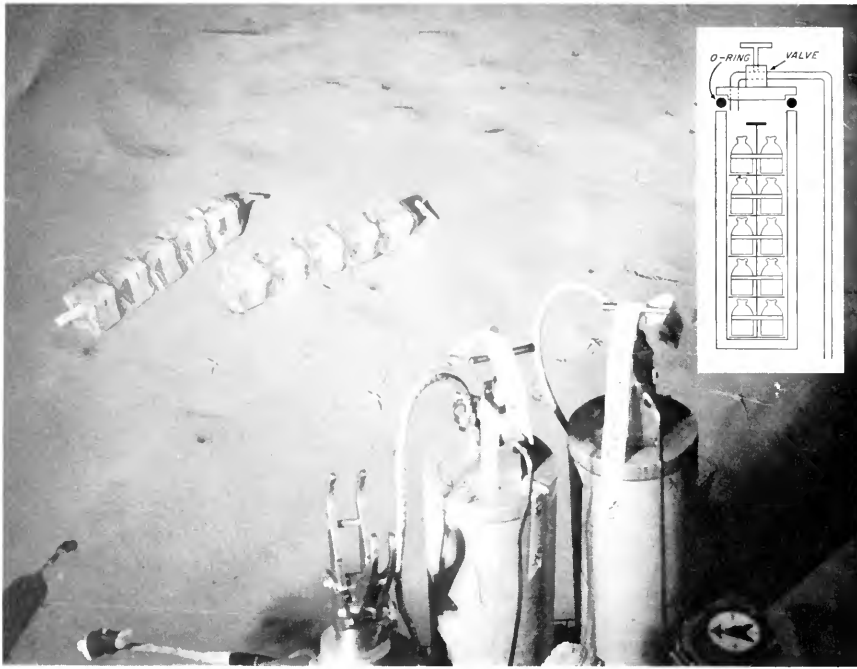

Figure 2. Bottles containing radioactive food materials (used for tracing uptake in microorganisms) are inoculated on the deep-sea floor by a valve operated by Alvin's mechanical arm. The racks of bottles are then removed from the pressure housings and dropped on the ocean floor for up to one year of incubation. After retrieval, the contents of the bottles are fixed and studied for the degree of microbial transformation.

cases, surface-borne bacteria metabolized the substrates up to 100 times slower in deep waters than in the controls incubated at normal pressure.

We expected to obtain the most interesting data, however, from an experiment utilizing the rebuilt *Alvin*. The test featured in situ inoculation of deep-sea microorganisms as well as in situ incubation. To this end, we constructed simple aluminum housings for transporting racks of bottles, containing various sterile substrates, to two permanent deep-sea bottom stations at 1,830 and 3,640 meters (Figure 2). On station, a valve was opened by *Alvin's* mechanical arm, allowing water or sediment slurry to fill the housings. The bottles filled through a slit in the rubber stoppers. When the pressure inside and outside of the housing had equalized, the lid was lifted off and the bottle rack was removed and placed on the ocean floor for incubation of two to 15 months. This approach permitted growth studies of microbial deep-sea populations in the absence of decompression.

The results were surprising: almost the same reduction in microbial activity was found with both in situ and surface-borne populations when incubated in the deep sea. No barophilic response was found; there did not seem to be more barotolerant organisms in deep-sea populations than in those collected near the surface.

There were two factors that might have affected the results of these in situ incubation studies. First, considerable pressure shock and high shear forces occur during the filling of the pressure housings and bottles. Second, mere end-point measurements do not reflect whether rates of activity are constant or continuous over the extended incubation periods. In fact, they may not be. It soon became apparent that a pressure-retaining system had to be developed for

measuring the time course responses of the bacterial populations collected in the deep sea. These populations had to be brought back to the laboratory with the pressure and temperature of the bottom station maintained. This appeared difficult at first, but with the help of Clifford L. Winget and Kenneth H. Doherty, designers of deep-sea equipment at Woods Hole, the first unit was successfully tested in 1973.

Two samplers are in operation at present, one for retaining pressures up to 200 atmospheres, the other for up to 600 atmospheres (maximum sampling depths of 2,000 and 6,000 meters, respectively). These devices (Figure 3) are lowered to the desired depth on a cable from the ship and triggered for the filling by a messenger weight. The sample enters the sterilized upper chamber at a set rate, the pressure differential and shear forces taken up by a liquid (sterile freshwater) passing through a small orifice located in the center section between two free-floating pistons. Upon completion of the filling, a check valve closes. Both pressure and temperature of the 1-liter sample are maintained during retrieval and transferred to a cold room aboard the ship.

When the sampler is subsequently used as a culture vessel, small amounts of media, up to 13 milliliters, are added to the 1-liter sample by a transfer unit. This is an easy operation in that no external source of pressure is needed. An equal subsample is removed at the same time. The sampler is incubated upside-down over a magnetic stirrer. Subsamples are taken at various intervals to measure the uptake and respiration of the radioactive substrates that are being metabolized by the microorganisms in the sample. These instruments and procedures have been used successfully for several years.

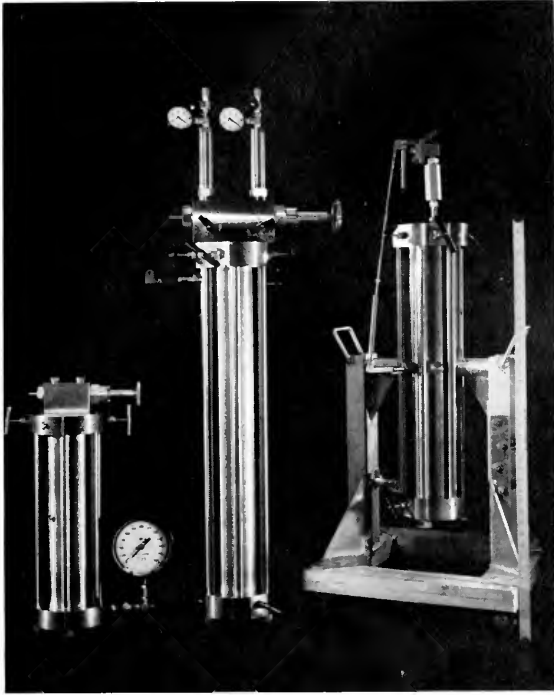

Figure 3. Water samplers for the retrieval of undecompressed microbial populations from the deep sea. The two steel vessels at left and right are capable of retaining the pressure of seawater samples taken at depths of up to 2,000 and 6,000 meters (approximately 200 and 600 atmospheres). The two vessels also serve as incubators when nutrients are added by means of a transfer unit (top of vessel, at left); the seawater sample enters the vessel through a triggering intake mechanism (top of vessel, at right). The more elaborate sampler (center) has a filter that concentrates the water's microbial content. The transfer unit on top of the sampler is used to withdraw part or all of the concentrated sample while maintaining deep-sea pressures (Photo Ralph Morse, Scientific American).

One drawback of this method is the low sampling capacity. Since the two samplers are also used as culture vessels for several weeks of incubation, only two samples per cruise can be taken. Large numbers of samples, however, are needed. The case of a few observations receiving more attention than their actual significance merits has been a problem of deep-sea biology since its inception. Conclusions tend to be drawn more quickly if the chances for repeating an observation are small. Reproducibility and statistical significance of results depend on a sufficient number of samples.

With this in mind, a filter sampler was devised that concentrates 3 liters of deep-sea water 200 times over a fine filter with a porosity of 0.2 microns (Figure 4). After retrieval of the sampler, subsamples of this concentrate can be withdrawn, stored, and later transferred into the

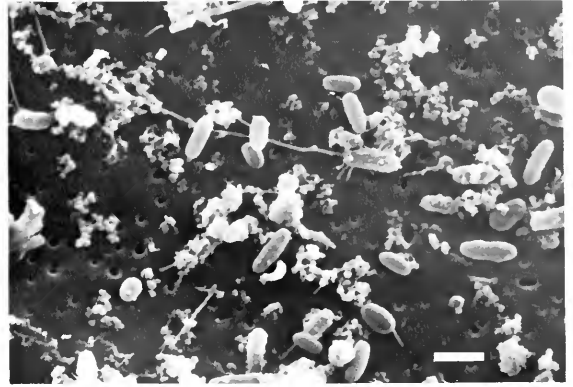

Figure 4. Bacteria collected at a depth of 4,400 meters on a filter with a specified pore size of 0.2 microns. The irregularly spaced holes are the pores of the filter. The thread-like structure may be an unknown microorganism. The granular material is an artifact produced during the fixing of seawater samples for the scanning electron microscopy. The bacterial cells looked the same whether they were fixed before or after decompression. White bar is 1 micron.

prepressurized culture vessels. This sampler can be sterilized and used again on the same cruise. With this device, as many samples can be brought home from a single cruise as transfer/storage chambers are available.

Using the type of instrumentation just described, the studies of undecompressed microbial populations from the deep sea have supported our findings in the in situ incubation experiments — namely that increasing pressure decreases metabolic activity. No barophilic response was found, only various degrees of barotolerance (Figure 5).

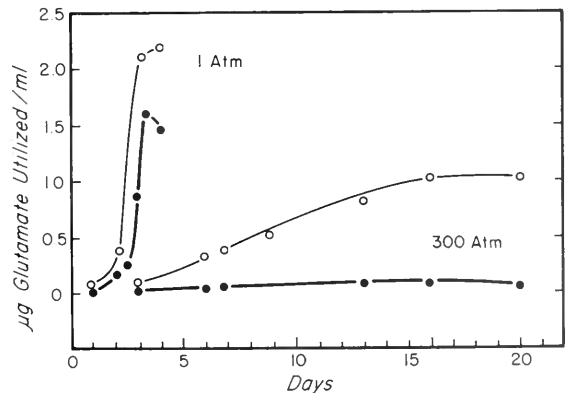

Figure 5. The effect of pressure on microbial metabolism is best shown when the data of decompressed and undecompressed deep-sea populations are compared. Both the uptake of radioactive carbon (dots) and the production of carbon dioxide (respiration, circles) are increased when the in situ pressure is released. Respiration is less affected by pressure than biosynthesis.

These data are not sufficient to conclude that completely pressure-adapted barophilic microorganisms do not exist. Barophilic behavior, if it exists, will be related to specific carbon and energy sources and their particular metabolic pathway. Our most recent data indicate that acetate as a substrate produces results quite different from those obtained with glutamate and casamino acids. Furthermore, it should be noted that we are working with mixed natural populations. If a constant input of barotolerant microorganisms from the surface is carried down by particles to the deep-sea floor, these organisms might well outnumber and hence outcompete pressure-adapted forms. Ultimately, this question can only be solved when pure cultures of undecompressed microorganisms have been achieved.

The guts of deep-sea animals is another place to look for barophilic bacteria. The digestion of "refractory" materials in the deep sea, such as cellulose and chitin, requires the participation of microbial enzymes. This notion appears to be supported by J. A. Allen and Howard L. Sanders of the Woods Hole Oceanographic Institution, who found that some deep-sea mollusks have larger guts than their shallow-water counterparts. Over the years, however, tests for barophilic growth of microbial populations from the gut contents of deep-sea fishes, echinoderms, and crustaceans have shown the same variety of barotolerant responses as found in microorganisms from water and sediment. This is not surprising in view of the fact that a large part of the sediment's microflora may originate in the gut contents of browsing benthic animals. Again, these observations, which suggest the absence of barophilic gut bacteria, cannot be considered conclusive until studies have been conducted on undecompressed gut contents and, finally, on pure cultures.

The Deep-Sea Food Chain

Bacteria and other microorganisms easily survive long periods of starvation. Their number in nutrient-poor environments, therefore, tells little about their actual activity. Nevertheless, their presence in every drop of seawater and their potential for utilizing almost all dissolved and solid organic materials (except for some synthetic compounds) indicates their general role as decomposers. Animals, of course, contribute substantially to the processes. All organisms larger than 10 to 100 micrometers have been excluded from our studies. The reason for this is that truly quantitative studies require containment of the tracer substrate in bottles or samplers that fall through small and easily closed orifices.

We decided, therefore, to compare the results obtained in closed systems with observations on the decomposition of solid

materials in open systems — for example, those providing access to larger organisms. To this end, racks were constructed that contained compartmentalized plastic tubes filled with gelatinous media (agar, starch, gelatin). Through circular holes, they were exposed to the sediment and to the water above the sediment (Figure 6).

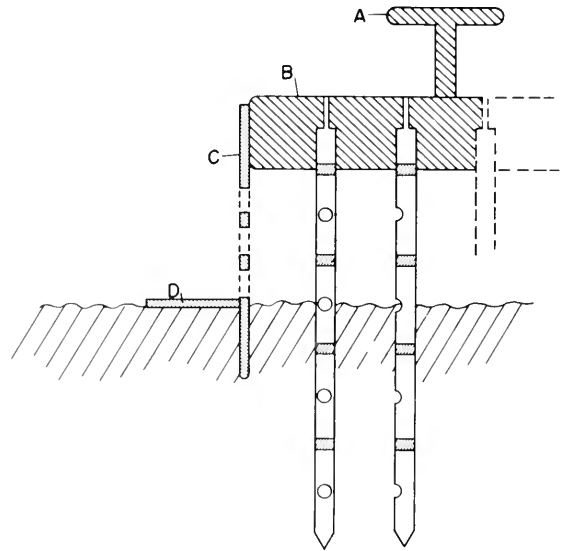

Figure 6. Sediment rack for observing microbiological activities in the top sediments. Polycarbonate tubes are mounted in a plate of inert plastic material (A, B). Each tube is sectioned into compartments with holes of 0.5-centimeter diameter, and 3.5 centimeters apart. A plexiglass cage (C) with horizontal wings (D) facilitates the accurate positioning of the tubes in relation to the sediment surface. After incubation periods of several weeks to more than a year, the content of the compartments is retrieved by Alvin and analyzed in the laboratory.

After 12 to 15 months of incubation on the deep-sea floor, bacterial colonization was observed on the exposed surfaces. Compared to shallow water controls, little microbial decomposition was noticed. This was especially true in the compartments immersed in the sediment. The materials exposed to the seawater above and at the sediment surface, however, showed extensive feeding marks of animals. Polychaete worms and small bivalves were found in several of the compartments.

At the same time, observations reported in the literature pointed to an apparent discrepancy in our quantitative data. As demonstrated in many photographic time-lapse records, fish observed by John D. Isaacs, as well as some crustaceans reported by Robert R. Hessler, both of Scripps Institution of Oceanography in California, did not appear to have any slowdown of activity with depth. These species appeared quickly after bait was placed on the ocean

floor, consuming the food within hours or days. Thus the distinct effect of pressure as observed in microbial metabolism did not appear to be directly reflected in these animals' behavior.

However, metabolic rates and the removal of food cannot easily be compared. The point made in the introduction needs to be reemphasized and extended here: microorganisms, which have no central nervous system, no complex behavior pattern, and little variation among high numbers of individuals, offer superior experimental possibilities for truly quantitative and reproducible physiological measurements.

Useful data on the in situ oxygen consumption of deep-sea fishes caught in plexiglass traps have been obtained by Kenneth L. Smith of Scripps. The rates measured were about two orders of magnitude slower than those found for fish of comparable size in shallow water. Such measurements, however, may be affected by the reactions of the test organisms to the artificial containment conditions. Sanders and J. Frederick Grassle of Woods Hole also have concluded from studies on benthic fauna that life processes are slower in the deep sea than in shallow water due to such criteria as population dynamics, low reproductive potential, and the apparent longevity of individual animals. By calculating the distribution of radioactive isotopes in the shell of an 8.4-millimeter deep-sea clam taken at a depth of 3,800 meters, Karl K. Turekian of Yale University has estimated its age at about 100 years. A comparable shallow-water clam reaches an average age of three to four years. General criteria, such as the decreasing abundance of organisms with depth, the vertical zonation of species, and the apparent absence of fishes from the deep trenches, appear to indicate effects of pressure as well as scarcity of food.

An exciting exception to this general picture is an observation made by Ruth D. Turner of Harvard University. She found that wood-boring bivalves, which depend solely on a non-marine food source, show rates of growth similar to those in shallow waters (see page 48). This was indicated by the size of individual specimens collected from wood samples. Rather than adopting a strategy of energy saving and longevity, these organisms rapidly destroy their habitat while producing enormous quantities of eggs, thus finding their rare food material in the deep sea by spreading out in large numbers of nonvegetative individuals. By analogy, the barotolerant growth characteristics of bacteria may favor the rapid production of resistant progeny instead of increased longevity for individual cells.

As long as physiological studies on higher organisms in an undecompressed state are still difficult, we can speculate that some animals may be able to overcome physiologically pressure effects in

the same fashion that warm-blooded organisms overcome the effects of low temperature. But even without such speculation, it is evident that organisms on the evolutionary scale higher than prokaryotic microorganisms have competitive advantages for life in deep-sea conditions. One example is their food-gathering capability.

What is the main food source and how does it reach the deep sea? The readily digestible parts of small particulate matter are largely removed as they sink through the water column. The most nutritional (the least decomposed) food sources reaching the deep-sea floor are assumed to be relatively large, fast-sinking chunks of organic materials, such as carcasses of larger fish or marine animals (Figure 7). Successful competition among

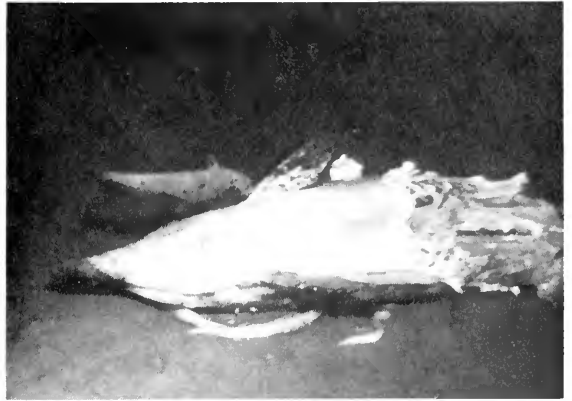

Figure 7. The carcass of a porpoise discovered during a recent dive by Alvin. This observation, although far from offering any statistical significance, supports the notion that fast-sinking chunks of organic materials, such as the remains of larger marine animals, represent a substantial source of food and energy for deep-sea populations. (Photo by C. O. Wirsen)

scavengers for this food, then, would depend upon these important traits: the sensory ability to locate the food, to move swiftly to it, and to ingest it relatively quickly. Such characteristics also require the ability to regulate energy expenditure — shifting physiologically between stages of relatively high activity and dormancy. Facing such competition, the microorganisms, excepting the gut flora, have little chance of participating in the primary stage of food consumption on the deep-sea floor. Subsequently, however, defecation spreads the organic matter to the smaller, immobile fauna embedded in the sediment, including microorganisms.

Although some of the microscopic particulate matter is compacted into fast-sinking fecal pellets by filtering zooplankters, the residence time of most such matter in the water column is fairly long. Here, the microorganisms appear to be the primary decomposers. This function includes the conversion of dissolved organic substrates,

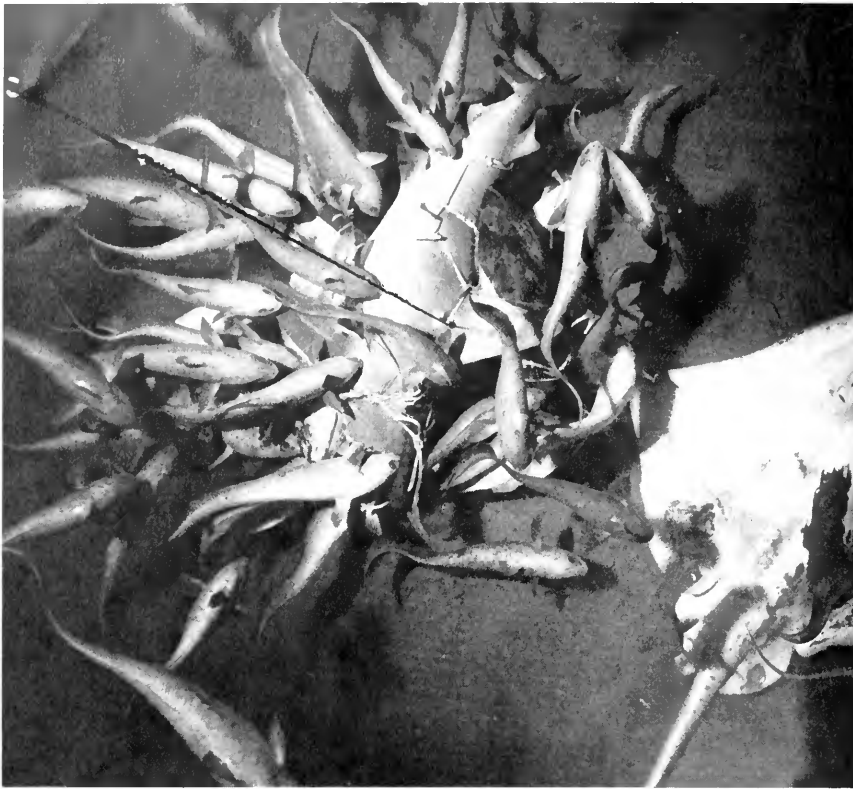

Figure 8. Two tunas and a shark that were used as bait near our permanent station DOS #2 at 3,640 meters. The picture was taken about 12 hours after the bait was dropped. Three kinds of fish can be identified: mainly grenadiers (*Coryphaenoides armatus*), a few brotulids (*Parabassogigas crassus*), and a ray (probably *Raja richardsonii*). The tunas were consumed in about 14 days by the scavengers, who only then started to feed on the carcass of the shark.

whenever present in sufficient concentration, into microbial cells (particulate food materials for the smallest multicellular organisms in the food chain). One prokaryotic trait will always ensure that microorganisms are present in substantial numbers: their ability to form long-lasting survival stages and to turn quickly into active vegetative cells whenever a food source becomes available.

In the summer of 1976, Gilbert T. Rowe of Woods Hole dropped a sizable fish sample (two tunas and one large shark) for us near our bottom station No. 2 about 200 miles south of Nantucket at a depth of 3,640 meters. A recoverable camera, designed by Harold E. Edgerton of the Massachusetts Institute of Technology, was attached, taking pictures every 30 minutes for 16 days.

Nine days after deployment, the fish sample was located by *Alvin*. Both tunas were half eaten, but the shark was untouched. A fair number of rattail fishes, or grenadiers, were observed in the vicinity, but none were actively feeding. We learned later from photographs taken by the automated camera (Figure 8) that many fish had left the scene during our visit. Only a few small amphipods were observed; it is possible that their number was kept low by the fish. An amphipod trap, baited with radioactive fish meat, was put on the bottom to measure metabolic turnover rates of these animals as well as their bacterial gut flora during short-term in situ incubations (Figure 9).

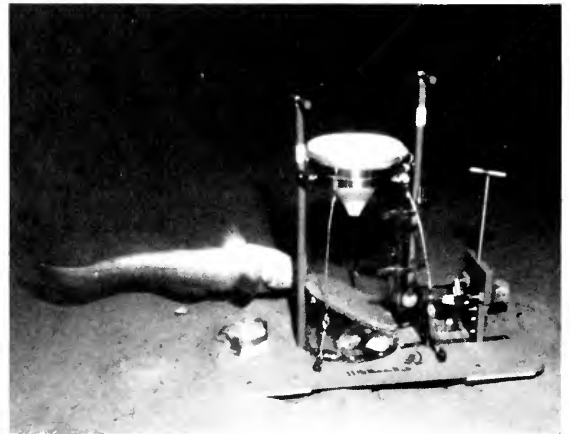

Figure 9. Trap for small crustaceans, mainly amphipods, deployed by *Alvin* at 1,800 meters (DOS #1). It is designed to permit the measurement of feeding rates on radioactively-labeled fish meat during a given time period.

The Galápagos Discovery

In the introduction, the generalization was made that the deep-sea microorganisms and animals depend on organic food materials produced by photosynthesis in surface waters. The implication was that benthic populations become scarcer with depth. A striking exception to this rule was discovered recently during dives by *Alvin* in the

Galápagos Rift area (see *Oceanus*, Summer, 1977). At a depth of 2,700 meters, copious populations of largely sessile organisms were found clustered around warm water vents on the sea floor.

The riddle appeared to be solved by the observation of “milky-blue” water extruding from the vents. This indicates the presence of hydrogen sulfide being oxidized to colloidal and particulate elemental sulfur in the presence of dissolved oxygen. The energy liberated by this oxidation can be used in the metabolism of certain bacteria to incorporate carbon dioxide into cell material — in other words, to grow. The bacterial biomass is then ingested by filtering organisms, eventually leading up the food chain to clusters of large clams, tube worms, limpets, and so on.

These sulfide-oxidizing bacteria have a plant-like metabolism but live “chemosynthetically” instead of photosynthetically. They are common in estuaries and other environments where sulfide is largely a product of sulfate reduction, a process carried out by another group of bacteria. In the deep sea, however, the sulfide appears to be a product of geothermal energy.

The mere thermocirculation of water above the vents has been advanced as an alternative, but less likely, explanation for the aggregations of organisms in the otherwise barren environment. Plans are underway to return to the Galápagos vents in January of 1979.

A Look Ahead

In the meantime, a number of problems will be studied in the laboratory. Ultimately, undecompressed deep-sea microorganisms have to be grown in pure culture. It will be a formidable technical task to isolate and cultivate organisms that have never gone through a decompression/recompression cycle. Samples not only have to be retrieved from the deep sea under pressure, but also have to be streaked out on agar plates and transferred to new media several times in a window-equipped chamber holding pressures of 600 atmospheres, or more. Despite the technical difficulties, we have good reason to believe that this can be accomplished.

Pure cultures of undecompressed deep-sea bacteria will enable us to obtain conclusive answers as to the physiological and biochemical nature of barotolerance and, perhaps, barophilism in prokaryotic organisms. Large, deep-sea aquaria will later be necessary to study the metabolism and behavior of higher, eukaryotic forms of life — from invertebrates to fishes.

Holger W. Jannasch is a Senior Scientist in the Biology Department, Woods Hole Oceanographic Institution.

Literature

- Brauer, R.W., ed. 1972. *Barobiology and the experimental biology of the deep sea*. North Carolina Sea Grant Program, School of Public Health, University of North Carolina.
- Jannasch, H.W., K. Eimhjellen, C.O. Wirsen, and A. Farmanfarmaian. 1971. Microbial degradation of organic matter in the deep sea. *Science* 171: 672-75.
- Jannasch, H.W., and C.O. Wirsen. 1973. Deep-sea microorganisms: in situ response to nutrient enrichment. *Science* 180: 641-43.
- Jannasch, H.W., C.O. Wirsen, and C.D. Taylor. 1976. Undecompressed microbial populations from the deep sea. *Appl. Environ. Microbiol.* 32: 360-67.
- Jannasch, H.W., and C.O. Wirsen. 1977a. Microbial life in the deep sea. *Sci. Am.* 236: 42-52.
- — — 1977b. Retrieval of concentrated and undecompressed microbial populations from the deep sea. *Appl. Environ. Microbiol.* 33: 642-46.
- Wirsen, C.O., and H.W. Jannasch. 1975. Activity of marine psychrophilic bacteria at elevated hydrostatic pressures and low temperatures. *Mar. Biol.* 31: 201-8.

Abyssal Stars, Urchins, Cucumbers (Holothurians)

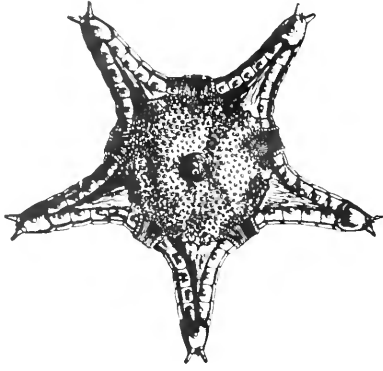

A short-armed starfish
(*Porcellanaster*).

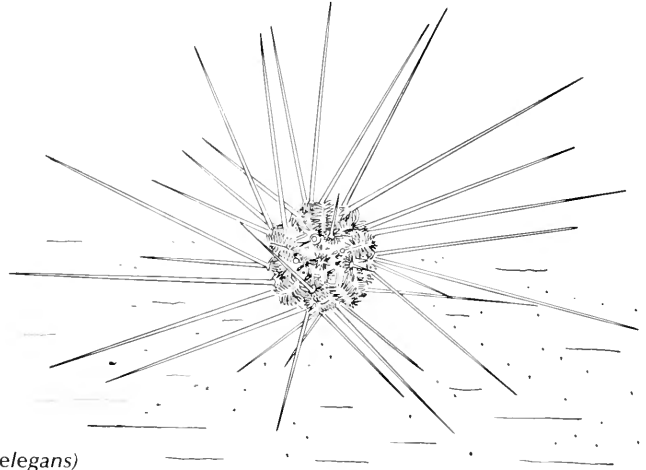

Regular (U, *Porocidaris elegans*)
and irregular (L, *Pourtalesia hispida*)
sea urchins.

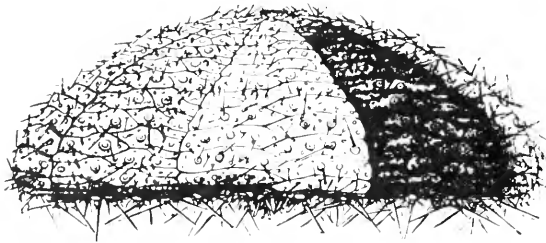

A large urchin
(*Phormosoma uranus*).

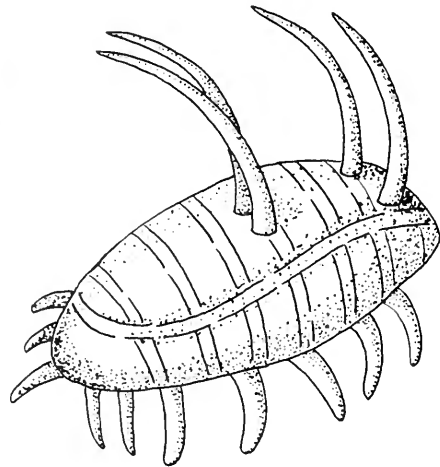

Holothurian
(Order *Elasipoda*).

Giant holothurian grazer
that can reach half a
meter in length. Mouth
is at left. (*Psychropotes*)

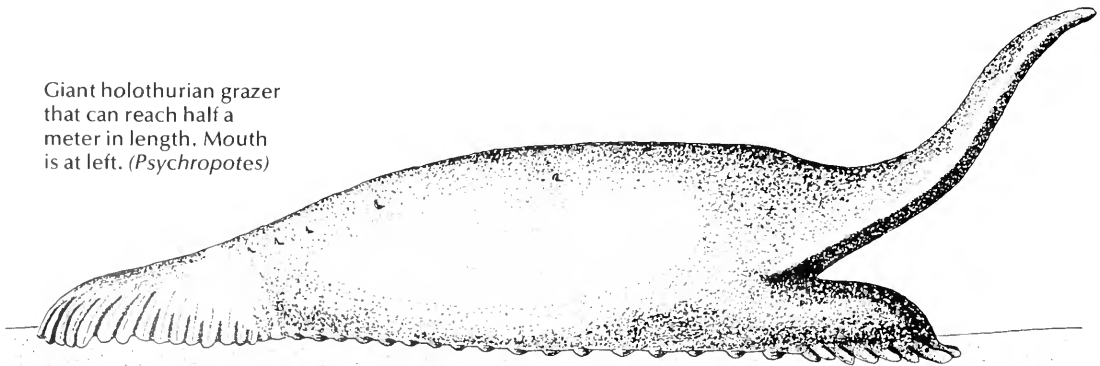

Crustaceans, Spiders, and Fish



The sea spider
(*Colossendeis colosseae*).

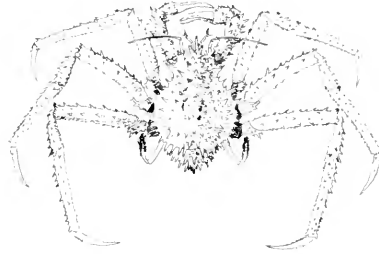

Crab (*Lithodes agassizii*).

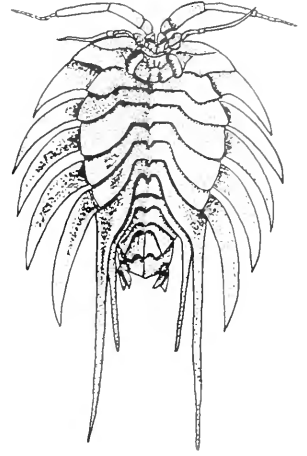

Giant isopod
(*Serolis*).

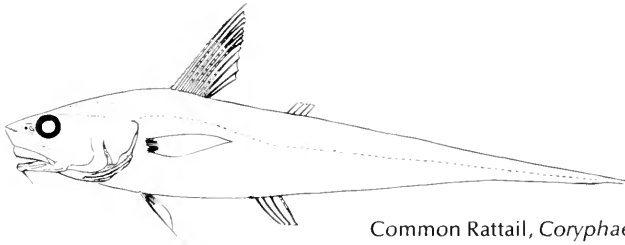

Common Rattail, *Coryphaenoides armatus*.

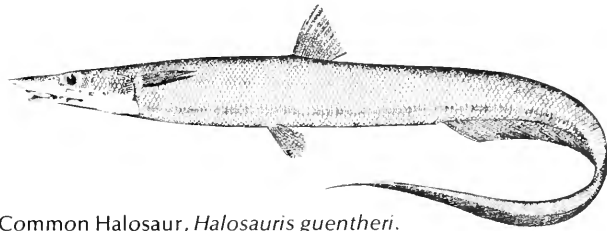

Common Halosaur, *Halosaurus guentheri*.
(From Goode and Bean)

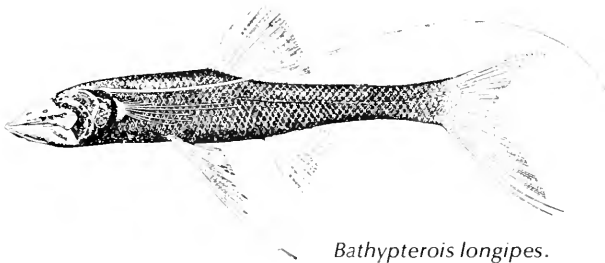

Bathypterois longipes.

Representative selection
by Charles D. Hollister
and Richard L. Haedrich.

Drawings (not to scale) by
Hester Haring, N.B. Marshall (Rattail), and
Margaret G. Bradbury (*Bathypterois*).

The fish sketches are courtesy of
The Sears Foundation, Yale University.

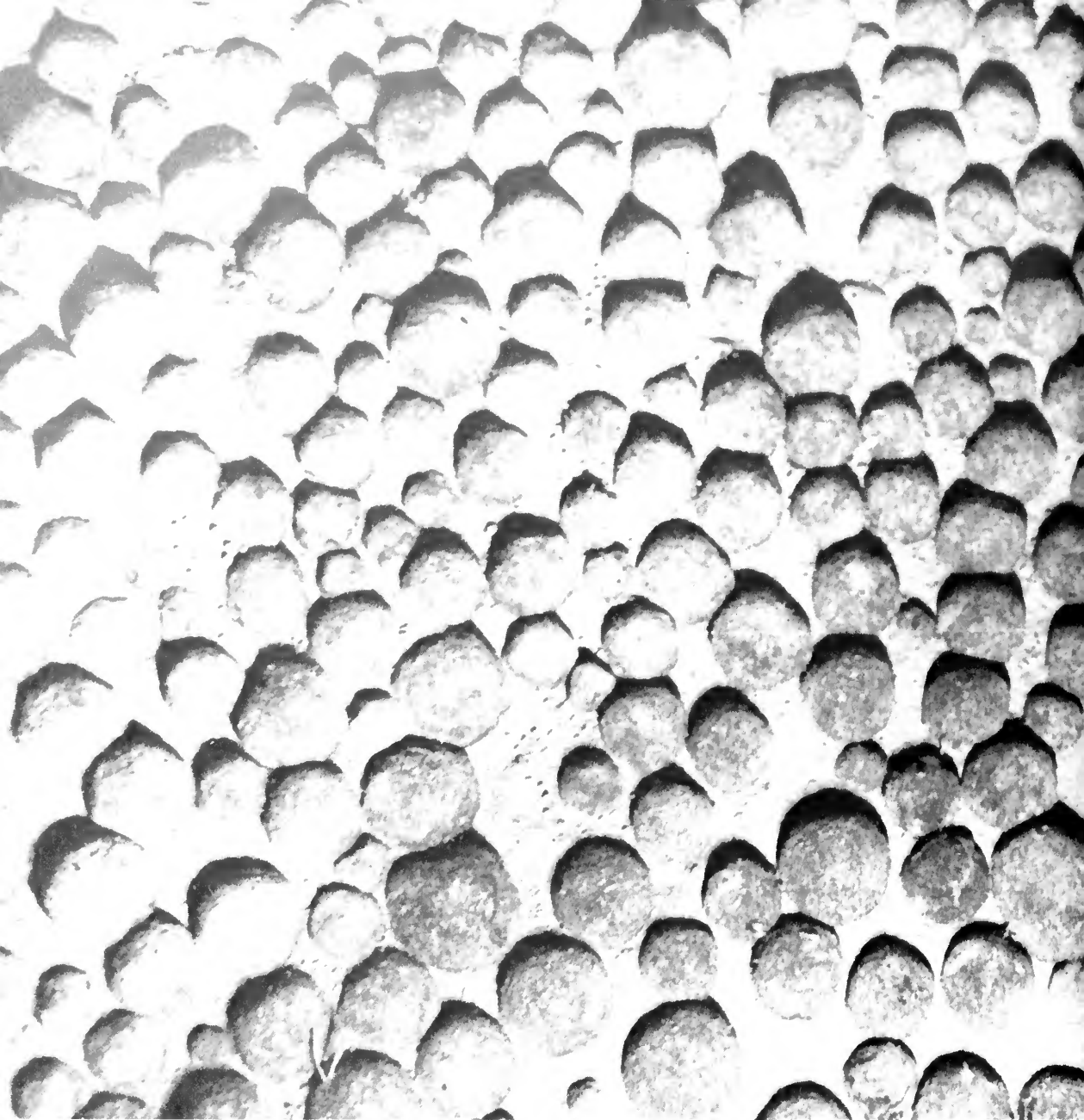

Deep-Sea Manganese Nodules

by G. Ross Heath

Potato-like manganese (or, more correctly, ferromanganese) nodules from the deep-sea floor have been studied in detail for more than a century. In fact, nodules collected from *HMS Challenger* during the first great oceanographic expedition from 1872 to 1876 are still studied by modern geochemists.

Manganese nodules are golf-ball to fist-sized dark brown objects that are found over much of the floor of the oceans. The most attractive ones are almost spherical, but they come in shapes ranging

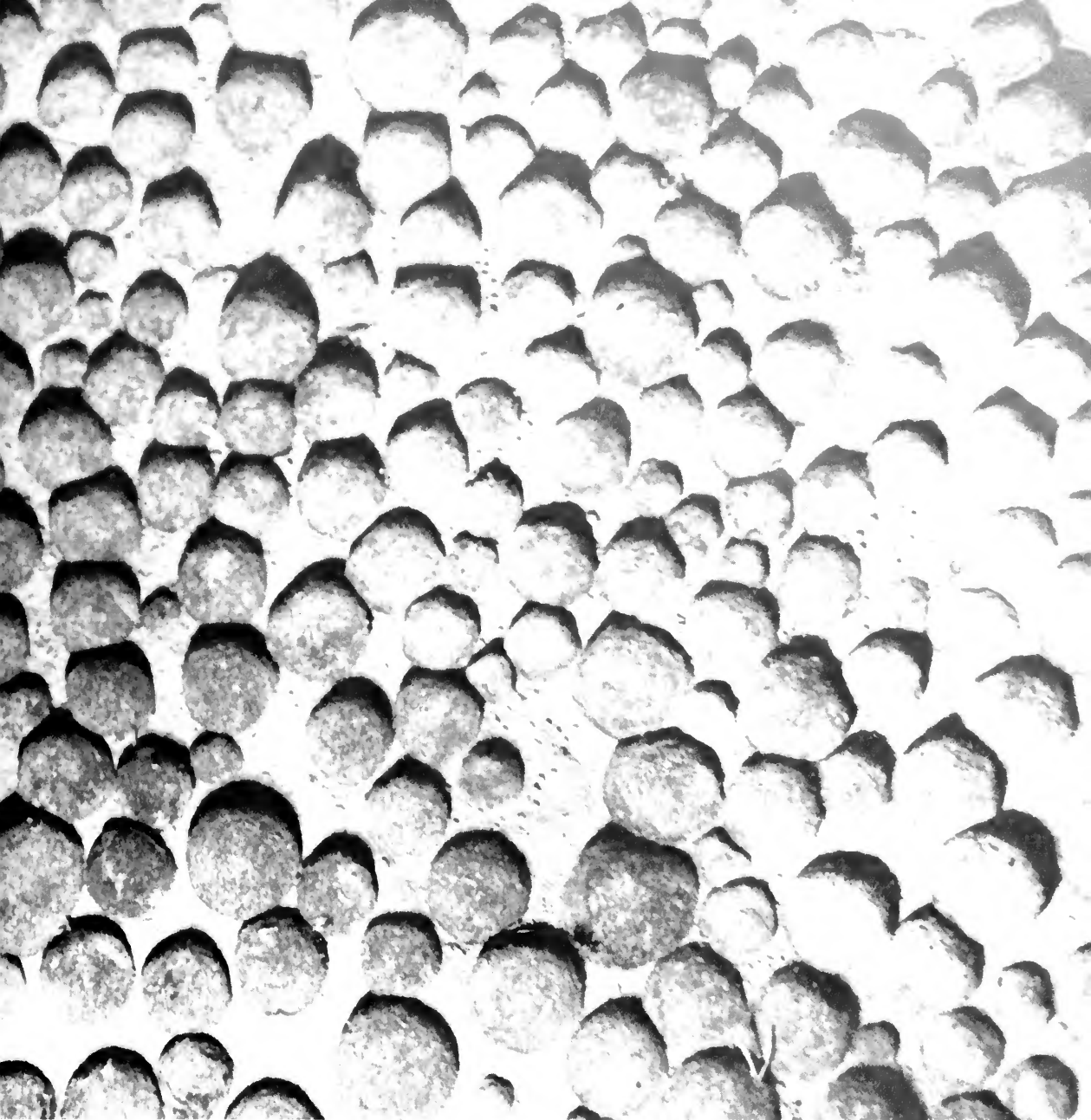

Figure 1. Dense coverage of manganese nodules at 5,487 meters water depth in the South Pacific at 36°37'S, 149°00'W. (Lamont-Doherty Geological Observatory station C9-67, photo 13. Photo duplicated and reversed at left.)

from discs to irregular lumps. Occasionally, the nodules almost totally cover the sea floor (Figure 1), but they are usually separated by a few centimeters. The observed surface abundance in the deep sea ranges from 0 to about 30 kilograms per square meter.

The great geochemical and economic interest of the nodules lies in their unusual compositions. They are rich in iron and manganese, and to a lesser extent in copper, nickel, and cobalt (Table 1). In contrast, they are relatively poor in

silicon and aluminum, the elements that make up most of both the sediments upon which the nodules lie, and continental and oceanic rocks.

Scientists who study deep-sea sediments have long been challenged by questions like:

- *Why are nodules found in some areas, but not in others?*
- *Where do the metals come from?*
- *Why do nodules from different locations have different compositions?*

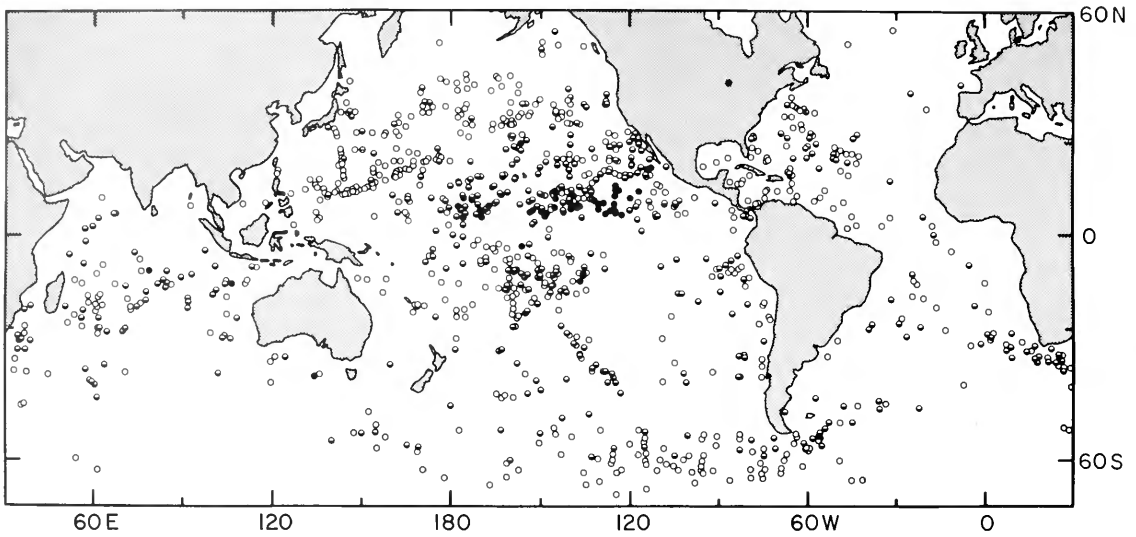

Figure 2. Global distribution of manganese nodules. Filled circles are analyzed nodules containing more than 1 percent copper. Half-filled circles are analyzed nodules containing less than 1 percent copper. Open circles are nodules for which analyses are not available.

- Why are nodules concentrated at the sea floor, rather than buried in the sediments?

Our present knowledge and ignorance of the answers to these questions are summarized in the following pages.

Why are nodules found in some areas, but not in others?

Figure 2 shows that nodules have been collected from the equator to high latitudes in all the oceans. Yet they are less common in certain regions. They are rarely found close to land, where sediments carried from the continents accumulate rapidly. Similarly, nodules are rare on the "drift" deposits that cover much of the Atlantic (see page 5), or on the carbonate oozes that underlie biologically productive surface waters (along the equator, for example). Finally, nodules are rare at mid-ocean ridges, where sediments are thin and new crust is forming by widespread volcanic activity (see *Oceanus*, Winter 1973).

Table 1: Compositions of ferromanganese deposits (weight percentages).

	World average	Abyssal nodules	Metal-rich Pacific nodules
Silicon	8.6	—	7.3
Aluminum	3.1	—	2.9
Manganese	16.2	16.8	28.1
Iron	15.6	17.3	6.2
Nickel	0.49	0.54	1.49
Copper	0.26	0.37	1.17
Cobalt	0.30	0.26	0.22

In general, nodules lie in the deeper parts of the ocean basins on sediments that are accumulating very slowly (a few millimeters per thousand years at most), and that are oxidized (most of the iron is in the form of red-brown oxides combined with water; much like ordinary rust).

Where do the metals come from?

Manganese and iron are continually being supplied to the ocean by rivers, by submarine hot springs (recently observed near the Galápagos Islands by the Woods Hole submersible *Alvin*, for example), and by upward leakage from reduced sediments rich in organic carbon. At the same time, the pathways for metals leaving seawater include precipitation onto exposed surfaces (either suspended sediment particles, or the sea floor), and uptake by oceanic plants and animals to satisfy their metabolic needs, or as an incidental accompaniment to their feeding. Every surface at the sea floor, whether it be volcanic rock, seashells, or man's garbage, eventually receives its ferromanganese crust. It is not too surprising, therefore, that nodules at the sea floor just keep growing. The continuation of this process for millennia helps produce the striking concentric layers that often are revealed when nodules are sawn in half and the sawn surfaces polished (Figure 3). Some of the layers result from recrystallization of minerals in the nodules, whereas others may mark changes in the oceanographic conditions around the nodules during the millions of years that they have been growing.

At present, we believe that most of the iron and manganese in nodules precipitate inorganically

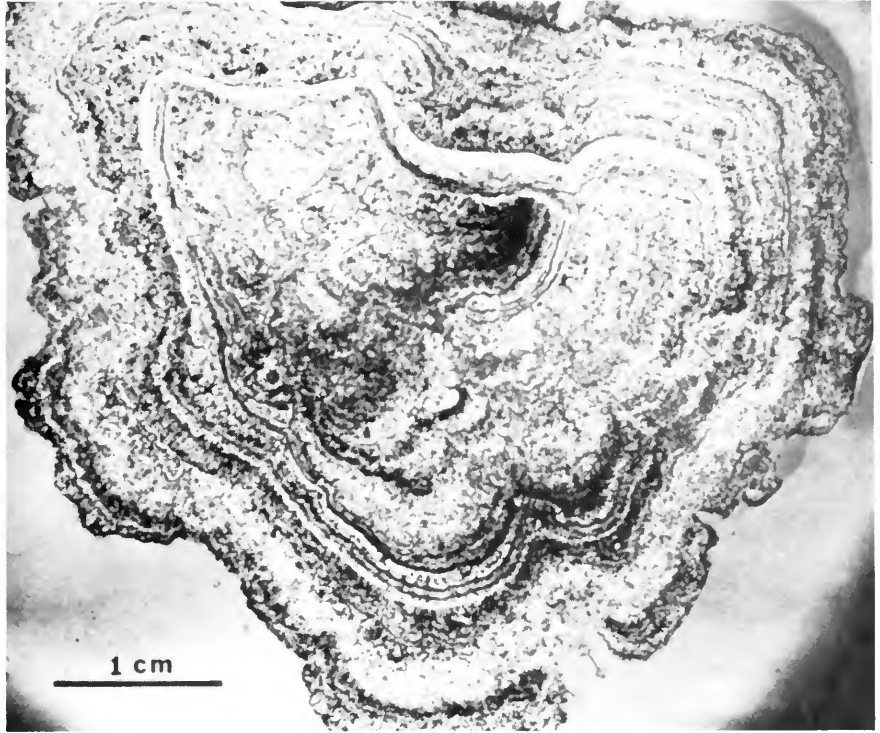

Figure 3. Sliced and polished section through an eastern North Pacific nodule, showing internal layering. (Photo by R. K. Sorem, Washington State University)

from seawater, but that metals like copper and nickel are carried to the sea floor in the remains of dead marine plants and animals. Bacteria capable of extracting manganese from seawater have been found on deep-sea nodules, but we do not yet know whether such bacteria actually contribute to the growth of nodules or influence their compositions.

Why do nodules from different locations have different compositions?

This is, perhaps, the most controversial outstanding question about nodules. If we knew the answer, we could pinpoint the locations of economically attractive nodules rich in copper and nickel much more reliably than we can now. We also would have a much clearer understanding of the processes that control the concentrations of many of the metals that are dissolved in the oceans.

The proposed answers to this question can be separated into four major groups:

1. Depending on conditions at the sea floor (temperature, pressure, nature of the sediments), iron and manganese precipitate in different areas as different compounds or minerals. Some of these (a manganese mineral called todorokite, for example) readily incorporate copper, nickel, and similar metals, whereas others do not.

It is not yet clear, however, whether the high copper and nickel concentrations result from

the presence of todorokite, or are responsible for its formation or stabilization in the first place. Research is underway to solve this question and to better define the conditions that lead to the crystallization of different manganese and iron minerals.

2. The surface waters in certain regions of the oceans support abundant plant and animal life. Some of the plants and animals concentrate economically valuable metals in their protoplasm. When the remains of these organisms fall to the sea floor and decay, the metals are released and are taken up by manganese nodules. Some scientists have suggested that the transfer is aided by small animals who live and build tubes and shelters on the surfaces of nodules. Advocates of this theory point to the abundance of nodules rich in copper and nickel southeast of Hawaii, beneath the fringes of the biologically productive waters of the equatorial Pacific. The question as to why nodules beneath equally productive waters elsewhere in the oceans are not rich in the same metals remains unanswered.

3. The recent discovery by scientists in the research submersible *Alvin* of hot seawater rich in manganese escaping from volcanic rocks on the sea floor (see *Oceanus*, p. 35, Summer 1977) renews the suggestion that global differences

in the composition of nodules result from the input of differing quantities and compositions of hydrothermal solutions from nearby volcanic sources. There is little question that the circulation of seawater through newly formed volcanic rocks is an important source of dissolved metals for the ocean. However, our knowledge of patterns of submarine volcanism and of the circulation of deep ocean waters lends little support to the idea that hydrothermal solutions are directly responsible for the observed variations in nodule compositions.

4. Several years ago, W. Raab, of Kennecott Exploration, Inc., determined that the tops of nodules, which are exposed to seawater, differed in composition from the bottoms, which are surrounded by sediment. Raab's data, supported by later analyses, show that manganese, copper, and nickel, for example, are concentrated on the bottoms of nodules, whereas iron, cobalt, and lead are more prevalent on the tops. Such a pattern suggests that the uptake of the first group of metals is in some way enhanced by the sediments. The simplest explanation is that metals dissolve in the sediments and are taken up by the nodules. It also is possible, however, that chemical conditions within the sediments (such as acidity, availability of oxygen, or bacterial activity) lead to the growth of todorokite or other minerals favoring the uptake of copper and nickel from normal bottom and shallow pore waters.

The close relationship between sediment type and presence or absence of nodules, discussed previously, as well as the association of nodules rich in nickel and copper (Figure 2) with clayey sediments containing abundant microscopic shells of radiolarians (Figure 4), leaves little doubt as to the influence of sediment properties on nodule formation.

Much less clear, however, are the exact mechanisms by which sediments affect nodule compositions.

The preceding discussion suggests that we would be much closer to understanding variations in the composition of nodules if we knew:

- *The composition and quantity of particles falling to the sea floor, and the ways in which they are altered when they get there.*
- *The composition of bottom and pore waters, and the rate at which dissolved metals move between the two.*
- *The relative proportions of metals incorporated in nodules and sediments, and the way these proportions vary with depth in both.*

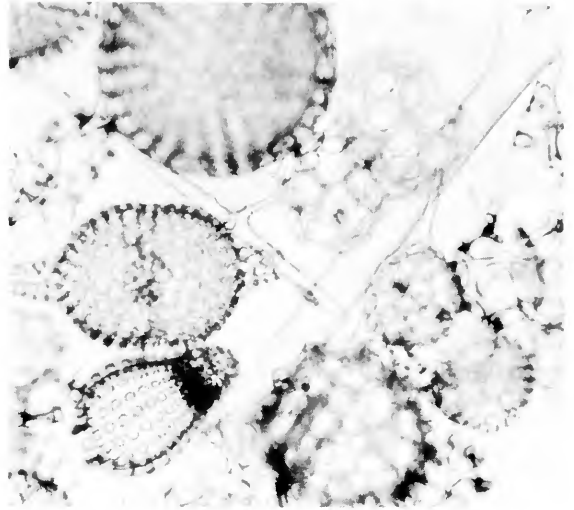

Figure 4. Radiolarian ooze from the North Pacific region of copper- and nickel-rich nodules. Individual shells are $\frac{1}{4}$ to $\frac{1}{6}$ millimeter across. (Courtesy T. C. Moore, Jr., University of Rhode Island)

- *The role of different iron and manganese oxides and hydroxides in determining the abundance of trace metals (copper, nickel, and so on) in nodules.*
- *The role of bacteria in precipitating or mobilizing manganese and other metals of interest at the sea floor.*

An effort to learn more about these questions is being coordinated through MANOP (Manganese Nodule Project), a research program on manganese nodules which began early in 1977 and is supported by the National Science Foundation's International Decade of Ocean Exploration. MANOP personnel will use sediment traps (see page 20) to catch particles falling to the sea floor, and they are building a Bottom Lander (Figure 5) to carry out experiments there. The Lander will sample metals released from the sediments; add antibiotics and other poisons to selected chambers (to distinguish the roles of living and non-living processes); and introduce tiny amounts of radioactive forms of dissolved metals to follow their uptake by nodules and sediments. The MANOP Bottom Lander will be used in several different deep-sea environments characterized by nodules of a wide range of compositions. The results should allow us to eliminate some of the ideas presented here, and focus on the major processes that lead to mineable nodules in one place, and worthless deposits in another.

Why are nodules concentrated at the sea floor, rather than buried in the sediments?

From studying the large number of sediment cores in the collections of Scripps Institution of



Sharks' teeth and teeth of other fish commonly form a nucleus for growth of manganese nodules. Any hard object, such as a rock or bones of a whale, can serve as the nucleus, though in many cases, no identifiable nucleus is found. The composition of the nodules is apparently unaffected by the chemical nature of the nucleus.

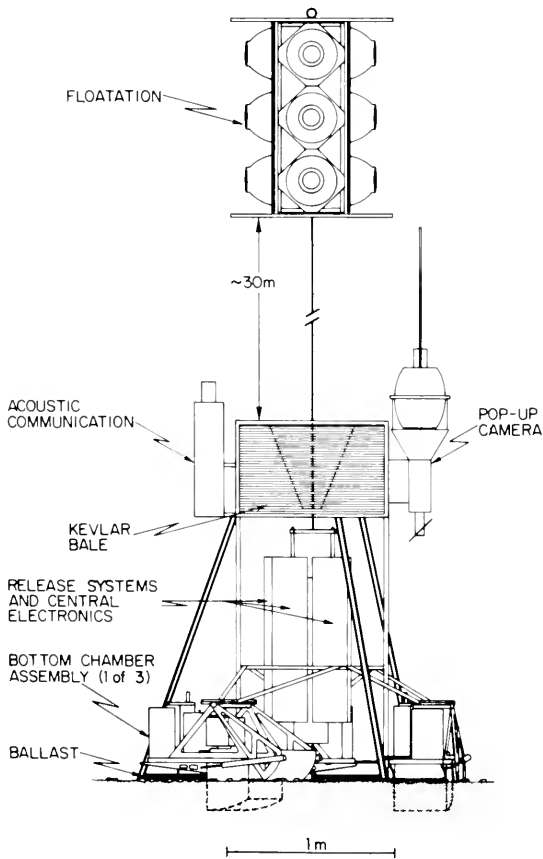

Figure 5. MANOP Bottom Lander designed to carry out geochemical experiments on the sea floor to learn how nodules form and why they have a range of compositions. (Courtesy R. F. Weiss, O. H. Kirsten, and R. Ackermann, Scripps Institution of Oceanography)

Oceanography in California and Lamont-Doherty Geological Observatory at Columbia University in New York, it appears that the abundance of manganese nodules at the sea floor is about equal to the abundance of buried nodules in the top 3 to 5 meters of sediment (Figure 6). The growth rates of many deep-sea nodules have been determined by radioactive dating of successively deeper ferromanganese layers and of the volcanic rock cores that lie at the centers of some nodules. These growth rates usually are a few millimeters per million years — about a thousand times slower than the accumulation rates of the associated sediments. Thus the vertical separation of nodules in deep-sea sediments should be about a thousand times their diameters. This is roughly what we see in the core data. Clearly, then, the question is not “why are there so few buried nodules?” but rather “why are there so many nodules at the surface?”

This question has long taxed the imaginations of marine geologists. Numerous physical and chemical explanations have been proposed, including flotation of the nodules on the soup-like surface sediment by earthquake shaking, rolling of nodules downhill, or continuous dissolution of buried nodules to feed new ones growing at the sea floor. None of these fit the facts, however — the first two processes tend to bury nodules, whereas the third is not consistent with their observed growth rates. Almost by default, we are obliged to seek a biological explanation. The discovery of large foragers on the sea floor (see *Oceanus*, p. 41, Winter 1977), who could easily roll a nodule while searching beneath it for food, as well as small animals who keep the tops of nodules clean by eating the sediment (Figure 7) support the view that the benthic community works quietly away to

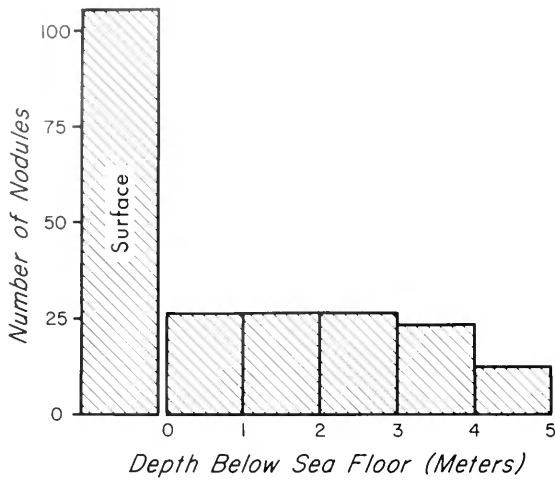

Figure 6. Relative abundances of sea floor and buried nodules, based on sediment cores from Lamont-Doherty Geological Observatory and Scripps Institution of Oceanography.

the benefit of the marine geologist and sea-floor miner. We have never actually photographed or observed an animal rolling a nodule. This is not surprising, however, since each nodule need only be rolled every thousand years or so at most. Nevertheless, we hope to record such an event by time-lapse photography of large fields of nodules for periods of many months. Such direct evidence would resolve many arguments and end a long period of speculation.

Photographs of the sea floor, such as Figure 1, often give the impression that the nodules are extremely uniform in size and shape. This is sometimes true, particularly when the nodules lie

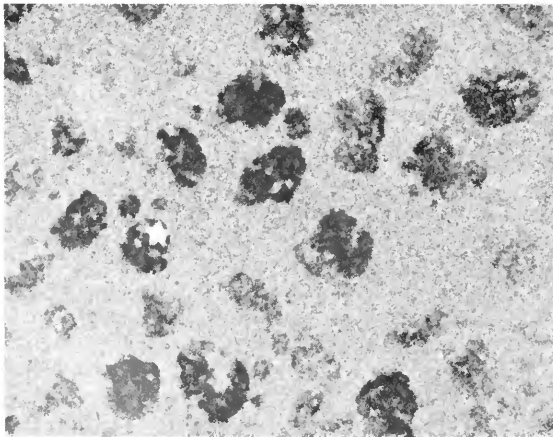

Figure 7. Small starfish feeding on sediment on top of a North Pacific manganese nodule. Such feeders probably help keep nodules from being buried by the continuous rain of fine sediment. (Courtesy A. Paul, Lamont-Doherty Geological Observatory)

on a pavement that is kept free of sediment by strong bottom currents. Presumably such nodules began to grow simultaneously when the pavement was formed. More commonly, however, bottom samplers show that a range of nodule sizes coexist. Figure 8, which shows both a bottom photograph and the nodules recovered by a free-fall grab at a station in the southwest Pacific, illustrates this case. Such a range of sizes suggests that new nodules continually form and keep growing until they are accidentally buried or become too large for foragers to turn over.

Finally, a few thoughts on the economic and legal aspects of manganese nodules. At the present time, four or five large international consortia (Table 2) are assessing the feasibility of commercially mining nodules for copper, nickel, and cobalt. One group (Deepsea Ventures) has laid claim to an area of the eastern Pacific and has even constructed a vessel for test mining. Thus there can be little doubt that serious nodule mining is less than a decade away. Because of the enormous capital cost of such mining operations, they will have to process 1 to 4 million tons of nodules per year to make money.

Table 2: Seabed mining consortia.

Deepsea Ventures Group	
U.S. Steel	USA
Union Minière	Belgium
Sun Oil	USA
Kennecott Group	
Kennecott Copper	USA
Rio Tinto - Zinc	UK
Consolidated Gold Fields	UK
Noranda Mines	Canada
Mitsubishi	Japan
British Petroleum	UK
Ocean Management Group	
International Nickel	Canada
AMR (Metallgesellschaft, Preussag, Rheinische Braunkohlenwerke und Salzgitter)	Germany
Domco (Sumitomo, Nippon Mining, Dowa Mining and others)	Japan
Sedco	USA
Lockheed Group	
Lockheed Missiles and Space	USA
Standard Oil of Indiana	USA
Royal Dutch Shell	USA/Holland
One other not yet announced	USA
Afernod	
CNEXO	France
Le Nickel	France

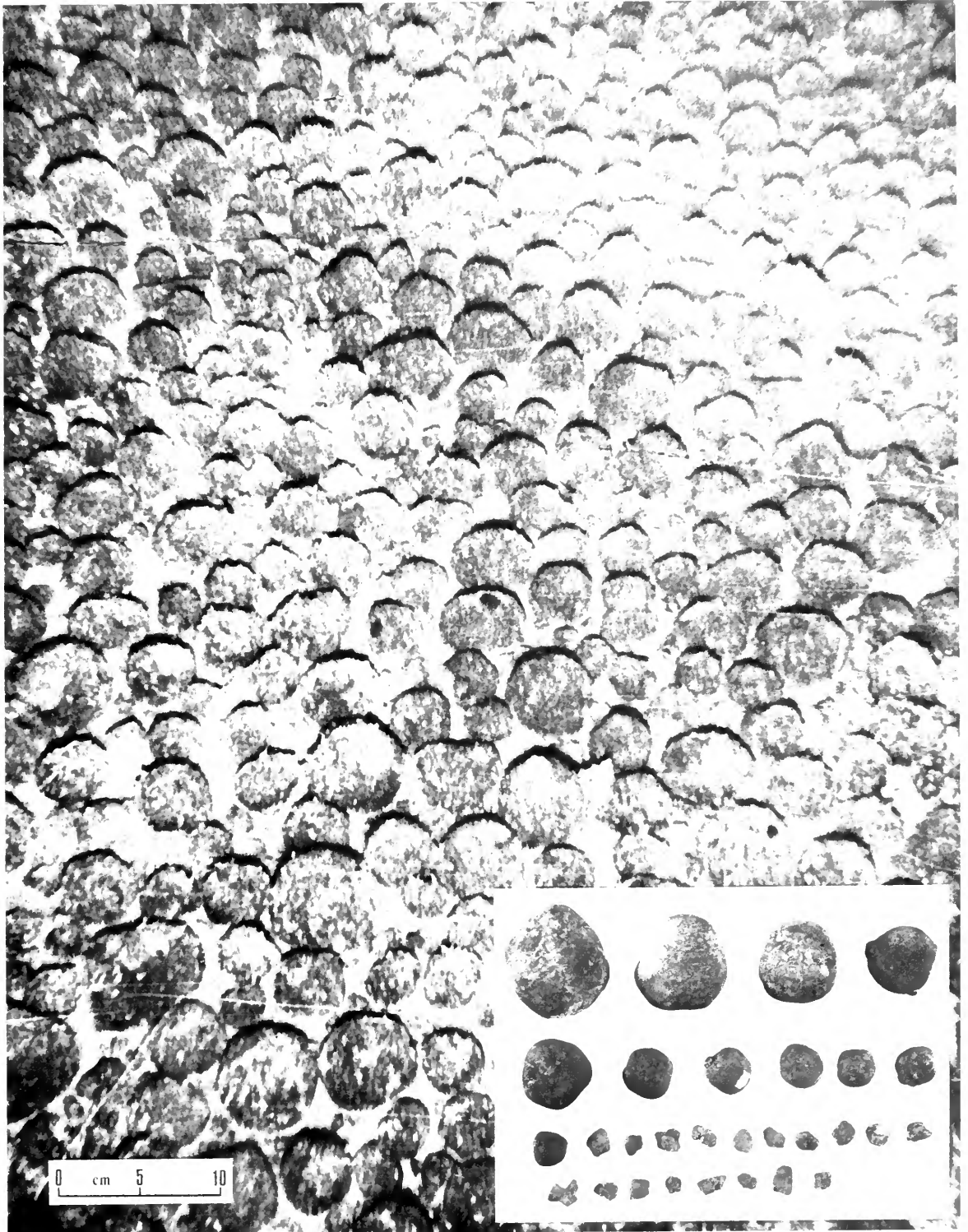

Figure 8. Comparison of recovered South Pacific nodules with bottom photograph taken at the same location. Photograph tends to underestimate small nodules. (From South Pacific Marine Geological Notes, "Manganese Nodules from the South Penrhyn Basin, Southeast Pacific," by C. W. Landmesser and co-workers)

In anticipation of such activity, the National Oceanic and Atmospheric Administration has begun studies of possible environmental effects at three sites within the Pacific band of copper-rich nodules shown in Figure 2. These DOMES (Deep Ocean Mining Environmental Study) sites lie between 8°N, 152°W and 15°N, 126°W.

The results to date suggest that mining will affect the ocean floor in a fashion analogous to the way that "clear cutting" affects forests in the western United States. The ecology of the area that is actually mined (or clear-cut) is severely disturbed, but as long as the exploited area is a small fraction of a particular region of the deep-sea floor (or forest), the larger community is not noticeably harmed. Similarly, it appears that sediment brought to the surface by the miners will rapidly settle back to the abyss, producing little effect on surface biological activity other than a minor (relative to the natural circulation) input of growth-producing nutrients.

Clearly, these preliminary studies have left many questions unanswered. We need to determine the rate at which mining can safely proceed over periods of centuries, as well as the rate at which the ecology of a mined area recovers, and the long-term biological effects of mixing deep- and shallow-living microorganisms. At present, however, it appears that deep-sea mining is ecologically no more harmful than equivalent enlightened mining activities on land.

Oceanographic research has already made an important contribution to the first phase of deep-ocean mining, both in outlining the extent of the resource and in environmental studies. Ongoing research will undoubtedly be of some economic value to the miners, but will be much more valuable in assessing the global magnitude of the resource.

While studies of the feasibility of deep-sea mining have been going on, some Law of the Sea negotiators have been advocating the establishment of an International Seabed Authority to oversee the exploitation of the sea floor beyond the limits of national jurisdiction. Such an Authority would handle mining claims, would receive royalties from mining consortia, would ensure that seabed mining does not endanger terrestrial producers of copper, nickel, and cobalt, and might even mine nodules itself. Such an Authority would be a mixed blessing to the mining consortia. On the one hand, it would allow claims to be registered and protected in an orderly way, which is not possible at present. On the other hand, however, it would subject miners to a set of regulations and controls that would undoubtedly complicate their operations and might well destroy the economic viability of nodule mining.

A disturbing suggestion that has recently emerged during discussions of the role of the International Seabed Authority is that it also be

responsible for regulating scientific research on the international seabed (see page 69). Given that the results of scientific research are available to all countries of the world, and are not of great immediate economic value in any case, it is difficult to see any reason for such regulation. It will be a sad day for marine science if we cannot take the next major steps toward understanding the formation and composition of manganese nodules because we become entangled in the bureaucratic web of an international body that really has no reason for concerning itself with basic research.

G. Ross Heath is a Professor in the Graduate School of Oceanography at the University of Rhode Island, Narragansett. He is also Director of MANOP, the National Science Foundation/DOE Manganese Nodule Program.

Threat to the Freedom of Scientific Research in the Deep Sea?

by David A. Ross

Since the beginning of oceanography, scientific research in the deep sea has been free of political constraints. Today, the situation may be changing, thanks at least in part to the fruits of that research.

The research vessel Knorr of the Woods Hole Oceanographic Institution outside the United Nations building in New York City.



Ironically, scientific work on manganese nodules (see page 60) and other resources has helped to focus economic attention on the abyss. The implications can be serious for both science and society.

To see how the problem has developed, we must go back a few decades. Until the end of World War II, it was generally accepted that a coastal nation could claim sovereignty only over those waters adjacent to its coast out to a distance of three nautical miles — the so-called territorial sea. In the mid-1940s, the United States claimed jurisdiction over the resources on its continental shelf, an area considerably larger than the territorial zone. Washington reasoned that since the continental shelf was a natural extension of the land, the resources of the shelf (petroleum was the main concern) were Federal property. Seaward expansion began in earnest as country after country extended the width of their territorial seas or made exclusive claims for fishing or other economic activities offshore.

In an attempt to impose some measure of moderation and standardization on these unilateral actions, two international meetings — the First and Second Law of the Sea Conferences — were held in Geneva in 1958 and 1960. Freedom of scientific research survived these deliberations in fairly good shape. There were a few restrictions within territorial seas, mostly involving prior permission by the appropriate coastal state. (The maximum width of the territorial sea was left in question; though the United States continued to observe the three-mile limit, other states thought in terms of 12 nautical miles.) In the waters beyond — the high seas — several basic freedoms were defined in a convention adopted by the 1958 Geneva Conference: navigation, fishing, overflights, and pipeline and cable laying. Though no specific mention was made of scientific research, freedom to conduct such work on the high seas was generally accepted as a basic right of individual nations.

In the years following the 1958 and 1960 Conferences, the expansion of territorial claims continued. By 1977, more than 27 states had declared territorial seas of more than 12 miles (Table 1), and most had adopted the 12-mile limit. During this period, the developing and less-developed countries of the world were awakening to the potential of the vast mineral and biological resources of the ocean. In 1967, Ambassador Arvid Pardo of Malta made an eloquent plea to the United Nations that the resources of the ocean should become "the common heritage of mankind." Within a decade, this noble thought was to become a hollow dream, as coastal countries pushed their claims of sovereignty farther and farther seaward. These pressures led to the Third Law of the Sea Conference, convened in 1973; it has met yearly since then. One result of these meetings and

Table 1: Changes in territorial sea claims (1973-1977).

Breadth (Nautical miles)	Number of Countries		
	1973	1975	1977 (Sept.)
3	25	30	26
4	4	4	4
6	11	13	8
10	1	1	1
12	54	57	60
15	1	0	1
18	1	1	0
20	0	0	1
30	3	4	3
50	1	3	4
100	0	1	2
130	1	1	0
150	0	1	2
200	10	9	14
Modified archipelago	0	3	3
No legislation	6	1	1
Greater than 12 nautical miles	17	20	27

Source: U.S. State Department reports.

negotiations (believed by many to be the most complex ever held) is that coastal States will gain control over what is called the Exclusive Economic Zone (EEZ) that extends seaward for at least 200 nautical miles off the coastal State. The distance can be even wider if the original 200 miles does not include the entire continental margin (continental shelf, continental slope, and continental rise — a region surprisingly renamed by the conference participants as the continental shelf). Within the EEZ, the coastal State will have clear control over the scientific research proposed by another country. It should be emphasized that the EEZ contains a large portion of what was previously defined as high seas; it covers more than 35 percent of the ocean. These extended claims have already presented considerable problems for marine scientific research.

In the past, there was at least some solace in the fact that there were no restrictions on scientific research in what remained beyond the EEZ (called the Area by the Conference). Unfortunately, even this blessing may not last long. At the most recent session of the Conference (New York, 1977), a few articles appeared in the negotiating text that would extend controls on scientific research into the Area. In large part, this occurred because the developing and less-developed countries are trying to create a Seabed Authority to control the exploitation of the large quantities of manganese nodules in the Area. The Authority would be composed of all States, each having equal sovereignty and voting rights. Clearly, the maritime powers would not represent a majority, or even close to it. Two specific articles in

the 1977 negotiating text concern scientific research in the Area (I quote only the sections that could prove most difficult):

Article 143 says that "States Parties shall promote international co-operation in marine scientific research in the Area exclusively for peaceful purposes by: . . . (b) Ensuring that programmes are developed through the Authority . . . for the benefit of developing countries and technologically less-developed countries."

Article 151, paragraph 7 says that "The Authority shall carry out marine scientific research concerning the Area and its resources, and may enter into contracts for that purpose. The Authority shall promote and encourage the conduct of marine scientific research in the Area, harmonize and co-ordinate such research, and arrange for the effective dissemination of the results thereof."

The potential problems lie in the interpretations of "promote," "peaceful purposes," and "ensuring" in Article 143 and "promote" and "harmonize and coordinate" in Article 151. One view is that the Authority would have considerable control over scientific research in the Area.

It is, of course, premature at this time to predict whether or not these articles will be accepted, or whether they will even survive the 1978 Law of the Sea Conference in New York. The acceptance of these articles could prove to be catastrophic in terms of freedom of marine science in the remaining portions of the oceans. I suspect that most marine scientists and administrations feel that the possibility of this becoming effective is infinitesimal — a feeling most of us had only a few short years ago about scientific research ever being controlled in a 200-mile Exclusive Economic Zone.

David A. Ross is an Associate Scientist in the Department of Geology and Geophysics, Woods Hole Oceanographic Institution. He is a member of the Ocean Policy Committee of the National Academy of Science, a member of the Ocean Advisory Committee of the U.S. State Department, and on the Executive Board of the Law of the Sea Institute.

Support for this article was given by NOAA, Office of Sea Grant, No. 04-7-158-44104.



Limited quantities of back issues are available at prices indicated; a 25 percent discount is offered on orders of five or more. PLEASE select alternatives for those in *very limited supply*. We accept only prepaid orders. Checks should be made payable to Woods Hole Oceanographic Institution; checks accompanying foreign orders must be payable in U.S. currency and drawn on a U.S. bank. Address orders to: Oceanus Back Issues, 1172 Commonwealth Ave., Boston, MA 02134.

SEA-FLOOR SPREADING, Vol. 17:3, Winter 1974 — Plate tectonics is turning out to be one of the most important theories in modern science, and nowhere is its testing and development more intensive than at sea. Eight articles by marine scientists explore continental drift and the energy that drives it, the changes it brings about in ocean basins and currents, and its role in the generation of earthquakes and of minerals useful to man. **\$3.00**

AIR-SEA INTERACTION, Vol. 17:4, Spring 1974 — *Out of print.*

ENERGY AND THE SEA, Vol. 17:5, Summer 1974 — One of our most popular issues. There is extractable energy in the tides, currents, and temperature differences; in the winds that blow over them; in the very waters themselves. Eight articles discuss these topics as well as the likelihood of finding oil under the deep ocean floor and of locating nuclear plants offshore. **\$4.00**

MARINE POLLUTION, Vol. 18:1, Fall 1974 — Popular controversies, such as the one over whether or not the seas are “dying,” tend to obscure responsible scientific effort to determine what substances we flush into the ocean, in what amounts, and with what effects. Some progress is being made in the investigation of radioactive wastes, DDT and PCB, heavy metals, plastics and petroleum. Eleven authors discuss this work as well as economic and regulatory aspects of marine pollution. **\$4.00**

FOOD FROM THE SEA, Vol. 18:2, Winter 1975 — Fisheries biologists and managers are dealing with the hard realities of dwindling stocks and increasing international competition for what is left. Seven articles deal with these problems and point to ways in which harvests can be increased through mariculture, utilization of unconventional species, and other approaches. **\$4.00**

DEEP-SEA PHOTOGRAPHY, Vol. 18:3, Spring 1975 — A good deal has been written about the use of hand-held cameras along reefs and in shallow seas. Here eight professionals look at what the camera has done and can do in the abyssal depths. Topics include the early history of underwater photography, present equipment and techniques, biological applications, TV in deep-ocean surveys, the role of photography aboard the submersible *Alvin* along the Mid-Atlantic Ridge, and future developments in deep-sea imaging. **\$4.00**

THE SOUTHERN OCEAN, Vol. 18:4, Summer 1975 — *Out of print.*

SEAWARD EXPANSION, Vol. 19:1, Fall 1975 — *Very limited supply.* **\$3.25**

MARINE BIOMEDICINE, Vol. 19:2, Winter 1976 — Marine organisms offer exciting advantages as models for the study of how cells and tissues work under both normal and pathological conditions — study leading to better understanding of disease processes. Vision research is being aided by the skate; neural investigation, by the squid; work on gout, by the dogfish. Eight articles discuss these developments, as well as experimentation involving egg-sperm interactions, bioluminescence, microtubules, and diving mammals. **\$3.00**



OCEAN EDDIES, Vol. 19:3, Spring 1976 — *Out of print.*

GENERAL ISSUE, Vol. 19:4, Summer 1976 — *Very limited supply. \$3.00*

ESTUARIES, Vol. 19:5, Fall 1976 — Of great societal importance, estuaries are complex environments increasingly subject to stress. The issue deals with their hydrodynamics, nutrient flows, and pollution patterns, as well as plant and animal life — and the constitutional issues posed by estuarine management. **\$4.00**

HIGH-LEVEL NUCLEAR WASTES IN THE SEABED? Vol. 20:1, Winter 1977 — *Very limited supply. \$3.00*

SOUND IN THE SEA, Vol. 20:2, Spring 1977 — Beginning with a chronicle of man's use of ocean acoustics, this issue covers the use of acoustics in navigation, probing the ocean, penetrating the bottom, studying the behavior of whales, and in marine fisheries. In addition, there is an article on the military uses of acoustics in the era of nuclear submarines. **\$3.00**

GENERAL ISSUE, Vol. 20:3, Summer 1977—The controversial 200-mile limit constitutes a mini-theme in this issue, including its effect on U.S. fisheries, management plans within regional councils, and the complex boundary disputes between the U.S. and Canada. Other articles deal with the electric and magnetic sense of sharks, the effects of tritium on ocean dynamics, nitrogen fixation in salt marshes, and the discovery during a recent Galápagos Rift expedition of marine animal colonies existing on what was thought to be a barren ocean floor. **\$3.00**

OIL IN COASTAL WATERS, Vol. 20:4, Fall 1977 — From a standing start a decade or two ago, scientists have made good progress in investigating how petroleum gets into coastal waters, where it goes, and what effects it has along the way. Articles discuss long-term studies of two spills plus work on effects of oil on fish eggs, fish, and lobsters. **\$3.00**

REISSUES

Last fall, we asked readers to pick the back issues they would most like to see reprinted. After reviewing

Oceanus

The Illustrated Magazine
of Marine Science
Published by Woods Hole
Oceanographic Institution

SUBSCRIPTION ORDER FORM

Please make checks payable to Woods Hole Oceanographic Institution.

Checks accompanying foreign orders must be payable in U.S. currency and drawn on a U.S. bank.
(Outside U.S., Possessions, and Canada add \$2 per year to domestic rates.)

Please enter my subscription to OCEANUS for

- one year at \$10.00
- two years at \$18.00

- payment enclosed.
(we request prepayment)
- bill me

Please send MY Subscription to:

Please send a GIFT Subscription to:

Name (please print)

Name (please print)

Street address

Street address

City State Zip

City State Zip

Subscriber's occupation: _____



Oceanus Back Issues

Limited quantities of back issues are available at prices indicated; a 25 percent discount is offered on orders of five or more. PLEASE select alternatives for those in *very limited supply*. We accept only prepaid orders. Checks should be made payable to Woods Hole Oceanographic Institution; checks accompanying foreign orders must be payable in U.S. currency and drawn on a U.S. bank. Address orders to: Oceanus Back Issues, 1172 Commonwealth Ave., Boston, MA 02134.

SEA-FLOOR SPREADING, Vol. 17:3, Winter 1974 — Plate tectonics is turning out to be one of the most important theories in modern science, and nowhere is its testing and development more intensive than at sea. Eight articles by marine scientists explore continental drift and the energy that drives it, the changes it brings about in ocean basins and currents, and its role in the generation of earthquakes and of minerals useful to man. **\$3.00**

AIR-SEA INTERACTION, Vol. 17:4, Spring 1974 — *Out of print.*

ENERGY AND THE SEA, Vol. 17:5, Summer 1974 — One of our most popular issues. There is extractable energy in the tides, currents, and temperature differences; in the winds that blow over them; in the very waters themselves. Eight articles discuss these topics as well as the likelihood of finding oil under the deep ocean floor and of locating nuclear plants offshore. **\$4.00**

MARINE POLLUTION, Vol. 18:1, Fall 1974 — Popular controversies, such as the one over whether or not the seas are "dying," tend to obscure responsible scientific effort to determine what substances we flush into the ocean, in what amounts, and with what effects. Some progress is being made in the investigation of

PLACE
STAMP
HERE

Oceanus

Woods Hole Oceanographic Institution
Woods Hole, Mass. 02543

OCEAN EDDIES, Vol. 19:3, Spring 1976 — *Out of print.*

GENERAL ISSUE, Vol. 19:4, Summer 1976 — *Very limited supply. \$3.00*

ESTUARIES, Vol. 19:5, Fall 1976 — Of great societal importance, estuaries are complex environments increasingly subject to stress. The issue deals with their hydrodynamics, nutrient flows, and pollution patterns, as well as plant and animal life — and the constitutional issues posed by estuarine management. **\$4.00**

HIGH-LEVEL NUCLEAR WASTES IN THE SEABED? Vol. 20:1, Winter 1977 — *Very limited supply. \$3.00*

SOUND IN THE SEA, Vol. 20:2, Spring 1977 — Beginning with a chronicle of man's use of ocean acoustics, this issue covers the use of acoustics in navigation, probing the ocean, penetrating the bottom, studying the behavior of whales, and in marine fisheries. In addition, there is an article on the military uses of acoustics in the era of nuclear submarines. **\$3.00**

GENERAL ISSUE, Vol. 20:3, Summer 1977 — The controversial 200-mile limit constitutes a mini-theme in this issue, including its effect on U.S. fisheries, management plans within regional councils, and the complex boundary disputes between the U.S. and Canada. Other articles deal with the electric and magnetic sense of sharks, the effects of tritium on ocean dynamics, nitrogen fixation in salt marshes, and the discovery during a recent Galápagos Rift expedition of marine animal colonies existing on what was thought to be a barren ocean floor. **\$3.00**

OIL IN COASTAL WATERS, Vol. 20:4, Fall 1977 — From a standing start a decade or two ago, scientists have made good progress in investigating how petroleum gets into coastal waters, where it goes, and what effects it has along the way. Articles discuss long-term studies of two spills plus work on effects of oil on fish eggs, fish, and lobsters. **\$3.00**

REISSUES

Last fall, we asked readers to pick the back issues they would most like to see reprinted. After reviewing responses, we have chosen the four shown below. The reissue price is \$4.00 per copy.



Energy and the Sea



Marine Pollution

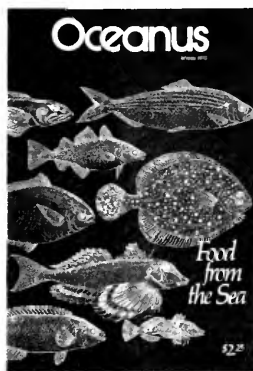

Food from the Sea



Estuaries

Oceanus

WOODS HOLE
OCEANOGRAPHIC
INSTITUTION

Woods Hole, MA 02543

Postmaster: Please Send
Form 3579 to Above Address

SECOND-CLASS
POSTAGE PAID
AT FALMOUTH, MASS.,
NO ADDITIONAL
POSTAL NECESSARY AT
MAILING POINTS

