

THE
METALLURGY
OF THE
COMMON
METALS



BANCROFT
LIBRARY



THE LIBRARY
OF
THE UNIVERSITY
OF CALIFORNIA



Digitized by the Internet Archive
in 2007 with funding from
Microsoft Corporation

E. A. HERSAM,
BERKELEY, CAL.

The Metallurgy of the Common Metals

Gold, Silver, Iron, Copper, Lead,
and Zinc

by

Leonard S. ^{Strong} Austin, 1846-1929.
Professor of Metallurgy and Ore-dressing,
Michigan College of Mines.

First Edition

1907
Published by the
Mining and Scientific Press
San Francisco

T N 665

.A9

COPYRIGHT, 1907
BY
MINING AND SCIENTIFIC PRESS

TABLE OF CONTENTS

	PAGE
PART I—GENERAL	
Section 1. Ores—Definition and Classification.....	13
2. Metallurgical Treatment of Ores.....	16
3. Combustion	16
4. Fuels	20
5. Artificial Fuels; By-Product Coke Ovens; Fuel or Pro- ducer Gas.....	23
6. Refractory Materials	32
7. Sampling; The Sampling of Metals.....	38
8. Preparatory Breaking, Grinding, or Crushing of Ores...	48
9. Thermo-Chemistry as Applied to Metallurgy.....	55
PART II—ROASTING	
Section 10. The Chemistry of Roasting.....	61
11. Roasting of Ores in Lump Form.....	65
12. Roasting Ores in Pulverized Condition.....	72
13. Pot-Roasting of Ores.....	94
14. Cost of Roasting.....	94
PART III—GOLD	
Section 15. Gold Ores	99
16. Gold-Milling and Amalgamation.....	99
17. Operation of a Stamp Battery.....	107
18. Leaching Methods for the Extraction of Gold from Ores	114

TABLE OF CONTENTS

	PAGE
19. Chlorination of Gold Ores.....	115
20. The Vat or Plattner Process of Chlorination.....	116
21. Barrel Chlorination	119
22. Cyaniding of Gold (and Silver) Ores—General Observations	126
23. Development of the Cyanide Process.....	127
24. Chemistry of the Cyanide Process.....	129
25. Operation of Plant.....	130
26. Classification of Methods	134
27. First Method of Cyaniding.....	135
28. Second Method of Cyaniding. South Africa.....	144
29. Third Method. Mexico.....	148
30. Fourth Method. South Dakota.....	156
31. Fifth Method. West Australia.....	162
32. The Bromo-Cyanogen Process.....	164
33. Practice upon Cripple Creek Ores.....	166
34. Cyaniding Sulpho-Telluride Ores.....	168
35. Action of Copper in Cyaniding.....	168
36. Precipitation with Zinc-Dust.....	170
37. Extraction of Gold by Smelting.....	170

PART IV—SILVER

Section 38. Silver Ores	173
39. Silver Milling and Amalgamation.....	174
40. Wet-Silver Mill or Washoe Process (Tank Settling)...	176
41. The Boss System of Silver Milling.....	185
42. The Combination Process of Silver Milling.....	186
43. Chloridizing Roasting	190
44. Dry Silver Milling (Reese River Process).....	192

TABLE OF CONTENTS

	PAGE
45. Hyposulphite Lixiviation of Silver Ores (Patera Process)	196
46. The Russell Process.....	201
47. The Leaching of Argentiferous Mattes.....	204
48. Cyaniding Silver Ores.....	209

PART V—IRON

Section 49. Pig Iron—Its Manufacture in the Blast-Furnace.....	213
50. Iron Blast-Furnace	214
51. The Stoves	219
52. Blast-Furnace Plant	220
53. Operation of the Furnace.....	220
54. Management of the Iron Blast-Furnace.....	223
55. Iron Smelting	224
56. The Chemical Reactions of the Iron Blast-Furnace.....	225
57. Calculation of the Iron-Blast-Furnace Charge.....	228
58. Casting the Pig Iron	230
59. Disposal of Cinder.....	231
60. Pig Iron	231
61. Iron Blast-Furnace Slags.....	233

PART VI—COPPER

Section 62. Ores of Copper.....	237
63. Smelting the Oxidized Ores of Copper.....	240
64. Storage of Materials of the Charge.....	246
65. Relative Advantages of Blast-Furnace and Reverberatory Smelting	248
66. Calculation of Charge in Regular Copper Blast-Furnace Matting	249
67. Matte and Slag.....	252

TABLE OF CONTENTS

	PAGE
68. Composition of Copper Matte.....	253
69. The Copper-Matting Blast-Furnace.....	254
70. Blast-Furnace Matte Smelting of Copper.....	258
71. Regular Matte Smelting.....	258
72. Pyritic Matte Smelting.....	262
73. Pyrite Smelting at Leadville, Colorado.....	264
74. Matte Concentration	264
75. Heat Equations of the Copper-Matting Furnace.....	265
76. The Reverberatory Matting Furnace.....	266
77. Reverberatory Matte Smelting.....	268
78. Reverberatory Smelting of Copper (Welsh Copper Process)	270
79. Direct Treatment of Copper Matte for Blister Copper..	272
80. Reverberatory Matte-Smelting at Anaconda, Montana..	273
81. Henderson Process for the Extraction of Copper from Burnt Pyrite	276
82. The Hydrometallurgy of Copper.....	278
83. The Copper Converter.....	285
84. Converting Copper Matte to Blister Copper.....	286
85. Re-lining the Converter Vessels or Shells.....	289
86. Accessories of a Converter Plant.....	292
87. Losses in Bessemerizing or Converting Copper Matte...	296
88. Cost of Converting.....	296
89. A 300-ton Copper Smelting and Refining Plant.....	298

PART VII — LEAD

Section	90. The Ores of Lead.....	303
	91. Bedding Ores	304
	92. Reverberatory Lead Smelting.....	306

TABLE OF CONTENTS

	PAGE
93. The Ore Hearth.....	308
94. Silver-Lead Smelting	310
95. The Silver-Lead Blast-Furnace.....	312
96. Blowing-In the Silver-Lead Blast-Furnace.....	318
97. Reactions of the Blast-Furnace.....	320
98. Lead Slags	321
99. Calculation of a Silver-Lead Blast-Furnace Charge....	326
100. Handling Base Bullion.....	331
101. Flue-Dust from the Silver-Lead Blast-Furnace.....	331
102. Preparation of Flue-Dust for Re-Smelting.....	332
103. Treatment of Lead-Copper Matte.....	334
104. Lead Ores—Cost of Treatment.....	334

PART VIII—ZINC

Section 105. Properties of Zinc.....	339
106. Ores of Zinc.....	339
107. Metallurgy of Zinc.....	340

PART IX—REFINING

Section 108. Refining of Metals.....	351
109. The Parke's Process for the Refining of Base-Bullion..	352
110. Variations in Methods of Lead Refining.....	362
111. Charges for Refining Base-Bullion.....	363
112. Electrolytic Refining of Copper.....	364
113. Costs of Electrolytic Refining of Copper.....	366
114. Copper Refining Furnace.....	368
115. Copper Refining	368
116. Parting Gold-Silver Bars.....	370

TABLE OF CONTENTS

PAGE

PART X — COMMERCIAL

Section 117.	Location of Reduction Works.....	375
118.	Handling of Materials.....	376
119.	Organization of a Metallurgical Company.....	383
120.	Investment Required on Original Plant.....	386
121.	Profits	387
122.	Organization	389
123.	General Remarks on Management and Labor.....	392
124.	The Purchasing of Ores in the Rocky Mountain States.	401
125.	The Marketing of Ores and Metals.....	405

PREFACE

This outline of the metallurgy of the common metals, namely, gold, silver, iron, copper, lead, and zinc, is devoted to the description of the processes of winning the metals from their ores and to the refining of these metals, except iron, the metallurgy of which is treated only to the point where pig iron is obtained.

Following the description of ores, as well as of the fuels used in treating them, and the materials of which the furnaces are composed, we come to their sampling, for the determination of their exact value before treatment.

A chapter has been devoted to the subject of thermo-chemistry as applicable to igneous methods of extraction.

The winning or reduction of the various metals is then taken up in order and is followed by a description of the methods of refining them.

Attention is then given to commercial considerations, since the processes must be conducted in a profitable way.

The author is indebted to Mr. F. L. Bosqui, who has not only read the manuscript, but has modified the portion devoted to the cyaniding of gold and silver ores, as his special knowledge has justified.

For the subject matter relating to the smelting of silver-lead and copper ores, the author has drawn on his own experience, gained during upwards of a quarter of a century of practical work.

PART I. GENERAL

PART I. GENERAL.

I. ORES—DEFINITION AND CLASSIFICATION.

An ore may be defined as a mineral aggregate containing metals in quantity sufficient to make their extraction commercially profitable. Minerals or rocks containing 15 to 30% Fe would hardly be called iron ore, nor would we designate as an ore, silver ore that carried but 2 or 3 oz. silver per ton. Nevertheless, the rock of the Treadwell mines on Douglas Island, Alaska, carrying \$2.50 to \$3 in gold per ton, may be called ore since it can be profitably worked. In general, ores are named from their chief mineral constituent, as a lead, a copper, or a silver ore. Such an ore, however, may contain other metals than those which designate it. For example, a lead ore may carry silver and gold, a copper ore may contain silver, gold and some lead; a silver ore may carry lead and copper. One can generally tell by appearance whether an ore carries lead, copper, zinc or iron; but gold and silver are not often visible, and the best way to determine their presence is by assay.

Ores carrying but little lead, say less than 5%, are designated dry ores. Those having 5 to 10% Pb. or more are termed leady ores. The former, often quite silicious, possess value chiefly because of their contained gold and silver. Copper ores, containing 5 to 10% copper, and free from lead, also contain gold and silver in appreciable quantity.

Mixed ores are those which contain both lead and copper, so that it is often puzzling how to designate them. In doubtful cases, smelting companies have purchased such ores on either the basis of their lead or copper content, under the plea that in extracting one of these metals the other is lost or wasted.

Straight silver or free-milling silver ores are free from lead and copper and may be treated by amalgamation. Likewise free-milling gold ores are those containing the gold in metallic form, and are amenable to treatment by amalgamation.

Lead-silver or lead-silver-gold ores.—These ores carry lead in such quantity, that when the lead is reduced by smelting, the precious metals alloy with it and are recovered with the lead.

Copper-silver, copper-silver-gold, or copper-gold ores.—These ores, when smelted, yield up their copper which at the same time takes up with it the precious metals.

Base-metal ores.—Lead and copper ores often contain zinc, antimony, arsenic, tellurium, or bismuth. These, in the process of reduction, often alloy themselves with the principal metal, to its commercial detriment, and require expensive after-treatment for their removal.

Plain lead, zinc and copper ores.—These contain practically no precious metal to assist in defraying the cost of treatment. Consequently they must be of higher grade to be profitably worked. They may, however, contain small amounts of silver and gold, but not enough to justify treatment. As an example, pig lead containing 4 oz. silver per ton would not pay the cost of refining for the purpose of extracting silver; or, blister copper might contain as much as 16 oz. silver and yet not pay the cost of electrolytic refining for its recovery.

Grading ore.—Miners often find it profitable to sort their ore into different grades, such as shipping or smelting ore, milling or concentrating ore, according to the after-treatment which they propose to give it. This matter is one of the most important which the metallurgist is called upon to consider in determining the treatment of the ore, and is referred to later in speaking of the combination method for the treatment of a mixed silver ore.

Classification.—An ore consists not only of the species of metallic compound from which it has been named, but also, in most instances, of gangue or waste material. On the other hand the ore may be very free from gangue, as in the case of galena, zinc concentrate, or iron ore; or an ore may consist mostly of waste material with comparatively minute quantities of the metal disseminated through it, as a gold or silver ore.

In reference to their metal contents, we may divide ores into:

(1) *Straight or simple ores*, namely, gold, silver, copper, lead, mercury, zinc, etc.

(2) *Complex or mixed ores*, namely, silver-gold, silver-gold-lead, lead-zinc-copper-silver.

As respects impurities, we may divide ores into free-milling, refractory or rebellious, docile, arsenical, antimonial. A free milling ore permits the extraction of most of its gold and silver by the simple milling operations of grinding and amalgamation. A rebellious ore (a term formerly more used) is one which requires a preliminary treatment by roasting before it can be milled, or which must be smelted. Even smelting ores may present difficulties which would entitle them to be called rebellious. A docile ore, on the contrary, is one which may be easily treated. Gold, silver or copper ores carrying arsenic or antimony may be called refractory or rebellious.

When carrying much lead or zinc, ores are designated as leady or zincky. When free from lead they are called dry.

As respects treatment, we may have free-milling, leaching, chloridizing, cyaniding, or smelting ore.

In smelting ores, there may be basic, silicious, dry, coppery, leady, or fluorspar ore.

In milling and leaching there may be talcose, quartzose, raw, roasting, earthy, argillaceous, talcy, light, heavy, or base-metal ores.

Among iron ores are bessemer and non-bessemer, manganese, silicious, phosphoric, basic, and open-hearth ore.

The gangue, or waste part of the ore, often its principal constituent, may be earthy, silicious, argillaceous or clayey, talcose, or limy. When, as is often the case, the metal is in the heavy part of the ore and the lighter part is gangue, the ore may be susceptible of concentration or dressing to remove the gangue. An ore capable of being thus treated is called a concentrating ore, and the valuable heavy part obtained from it is called concentrate.

We may also divide ores into sulphide and oxidized. As a matter of fact, these varieties merge into each other, and it often becomes difficult to say whether the ore belongs to the sulphide or oxidized variety.

2. METALLURGICAL TREATMENT OF ORES.

In winning metals from their ores the ideal treatment may be divided into three stages: (1) *Preparation*; (2) *Extraction*; (3) *Separation*.

While these three stages often merge into one, it is well to consider the ideal treatment from which departures can be made, or, in which any two stages may be united.

(1) *Preparation*.—This has reference to those operations by which the ore is fitted to undergo the later ones. It is by subjecting the ore to grinding, breaking or comminuting, or to roasting or other heat preparation, that it is so fitted.

(2) *Extraction*.—This consists in having present, or in adding to the mineral charge or mixture, a collector, whose duty shall be to receive or take up from the ore its metal content, bringing it often into a much smaller bulk, from which the metal is more easily parted in the succeeding operation. The collector or carrier may be one of the metals in molten form (mercury, lead, or copper) or water or other liquid.

(3) *Separation*.—This consists in removing, by precipitation or concentration, the metal content of the collector, whereby the metal is collected by itself in marketable form. This does not necessarily mean refining, for the metal may contain impurities and still be in marketable form.

3. COMBUSTION.

Fuels such as wood, coal, charcoal, and coke are combustibles which combine with the oxygen of the air with so much energy as to produce light and heat. Being a chemical action, it can only take place under favoring circumstances. First, there must be a supply of air coming in contact with the fuel; second, there must be plenty of surface exposed to the action of the air if we desire vigorous combustion.

A jet of gas will not ignite when a poker at low red heat touches it, but if the temperature is of a bright red the gas is inflamed. Illuminating gas gives a large flame, while charcoal and coke simply glow. Flame then is burning gas. Soft coal burns with a flame because the heat of burning distills the gas out

of it, while the residue of coke gives forth a short flame due to the burning of the carbon monoxide coming from it.

Hydrogen burns with a non-luminous but very hot flame. In the case of coal gas, if the air supply is abundant as in a Bunsen burner, the flame is non-luminous, while, as ordinarily burned, it is luminous because of the presence of hydrocarbons. In the fire-box of a reverberatory furnace, if we carry a thick fire, say 18 to 24 in. deep, we can produce a long flame in the furnace. By carrying a thin fire, say 6 in. deep the air gets through the fuel more abundantly and the flame is shorter; that is, the hydro-

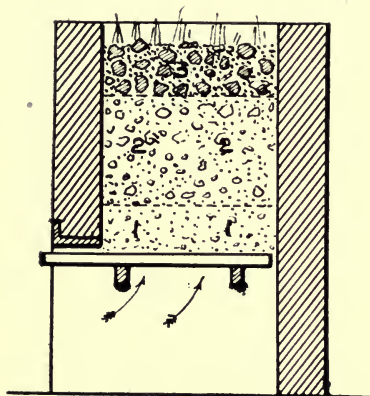

FIG 1. WIND FURNACE.

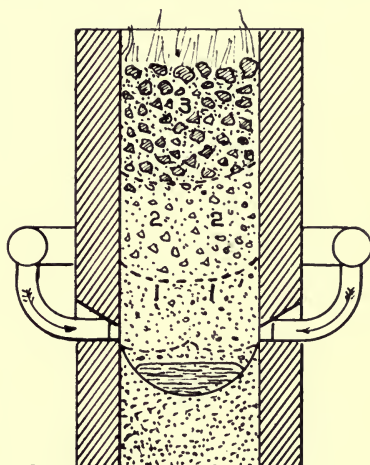
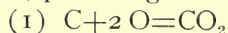

FIG 2. CUPOLA FURNACE.

carbons are speedily consumed. The long flame is desirable where we wish to produce the heat farther along in the furnace. If a cool surface be depressed into a luminous gas-flame, the flame is cooled and soot is deposited on the surface. The combustion of carbon is therefore prevented and smoke is produced if the escaping gases from a soft-coal fire come in contact with a cool surface, or again, where there is a short supply of air.

As an illustration of the phenomena of combustion let us take the case of a fire of glowing coke. (Fig. 1.) The air is in excess at the first instant, producing carbon dioxide thus:



The action is highly exothermic, or heat-giving. It will be noticed that the nitrogen is present as a dilutant to the extent of 70% of the total gases and that a little of the oxygen manages to escape contact with the coke, especially where it is in good-sized lumps. At 2 to 4 in. above the grate in a clear fire we may, therefore, expect to find the greatest heat. But as we go upward this condition quickly changes, since, in presence of an excess of glowing carbon, the latter is dissolved or acted on by the carbon dioxide as follows:

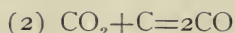

This action is endothermic, and hence we may expect a cooling zone as the gases rise through the coke. If the coke is in large pieces and the fire thin, a little air may draw up along the walls, and escaping combustion and issuing above the fire bed, unite with CO gas, burning a little of it to carbon dioxide thus:

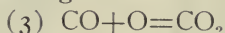

again an exothermic reaction. We get finally a mixture of gases much as follows:

70% N, 27% CO, 2.5% CO₂, 0.5% O, called producer gas. Were we to open the charging door, the entering air would burn the CO gas, producing a blue flickering flame.

To obtain the greatest amount of heat from the fuel the thickness of the fire should be no greater than that of the zone (1, 1).

Fig. 2 represents the conditions in a blast-furnace where, as in an iron foundry cupola, the material is simply melted. The air, forcing itself in contact with the glowing coke, as per the formula (1), rapidly burns it with the production of an intense heat of say 1500° C, this action continuing to the upper limits of the zone (1,1) where the oxygen has disappeared and where the formation of CO from the CO₂ begins. As the gases enter the colder zone (2, 2) the CO₂ becomes dissociated in the presence of carbon to CO, but little of it remaining at the upper limits of that zone. In the upper zone (3, 3) the cold materials of the charge, often mixed with limestone, tend to absorb heat from the rising gases. The limestone is dissociated as follows:



the action being complete at 800° C. In a cupola, where the operation is one of melting only, to attain the greatest economy of

fuel, the coke should be dense and in large pieces, and the blowing should be done with plenty of air.

From the equation (1) we shall find, that to burn one pound of carbon completely, there is needed 2.66 lb. O, or, since air contains 23% O by weight, 11.6 lb. air. At the sea-level, where air weighs 12.4 lb. per cu. ft., this will make 143.8 cu. ft., or, in round numbers, 150 cu. ft. per pound of carbon. Common grades of coke contain 85% of carbon, reducing the exact figure to 122 cu. ft. to one pound of such coke. While in theory 12 lb. of air is sufficient for a pound of coal, it has been found that the air is not entirely consumed in passing through the fire, and that an excess should be used to ensure complete combustion. With a forced under-grate draft 16 lb. has been found to give the most satisfactory results.

The quantity of heat developed in unit time and, therefore, its intensity, depends upon the amount of coal burned in that time and this latter upon the weight of air supplied to it. Now for a natural draft this depends upon two things, the grate-area, and the size of the chimney which takes away the products of combustion and which draws the air through the fire. For a given thickness of fire and draft-pressure the quantity of coal varies directly with the grate-area. The weight of air passing away by the chimney is the product of its velocity into its weight per cubic foot and this into the area of the stack thus: $W = Vaw$; where W is the weight of air in pounds per second, V the velocity of the air in feet per second, a the effective sectional area of the stack, and w the weight of a cubic foot of air. The velocity V varies with the square root of the height of the chimney and of the temperature of the escaping gases, and is measured by a U-gauge which expresses the pressure in inches of water; this pressure varying directly with the height of the stack, and consequently, as the square root of the velocity. A good draft is obtained with 1.5 in. of water. Since the velocity depends upon the differences of temperature between the column of air filling the chimney and that of the outside air, we have the formula:

$$V = \sqrt{2gh} \sqrt{\frac{T-t}{273+t}}$$

where g is the acceleration due to gravity (32.2 ft. per sec.), h the height of the chimney, T the internal and t the external temperature in degrees, centigrade.

Since the friction of the chimney and of the escaping gases comes into play, the effective area is less than the actual, so that we may give the effective area $a=e-0.6\sqrt{e}$, where e is the actual area.

The velocity V increases as the square root of the increase of temperature, while the density or weight per cubic foot W at the same time decreases at the rate of 1-273 of its volume for each degree centigrade. The product Vw therefore reaches its maximum when the chimney gases have half the density of the outside air or at 273° C (about the temperature of melting lead), and it is of no advantage to exceed this point. (See Fig. 3.) At this density, 25 cu. ft. of air equals one pound; this multiplied by 24, the number of pounds needed in practice for complete combustion, means 600 cu. ft. per pound of coal. In a reverberatory melting furnace, where a neutral flame is desired, 400 cu. ft. of air is sufficient. On the other hand, in a roasting furnace, an oxidizing atmosphere may be needed, in which case air is supplied in excess of that required for burning the fuel, entering the furnace by holes at the side or roof or through the bridge-wall.

4. FUELS.

Fuels may be divided into two classes, natural and artificial. Coal and wood are examples of a natural fuel; coke and charcoal, of their artificial products.

Natural fuels.—These include natural gas, the mineral oils, and the solid fuels.

Solid natural fuels.—These may be divided into wood, lignites, bituminous coal and anthracite, which may grade into one another. This is particularly true of the latter two. We may classify them by composition, making the fixed carbon and volatile constituents 100% and excluding ash, sulphur and moisture, as follows:

	Fixed Carbon	Volatile Constituent
Hard, dry anthracite.....	100 to 93%	0 to 7%
Semi-anthracite	93 to 87%	7 to 13%
Semi-bituminous	87 to 75%	13 to 25%
Bituminous	75 to 0%	25 to 100%

Hard or anthracite coal may be considered as a heavy, compressed, natural coke. For commercial purposes, it is customary

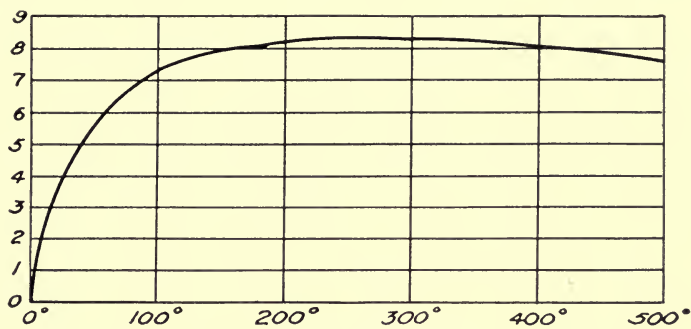

FIG. 3. TABLE SHOWING VARIATION DUE TO TEMPERATURE.

to screen it into different sizes, the smaller sizes containing the most slate and dirt, as shown by this table.

Size of Coal.	Fixed Carbon	Ash
Egg, 2.5 to 1.75 in.....	88.5%	5.7%
Stove, 1.75 to 1.25 in.....	83.7%	10.2%
Chestnut, 1.25 to 0.75 in.	80.7%	12.7%
Pea, 0.75 to 0.50 in.	79.0%	14.7%
Buckwheat, 0.50 to 0.25 in.	76.9%	16.6%

A cubic foot of anthracite coal may be taken at 60 to 65 lb. and its calorific power at 6,500 to 7,000 calories. The proximate analysis of anthracite coal of Pennsylvania is as follows: 3% water, 3.4% volatile matter, 87.1% fixed carbon, 5.9% ash, 0.6% sulphur. Anthracite coal, having little or no flame, is especially suited to direct contact heating as in the blast-furnace or in the crucible melting furnace.

Bituminous coals are chiefly used in reverberatory furnaces because of the long flame which they produce. As an example

we may take West Virginia coal, which has by analysis 1.5% water, 37.8% volatile matter, 53.4% fixed carbon, 6% ash, 1.3% sulphur, and having a calorific power of 7,333 calories. We may compare this with an example of semi-bituminous Colorado coal, containing 6.2% water, 31.2% volatile matter, 52.5% fixed carbon, 11.1% ash; or with a Western lignite, as that of Gallup, N. M., which contains 12.1% water, 32.8% volatile matter, 47.6% fixed carbon, and 7.4% ash. Of the Rocky Mountain coals, some will coke, but the larger portion will not fuse in the coke-oven.

Wood.—When freshly cut, wood will contain on an average 40% of moisture, and where it can be burned will develop 2,300 calories. After drying out for several months it still retains 20% of moisture, and its calorific value has increased to 3,100 calories. Where the wood is perfectly kiln-dried, it contains 50% carbon and has a calorific power ranging from 3,667 cal. for white oak to 5,546 cal. for long-leaf pine. In outlying districts of the West, where the metallurgist is dependent on wood for making steam or for metallurgical operations, the accumulation of a supply of dry wood should be one of his first cares, since in no way will his forethought be better rewarded. He should purchase it delivered and corded ready for measurement, and in measuring should make due allowance for short dimensions and open piling. Cord-wood should cord up so as to give 70% solid.

Mineral oil or, fuel oil.—This is the most concentrated of fuels, and, where the cost justifies its adoption, is used not only for steam-making but also for roasting and melting.

Heating power.—It will be found, in burning fuel oil from various localities, that the calorific power is much the same in all. Beaumont, Texas, oil has a calorific power of 10,820 calories, and a specific gravity of 0.88. Oil can be burned so as to give not only uniform heat, but also an oxidizing (as in roasting), or reducing flame, as may be desired. The air, which enters with it, should be pre-heated as well as the oil, and it will be found best to inject it under high steam pressure. Light and heavy oils should not be burned in mixture.

In Russia, where it has been burned in open-hearth steel furnaces of 10 to 15 tons capacity, the oil used was 15 to 20% of

the charge. As regards comparative cost, it was found at the Selby Smelting & Lead Works, Vallejo Junction, Cal., that, with oil at \$1.71 per bbl. of 42 gal., and coal at \$6.00 per ton, the saving in using oil was from 40 to 60%. It was found that in the reverberatory matting-furnace a higher or lower grade of matte was produced according as the flame was more or less oxidizing or reducing.

Natural gas.—In Ohio, Indiana, and Kansas, there are regions where natural gas has been obtained by boring, as for oil. It is the most efficient of gaseous fuels, having a calorific power of 611 calories per cu. ft. or 27,861 calories per pound.

5. ARTIFICIAL FUELS.

These may be divided into the solid prepared fuels and fuel gas. The solid fuels are charcoal and coke.

Charcoal.—Wood, packed into a kiln where a part of it is permitted to burn, heats up the remainder so that the volatile portion is distilled, leaving charcoal. The latter keeps the form

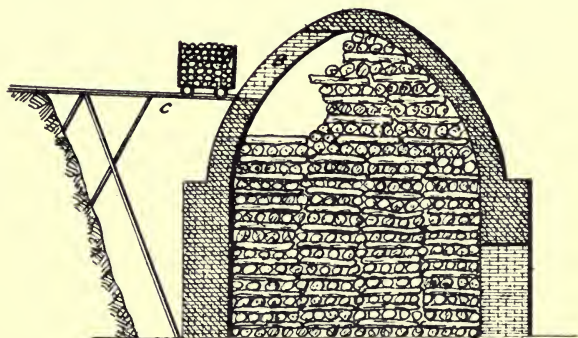

FIG. 4. SECTION OF CHARCOAL KILN.

of the wood from which it is made, and, by burning, becomes much lighter, having a specific gravity of 0.2. A heaped bushel weighs 14 to 16 lb. It contains 95% carbon and has a calorific power of 7,610 calories.

Charcoal is generally made in a kiln, shown in section in Fig. 4 and in perspective in Fig. 5. It is set at the foot of a steep bank so that it can be conveniently charged from above.

It has two openings *A* and *B*. Wood is first packed in at the lower opening and the filling finished from above. There are three rows of 3 by 4 in. holes set 2 ft. apart around the bottom. The kiln is lighted at the lower door, and, when fairly started, both openings are closed with sheet-iron doors, the air entering by the small holes. When combustion has proceeded far enough, these openings are closed, and the kiln is allowed to cool. The first period of burning lasts eight days, the cooling four days more. Such a kiln will hold 25 cords of wood, and will produce 1125 bu. of charcoal of 16 lb. per bushel, or about 20% of the weight of the wood charged.

The ash of charcoal amounts to from 1 to 3%, that of the charcoal made from wood of the arid regions of the West carrying the most. The ash contains but little sulphur or phosphorus, and hence will make, in the iron blast-furnace, a pure and strong pig iron.

The Pierce process.—This is intended both for the making of charcoal and for the recovery of the by-products of the destructive distillation of wood. The wood is heated in brick kilns by burning gas arising from a previous operation, air being at the same time injected by means of steam-jets. The wood is dried out in about 18 hours and then distillation begins. The top of the kiln is then closed, and the products drawn away to condensers by means of fans. Part of the uncondensed gas is, however, together with a proper proportion of air, returned to the kiln to supply additional heat, while the remainder is used for steam-making. The whole operation of charging, condensing, cooling and discharging takes 8 days. The condensers are a series of copper pipes cooled by circulating water. The wood yields

Charcoal	25.3 %
Methyl or wood alcohol.....	0.75
Acetic acid	1
Tar	4
Water	46
Permanent gases	23

By-product charcoal is quite dense, weighing 20 lb. per bushel. By the sale of these by-products, and because of the superior

quality of iron made from charcoal, it has been possible, where the supply of wood was abundant, to build up the industry of charcoal-iron making in spite of the competition of coke blast-furnaces.

Charcoal, however, is more friable than coke and makes a good deal of fines or 'braize,' as it is called. This will accumulate at the sides of the iron blast-furnace tending to form

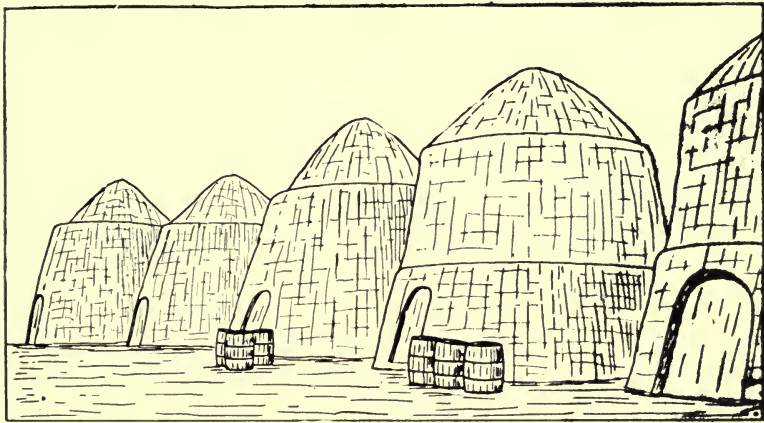

FIG. 5. PERSPECTIVE VIEW OF CHARCOAL KILN.

'scaffolds.' Even in the lower furnaces for lead and copper smelting, a charcoal, made from a light wood, is apt to be friable and to give trouble in this way, and only the firmer woods should be used in charcoal-making.

Coke.—This is made in kilns in a similar way to charcoal from a bituminous coal which will coke or fuse together at the high heat of the kiln. Coke is chiefly made in bee-hive ovens of which Fig. 6 is a type. These are 12 ft. diam. by 7 ft. high in the clear. They are charged through a hole in the roof, each oven holding 5 to 6 tons of the finer portion of the coal (less than 0.75 in.) as it comes from the mine. In burning 72-hour coke the charge is, in the morning, dropped into the hot oven from the coal-larry standing above, and is leveled through the working opening to the depth of 26 in. It is then walled up with brick,

an opening being left at the top of the door for admission of air. Combustion soon begins, and the usual dark smoke escapes by the charge-opening. After four hours this becomes white, the coal ignites or 'strikes,' and flames issue at the top. For twelve hours the oven burns with a dull smoky flame above the surface of the charge. On the second day the flame becomes bright, and the air supply is nearly cut off, the coking being completed in 55 hours. The flame gradually subsides, the whole interior of the oven being red-hot. The oven is then tightly closed and left until drawn in the morning of the fourth day, the whole operation taking 72 hours. To draw the coke, the brick-front is taken down and water played by hose into the oven. After it is superficially cooled, the coke is drawn out by a coke-drag having a long handle. As it is withdrawn, it is cooled with more water. The heating has taken place from above downward, leaving the coke in prismatic masses of a steel-gray color.

The following table indicates the composition of Connellsville coal and the coke made from it.

	Coal	Coke
Moisture at 100° C.....	1.2%	0.6%
Volatile matter	31.3	1.4
Fixed carbon	59.8	86.
Ash	7.2	11.1
Sulphur	0.5	0.9

Such coal, carefully coked in a modern bee-hive oven, will yield 66% of marketable coke. Coke can also be made in 48 hours but the 72-hour product is firmer. The efficiency of coke depends upon five factors, namely, (1) hardness of body, (2) fully developed cell-structure, (3) purity, (4) uniform quality and (5) coherence in handling. Hardness of body and well-developed cell-structure are apt to go together, the latter characteristic being important in permitting the access of air in combustion. Purity depends upon a low ash, 10% being good and 6 to 8% exceptionally pure. The sulphur in coke intended for iron blast-furnace work should be under 1%, a good coke containing as little as 0.5 to 0.75% sulphur. For lead or copper blast-furnaces this does not so greatly matter. Uniform quality

means absence of black ends, which, being soft, are dissolved in the upper part of the furnace by carbon dioxide gas. Coherence in handling is evidently important where the coke has to be transported far and re-handled at the smelting works. The

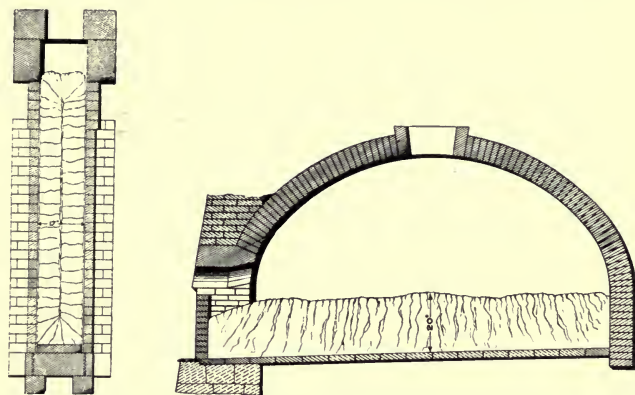

FIG. 6. SECTIONS OF BY-PRODUCT AND BEE-HIVE COKE OVENS.

coke-fines are injurious to the action of the furnace, and should be kept out by using a coke-fork.

The calorific power of a Pittsburg coke, containing 89% fixed carbon, 10% ash, and 1% sulphur, may be given at 7,272 calories.

BY-PRODUCT COKE OVENS.

The principal ovens of this kind in the United States are the Otto-Hoffman and the Semet-Solway. The former type is well shown in a general sectional elevation in Fig. 7. The coking chamber is 18 in. wide, 33 ft. long, and 5 ft. 3 in. high, and is closed at each end by an air-tight cast-iron door. The side-walls of the chamber contain flue-openings, in which the gas evolved in coking is burned in order to heat the coal. There may be 20 to 60 of these chambers set side by side in one block. The oven being hot from a previous charge, the doors are closed, a fresh charge is dropped by the hoppers and leveled off. Distillation at once begins, and the gases are led away to condensing chambers, where they are freed from by-products—tar, ammonia and benzol—and the permanent gases returned by a gas-main to

be burned around the ovens in the flues already referred to. The products of combustion, in passing away to the stack, go through a regenerating-chamber containing brick checker-work, while air is blown through the other chamber at the other side. Thus the gas is burned, together with highly heated air, producing an intense heat in the walls of the coking chambers. As in open-hearth work, this action is then reversed. Upon the completion of the coking in 24 to 36 hours, the end doors are opened and the coke pushed out by means of the ram shown at the left. It is then sprinkled with water and loaded into cars standing on the track at the right. The yield is about 72%, being 7% more than that of a bee-hive oven. The coke is harder, denser, but more reliable than the bee-hive and has not the same silvery gloss which we see in Connellsville coke.

Costs.—The actual cost of making coke may be given at 50c. per ton in bee-hive, and 37c. per ton in by-product ovens, to which must be added the cost of coal to make it. A bee-hive plant of 400 tons daily capacity, operated 6 days per week would cost \$60,000, while a by-product plant would figure up to \$300,000.

FUEL OR PRODUCER GAS.

The use of gas made in producers is extending, and has many applications in generating power and in metallurgical operations. It is therefore proper that in this place a careful study should be made of the subject.

We show in Fig. 1 and 2, in the section on combustion, how producer-gas is formed where air rises through a thick coke fire, and where the fuel is consequently in excess. The calorific power of one pound of such gas would be simply that of the CO or

$$\frac{\text{Its specific heat x heat of combination}}{\text{Atomic weight}} = \frac{0.127 \times 29000}{28} = 280 \text{ calories}$$

By blowing steam through the glowing fire, and decomposing it according to the equation

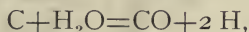

we produce what is called water gas. This gas has a much greater heating power than ordinary producer gas on account of

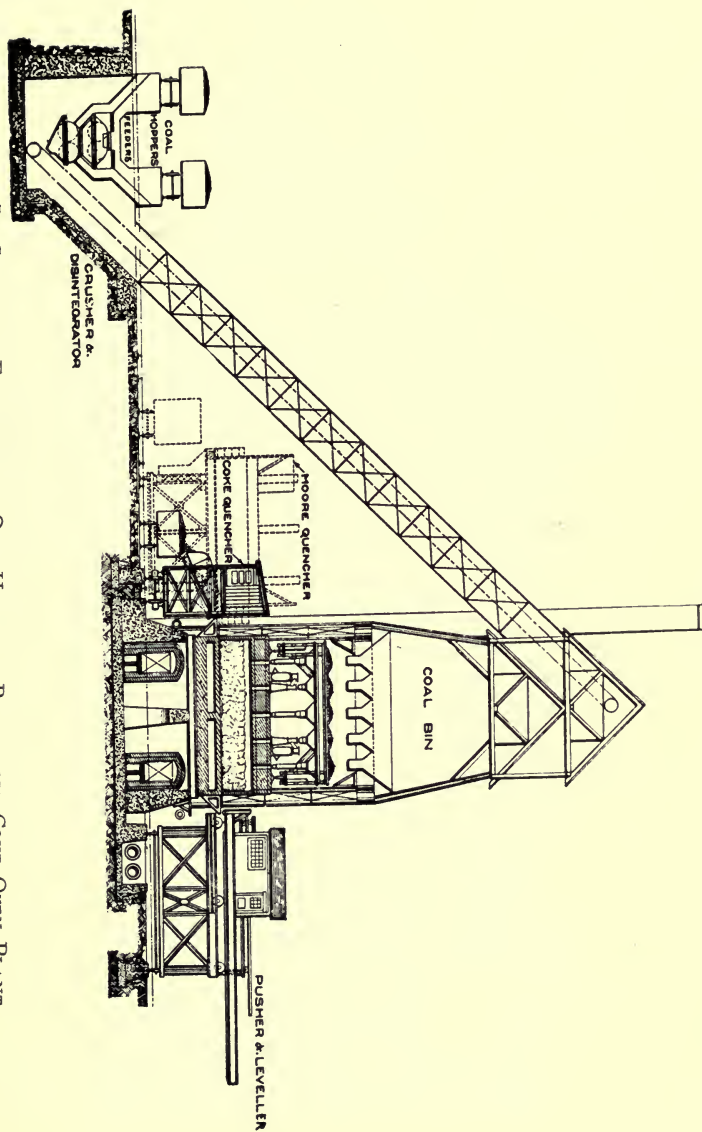

FIG. 7. SECTIONAL ELEVATION OF OTTO-HOFFMAN BY-PRODUCT COKE-OVEN PLANT.

the calorific power of the hydrogen, one pound of which would give 29,100 calories if again burned to water. The reaction by which water gas is produced is highly endothermic, and in consequence of its rapidly cooling the fire, must be stopped in a few minutes, so that the quantity which can be thus made is limited.

A great variety of gas producers have been made; among the more recent types is:

The Taylor revolving-bottom producer.—This consists of a steel brick-lined shell, 6 ft. internal diameter (Fig. 8), with an iron bosh below where the ashes accumulate. These are held up by a grate which about once in six hours is revolved in order to grind up and remove the ashes. A central pipe is to be seen rising through the ashes, and by it both the air and steam may be introduced to the fire. At the left may be seen a steam injector by which both steam and air are blown into the fire. Peep holes at the side show its condition and the height of ashes. The coal is charged by hopper and bell, being kept closed except at the instant of charging. The gases are led off at a large exit pipe near the top.

Fig. 9 shows a complete plant of the Loomis-Pettibone system, having a positive blast exhauster, and making both producer and water gas, and cooling and cleaning it for use. The operation is as follows: Assuming that there are hot fires in both of the generators (or producers), the air is drawn through generator 1, and, in so doing, burns the fuel and makes producer gas. This generator may have just received fresh coal, and the coal smoke, tarry matter and producer gas from it are together drawn through the hot fire in generator 2, being completely burned in so doing. The gas goes off through the valve *B* to the boiler where its heat is absorbed. It then passes over to a scrubber where it rises through coke set on perforated trays in a tower. This coke is continually sprinkled with water sprays so that the gas is cooled and cleaned. Rising to the top of the tower, it filters through a layer of fine shavings or 'excelsior,' which removes any particles of dust, and passing on goes through the Root positive-blast exhauster shown at the right, and finally, by the pipe *Z*, to the producer-gas gasometer. The fire in generator 1, having be-

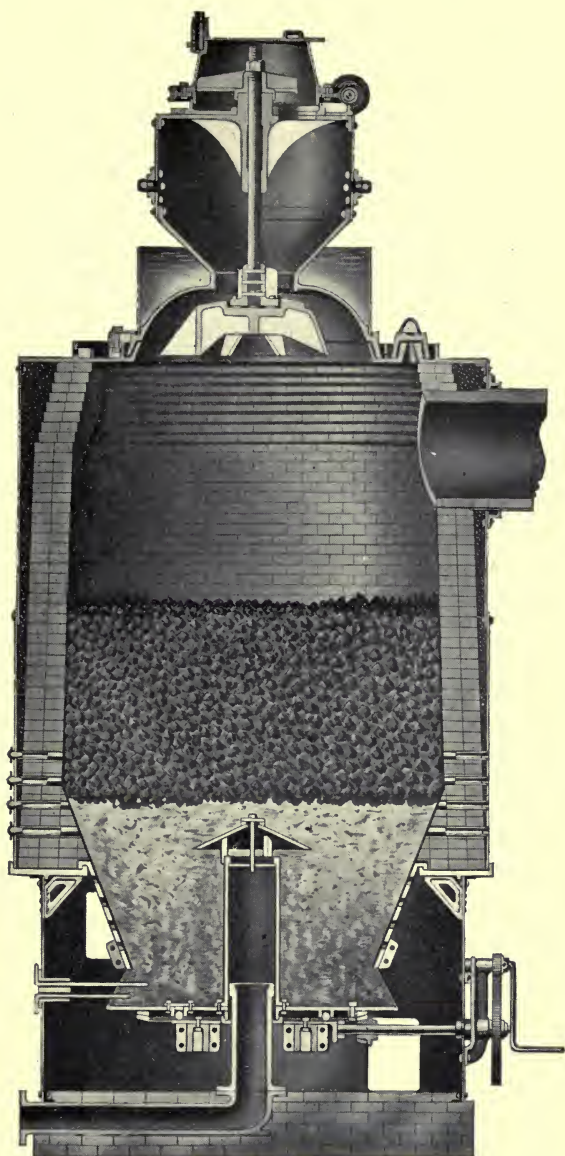

FIG. 8. TAYLOR REVOLVING BOTTOM PRODUCER.

come clear and hot, fresh coal is put into generator 2 and the valves change to take the air at the bottom of it. The course of the gas is then from 2 to 1 through valve *A* (valve *B* having been shut), to the boiler, thence to the scrubber and exhauster to the gasometer. In making water gas, steam is introduced under the grate of the generator which has the upward current, and while the fire is hot. The water gas made in one generator is perfected by passing down through the other, it having been found, that unless this is done, a portion of the hydrogen again reverts to steam. The making of water gas, having been kept up for a few minutes, so cools the fire that steam must be shut off, and air again substituted. While water gas is being made, it may pass on by the pipe *Z* to the gasometer, or *Z* may be closed and *Y* opened, permitting it to go to the water-gas gasometer. Water gas having a higher calorific power, is often reserved for certain heating operations for which producer gas would be unsuited. *X* is a 'purge pipe' which is opened when starting so that the air in the system may be expelled before turning the gas into the gasometer. Steam may also be admitted, together with air, above the fire where it mingles with the producer gas and enriches it.

6. REFRACTORY MATERIALS.

In addition to ordinary building materials, such as red brick, iron, or stone used upon the exterior portion of furnaces, refractory bricks and materials are needed for the interior, where a high temperature or the corrosive or scouring action of molten metallic oxides or slags must be resisted. These materials may be either in natural form, as sand, or in artificial form, as brick.

Sand is used for repairing or fettling the interior borders of a reverberatory furnace, forming a bank which covers up or protects the portion eroded by the scouring action of the charge. The repair is executed after a charge is withdrawn, and when the sides of the emptied furnace are free and clear. The sand is thrown in by means of shovels, or set in place by long-handled paddles. Sometimes a little clayey material is added to the sand so that it may be made into coherent balls. These are then thrown against the side, adhering to it or pressed against the

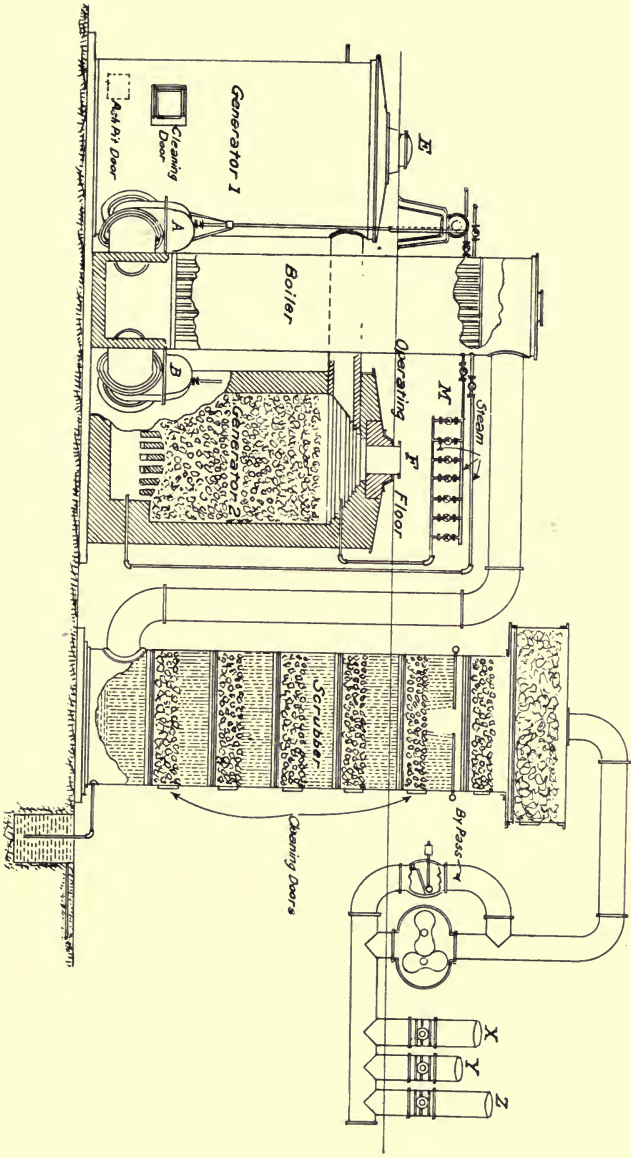

FIG. 9. LOOMIS-PETTIBONE GAS-MAKING PLANT.

spot to be repaired by means of the paddle just referred to. The bottoms of such furnaces are also made of this sand. Ganister or lining is a mixture of crushed quartz or other silicious rock, to which there has been added just enough clayey material to make it cohere. It is largely used for lining converters, and in this case a very silicious ore carrying some gold and silver may be used instead of barren quartz rock. Since this material is all eaten or scoured away, and since its metal contents are absorbed by the matte constituting the charge, it is in reality a kind of ore-smelting performed without additional expense of treatment. For stopping a tap-hole of a furnace, or for closing joints or other openings, clay, or a mixture of sand and clay, mixed into a stiff mud or adobe may be employed. Clay alone shrinks in drying and the admixture of sand prevents this. In place of the sand, coarsely ground fire-brick (called also chamotte, grog, or cement) may be used. This moist, firmly coherent, and plastic mass is molded into conical plugs, and the plugs stuck upon the end of a dolly or stopper-rod and pressed into the tap opening, thus stopping the flow of slag. It is also used for stopping cracks, and, in larger masses, for closing openings or apertures of the furnace.

Refractory materials may be divided into three classes:

Acid, as silica-brick, sand, and ganister.

Neutral, as graphite, chrome iron, fire-clay, bone ash, and carbon brick.

Basic, as dolomite and magnesite.

The choice of one or the other of these depends on the following considerations:

Acid materials may be used to resist the scouring or corrosive action of acid slags, or, being very infusible, for the roofs or arches of furnaces subject to highest heats.

Neutral materials resist well the action of neutral slags or of metals, and, in the case of open-hearth furnaces, are interposed as a layer between the silica-brick roof and the basic-lined hearth.

Basic materials are used where the slags are quite basic. Such slags would quickly scour or corrode a silicious lining.

It will be noted that all the above materials have not only special resistant power, but are also very infusible. This is particularly the case with carbon, which in the absence of air or nitre, is quite permanent. This is illustrated in the carbon filament of an incandescent electric light.

It is the brick made from this material that we will now discuss.

Silica-brick.—If quartz rock or a sandstone, containing 98% SiO_2 , is mixed with a little lime paste made from caustic lime and moistened with water, it will cohere sufficiently so that it can be molded into bricks. These are dried in a drying oven or room by steam heat, and then charged into kilns, where they are burned or heated to a white heat. Fig. 12 represents a down-draft kiln. It is a dome-shaped oven 15 to 25 ft. diameter, coal-fired by means of fireplaces set in the exterior wall. The flame rises to the crown of the arch, and, passing downward through the brick piled in open order, leaves through flues at the floor of the kiln, connected with the adjoining stack. Silica-bricks are burned at the highest heat attained in such an oven. In use they resist the highest temperatures, and expand when heated up. Consequently, expansion joints or openings are provided, which close when a furnace is in use. Otherwise, the tie rods which bind the furnace may be slackened, being tightened again when the furnace is closed down and cooled off. The linear expansion to white heat is 2.5 per cent.

Graphite or plumbago.—This is essentially carbon containing a little iron and other gangue as an impurity. It is used, in mixture, for melting-crucibles or for retorts, containing 50% graphite, 45% air-dried clay and 5% sand. The graphite prevents shrinking and cracking and adds to the refractoriness of the vessel.

Chromite, or chrome-iron, is a double oxide of iron and chromium ($\text{Cr}_2\text{O}_3 \text{ FeO}$). For making brick the ore should have not less than 40% Cr_2O_3 and not more than 6% SiO_2 . It is made into brick by crushing it, mixing with a little lime as in the case of silica-brick, and burning in kilns. Chromite is not acted on by silicious fluxes.

Fire-brick and tile.—We come now to that most used of refractory materials made from fire-clay. Clay, in its purest form as kaolin, contains silica and alumina in such proportions as to make

it difficultly fusible. The presence of certain bases, even in small quantity, may much increase its fusibility. Clays, nearly free from such impurities, and therefore quite infusible, together with uncombined silica, form fire-clay. Thus, we have a typical air-dried clay of the following analysis:

Kaolin ($\text{Al}_2\text{O}_3 \cdot 2 \text{SiO}_2 \cdot 2 \text{H}_2\text{O}$)	58.9%
Uncombined silica (SiO_2)	36.1
Impurities (CaO , FeO)	2.5
Moisture and organic matter	1.9

It is the combined water in the first constituent which renders the clay plastic when pugged, that is, when after grinding it is incorporated with water. The pure clays alone are unsuitable for making fire-brick, since, in burning, they shrink and crack. It is necessary therefore to mix with the clay some non-shrinking substance, such as sand, ground quartz, or coarsely ground, previously burned, clay or brick, which has already reached its maximum of shrinkage. This latter material is called 'chamotte' or 'grog.'

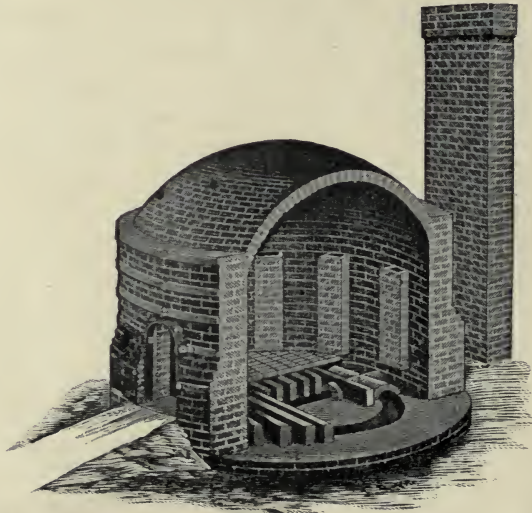

FIG. 10. BRICK MOLD.

The manufacture of fire-brick.—The fire-clay to be used is first coarsely ground to about 10-mesh. It is then put into a large

square pit in layers, and thoroughly soaked in water for 24 hours. From the pit the mixture of clay and grog is shoveled into a vertical pug-mill by which the clay is thoroughly incorporated. There is obtained a plastic mass ready for the molding. The molding may be done either by machine or by hand. In the latter case, the clay is made in balls large enough to fill a mold (see Fig. 10), and thrown into it with all the force possible. It fills the mold completely, the excess being cut off with a straight-edged stick, and the bricks dumped out on a pallet or board. These pallets are placed upon racks and the bricks are air-dried until they are so stiff as to give but little under pressure of the finger. They

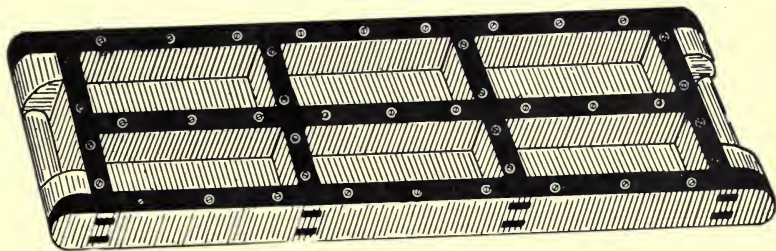

FIG. 11. BRICK REPRESSING MACHINE.

are then put through a re-pressing machine (Fig. 11), by which they take their exact form. When pressed, they are placed again on pallets, set on brick-cars, and run into the dryer consisting of chambers, where, under the action of steam heat, the final moisture is removed. The bricks are now piled in the kiln (Fig. 12), where they are burned, the operation taking upward of two or three weeks.

Fire-brick varies in its physical characteristics according to composition, the more aluminous being tougher and more resistant to molten slag or matte, while the silicious is more infusible.

Bone ash is made by burning bones in a kiln and coarsely grinding the white burned residue. Organic matters and moisture are both removed, and an impure calcium phosphate is left. It resists the action of litharge, and is accordingly used not only in assaying but for forming the test or large cupel of the English cupelling furnace.

Carbon brick.—Gas-carbon, such as is used for arc-lights in electric lighting, is made into brick with a limited amount of gas-tar and burned to brick. This brick has been found to be quite resistant in a reducing atmosphere, such as the interior walls of a blast-furnace.

Both dolomite and magnesite are basic materials, used for lining furnaces where basic slags are formed, such as would attack or scour silicious or even neutral fire-brick. Dolomite is a magnesian limestone, and the more magnesia it contains the better. Magnesite, or magnesium-oxide, is made into magnesia-brick

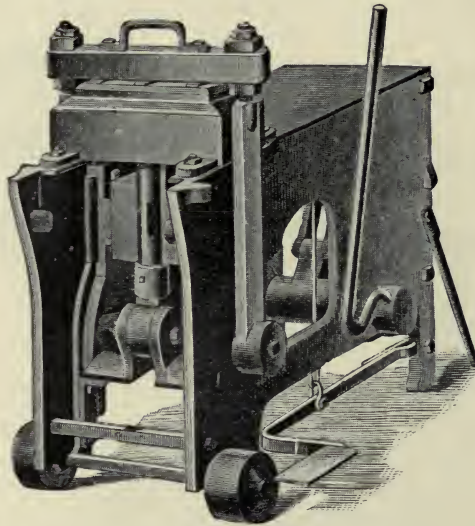

FIG. 12. SECTION OF BRICK KILN.

by calcining it at a high temperature. It is usually dark brown from the presence of iron, and is the most valuable of basic materials. It is used both for basic converters and for open-hearth basic furnaces where the slag contains as little as 15% silica.

7. SAMPLING.

The first step necessary in the treatment of an ore is to learn its value by assaying. As a preliminary the ore must be sampled so that in a bulk of a few ounces we may have a correct rep-

representative of the entire quantity of the ore, whether it be a few hundred pounds or thousands of tons. Moreover, the metals resulting from the treatment, especially where there are several together, should be sampled before assaying them for these various metals. Further, the ores and materials used in treatment should be sampled in order to determine their exact constitution and so learn exactly how to combine and to treat them. Ores worth thousands of dollars are often bought outright from the producer, and upon their correct sampling depends the amount paid; so that both seller and buyer are equally interested in having the sampling correctly performed. In obtaining the value of a lot of ore we must ascertain its weight and moisture, and calculate its dry weight; also obtain its correct sample and its correct assay. Thus, suppose we have a lot of ore weighing 10,800 lb. with 7% moisture and containing, by assay, 54% lead worth 3c. per lb. Since the assay is made upon the dry weight, we have, after deducting the moisture, 10,044 lb. of ore containing 5,424 lb. of lead, worth, at 3c. per pound (neglecting fractions), \$162.72.

Receiving and weighing.—Ores may come into a reduction works either loose or in sacks. In the first case, whether received in wagons or in cars, the weight of the vehicle and ore together is taken upon the scales and called the gross weight. When the vehicle (car or wagon) is emptied, its weight, called the tare, is taken; this, subtracted from the gross, gives us the net weight. It is this net weight which we have above called the wet weight. When the ore arrives in sacks the weight may be ascertained in the same way, but from this figure must be subtracted the weight of the sacks. Often the sacks are transferred direct to the scales, weighed there and afterward emptied. The sacks, if worth it, may be dried and returned for re-use. Sometimes the ore, especially when frozen, is charged, sack and all, into the blast-furnace, the sack serving to hold the fine contents together until smelted, thus preventing loss of flue-dust. In this case the sample is made up from small portions taken from each sack.

The moisture sample.—In theory the moisture sample should be taken at the instant of weighing, since obviously the ore dries

while the operation is delayed. In practice the sample is taken either then or as the car is being unloaded. When taken from the car, a hole is dug in the ore and the dried-out surface portion rejected. The remainder is put into a covered can and from it 50 oz. are taken and promptly weighed on a moisture scale. After cautious drying on a hot-plate or, better, on steam coils, it is again weighed, the loss being the moisture.

The methods of sampling may be divided into *hand-sampling* and *automatic or machine-sampling*.

Hand-sampling includes such imperfect methods as the grab sample and the trench sample; while among the complete methods we have coning and quartering, fractional selection, the split shovel, and riffles.

The grab sample.—This consists in taking evenly from different places on the pile, lumps and handfuls of the ore to be treated further as follows: the lumps are broken uniformly to about one-fourth the size of the large pieces, and the whole (lumps and fine) mixed together and worked down by one of the hand-sampling methods to be later described. The hand-sample is used as a quick method to give an approximate idea of the metals in the pile of ore.

The trench sample is taken upon a large pile of ore, such as a dump, cutting transversely through it by means of a trench. As the workman proceeds he throws the bulk or principal portion of the ore to one side, but reserves an aliquot portion of every tenth, twentieth, or hundredth shovelful for a sample. In this way the ore from the bottom of the pile is represented, which is hardly the case in a hand-sample. As a variation from trenching, trial pits may be sunk into the pile, the aliquot portion being reserved. It is this small, reserved part of the whole which is subjected to regular sampling methods. The method is manifestly imperfect, since most of the pile is unrepresented.

We come now to the complete methods of sampling, one of the older being:

Coning and quartering.—In connection with this a starting operation is to shovel over the entire pile taking out the aliquot portion, about every tenth shovelful, for the sample. The work, to save unnecessary labor, is generally done

as the car or wagon is being unloaded. The sample is wheeled into the mill and put through a rock-breaker where it is coarsely crushed to about 1.5 in. size. As the ore is wheeled from the crusher it is put into a circle or ring. Standing inside this ring the men slowly circle around it, shoveling the ore to the apex of a cone which is forming in the centre. The ore is then worked down into a flat disk. This is marked into four sectors (whence the name of quartering), of which two are reserved and two rejected. The reserved sectors are shoveled back into a ring, and the men again form a cone. This is again flattened down and quartered, and the opposite quarters saved out. Thus the process goes on, coning and quartering the ore, until a single maximum-sized rich piece would appreciably raise the grade of the sample if retained or lower it if rejected. At this point the ore is crushed to 0.5 in. size by means of rolls. Coning and quartering is resumed until crushing finer, say to wheat size, is necessary. The ore is worked down to two pounds in weight and again finely ground to the desired finishing mesh of 80 to the inch. It is thoroughly mixed by 'rolling' on a piece of rubber cloth. This final product is placed in four 4-oz. bottles or in paper sample-sacks and marked with the name and particulars of the lot of ore.

Fractional selection.—This differs from the quartering method in that every second, or every fourth shovelful of the lot is retained for sample, being made into a cone for the purpose of mixing it. From this cone every second or fourth shovelful is again removed, and so on until it is necessary to re-crush the ore. After crushing the reduction takes place in the same way until the bulk has been made as small as desired.

The split shovel.—By this method a shovel, resembling a fork and made up of several troughs, is used. Half of the ore drops through the spaces between the trough and half is retained as a sample. The sample is passed over the split shovel, again reducing it by one half, and so on, until, as in the other methods, the entire quantity has been cut down to the desired amount.

Riffles.—This apparatus is used only for finishing a sample after it has been ground to 0.5 in. size or less. A riffle is a series of troughs 1.5 to 0.5 in. wide set in a frame and with equal spaces between. As in the split shovel, one half the ore is re-

tained in the troughs of the riffle and one half rejected. It has the advantage that all parts of each shovelful thrown upon it get representation.

Machine sampling.—It will be seen that the different methods of hand-sampling involve much labor, and it has been sought to overcome this by the use of machinery. Machines are of two different kinds: (1) Those which take part of the stream of ore all the time, and (2) those which take the whole stream at frequent intervals. Since the stream of ore is not homogeneous the first method is defective and the second is accordingly preferred. In the second method the scoop which passes through the stream should enter always at the same side since otherwise more is taken of the entering side which again may be richer or poorer than the leaving side of the stream. Fig. 13 is an example of the first type, the ore, as it falls, having portions successively cut out until at the bottom a small sample remains. The remainder, falling outside the tube, is rejected and is called the 'principal.'



FIG. 13.
PIPE ORE-SAMPLER.

The Vezin sampler (Fig. 14) is an example of the second kind. It consists of a sheet-iron double cone carrying scoops, and revolving 30 times per minute. A feed-chute delivers a stream of ore into the main hopper while the scoops, as they revolve, take out a portion of it to be delivered at the apex of the lower cone. The scoops together occupy one-fifth the circumference of the circle, and accordingly, take out one-fifth of the ore. One of them may be omitted, so that one-tenth may be retained. By repeating the process with another sampler, or by sending it back to the first one, the sample is reduced in bulk. For finishing, a riffle is used.

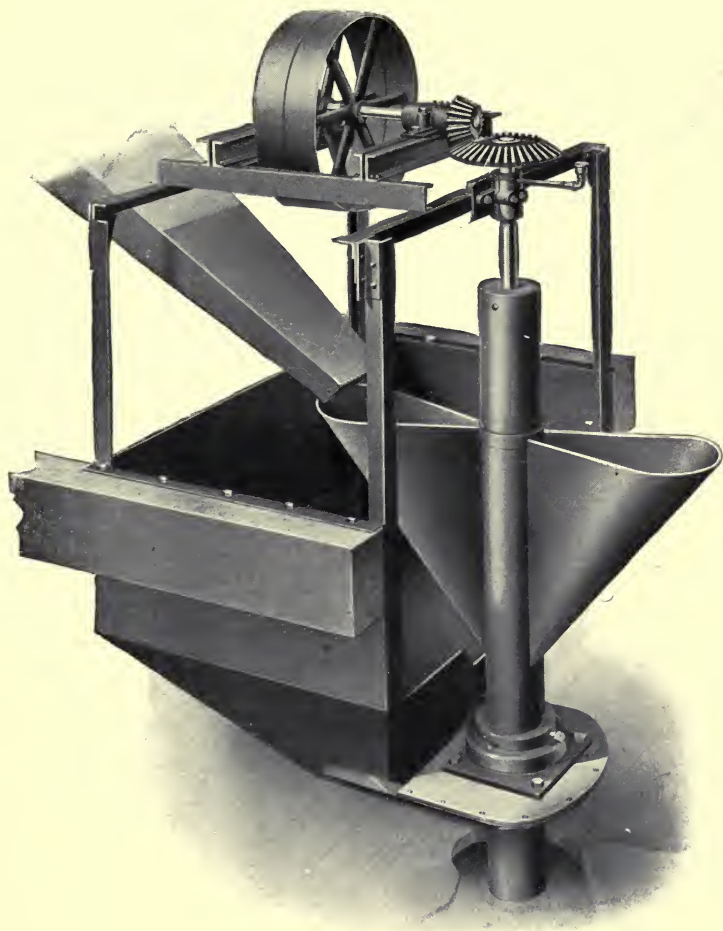

FIG. 14. VEZIN SAMPLING MACHINE.

Fig. 15 and 16 represent in plan and elevation a small sampling works of a capacity of 10 tons hourly. One-fifth to one-tenth of the ore in the car is delivered to the mill, the principal being retained in the car for delivery to the main storage bins. From the Blake crusher the ore passes by elevator to a Vezin sampler, where one-fifth (or 2 tons) is cut out and passes on to the Dodge crusher, for finer crushing. It is then elevated to a second Vezin sampler which again cuts out one-fifth, leaving 800 lb. It then passes to the large rolls. It is now elevated to a third Vezin sampler, which cuts out one-tenth, leaving 80 lb. of sample, this passing on to the small rolls. This quantity, 1-250th of the ore, may be reduced by quartering, and the small amount left, ground in a sample grinder. The discarded portions of the ore are conducted by means of an elevator and swinging spout into any desired bin where it is retained until the ore has been settled for.

Requirements for accurate sampling:

(1). *Frequent taking*, which will ensure representation of every part of the ore.

(2). *Mixing thoroughly*, which makes the ore uniform throughout.

In progressive crushing we make the ore finer as the sample diminishes in weight, so that the ratio which the size a single rich piece bears to the size of the sample shall not be exceeded. The following table expresses these relations:

Table showing size to which ore is to be crushed.

Weight of Ore	Value in Silver Oz. per Ton		
	Highest 300 Average 50	Highest 3,000 Average 75	Highest 10,000 Average 500
100 tons to 10 tons.....	Cocoanut	Fist	Fist
10 tons to 1 ton.....	Orange	Egg	Walnut
1 ton to 200 lb.....	Walnut	Chestnut	Chestnut
200 lb. to 5 lb.....	Pea	Wheat	Wheat
5 lb. to bottle sample....	20-Mesh	25-Mesh	50-Mesh
Bottle sample.....	80-Mesh	100-Mesh	120-Mesh

Cost of sampling.—The cost of handling the ore, delivering it to bins, and wheeling the retained fifth or tenth into the sampling mill may be taken at 10c. per ton. The cost of hand-sampling

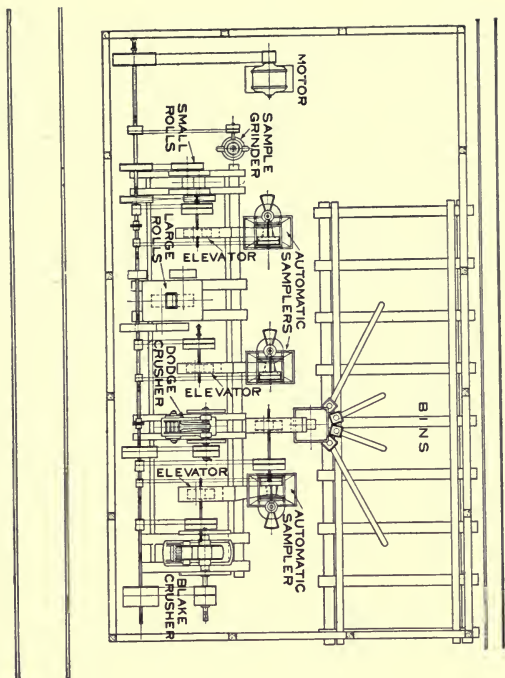

FIG. 15. SAMPLING WORKS, PLAN.

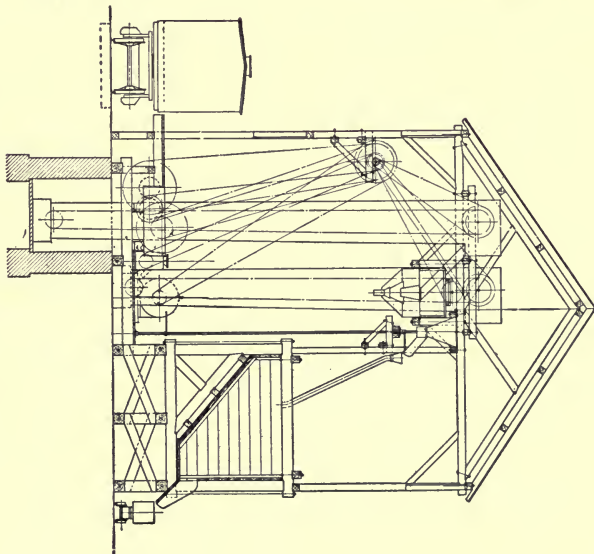
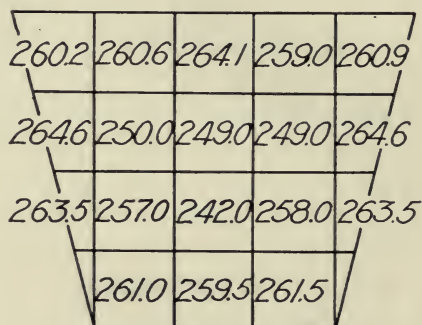

FIG. 16. SAMPLING WORKS, ELEVATION.

this retained portion will be 75c. per ton. At the Metallic Extraction Co.'s Works, Cyanide, Colo., ore was thrown out of the car into a feed chute, and was coarse-crushed, automatically sampled, and delivered to storage bins for 11c. per ton. At custom sampling mills a charge of \$1 to \$2 per ton has been made for sampling, storing and selling the ore, the sampling mill acting as selling agent. This price is made even lower for concentrates requiring no crushing.

THE SAMPLING OF METALS.

Bars of gold or silver are sampled for assay, either by taking granulations, or by a chip-sample. In the first case, while the metal is in a molten condition, a small ladleful, of an ounce or less, is taken and poured into a bucketful of water. This gran-



Average 258.2 oz. silver per ton

FIG. 17. SECTION OF BAR OF BASE-BULLION.

ulates the metal, so that it can be easily weighed in assaying. The chip-sample is taken from diagonally opposite edges of the bar or ingot by cutting with a cold-chisel. The average of the two chips, thus obtained, is taken for the true result.

Base bullion.—This is the lead which comes from the silver-lead blast-furnace, containing commonly 100 to 500 oz. silver per ton. When poured into molds and allowed to cool, it will segregate; that is, the exterior or first-cooled portions of the bar will be higher by several ounces than the central portion, as shown in

cross-section Fig. 17. Base bullion was formerly sampled by taking two chips or punchings, one from the top and one from the bottom of each bar. The punch, Fig. 18 (somewhat resembling a belt punch), 1.125 in. diam., was driven into the soft metal by a sledge, taking a cylindrical piece. In a carload of 400 bars there would therefore be 800 chips. These chips, melted together,



FIG. 18. BASE-BULLION SAMPLING PUNCH.

would be the sample of the 400-bar lot. The preferred way, though, is to re-melt the metal in large kettles, skimming and stirring it, and casting it again into bars or ingots. While molding, portions are taken from the molten bath and poured into bullet molds, each bullet being approximately one-half assay ton, which is then trimmed to the exact weight.

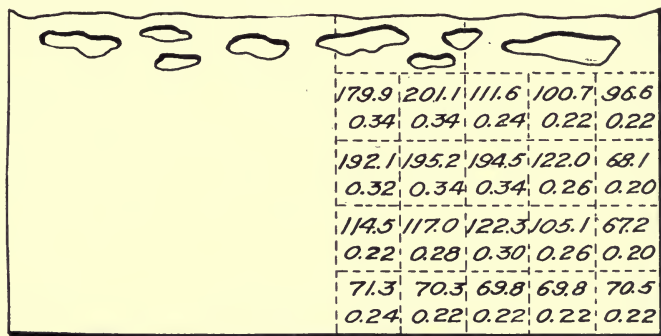

FIG. 19. SECTION OF BAR OF INGOT COPPER.

The segregation of copper, in bars, is much more marked as shown in Fig. 19, which gives the values in ounces per ton of both the contained silver and gold in a pig of blister copper 5 in. deep. The usual method of sampling such bars is to drill them, retaining the shavings or chips for a sample. Manifestly, such a sample would be uncertain, depending upon where it was taken. To minimize this difficulty, it is customary, in a given

lot, to drill each succeeding bar in a different spot so as to obtain an average. The quality of copper for conductivity is often a factor, for which a dipped sample of the charge of copper in the furnace, just before it is molded, is made into a wire and tested.

In sampling base-bullion where the variations are smaller, chip samples are fairly accurate, but not in anode or blister copper. To ensure such accuracy it is now becoming the custom to melt the whole lot of metal to be sampled, to stir it well together, to take out a ladleful and to pour it into water in the case of copper, or into a small mold in the case of lead, the idea in the latter case being to cool the metal so quickly that segregation cannot occur.

Pig iron is sampled and graded both by its appearance when fractured and also by analysis. When the latter method is used, the determination is made from drillings taken from a small molded sample. The silicon present is the chief determining factor of its grade.

The sampling of metals is described at greater length in discussing their reduction from ores.

8. PREPARATORY BREAKING, GRINDING, OR CRUSHING OF ORES.

The amount and method of breaking or crushing varies according to the further treatment of the ore.

Ore frequently comes from the mine or the concentrator already hand-sorted, and from the concentrating mill more or less finely ground, in which case it is already fine enough for metallurgical treatment by the several methods to be described.

Crushing for sampling.—This operation varies with the facilities for crushing, and with the nature of the ore and the coarseness at which it is desired to keep it.

Thus, in blast-furnace smelting, it is desirable to keep the ore nearly as coarse as it comes from the mine. (Pieces as large as the double fist are very suitable in the ore mixture, and conduce to the openness of the charge and the more rapid operation of the furnace.) When in sampling, an aliquot portion is taken, as for example, every fifth or every tenth shovelful, the

principal is broken no farther; this is a favorite way of sampling for blast-furnace work. For certain ores whose precious-metal content is high and variable, finer crushing is necessary, and the blast-furnace must make the best of the inconvenience thus imposed. When a suitable sampling mill is provided, the crushing of the ore can be cheaply done, and the ore more thoroughly averaged. This crushing (called coarse crushing) may be down to 1 in. or to 0.75 in. cubes and smaller. The sample taken from this is again crushed finer, say to 0.25-in. mesh; and after cutting down the still smaller portion is ground to say, 30-mesh. Finally the very small reserved quantity intended to be used as an assay sample is ground to pass an 80 or 100-mesh screen.

Breaking or grinding, to fit the ore for further treatment, may be divided into:

- (1). Breaking for blast-furnaces.
- (2). Breaking for stall or heap roasting.
- (3). Crushing for reverberatory melting.
- (4). Crushing for reverberatory roasting.
- (5). Crushing for leaching or percolation.
- (6). Crushing for distillation.
- (7). Crushing or grinding for amalgamation.

Breaking for blast-furnaces.

The conditions have been referred to under the head of 'crushing for sampling.' The larger lumps are broken with 6-lb. hammers to pieces not exceeding in size the double fist. This size of hammer, which is more serviceable than a larger one, should have its faces rounded to increase the efficiency of the blow. Where all the ore is both oxidized and lumpy the whole of it is passed through a rock breaker set quite open—say $2\frac{1}{2}$ in. This is desirable, however, only when the blast-furnace charge is liable to be too open. Quite commonly the reverse prevails, because of the large amount of fine ore which must be run. With a coarse charge, it is advisable also to crush the fluxes, that is, the iron ore and limestone. When the charge is fine, the limestone, at least, may be fed in, in large lumps of 50 lb. and less. Limestone thus fed in, when heated in its downward passage, finally disintegrates, up to which time it has performed its duty in making voids in the charge.

An objection to finely pulverized ore in the blast-furnace is that it is likely to be borne away by the force of the blast. By moistening the charge this loss is lessened; but the effective way is to press this fine material into bricks, which become hard on drying, and are unaffected by the blast. This adds, however, to the expense of treatment.

(2). *Breaking for stall or heap-roasting, or stack-roasting.*

This work may be performed either by means of a jaw crusher (by mechanical means) or with the spalling hammer. By the former method the work is done more cheaply but with the making of a larger quantity of fine than in the latter method. Peters cites a case* where, in breaking by a jaw crusher, the fines amounted to 17.3% while with hand hammers there was only 9% fines.

On the other hand, machine crushing cost 9c. per ton while by hand-spalling the cost was 35c. He remarks that, as about 10% of the fine is sufficient for finishing the roast-heaps or stalls, any excess is to be avoided. Of course, this rule does not apply when the excess of fine can be roasted in a reverberatory furnace.

(3). *Crushing for reverberatory melting or smelting.*

Since the ore is to be fused into a liquid mass it is not important that it should all be crushed fine. It is well, however, to have no pieces larger than a hen's egg. The ore leaves the charging hopper more readily and probably melts down more evenly than in larger lumps. One great advantage of the reverberatory over the blast-furnace is that at the time of charging, the damper of the furnace may be closed until the dust, arising from dropping the charge, has subsided so that there is no serious loss of fine or dusty ore. Such light material, in the blast-furnace, would be blown away.

(4). *Crushing for roasting in reverberatories.*

The ore must be crushed fine enough to roast readily. An ore containing iron sulphide disintegrates in roasting, so that crushing to pass a 2 or 3-mesh screen is sufficient. Many ores and mattes require finer crushing, to 4 and 6-mesh, for example. For leaching, the ores are generally ground finer than is necessary for their efficient roasting, though it must be remembered that,

*'Modern Copper Smelting,' by Dr. E. D. Peters.

where it is desired to have a hot finish to the roast, the smaller sizes roast more readily, and the sulphides are more completely broken up. This applies especially in the Stetefeldt furnace, where the time of roasting is limited to the time occupied by the fall of the particles of ore to the bottom of the tower.

(5). *Crushing for leaching or percolation.*

In this operation one is governed by the activity or efficiency of the leaching solution, whether of chlorine, bromine, cyanide of potassium, hyposulphite of soda, salt, or simple water. With an active agent like chlorine the reduction in size may be less than is the case with cyanide of potassium. Again, the ore may be porous, or the precious metal may be in a more soluble condition or may be rendered so by the preliminary roasting. Thus an ore crushed to 10-mesh for chlorination would be broken to 30-mesh for cyaniding. Another point to be particularly observed in leaching is to avoid the making of slimes in crushing. Any considerable quantity of this extremely fine ore hinders percolation greatly. Consequently gradual reduction methods should be followed in crushing the ore, that is, the ore, already fine enough, should be screened out as fast as it is formed and removed from the further action of the crushing machinery. On this account those machines where the ore falls away from the crushing surfaces are to be preferred.

(6). *Crushing for distillation;* as in the distillation of zinc, mercury and cadmium.

The ore is broken down to 8 or 14-mesh for zinc and cadmium which is quite as fine as is necessary for the preliminary roast. For cinnabar minerals the ore is fine enough when of 1-in. size or less.

(7). *Crushing for amalgamation.*

The ore is finely comminuted to pass through a battery screen and a good deal of slimed material is produced. This is not objectionable when the pulp passes over the apron plate. In silver milling the ore is finely ground in an amalgamating pan, thus comminuting the coarser particles which have got through the battery screen. Grinding is continued until the pulp feels smooth and free from grit between the fingers. All of it is practically finer than 200-mesh.

Dry crushing.

In preparation of ore to be finely ground for roasting, which is to be afterward amalgamated, or to be treated by leaching for the extraction of its metal, dry crushing is the method followed.

In preparation of a considerable quantity, say 200 tons per day, the following method might be employed.

Coarse crushing.—A 20 by 12 in. Blake rock-breaker will crush 25 tons per hour from 12-in. pieces down to 1.5-in. size and can take the ore as it comes from the mine at that rate. However, there are clayey, talcy, wet ores containing as high as 25 to 30% moisture, which stick to the machine and are impossible to crush in their wet state. Such ores should be first dried, using the cylinder-dryer described below.

A set of 36 by 16-in. rolls will crush about 25 tons per hour through a 0.75-in. screen. This material is now fine enough for automatic sampling, the whole stream passing over a Vezin sampler (see Fig. 14) making 40 rev. per min., the rejected portion of four-fifths going to storage bins. The sample is completed by the well-known sampling methods. One sampler machine can handle 200 tons in 10 hours of day-work.

Fine crushing.—This work is done on both day and night shifts, that is to say continuously. The ore, 0.75 to 0.50-in. in size, is drawn as desired, from the storage bins by two-wheeled buggies, and is dumped into the hopper of the cylinder-dryer where a feeding shoe, or other automatic feeder, continuously supplies it to the dryer. A cylinder-dryer 24 ft. long and respectively 4 and 5 ft. diameter at the two ends will have sufficient capacity to take care of ore containing an average of 6% moisture, at the rate of 10 to 15 tons per hour, drying it to 1% moisture or less, and at the same time heating it to 120° C, so that it will readily pass through the screen of a trommel. When in this condition the ore is lively and will screen readily, but were it not for this drying the ore would stick to, and 'blind' the screen. The cost of such drying may be put at 5c. per ton.

For fine crushing a series-system, using four rolls (see Fig. 21) is adopted as follows:

Rolls *a* reduce the ore from 0.75 down to 0.25 in. It is elevated by a belt elevator to a trommel, having 0.25 in. perforated plate screens, the oversize going back to rolls *a* while the undersize passes on to rolls *b*. These crush the material, which is again

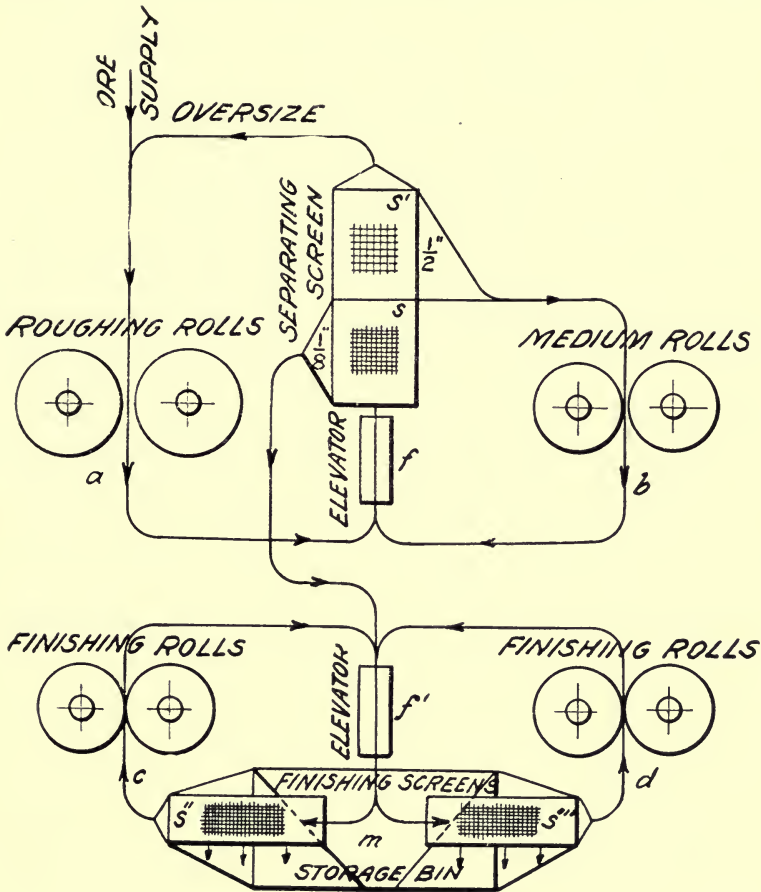

FIG. 21. FLOW-SHEET FOR DRY CRUSHING.

elevated to a trommel with a 5-mesh wire screen. The oversize of this trommel goes back to rolls *b*, while the undersize is divided, one-half going to each of the two finishing rolls *c* and *d*. Here, as before, the oversize of each roll, after passing over a 30-mesh

trommel, goes back to the rolls, while the undersize, being now reduced to 30-mesh (0.02-in. particles) goes to the storage bin *m*, and is ready for further metallurgical treatment. One square foot of 30-mesh screen will take care of 6 cu. ft. of finished product in 24 hours. The desired quantity of 200 tons can be worked off in 20 to 22 hours, thus allowing time for delays and repairs. This gives the capacity of each set of finishing rolls at 5 tons per hour.

This system of gradual reduction is preferably followed because the product contains a minimum quantity of slime, and being granular, is more easily percolated or leached. As each piece or particle of ore is crushed by a single nip, the fine material is screened out and removed from further unnecessary breaking, or the consumption of more power in so doing. In this respect crushing by rolls has an advantage over stamps, in that the product is more granular and uniform. In stamp-milling, however, after the coarse crushing to 1.5 in. the rest of the work can be done in a single machine to the finest mesh desired.

To keep rolls up to their work they should be furnished with strong springs, with as high as 15 tons pressure to a bearing; that is to say, the springs should be such that if a hard object gets into the rolls, they will only begin to open when a pressure of 30 tons has been overcome. The speed of rolls varies with the coarseness of the material to be crushed, the coarse rolls running at say 600 ft. peripheral speed while fine rolls go at 1,000 to 1,400 ft. per minute.

Cost of dry sampling and crushing as above.—The prime cost of crushing ore in Colorado to 30-mesh, in preparation for roasting or leaching, may be taken as follows:

For coarse crushing and automatic sampling.	\$0.106
For fine crushing, including drying.	0.275
For power	0.105
	\$0.486

or in round numbers, 50c. per ton to which must be added cost of management and office expense, rates and taxes, insurance, cost of water supply, improvement, and general expense.

9. THERMO-CHEMISTRY AS APPLIED TO METALLURGY.

One of the most striking phenomena of thermo-chemistry is the combustion of fuel, in which carbonaceous material becomes united to the oxygen of the air, the reaction being accompanied by the development of heat. The assayer observes that heat is developed as the result of cupellation. The air passing over the surface of the molten lead oxidizes it, producing heat and enabling the operation to progress at a temperature much below the melting point of litharge which consequently forms in crystals upon the borders of the cupel. Again, a mixture of oxygen and hydrogen is exploded by the momentary assistance of an electric spark, water being formed, and the reaction being accompanied by the development of much heat. The heat generated in the formation of many chemical compounds has been determined, the unit by which it is measured being the heat required to raise a unit weight of water one degree Centigrade. The experimental determinations are made with a few grams of substance, and, hence, it has been customary to use as a unit the heat required to raise the temperature of one gram of water to one degree Centigrade. This unit is called a small calorie (cal). The amount of heat thus taken is, however, too small for practical application, so that it has been customary to use the heat needed to raise one kilogram of water to one degree Centigrade, called a large calorie (Cal), or one thousand times the other quantity. Where the unit weight is one pound, we have the pound-calorie, in which that amount of water is also raised one degree Centigrade. This unit will generally be used in the calculations to follow. When 12 lb. of carbon (C) are burned with 32 lb. of oxygen ($2O$) there results 44 lb. of carbon dioxide (CO_2), and this is expressed by the chemical equation (1) $C+2O=CO_2$, that is to say, 97,000 calories are developed, or 8,080 calories for each pound of carbon burned. It must be understood, in writing equations, that the molecular weight is referred to as expressed in an ordinary chemical equation. This may also be indicated thus: (2) $C, O_2 = 97,000$, meaning that the separate molecules C and O are thus united. If we burn carbon with a limited quantity of oxygen, as in the

upper part of a thick fire, CO gas results thus (3) $C + O = CO$,
 29,000
 or, as otherwise expressed, (4) $C, O = 29,000$, or the heat developed by the incomplete combustion of carbon, is but 2440 lb. calories. If we burn the CO gas, thus formed, with an excess of air we again obtain carbon dioxide, thus (5) $CO + O = CO_2$.
 68,000

This means that before the new compound can be formed the CO must be decomposed, using up in so doing the heat just obtained. The equation may also be given (6) $CO, O = 68,000$ the comma showing what are the elements to be combined. It will be noted that the heat developed by the burning of the carbon in two stages, viz: (6) $29,000 + 68,000 = 97,000$ amounts to the same as though the carbon had been at once completely burned to carbon dioxide. We thus get the following laws:

1. *The amount of heat needed to decompose a compound into its constituents is equal to that evolved when that compound is formed from those constituents.* When a reaction takes place by which heat is absorbed, as in the decomposition just referred to, it is called endothermic. On the other hand where heat is evolved the reaction is an exothermic one.

2. *The heat evolved in a chemical process is the same whether it takes place by one or by several steps.* See equations (5) and (6).

In comparing reactions (1) and (3) it may be said that in presence of an excess of oxygen, the reaction (1), by which CO_2 is formed, will take place rather than reaction (2) in accordance with the law of Berthelot, namely:

3. *Every reaction which takes place independently of the addition of energy from without the system, tends to form the combination which is accompanied by the greatest evolution of heat.*

The reaction produced by the oxidation of lead to litharge, referred to above is thus expressed: $Pb + O = PbO$ or otherwise $Pb, O = 51,000$; but on account of its high atomic weight this is but 249 Cal. per pound of lead.

To determine accurately the heats of formation of fuels and other compounds, the Mahler bomb calorimeter (Fig. 22) is much

used. It consists of a steel shell or bomb *B* having a capacity of over a pint. The shell is closed by a screw-cap, with a connection *X* for the introduction of oxygen from a cylinder of compressed oxygen gas *O*. Within the bomb is suspended a capsule *C*, in which is placed the substance to be tested. The bomb is then closed, placed in the water of the calorimeter *A*, and charged with the compressed oxygen. The fuel is ignited by the aid of a wire *F*, which is heated to redness by an electric current. An explosion takes place, and the heat of the completely burned fuel is transmitted to the water of the calorimeter. The water surrounding the bomb is kept in circulation by means of a mixer *S*,

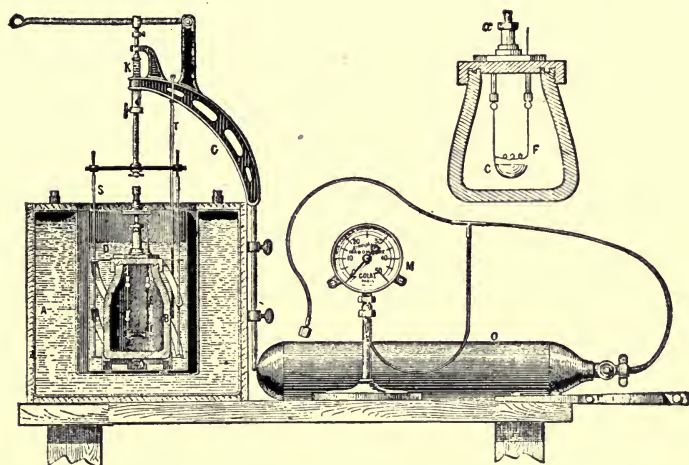
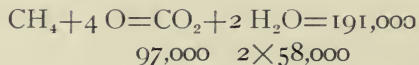

FIG. 22. MAHLER BOMB CALORIMETER.

and the rise of temperature noted by the thermometer *T*. The total heat developed is calculated with certain corrections from the amount of calorimeter water and the rise of temperature. In those cases, where the formation temperatures of oxides or silicates are desired, it is accomplished by melting or oxidizing the compound in the bomb with a known weight of a well-determined fuel. The total calories evolved would be the algebraic sum of those of the desired reaction and of the fuel.

Heat of formation.—The amount of heat liberated or absorbed in the formation of a molecule of a substance is called the heat of

formation, and is expressed, either in the large pound-calorie, or in the small gram-calorie. If the heat of combustion of a compound be subtracted from the heats of combustion of its elements, the remainder is its heat of formation. The heat of formation of methane (CH_4) is determined indirectly from the heat of combustion thus:



The heat of formation of methane is therefore $(97,000 + 2 \times 58,000) - 191,000 = 22,000$ calories.

While the equations heretofore given are exothermic, it may often happen that a reaction takes place accompanied with the absorption of heat, as in the reduction of metals. Thus, we have a reaction which takes place only at a red heat because of the large amount of heat absorbed in the reaction:

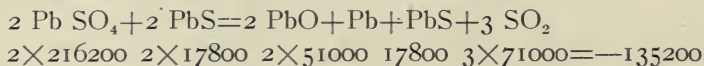

PART II. ROASTING

PART II. ROASTING.

10. THE CHEMISTRY OF ROASTING.

For purposes of illustration let us consider the reverberatory roasting of an ore containing mixed sulphides, galena, blende, pyrite and chalcopryrite, together with a quartz gangue, which prevents cohesion of the particles of ore and makes the charge more open and accessible to air. The ore is first dropped upon the hearth at the cooler end of the furnace where the temperature ($350^{\circ}\text{C}.$) is only sufficient to drive off moisture and to start the reactions. In 10 to 15 minutes the charge becomes hot enough for oxidation of the pyrites to take place, as shown by a blue flickering flame which plays upon the surface of the charge. The second equivalent of sulphur in FeS_2 is feebly held, so that it comes off, burning to SO_2 according to the reaction,

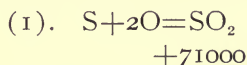

or $71000 \div 32 = 2220$ pound-calories per pound of sulphur burned.

At the same time, the FeS remaining, together with the other sulphides CuS , ZnS and PbS , begins to oxidize, especially the FeS , which acts according to the reaction:

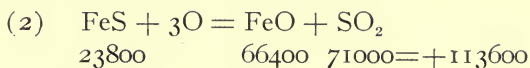

or, per pound of sulphur, $\frac{113600}{32} = 3550$ pound-calories.

The cupric sulphide of the chalcopryrite acts according to the formula:

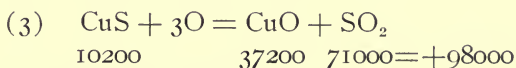

or, per pound of sulphur, $\frac{98000}{32} = 3030$ calories.

The blende, under the action of the air, is affected in the same way:

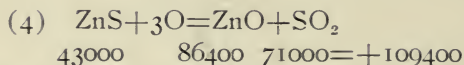

or, per pound of sulphur, 3420 calories.

Galena also roasts according to the formula:

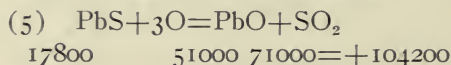

from which we obtain 3250 calories per pound of sulphur. It will be noticed that the heat evolved per pound of sulphur is much the same in each case; and hence such sulphides as FeS, containing much sulphur, give off the most heat in roasting. The above reactions act superficially and their activity is increased by stirring the charge. Naturally, FeS is first formed where most exposed to the air, which, reacting upon it, forms iron sulphate.

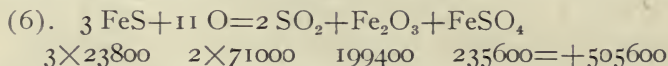

or, per pound of sulphur 5260 cal., a most energetic exothermic reaction.

As the ore is moved to a hotter portion of the furnace the activity of these reactions continues, keeping up the temperature; but at the just visible red (590°C) the just formed iron sulphate begins to decompose, reacting on the cupric oxide:

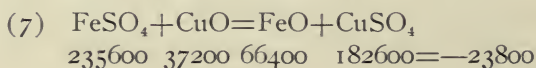

and

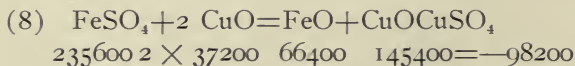

There remains unused, however, much iron sulphate which is decomposed at the higher temperature, thus:

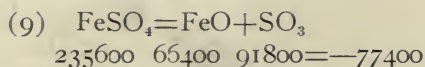

It will be noticed that these latter three reactions (7), (8), and (9) are endothermic. At a slightly greater heat (655°C.) the just formed cupric sulphate (reaction (7)) begins to decompose; and at a dark red heat (705°C.) the same change begins upon the

cupro-cupric sulphate (reaction (8)). These decompositions of the copper sulphates are complete at 850° C. or at a cherry-red heat. At this time also the zinc and lead oxides, reacting with the copper sulphates, are changed to sulphates:

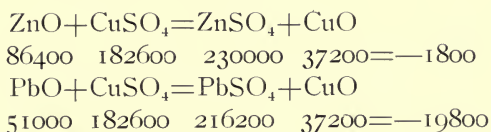

As the heat increases these sulphates again decompose, the zinc sulphate more readily than the lead sulphate. At $1,050^{\circ}$ C, or a dark-orange heat, copper oxide is reduced to cuprous oxide (Cu_2O) and ferric oxide to the next lower oxide, Fe_3O_4 .

At this stage the ore begins to fuse together, or agglomerate slightly, and is then withdrawn from the furnace. If much lead exists in the ore, even this temperature cannot be attained without the ore beginning to soften, when roasting must cease because the charge is no longer porous. In such case the lead and zinc sulphate are imperfectly decomposed, and the sulphur is not well eliminated.

Sometimes, and with zinciferous ores, the roaster is arranged with a fuse-box, into which the charge is brought and melted down with the addition of some silicious ore, the silica reacting on the zinc and lead sulphates according to this formula:

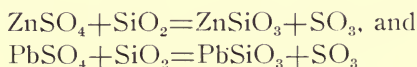

the sulphur being eliminated as sulphuric anhydride.

It has been found that with 2% by volume, or 4.4% by weight of SO_2 in the escaping gases, roasting proceeds actively. This corresponds to 23 lb. air per pound of SO_2 , or to 46 lb. of air per pound of sulphur driven off. If more air is admitted than this, then the charge gets cooled; if less, roasting proceeds slowly; with 8% SO_2 , it ceases altogether. Thus, not only must the heat be sufficient, and new surfaces presented to the action of the air, but the air must be fairly fresh and the SO_2 evolved must be promptly removed from contact with the ore by means of the draft.

The various reactions described above need time for their completion; and the larger the body of ore, the longer it takes to complete the roast. If a few grams of ore are roasted in the muffle the operation is complete in half an hour, but, in a reverberatory furnace roasting 14 tons per day the same operation takes twenty hours.

The temperatures at which the various reactions take place are as follows:

At 350°C. the sulphur of sulphides begins to burn off.

At 590°C. just formed iron sulphate (FeSO_4) begins to decompose.

At 655°C. just formed copper sulphate (CuSO_4) begins to decompose.

At 705°C. cupro-copper sulphate (CuOCuSO_4), formed at the same time as the copper sulphate (CuSO_4), begins to decompose.

At 850°C. copper sulphates are quite decomposed.

At 835° to 850°C. the maximum amount of soluble silver sulphate (AgSO_4) is formed.

At 1050°C. copper oxide (CuO) is reduced to Cu_2O .

At 1100°C. ferric oxide Fe_2O_3 is reduced to the next lower oxide Fe_3O_4 .

Losses in roasting.—This depends upon the extent to which the roast is carried as well as the nature of the ore. If the ore is dry-roasted, so that it is not sintered at all, the lead-loss will be 2.5%, with no loss in silver. When the ore is agglomerated the losses are slightly higher; and when fused the losses are 15 to 20% Pb, 2 to 5% Ag.

The lead-bearing matte from the blast-furnace is also roasted, preferably in a reverberatory roaster. It requires a different treatment from ore since it contains but 20% S, does not take fire like a pyrite ore, and must have a good finishing heat in order to expel sulphur. Matte is considered to be well roasted when still containing 4% S. Ores low in lead may be easily brought down to 2 to 3% sulphur, while galena still retains 5 to 6% S when withdrawn from the furnace. Like matte, galena starts burning slowly, and must be slowly roasted—premature heating at once sintering it, thus stopping further roasting.

The following is an analysis of a leady matte (unroasted) from Pueblo, Colorado:

10.72%	PbO	0.56%	As
0.61	Cu	0.41	CaO
24.01	S	0.47	MgO
52.27	Fe	24.4 oz.	Ag per ton
4.27	Zn		

with a ratio of sulphur to iron of 1 to 2.2.

II. ROASTING OF ORES IN LUMP FORM.

Heap roasting.—The roasting in heaps of sulphide ores containing copper, is an operation that must be performed with knowledge and care in order to obtain satisfactory results. The selection of this method involves a careful consideration of the environment. Thus, it may not be adopted in a settled country, where the fumes from it are a nuisance, or where it is likely to damage cultivated crops, surrounding vegetation, or live-stock. In the arid and sparsely settled regions of the Rocky Mountain States, it may often be used to advantage. At a moderate-sized installation, where not more than 25 tons of sulphur are evolved daily, the zone affected may not be more than 4 miles in extent, and the roasting site may then be chosen with this in view. Often prevailing winds, blowing from a single quarter, may permit the placing of roast-piles so as to give practically no offense. Indeed, this matter should be considered with relation to the plant itself and the ground chosen, so that the smoke shall be seldom driven in the wrong direction. A roast-yard should be of ample size, approximately level, and protected from flow of storm-water. At Jerome, Arizona, a tram track following the contour of the hillside has the roast heaps adjoining it, so that the ore is conveniently transferred to the ground, and the roasted ore carried to the smelter by the same tram-system. This tends also to scatter the heaps, so that fumes do not interfere with making them up.

An ordinary pile, say 40 ft. long, 24 ft. wide and 6 ft. high, and containing 240 tons, will burn for 70 days, to which is to

be added 10 days for removing and rebuilding. This will make a yield of 3 tons of roasted ore daily. A foundation should be prepared by leveling off the ground, and making a final surface of clayey loam. Upon this is placed a layer of ore-fine to the depth of 3 or 4 in. As this layer gets gradually roasted, it is sent to the furnaces, fresh fine taking its place. A system of overhead tram-trestles (see Fig. 23 and 24) may often be put in, otherwise the ore is hauled by carts or brought in cars to the heap, and is then wheeled on.

The bents, shown in the figure, are 36 ft. apart, and trussed stringers, 10 by 12 in., carry the tram track over the roast-heaps. A turn-plate, with a movable track, serves to carry the ore to the full length of the roast-heap. This track, made with stout rails, is supported on movable trestles. The height of the pile will depend upon the character of the ore. Thus, an ore of 15% sulphur may be made 9 ft. high, while massive pyrite should be but 6 ft. in height for the best conditions of thorough roasting.

Upon a bottom of the fine is placed the fuel used to start the roasting. This consists of a layer of wood of 4 to 8 in. in thickness, the 4-in. layer being sufficient for the higher sulphide ores. The wood may be of any kind and length, especially when these higher sulphides are roasted. The cheaper wood, as old rails, logs, old tree trunks and twisted branches, can be taken for the central portion of the pile, using the more uniform wood for the outer four feet of the borders. The interstices between these closely packed pieces should be closed by laying in finer sticks, brushwood and chips, so that the ore will not fall through. Three chimneys, 8 in. square, made of four old boards set upright from the ground, are located evenly on the foundation, with channels, say 6 in. wide, containing kindling wood connecting the borders to the chimneys. The chimneys may also be made of sticks wired together, or old sheet iron bent in cylindrical form. The coarse ore, spalled so that none of the pieces are more than 4 in. in size and down to 1 in. diameter, is dumped upon the foundation. The ore is carried to the required height with as steep an angle as it will stand, forming a shapely frustum of a pyramid with sharp corners. Upon this, as shown in Fig. 23, is placed the raggings (from 1 in. down to 0.25 in. in size), forming a layer

thicker below and thinning out as we go up the pile. Following this, a thin layer of fine is added on the slopes of the pile.

It should be noted here, that far too much wood is apt to be used. About one cord, on an average, is required for 40 tons of ore. It must be remembered that the object of the wood is merely to start the pile burning. As the wood soon burns out, the pile will continue to burn by its own action. The more massive the pyrite the less wood required. While the pile should be

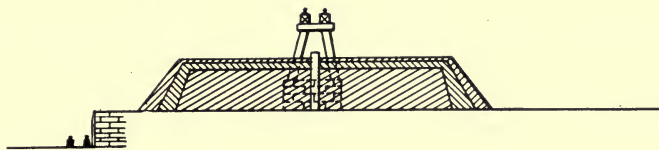

FIG. 23. ROAST-YARD WITH TRESTLE (CROSS SECTION).

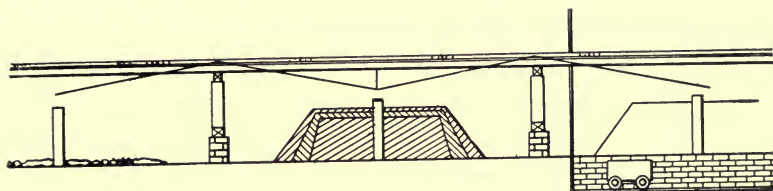

FIG. 24. ROAST-YARD WITH TRESTLE (LONGITUDINAL SECTION).

kept uniformly burning, no attempt should be made to unduly hasten the process, since with a high heat the ore will fuse together, thus stopping all further action.

The pile is fired at the different channels all around the edge, and preferably in fine, still weather. After 4 to 6 hours, the fire having spread over the entire area, the fine is put upon the pile, thinly on top and more thickly upon the sides and upon the borders of it below. The heap, especially at first, must be closely watched,—fine being placed to check the draft where it is too vigorous, and holes opened in the covering to draw the fire wherever the draft seems dead. The fine is freely used to control the fire, both on the borders and the top of the heap. The latter can be reached for examination and adjustment by taking advantage of the wind and the drafts of air.

Moderate rains and snow have but little effect on the process, but high wind from one direction is apt to stop burning on the windward side. This may, however, be prevented by a temporary fence placed as a wind-break. More abundant rains tend to leach out copper sulphate from the roast pile. Where such conditions exist, the heaps should be roofed over, or, where this is thought to be too great an expense, some saving can be effected by draining through ditches to a launder containing scrap iron, where the copper can be precipitated. In the dry region of the West, these considerations are less important. In places like Mexico, probably it would be best to suspend operations during the rainy season.

Wherever possible, roast heaps should be left undisturbed; but if ore must be used, it may be taken from the burnt-out and cooled portion of the pile, leaving action to continue on the hot core, still burning. The best way, however, is to start roasting operations weeks in advance of the smelting so as to have a well roasted supply to draw from. With care and experience it should be possible to roast 90% of the ore placed on the pile, including the fine.

Cost of heap roasting. We give the cost of roasting at Ducktown, Tenn., at 42c. per ton, while Peters gives 48.5c. per ton for the items of fuel, labor, and supplies. In the latter case common labor was estimated at \$1.50 per day. Heap roasting can often be contracted for to advantage. At the United Verde at Jerome, Arizona, 75c. per ton was paid on contract. Heap roasting, skillfully conducted, will reduce the sulphur from 40% and over to as low as 7 and 8%. The roasted product has an earthy, irregular surface of a blackish brown hue, and is lighter to the hand and more porous than the raw ore.

Heap roasting of matte. Matte in lump form can be well roasted in heaps, but, unlike ore, requires two or more burnings. After the first firing, in spite of the greatest care, the matte shows but little of the profound change it has undergone. At the second burning, with a somewhat larger quantity of wood, the results begin to show, a large portion of the twice-burned material then appearing light, porous and with no raw interior. In fact, the thoroughness of the roast may be determined by the feeling of

the lumps in the hand. If such lumps are broken open, they no longer have a raw core or centre.

The wood bed for matte can be prepared as for ore, but the pile is only 12 ft. square by 6 ft. deep, with a single chimney in the centre. The broken matte with its fine constitutes the heap, which is covered by thoroughly roasted ore which is fine enough for the purpose. The burning of the heap will take 10 days, after which the heap is broken up, and the partly roasted material made into a new pile. It is a good plan, in this new pile, to introduce one or two layers consisting of chips and bark, which have a reducing effect on impurities, and also furnish more uniform heat to the mass. Finally at the next turning over, a large portion suitable for use may be sorted out, the partially burned remainder going to a fresh heap. Peters gives the cost per ton for roasting matte as \$2.05 for the three burnings.

Relative advantages of heap and of stall roasting. Heap roasting has the advantage that it requires only the necessary site and no investment for plant. The method is a simple one and the results satisfactory. On a small scale primitive methods of handling materials are sufficient, but on a larger scale we must not forget the costs of grading, for trestles, trackage, etc. Stall roasting saves much time, requiring 10 days, as against 70 days for heap roasting. But in large plants, where from 10,000 to 50,000 tons are in process of treatment, several hundred thousand dollars may be locked up in the heaps. By reducing this value to one-seventh an important saving is effected. In stall roasting the stack removes the fumes, and the entire contents of the stall get roasted. Rain and snow have but little effect on the roasting ore, and in a moist climate, leaching does not cause trouble. For stall roasting one-fifth of a cord of wood is enough for the charging of a stall, or one per cent of the ore to be roasted, while, in heap roasting, average practice calls for $2\frac{1}{2}\%$ of wood.

Cost of roasting stalls. Peters gives, for the cost of building 56 stalls, a total of \$3,303.80, or about \$60 per stall. The total includes \$448.80 for the necessary trackage. He estimates the cost of the track laid with 12-lb. rails at 51c. per foot. To this should be added about \$400 as the cost of the stack.

Cost of roasting in stalls. This may be assumed at 50c. per

ton, using the same figures for labor as in calculations for heap roasting.

Stall roasting. The principle of such roasting consists in enclosing the ore within walls or rooms called stalls, in the walls of which are contrived flues for the admission of air, and for the removal of smoke, by means of a main flue to a tall stack, thus shortening the period of burning, and at the same time removing the noxious fumes to the upper air. The stall consists of a small paved area surrounded by three walls, but having an open front, which, to confine the contents, is loosely built up at each operation. The back, or sides, are pierced with small openings communicating to the common flue of many such stalls. The surface of the ore

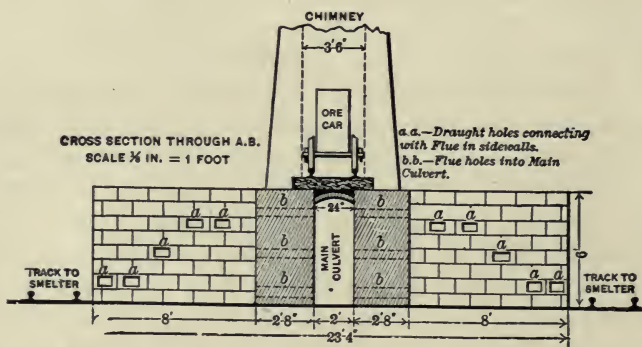

FIG. 25. ROASTING STALLS FOR LUMP ORE (SECTIONAL ELEVATION).

in the filled stall is covered with fine to keep in the heat, and to cause a suitable draft from below, through the flues, to the stack. Openings near the bottom permit the entrance of the air which also filters through the front wall.

Roasting Stalls for Lump Ore.

Fig. 25 and 26 represent, in sectional elevation and in plan, a battery of stalls for roasting ore. Fifty-six such stalls will roast 100 tons of raw ore daily, each holding 20 tons, taking 10 days to burn and clear out, or 2 tons daily per stall with a 12% allowance of time for repairs. The stall may be built of rough masonry laid in clay mortar or with slag-blocks cast at the works itself. The brick stack, 3 ft. 6 in. square inside, is 75 ft. high.

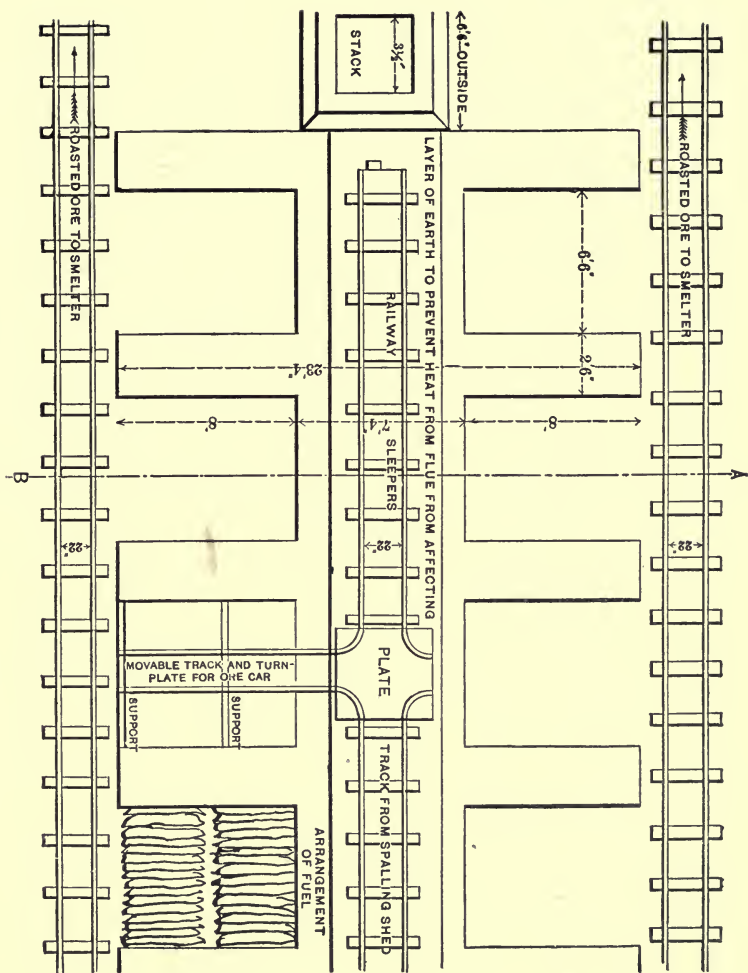

FIG. 26. ROASTING STAILS FOR LUMP ORE (PLAN).

To fill a stall, a central longitudinal and two lateral flues or passages for the admission of air are made with large irregular pieces of ore. These are filled and surrounded with kindling wood while the rest of the bottom is covered in a thin layer with long thin sticks, split from old logs and poles. The structure is now filled with coarse ore, the ragging being distributed through the mass. As the stall is filled, single small sticks of wood are put at the back and side-walls as well as occasional sticks at the front. A single carload of ragging is now added above the ore, then a 3-in. layer of shavings, bark and chips, a layer of 1.5 tons of fine, and finally, a coating of well-roasted ore. Sometimes a sheet-iron cover luted with clay at the walls, on the top of the ore, is of great advantage. By care it is possible to roast a proportion of fines in this way, thus disposing of a product which would otherwise have to be roasted in a reverberatory furnace. The stall having been fired, the roasting proceeds rapidly, and by the end of the fourth day the heap should be burning throughout. If the process is successful, it will be indicated by the swelling or rising of the contents of the stall, sometimes to the extent of 12 in. Because of the swelling, the front or temporary wall should also be braced to oppose the outward thrust. When the process goes on too rapidly, no such swelling occurs, but on the contrary the surface subsides where the ore, owing to the great heat, has melted together, and the roasting is imperfect. The heat can, however, be regulated by the use of fine for stopping cracks, and by the closing of draft-openings. Were the ore left to burn out and cool at leisure, it would take 15 days. In order to hasten the operation the front portion of the ore may be removed as it cools from the front, taking care not to penetrate beyond the cooled portion. Beginning at about the fourth day, it is possible to take away the ore, so that in 5 to 7 days the stall is again empty. As regards sulphur, stall roasting is perhaps a little less efficient than heap roasting.

12. ROASTING OF ORES IN PULVERIZED CONDITION.

This work is performed in furnaces, the ore being exposed upon a hearth to the action of the hot gases and air from the fire. We may divide them into:

(1). *Hand-reverberatory roasting furnaces or calciners* (intermittent discharge).

(2). Revolving cylinders with (a) continuous discharge, as the White-Howell and the Argall; (b) intermittent discharge, as the Brückner.

(3). Automatic reverberatory roasters or calciners with continuous discharge having (a) straight hearths, as the Brown-O'Hara and the Wethey; (b) curved or circular hearths, as the Brown Horseshoe, the Pearce Turret, the McDougall and the Herreshoff.

Besides these should be mentioned the Holthoff furnace, where the hearth revolves, the Stetefeldt shaft-furnace, the Edwards and the Merton furnaces.

In these various furnaces advantage is taken of the heat developed as the result of oxidation of the sulphides at the temperature of the furnace. If the percentage of sulphur is high, this is often enough to supply the required heat (after having once been started), without the aid of extraneous fuel. The various mechanical roasters roast ores very cheaply, but for ores containing lead, which may agglomerate, those which are stirred with rabbles do not give the satisfaction of hand-reverberatory roasters. With a slight accession of heat above the normal, due to a variation in the firing, the ore is liable to agglomerate or stick to the hearth. In the hand-reverberatory roaster, the same thing may occur, but the furnace in this case is quite accessible to cutter-bars by which such obstruction can be removed, and, even if the hearth builds up, the furnace can still be used. An effort has been made to remove these accretions in the rabble furnace by putting in a flat bar of iron in place of the blade, stout enough to tear loose these accretions. It has not, however, proved successful. The hand-reverberatory works to better advantage on ores which need a high finishing heat for breaking up the sulphates.

The long-hearth reverberatory roaster or calciner. Its essential features are a floor, or hearth, heated by a fire contained in a 'fire-box,' with a space beneath the grate called an 'ash-pit,' and separated by a 'fire bridge' from the hearth, upon which lies the ore spread out over its entire surface. The whole is covered

by a flat arch or 'roof' against which the flame 'reverberates' (hence the name of the furnace), heating the charge on its passage from the fire-box to the farther or 'flue end,' and thence to the chimney or stack.

These furnaces are distinguished from reverberatory smelting furnaces by having a much smaller grate area, and by having a flat hearth, at the same level as the side door-sills of the furnace.

Fig. 27 and 28 represent, in sectional plan, and in longitudinal sectional elevations, a long-bedded reverberatory roaster. Its inside width, for convenience in stirring and for moving along the charges, may be fixed at 14 ft., while its length varies according to the ability of the ore to generate heat by the combustion of its sulphur, the fire-place, without this assistance, not being able to maintain the requisite temperature beyond 32 ft. from the fire-bridge. The heat-generating power of the ore depends upon the percentage of contained sulphur, including the loosely held equivalent as found in iron pyrite. An ore, containing no more than 10% sulphur, would therefore be well roasted in a short furnace of 16 ft.; where there is 15% sulphur it is proper to add another hearth; a 20% ore would work rapidly in a three-hearth furnace; and where the ore contains 25% or more of sulphur, a fourth section should be added, making a total length of 64 ft. of hearth, which is long enough for any ore the metallurgist is likely to handle. Hearths of greater length have been tried, but have not been found satisfactory.

This kind of furnace has several advantages in the roasting of ore, namely, in starting the roasting operation at a low temperature at which there is but little tendency for the ore to crust, or stick together, thus ensuring its thorough contact with the air; the saving of fuel which in this length of furnace gives up much of its heat, and leaves the furnace at a temperature of about 260° C; the thorough stirring and turning resulting from the gradual removal of the charges to the front or bridge-end of the furnace; a uniform firing, and an economy in repairs and construction due to the uniform and moderate heat of the rear portion of the furnace, where red brick can be used. Moreover, the final heating near the bridge can be well performed for

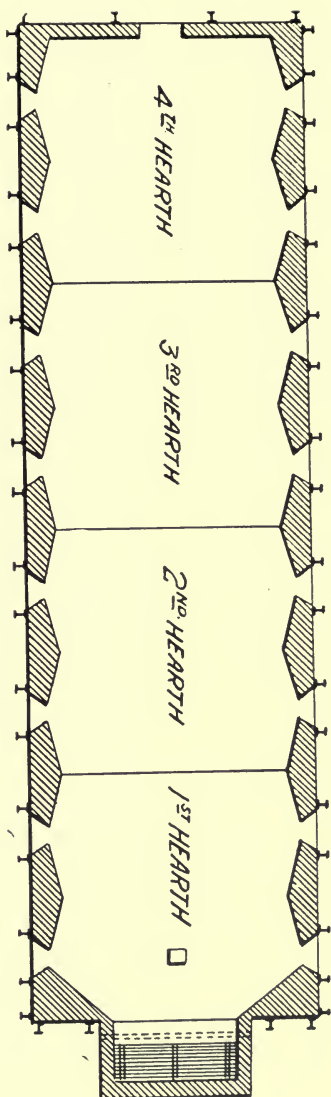

FIG. 27. ROASTING FURNACE (PLAN).

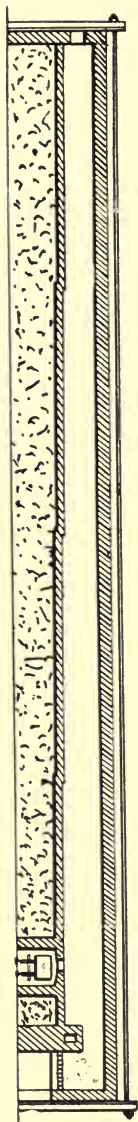

FIG. 28. ROASTING FURNACE (SECTIONAL ELEVATION).

breaking up sulphates and agglomerating the ore (provided it is somewhat fusible), so that it is in better condition for a blast-furnace operation. It must be remembered, however, that in copper smelting these pulverized ores are rather suited to the reverberatory furnace.

The cast-iron door-frames of this furnace are set 6 ft. apart and opposite one another. The door is made of a piece of sheet-iron removable by means of a 'lifter.' The hearth is divided by steps into divisions, so that successive charges shall not mix to the detriment of the roast, due to the mixing of the ore of a less roasted charge with that of the more advanced one. The furnace is strongly stayed and tied by buck-staves and tie-rods to resist the expansion due to the heated brick-work, and the thrust of the covering arch. At the front wall of the fire-box, openings of $2\frac{1}{2}$ by 4 in. are often left for the admission of air above the fire level. The bridge also has a transverse passage for cooling it, and for conducting air to the charge by means of transverse ports or openings, also $2\frac{1}{2}$ by 4 in., by which air gets in through the bridge-wall to the hearth. These openings furnish air which, together with that entering through the fire, produces an oxidizing atmosphere upon the hearth. The fire-box and the hearth for the first 15 ft. should be of fire-brick. A better quality of common brick may be used for the rest of the furnace, both for the roof and for paving the hearth. All such brick, however, must be laid in clay, not in lime-mortar.

The proper coal for a roaster is a free-burning, semi-bituminous coal which should be burned upon the grate in a shallow bed from 6 to 8 in. thick. It should be fed at intervals of 15 to 30 minutes in small quantities, and a roaster will consume 5,000 to 6,000 lb. in 24 hours. With a roaster of a capacity of 12 tons daily this is equal to a consumption of at least 20%.

The stack proposed by Peters for furnishing the draft to two roasters, is 42 in. square (internal dimensions) and 65 ft. high. Its cost, together with that of the short, connecting flues for the furnaces, he gives at \$728, while the cost of the roaster is given at \$2,713.

The cost of roasting a copper sulphide in the long-bedded reverberatory furnace is, according to Peters, \$1.81 per ton of



FIG. 29. ROASTING FURNACE WITH FUSE-BOX.

ore charged. If the ore contain lead, which makes it more difficult to roast, the price may go up to \$2.25 per ton.

The Slagging-reverberatory roaster. This consists of an ordinary long-bedded roaster to which has been added a slagging-hearth or fuse-box. Certain ores containing much zinc, and which in roasting produce sulphates that decompose with difficulty, are, in silver-lead practice, roasted, and then dropped down into the fuse-box where the entire material is melted into a slag. By so doing the silica present unites itself to bases breaking up their combinations as sulphates thus—

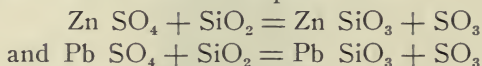

The sulphuric anhydride escapes in the fumes while the fusible silicates thus formed are skimmed as slag into slag-pots. This fused material can then be smelted without flue-dust loss.

Fig. 29 shows such a furnace, 72 ft. long by 17 ft. wide. It consists of a long brick hearth covered with a low arch and terminating next to the fire-box in a fuse-box or slagging-hearth. A high heat is carried at this point, so that the fire bridge must be protected by a water jacket or coil of water pipes inserted amidst the brick-work of the bridge. Ore is charged at the flue end by means of a hopper, also shown, and gradually worked forward and roasted as in an ordinary long-bedded roaster. Thus roasted, it is passed by a paddle to the fuse-box, whose hearth is at a lower level. Here it is spread out and melted down.

The Pearce turret furnace. Three types of this furnace have been developed, the one-deck, the two-deck, and the six-deck or hearth. The greater the number of hearths, the more economical is the furnace as regards fuel consumption and output per furnace. On the other hand the structure becomes much more complicated. We will consider for illustration the type of the two-deck furnace (Fig. 30 and 31). It consists of two superimposed circular hearths heated by external fire-boxes. The ore is fed continuously through a slit in the roof of the upper hearth, is stirred and slowly moved forward through the circuit of that hearth, and falls through a transverse slit to the lower hearth where it is stirred and moved forward as before, and finally discharged at a break or open-space of the hearth. The

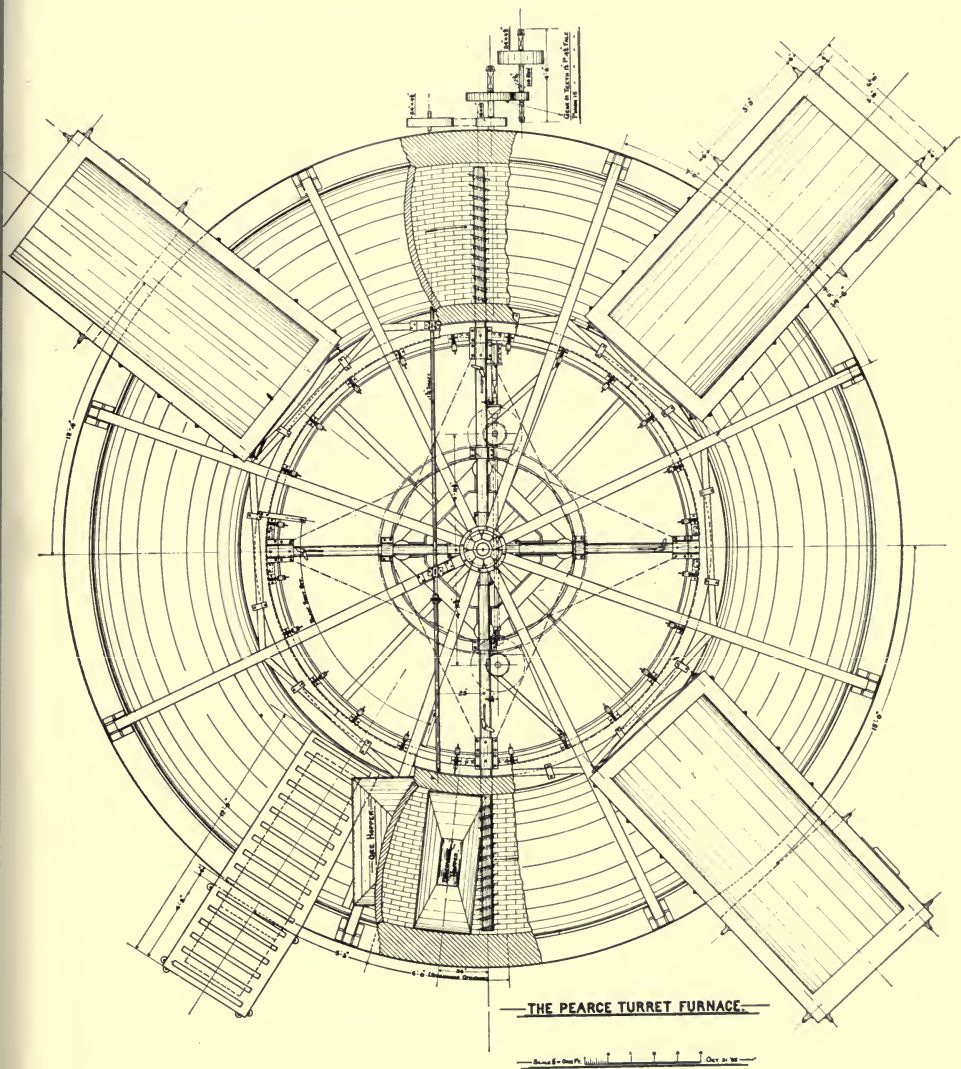
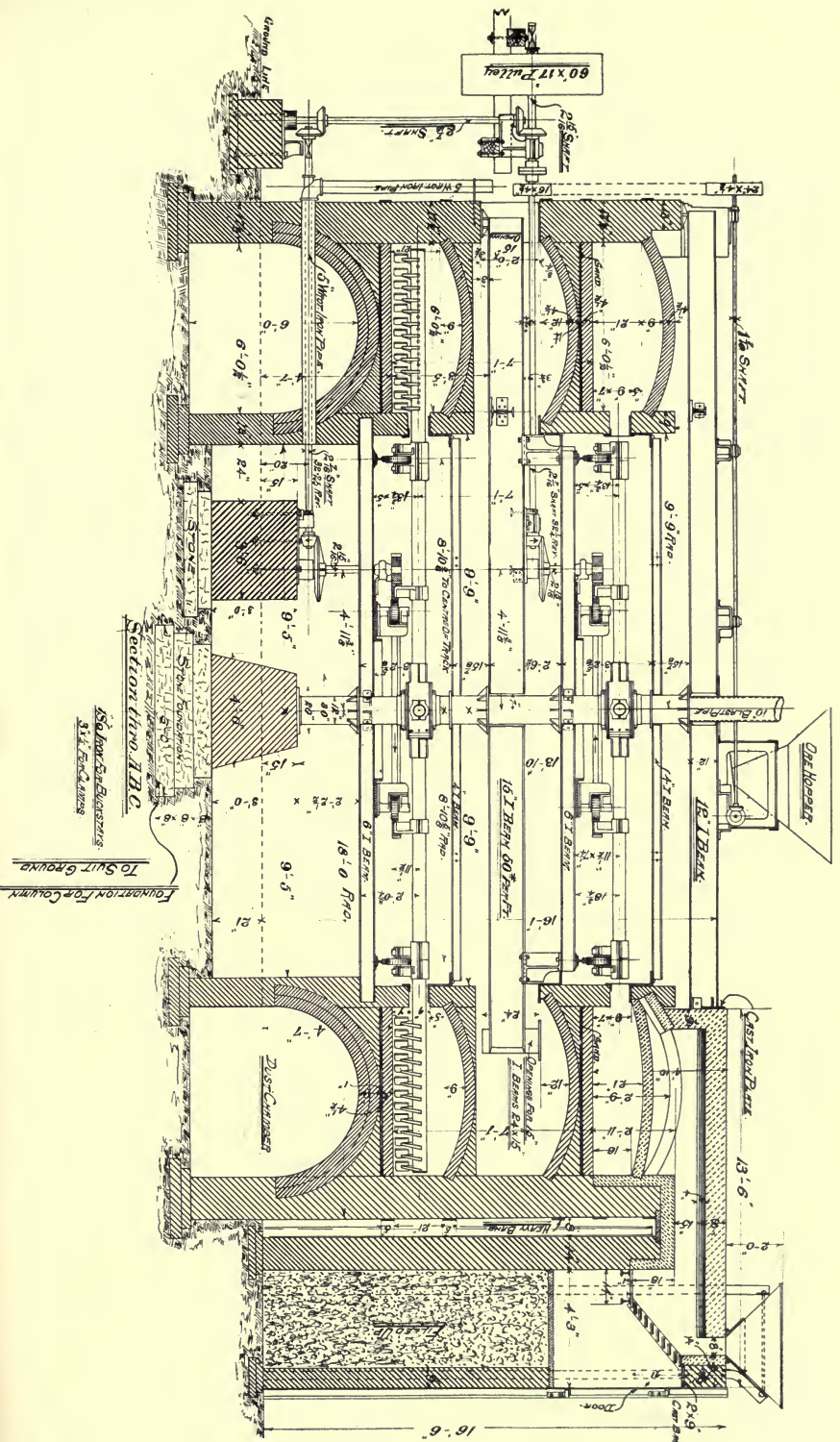

FIG. 30. TWO-DECK PEARCE TURRET ROASTING FURNACE (PLAN).

stirring is done by blades, shown in detail in Fig. 32, which are attached to the radial arms. As will be noticed in the figure, and at *m* in Fig. 30, the rabble blades are set at an angle to their line of travel. Nearly touching the hearth, they pass through the ore, stirring it, and while pushing it aside, move it slightly forward. The blades on the opposite rabble, inclined the opposite way, stir the ridges thus formed. Thus about every minute fresh surfaces are presented to the action of the fire. An objection has been urged against this, as against all the mechanically stirred roasters, that there is a creeping forward of part of the less roasted ore to mix itself with the more roasted portion of the charge. In hand-roasting this need not occur.

Each set of arms is carried by a central hub revolving with a central hollow column. Air under pressure is forced from the central column through the rabble arms, thus cooling them, and, at the same time, furnishing air for oxidation. The inner wall of the furnace has a continuous slot for the movement of the rabble, the slot being covered by a steel tape or band, moving with the rabble arms. The inner wall, thus cut in two, is sustained by I-beams resting both on the external solid wall and upon the central column. Gears attached to each set of arms are actuated by pinion bevel gears and pulley as shown in Fig. 30. The fire-boxes are supplied by air from a fan under a few ounces' pressure ('under-grate blast'), so that the flame enters the furnace under pressure, thus neutralizing the inward suction of the outer cool air due to the draft, and the consequent cooling of the furnace. Suction increases, however, as the outlet flue is approached. Fig. 31 shows one of the fireplaces, having a step-grate, used for burning slack coal. The ash pit is closed by tight iron doors, so that the under-grate blast can be sustained. The fire-box is supplied with coal by means of a hopper kept constantly full. To prevent the too intense action of the heat on the newly dropped charge, a curtain arch (Fig. 31), deflects and distributes the flame. At the open part of the circular hearth each rabble arm successively emerges, pushing aside a swinging sheet-iron door. Continuing its movement it at once enters the heated hearth through another swinging door.

FIG. 31. TWO-DECK PEARCE TURRET ROASTING FURNACE (ELEVATION).



A furnace with a 7-ft. hearth (area 1,218 sq. ft.) will treat 42 tons of ore containing 35% sulphur and roasting it down to 6 to 7% with a consumption of 9.1% fuel. The labor needed for a double-deck furnace is no more than for a single-deck one, while the fuel cost per ton of ore is one-half. The flue-dust is more than in the single-deck furnace. In a multiple-deck Pearce turret furnace the fuel has been cut to 1.4% of the weight of the ore, but such a furnace makes 4% flue-dust. The two-deck furnace requires 3 horsepower to run it and the cost of roasting is 98c. per ton. The cost of the roaster is \$8,000.

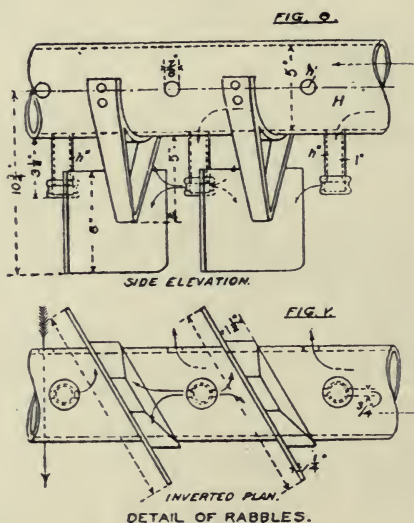

FIG. 32. DETAILS OF ARMS OF PEARCE TURRET ROASTING FURNACE.

The Edwards Roasting Furnace.—Fig. 33, 34, and 35 represent respectively a plan (partly in section), an elevation (partly in section), and a cross-section of the tilting type of an Edwards ore-roasting furnace, 6 by 57 ft. hearth dimensions. It is a single-hearth reverberatory furnace whose slope can be varied by tilting the furnace more or less as desired, but having in this case a slope of 2 in. per foot toward the discharge end, which is near the fire-box. The stirring and moving along of the charge is effected by rabblers fixed to vertical shafts as shown in Fig. 35.

The ore is fed from a storage hopper at *a* by a screw conveyor to the hearths of the furnace, is moved along by the revolving rabblers whose circles intersect, and is discharged through an opening near the side of the hearth at the fire end to a vibrating conveyor and then to the cooling-floor. Slides at the bottom of the conveyor-trough may be opened as desired to regulate the point of discharge upon the cooling-floor. The furnace takes one horse-power to operate it, and has a daily capacity of 25 tons, roasting sulphide of 30 to 35% sulphur to from 3 to 8%. The

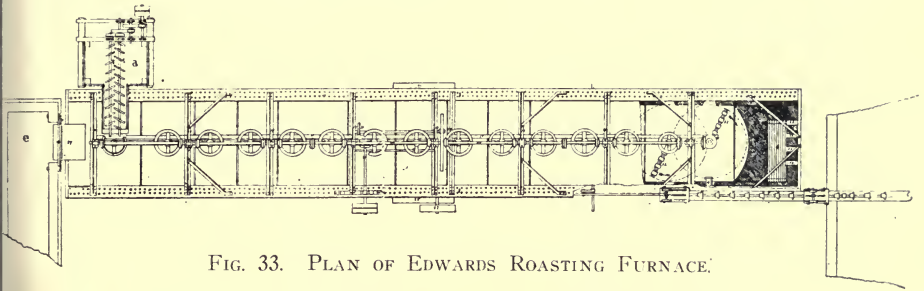

FIG. 33. PLAN OF EDWARDS ROASTING FURNACE.

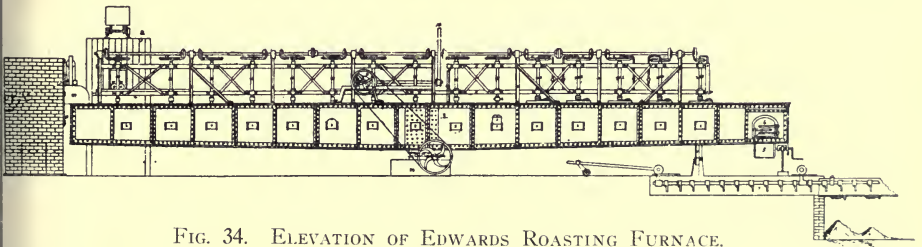

FIG. 34. ELEVATION OF EDWARDS ROASTING FURNACE.

blades or plows of the rabblers can be easily replaced through the doors adjacent to the rabblers. The moving parts are quite desirable, and the furnace has proved efficient in practice. Large furnaces of the duplex type, 120 by 12 ft., have been built, having two rows of shafts and rabblers with a capacity of 60 tons daily; these furnaces have a fixed hearth.

The Wethey Roasting Furnace.—Fig. 36 is a perspective view of the furnace, and Fig. 37 a cross-section of its two straight hearths. The roasting is done on the upper reverberatory hearth, and the lower one is for cooling the ore after it has been roasted.

The upper hearth, 121 by 12 ft., is held firmly between two heavy I-beams suspended from the main frame so as to leave a slit in each wall along which the carriages travel. These carriages or rabblers are, at each side, attached to an endless chain so that they can be dragged through the hearth, stirring and gradually advancing the ore. They return by the lower hearth, upon which the ore from the upper one slides by a chute, and where it is moved along, cooled, and discharged to a screw-conveyor that delivers it to the mill for further treatment. To hasten the cooling, so that it may not, when cool, injure the conveyor and the

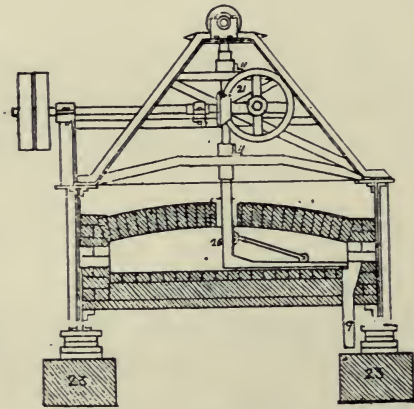

FIG. 35. CROSS-SECTION OF EDWARDS ROASTING FURNACE.

elevator to the mill, water-cooled pipes are laid the length of the hearth in grooves between its brick paving and flush with their top surface. The ore is constantly fed into the furnace at the driving end (the right in the perspective view) and is heated by three fire-boxes alternately set on either side of the furnace. The flame, entering from them by the flue through the roof and descending toward the hearth, moves horizontally to the exit in the stack in the roof near the feed end. Thus the ore and the flame move in opposite directions. The endless chains pass around the sheaves at the ends of the furnace, and around sprocket-sheaves at the driving end that impel them. The stirring plows or blades are set at opposite angles upon the rabblers, so that the end thrusts are balanced. The rabblers are so arranged that they can easily



FIG. 36. PERSPECTIVE VIEW OF WETHEY ROASTING FURNACE.

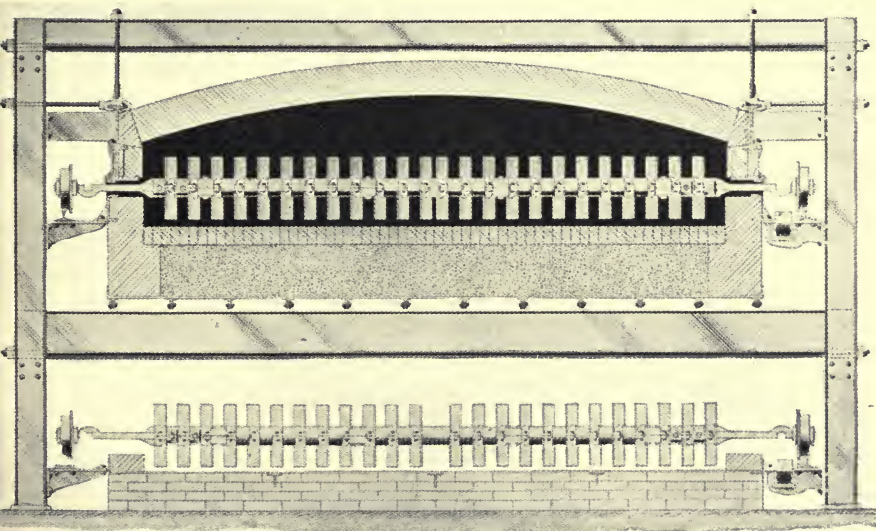

FIG. 37. CROSS-SECTION OF WETHEY ROASTING FURNACE.

be removed without disturbing the carriage connections. There are four carriages and they pass through the hearth at the rate of 100 ft. per min. There are sheet-iron flap-doors hinged on the top edge at each end of the roasting-hearth (as in the Pearce turret-furnace). These are ordinarily closed, but are lifted by the stirrer carriage in passing into and out of the upper hearth. It might be thought that the slits at the sides of the furnace would admit too much air, and also injure the draft, but the furnace is found to work well notwithstanding.

The Evans-Klepetko furnace. This belongs to the type of McDougall furnaces, and is shown in Fig. 39. It is a vertical cylindrical furnace with arched horizontal hearths, having drop or discharge openings for the ore alternately at the centre and at the periphery of the hearths. To stir the ore and to move it alternately to these drop openings, there is a central revolving shaft, having horizontal radial stirring-arms provided with stirring-blades set at an angle to their direction of motion.

The blades of the arms on the even-numbered hearths are inclined opposite to those on the odd-numbered, so that on the odd-numbered they push the ore to the central drop-opening, and the even-numbered toward the periphery. The ore, fed continuously to the furnace, drops upon the first hearth near its outer edge; the blades of the rabble-arms of that hearth stir and move it gradually toward the central drop-opening, where it passes to the second hearth. The rabbles of this hearth again stir and move it to the exterior drop-openings where it falls to the third hearth and so on. At the lower hearth, openings are left by which it is finally dropped into a hopper. The ore spread evenly on the hearth thus travels zig-zag through the furnace, gradually passing from periphery to centre and *vice versa*. The ore, contained in a hopper, is mechanically fed in a continuous stream to the periphery of the upper hearth. Here, as it is moved toward the central discharge opening, it dries out, roasting beginning on the second hearth. On the third hearth the ore roasts freely with the emission of numerous sparks, and some sulphates are formed; on the fourth there are no sparks, and the ore has attained its highest temperature. On the fifth, the ore looks less bright, especially at the discharge, where it has begun to cool off.

The air for oxidation is admitted by doors in the side of the furnace, mostly at the bottom ones. The gases, and with them, the dust, passing up through the drop-openings, are drawn off through the flues at the top. In starting, the furnace has to be heated up to the kindling-temperature of the ore, which, if rich

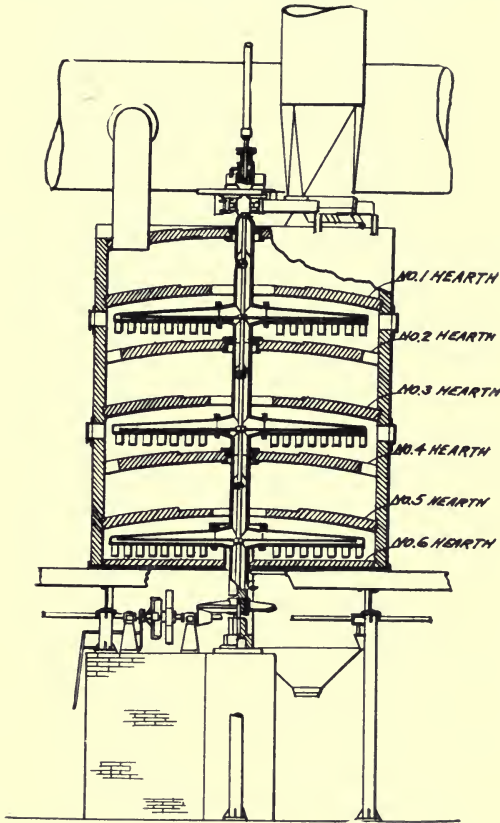

FIG. 39. EVANS-KLEPETKO FURNACE (ELEVATION).

enough in sulphur, will burn of its own accord without the addition of any fuel. If low in sulphur, additional heat must be supplied by one or more external fireplaces located near the bottom of the furnace. To protect the rabble-arms from the intense action of the fire, they are water-cooled. The cooling

water is forced down to near the bottom of the 9-in. hollow central shaft in a 3-in. pipe and out to the ends of the horizontal rabblers or stirring arms in 1-in. pipes. It then returns up the annular space between the 3-in. pipe and the hollow shaft, and discharges at the top through two spouts into a launder. The furnace is 18 ft. 3 in. high and 15 ft. 10 in. diam., having six hearths. The shell is of $\frac{3}{8}$ -in. boiler iron, and is lined with 9 inches of brick. Each hearth has two stirring-arms making one revolution per minute.

A furnace treats in 24 hours 40 tons of sulphide ore of 35% sulphur, reducing it to 7%. About 4% of flue-dust is made, and the roasted ore itself contains more ferric oxide and is lighter and more porous than would be the case with the product of the hand reverberatory-roaster. The cost of roasting for the above-named ore may be given at 35c. per ton, the lowest thus far known for any furnace. The compact form of the furnace, reducing radiation to a minimum, enables it to roast with the consumption of little or no fuel. Taking its capacity into consideration, it is of moderate price and is easy to repair.

The White-Howell Roasting Furnace. Fig. 40 is an elevation of this furnace, which has a continuous feed and consists of a cylinder 5 ft. external diameter by 32 ft. long, slightly inclined, supported on friction rollers and revolved between a stationary fire-box at one end, and a dust-chamber and flue connected to the stack at the other. That portion of the cylinder near the fire is of larger diameter to permit of it being lined with fire-brick where needed, leaving the interior of the same diameter throughout. For projecting fire-brick ridges serve to raise the ore as the cylinder revolves and to shower it back through the flame so as to more rapidly roast it. The unlined part for the same reason is provided with longitudinal cast-iron shelves. The furnace is fed at the flue end by means of a screw-feed, and as the cylinder revolves, the ore works along to its lower end, passing out between the cylinder and the fire-box to a vault or brick chamber whence it can be withdrawn when cool. The furnace has been chiefly used for chloridizing roasting.

The Brückner roasting furnace. This furnace consists of a horizontal cylinder of plate-steel lined with brick, and revolving

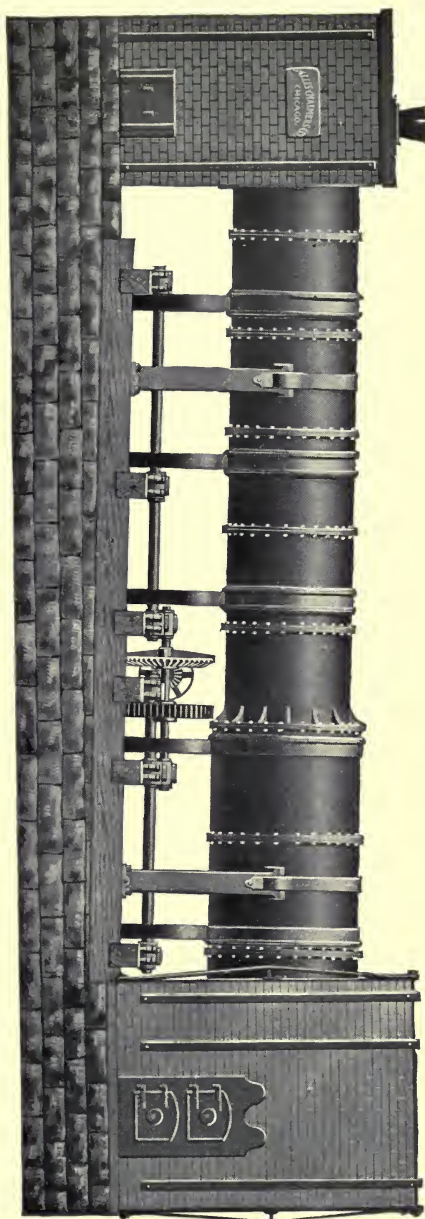

FIG. 40. WHITE-HOWELL ROASTING FURNACE.

between a fire-box and a flue. The flame from the fire-box is drawn directly through the cylinder to the flue. The cylinder is provided with man-holes for charging and discharging the ore, and is served by a double hopper, large enough to hold a full charge.

Fig. 41 is a perspective view of the furnace, 8 ft. 6 in. diam. by 28 ft. long.

The cylinder is truncated at the ends for the easier discharge of the ore, and constricted at the inlet and outlet openings intended for the passage of the flame and gases. The present practice is to revolve the cylinder slowly, say once an hour, since its contents, even at this speed, are constantly shifting; the older way was to revolve it once in four minutes. Motion is communicated through spur-gearing to a circular spur-gear rack on the cylinder, and the slow motion is attained preferably through worm and worm-gear. At the time of discharging, however, the cylinder must be revolved quickly in order to remove the ore promptly. Charges which contain lead are liable, with a slight accession of heat over the normal, to agglomerate slightly and 'hang up'; that is, the ore attaches itself in a layer to the brick lining. Should this occur, the movable fire-box may be pushed aside and the layer removed with long slicer-bars. The attachment is so slight that when the layer is cut through even in one line from end to end of the cylinder, thus destroying its key, the rest falls off as the cylinder again revolves, and the whole, again breaking up, is ready for further roasting. A slight cohesion of the finer particles need not interfere with obtaining a good roast.

The charge having been dropped into the furnace and the man-hole openings closed, it is vigorously fired upon in order to get the ore burning by its own oxidation.

This takes about six hours, the ore slowly becoming of a visible red heat, first at the fire-box end and finally at the flue end. The charge thus started burns by its own heat for 12 hours more, the fire having meanwhile been withdrawn from the fire-box. Indeed, the action is so vigorous that the charge must be watched and the admission of air limited, for fear, in case of leady ores, of agglomeration. As the heat, at the expiration of this stage, slacks off, firing with coal is resumed, gradually in-

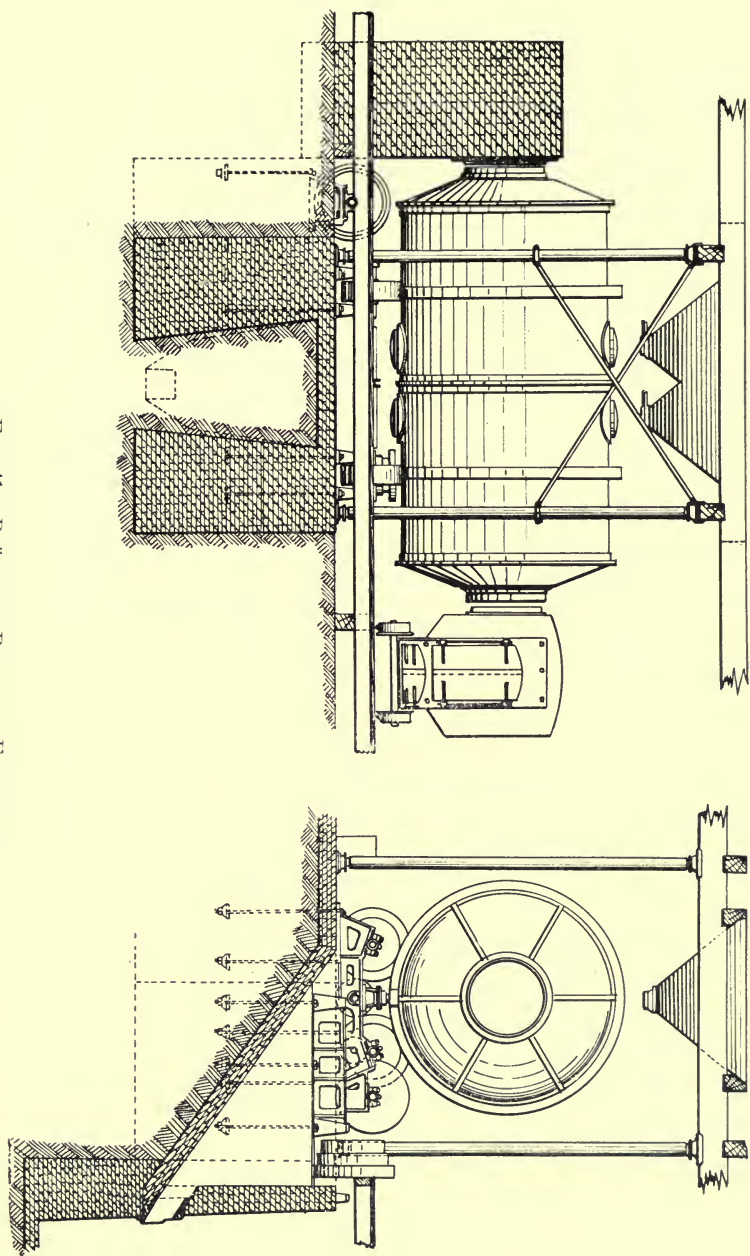

FIG. 41. BRÜCKNER ROASTING FURNACE.

creasing the heat to the finish. In this way sulphates are decomposed, and the oxidation of the charge completed. The whole operation, in the case of lead-bearing ores, takes 48 hours—sometimes longer. In the case of copper-bearing ores which do not agglomerate, and which need not be roasted so closely, 24 to 36 hours is sufficient. In the former case, the sulphur remaining may be from 3 to 5%, in the latter 7 to 8%. The ore is discharged by opening all the man-holes and revolving the cylinder quickly. At each half-revolution, part of the charge runs out, until, in 5 to 10 minutes, most of it is removed. The little left behind mixes with the next charge. The hot escaping ore is received into large charge-cars, transferred and dumped into bins to cool. All the man-holes save two are closed, these latter being brought under the hopper-spouts. The hopper-slides are pulled and the ore speedily runs into the cylinder. On closing the man-holes, the charge is ready for firing upon. These operations of discharging and charging need take no more than 20 minutes. A large cylinder 8 ft. 6 in. by 28 ft. will take a charge of 30 tons, which makes a capacity of 15 tons daily for leady sulphides, and of 20 to 30 tons for copper-bearing sulphides. The cost of roasting, for leady ores, is 85c. per ton; for copper sulphides roasted to 6 or 7%, but 42c. per ton. The cost of a Brückner cylinder may be given at \$3,000.

The Stetefeldt Roasting Furnace.

This furnace (Fig. 42) consists of a vertical brick shaft, *B*, some 25 ft. high, having fire-boxes, *G G*, near the bottom and a flue opening near the top. By means of a screen feeder, *A*, pulverized ore is continuously sifted into the shaft and, during the few seconds it is falling through the heated air, becomes roasted. The flue-dust passing off through *H* is mostly caught in the hoppers, *FF*, and the remainder in the main flue forming a continuation of the flue, *D*, and terminating in a chimney or stack. An auxiliary fire-box, *E*, completes the roasting of the flue-dust, which may amount to 30% of the ore fed in. The furnace has a capacity of 40 tons in 24 hours.

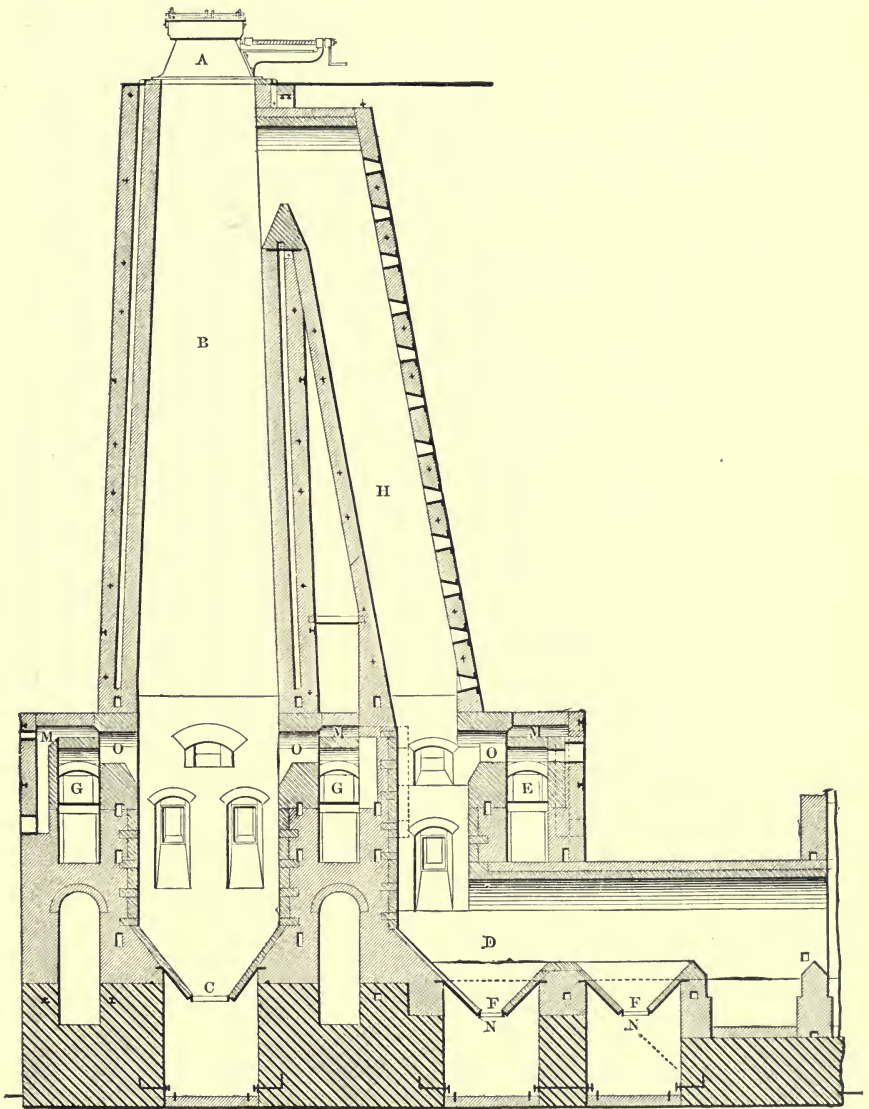

FIG. 42. STETEFELDT ROASTING FURNACE.

13. POT-ROASTING OF ORES.

We have already noted the difficulty of roasting galena ores, but, by one of the pot-roasting methods, galena may be freed from most of its sulphur. In these processes the moistened sulphide ore, carrying galena mixed with a certain proportion of limestone and silicious ore, is charged into a large hemispherical cast-iron pot, usually of a capacity of from 8 to 10 tons. Air, under low pressure (one to four ounces) is introduced under the false bottom of the pot and is blown through the charge; a little wood fire, if necessary, or hot ore, being at first put under it. An exothermic reaction takes place, the charge becoming red hot and SO_2 and SO_3 coming off. At the end of the reaction, sometimes extending to 16 hours, desulphurization is almost completely effected. The pot is then inverted and the solid, red-hot mass dumped out. This is then broken up to a size suitable for the blast-furnace. Owing to its lump form, it permits the air of the blast-furnace to come through more readily, thus increasing tonnage, while, owing to the low percentage of sulphur, the production of matte is greatly decreased. Besides this, since the temperature of desulphurization is not high, the loss of silver and of lead is reduced as compared with that in an agglomerating-roasting.

There are three patented variations of the process. In the first, the Huntington-Heberlein, the ore mixed with limestone is partially roasted down to 12 to 14% S, and charged to the pot while hot, so that no extraneous fuel is needed to start the reaction. In the second, the Savelsberg, the ore, mixed with the proper proportion of limestone and of silicious ore, is charged directly to the converter, there being no preliminary roasting. In the third, the Carmichael-Bradford process, the ore is mixed with a proportion of gypsum, and then charged directly to the pot.

14. COST OF ROASTING.

Ore-roasting *in heaps* at Jerome, Arizona, costs 80c. per ton, including general expenses.

Ore-roasting *in stalls* costs 54c. per ton. A battery of roasting stalls, each 8 by 8 ft. in size would cost \$3,300, to which should be

added \$800 for the cost of the stack (common to all the stalls), making a total of \$4,100. Such a plant has a life of about six years.

In *reverberatory roasting* in long-bedded hand-rabbed furnaces the lowest price when roasting copper ores is \$1.25 per ton. For roasting lead-bearing ores \$1.75 per ton is a moderate figure. The cost of erecting such a roaster may be given at \$3,130, including that of one-half of the stack needed for two roasters in common.

The Allen-O'Hara automatic furnace, having two hearths each 94 by 9 ft. will roast 45 to 50 tons daily to 8% S at a cost of 78c. per ton.

The Wethey furnace, having four hearths each 65 by 10 ft., will roast 90 tons daily to 5 or 6% S at a cost of 60c. per ton.

The Pearce double-deck furnace (7-ft. hearth) will roast 42 tons daily to 6% S at a cost of 98c. per ton.

The Herreshoff furnace, having five hearths each 10 ft. 10 in. diam., will roast 40 tons daily to 7% S at a cost of 50c. per ton.

The McDougall-Evans-Klepetko furnace, with six hearths each 15 ft. 10 in. diam., will roast 40 tons daily to 7% S at a cost of 35c. per ton.

The Brückner cylinder roaster, 8½ ft. diam. by 22 ft. long, will roast 10 tons daily to 4% S at a cost of 80c. per ton.

It is to be noticed that the low cost of roasting on some of these furnaces is due to their using no fuel after they are fully in operation. Such furnaces have several hearths, are compact, and, on account of that compactness, lose but little heat by radiation.

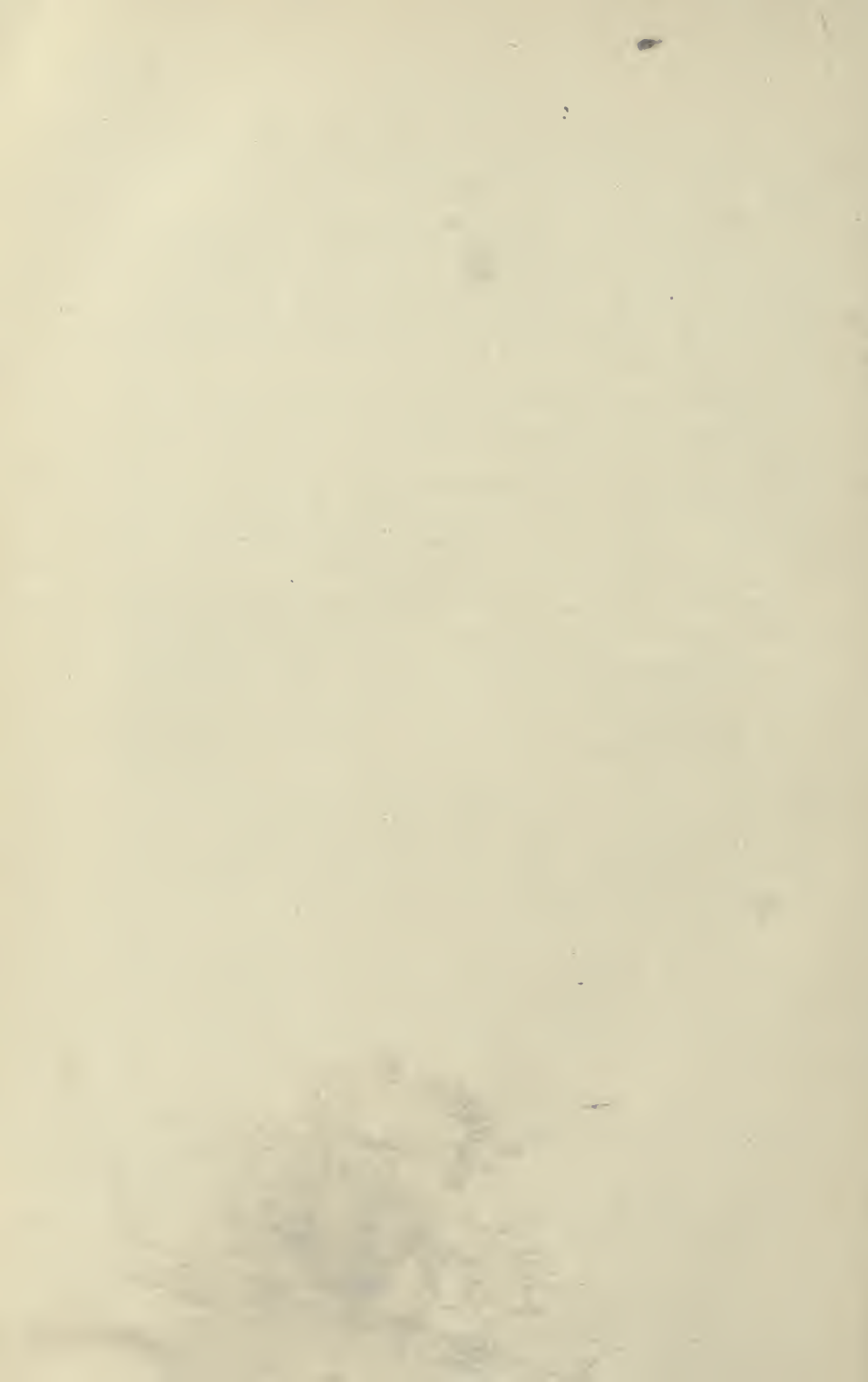

PART III. GOLD

PART III. GOLD.

15. GOLD ORES.

Gold occurs in nature, both native and combined with tellurium.

Native gold occurs in rock disseminated through it in grains or particles of varying size. It is found not only in quartz, but in hematite, iron pyrite, arsenical pyrite, blende, and galena. In pyrite it may occur as films on the faces of the crystals. Such rock in place is called gold rock or reef rock.

When these rocks have been broken up by alluvial action the particles of gold are swept along by the water mixed with sand and gravel, and are deposited in beds, the pebbles and boulders being, in general, barren of gold. Gold occurring in this way is called alluvial gold, and is recovered by methods of hydraulic mining or dredging, which belong rather to mining engineering than to metallurgy. We will consider, therefore, the treatment of gold rock or ore in place.

Gold Tellurides.—In South Dakota, at Cripple Creek, Colo., and in West Australia is to be found gold combined with tellurium in the form of sylvanite and petzite (Au, Ag) Te_2 and as calaverite (Au Te_2) the latter having 41.4% Au to 57.3% Te.

16. GOLD-MILLING AND AMALGAMATION.

Free-milling gold ores, in which the ore is oxidized, can be well and cheaply treated by milling the ore and amalgamating the crushed pulp, while the tailing or residue, left after such extraction, is run to waste. If, however, the ore contains some pyrite, not all the gold content can be recovered so simply. The pyrite, though being heavy, is caught on concentrating tables and the concentrate is then sent away to be smelted or to be further treated by leaching methods. At Treadwell Island, Alaska, about half the

gold is obtained by amalgamation, and the concentrate, one-fortieth of the total weight of the ore, contains the remainder of the gold.

Stamp-mill Amalgamation.—This consists in crushing the gold-bearing rock in a stamp-mill and in some instances, feeding mercury in small quantities (about 1.5 oz. per ounce of contained gold) into the mortar while the crushing proceeds. By regulating the water supply and the height of discharge from the mortar, the mercury is kept distributed throughout the ore pulp, as the mixture of water and finely ground ore is called. By the fall of the stamps the gold is brought into intimate contact with the mercury, and forms, with the gold, an amalgam which settles at the bottom of the mortar between the dies, and also becomes attached to amalgamated copper plates (inside plates) lining the sides of the mortar. As all the gold, however, is not amalgamated within the mortar, the issuing pulp flowing over a flat amalgamated table or apron plate (4 ft. wide by 5 to 6.5 ft. long), and is further acted upon, the gold attaching itself to the plate, together with any mercury or amalgam that may escape from the mortar.

The Battery.—Fig. 43 is a perspective view of a 10-stamp battery used in gold milling.

In Fig. 43, the parts are as follows: *A*, mortar block; *B*, mud sills; *C*, cross-sills; *D*, posts; *E*, platform; *F*, *G*, buckstaves; *H*, lower guide timbers; *I*, upper guide timbers; *J*, mortar; *K*, screen; *L*, die; *M*, shoe; *N*, boss or head; *O*, stem; *P*, tappet; *R*, cam shaft; *S*, collars; *T*, cam shaft boxes; *U*, cams; *V*, cam shaft pulley; *W*, line shaft; *X*, tightening pulley; *Y*, water pipes; *Z*, automatic feeder.

On the cross-sills is shown the frame and amalgamated apron-plate, which in the cut is omitted from the five nearer stamps.

The mortar block. *A* is often made of timbers set on end as shown in Fig. 44 and 45. These timbers are set in a pit going down to the solid rock or on a concrete foundation, as upon their solidity depends the durability of the mill. They are bolted together horizontally, and are held vertically by a tamping of sand, rock, or concrete, which fills the pit. This block or foundation is also made of concrete which is cheaper and more

durable. On the mortar-block is firmly bolted with long holding-down bolts, the mortar *J*, with three thicknesses of blanket, or a piece of heavy belting or rubber sheeting, interposed to give an even bearing.

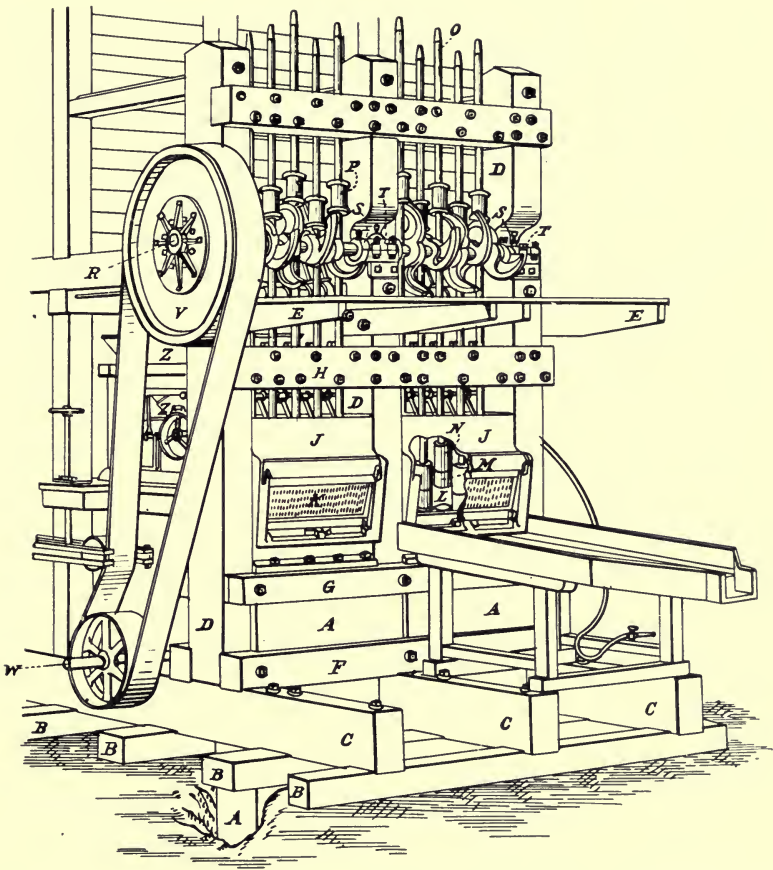

FIG. 43. PERSPECTIVE VIEW OF 10-STAMP BATTERY.

The stamp-frames, consisting of the mud sills *B*, the cross-sills, *C*, posts *D*, braces, buckstaves *G*, *H*, and guide-timbers *H* and *I*, are of dimensions given in Fig. 44 and 45. The mud-sills run the length of the mill and carry also the line-shaft. To the guide-

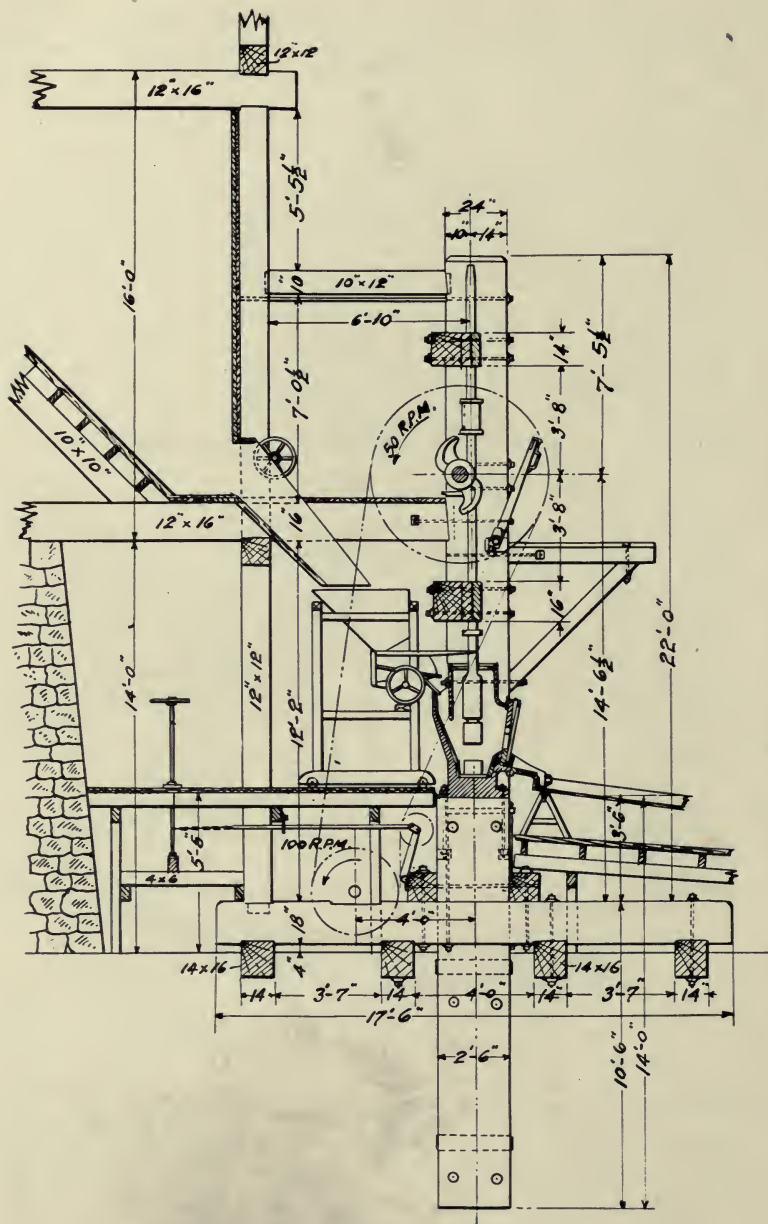

FIG. 44. SIDE ELEVATION OF 10-STAMP BATTERY.

timbers are bolted the guides, commonly made of two planks, each 4 by 14 in., bored with holes 3 in. diam. for the wrought iron or steel stems.

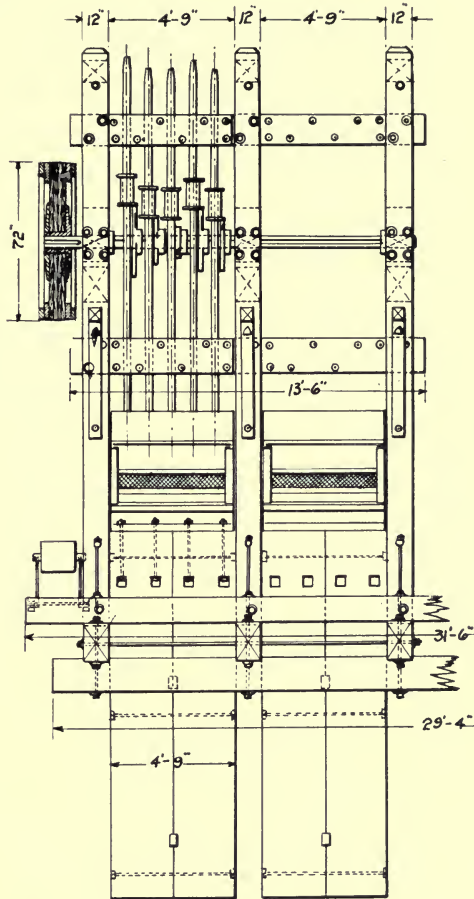

FIG. 45.. FRONT ELEVATION OF 10-STAMP BATTERY.

There are two kinds or methods of framing, called A-frames and knee-frames. Both Fig. 43 and 44 are of the knee-frame type. The A-frame is braced by an inclined brace to the cross-sills and tied by long tie-rods to the same. The A-frame is suited to lighter stamps; the knee-frame to heavier stamps, as

being heavier and more solid. Stamp-frames are also made of steel.

The mortars are boxes of cast iron containing, at one side, feed openings where the ore enters, screen openings on one or both sides for screens through which the stamped ore or pulp

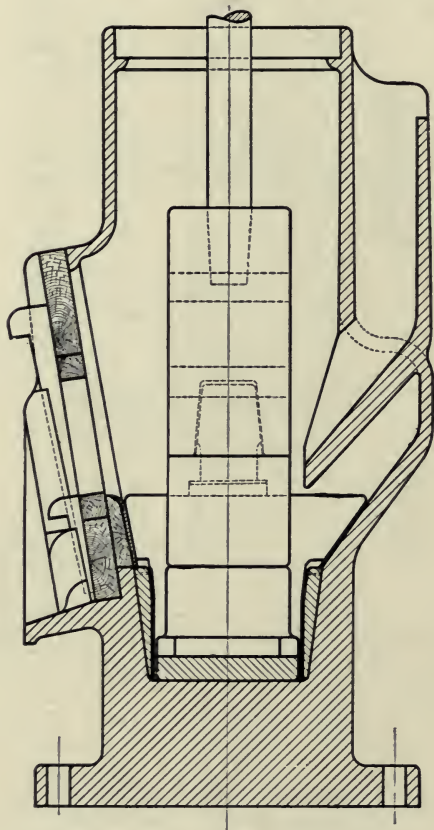

FIG. 46. SINGLE-DISCHARGE MORTAR.

discharges, a base to receive the dies and sides to which are often fastened inside amalgamated plates. Two designs of mortars are shown that weigh 2 to 3 tons each, Fig. 46 illustrating the single-discharge type for gold-milling, and Fig. 47 a double-discharge mortar for silver-milling. Upon both mortars will be

noticed a deflecting lip terminating the feed opening, and so arranged as to discharge the ore well to the centre of the mortar, and (in the case of Fig. 46) protecting the inside plate, if any, from the direct wear of the ore. Screen-openings are provided, both at the front and back of the mortar. The screen is mounted

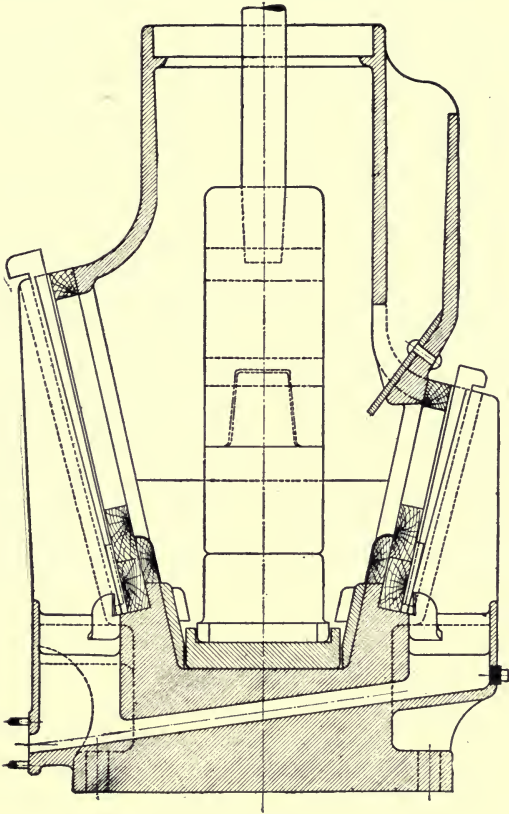

FIG. 47. DOUBLE-DISCHARGE MORTAR.

in a wooden frame and is made of wire-cloth or of punched-plate, the holes in the latter case being either slotted or round.

Of the two, the punched steel plate has the advantage for strength and cheapness of first cost. On the other hand, brass wire-cloth gives increased effective discharge area; thus in the

case of the No. 7 punched plate, above given, we have an effective discharge-opening of but 10% of the total area; while in the case of the wire screen, it is 27% and, in consequence, less sliming of the ore occurs because of its prompter escape from the battery.

The chuck block.—To increase the height of discharge, which is the vertical distance from the top of the die to the bottom of the screen opening, a block is put into the discharge-opening below the screen, as shown in Fig. 46 and 47. As shown in Fig. 46, an inside plate is attached to this as well as to other parts of the interior of the mortar for the purpose of collecting as much of the gold as possible within the mortar.

Fig. 46 and 47 show the foot-plates which cover the bottom of the mortar, and upon which rest the five cylindrical dies 8 to 9 in. diam. by $3\frac{1}{2}$ to 7 in. high when new. The connection of the stamp-shoe, head or boss, and stamp-stem are also clearly shown. In inserting a shoe, wood shims are placed around its shank, and the boss with stem affixed, dropped upon it, thus holding it in place by friction.

Dies and shoes are made of chilled cast iron and of manganese or chrome steel, chilled cast iron being quite common. The wear of shoes and dies is from 0.25 to 1.25 lb. per ton of ore crushed, according to the toughness of the ore. In the case of chilled cast-iron 0.75 lb. at 6c. per lb., or 4.5c. per ton, may be given as an average figure.

The reversible tappets, *P*, Fig. 44, of cast-iron, are keyed to the stems and acted on by the cams *U* which lift them from 8 to 16 in., according to the drop required, at the same time giving the stem a partial rotation on its axis to obtain an even wear of the shoe and die. The replacing of a cam of the ordinary type is a tedious operation, and to overcome this, a self-tightening cam such as the Canda has been devised, as shown in Fig. 49. It consists of a curved tapering key, *a*, which is fitted to a tapering recess in the cam *b*. Upon the shaft *c* is set a pin, which engages in a recess in the key, so that, when cam and key are slipped on the shaft over the pin, and then turned, the key wedges itself, securely, uniting the cam to the shaft. It will be noticed that the cams are set upon the shaft at various angles so that the stamps drop at regular intervals and in a predetermined order. The

stamps, being numbered consecutively, counting from left to right in a five-stamp battery, a favorite order of drop is No. 1, 4, 2, 5 and 3. When it is desired to stop any one of the stamps it may be 'hung up' by putting under the tappet the finger L, Fig. 44.

17. OPERATION OF A STAMP BATTERY.

From the storage bin (see Fig. 44) the ore passes by a chute to the automatic feeder. At each down-stroke of one of the stamps a collar on it strikes the end of a horizontal lever there shown, slightly revolving the feed-plate of the feeder, so that some ore drops into the feed-opening of the mortar. As ore gets under the

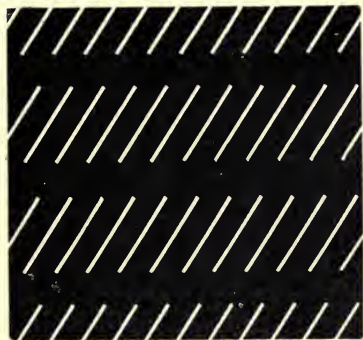

FIG. 48. PUNCHED SCREEN.

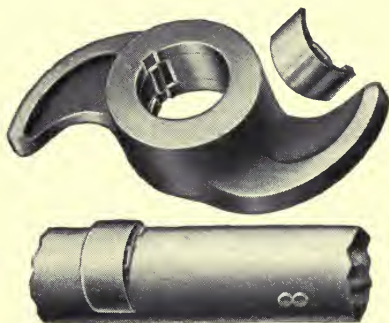

FIG. 49. CANDA CAM.

shoe, the stroke of the stamp shortens, the horizontal lever is less moved, and the feed is correspondingly lessened, thus acting automatically according to the needs of the battery. In wet-stamping, water is also fed in, which, mixing with pulverized ore, forms a pulp which is splashed out through the mortar-screen.

California and Colorado practice in gold-milling. For free-milling gold ores, where the gold is coarsely knit in the ore, and where, consequently, fine grinding is not needed, we prefer the California practice, by which large capacity is attained. On the other hand, in Gilpin County, Colo., the ore contains 10% of a gold-bearing pyrite, in which the gold is finely disseminated. In order to grind this fine, it must be longer retained within the

mortar. While thus retained, the fine float-gold set free, has time to come in contact with the inside amalgamated plates by which some 75% is caught. In California practice, the stamps weighing 900 to 1,100 lb. each, drop 80 to 110 times per minute, with a fall of from 5 to 9 in.; in Colorado practice the stamps, weighing 600 to 800 lb. each, run at 26 to 30 drops per minute, with a 16 to 20-in. drop. As a general principle, the greater number of drops per minute, the greater the tonnage put through, but this is also increased by a high drop. To grind the ore more finely, and to retain it within the battery for amalgamation, a high discharge is needed. This is attained by putting in a higher chuck-block. This height in Colorado practice amounts to from 13 to 18 in. from the top of the die to the lower edge of the screen opening. In California practice the height of discharge is but 5 in. The objection to high discharge is that the ore is largely slimed, so that it is difficult to concentrate, and the tailing loss in gold-bearing pyrite is high. In California practice 4 tons may be crushed daily; in Colorado practice but 1 to 1.5 tons. We thus have as an average performance of a single stamp head:

	California	Colorado
Drops per minute.....	95	28
Height of drop.....	7 in.	18 in.
Height of discharge.....	5 in.	15 in.
Capacity in 24 hours.....	4 tons	1.25 tons
Weight of stamp.....	1,000 lb.	700 lb.
Actual h.p. needed per stamp	2.02	1.07

The theoretical horsepower of a single stamp is calculated by multiplying its weight into the distance it is lifted per minute divided by 33,000. The actual horsepower is 1.2 times the theoretical.

Mercury fed to the battery.—This varies from 1 ounce to 6 ounces per ounce of gold caught, the average being about 1.5 oz. This is added a little at a time inside the mortar and works out, in part, upon the apron-plates. As to the amount to use, a safe guide is the appearance of the plates. If the plates are hard it indicates insufficient mercury; if the mercury is distinctly visible on the plates, either in patches or streaks, then it is being added

too freely. The mercury should be free from base metals which cause it to 'sicken,' that is, it breaks up into minute globules when coated with these metals. Such globules refuse to coalesce and are swept away in the tailing. Mercury acts best when it already contains some gold and silver.

The outside or apron-plates are dressed three or four times daily, taking about 15 minutes each time. To do this, feeding is stopped to permit ore to work out of the battery, the stamps are then hung up, and the surface of the plate hosed off clean. A rubber-edged scraper resembling a window cleaner, but heavier, is used to scrape the plate. With this the amalgam is gathered together and removed to a suitable vessel. An enamelled kettle is commonly used for this purpose. If the surface is too hard for the scraper, the amalgam is softened by sprinkling on a little mercury. The plates are liable to become tarnished with the salts of copper forming a verdigris upon the plate itself; and since the tarnished part catches no gold, such stains must be removed. To do this the battery is stopped, the plate rinsed with clean water, and a solution of sal-ammoniac applied to the stained parts with a scrubbing brush. In a few minutes this is washed off, potassium cyanide and some mercury rubbed on, and the plate immediately washed clean.

Apron-plates have a grade or inclination of 0.5 to 1.75 in. per foot, heavier ore and sulphides requiring the steepest grade. When the pulp is flowing over the plate in a proper manner it travels down in a series of ripples, its upper surface tumbling over and over upon the plate, thus bringing the particles of gold in contact with it.

To save escaping particles of amalgam or of mercury which fail to attach themselves to the plate, a mercury trap, Fig. 50, is provided, especially where no table-concentration of the tailing is attempted. It is in shape an inverted frustum of a pyramid,

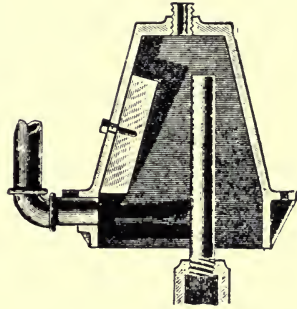

FIG. 50. MERCURY TRAP.

the pulp flowing in by the vertical pipe and escaping over a wooden block attached to the side of the trap.

The clean-up.—Every two to four weeks it is customary to remove thoroughly all accumulations of amalgam from the battery. To do so the stamps are hung up, two batteries at a time. The screen, inside plates, and dies are taken out and the contents of the mortar, two or three buckets full, are carefully scraped out and fed to one of the other batteries. Finally, the cleanings of the last batteries hung up, are put in a clean-up pan (Fig. 51), together with the amalgam from the well-scraped plates. Three men can clean 40 stamps in five to seven hours.

The iron clean-up pan, Fig. 51, 3 ft. diam. by 2 ft. deep, making 12 to 15 rev. per minute, is used for grinding the amalgam, sand, pyrite, fragments of iron, and other substances, the result of the clean-up. The charge, say of 300 lb. mixed with water, is ground for three or four hours, after which 50 lb. of mercury is added and the mixing is carried on for a few hours longer; the pulp is then diluted with water, settled and discharged. The residual mercury and amalgam is withdrawn through a plug-hole and strained through chamois-skin, or through a canvas bag, to remove the excess of mercury. Gold amalgam when well squeezed through the cloth will contain as much as 35 to 45% gold. The filtered mercury still retains upwards of 0.5%.

Retorting.—In the smaller gold mills the amalgam is retorted in a pot-shaped retort (Fig. 52), and in larger ones, in a horizontal cylindrical retort (see Fig. 53). The retort, filled two-thirds full of amalgam, is placed in an assay furnace fire with the tube dipping into water, and the charge is heated slowly until the mercury begins to come over and collect in the vessel containing the water. At this point the fire is checked, and the retort kept an even heat for one or two hours, after which it is brought to a red heat to expel the last of the mercury.

The mercury, collected by condensation in the water, is used over again. This accounts for its small loss, amounting, in California practice, on an average to 0.5 oz. per ton of ore treated. Mercury is lost both by 'flouring' and by 'sickening'; the first, a white appearance, is due to excessive agitation and to the air

acting on the pulp, while the sickened mercury is black-looking owing to the presence of base metals, as already explained.

The retorted residue, still retaining 0.5 to 1% Hg., is porous and from 500 to 950 fine in gold. It is melted in a plumbago

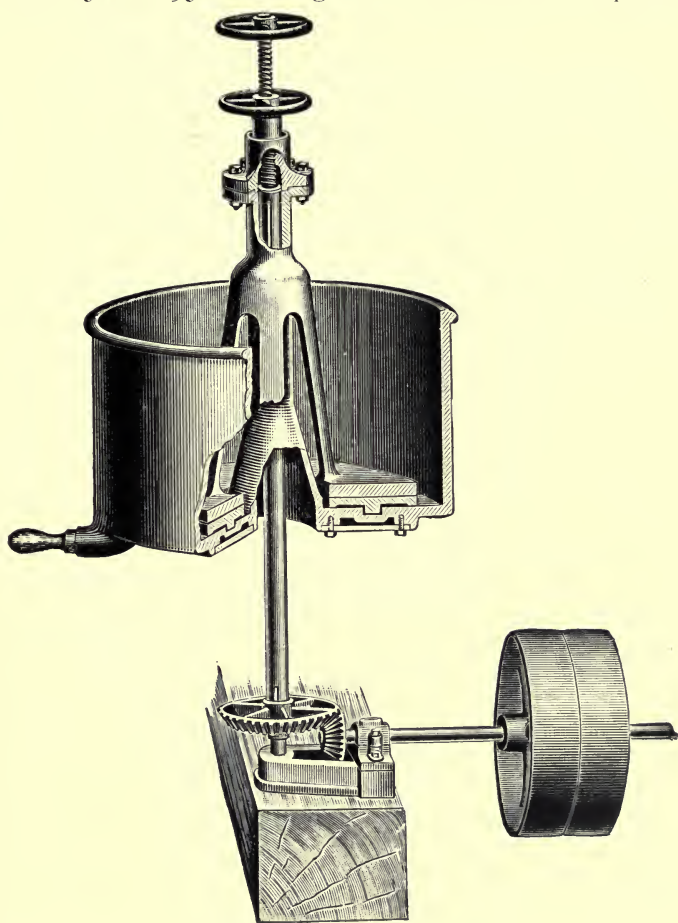

FIG. 51. CLEAN-UP PAN.

crucible with the addition of some soda and borax, and when containing base metal, with a little nitre. The melt is poured into an ingot mold, and when cold the ingot, cleaned from adherent slag, is shipped to the mint.

When the ore contains sulphides which it would pay to treat by concentrating, amalgamation is followed by concentration of the tailing on tables like the Frue vanner or Wilfley table. Thus, not only is a valuable product gotten into a small bulk, but particles of amalgam are caught and also go into the concentrate.

When ores contain gold, both coarse and fine, the method followed has been to amalgamate the ore to obtain the coarse gold and to treat the tailing by the cyanide process to extract the values not obtained by amalgamation. For further particulars of thus treating gold ores see the description, Section 28. In South Africa, where this method of working obtains, the cost of milling may be placed at \$0.72 to \$1.20 per ton for milling and amalgamation, and at \$0.96 to \$1.44 per ton for cyaniding the tailing, all based upon an output of 4.5 to 5.0 tons per stamp.

Cost of gold milling.

At a 30-stamp mill in California in 1896 there were crushed and concentrated 33,512 tons of ore at an expense detailed as follows:—

Shoes and dies.....	\$0.029
Screens	0.003
Mercury	0.007
Hardware, belting, and firewood.....	0.021
Water for power.....	0.095
Freight, cyanide, oil, and grease.....	0.006
Lumber	0.008
Miscellaneous	0.007
Assay and office supplies.....	0.008
Silver-plated plates.....	0.007
Water pipes and connections.....	0.021
Hauling sulphides.....	0.020
Express on bullion.....	0.006
Taxes and insurance.....	0.010
Superintendence and labor.....	0.160

\$0.408

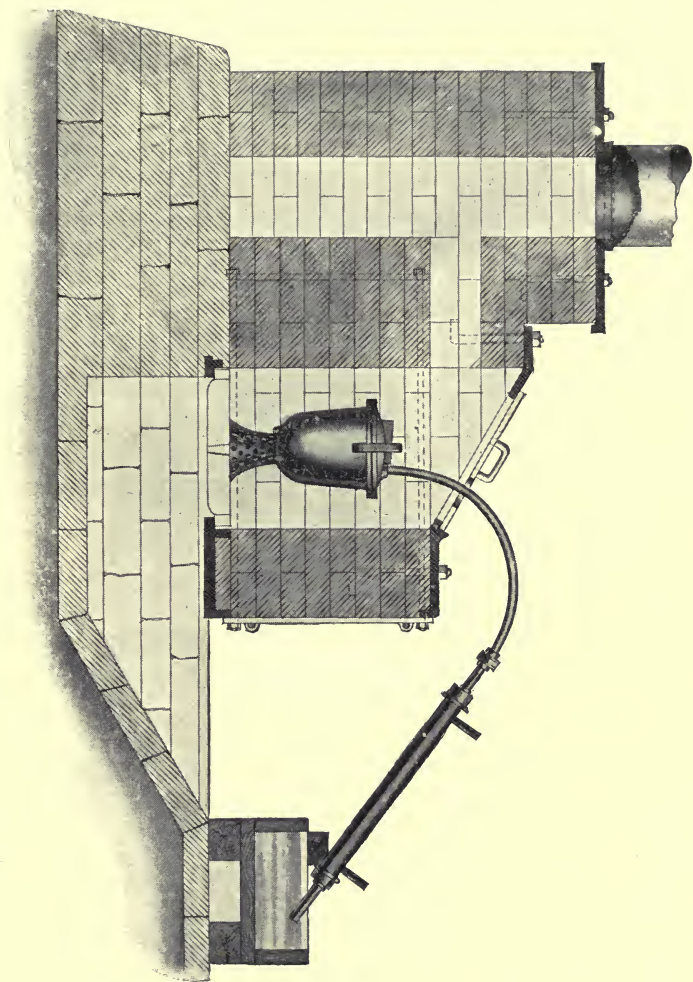

FIG. 52. GOLD RETORT.

A summary shows, that of this cost, \$0.153 was for supplies, \$0.160 for labor, and \$0.095 was for power. This is for a free-milling gold ore.

In Gilpin county, Colo., where the tonnage put through is small, the cost was 78c. per ton in 1891.

18. LEACHING METHODS FOR THE EXTRACTION OF GOLD FROM ORES.

Gold occurs in ore in sizes from grains, or even nuggets, down to particles of microscopic size. When in particles, in sizes which show as colors in panning, it is called coarse gold, and such particles are obtained from gold by amalgamation. Much gold occurs, however, not only in microscopic particles,

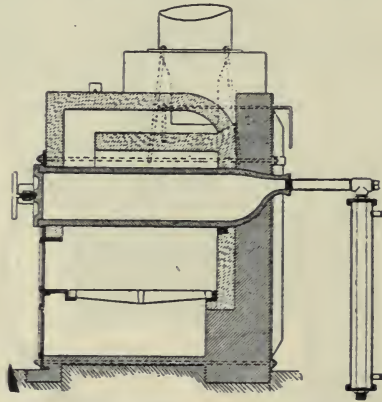

FIG. 53. HORIZONTAL RETORT.

but also in films upon the surfaces of pyrite crystals. When in this state, it is capable of being dissolved by aqueous solutions containing chlorine or cyanide of potassium. Advantage is taken of this to get the gold in solution by leaching or percolation methods, in which the ore is treated in vats or tanks by such solutions, the gold being afterward precipitated from the clear filtrate in a flaky form. These flakes or particles are caught on a filter, and later dried and melted down into gold ingots.

There are, therefore, three stages in obtaining the gold by leaching: First, the ore is finely ground, and, in certain cases,

roasted to render the gold more soluble and accessible to the solution; second, it is leached out by means of a dilute solvent in a tank having a filter-bottom; third, the gold is precipitated by means of hydrogen sulphide or by zinc from the filtrate, collected on a filter, dried and melted.

Up to the present time there are two methods by which gold may be dissolved from its ores, and got into an aqueous solution to be subsequently precipitated as metal; viz., the Plattner process in which the gold is gotten into solution as chloride, and the McArthur-Forrest process by which it is obtained as potassium or sodium auro-cyanide.

19. CHLORINATION OF GOLD ORES.

This process depends upon the action of chlorine gas upon gold. The auric-chloride is leached out with water and the metallic gold precipitated from the solution of its chloride by hydrogen sulphide or by ferrous sulphate.

The ores best suited to chlorination are those which cannot be successfully amalgamated, such as concentrate, in which the gold is in a state of fine division, and which contains but little silver. The latter as an insoluble chloride is apt to coat the particles of gold. Since chlorine attacks arsenides and antimonides, ore containing them should be subjected to an oxidizing roast to drive off arsenic, antimony and sulphur, and to oxidize the metallic bases. A little salt is added to this roast to chloridize whatever metals are capable of being so acted upon. Besides this, roasting makes the ore more porous, and therefore more accessible to the action of the chlorine.

Roasting the ore. The ore, dry-crushed to from 10 to 30-mesh size (see Section 8), must first be roasted. This is done frequently in long hand-rabbed reverberatories, and also in one of the automatic roasting furnaces such as the Wethey-Holthoff furnace (see Fig. 36). (This latter has a cooling-hearth where the temperature of the ore may be brought down to a point where it can be charged to the chlorinating apparatus.) The roasting should be conducted at a low temperature, which is only raised at the finish in order to decompose sulphates as far as possible.

There are two methods of chlorinating ores, *vat* or *Plattner* and the *barrel* or *Thiess process of Chlorination*.

In the vat method the ore is charged, in moistened condition, into a tank or vat, and there treated by chlorine evolved in a separate vessel. In barrel chlorination the ore is acted on in rotating barrels or cylinders by means of chlorine generated within the barrel itself. The continuous movement of the materials of the charge brings the gold in the ore intimately in contact with the chlorine, which in nascent condition is supposed to act powerfully in promoting solution.

Vat chlorination recommends itself because of the small investment in plant, aside from the roasting furnace used. While the capacity of such a plant is small it is sufficient for the amount of concentrate which it is called upon to treat.

20. THE VAT OR PLATTNER PROCESS OF CHLORINATION.

The ore, having been subjected to an oxidizing roast to free the gold and to make the ore of an open porous texture, is moistened and charged into a vat or tank, 8 or 9 ft. diam. by 3 to 3.5 ft. deep. These vats (see Fig. 54) have a false bottom of perforated 1-in. boards supported on 1-in. strips. Upon the perforated bottom is spread a 6-in. layer of coarse gravel of hen's egg size at first, becoming smaller at the top. Above this is a layer of 2 in. of sand, on which is laid either a canvas filter cloth, or a layer of boards. Chlorine gas is admitted at *a*, and drainage of the vat takes place through the hose *b* into the launder *c* leading to the settling vat.

The 4-ton charge of ore must be moistened to the right degree (about 6%), since, when too dry, it is not well acted on by the chlorine, and, if too moist, the gas does not pass through it well. The charge is thrown into the vat through a screen of 0.5-in. mesh, which at once breaks up all lumps and causes the ore to fall loosely and scatteringly. When the vat has been filled to a foot in depth, chlorine is allowed to pass into the space below the false bottom and rises through the ore. The charging being continued, the vat is filled to within 3 in. of the top, and is covered with sacking. The cast-iron cover *d* is then

brought by an overhead crawl to the tank and lowered upon it, the joint between being made up of a clay-mortar interlaid with a cloth strip to keep it moist and tight. Chlorine is allowed to enter the vat for 5 to 12 hours, according to the fineness of the gold; the finer the gold the faster it is chlorinated. The charge is sufficiently saturated with chlorine when, upon opening a stop-cock on the cover, escaping fumes of chlorine

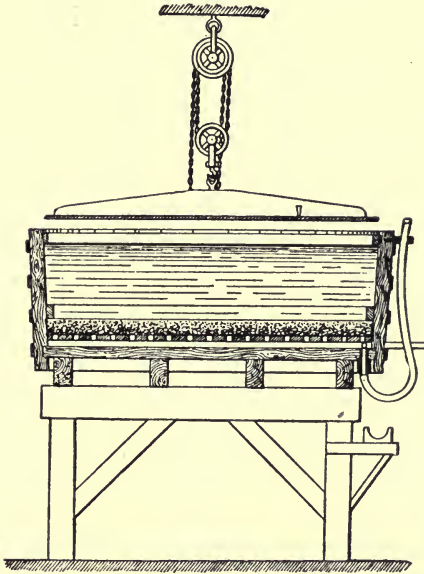

FIG. 54. CHLORINATION LEACHING TANK.

can be detected. After this the covered vat is allowed to stand 24 to 40 hours to chlorinate.

We have at first:

$Au + 3Cl = Cl + AuCl_2$, which is an insoluble compound.

In presence of water, however, we have the reaction:

$Aq + AuCl_2 + Cl = Aq + AuCl_3$. This latter salt is soluble in water, so that the gold can be leached. Hence the importance of at first moistening the ore.

The chlorine is produced in a generator (Fig. 55). This is of cast iron, lead lined, and has a heavy, tight cover. It is 24 in. diam. by 16 in. deep for a 4-ton charge of ore. To charge it a

plug in the cover is removed and the solid chemicals put in. These are 20 to 27 lb. of binoxide of manganese and 27 to 32 lb. of common salt. From 40 to 60 lb. of sulphuric acid of 66° Bé is added through the fissle tube *u*, followed by 24 to 33 lb. of water. The chlorine is generated according to the reaction:

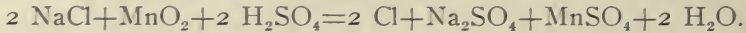

The apparatus stands upon a water or steam-bath on which it can be heated to 50° C which is the best temperature for generating chlorine. Through the tube *b* the gas passes to a wash-bottle to remove HCl, and thence to the chlorinating tank.

The charge having remained in the vat for 48 hours is ready for leaching. To do this, the cover is removed, and the water run on over the sacking, it being thus uniformly distributed over the ore. As soon as the tank is quite full of water, which no longer settles through it, the solution is allowed to escape through the hose *b*, let down for that purpose, the supply of water being kept up at the top until the escaping solution shows no reaction for gold. Two tons of water is needed per ton of ore. The tailing often contains silver which, when in sufficient quantity, can be later recovered by hyposulphite lixiviation (see Section 45).

Passing to the settling tank the solution is allowed to settle out its sediment for several hours, after which it goes to the wooden precipitating tank 6 ft. diam. by 3 ft. high, painted with hot asphalt to which has been added some Portland cement. The precipitant for the gold is a solution of ferrous sulphate, prepared at the works by dissolving scrap-iron in sulphuric acid. It precipitates the gold as follows:

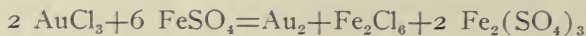

The precipitant is stirred in, after which the vat is covered and the gold allowed to settle for at least 12 hours, often much longer. The supernatant solution is then run off, preferably to a filter press, the filtrate from which is later received into a saw-dust filter to catch any further particles of gold that may have escaped pressing. Precipitation with ferrous sulphate has the disadvantage of being very slow of completion, the solution showing a purple color, due to the presence of gold, for days

after the precipitation. It is inferior in its action to hydrogen sulphide.

The precipitated gold is filter-pressed and washed with dilute sulphuric acid, then with hot water to remove the ferric salt still retained by it. It is finally melted with soda, borax and nitre in graphite crucibles. The gold thus obtained is 920 to 990 fine, the impurities being iron and lead. The extraction or recovery of gold varies from 90 to 92%.

Costs.

The cost of erecting a plant in California, capable of treating 6 tons daily, may be given at \$6,000 to \$7,000. In 1886 the

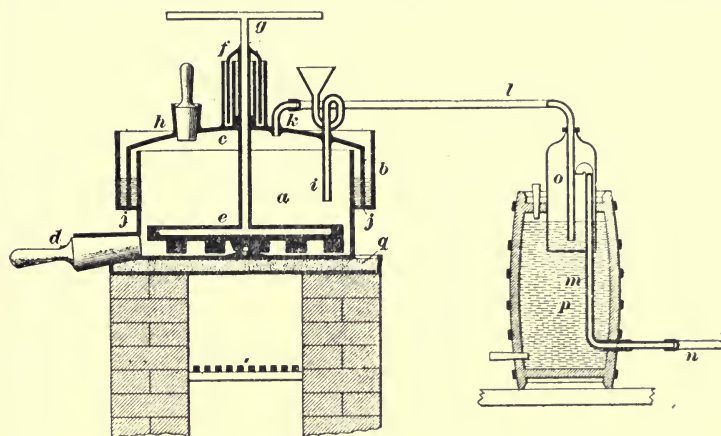

FIG. 55 CHLORINE GENERATOR.

cost of chlorination at the Providence mine was \$6.30 per ton, not including the items of supervision, interest and depreciation, about one-half being the cost of roasting. This cost has since been considerably reduced by the use of fuel oil and automatic furnaces of the Edwards type.

21. BARREL CHLORINATION.

The chlorination barrel.—These barrels or cylinders, as shown in Fig. 56, are rotated on a horizontal axis, being carried on trunnions, and driven by spur gearing at 12 rev. per min. The cylinder is lined with sheet lead bolted to the shell, and, as

shown, carries within it a filter-frame or diaphragm of hard wood intended to filter the solution after treatment, so as to obtain a filtrate containing the gold in solution. On this rests lead plates 0.375 in. thick, perforated with 0.375 in. holes 0.75 in. apart. The plate itself is corrugated for the freer circulation of the filtrate over it. Instead of these plates a board or plank floor, similarly perforated, has been used. Upon the plates rests a filter of sheet lead of a weight of 4 lb. per square foot. This sheet is perforated with holes 0.05 in. diam., 0.375 in. apart. To hold down the filter-sheet another frame is fitted over it and securely bolted down. The wood underframes last three months, the upper ones but two or three weeks. Barrels have been made up to 18 tons capacity, 6.5 ft. diam. by 16 ft. long. The common size is, however, 5.5 ft. diam. by 12 ft. long.

Charging.—In operation, the ore, already crushed and roasted, is drawn off from the storage bins in two-wheeled buggies, and is placed in weighed charges in the charging-hoppers belonging to each cylinder. Into the cylinder is first run 135 to 140 gallons of water per ton of ore. Next a measured quantity of sulphuric acid is added, and upon this, the charge of ore. Lastly is added a weighed amount of bleaching powder. The quantity of chemicals to be added to the charge depends upon the nature of the ore, and is determined by experiment. On roasted Cripple Creek ores is used 12 to 15 lb. of bleaching powder per ton of ore of 34 to 36% available chlorine, and 24 to 30 lb. sulphuric acid of 66° Beaumé.

The charge-openings of the barrel are now closed, and the barrel set slowly revolving (12 rev. per min.) for a period indicated by experience, being from one to four hours. (In the case of Cripple Creek ores, 3 hours.)

The chemicals are brought thoroughly in contact with the ore, and with one another, producing the following reaction:

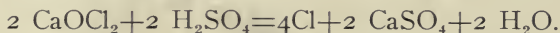

The chlorine, in formation in a nascent condition, acts with greater energy upon the gold, forming a soluble gold chloride thus:

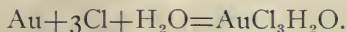

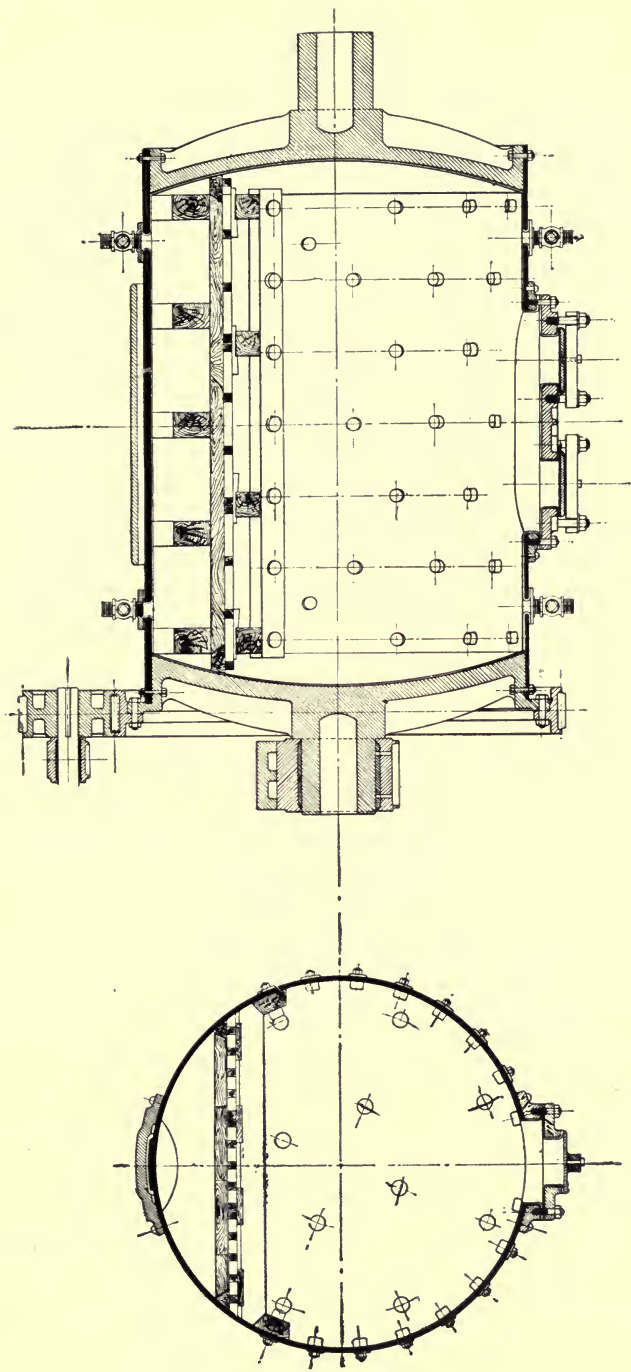

FIG. 56. CHLORINATION BARREL.

To determine when the ore has been thoroughly saturated by chlorine, a small stop-cock on the barrel is opened, and the issuing gas tested for chlorine with ammonia with the formation of a white NH_4Cl fume. Another way of furnishing chlorine, which has been used, is to add it to the barrel in liquid form, it being obtainable in the market in that form stored in drums.

The barrel is revolved for another hour, after which it is stopped with the filtering-diaphragm down; the outlet pipe is opened and connected by hose to the settling tanks, and water is pumped into the barrel above the charge. The barrel is also connected to the compressed-air tank, and the filtering proceeds under pressure. The excess of chlorine is absorbed by the water, and does not enter the building. At definite intervals leaching is suspended, and the barrel revolved a few times to mix its contents and to break up channels which may have formed during the leaching. The compressed air is admitted at a pressure of 30 to 40 lb. per square inch, and the time of washing and leaching is, on an average, 2.5 hours, the water used being 50% by weight of the ore. After the leaching is over the barrel is emptied by opening the man-holes and revolving the cylinder, after which the filter is washed with a hose in readiness for another charge.

The solution from the barrels is received into lead-lined settling tanks, 10 ft. diam. by $7\frac{1}{2}$ ft. high. Here any sediment is settled out during 8 hours, while the supernatant clear solution is withdrawn from a point 10 in. above the bottom, so as not to disturb the settling, and is sent to the lead-lined precipitation tank (Fig. 57) 10 ft. diam. by 12 ft. high entering it through *A*.

Precipitation of the gold.—Referring to Fig. 57, precipitation of the gold is performed as follows: The free chlorine, contained in the gold solution in the precipitation tank, is first removed by passing in sulphur dioxide from the generator *h*. This generator contains a pan in which lump sulphur is set on fire. Compressed air, being admitted by means of the pipe *n*, serves to burn the sulphur and to drive the fumes into the solution by the pipes *o* and *u* to the lead pipe *r*, perforated where it crosses the bottom of the tank. The SO_2 gas acts according to the following equation:

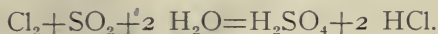

The chlorine having been removed, hydrogen sulphide is passed into the solution to precipitate the gold. Of late, treatment with SO_2 gas has been omitted, H_2S gas being alone used. At first it is oxidized by the chlorine, after which it begins to precipitate

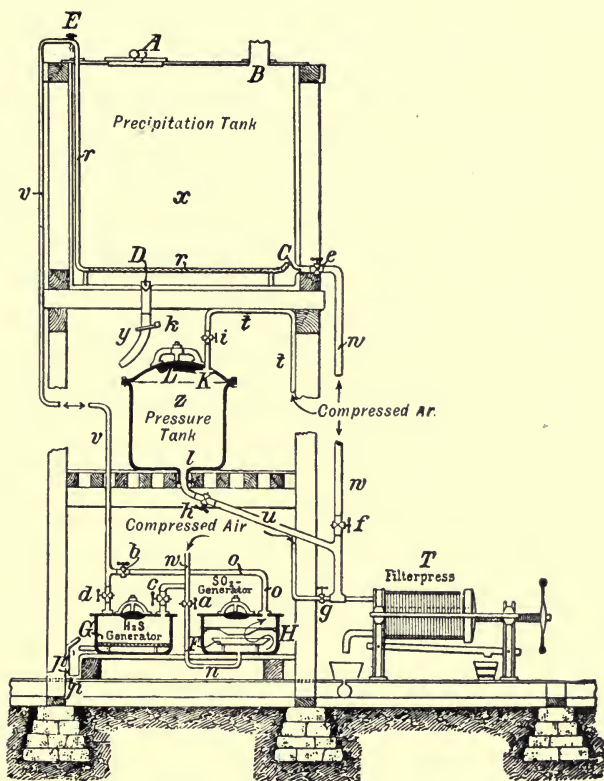
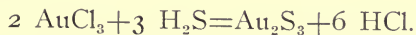

FIG. 57. PRECIPITATION APPARATUS FOR BARREL CHLORINATION.

the gold. Hence, we have, after removal of the chlorine, the following reaction:



The precipitation is rapid, taking only 10 minutes, and as the gold is thrown down before the copper, it is possible, by careful working, to leave the greater part of the copper in

solution. Referring again to Fig. 57, *g* is the lead-lined H_2S generator. It contains a perforated sheet-lead shelf on which lies 1-in. pieces of iron sulphide upon which is brought the H_2SO_4 for the generation of the H_2S . The valve *d* having been opened and *b* closed, the gas passes through the pipes *v* and *r* to the solution, being driven through it by compressed air admitted to the generator at *c*. When the chemicals in the generator are exhausted they are drawn off into a waste launder *p*. The chemicals for precipitation needed, per ton of ore roasted, are, iron sulphide 1 lb., sulphur 0.25 lb., and sulphuric acid 2.5 pounds.

After precipitation the Au_2S_3 is allowed to settle for two hours, after which the supernatant solution is drawn off at *C*, 10 in. above the bottom of the tank, through the pipe *u* into the filter press, being under its own hydrostatic head of 25 ft. The filtration is performed to recover possible flakes of gold sulphide which may not have settled to the bottom of the tank. In 3 to 4 hours after precipitation the tank is ready to receive a fresh charge. The life of a set of filter-frames is equal to from 6,000 to 7,000 tons of ore treated. The precipitated gold sulphide collects upon the bottom of the tank and, every month or two it is drawn off through *D*, by the rubber pipe *y*, into the pressure tank *s*, the tank being also washed clean with a hose. The pressure-tank *s* is 4 ft. diam. by 4.5 ft. high. Into it air is forced through *t* and its contents driven by the pipe *u* through the filter-press *T*, elsewhere described and illustrated in Fig. 62. The filtrate from the press, as a safeguard, passes over a filter-bed placed in a shallow tank before finally running to waste.

The precipitate of gold sulphide contains a certain amount of precipitated sulphur together with the sulphides of arsenic, antimony, copper and silver, forming a 'sulphide cake.'

This cake is mixed in trays 44 in. long, 24 in. wide, and 4 in. deep, with some borax, soda and nitre, and the trays are placed in cast-iron muffles heated by coal. These muffles are connected with a flue-chamber where any mechanically escaping dust may be caught. In the muffles the precipitate is dried out, after which the heat is raised to roast off and decompose the sulphides, the operation taking an hour. The roasted material will have a light brown color, and contains upward of 70 to 80% Au.

It is now carefully transferred to a crucible and melted down in a wind furnace. The contents of the crucible are poured, slag and all, into a conical mold, the gold settling to the bottom. Upon cooling, the gold ingot, 900 to 950 fine, is separated from the slag, re-melted and cast into a bar in readiness to ship away to the U. S. Mint. Here, after deducting a charge of 2c. per ounce for melting and assaying, the gold should net \$20.65 per ounce.

The slag resulting from this melt may be re-melted with one-seventh of its weight of litharge with the addition of some reducing agent, and a lead button obtained. This lead can be scorified, and finally cupelled in the muffle, to obtain the small additional amount of gold.

The above is not the only way of precipitating the gold—precipitation by means of charcoal having also been used. In this method the filtered solution from the barrels is heated to 50° C to precipitate lime-salts and to drive off chlorine. It then goes through a charcoal filter 40 in. diam. made as follows: The false bottom of the filter is a thick perforated lead plate on which rests 1 cu. ft. coarse charcoal, then 8 cu. ft. fine charcoal and finally 3 cu. ft. of coarse charcoal. The coarse charcoal has been broken to lie between 20 and 30 mesh, the fine between 30 and 40 mesh. Both grades are washed to free them from dust. The gold solution is filtered hot at the rate of 20 gallons per hour leaving the solution with 0.003 to 0.007 oz. gold only. The gold shows as a gilded appearance upon the surfaces of the particles of charcoal, especially at the top layers where most of the precipitation occurs. The exhausted filtrate is run into a tank having a lead-plate false-bottom and containing sawdust to the depth of a foot. Yearly this sawdust is burned and the ashes sold to the smelter.

The charcoal is periodically removed from the filter and burned upon flat plates, from which the ashes can be carefully swept up. These ashes, containing 5 to 10% of gold, are melted in crucibles with their own weight of a 1 to 1 mixture of soda-ash and borax. The melt is poured into a conical mold, and upon cooling the gold is removed and re-melted into an ingot. The slag is sold to the smelters.

The extraction of gold is 90 to 94% according to the nature of the ore. The silver is not recovered, being in the form of an insoluble silver chloride. However, if some salt has been used in the preliminary roasting, the silver chloride then formed, if insufficient in quantity to pay, may be extracted by further treatment, leaching it by means of sodium hyposulphite with a recovery of 60%.

We give herewith the cost per ton of treating Cripple Creek ores on a large scale by barrel chlorination:

Labor, including salaries.....	\$1.34
Chemicals and supplies.....	0.72
Fuel, roasting and power.....	0.70
Renewals and repairs.....	0.45
Miscellaneous expenses.....	0.32
	<hr/>
Total cost per ton.....	\$3.53

The chemicals used in the process are: Sulphuric acid (oil of vitriol of 66° Bé.) \$0.90 to \$1.10 per 100 lb.; chloride of lime (bleaching powder) \$1.80 per 100 lb., (New York); sulphide of iron \$3 per 100 lb., or it can be made at the works from wrought-iron scrap and sulphur; sulphur \$2 per 100 lb.

The quantity of water needed for high-pressure steam power and for chlorination will be 2 tons per ton of ore treated. This can be reduced if settling tanks are employed and the water used over again.

22. CYANIDING OF GOLD (AND SILVER) ORES.—GENERAL OBSERVATIONS.

The process of cyaniding consists essentially in attacking gold and silver ores by dilute solutions containing less than 0.5% cyanide of potassium (caustic soda or lime being added to ores which have been rendered acid by the oxidation of pyrite) and then in precipitating the precious metals by means of zinc shavings or zinc dust, or by electrolysis.

The process is a success with many ores, and its field of usefulness is bound to be greatly extended, partly at the expense of the chlorination process.

The chief advantage of cyaniding over chlorination is that roasting is by no means always essential even when sulphides are present. This is an important point in the treatment of low-grade ores, especially where fuel and labor are costly.

It will be noticed that the dilute cyanide solution must have a selective action, that is, it must be able to dissolve the gold and silver without attacking the base metals which may be present. If, however, copper is present, it will consume cyanide, though the presence of copper in small quantities is now no longer considered a serious obstacle to cyaniding.

The ores to which the process is adapted are:

1. *Free-milling ores* in which the gold is in fine or microscopic particles. If the gold is in coarse particles it takes so long to dissolve it that the method would be impracticable. However, it is possible to remove the coarse gold by amalgamation, after which the residue can be treated by cyaniding.

2. *Telluride ores*, which have first been roasted to set the gold free from its combinations with tellurium.

3. *Pyritic ores* in which the gold occurs upon the faces of the crystals of pyrite as films. When this is crushed fine enough to expose these faces the gold is attacked by the solution. Some pyrite ores, however, have the gold included in the substance of the crystals and hence may be profitably roasted. Roasting has also the advantage that it renders the ore more porous and therefore more accessible to the solution.

Talcose or clayey ores, when crushed for cyaniding, make a great deal of slime which is exceedingly difficult, if not impossible, to leach, and hence require treatment as a slime, adding much to the cost of extraction.

23. DEVELOPMENT OF THE CYANIDE PROCESS.

Beginning in South Africa in 1889, the process was at first applied to the treatment of impounded tailing from the gold stamp-mill to recover the gold not extracted by amalgamation. This tailing was leached in vats with cyanide solution to dissolve the gold which was then precipitated by sending the solution through zinc boxes full of zinc shavings. So long as these

dumps lasted, this simple treatment was sufficient, but when finally the tailing had to be treated as fast as it was produced, the practice was modified as follows:

The pulp as it left the amalgamation plates was run through classifying boxes which gave two products. The first of these was the coarse sand or concentrate. This was treated for a long time and with comparatively stronger solution to effect recovery. The second product was the mingled slime and sand whose acidity was neutralized by the addition of a regulated amount of milk-of-lime which flowed into a launder which led to a Butters & Mein distributor (Fig. 77). This latter delivered it evenly to a settling vat, the clean sand settling out while the slime was carried away in the escaping turbid water; when the settling vat had been filled, its excess of moisture was displaced by a weak solution, after which the contents of the vat were shoveled through trap-doors into a leaching vat set immediately under the upper one. Strong solution containing 0.15 to 0.25% potassium cyanide was then allowed to percolate through this sand for a certain number of days, was displaced by weak solution, and finally by water. These solutions, as they left the vat, were run through the zinc boxes to precipitate their contained gold. The exhausted tailing was then shoveled out and trammed away.

The slime was caught in large vats, allowed to settle, and the supernatant water decanted. A very dilute cyanide solution was added to the remaining slime and the whole was agitated by a mechanical stirrer. After some hours' treatment this mixture was allowed to settle and the clear liquid precipitated by zinc shavings.

Since settling by decantation was slow, a large number of vats was needed and moreover the last portion of the gold could not be saved, so that decantation was succeeded by the filter-press method of slime treatment. This consisted in filter-pressing the agitated slime under high pressure through such a press more fully described in Section 31.

The comparatively high cost of this system led to the adoption of the Moore system and to similar methods of suction filter-pressing. The most successful of these is that of Cassel & Butters.

The West Australian ores are of such a nature that, to liberate their contained gold, fine grinding was needed, and while this fine material could not be leached in vats, it could be filter-pressed. This led to the use of the grinding pan as employed in silver amalgamation and chiefly to the adoption of the tube-mill, which has proved itself particularly efficient in fine grinding.

The trend of modern practice is toward fine grinding and to the treatment of the whole product either as a slime, or else a separation of the ground product into sand and slime, the former to be treated by percolation, the latter by a filtering process.

24. CHEMISTRY OF THE CYANIDE PROCESS.

When a dilute solution of less than 0.5% of potassium cyanide is brought in contact with finely ground ore, in which gold occurs in metallic finely divided particles, the gold goes into solution according to the reaction first set forth by Elsner as follows:

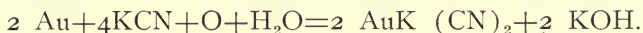

or with the formation of an auro-potassium cyanide and of caustic potash. According to this reaction 1 oz. of potassium cyanide should dissolve 1.5 oz. of gold, but, in practice, 30 to 40 times this quantity is required. The reaction ceases when the oxygen of the dissolved air is gone, and begins again with the access of fresh air. Oxidizing agents, as potassium chlorate and permanganate, and the peroxides of lead, manganese and sodium may replace air in furnishing oxygen, but are more expensive. Silver may be dissolved as well as gold by the same reaction, namely:

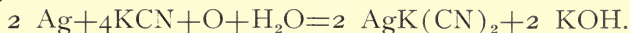

Silver dissolves less readily, however, than gold.

Another powerful reagent has been found in bromo-cyanide, made from the crystals or at the works by adding bromine water to cyanide solution, which reacts with potassium cyanide thus:

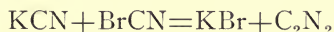

forming cyanogen (C_2N_2) which in nascent condition acts directly on the gold as follows:



Bromo-cyanide, which does not require the aeration of the solution, as when the ordinary cyanide solution is used, is, however, more expensive, and has been applied only to those sulphotellurides which are unattacked or but slowly attacked by the latter.

When pyritic ore has been mixed and left out in the weather, air and moisture act on it thus:

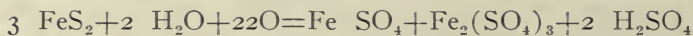

While this action is apt to be superficial, still the ore gives an acid reaction, and decomposes cyanide solution with the formation of hydrocyanic acid. To prevent this the ore should be given a water-wash to remove the sulphuric acid and ferrous sulphate, while the ferric sulphate may be neutralized by a caustic soda solution, or preferably, by lime-water which converts it into a harmless hydrate.

To precipitate gold from its solution, zinc, either in the form of shavings or as zinc dust, is used; the gold being obtained as a black or brown precipitate thus:

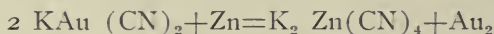

According to the equation one part zinc should precipitate 6.2 parts gold, but in actual practice one part of zinc is needed for 0.2 to 0.07 part of gold, much zinc being used up to satisfy reactions produced by other substances in the solution.

25. OPERATION OF PLANT.

The modes of operating cyanide plants will vary in accordance with whether the plant is treating dry crushed ore, sand and slime, or slime alone. In the treatment of dry crushed ore, and of sand in direct-treatment plants the leaching is an important operation.

Leaching.—The fineness to which ore must be crushed in order to give the best results by leaching must be determined for each case. With the porous ore coarse crushing is permissible. With some hard ores or those in which the gold is uniformly distributed and very fine, it is necessary to crush fine or even slime the material in order to get satisfactory extraction. We will assume an average case of a sand of which about 50% will pass

a 100-mesh screen. If impounded tailing or dry crushed ore, it is at once delivered to the leaching tanks, varying in diameter from 12 to 40 feet, by means of cars or belt conveyors, and evenly distributed. If delivered to the tank wet after crushing in stamps, it has either had a preliminary settling, or the settling and leaching may be accomplished in the same tank, as at the Homestake mills in South Dakota. In either case the charge is simply leveled off, and the strong solution run on the top or



FIG. 58. BLAISDELL EXCAVATOR.

introduced from underneath the filter. The method of introducing solution varies greatly in different mills. This strong solution contains from 0.2 to 0.3% potassium cyanide; if the ore contains much silver, the strong solution may be as strong as 0.4% cyanide. The proper strength of solution is an important consideration and must be determined experimentally. When the charge is saturated it is customary to allow it to soak for several hours in order to permeate the charge thoroughly and thereby avoid channeling during percolation. The valve

under the filter is then opened and the solution allowed to run to the gold solution tank. Thence it passes to the zinc-boxes, to the sumps, and finally to the storage tanks where it is re-enforced with more cyanide and used over again on the charge. Thus the charge is subjected to a series of percolations with strong solution, the solution being allowed each time to disappear below the surface so as to draw down air into the sand and accelerate the extraction. The strong solution may be applied for several days. With gold ores from 4 to 6 days are usually sufficient. With silver ores leaching from 10 to 20 days is required. When the final strong solution is drawn off, a weak solution of from one-third to one-half the strength of the strong is applied; and finally a wash of water is run on to wash out the last traces of dissolved metals before the residues are discharged. These residues may be discharged in various ways: Into cars through side doors (see Fig. 72); or sluiced out with water into a flume beneath the tanks, or removed by means of a very effective device known as the Blaisdell excavator, which is now used in large modern plants and effects a great saving in labor cost (Fig. 58).

Slime treatment.—In all wet crushing mills the production of a certain amount of slime is unavoidable, that is, a product composed of such finely divided particles of quartz and clay that it cannot be treated by percolation. This so-called 'slime' may consist of from 20 to 40% of the total ore crushed. As it requires a separate treatment, it is usually segregated by means of classifiers of which there are a great variety, the cone classifier with a central intake and a peripheral overflow being now most commonly used in the United States (Fig. 76). As we have already noted, when the cyanide process was first introduced into South Africa the sand alone was treated, the bulk of the finest slime having been allowed to overflow from the dams. But as the slime carries about as much metal as the sand, and in some instances considerably more, the necessity of treating this product was soon recognized. The great difficulty besetting the slime problem was to find some cheap method of removing the slime solids from the solution carrying the precious metals. As we have seen, decantation was at first tried and is even now

used in South Africa, being the cheapest available method for handling the low-grade slime in that field. This was followed by the introduction of filter presses in West Australia and the vacuum filter in the United States.

In view of recent developments in cyanide practice a plant for the treatment of slime is a necessary adjunct of nearly all mills for the wet reduction of gold and silver ores. The first step in the treatment is the settling of the slime. To accomplish this the slime overflow from the classifiers is conducted to the centre of a cone-bottom settling tank (Fig. 76) and dropped into a cylinder of about 12-in. diam., which is suspended over the centre of the tank and extends about half way to the bottom. By this means the agitation of the falling slime is confined to the interior of the cylinder: while the surface of water outside the cylinder is perfectly quiet. These settlers are of varying size. In operation the clear water rises around the central cylinder while the slime settles to the bottom: and the clear water finally overflows at the top of the tank into a circular launder provided for that purpose. This settling and clarifying operation goes on for about 24 hours. The number of tanks required for this purpose will obviously depend upon the capacity desired and the rapidity with which the slime settles. The capacity of the tank must be carefully estimated for any particular slime, as there is as much difference in the character of slime and its rate of settling as in ores themselves. It must be borne in mind, too, that the settled charge of slime becomes less dense as the filling proceeds; consequently at a certain time the separation of water from slime is no longer perfect and the slime begins to flow over with the water. When this occurs, the stream should be at once shifted to another tank, and the contents of the first settler allowed to settle undisturbed. Usually twelve to twenty-four hours are allowed for settling. The settler is provided with a decanting apparatus consisting of a pipe connected with a flange at the bottom of the tank by means of a swivel joint, which permits of raising and lowering the pipe at will. Unless the pulp has already been crushed in a cyanide solution (see practice in Black Hills) enough cyanide solution is added to the pulp, now containing about 50% moisture, to raise the whole to the desired

strength and to make a consistency of about 3 parts solution to one of dry slime. This pulp is then transferred by gravity or by centrifugal pump to the agitator. In some plants the same tank answers for both settler and agitator. The choice must be governed by conditions. In general, the settler should be large in diameter at the expense of height; the agitator, just the reverse, especially if the centrifugal pump is to be used for agitating. Moreover, the object of the agitator is to prevent settling, hence it is desirable that the bottom have a steeper slope than the settler. In very large tanks, however, the cone-bottom may be dispensed with, owing to difficulties and expense of construction: and all such tanks may be provided with stirring devices to facilitate emptying.

26. CLASSIFICATION OF METHODS.

First method.—Where the ore is soft and oxidized, and no advantage is to be gained by amalgamation and concentration, it is crushed dry in rolls and treated by leaching, either with or without roasting; examples, Cripple Creek, Colorado; Mercur, Utah.

Second method.—Where the ore is stamped, then treated by amalgamation or concentration, or both, and the tailing treated by cyanide after separation of sand from slime. This class may be divided into three sub-classes:

A. Mills in which the slime is treated by decantation; best example, South Africa.

B. Mills in which the slime is treated by filter-pressing; best examples, New Zealand; Homestake mine, South Dakota.

C. Mills in which the slime is treated by the vacuum filter; best examples, Terry, South Dakota; Liberty Bell mine, Colorado; Goldfield and Virginia, Nevada.

Third method.—Where the ore is crushed in stamps and either a large part or the whole of it re-ground or slimed in tube-mills. (1) At El Oro, Mexico, a large part of the ore is re-ground in tube-mills; the fine sand is leached and the slime treated by decantation. (2) At the Liberty Bell mill, Telluride, Colorado, the whole product from 80 stamps is reduced to a

slime in tube-mills. This product is then treated by agitation and filtered on the Moore vacuum filter.

Fourth method.—Where the ore is crushed in stamps, amalgamation and concentration omitted, the sand leached and the slime treated by decantation. The interesting feature of this method is that the ore is crushed in the cyanide solution. The process is applied successfully at large plants in the Black Hills, South Dakota.

Fifth method.—The reduction of the ore to a slime, followed by filter-pressing; example, West Australia.

27. FIRST METHOD OF CYANIDING.

This is well suited to the treatment of ores, that do not produce much slime and do not require amalgamation and concentration; or to ores which require roasting. It must not be forgotten that silver, as well as gold, is extracted by cyaniding, though not to the same extent.

The conditions requiring dry crushing are comparatively rare, and in many instances, for economical reasons, dry crushing plants have been converted into wet crushing. Where efficient rolls can be had, dry crushing is preferred for the following reasons:

The ore is delivered to the tank dry and therefore there is no dilution of the solution as in treating wet ore, and in the treatment of dry-crushed ore less water is required.

A more uniform and more easily percolated bed can be obtained and the ore is better aerated, the oxygen present assisting, as we have already seen, in the dissolution of the gold.

Finally, dry-crushing by rolls ensures a more granular product than is attainable by stamp-milling.

On the other hand, the cost of dry-crushing beyond a certain mesh is excessive; and except in rare instances, it is not practicable to crush fine enough in rolls for the highest extraction.

The rate of percolation of dry-crushed material will vary in accordance with the proportion of slimy material (talc or clay). So long as that rate is not less than 1 in. per hour such material can be treated without first removing the slime by methods to be described later.

Fig. 59 and 60 represent, in plan and sectional elevation, a 75-ton plant designed to treat impounded tailing containing so little slime that only 37% of the material will pass an 80-mesh screen, so that a charge of it may be treated in four days. *a* is the strong-solution tank 12.5 ft. diam. by 10.5 ft. deep, containing a stock solution of, for example 0.25% potassium cyanide, or 5 lb. per ton. *a'* of the same size, holds the weak solution, which may be specified as containing 0.1% or 2 lb. KCN per ton. Both these tanks are situated above, and supply the leaching-vats, *b b b b*, each 20 ft. diam. by 6.5 ft. deep inside, having a capacity of 75 tons of ore, or 85 lb. per cu. ft. The strong-solution stock-tank is connected to both top and bottom of the leaching vats by the pipe, *C*, while *C'* supplies the vats at the top. A pipe, *X*, beneath the charging platform, gives a supply of water for sluicing out the contents of the vats where, as in this case, that method is used for the removal of the exhausted ore. *Y* is a platform placed 4.5 ft. below the top of the vats for convenience of access. *Z* is the charging platform, not shown in the plan, Fig. 60, by which ore is brought in and dumped into the leaching-vats. There are two gold-solution vats, *h h'* (strong and weak solutions) 12.5 ft. by 5.5 ft. deep, which receive the filtrate from the leaching vats by way of launders, *d* and *d'*, and deliver them in a regulated stream to the zinc-boxes, the strong solutions passing through *K K K* to the sump-tank *l*, and the weak solutions through *K' K'* to the tank *l'*. There are five sets of these boxes, each containing 9 compartments 12 in. deep, 15 in. long and 24 in. wide. *W* is a centrifugal pump by which the contents of the sumps may be returned to their respective stock-tanks *a* and *a'*. By means of the vacuum tank *S* and pump *V* a vacuum may be created beneath the false bottom of the leaching-vats, thus increasing the rate of percolation. The liquid thus removed is discharged from the tank by the pipe *U* to either of the gold-tanks from their respective sump-tanks. On the near side of each of the zinc-boxes is to be seen a double line representing the launders, by which gold precipitate is carried from any of the boxes and delivered through the launders *n* and *m* to the 'acid tank' *o*. In this tank the gold precipitate is treated with sulphuric acid for the removal of the entangled zinc, the clear

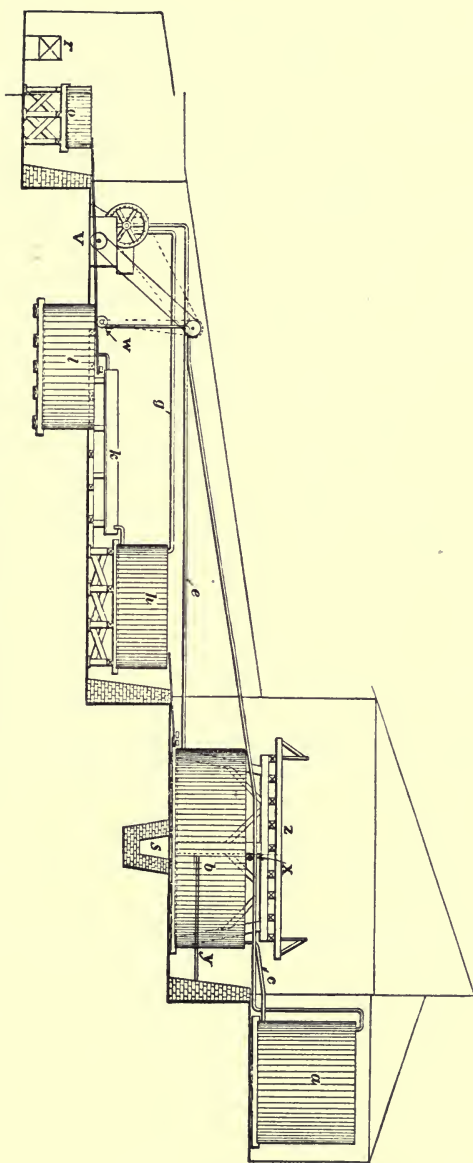

FIG. 59. ELEVATION OF CYANIDE PLANT.

supernatant liquid being decanted to the settling tank *p*, while the settlings of the acid tank go to the filter-press *r*. The other apparatus consists of a gasoline engine, or a motor, which furnishes power to operate the pumps, a drying furnace for drying the precipitate and a melting furnace where the dried precipitate is reduced to bullion.

A plant, such as above described, costs \$150 to \$200 per ton of ore capacity in 24 hours. This does not, of course, include the plant for crushing the ore.

Precipitation.—The strong and weak solutions, leaving the leaching vats, are gathered in their respective gold-tanks, and then passed in a regulated flow from the zinc-boxes into the sumps, the gold in the solution being precipitated on zinc shavings contained therein. Zinc shavings have the advantage of permitting the free passage of solution, and do not clog the screen on which the gold precipitate falls. They may be bought ready made, or can be made at the works, since, when freshly made, they are more efficient. To make them sheets of zinc are wound around a mandrel in a lathe, the edge of the sheet being then soldered down. A side-cutting tool is used to cut the shavings, which are about one twelve-hundredth of an inch in thickness, 0.03 in. wide, and several feet in length. All the compartments of a set of boxes, except the last, are loosely but uniformly filled with the shavings. The strong solution in the plant (Fig. 59 and 60) flows through the three sets of boxes at the rate of one ton per hour. The gold is precipitated in the first compartments, so that by the time the solution reaches the ninth compartment, no discoloration of the shavings is to be noticed, and the barren solution goes to the sump *L*. The deposit on the zinc has a brownish or grayish black hue. As it increases in the first compartment, the shavings become soft and stringy, the precipitate, and finally the zinc in small pieces (short zinc), settling to the bottom of the compartment. As the shavings in the first compartment settle down, it is usual to replenish them with zinc from the last compartments, which in turn are filled with fresh shavings. Gold is precipitated with greater difficulty from weak solutions, and accordingly it passes in series through both sets of boxes *K'*, *K'* to the sump *L*. From 95 to 99% of the gold should be pre-

FIG. 60. PLAN OF CYANIDE PLANT.

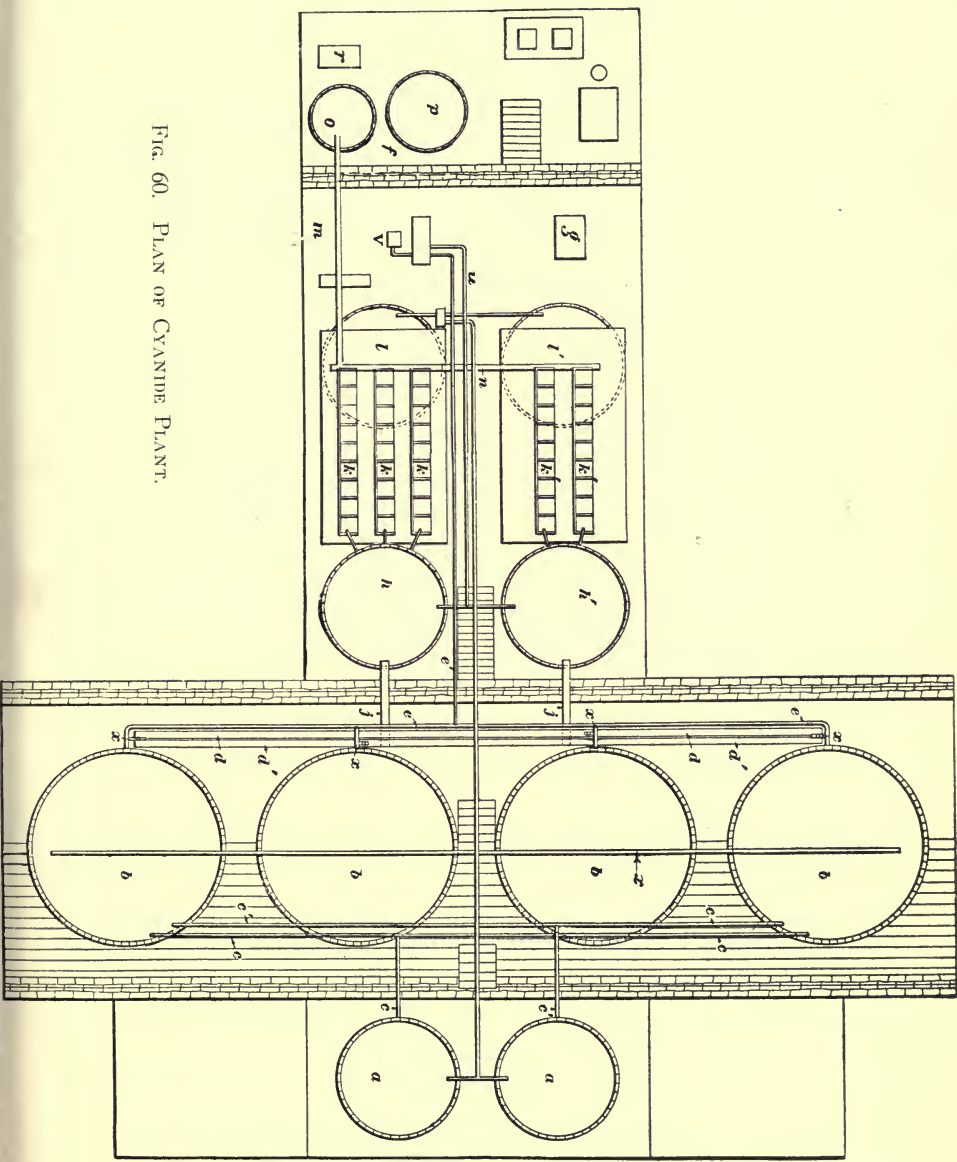

cipitated by the zinc, and since the barren solution is pumped back to the stock tanks and used again, this residual gold is not lost.

Cleaning up, acid treatment, and refining of the precipitate.—This may be done monthly or bi-monthly, according to the richness of the ore and the need of realizing values, and is conducted as follows: The flow of gold solution is stopped and to displace the solution water is run through the one set of boxes which is about to be cleaned up. Beginning in any compartment, and with the hands protected by rubber gloves, the contents are agitated by raising and lowering the zinc shavings for a few minutes, being careful to do it gently, so as to make as little 'short zinc' as possible. The water becomes black with the floating precipitate. The plug at the side *k*, Fig. 60, is now gradually withdrawn and the accumulated slime is carried down to the acid tank *o*. The plug is replaced and the compartment is then filled with water in which the zinc is again rinsed and rubbed, and the loosened precipitate again drawn off. About three such washes are enough to free the shavings from short zinc and from precipitate. Each compartment having been thus cleaned out, the launder is cleaned with a hose, zinc from the end compartments distributed to the head, and the rest of the box replenished with fresh shavings.

When all the boxes have been cleaned the precipitate is allowed to settle for a short time in the acid tank and the clear liquid is then siphoned off to the settling tank, see Fig. 60. The acid tank *o* is represented in detail.

This tank is provided with an agitator, which can be kept in motion by power transmitted from the line shaft, shown in the elevation of Fig. 59. It insures thorough agitation of the sludge or precipitate when undergoing the operation next to be described.

The acid treatment.—Upon the watery slime about 30 lb. of sulphuric acid is poured which, acting on the short zinc, produces a violent effervescence. As this subsides the slime is stirred by the agitator. When the action decreases, about 15 lb. of hot water with the same weight of acid is added with occasional stirring; and so on, until further addition of acid produces but

little effervescence. Then the mixture is allowed to stand for two hours, and tested with a little acid to see that decomposition is complete. The total time for this operation is from four to six hours.

The black-looking mixture is now diluted with hot water to within a few inches of the top of the tank and pumped through the filter-press. This washing with hot water is repeated several times, until the zinc sulphate has been quite removed. Finally the tank is hosed out, the washings being passed also to the filter-

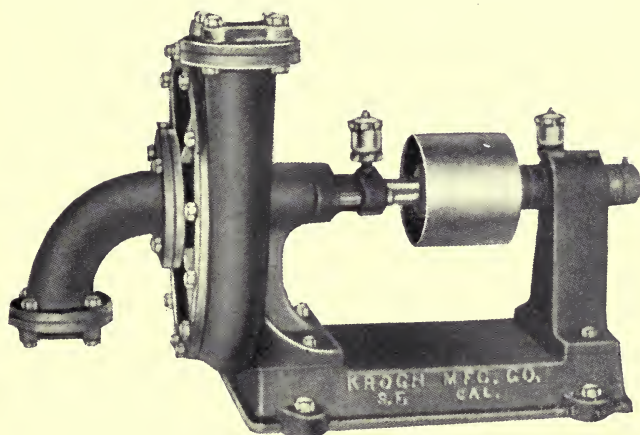

FIG. 61. CENTRIFUGAL PUMP.

press. In filtering, the filter cloths are covered with filter paper, so that the precipitate does not touch the cloth, this paper being afterward burned, and the ashes mixed with the precipitate. Fig. 62 represents the filter-press used. It consists of a series of cast-iron flat frames (each frame being recessed), between which the filter cloths are interposed. The liquid enters the press under pressure from a pump through the pipe shown at the head end at the centre, the filtrate escaping by bronze cocks into a launder. Leaning against the launder are to be seen two frames showing their grooved surfaces by which the filtrate escapes to the stop-cock. To the left is shown this grooving in detail, the dotted line on the section showing how the filter cloth

lies against the frame. The precipitate collects in, and fills, the recesses, and is freed from much of the remaining moisture by air introduced after filtration. The frames are now opened, and the precipitate falls or is scraped from the frames into a pan set below.

Drying and final treatment of the precipitate.—The product is transferred to a cast-iron pan, 44 by 24 in. by 4 in. deep. This pan is placed in a cast-iron muffle-furnace, where it is gradually dried, and finally heated to a just-visible red. The pan is then removed, allowed to cool, and its weighed contents mixed with half its weight of a flux composed of borax 4 parts, soda 2 parts, and sand 1 part. These proportions will vary slightly at different plants. From the pan the material is cautiously put into large plumbago crucibles, which are set in a wind furnace, and packed round with coke, the melting being done as in silver milling (Section 40, which see). The molten metal is poured into conical molds, and, on cooling, the slag is removed and the gold re-melted into an ingot.

The Taverner process.—In this process, the acid treatment which is said to occasion some loss of gold, is done away with, and the gold is obtained by the Taverner method as follows: The clean-up of the gold-slime is conducted as described above, the precipitate being collected in the acid tank, now called the clean-up tank. The precipitate is pumped to the filter-press, the short zinc which remains at the bottom of the tank being heaped to one side and allowed to drain. The filter-press slime is dried for a few minutes in an oven. Thus dried, it is passed through a 4-mesh sieve, weighed and mixed with fluxes in the following proportions. Slime 100 parts, slag 20 to 30 parts, sand 5 to 10 parts, litharge 60 parts. This is placed on the hearth of a cold reverberatory furnace (see Fig. 63).

Upon this is placed the short zinc from the clean-up tank, then a thin layer of 150 parts of litharge, and finally a thin layer of 20 parts of slag. A slow fire is started, and after two hours, increased to melt the charge, which takes about four hours longer. It is then well stirred, mixing in some sawdust to reduce the litharge; and the stirring continued until the slag shows clear on the

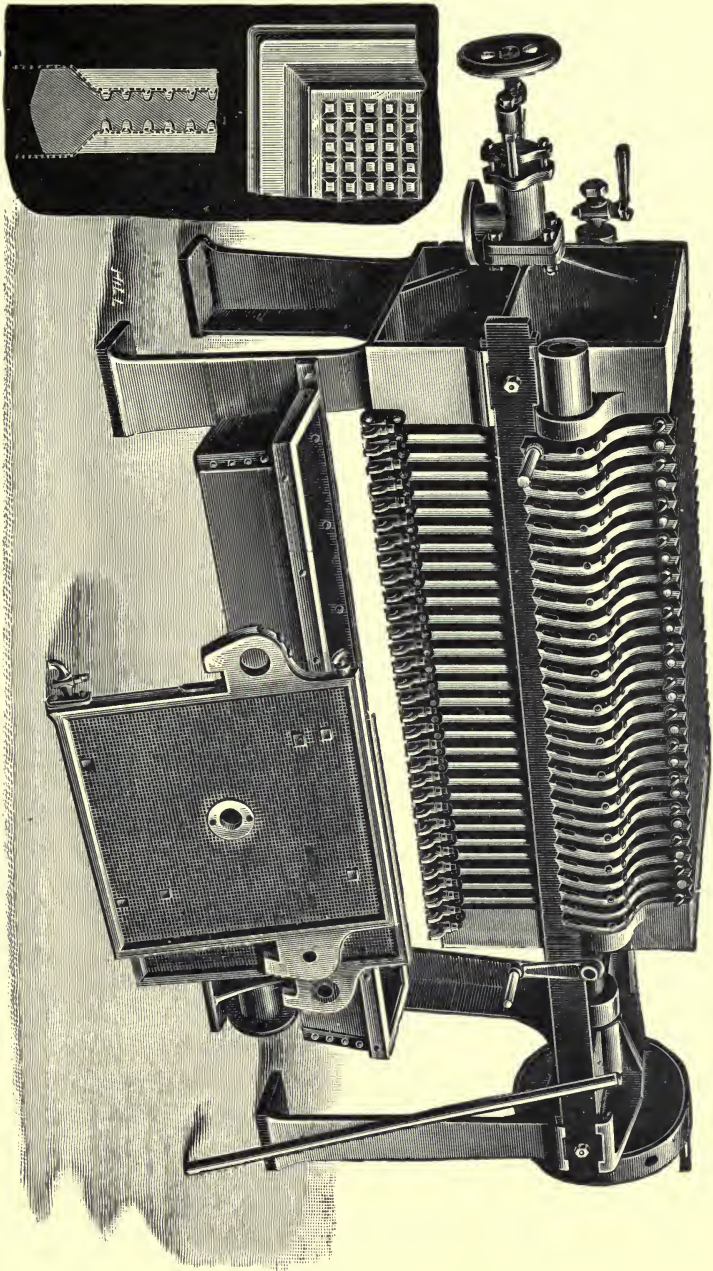

FIG. 62. FILTER PRESS.

rabble. The slag is skimmed off, and, after standing awhile in the pots, is poured out, the shells being removed for re-melting. The lead surface thus being cleaned, the zinc burns off and the rich lead, clean and soft, is ladled into bars. These bars are then treated in an English cupelling furnace, using a test made of bone ash (see Fig. 152), by which impurities such as copper are removed; and finally the bars are fined quite as described in Section 109. The litharge produced is used for the next charge to be treated.

The alleged advantages of the process are (1) saving in the cost of treatment (5.5 c. against 24 c. per oz. of fine gold); (2) absence of by-products; (3) increased recovery of the gold (10% more than by the acid process); (4) facility of treating foul slag.

28. SECOND METHOD OF CYANIDING. SOUTH AFRICA.

South African practice, brought today to a great perfection, has been a development. At first, ores containing \$9 values, were milled by wet-stamping and amalgamating, the tailing, still containing some \$3.50 in gold value, having been run to waste. With the introduction of the cyanide process the tailing has been cyanided, and further values cheaply extracted. Since the ore had previously been stamped, a considerable quantity of slime was necessarily made, which would, if allowed to remain in the ore, practically prevent leaching. As a first step in cyaniding, the slime had accordingly to be removed by means of separators and run to waste. The remaining sand was then treated as in the first method already described. Later, however a method was devised for treating slime.

The ore called 'bagnet' is a conglomerate, the gold occurring in the cementing material which unites the pebbles, and therefore fine crushing is not needed.

After coarse crushing the ore through Blake or Gates rock-breakers it goes to the stamps which weigh 1,050 to 1,200 lb., and which yield 4 to 6 tons ore per stamp crushed through a 30-mesh screen, with the use of about 8 tons of water per ton of ore. The pulp from the mill flows over amalgamated apron-plates, as in ordinary gold milling, and thence to a tailing-wheel and to

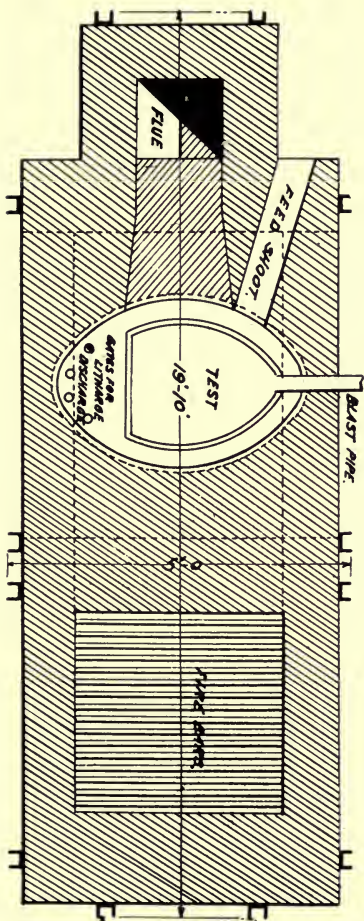
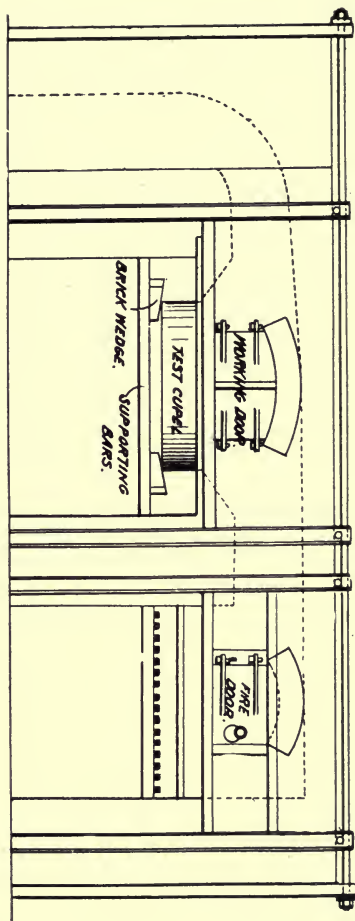

FIG. 63. TAVERNER CUPPELLING FURNACE.



a group of pointed box classifiers located above the leaching tanks. Some of these wheels are as large as 50 ft. in diameter, they are very efficient elevators, cheap to operate and are made necessary by the flat ground on which most of the plants are built.

The classified coarse sand and sulphide pass to collecting tanks, in two tiers, one superimposed above the other. They are made of steel, and are 30 ft. diam. The upper or collecting tank is usually made a little shallower than the lower. It is supported on steel I-beams which are in turn supported on steel or cast-iron columns extending through the lower tank and encased in a protecting cylinder. The sand and a remnant of the slime were formerly fed into the upper tank by means of a pipe distributor, but this is now done with a large hose which is moved about at intervals by hand. The upper tank is provided with circular discharge gates, through which it is emptied to the lower tank. In some instances the upper tank is merely used for collecting the sand; in others, the charge is given a very dilute solution of cyanide and the leaching is allowed to proceed until the moisture is displaced. In the lower tank the sand is leached with a stronger solution, and precipitation carried on by means of zinc shavings or electrolytically. In some plants where a perfect separation between sand and slime is effected the whole operation of settling and leaching is carried on in the same tank. The best example of this is seen at the cyanide works of the Homestake company.

The third product or slime is now, as already explained, treated by decantation. The slime is settled in large tanks, the water drawn off, very dilute cyanide solution added, and the agitation carried on by transferring the pulp from one tank to another by centrifugal pumps.

South African practice has recently felt the influence of West Australian methods, and is slowly adopting fine grinding of the coarser sand.

Filter-pressing is practised with success in Australia in the treatment of roasted ore. The Dehne press, resembling Fig. 62, is most commonly used. These are arranged in series, and receive the slime and fine sand after treatment by

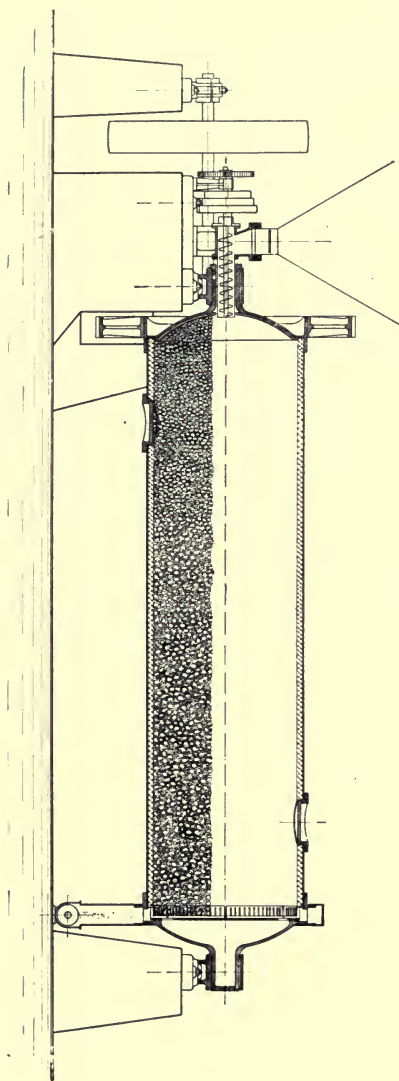

FIG. 64. DAVIDSON TUBE MILL.

cyanide solution. It was at first customary to treat the product in the press, and to fill the latter by means of compressed air. The dissolving of values is now done in agitating vats and the press filled direct by plunger pumps—so that now the press is merely used for separating the solution from the slime and for washing purposes.

In the treatment of slime produced in wet-crushing, we have to deal with a less permeable material. This slime is treated by presses in New Zealand; and at the Homestake mine, South Dakota, very large presses with a capacity of 25 tons each are being used to treat about 1,200 tons of slime per day. Extraction is carried on in the press itself, which is finally emptied by means of water under high pressure introduced through a special device into each chamber of the press. This does away with one important item in the cost of operating, namely the labor of opening and closing the press.

29. THIRD METHOD. MEXICO.

At El Oro, Mexico, the ore is crushed in stamps, and as much as can be economically reduced to a slime is treated by decantation. The fine crushing is done in tube-mills (Fig. 64), and the very fine sand leached.

At the Liberty Bell mill, Telluride, Colo., the product of 80 stamps is crushed in a cyanide solution, amalgamated, and then re-ground in tube-mills. The whole tube-mill product is then treated in Hendryx agitators (Fig. 65), after which it passes to the Moore filtering plant for filtration. The solutions are precipitated on zinc shavings.

Fig. 66 illustrates a slime-plant for the treatment of a wet-stamped ore which flows into the settling-vat *A*, as fast as it is produced.

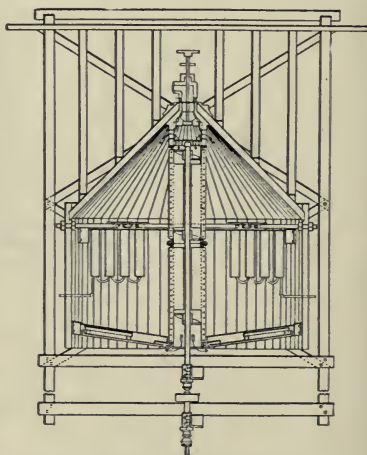

FIG. 65. HENDRYX AGITATOR.

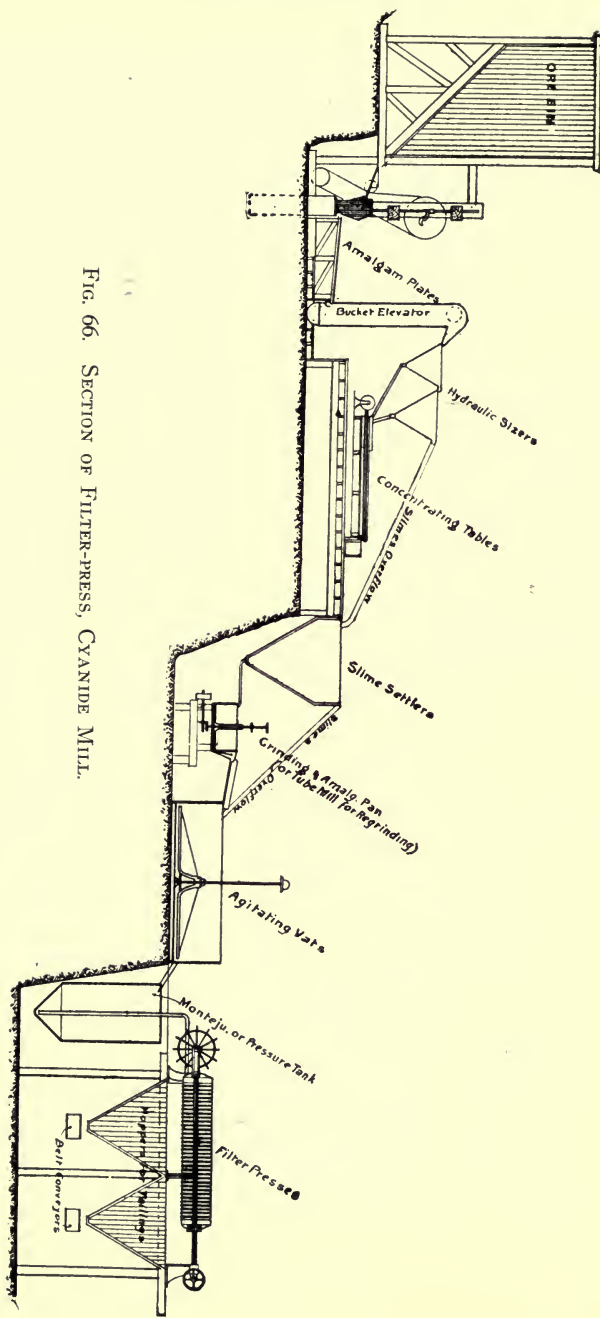

FIG. 66. SECTION OF FILTER-PRESS, CYANIDE MILL.

When the vat is full, the flow goes to another similar vat while the contents of the first vat are allowed to settle, milk-of-lime being added to promote settling. The supernatant water is decanted as fast as it clears while the thickened slime is withdrawn at the bottom into the agitating vat *B*. Cyanide solution of 0.3% is now run in from the stock vat just beyond the filter-press *C*, and the whole is circulated for a period of 10 hours by aid of a centrifugal pump *D*, which withdraws it from the bottom of *B* returning it by a pipe to the top of the vat. Besides this air is pumped through



FIG. 67. PERSPECTIVE VIEW OF WOODEN LEACHING VAT.

the solution by means of a pipe leading to the apex of the conical bottom. Finally the pulp is pumped to the filter-press *C*, the filtrate going to the gold solution vat on the right. From this it flows through the zinc boxes *E E*, and then to the sump situated at the lowest level. The sump solution is returned to the stock vat as it accumulates.

The Leaching Vat.—This may be made either of wood or of steel. In hot countries the steel vat is to be preferred; but in cold countries where it is necessary to house the plant, the wood vat gives satisfaction. The latter is cheaper in first cost and easier to set up; the steel vat, on the other hand, is less liable to leakage, and is free from alleged losses due to absorption. On the other hand, the steel vat costs more to maintain, as it requires a periodical coat of protective paint to preserve the steel from the action of the solution. In western America the use of wooden

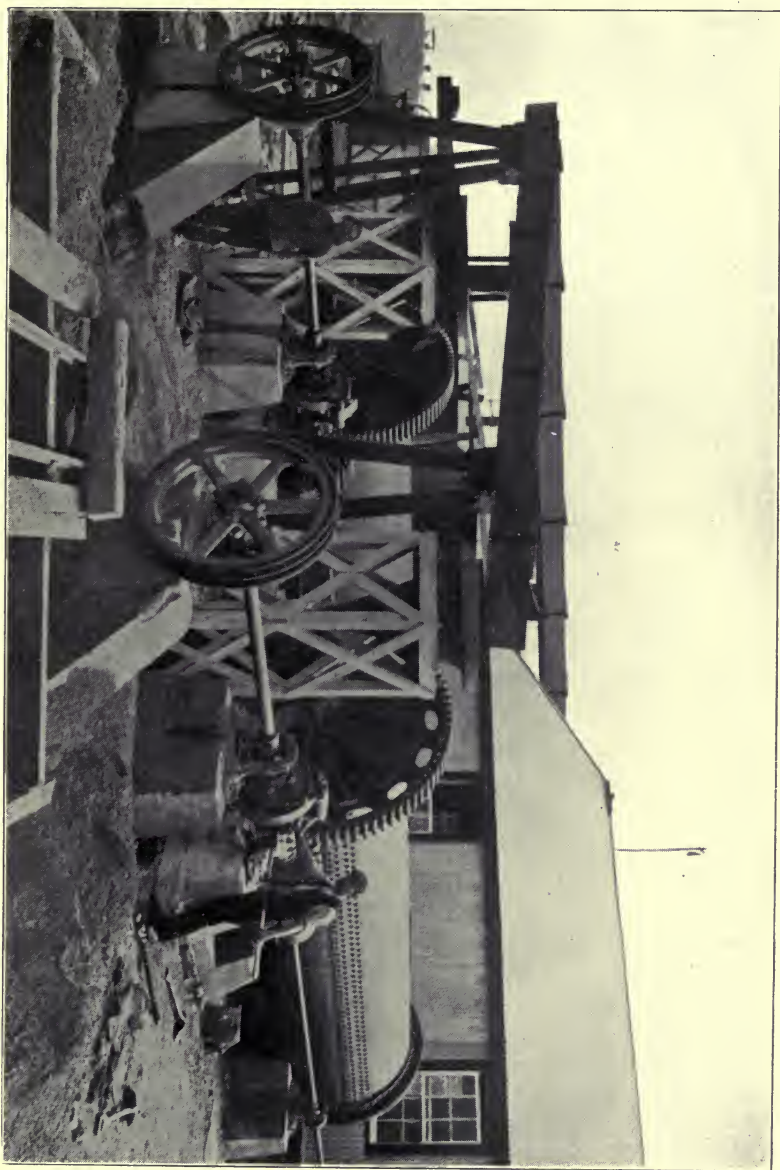

FIG. 68. GATES TUBE MILL.

vats predominates, although steel vats are used; the latter are favored in South Africa and West Australia. Each possesses its advocates; but in general, the steel vat is to be preferred.

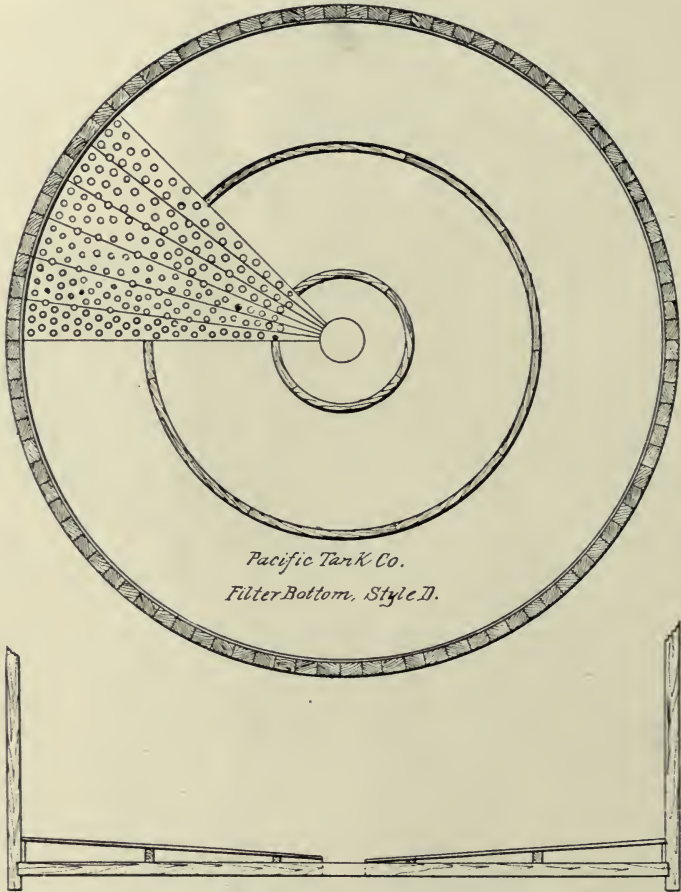

FIG. 69. FILTER BOTTOM OF WOODEN LEACHING VAT.

Fig. 67 is a perspective view of a wooden vat, where will be seen the hinged bottom discharge opening through which the tailing may be shoveled or sluiced.

Fig. 69 gives in plan and in section the construction of one form of filter-bottom. It consists of a wooden ring 2 in. high by 2.5

in. wide nailed to the bottom of the tank 1 in. from the side. Cleats 1 by 2 in. are nailed flat upon the bottom of the tank one foot apart. On these are nailed 1 by 4 in. strips one inch apart. Upon this false bottom is laid cocoa matting, and over this 8-oz. canvas filter-cloth cut 12 in. larger in diameter than the inside of the tank, the edges of the cloth being held down by a rope

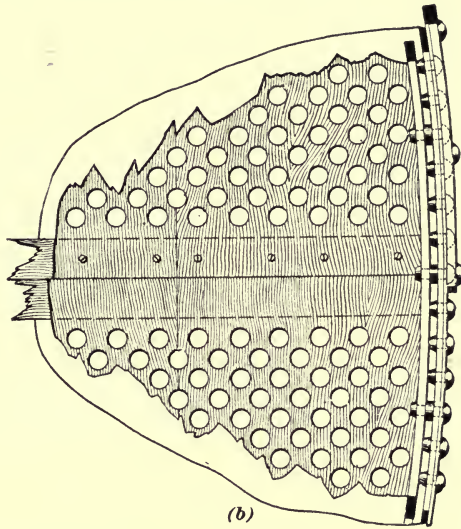

FIG. 70. PLAN OF STEEL LEACHING VAT.

driven with it into the 1-in. space between the wooden ring and the staves. Sometimes this ring is omitted, the joint being made by nailing a strip around the tank over the edge of the canvas, as shown at the section at the right of Fig. 69. The manner of securing the edge of the cloth is shown more in detail in Fig. 70.

Fig. 70 and 71 represent, in plan and in section respectively, the construction of a steel vat, having a perforated board bottom, convenient in case one intends to remove the tank for use in another place. A ring of flat iron, 0.5 by 2.5 in., is riveted to the side of the tank, leaving a space of 0.75 in. The cleats upon the bottom are 2 by 1.5 in. laid on edge, while the perforated boards are bored with 0.75 in. holes, and are screwed to the cleats. As in the case of wooden vats, cocoa matting is laid upon this false

bottom, and that again covered with a filter cloth of 8 to 10 oz. canvas duck, whose edges are calked with a rope into the 0.75 in. space between the sides and the ring, as shown at *g* in the sectional view. Leaching vats are made of varying dimensions, from 16 to 50 feet in diameter and 4 to 9 ft. deep, the shallower ones for the more slimy ores. The tank is usually made large enough to hold one day's supply of ore, to ensure uniformity of work in the mill. The rate of percolation is also very much increased by the use of the vacuum pump. The tailing is commonly removed from the tanks either by shoveling them out by a side or

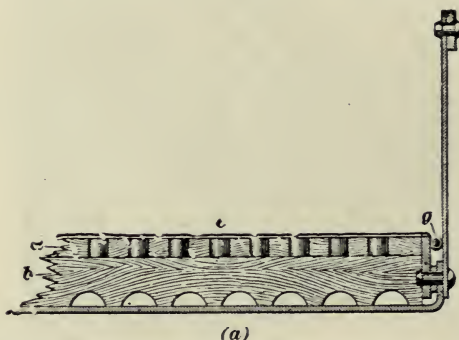

FIG. 71. SECTION OF STEEL LEACHING VAT.

by a bottom opening; or where water is abundant by hosing the residues into a sluice or launder marked *S* in Fig. 59 by which they are carried to the dump.

Fig. 72 represents a side- or bottom-discharge door which is bolted to the outside of the tank. The joint of the door is made tight with a rubber gasket. Fig. 73 represents a central bottom-discharge valve (Fig. 73) operated from the charging-platform, very convenient when the ore is to be sluiced out. It is bolted securely to the bottom and is self-sustaining. The opening is 10 in. in diameter.

The zinc-boxes.—Fig. 74 gives a plan, an elevation, and a cross-section of a set of wooden zinc-boxes, and Fig. 75 is a perspective view of three sets of them arranged as at *K, K, K*, Fig. 60. As there shown, each set of boxes contains nine compartments, 12 by 15 by 24 in. in size. These compartments have a per-

forated bottom of sheet-iron or of wire-cloth sustaining the zinc shavings with which they are filled. The partitions are set alternately down and up to compel an upward flow of the gold-bearing solution, so as to bring it intimately in contact with the zinc upon which it is to be precipitated. In the elevation *a*, the entrance of the solution from the gold-solution tanks into the first box and its discharge to the sump are clearly shown. The boxes are set at a grade of 0.25 in. per foot; *h* is a launder into which the gold precipitate formed in the boxes can be at the time

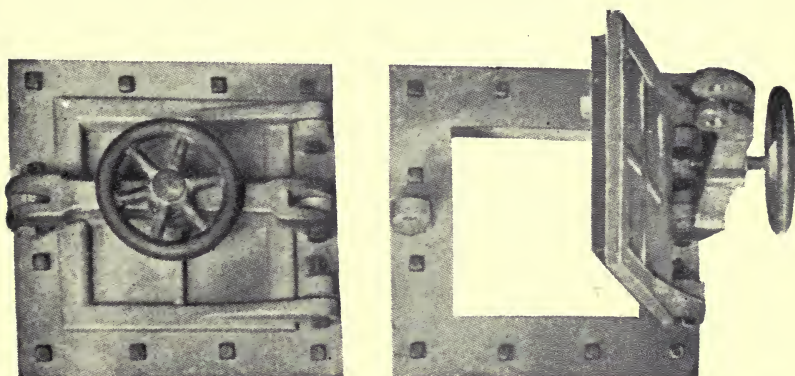

FIG. 72. SIDE DISCHARGE DOOR.

of clean-up, conveyed to the launder *m* Fig. 60, and thence to the acid tank *O*. Both tank and launder are covered with lids for the protection of the precious-metal contents.

For small plants sheet-iron individual zinc-boxes painted with asphalt paint are much used (see Fig. 79). In cleaning up the boxes can be removed one at a time and a box freshly packed with zinc substituted.

Fig. 61 represents the centrifugal pump used to return the barren solutions from the sumps to their respective stock-tanks. It is operated by a belt from a counter-shaft, shown in the elevation at Fig. 59.

Roasting as a Preliminary to Cyaniding.—We have already referred to the fact that gold may occur in pyrite as a film on the faces of the crystalline particles. Such ore is susceptible to direct cyaniding when the ore is so crushed that these films are exposed

to the action of the solution. If, however, such ores are not cyanided when freshly mined, but are allowed to lie, they are rendered acid by oxidizing atmospheric influences, and need careful neutralization by means of caustic soda or lime. If the gold occurs, finely permeating the pyrite crystals, they must be minutely ground before it can be entirely attacked by the cyanide, and may then be treated by agitation. Again, where the gold is combined with tellurium to form calaverite or sylvanite, it is insoluble in cyanide unless roasted. Roasting, moreover, renders an ore porous in texture so that it is more easily permeated by a solution. We thus see that sulpho-tellurides and pyrite ores in which the gold exists in the substance of the crystals are both eminently suited to roasting as a preliminary to cyaniding. The extraction and rapidity of leaching is so improved that for many ores the expense of roasting is quite justified.



FIG. 73.
BOTTOM DISCHARGE
VALVE.

30. FOURTH METHOD, SOUTH DAKOTA.

The ores of this country may be divided into the unoxidized, or blue ores, which yield but little to amalgamation (20 to 30%), and into the dense oxidized or red surface ores, from which some 80% may thus be extracted. The gold occurs evenly distributed and in a finely divided condition, such that it may be recovered by cyaniding.

The ore is coarsely crushed by rock-breaker to 1.5 in. size and automatically fed to a battery of 1000-lb. stamps where it is wet-crushed to 20-mesh at the rate of 6 tons per stamp daily. To the solution is added 1 to 1.5 lb. sodium hydrate to neutralize the acidity of the ore. In crushing 4 to 6 lb. quicklime is added at the battery per ton of ore to assist in the precipitation of the slime.

The battery discharge is elevated by sand pumps to a system of cone classifiers (see Fig. 76). Here it is delivered to a distributing-box 6 by 3 by 3 ft. in size, which serves to give a

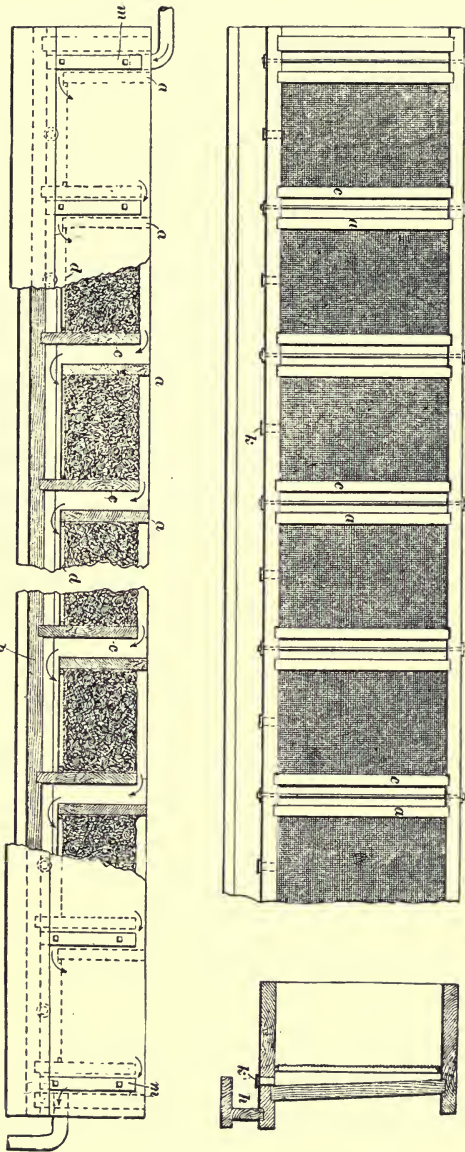

FIG. 74. SECTIONS OF ZINC BOXES.

regular supply. The flow from this box is divided evenly between two cone settlers which, however, have no upward flow of water, so that, while the sands settle out, they still contain some slime. The spigot-discharge of the two cones is received into a distribution launder which delivers it to a hydraulic cone classifier, having the usual supply not of water, but of battery solution already mentioned. Thus the sands are separated, containing



FIG. 75. PERSPECTIVE VIEW OF ZINC BOXES.

no more than 1 to 5% of slime, while the slime, amounting to 30%, and much of the solution, escape together over the top.

Treatment of the sand.—The sand-tanks are filled by means of the Butters & Mein distributor. In this case, however, the distributor can be moved by an overhead trolley from tank to tank as required (see Fig. 77). The sands enter the empty tank, evenly filling it, the accompanying solution draining away through overflow openings and through the filter-bottom, so that there is no overflow over the top edge of the tank. It takes two days or more to fill a tank. Additional battery solution is now run in, and this is followed by barren solution, being that which has been passed through the zinc-boxes. This is followed by a small amount of wash-water of 0.1 to 0.2 ton per ton of sand. The leaching is continuous and it takes at least 8 days to leach a single charge. There is no strong solution properly so called. The extraction on the sands amounts to about 75%.

Treatment of the slimes.—The overflow from the cones goes by launder to one of the slime-tanks, 14 ft. diam. by 10 ft. deep,

shown in plan an elevation in Fig. 78, and goes down behind a wooden partition extending half way to the bottom of the tank. Before charging, the tank is filled with barren solution, the slime

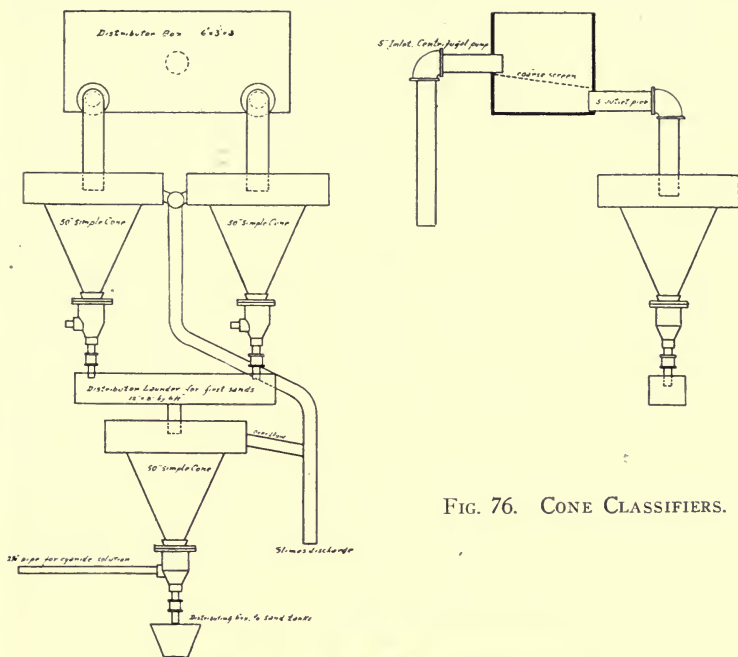

FIG. 76. CONE CLASSIFIERS.

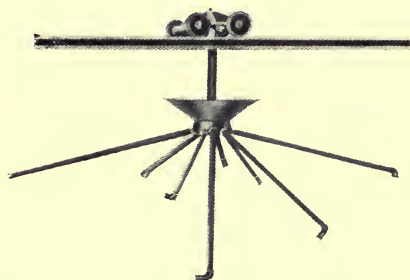
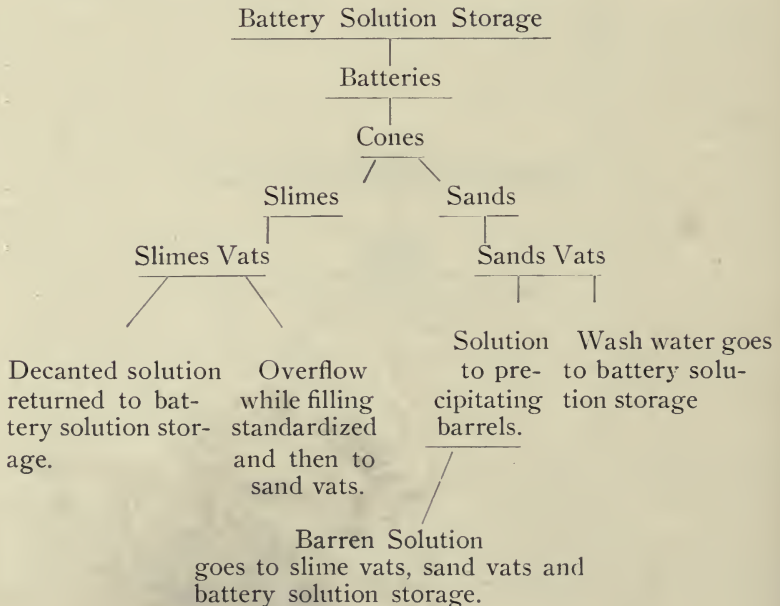
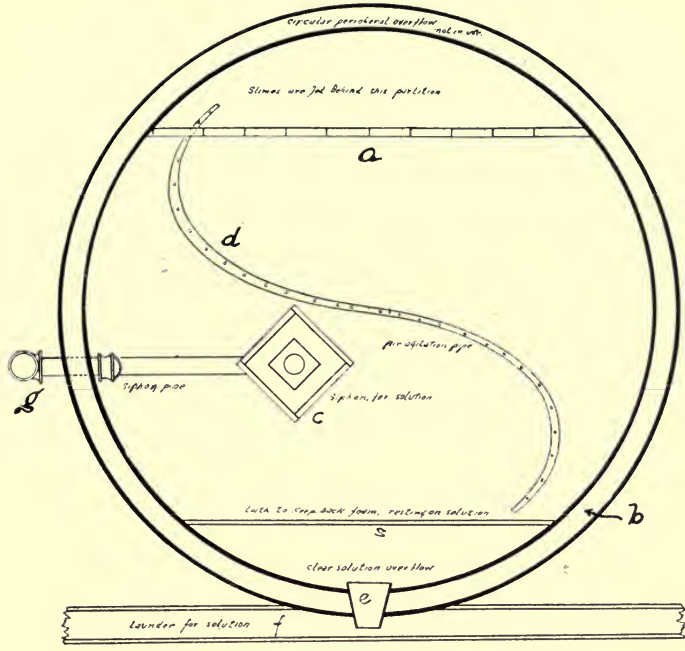

FIG. 77. BUTTERS & MEIN DISTRIBUTOR.

is run in, the solids settling in the tank, while the overflow goes away by the spout *e* and any foam is held back by a strip of wood *s*. It will be noticed that the circular launder, surrounding the tank, is not now used. The quick settling-out of slime is due to the addition of the lime (4 to 6 lb. per ton of ore) at the bat-

tery. The overflowing solution is strengthened by the addition of some cyanide and sent on, as battery solution, to the sand treatment. The flow of entering slime is kept up until the solution, escaping at the spout *e*, begins to look turbid, by which time the tank has been filled with the settled material to the depth of 4 feet, when, of course, the entering flow is transferred to another tank, and the contents of the just-filled tank allowed to settle for about 10 hours. As the slime settles the supernatant clear liquid is drawn off by the decanting device *c*. This is gradually lowered in the tank until finally the solution is decanted to within an inch of the settled slime. The decanting device is then raised and a wash of barren solution run in, while, at the same time, compressed air is driven through the solution, rising through it by the perforated pipe *d*. This is allowed to settle and the solution decanted as before, the operation being repeated 4 to 6 times with barren solution, and once with water. Each wash consists of 40 tons. After this the slime, containing 50% moisture, is discharged through a bottom gate, indicated at *h*. The course of the solution is shown in the accompanying diagram. It will be seen





Plan

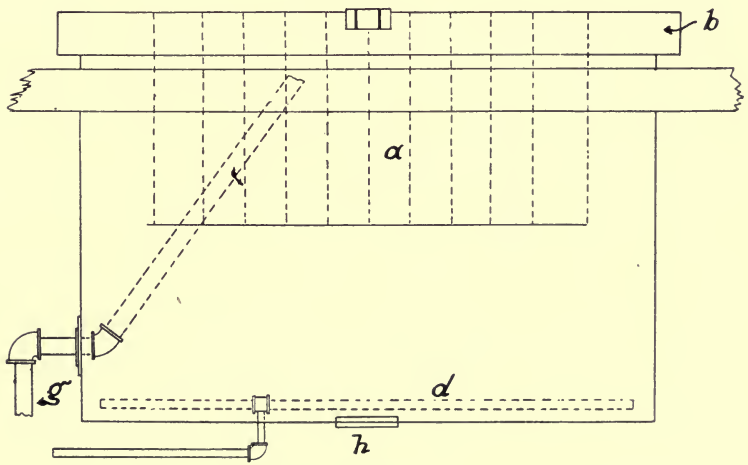

Elevation

SCALE 1:50

FIG. 78. SLIMES TANK.

from this diagram, that there is no escape of any solution, except that which gets away in the sand and slime as they are discharged from the tanks. None of the solutions from the slime treatment go to the zinc-boxes direct, being too low in gold, but pick up an additional load of the latter when they enter the sand-tanks, either directly or by way of the battery storage tank.

Precipitation of the gold.—In place of the ordinary zinc-boxes, individual barrels or tanks may be used, of which an illustration is given.

The gold precipitate is subjected to the acid treatment, already described under the first method, and yields, in South Dakota practice, a bullion of 450 to 600 fine. The total extraction, both from sand and slime, will vary from 68 to 75%, the potassium cyanide consumed will amount to 1.33 lb. and the zinc used up to 0.58 lb. per ton of ore treated.

The following is the cost of treatment per ton of ore:

Labor	\$0.452
Superintendence	0.090
Cyanide	0.211
Zinc	0.033
Lime	0.012
Power	0.226
Shoes, dies, etc.	0.095
Repairs	0.027
Refining	0.030
Assay office	0.040
General expense	0.050
	<hr/>
	\$1.266

31. FIFTH METHOD, WEST AUSTRALIA.

Fig. 66 is a cross-section of a complete process of ore treatment where the ore is re-ground and filter-pressed. The ore, while it may contain some coarse gold, has the larger part of it finely divided, so that, for high extraction, it needs extremely fine grinding before the microscopic particles are accessible to the cyanide solution. The ore, from the storage bin at the left, is

automatically fed to the stamp battery, where it is crushed in a cyanide solution of 0.1%. The coarse gold, if any, is taken out on the amalgamated apron-plates, whilst the pulp is raised by the elevator to two classifying-cones, which remove the sand, in two grades, the coarse going to one table, the fine to another. Any concentrate is removed and may be considered to have sufficient value for shipping away to the smelter. The tailing joins the overflow from the cones, and passes to the slime settler, a large cone classifier, which removes the water and returns it to the

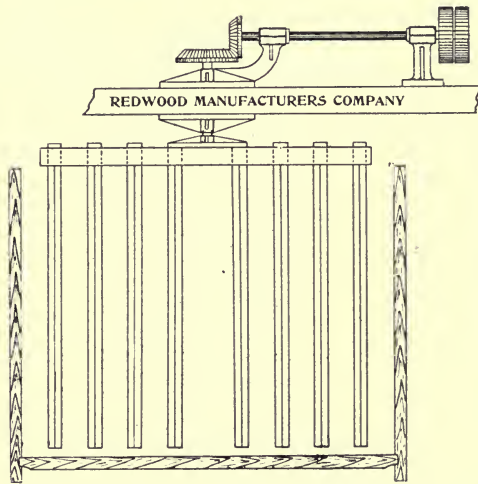

FIG. 79. INDIVIDUAL ZINC BOXES FOR GOLD PRECIPITATION.

stamps, while the settled sand and slime are reground, as shown in the figures, in amalgamating pans without the use of mercury. (In place of the pan a favorite machine for regrinding is shown at Fig. 61. It consists of a steel riveted cylinder lined with flint stone, making 22 to 27 rev. per min., 5 ft. diam. by 20 ft. long and nearly one-half filled with flint pebbles the size of one's fist. The sands are fed in at one end by a hopper and are ground by the pebbles rolling on them as the barrel revolves. The ground material escapes at the other end.) Referring again to the diagram we find the ground material from the pan entering the agitating vat, where it receives a farther charge of cyanide solution

of 0.22%, is agitated for several hours, and is finally run off to a 'montejus' or pressure tank 5 ft. diam. by 12 ft. high. A pipe from the bottom of the tank leads to the filter-press, and, through this is driven the finely ground pulp by the aid of compressed air under a pressure of 40 to 80 lb. per sq. in. The filtrate from the press passes as usual to the zinc-boxes. A charge of 5 tons of dried slime can be treated at a time, taking upward of two hours. When ready, the press is opened and its contents drop into the tailing-hoppers, which deliver to conveying belts going to the dump.

32. THE BROMO-CYANOGEN PROCESS.

This method, also called the Diehl process, is practised upon the sulpho-telluride ores of Western Australia. The ore carries iron and calcium carbonates, which, after roasting, have cement-like properties which dispose it to cake or set together when subjected to the action of cyanide solution in the tanks. Since the Diehl process does not involve roasting of the ore, it has come in as a successful method of treatment.

It has been found that to get a good extraction from the ores they must be finely ground, or, as it may be termed, slimed. At the same time we must distinguish such a product, which contains many hard crystalline particles of quartz, from a real slime made up of colloid substances such as clay, and in which no hard substance exists. Moreover, the gold exists only in part in the metallic state, the rest being present as telluride and in the sulphides. Owing to the brittleness of the telluride, the finer the slime the richer it is in gold.

The ore, containing 2 to 3 oz. Au per ton, is therefore crushed through a stamp battery, and passes on to tube-mills (see Fig. 68) where it is crushed so finely that it will nearly all pass a 200-mesh screen. The product from the tube-mills, containing 5% of sandy particles, goes to a system of classifiers, where these are separated and returned for re-crushing. The overflow of the classifiers goes again to spitzkasten from the bottom of which is drawn off the thickened pulp containing 40 to 50% of solid matter which is discharged to the agitator. This is a tank 25 ft. diam. by 8 ft. high, capable of holding 125 tons of

pulp, and in which the pulp is agitated by stirrers. When the agitator has been filled, cyanide of potassium is added until the strength of the solution is brought up to 0.22% per ton of ore, and the whole is stirred for 1.5 hours. This is followed by an addition of bromo-cyanogen to increase its strength by 0.055% of the salt per ton of dry slime. The stirring is kept up and at 22 hours from the start 1 to 4 lb. of dry quicklime per pound of dry slime is added. The charge is now run to a montejus and then

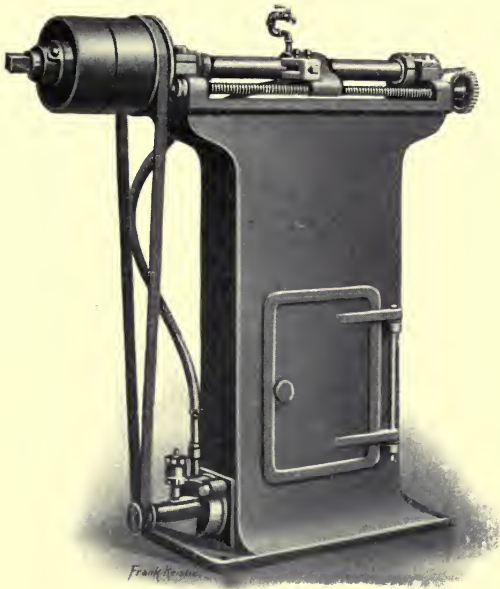

FIG. 80. ZINC LATHE.

driven to the filter-presses by compressed air. The press-cakes are washed first with 2 tons of a weak solution, then with the same weight of water. They are then blown nearly dry by sending compressed air at 80 lb. pressure through them for 15 minutes. The press, being opened, the cakes are discharged into cars standing below. The clear filtrate goes to the zinc-boxes; the weak washes return to the weak solution tanks to be used over again. As compared with extraction with plain cyanide

which will vary from 41 to 62%, there is an increase to 77 to 97% or of about 35%.

On account of the high value of the ore, filter-pressing is essential. These presses have a capacity of 5 tons each, and consist of 50 frames, each 40 in. square, the cake of slime being 2.5 to 3 in. thick. This gives a total area of 22 sq. ft. per frame, or a total of 1,100 ft. per press.

33. PRACTICE UPON CRIPPLE CREEK ORES.

The phonolite ores treated may be divided into two: First, the altered surface ores with no tellurium and containing free gold, and, second, the deeper-lying ores containing the gold combined with tellurium as sylvanite and calaverite, together with some nearly barren pyrite. The surface ores are treated raw, the telluride ores receive an oxidizing roast before leaching.

Either kind is coarsely crushed, dried and then finely crushed, as described in detail in the chapter on crushing. Surface ores are crushed to 40-mesh while the tellurides are crushed to 30-mesh, since they are to be subsequently roasted whereby the ore is made more porous and accessible to the solution. The roasting of the pulverized ore is done in one of the mechanical roasters, the Argall, the Ropp straight-line, the Edwards or the Holthoff-Wethey. The latter furnace completes the cooling of the ore upon its lower hearth, while in the case of the other furnaces, a cooling apparatus must be used in addition. This cooling apparatus, in some cases, consists of a trough, water-cooled by pipes below, in which the ore, mixed with 10 lb. lime per ton, is moved along by means of flights or scrapers, which deliver it at the end of the trough to a storage bin. At the discharge end the ore may be sprinkled, just before it leaves the trough, with strong cyanide solution. This at once cools it, prevents its dusting, and starts dissolution.

Connected with the drying and the roasting furnaces are two large fans discharging 10,000 cu. ft. of air per minute to an extensive system of flues terminated by a bag house. The dust, thus recovered, is of higher grade than the original ore. It may be bricked and smelted.

The leaching tanks are of steel 50 ft. diam. by 6 ft. deep, having a false bottom, constructed much as is shown in Fig. 70. The bottom is made of 1 in. stuff, bored with 0.75 in. holes, set radially and sloping 5° to the centre discharge or else set flat.

The bottom is covered with cocoa-matting, and this again with 8 or 10 oz. duck or cotton canvas. The empty tank is filled 6 in. above the false bottom with strong solution of 0.7%. Ore filling from 2-wheeled buggies is then begun and solution is run in from below so that ore and solution rise at the same time in the tank, the whole work of charging taking 50 hours. The first solution is allowed to stand on the ore 24 hours, then more is added and drawn off. This is repeated until the gold in the ore is reduced to 33% of its original gold contents, taking 5 days. The weak solution, of 25% KCN, is then used in the same way for 3 days, after which the charge is treated to several water-washes, drained and sluiced out through a bottom-discharge valve, Fig. 73, or is shovelled out at side-discharge doors, Fig. 72, all this needing two days more. The total time is consequently 12.5 days. The original ore, as charged to the vat, contained 0.90 oz. Au and 0.5 oz. Ag per ton, while the tailing retained 0.06 oz. Au and 0.2 oz. Ag. The extraction was accordingly 93.33% of the gold and 60% of the silver, while the loss of cyanide was 1.75 lb. cyanide per ton of ore treated. The screen analysis from the above charge showed

Coarser than 40-mesh	19%	containing	0.07 Au
40 to 200	40%	“	0.06 “
100 to 200	16%	“	0.06 “
Less than 200	25%	“	0.07 “

This shows that extraction was very even, being as complete on the coarser size as on the slime.

Each kind of solution passes to its own gold tank, and from thence it is slowly run through the zinc-boxes to the sumps, the solution being then strengthened for re-use. The zinc consumed amounts to 0.9 lb. per ton of ore treated.

The cost of treatment of Cripple Creek ore may be taken as \$2 to \$2.50 per ton, roasting included, when performed on the large scale above indicated.

34. CYANIDING SULPHO-TELLURIDE ORES.

Cripple Creek ores of this character need a roast before they are cyanided. For economic working a mill treating such ores should have a capacity of at least 400 tons daily. At the Golden Cycle mill, Colorado City, Colo., the practice is as follows:

The ore is coarsely crushed to 2-inch cubes in rock-breakers, and it then passes through heavy crushing-rolls which reduce it to about one inch size; from the rolls the ore is conveyed to automatic storage bins, with capacity of 8,000 tons. The ore is removed from the storage bins on automatic belt-conveyors, which deliver it to the final crushing rolls, where, without preliminary drying, the ore is crushed to quarter-inch cubes or finer. The coarsely crushed ore is next delivered to the roasters, it having been found that on ore of this size roasting can still be thoroughly done. The telluride of gold, where segregated, roasts into shot or particles of gold, too large generally for solution with potassium cyanide, hence, the roasted ore, after cooling, is ground in cyanide solution and amalgamated in Chilean mills (see Fig. 81).

The pulp passes over amalgamated plates and the fine grinding to 60-mesh is completed in pans. By this method all the amalgamable gold is removed and the sands reduced to a product of low tenor; the pulp is next lifted to classifying-cones, where the slime is separated from the sand in the usual manner; the latter being conveyed directly to the leaching vats, while the separated slime, after four hours' agitation in a conical-bottom tank, is drawn off to filter-presses for final treatment.

35. ACTION OF COPPER IN CYANIDING.

Copper in the ore is generally understood to be a serious drawback to successful cyaniding, since it passes into the solution, and consumes cyanide. It is customary, in the presence of a little copper, to strengthen the solution as it enters the zinc-boxes, thus preventing its precipitation to some extent. Copper always goes into solution, using up potassium cyanide in so doing, and thus increasing the cost for that chemical.

The Hunt ammonia-cyanide process.—At Dale, San Bernardino County, Cal., a copper-bearing gold ore was treated as fol-

lows: In crushing, 8 lb. of quick-lime was added per ton of ore, and in the vats the ore was treated with a 0.15% solution of potassium cyanide to which had been added 6 lb. ammonium chloride per ton of solution. This was allowed to remain for 12 hours in contact with the ore, after which the latter was drained and washed, the operation requiring 6 days. The filtrate was run

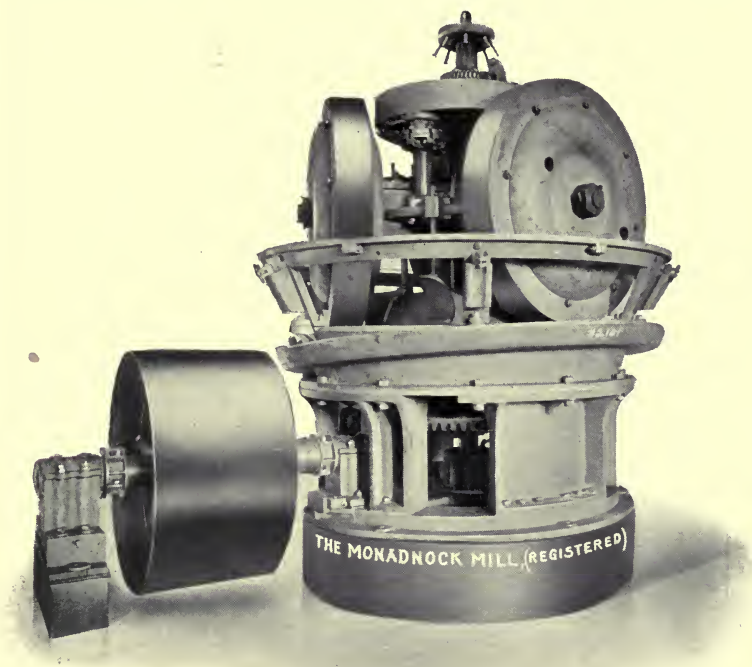

FIG. 81. MONADNOCK (CHILEAN) MILL.

through the zinc-boxes as usual. When using the ordinary cyanide solution, there was a loss of 8 lb. cyanide per ton of ore treated, while by the above method, this was reduced to 1 lb. per ton. The method has also been successfully applied to the treatment of copper-bearing mill-tailing, long exposed to atmospheric influences.

36. PRECIPITATION WITH ZINC DUST.

Zinc dust is a product of zinc smelting, containing 90% metallic zinc. Its use as a precipitant has been conspicuously successful at the Homestake cyanide mills in South Dakota. The gold-bearing solution is alternately treated with the dust in two large tanks. When a tank is full, an emulsion of zinc dust is sprinkled on the surface of the solution in the proportion of about $\frac{1}{4}$ lb. per ton of solution. This is forced on the tank under air pressure from a small, conical-shaped vessel, in which the emulsion is prepared. A violent jet of air entering through perforated pipes is then introduced into the tank, and the agitation kept up for fifteen minutes, after which the whole content of the tank is elevated by a large pump to the filter-press, which it enters under about 10 lb. pressure. The excess of zinc dust thus accumulates in the press until the clean-up.

37. EXTRACTION OF GOLD BY SMELTING.

Gold may be recovered from its ore by the processes of lead-silver or of copper-matte smelting, practically all of the gold being saved. This would be the best way of obtaining gold from its ores were it not for the expense of smelting, especially of the silicious ores. Thus, the charge for smelting a silicious ore by a silver-lead smelting works would be \$10 per ton, while it is often milled for less than \$1 per ton, with, however, a lower extraction or recovery of the gold. Then again, the ore if smelted must be sent to the nearest smelting works, which involves an additional expense for freight.

PART IV. SILVER

PART IV. SILVER.

38. SILVER ORES.

Silver sometimes occurs native in flakes or plates, as wire-silver, or as adherent to native copper.

The principal ores of silver are as follows:

Cerargarite (horn silver, silver chloride), AgCl , contains when pure 75.3% Ag. It is widely distributed and in mines is found in the upper oxidized zones. It is probable that much of the so-called chloride ore is in reality a chloro-bromide (embolite). The ore is readily amalgamated or free-milling.

Argentite, Ag_2S , contains 87.1% Ag. This is one of the most common of silver ores, and is capable of being acted on by chemicals. In this respect it is more docile than the sulphides associated with arsenic and antimony, namely:

Stephanite, $5 \text{Ag}_2\text{S}, \text{Sb}_2 \text{S}_3$ containing 68.5% Ag,

Pyrargarite, $3 \text{Ag}_2 \text{S}, \text{Sb}_2 \text{S}_3$ containing 59.8% Ag., and

Proustite $3 \text{Ag}_2\text{S} \text{As}_2\text{S}_3$ containing 65.4% Ag.

Finally we have silver sulphides, which, besides the above-named impurities, have copper also. They are polybasite $9 (\text{Ag}_2 \text{Cu}) \text{S} (\text{SbAs})_2 \text{S}_3$ with 64 to 72% Ag, and fahlerz (gray-copper ore) the most complicated of all, $4 \text{Cu} \text{Fe} \text{Ag}_2 (\text{Hg} \text{Zn}) \text{S}, (\text{SbAs}) \text{S}_3$, in which the silver varies from 0.06 up to 31%, the silver existing in large quantity in the more arsenical and less in the more antimonial varieties.

Besides the above widely distributed ores, there are others less common, but sometimes important in certain localities. They are dyscrasite $\text{Ag}_3 \text{Sb}$, stromyerite $\text{Ag}_2 \text{S}, \text{Cu}_2 \text{S}$, and freieslebenite $5(\text{PbAg}_2)\text{S}$.

A number of rare minerals containing silver could also be enumerated, but, for the purpose of the metallurgist, the ones named above are the more important ones. As they come to him they contain an overwhelming proportion of gangue, so that

many of them are treated containing no more than 0.1 to 0.2% of silver. Thus we may have, as at the Comstock mines, the silver in native form and as sulphides associated with pyrite, galena, blende and chalcopyrite, and having a gangue of quartz, calcite, dolomite and the oxides of iron and manganese. At the Ontario mine, Park City, Utah, the silver is found in argentite and gray-copper ore, associated with the heavy minerals, blende and galena, and having a gangue of quartz and clay. These heavy minerals also carry some of the silver, which accompanies them, into the concentrate wherever concentration is practised.

39. SILVER MILLING AND AMALGAMATION.

The ores of silver which can be successfully subjected to free milling are such as contain the silver (and gold) in a form capable of being acted upon by mercury, assisted by agitation, heat and certain chemicals.

The operation, after stamping, is performed in amalgamating pans, each being worked for several hours, and the reactions often being slow. The forms of silver are horn-silver (chloride), free silver (native) and certain silver sulphides, notably argentite. Base minerals, such as pyrite, calcopyrite, galena, blende, and especially arsenic and antimony, interfere with the success of the process in two ways.

1. Directly by fouling the quicksilver, and also by checking the reactions of the chemicals.

2. By carrying off in combination such silver as they contain not capable of being liberated by pan amalgamation. There is no sharp line between free-milling and roasting-milling ores. Often the upper part of a vein is free milling, and the lower part contains base metals and sulphides, so that finally it becomes necessary to roast the ore. The best extraction is obtained on the decomposed or oxidized ores, from which, by weathering, the sulphur has been removed, and where the silver occurs in form capable of being reacted on by mercury. Occasional deposits of silver chlorides and of native silver, together with the oxidized ores, make up all the ores capable of free milling.

Silver milling may be divided into:

1. The wet-silver mill or Washoe process, including
 - (a) The tank mill,
 - (b) The Boss process.
2. The dry-silver mill, or Reese River process.
3. Combination mills, combining the gold mill and the wet-silver mill.

In the treatment of silver ores the principal thing which we note is the time required to effect the amalgamation. Thus, in gold milling, that portion of the gold not caught on the inside plate comes in contact with the outside amalgamated apron-plate for a few seconds only. In silver milling, on the contrary, the pulverized ore is ground and mixed most intimately with the mercury for hours in an amalgamating pan, the operation being assisted by heat, and by the addition of chemicals to promote the amalgamation.

Again, in gold milling, an ore containing 0.5 oz. Au per ton can be satisfactorily milled. In silver milling an ore of equivalent value would contain 20 oz. Ag per ton of ore, or 40 times as much metal as in the first case. Thus it can be seen why so much time and pains must be taken in silver milling to be sure that all the metal possible shall be recovered. Even so, there may still remain several ounces of silver in the tailing.

Chloridizing amalgamation versus free milling.—The amalgamation of roasted silver ores gives a higher extraction, consumes less iron and loses less quicksilver than is the case in wet milling. On the other hand the expenses of roast amalgamation are high, and the volatilization loss is large, hence the Reese River process is not extending. Probably many ores may give a good yield after a quick oxidizing roast in place of a slow chloridizing roast.

Roast amalgamation is being replaced by the combination process, in conjunction with the smelting of the concentrate.

The lower-grade silicious silver ores are now being treated with marked success in Mexico and elsewhere by a combination of concentration and cyaniding. At Tonopah, Nevada, the cheapest method of treating the silver-gold ores of that district has been found to be, after a careful investigation of other methods,

wet crushing in stamps, close concentration, and cyaniding of sand and slime after the usual separation in classifiers.

40. THE WET-SILVER MILL OR WASHOE PROCESS (TANK SETTLING).

The process is suitable to so-called free-milling ores, in which the silver is found in native form or as chloride. Sometimes a little silver sulphide may occur, but the ore should be free from lead and from any tough, clayey gangue.

Fig. 82 is a sectional elevation of a wet crushing silver mill. The ore coming from the mine is, as in gold milling, dumped over a grizzly or bar-screen set at an inclination. As a result the larger pieces of ore (oversize) are screened out and fall close to the mouth of the crusher, while the finer portion (undersize) passes by chute direct to the receiving bin. The lump ore is meanwhile fed to the crusher, and joins the rest in the receiving bin. As a result of using a grizzly, the crusher, relieved from the fine ore, can put through more material. This work of coarse crushing should all be done during the ten hours of the day, and the receiving bin should be large enough for holding a night's supply. Crushing is done to 1.25 in. size, and preferably even to 0.75 in., since by finer crushing the tonnage of the stamps may be increased. From the receiving bin the ore is fed to the stamps by an automatic feeder. The mortar, in silver milling, has a double discharge since the machine is intended for crushing, and the increased screen-opening gives larger tonnage. The screens are of 30-mesh. (For further particulars of gravity stamps see the detailed description under gold milling.) Water, (about 8 tons per ton of ore) is fed in to make a pulp, which flows or is splashed through the screens and then goes by launder to the settling boxes. The settling tanks or reservoir consists of a space divided into boxes or compartments, each 9 ft. long 5 ft. wide and 3 ft. deep. The flow of the pulp is from box to box until it finally goes by launder to a settling pond outside the mill. In the first boxes most of the solid matter settles out, a further portion dropping in the succeeding boxes until the still dirty water passes to the settling pond. Here it has its final

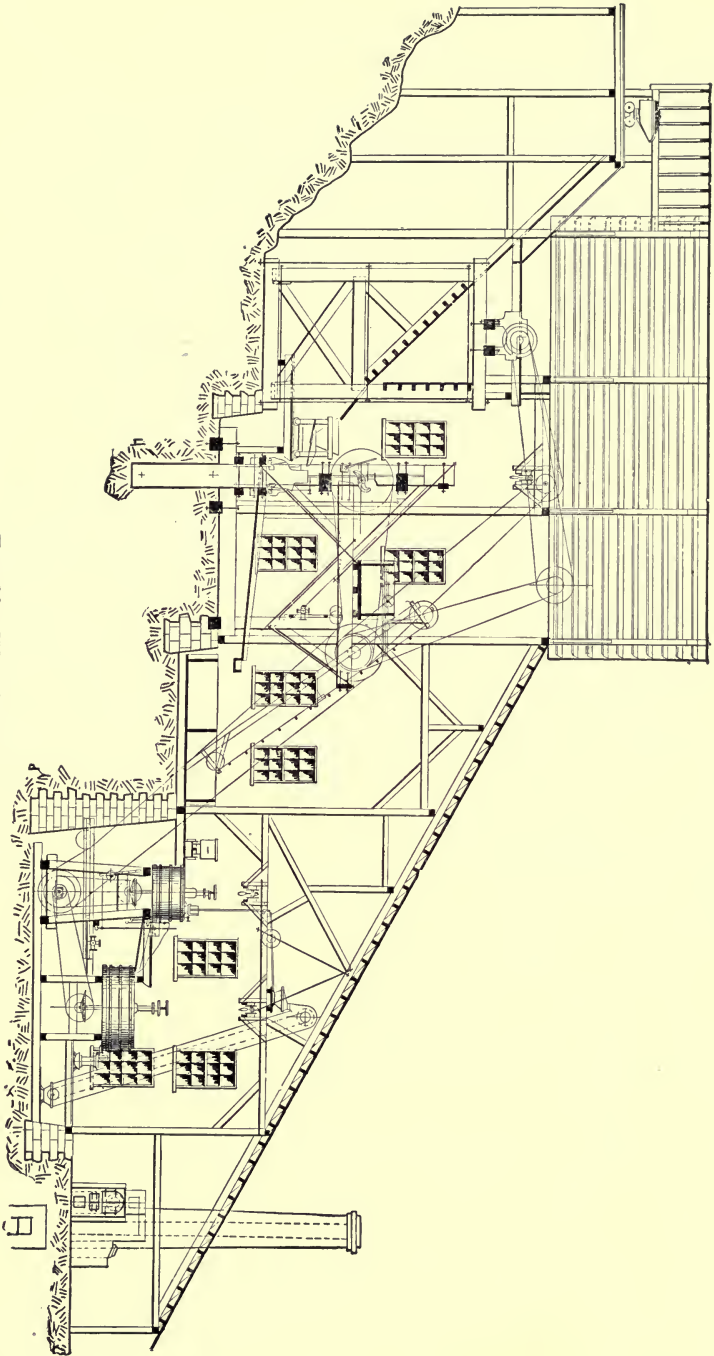

FIG. 82. WET SLIVER MILL.

chance to settle and clear itself, after which the settled water runs to waste, or may be used over again in the mill if the water is so scarce that it is an object to do so, while the pond settlings are treated in pans as they accumulate. When the first settling box is full it is by-passed or cut out by turning the flow into the next box. The full box is then shoveled out upon the floor adjoining, and taken, as needed, to be fed to the pans. Meanwhile, the just emptied box has the flow of the last one turned into it, thus forming the final one of the series. The launders are so arranged that all this can be conveniently done.

The ore is now ready for further treatment and is charged into 5-ft. diam. amalgamating pans together with mercury. Fig. 83 is an illustration of such a pan as is used today in silver milling. It consists of a cylindrical cast-iron pan furnished with a central cone through which a shaft rises carrying the muller. The muller has attached to its lower surface 6 cast-iron shoes 2.5 in. thick. The muller can be raised or lowered as desired by means of a hand wheel and screw on top of the shaft. The bottom of the pan has fixed to it iron plates or dies, forming the lower or fixed grinding surface. The muller, which revolves 60 rev. per min., not only serves to grind the ore more finely but also to divide up the mercury at the bottom of the pan and to bring the small globules of it in intimate contact with the ore pulp. There is set up a movement or current of the pulp toward the periphery, where it rises, flows toward the centre, and sinks down near the centre and again comes under the muller to be again ground and brought in contact with the mercury. To assist this action, the rising pulp is deflected by means of cast-iron wing-plates. The reaction in the pan, by which the silver in the pulp becomes amalgamated, proceeds most favorably when the pulp is heated nearly to boiling by means of steam generally introduced through a pipe which dips beneath the surface of the charge. Sometimes also the pan is provided with a double bottom, into which exhaust steam from the engine may be introduced.

The reactions which take place in the pan are as follows: Native silver in threads, films or particles is readily taken up and dissolved in mercury, forming an amalgam which, mixed

with a large excess of mercury, resembles it. Silver chloride coming in contact with mercury is decomposed by the latter thus:

$2 \text{AgCl} + 2\text{Hg} = \text{Hg}_2\text{Cl}_2 + 2 \text{Ag}$, the silver then amalgamating with other mercury. But the $\text{Hg}_2 \text{Cl}_2$ does not long remain as such since the iron bottom of the pan and particles of iron abraided from the stamps soon decompose it again, settling free the mercury. In many so-called free-milling ores there is, how-

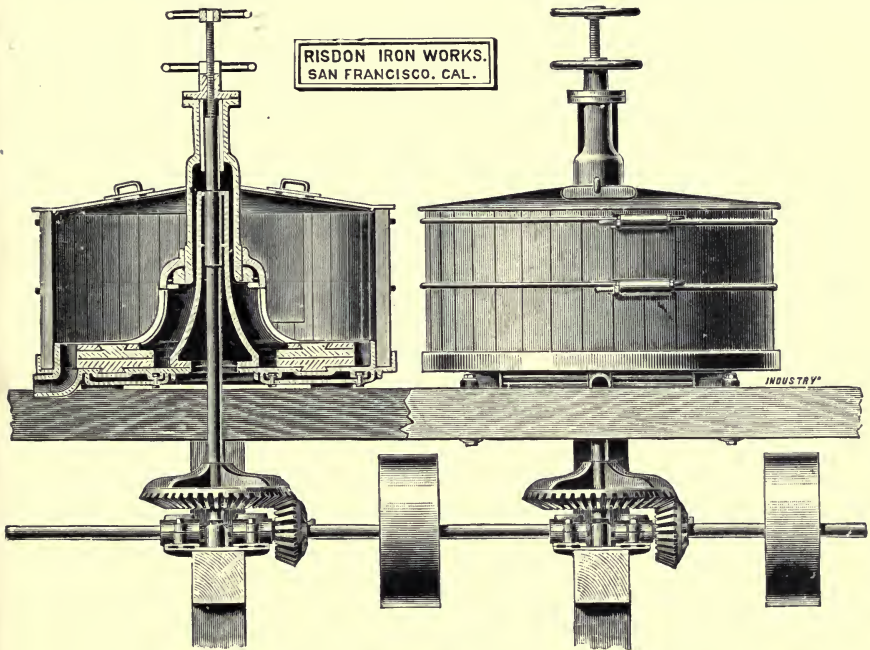

FIG. 83. COMBINATION AMALGAMATING PAN.

ever, some silver sulphide which is, in part, decomposed by the mercury as follows:

$\text{Ag}_2 \text{S} + 2 \text{Hg} = \text{Ag}_2 \text{Hg} + \text{HgS}$, the latter salt being lost. Chemicals are also added to promote decomposition of the silver sulphide, namely: copper sulphate and common salt. From 6 to 18 lb. of salt and 3 to 9 lb. of copper sulphate are added per ton of ore treated. The reactions which take place are, as generally given.

$\text{Cu SO}_4 + 2 \text{Na Cl} = \text{Na}_2 \text{SO}_4 + \text{Cu Cl}_2$; and this latter compound acting on the silver sulphide decomposes it: $\text{Ag}_2 \text{S} + \text{Cu Cl}_2 = \text{CuS} + 2 \text{Ag Cl}$, which latter is then decomposed by the mercury as already stated.

In working the pans the mullers are first raised half an inch, water is run in, the muller set in motion and 3,000 lb. ore charged in. The ore and water are stirred to a pulp of about the consistency of honey, and nearly fill the pan. The muller is now lowered until the shoes touch the dies, and the ore is finely ground for about one and one-half hours, the contents of the pan being meanwhile heated up. The shoes are then raised, 300 lb. or 10% of mercury is added, and the mixing is continued for four hours. Amalgamation proceeds rapidly at first, but soon diminishes. Thus, at the end of the first hour 74.7% of the silver was amalgamated, at the end of the second 76.3%, at the end of the third 77.7% and in four hours 81.0%, after which no more was taken up. The amalgamation being complete, the pan is emptied to the settler. About 15 minutes before discharging, the speed of the muller is reduced to 40 revolutions, and the pan filled to the top with water. A plug, closing the discharge opening at the side of the pan, is now pulled out and the entire contents of the pan run to the 8-ft. settler, the amalgam being separated there from the ore. Emptying takes half an hour, water being allowed to run into the settler at the same time.

The complete separation of the amalgam, mixed of course with a large amount of mercury, is effected in the settler, there being one settler provided for each two amalgamating pans.

The settler is a cylindrical vat or pan 8 ft. diam. by 3 ft. deep with a cast-iron bottom and wooden sides. As shown in Fig. 84, it resembles an amalgamating pan, having a muller provided with shoes of wood, since the object of the pan is to stir, not to grind. The shoes nearly touch the bottom of the settler, and can be raised or lowered, as desired, like the muller of the amalgamating pan. The grooved border of the bottom of the settler slopes to the side, conducting to an outlet which is provided with a mercury-well. The mercury, settling out, collects in this well to a height to balance the contents of the pan, say two to three inches. At different heights in the side of the pan openings are

provided, closed by plugs, for the discharge of the amalgam-free tailing.

The muller of the settler, being in motion at the rate of 15 rev. per min. with the shoes 8 in. above the bottom, the content of the two pans is run into it, and water is added to 6 in. of the

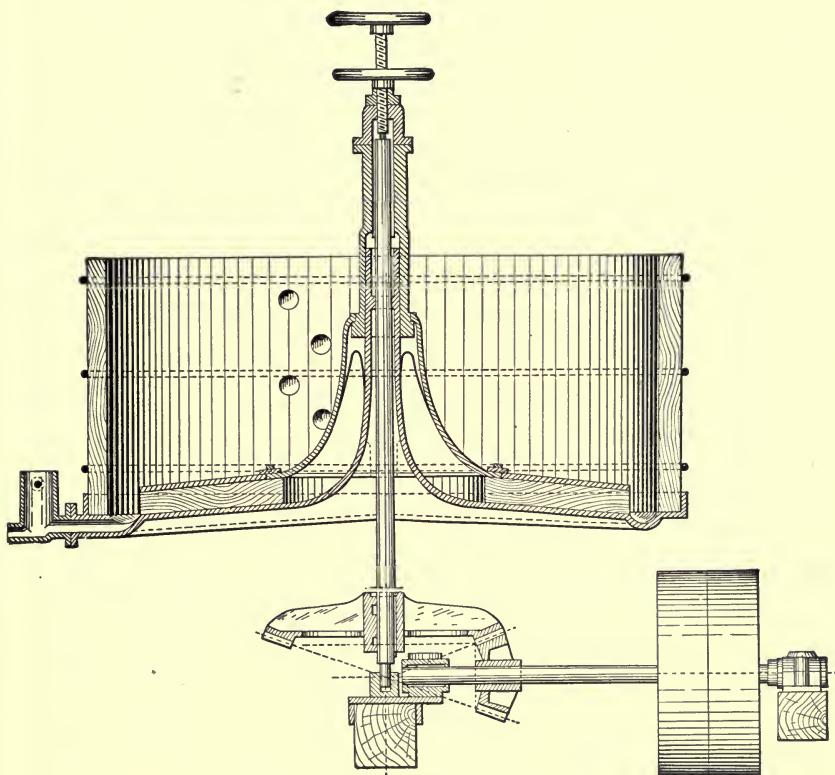

FIG. 84. EIGHT-FOOT SETTLER.

top. After half an hour the shoes are gradually lowered, nearly touching the bottom by the end of two hours. The purpose of the agitation is to keep the lighter portion of the ore (now called the tailing) in suspension, while the amalgam, mercury, sulphides and fine particles of iron collect at the bottom of the settler. The stirring is kept up for 3.5 hours, after which the highest

plug at the side of the settler is removed, and the turbid water allowed to flow away by launder. The succeeding plugs are then one by one withdrawn until the settler is emptied of all except the heavier portion above mentioned. Emptying lasts half an hour. Since the escaping tailing contains some portion of sulphides and particles of amalgam, it is often run over concentrating tables to recover this valuable heavier portion, otherwise it runs to waste. The amalgam mixed with mercury, or,

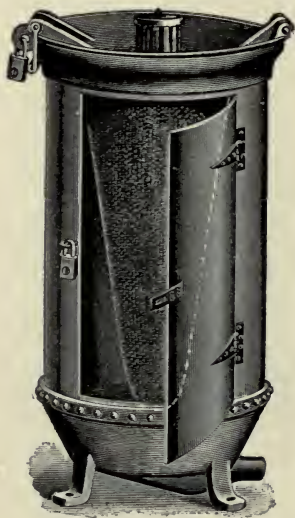

FIG. 85. AMALGAM SAFE.

as it may be called, diluted amalgam, collects in the mercury-well, overflowing by a higher opening to the amalgam safe, Fig. 85. Here it enters a conical canvas sack or filter, the mercury oozing through the pores of the canvas, while the amalgam, containing say 14% Ag, is retained. Occasionally the sack is squeezed to remove the surplus mercury, and the amalgam, containing 20 to 28% Ag, is reserved for retorting. The mercury is drawn off, or flows away by the outlet *p* to be used again. In the large mills the mercury is returned to a cast-iron tank placed at a level above the pans, being raised by a mercury elevator which is an ordinary belt elevator furnished with iron buckets.

The loss of mercury is from 1 to 3.5 lb. per ton of ore, and is greater in talcose or clayey ores, and in those carrying cerussite or sulphides of copper and lead. It is also lost by grease, coating over globules of mercury, and by flouing caused by the stamping, grinding or washing.

Treatment of the amalgam.—Since the quantity of metal recovered in silver milling is so much greater than in gold milling, the retorting of the amalgam must be performed on a larger scale. Fig. 86 shows sections of a combined retorting and melting furnace for a silver mill or for a large gold mill, showing also the arrangement for handling the melting crucibles. The

retort, as shown, consists of a cast-iron cylindrical vessel 4 to 5 ft. long, 10 to 14 in. diam., of cast iron 1.5 in. thick, and weighing 900 lb. It is provided at one end with a water-cooled pipe,

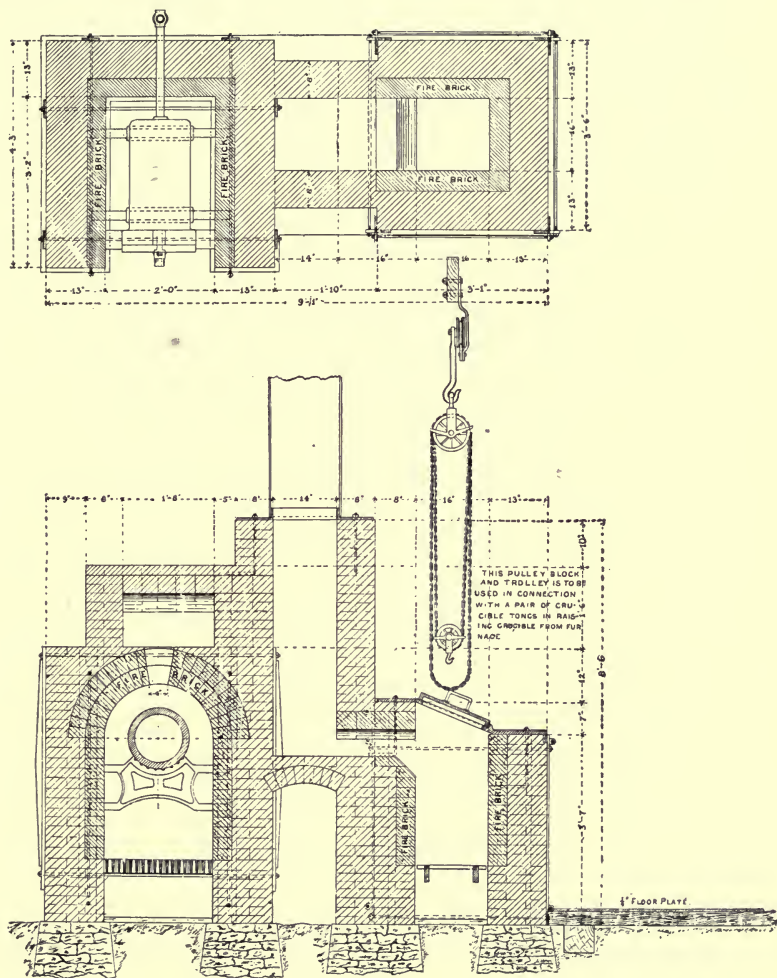

FIG. 86. HORIZONTAL RETORT AND MELTING FURNACE FOR SILVER MILL.

the end dipping in the water of the vessel provided to collect the mercury. The other end is provided with a cover or retort-head, securely and tightly clamped by a screw.

Operation.—The charge of amalgam, containing 20% of mercury, should not more than half fill the retort, and weighs 1,000 to 2,000 lb. After filling, the cover is clamped on, first making the joint with some flour-paste. A fire of wood is started under the retort, low at first and increasing to a cherry-red heat at the end, using 0.65 to 0.75 cord. The operation lasts 10 to 14 hours, the mercury being driven off down to 1 to 1.5%. Care must be taken not to heat the retort too rapidly, nor to raise the heat too high for fear of blistering it, after which it is allowed to cool, and the silver residue removed. The melting down of these residues is performed in plumbago crucibles with the addition of a little soda and borax as fluxes. When melted, the crucible is removed from the furnace by means of basket tongs, which surround and grip the crucible firmly so that it can be lifted out by the chain hoist and poured into an ingot mold 11 in. long by 4.5 in. wide and 4.5 in. deep, and capable of holding 1,000 oz. or 70 lb. of silver.

The residue, suspended in the muddy water run from the settlers, known as tailing, contains a certain portion of heavy unaltered ore which can be generally profitably worked either on Frue vanners or over some other of the concentrating tables. Otherwise sluices are used, two or three together, 2 to 3 in. high, 20 in. broad and as much as 1,800 ft. long. The bottoms of the sluices are covered with coarse blankets, which may easily be taken up and washed to remove the concentrated or heavy portion of the ore, which has been caught in the meshes of the blankets.

Cost of pan amalgamation (Washoe process) per ton of ore treated:

Power	\$0.087
Labor	0.361
Chemicals, salt, acid and bluestone.....	0.465
Loss of mercury	0.750
Wear of pans	0.200
Wear of dies and shoes	0.400
Oil, interest and superintendence.....	0.100

Total cost per ton\$2.363

41. THE BOSS SYSTEM OF SILVER MILLING.

This system or process was originated by M. P. Boss, a Californian engineer, and differs from the ordinary settling-tank system in being continuous, saving much hard labor. It may be used both on free-milling ores and on rebellious ores requiring a preliminary roast.

The ore-pulp as it leaves the battery passes through the pans in series (see Fig. 87 and 88), being finely ground in the first ones, then amalgamated and finally settled, the pulp being ground,

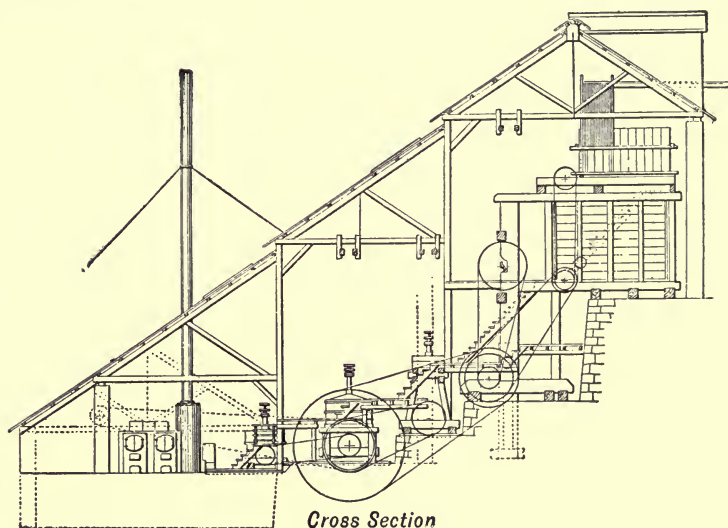

FIG. 87. BOSS-PROCESS SILVER MILL (ELEVATION).

brought into intimate contact with the mercury and ultimately settled in series, each pan doing part of the work. The first two 5-ft. pans of the series do the fine grinding of each 5 stamps. The pulp, which is a thinner mixture of ore and water than in the tank system, flows from the top of one pan by a short pipe connection to the next. After this the finely ground pulp passes through the 5-ft. amalgamating pans and then through all the settlers arranged in the same way and on the same level. Each pan has its pipe connection to the next, and the last pan

in the same way to the settlers. Any pan or settler can be by-passed or cut out, the pulp flowing around to the following ones. The quicksilver (as well as the salt and bluestone, in a state of solution) is fed automatically and continuously to each of the amalgamating pans, the portion settling to the bottom collecting in a mercury-well. The settlers also have mercury-wells, so that the collecting of the mercury, with its contained amalgam, is continuous. As it accumulates in the wells, it overflows to the strainer, where the excess mercury is elevated and returned to the overhead supply-tank. The continuous discharge from the last settler goes through classifying-cones to concentrating tables, where the valuable heavy part of the ore is removed as concentrate.

42. THE COMBINATION PROCESS OF SILVER MILLING.

The process is applicable to ores carrying silver with some gold, and containing sulphides of base metals, such as pyrite, galena and zinc, which also carry gold and silver values. It is necessary, however, that the silver not present in the sulphides should be amalgamated.

It consists in wet stamping the ore, permitting the pulp to run over amalgamated plates as in gold milling, concentrating out the heavy gold and silver-bearing sulphides, pan amalgamating and settling the tailing from the concentrating tables as in the Washoe process.

When compared with either wet or roast amalgamation the process has much to recommend it.

By wet stamping the stamps crush one and one-half to two times as fast as dry. It is true that the roast amalgamation will extract 10% more than can be done by raw amalgamation, but this is offset by the cost and losses of roasting. The combination process also saves the lead by concentration, and removes both the base-metal sulphides, arsenic and lead, which tend to foul and cause loss of the mercury and interfere with amalgamation; and there results a cleaner or higher grade bullion. Manganese minerals, which use up chemicals in the pan, are also removed by concentration. It is probable that, because of these advan-

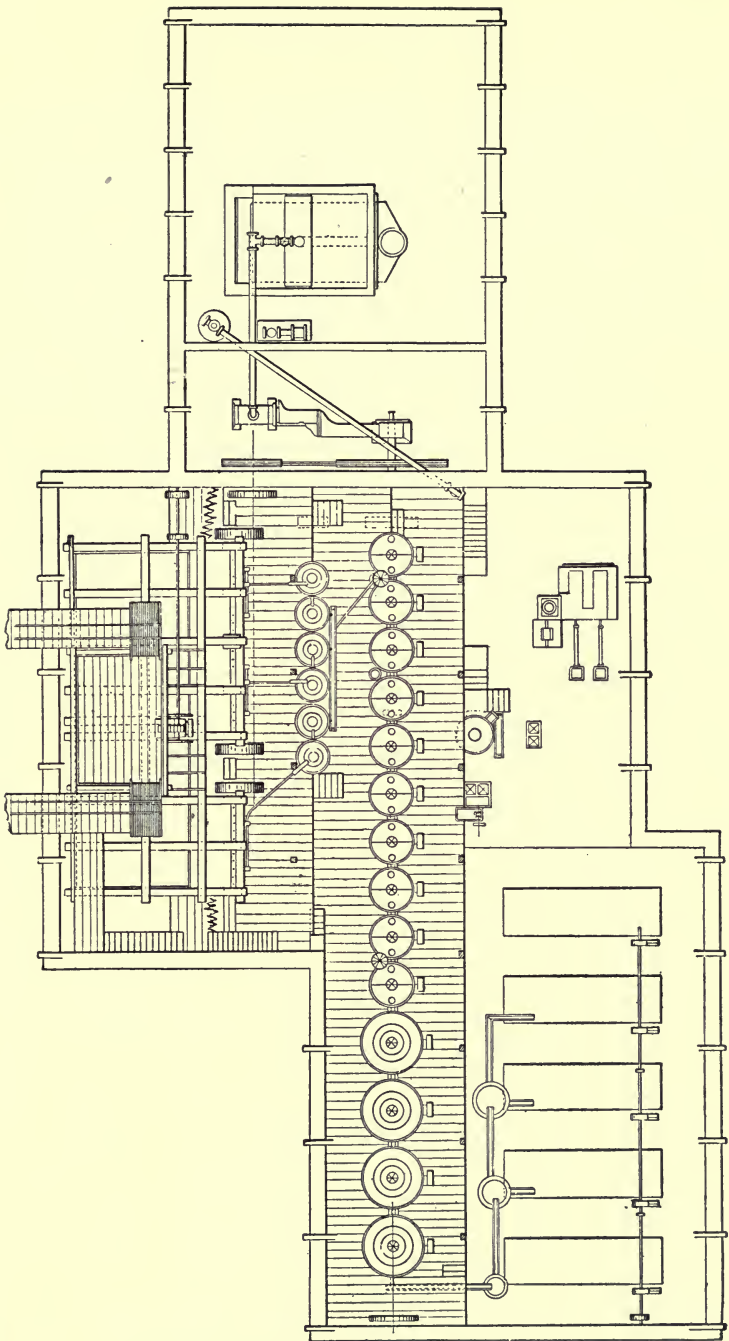

FIG. 88. BOSS-PROCESS SILVER MILL (PLAN).

tages, the combination process will extend, certainly at the expense of roast amalgamation which is fast losing ground, and may perhaps supplant lixiviation either by hyposulphite or by cyanide.

Fig. 89 is a perspective view of a 10-stamp combination mill. It shows, at the upper stage, a car about to be dumped over a grizzly, while the lumps pass on to the crusher where they are crushed to 1 in. diam., this portion then joining the fine in the storage bin ready for the stamps.

Let us consider an oxidized ore containing native silver, silver chloride, a little silver sulphide, lead and copper, and, perhaps, manganese minerals constituting the heavy part, and a light gangue of quartz, clay and calcite. The problem is to save the gold and silver, to remove the lead, copper, arsenic and manganese. Arsenic tends to sicken the mercury, while manganese uses up chemicals in the pan amalgamation.

The ore is fed automatically to the stamps, each of which may be considered as crushing 5 tons daily to pass a 30-mesh screen. The pulp, issuing from the mortar, passes over an apron-plate where part of the gold and the silver is recovered. Thence the pulp passes to concentrating tables where the heavy part is removed and, as concentrate, shipped to the smelting works. The tailing of the tables flows through a series of settling boxes as in the Washoe process. Indeed, from this point on, operations are conducted as in that process. Bluestone and salt are used in amalgamating to break up silver sulphides. It may be noted that the careful settling of the tailing ensures the eventual delivery to the pans of the amalgam and mercury from the apron-plates. Five-foot combination amalgamating pans are used which treat a charge of 1.25 tons, the time of treatment varying from 4 to 8 hours, according to the nature of the ore. The recovery of gold and silver in one case was as follows:

	Gold %	Silver %
Recovered on the apron-plates	22	3
Recovered on concentrating tables	28	32
Recovered in amalgamating pans	32	35
Lost in tailing	18	30
	<u>100</u>	<u>100</u>

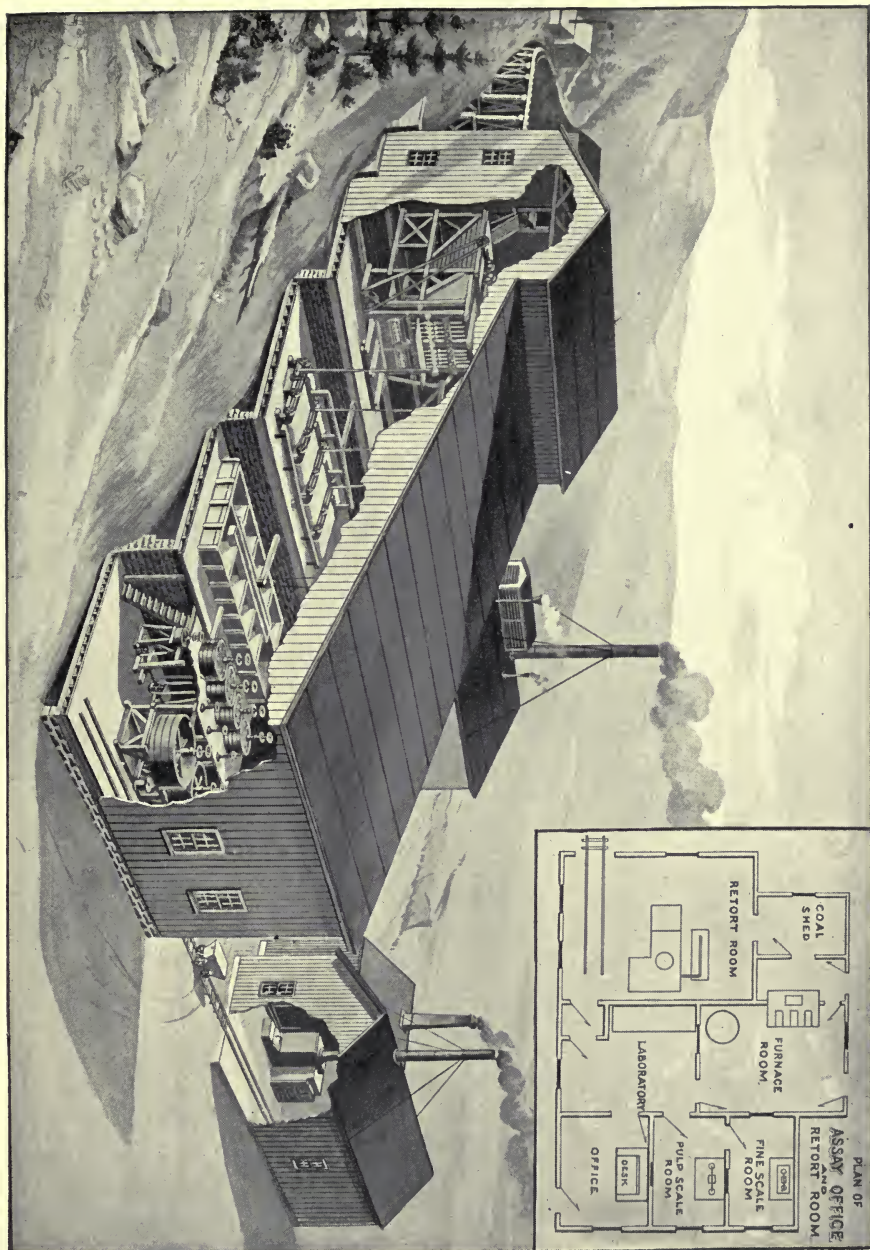

FIG. 89. COMBINATION MILL.

Concentration adds but little to the costs as compared with pan amalgamation, so that \$3 per ton may be taken as a fair figure.

43. CHLORIDIZING ROASTING.

This is performed upon rebellious silver ores where we desire to bring the contained silver into the form of a chloride so that it can be extracted by amalgamation or by lixiviation. Such ores contain the silver as sulphide or as arsenical or as antimonial silver sulphides associated with the heavy sulphides of iron, zinc, copper, and lead.

As a preliminary to roasting such ores are dry crushed, either by rolls, or by stamps. Galena-bearing ores are preferably crushed to 40-mesh, but with pyrite, 16-mesh is sufficient.

The roasting is done with the addition of salt, and in presence of 3 to 8% of pyrite, the larger quantity being needed where there is much limestone in the ore. If the ore contain more than 8% pyrite it may be roasted down to that percentage in sulphur, after which the salt may be added. The amount of salt varies from 3 to 18% according to the quantity of contained pyrite, blende, or limestone, all of which take up chlorine.

The roasting operation is at first an oxidizing one, acting upon the heavy metals, and converting them into either oxides or sulphates. It may be divided into three stages: (1) The kindling, (2) the desulphurizing or oxidation, and (3) the chlorination. Referring to the 'Chemistry of Roasting,' we find an account of what occurs in the kindling stage. We find that the ferrous sulphate, which has been formed from the pyrite, begins to decompose at 590° C, evolving sulphuric anhydride, and this reacts upon the salt thus:

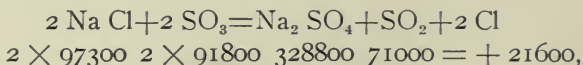

an exothermic reaction. The chlorine, thus set free, begins acting upon the silver sulphides, arsenides and antimonides, converting the silver into chloride.

At the second stage of the roasting above mentioned, especially where salt has not been at first added, the heat may

rise to such a degree as to form metallic silver according to the reaction:

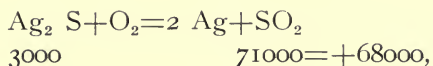

also a strong exothermic reaction. In the subsequent amalgamation, the fact that the silver is in metallic form is no detriment, but, if lixiviation is to follow roasting, silver is but little acted upon by the solution, and hence, for the latter process, the roasting must be more cautiously conducted.

However, metallic silver is slowly acted upon at a red heat by chlorine gas and some silver chloride is formed.

At the various stages of roasting, iron, copper, zinc and lead sulphates are formed, which are acted on by the salt as illustrated in the case of the iron sulphate,

$\text{Fe SO}_4 + 2 \text{ Na Cl} = \text{Na}_2 \text{ SO}_4 + \text{Fe Cl}_2$, so that soluble chlorides of iron, copper and zinc result, besides the sparingly soluble Pb Cl_2 . That is to say, the salts of the heavy metals are brought in soluble form as the result of a chloridizing roast. These decompositions are not, however, complete, so that some soluble sulphates are later extracted when the roasted ore is treated with water.

For moderate quantities of ore the chloridizing roast is carried on in reverberatory roasters, in larger quantities in one or another of the mechanical roasters. The perfectly dry and salted ore is charged to the furnace and roasted at a low heat, at first to kindle the ore and to bring about decompositions. The heat is raised upon it toward the last to produce the chloridizing reactions.

At the present time it is not usual to continue the roasting in the furnace with a view of converting therein all the silver compounds into chlorides, but the charge is withdrawn in a hot condition before this stage is reached, and, during the gradual cooling, lasting 12 to 30 hours, a further chloridizing takes place, due to the action of free chlorine, with which the ore is saturated, on yet undecomposed silver sulphides. This may increase the chloridization 10 to 40%. Upon the completion of this operation of heap chlorination, as it is called, and upon ores containing cop-

per chloride, a wetting down or sprinkling will result in an additional chlorination of 3 to 6 %. Thus, at the Lexington Mill, Butte, Mont., the ore, just after roasting in a Stetefeldt furnace, was chloridized to 65%, after 2 hours to 75 to 80%, and at the end of 36 hours to 92% of its silver contents.

The loss of silver by volatilization when the ore has been properly roasted should not exceed 8%, except in presence of many volatile elements like arsenic, antimony, selenium or tellurium. If, however, the roasting is completed at too high a temperature, the volatilization losses may run up to 18%.

Taking the cost of a chloridizing roast at \$2.40 per ton, it will be equal to the value of 4 oz. at 60c. per ounce. Adding, on a 25-oz. ore, 8% for the volatilization loss, or 2 oz. more, we have a total of 6 oz. or 24%, so that 60% extraction by raw amalgamation would be as profitable as 84% on roasted ore, to say nothing of the cost of installation of the roasting plant and the extra cost of dry crushing. It would seem, therefore, that the lower grade silver ores, of less than 30 oz., could be more profitably treated raw.

44. DRY SILVER MILLING. (REESE RIVER PROCESS.)

This process is applied to the treatment of rebellious silver ores, in which the silver is so locked up that it is required, before amalgamation, to roast the ore, necessitating dry crushing. While rebellious ores are worked by this method, it pays, in many cases, where smelting works are available, to ship the ore rather than to mill it. Or again, if the heavy portion of the ore carries the values, it may be profitable to undertake concentration only, and to submit to some loss in the tailing. Such problems should be worked out on a trial scale before undertaking the construction of a plant.

The ores mainly worked by this process are those containing sulphides of silver, particularly antimonial and arsenical sulphides, together with base-metal sulphides containing copper, iron, zinc and lead. The latter, however, when over a certain limit, render the ore unsuitable for this process.

The ore before roasting is dry crushed either by rolls or by stamps. The former method is fully described in the chapter on

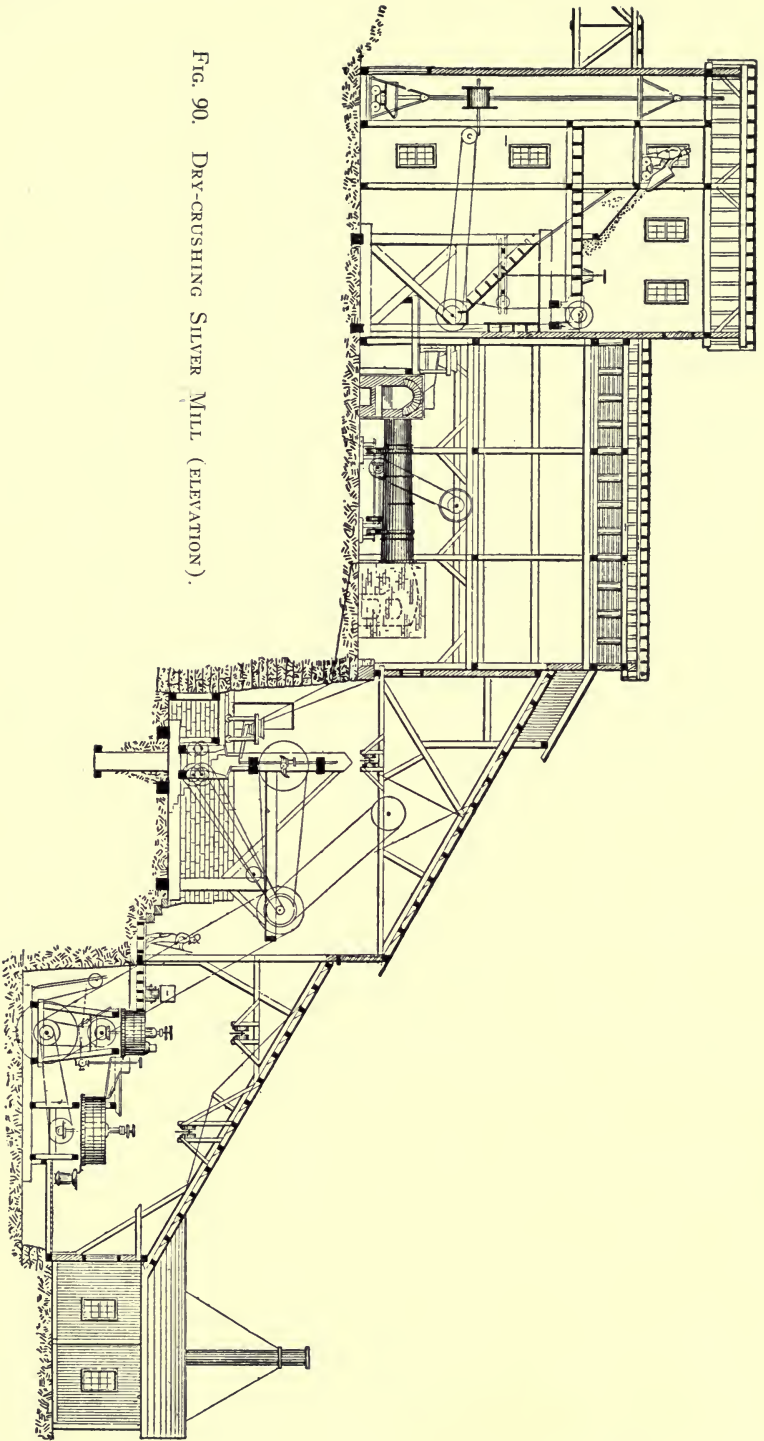

FIG. 90. DRY-CRUSHING SILVER MILL (ELEVATION).

crushing; the ore after crushing being fed continuously to the feed-hopper of the roaster. Otherwise operations are carried forward as in the dry crushing silver mill, Fig. 90 and 91, now to be described.

The ore, as in wet milling, is coarsely crushed during the 10-hour day shift, and delivered to the storage bin, whence it is continuously fed by an automatic ore feeder during the 24 hours to a cast-iron revolving dryer 18 ft. long. Here the ore is dried out; and by inclined launders slides to the automatic feeders of the stamps, entering the double discharge mortar where it is finely crushed. As fast as the crushing proceeds, the ore is projected by its impact against the screen, the finer particles passing through, while the coarser material drops back upon the die to be again crushed. Naturally this produces dust, and, to prevent much of it in the mill, the mortar is housed. There is also an exhaust fan, connected to the housing, by which the dust is carried away and deposited in a dust chamber. The finely ground ore, passing through the screens, is carried by screw-conveyors, one on each side of the mortar, to an elevator. It is customary to feed to the last five stamps the rock salt necessary to go with this ore, and, which being finely crushed, can be intimately mixed with it. The ore and salt mixture raised by the elevator passes by screw-conveyors to the feed-hopper of a White-Howell roasting furnace, see Fig. 40, where it receives a chloridizing roast. On the plan view (Fig. 91) is shown the flue-chambers which collect the dust and the stack which furnishes the draft. The ore from the roaster falls into pits or receptacles where it undergoes further chlorination, and is then moistened with a little water to prevent dusting and placed in heaps upon the cooling floor to be treated in batches or charges in the pans.

The pan amalgamation of roasted ores is performed in wooden-sided pans resembling those used in the Washoe process. As compared with it, the yield of silver is greater, being as high as 97%, and the loss of quicksilver less, being but 0.25 lb. per ton of ore. Water is first run into the pan, while in motion, and the ore added, in 1.5 ton batches, until the pulp is of the consistency of honey. If the ore is badly roasted, salt and bluestone are put in to decompose silver sulphide. The free chlorine in the ore is

FIG. 91. DRY-CRUSHING SILVER MILL (PLAN).

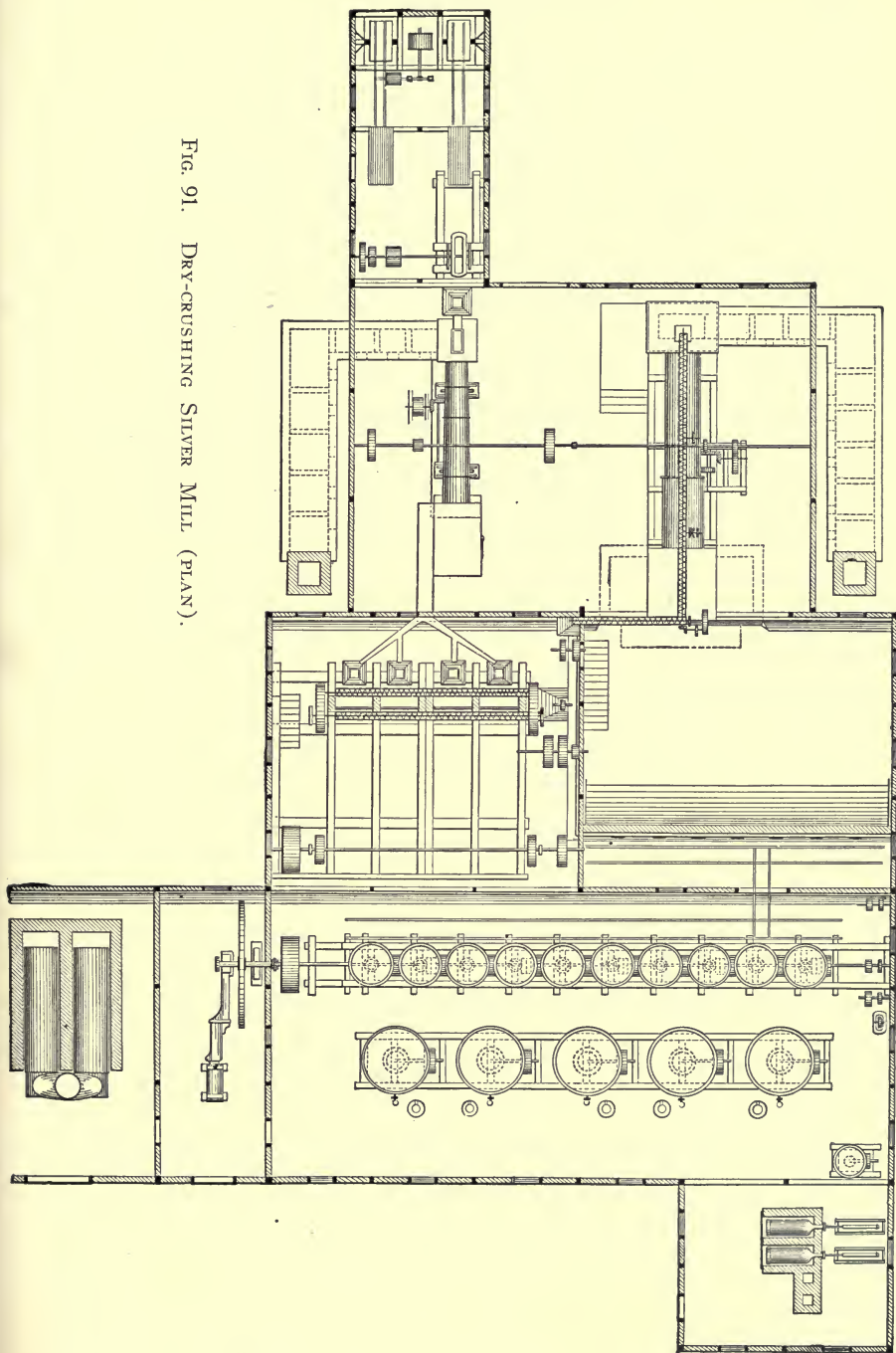

taken up by the iron surfaces of the pan, and from any iron particles, which have come from the stamping, and is thus removed from detrimental action on the mercury, 300 lb. of which is added in 1 to 2 hours after starting. The muller is raised at the time of this addition so that no further grinding takes place, the action of the muller being to mix intimately the mercury and the pulp. Amalgamation proceeds rapidly at first, the silver chloride being reduced to metal as in the Washoe process. The iron present reduces the higher chlorides of copper and iron and converts any mercurous chloride to metal. This mixing is kept up for a period of six hours, the pulp is then diluted with water, and the entire charge is run into the settler. The amalgam is collected and treated as in the Washoe process. At the Lexington mill, Butte, Mont., an ore containing 28.5 oz. Ag and 0.58 oz. Au per ton gave a yield of 93.3% of the silver and 60% of the gold after roasting. The loss of silver in roasting was, however, 7%, while the loss of gold was 20%.

The cost of dry stamping, followed by chloridizing roasting, may be taken at \$6.48, being the average of three mills in different parts of the Rocky Mountain country, which vary but little from one another.

45. HYPOSULPHITE LIXIVIATION OF SILVER ORES. (PATERA PROCESS.)

Free-milling silver ores, that is, oxidized ores containing the silver in native state or as chloride, do not need to be treated by this method, but preferably by milling and amalgamation. Hyposulphite lixiviation is used upon ores containing simple and compound sulphides of silver which have undergone a preliminary chloridizing roasting. The silver is then dissolved by sodium hyposulphite, precipitated by sodium sulphide, and the precipitated silver sulphide worked up for the resultant silver. The crystalized sodium hyposulphite ($\text{Na}_2\text{S}_2\text{O}_3 \cdot 5 \text{H}_2\text{O}$), contains 5 equivalents of combined water and 100 parts of it will dissolve 40 parts of silver chloride. Ores, to be adapted to the process, must not be rich in lead, copper or lime, because in roasting, their chlorides tend to coat over the undecomposed particles contain-

ing silver. They also go into solution as sulphates and chlorides. As a result, we find the lead and copper precipitating with the silver, thus contaminating the silver product, while the quicklime produced in the roasting diminishes the solvent power of the hyposulphite and, with the lead present, precipitates it as hydrate, coating over the particles of silver chloride and preventing their lixiviation.

Up to a certain point this may be prevented by a preliminary extraction of these soluble base-metal salts by hot water. Metallic silver, if finely divided, may be lixiviated, as also the arsenate and antimonate of silver produced during the roasting. Undecomposed silver sulphides and arsenic or antimony sulphides are, however, not attacked by the hypo solution.

Roasting the ore. The ore undergoes a chloridizing roast, as described in the chapter on roasting, it being much the same as a chloridizing roast for amalgamation, except that greater care must be exercised, the coarser unattacked silver being only slowly dissolved by hypo solution while it is readily soluble in mercury.

Leaching the ore. To give an idea of the quantities of bases present in a silver ore successfully treated by lixiviation we will take Ontario ore, Park City, Utah, as an example. The silver sulphides are argentite and cerargyrite, together with tetrahedrite, forming 'gray-silver ore' called also fahlerz. Analysis gives 55.2% SiO_2 , 13.1% Al_2O_3 , 3.3% Fe and Mn, 6% Pb, 1.4% Cu, 9.6% Zn, 1.4% As and Sb, 7.7% S. This ore would, therefore give, on roasting, the soluble sulphates and chlorides of iron, lead, copper and zinc, which must be got rid of before treating the ore with hypo solution for the extraction of the silver.

Fig. 92 is an elevation of a Hoffman leaching vat, 12 ft. diam. and 4 ft. deep, with a central discharge opening for tailing. The false bottom, as shown, slopes toward the centre and is a wooden lattice work made in sections and covered with cocoa matting. Upon this is laid a canvas filter-cloth, 6 in. larger in diameter than the vat. The edges of the canvas are crowded down by means of a rope driven into the groove *p* at the inside circumference of the vat, and in the same way at *p'* near the centre.

The ore is brought from the cooling-floor near the roasters to the tank, and tipped in evenly, taking care that it is not tramped

down or compressed in any way to interfere with its loose, porous condition. It fills the tank to a depth of 2.5 ft., this thickness being preferred because the water used in the first wash will contain less salt (taken from the ore) to leach out silver, and because the contents of the vat are more easily sluiced out. About 12-in. space is left above the charge to the top of the tank.

The preliminary leaching with water. Cold water is the best for leaching where there are but small quantities of the base-metal salts to remove; but if there is much of these, then hot water must be used. In such a case much silver chloride is dissolved, due to the presence of salt in the water derived from the ore. The water admitted on top of the ore should leach through it at the rate of 2 to 16 in. per hour until the escaping water shows no precipitate on testing with sodium sulphide. The quantity of wash-water needed per ton of ore is 1 to 2½ tons, and the operation takes from 2 to 24 hours. If the wash-water contains but little silver chloride it is run to waste. If much, it is precipitated in a tank to which it has been run, by the addition of sodium sulphide, which will precipitate the silver as sulphide, together with some sulphides of base-metal salts. The precipitate from this tank is later treated like the main portion of silver sulphide.

Lixiviation with hypo solution. A 0.25 to 2.5% solution of the thiosulphate is run in as soon as the wash-water has sunk to the level of the ore, forcing the latter in advance out of the vat, while, as soon as the hypo solution follows, it is diverted to the precipitating tanks. The crystallized hypo salt dissolves silver chloride according to the following formula:

$2 \text{Na}_2\text{S}_2\text{O}_3, 5 \text{H}_2\text{O} + 2\text{AgCl} = \text{Ag}_2\text{S}_2\text{O}_3, \text{Na}_2\text{S}_2\text{O}_3 + 2 \text{NaCl} + 5 \text{H}_2\text{O}$;
that is, the crystallized salt dissolves 40% of its weight of AgCl, or 30% of silver. It dissolves not only AgCl, but also some finely divided metallic silver, silver oxide, arsenate and antimonate and gold. Of the other metals, copper dissolves much like silver, while lead sulphate and calcium sulphate also dissolve, but the solvent properties of the hypo solution are diminished in presence of lead and sodium sulphates, and particularly by caustic alkalies and alkaline earths, such as quicklime, the latter due to limestone which may have existed in the ore. The solvent is allowed to leach the ore until the silver is removed, as may be ascertained by

assaying the exhausted ore for silver. There should not be more than 4 oz. per ton in the tailing, the extraction amounting to 70 to 85% of the silver. The operation takes from 6 to 53 hours. The ore is then treated to a water-wash, the washings also going to the precipitation tank, 10 ft. diam. by 8½ ft. high.

Precipitation of the silver out of the hypo solution. This is effected by the addition of sodium sulphide to the solution just in sufficient quantity to do the work, the sodium hyposulphite be-

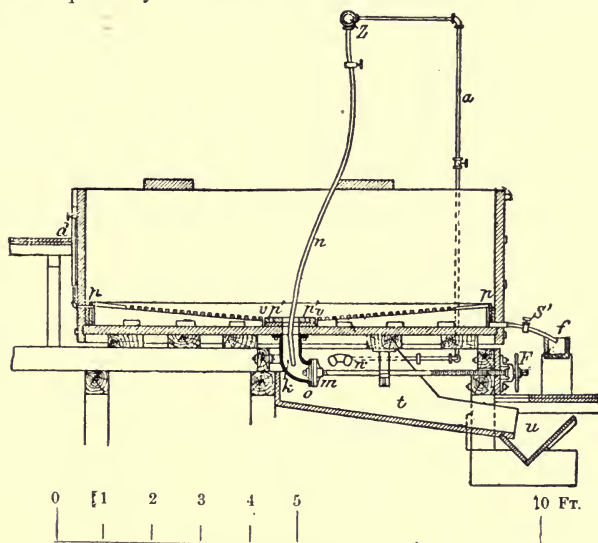

FIG. 92. HOFFMAN LEACHING TANK.

ing regenerated as follows: $\text{Ag}_2\text{S}_2\text{O}_3, \text{Na}_2\text{S}_2\text{O}_3 + \text{Na}_2\text{S} = \text{Ag}_2\text{S} + 2 \text{Na}_2\text{S}_2\text{O}_3$. Gold, copper, and salts of the base metals are also thrown down. In precipitating, sodium sulphide is added, while the solution is constantly stirred, until a sample withdrawn from the vat gives but a very slight precipitate with sodium sulphide.

The precipitate is allowed to settle and the supernatant clear solution is drawn off, the precipitate remaining in the vat. Another charge may then be run in, and treated as before. The precipitate thus accumulates in the bottom of the tank. At the expiration of several days to a week the precipitate, together with the solution which has collected at the bottom of the tank, is run

to a filter-press, where the solution is removed and sent to the stock-tank, while the precipitate is taken out of the press for further treatment. The solution, which must contain no excess of sodium sulphide, is then returned to the stock-tank to be used again on other charges of ore. As it has been weakened by the addition of wash-water, the stock solution is strengthened by the addition of fresh hyposulphite.

Sodium sulphide is made at the works by dissolving caustic soda in its own weight of water in an iron kettle at 80° C, and adding gradually to it powdered sulphur. The addition of the sulphur causes the liquid to swell to two or three times its original bulk, so that, to begin with, the pot should be no more than one-quarter full. The sulphur, equal to 60% of the caustic soda, dissolves in a few minutes. The sodium sulphide thus made is poured into molds where it solidifies. For use, it is dissolved in water. The amount of hypo salt consumed is 2 to 4½ lb. per ton of ore.

Treatment of the precipitated sulphide. After filter-pressing, the damp precipitate is molded into cakes. For drying, these are placed in a reverberatory furnace, 16 by 6.5 ft. hearth dimensions, with a small grate. The drying must be done at a moderate heat, such that the flame shall not come in contact with or ignite the sulphides. The dried precipitate will contain 18 to 35% of silver. Following we give an analysis of dried sulphides from the Marsac mill, Park City, Utah:

Ag	(11,360 oz. per ton).....	34.78%
Au	(12.6 oz. per ton).....	0.04
Cu	21.60
Pb	0.50
Fe	0.75
Sb	0.18
Al ₂ O ₃	0.25
SiO ₂	0.25
S.	20.74

This dried sulphide is generally sold to smelting works where it is treated as follows, to obtain the silver:

It is gradually brought upon the hearth of an English cupelling furnace (see Fig. 152), where it is roasted and the silver taken up

by the molten lead-bath. The other metals enter the litharge, which, as usual, is continuously forming and flowing from such a furnace. The litharge is sent to the blast-furnace, since it contains some of the silver, but the bulk of the silver goes into the lead-bath. When all the sulphide has been treated, the lead in the test or hearth is cupelled off, leaving the molten silver ready for molding into bars.

The extraction or yield of silver by the Patera process is 70 to 90%.

At Sombrerete and at Cusihuiriac, Mex., the Russell process has been given up for the Patera process. At the former place the ores contain galena (9 to 10% Pb) blende, copper and iron pyrite, and a silicious gangue together with silver sulphides, the ore having 41.9 oz. Ag per ton. The ore loses in roasting 4.8% and the extraction, figured on the raw ore, is 82.5%.

The cost of treatment per ton is:

Crushing	\$1.36
Roasting and salt (6%).....	2.68
Labor in leaching.....	0.27
Chemicals	0.30
Superintendence	1.02
Heating, lighting, pumping and repairs.....	0.08
	<hr/>
Cost per ton.....	\$5.71

46. THE RUSSELL PROCESS.

The Russell process is a modification of the Patera process. This modification consists principally in the use of another solution in addition to the hypo solution used in the latter for the extraction of the silver. By mixing in solution two parts of the hypo salt with one part of copper sulphate, we obtain a double salt, $\text{Na}_2\text{S}_2\text{O}_3$, $\text{Cu}_2\text{S}_2\text{O}_3$, called the extra solution, which has nine times the solvent power for native silver, for silver sulphides, and for silver arsenides and antimonides that the ordinary hypo solution has. In the case of an imperfectly roasted ore, the use of the extra solution ensures the extraction of an

additional amount of silver from the just-named compounds, which could not have been gotten out by the ordinary solution.

Referring to the diagram, Fig. 93, and to the practice at the Marsac mill, Park City, Utah, the process is conducted as follows: The ore contains 76.6% SiO_2 , 1.65% Fe, 1.32% CaO, 0.23% MgO, 3.5% Pb, 0.39% Cu, 5.3% Zn, 0.7% S with 37.3 oz. Ag and 0.049 oz. Au per ton. The ore, mixed with 8.9% salt, is stamped dry through a 30-mesh screen, each stamp having a capacity of 2.33 tons daily. The ore is submitted to a chloridizing roast in a Stetefeldt furnace, having a capacity of 70 tons daily, and able to convert 92.4% of the silver into chloride.

After roasting, the ore is charged into a leaching tank such as already described in the Patera process, 17 ft. diam. by 9 ft. deep and capable of holding 72 tons. In this tank it is treated with a wash of water, using 18 cu. ft. per ton of ore, the water percolating through it at the rate of nearly 4 in. per hour. This solution passes then to the base-metal precipitating tank, where the base metals were thrown down as sulphides by the addition of sodium sulphide. The precipitate contained on an average 4.2% Pb, 3.9% Cu, 4,800 oz. Ag, and 2.7 oz. Au per ton, and was sold to the smelter.

The ore is next treated with a 1.5% hypo solution, by which a greater part of the silver is extracted, the solution going to the lead-precipitating tank. This work takes 87 hours. Now comes the 'extra' solution consisting of 0.75% copper sulphate, CuSO_4 , 5 H_2O and 2.25% of the crystallized hyposulphite $\text{Na}_2\text{S}_2\text{O}_3$, 5 H_2O , by which a further amount of silver is taken out, being those undecomposed sulphides unattacked by the ordinary solution. This operation takes 27 hours, the filtrate being also run to the lead-precipitating tank. In this tank lead carbonate, insoluble in hypo solution, is precipitated, using 5 lb. of sodium carbonate per ton of ore treated, according to the reaction: $\text{Na}_2\text{CO}_3 + \text{PbCl}_2 = 2\text{NaCl} + \text{PbCO}_3$. This precipitate contains, on an average, 32% Pb, 1,000 oz. Ag and 1.2 oz. Au per ton.

After settling, the supernatant liquor is transferred to the silver precipitating tank, and the residue in the tank is sent to the filter-press. The precipitated lead carbonate is sold to the smelting works, while the filtrate is stored, to be sent later to

the silver precipitating tank. The solution in the silver precipitating tank is now treated with just enough sodium sulphide to bring down the silver as in the Patera process. The precipitated silver sulphide contains on an average 25% Cu,

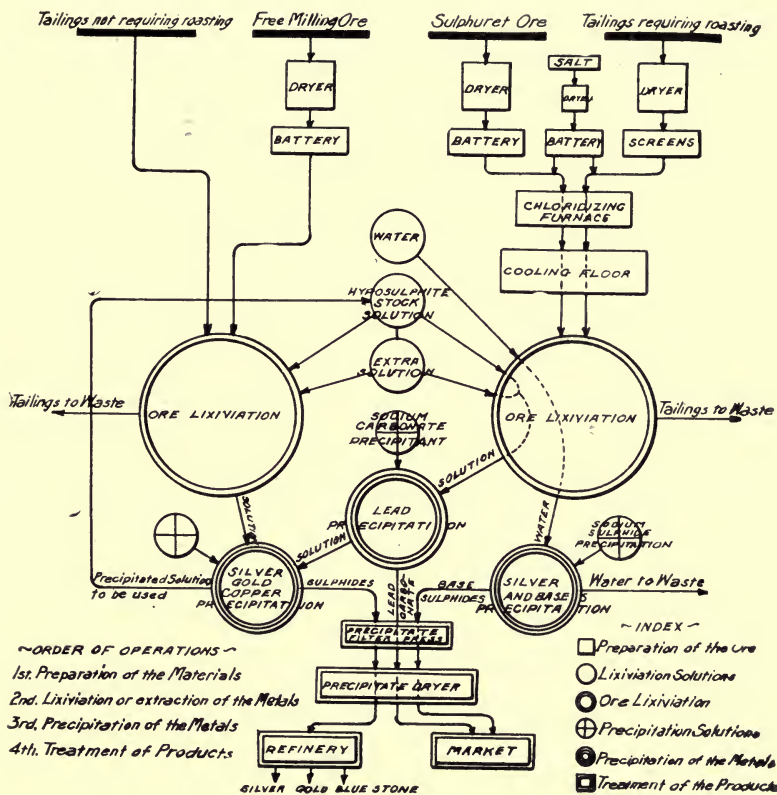

FIG. 93. FLOW-SHEET FOR RUSSELL PROCESS.

40% or 11,700 oz. Ag, and 11.6 oz. Au per ton. It is transferred to the filter-press where the solution is removed, and, together with that from the tank, is returned to the stock-solution tank to be used over again. Thus the filter-presses and dryer take care of the base-metal precipitates, the silver precipitate and the precipitated lead carbonate. The precipitate is dried and sacked, being then sold to the smelter, and worked up by them in the

English cupelling furnace as already described (see Fig. 155). The costs by the Russell process, based upon an output of 100 tons ore daily, may be given as follows:

Crushing and roasting.....	\$4.62
Labor in leaching	0.83
Tools, light, pumping and heating.....	0.12
Chemicals	0.92
Repairs and superintendence.....	0.18
Assaying	0.08
Treatment of out-products.....	0.10
	\$6.85

The extraction is 85%, the proportion of silver obtained being,

In base-metal sulphides.....	6.2%
In lead carbonates.....	2.6
In silver precipitates.....	75.7
In mill cleanings.....	0.5
	85.0

The Russell process has proved successful in exceptional cases only. We have already alluded to its having been given up in two places in Mexico, while elsewhere failures have occurred. Compared with the Patera process the cost of the chemicals is greater (92c. against 42c.), the plant is more complicated, and greater skill is needed to work it. It can, of course, be applied to raw oxidized ores or to those which have an ordinary dead roast, and although the yield of silver is greater when the extra solution is used, yet this is offset by the consumption of copper sulphate. In presence of much galena and zinc blende, the extra solution seems to extract the silver no better than the ordinary solution. Nor does the process work well in presence of much lime, being too slow and consuming much copper sulphate.

47. THE LEACHING OF ARGENTIFEROUS MATTES.

In order to extract the silver from such mattes, which also carry silver, two different processes have been used, the Augustin and the Ziervogel. In both methods the principle consists in

bringing the silver in soluble form, either as the chloride or the sulphate, and then leaching it out with a suitable solvent, the silver being precipitated in presence of metallic copper.

The Augustin process.—The matte is crushed, roasted with salt to form silver chloride, leached with brine to extract the silver, the silver in the brine solution precipitated on plates of

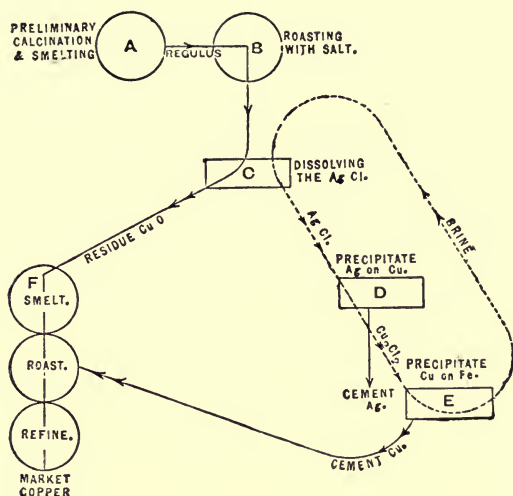

FIG. 94. FLOW-SHEET FOR AUGUSTIN PROCESS.

copper, and the copper, in the clear decanted solution, precipitated by scrap iron.

The Ziervogel process.—At the Boston and Colorado smelting works at Argo, Colo., the process is used upon copper mattes comparatively free from arsenic, antimony or bismuth, all of which tend to form insoluble compounds with silver. It is performed as follows:

The matte is made in reverberatory furnaces from ores containing gold, silver and copper and is cast in sandbeds. Its composition is 47.3% Cu, 8.1% Pb, 2.7% Zn, 17.7% Fe, 21.6% S with 400 oz. of Ag and 10 oz. Au per ton. It is crushed and rolled to 6-mesh, and then sent to a Pearce turret roasting furnace where it receives a preliminary roasting at a low heat, removing the sulphur down to 6.3%, and converting iron and copper to oxides

and sulphates (see Chemistry of Roasting). The partly roasted matte then goes to Chilean mills where it is finely ground to 60-mesh.

It is now treated in charges of 1,600 lb., to a sulphatizing roast in small single-hearth reverberatory furnaces. In the process, the remaining sulphides are converted to sulphates, and, at a little higher heat, the copper sulphate begins to decompose so that no more than 1% is finally left. In so doing the sulphuric anhydride evolved acting powerfully on metallic silver, transforms it to the state of sulphate. It has been found that the addition of 2% sodium sulphate (salt cake) greatly accelerates this change. The roasting occurs in four stages:

At the first stage, with the draft checked and the working doors open, the charge is kept at a low temperature for 1.5 hours. It becomes heated evenly throughout and glows from the oxidation of Cu_2S to Cu_2O . At the second stage, during 1.5 hours, the heat is slightly increased while the charge is constantly rabbled. Sulphate of iron is decomposed and CuSO_4 is formed. The charge swells, and becomes porous and spongy from the formation of this salt. In the third stage, for an hour the temperature is again increased, until tests show that the silver is 'out,' that is, in the condition of sulphate soluble in water. During this stage the copper sulphate, decomposing, transmits its SO_3 to the silver compounds, forming sulphate. At the fourth stage, with the temperature constant, the charge is gathered together and bruised down with a heavy paddle to break up the lumps, and it is then vigorously stirred to oxidize any remaining Cu_2O to CuO , and to decompose nearly all the copper sulphate. This temperature is not further increased, since it would have the effect of decomposing the silver sulphate to Ag_2O , thus again making it insoluble.

The progress of the roasting is tested by putting small samples from time to time in hot water and bringing the soluble sulphates in solution. Early in the third stage it becomes deep blue; and later, as the silver sulphate begins to form, it is immediately reduced to silver spangles by the cuprous oxide present. As the stage proceeds, and the copper sulphate is decomposed, the solution becomes less blue and the silver spangles increase and

then diminish. During the fourth stage the Cu_2O is changed to CuO , and the spangles disappear, while a light blue color still remains, due to a little copper sulphate still remaining, which indicates that the silver sulphate is not itself becoming decomposed.

(A sample thus roasted, but at another works, and containing 246 oz. silver, showed by analysis 2.5% $\text{Fe SO}_4 + \text{Zn SO}_4$; 0.6%

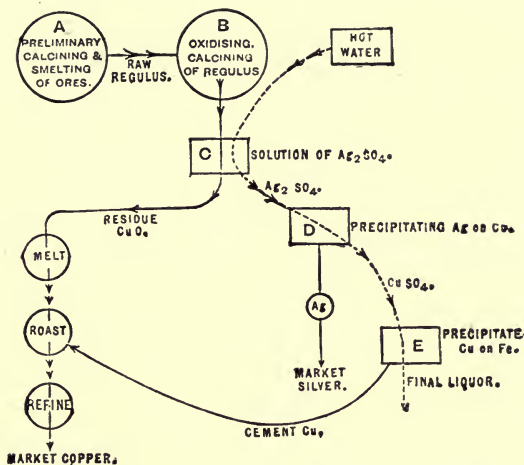

FIG. 95. FLOW-SHEET FOR ZIERVOGEL PROCESS.

Cu SO_4 , and 1.0 AgSO_4 , or of silver 213.9 oz. per ton. There was left, therefore, in the ore 32.1 oz. or 13% of the silver in insoluble form.)

Leaching.—This is performed in tubs or tanks, each holding 1,000 lb. of matte, and furnished with filter bottoms. The copper-bearing solution goes through a series of vats containing copper plates upon which the silver precipitates. The silver-free solution containing copper then goes to tanks containing scrap iron where it is precipitated.

The cement silver from the precipitating vat is next transferred in charges of 3,000 oz. to a tub where dilute sulphuric acid (1 to 100) is added, and it is boiled by forcing in a mixture of air and steam from an injector. The air oxidizes the copper, still retained in the precipitate, to CuO which is dissolved by the acid,

while the steam keeps the solution boiling. In two or three hours the whole of the copper has been dissolved. The copper sulphate solution is drawn off, and the precipitate repeatedly washed with hot water until quite free from copper. It is then transferred to, and dried, in a long pan set over a coal fire, and, after drying, melted down in a wind furnace into ingots of 999 to 999.5 fine.

Residues from the leaching tanks or tubs.—These, still containing one-tenth of their original silver, say 40 oz. per ton, all the gold (10 oz. per ton) and the copper as CuO, are sent to a reverberatory furnace where, together with rich ore both silicious and sulphide, they are melted together to a matte. The slag from the treatment goes back to the ore-smelting furnace, while the matte, which has been tapped into sand molds, is sent to another reverberatory furnace to be treated according to the English method of making 'Best selected copper.' Here the pigs of matte are piled up near the bridge of the furnace and are slowly roasted and melted down under the oxidizing action of the flame and air. The copper oxide formed in the 'roasting,' reacting upon the matte, forms copper according to the reaction.

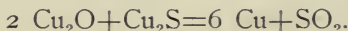

It is aimed to carry on the oxidation of the copper, so that the amount formed will give one part of copper to fifteen of matte. The matte is now tapped from the furnace into sand-molds, and, in the first molds, will be found the plates of copper overlaid with the matte. These bottoms have carried down with them the impurities, as arsenic, antimony, lead and bismuth, together with practically all the gold (100 to 200 oz.), and some of the silver. On the other hand, the matte has risen to the stage of white metal of 75% copper, still holding 90 to 100 oz. Ag per ton, but not more than 0.2 oz. of gold, and is sent to be again treated by the Ziervogel method, its roasting, however, being done in separate furnaces from that of the first-matte. The residues, after this second treatment, are principally copper oxide containing but 10 oz. Ag per ton, and are sold to the oil refiners. At the Argo works, the bottoms, heretofore treated for the extraction of the precious metals by a secret process, could be more profitably treated by electrolytic refining.

48. CYANIDING SILVER ORES.

Silver ores carrying some gold and in which the silver occurs not only as native silver, but as chloride, argentite and stephanite, have been more or less successfully cyanided. Thus at Chloride Point, Utah, where the silver occurs as chloride, the extraction averages 71%; at the Palmarejo mine, Chihuahua, Mex., the extraction is 54% of the silver and 96% of the gold; and, at El Salvador, Mex., 85 to 90% of the silver and 90 to 92% of the gold is recovered.

The main points in cyaniding silver ores are these:

1.—That a comparatively long time is needed, usually 10 to 25 days, since silver compounds are more difficultly soluble than gold.

2.—Thorough oxygenation is necessary, due, not only to the larger quantity of silver to be dissolved, but also to the fact that the silver compounds need to have, at least, initial oxidation to make them more soluble in cyanide solution. To insure this, double treatment is necessary, that is, the ore, after having been leached in one vat, is shoveled out into another where the treatment is repeated. In so doing, it becomes thoroughly exposed to the air. Also, if the solution is allowed to sink several inches below the top of the charge before fresh solution is run on, the air is drawn down and permeates the ore. In the slime treatment, of course, the pulp may receive thorough aeration by agitation with air.

3.—Stronger solutions must be used than in the treatment of gold ores. The first, or strong solution, may be 0.7%, and the weak solution 0.25%, while, for gold, a 0.25% solution would be the strong, and 0.05% a suitable weak solution.

4.—The consumption of potassium cyanide is higher than in the case of gold ores. It varies from 2.5 to 4 lb. per ton compared with 0.4 to 0.8 lb., consumed for gold ores.

5.—The precipitation of silver by zinc shavings presents no difficulty and is practically complete; and despite the fact that relatively so much silver is precipitated as compared with gold, no more zinc is used up.

PART V. IRON

PART V. IRON.

49. PIG IRON—ITS MANUFACTURE IN THE BLAST-FURNACE.

The three kinds of ores used in making pig iron are carbonates, magnetites and hematites.

(1) Carbonate ore (FeCO_3), spathic iron, black-band, clay-band or clay iron-stone contains 48.3% Fe when pure. It is often roasted to drive off the CO_2 before going to the blast-furnace. In England it is the principal ore used, but in the United States, though widely distributed, it is too low grade to be used in competition with richer ores. (2) Magnetite (Fe_3O_4) contains 72.4% Fe when pure. It is a valuable source of iron, there being deposits of it in New York, Pennsylvania, New Jersey and Michigan. The New York beds occur in the Lake Champlain district, and on account of the presence of titanium have been considered valueless, it having been asserted that the titanium produces an infusible slag. This, however, has been proved an error, and in future the metallurgist need not be deterred by such a fear from using titaniferous ores. In Pennsylvania the Cornwall deposits are the most important, and can give a pig iron of not more than 0.04% P, but the ore (containing 2.5% S) should first be roasted. The copper in the ore is the most objectionable element and will be found in the pig to the amount of 0.5 to 0.75%. This is unobjectionable in the finished material, but it produces hot-shortness and many imperfections in the rolling. In New Jersey occur extensive beds of low-grade silicious hematite which have been utilized by Edison in the production of iron ore on a commercial scale. He has mined, crushed and concentrated the ore and made it into briquettes which contain as little as 3.3% SiO_2 0.04% P, and as high as 67% Fe. It is doubtful, however, whether the enterprise can be carried on at a profit in competition with foreign ores. (3) Hematite (Fe_2O_3) contains, when pure, 70% Fe. It occurs as specular

hematite, having a black, hard, shining look, or combined with more or less water, having a reddish-brown or yellowish-brown color. It is customary to speak of the higher grade ores as red or brown hematites, and of the more hydrous ones, as soft hematites or limonites. Strictly speaking a limonite is a bog-iron ore containing over 20% H_2O . However, the other nomenclature has the sanction of custom.

50. IRON BLAST-FURNACE.

Fig. 96 is a sectional elevation of a blast-furnace in which coke is used as a fuel. Beginning at the bottom we have a heavy foundation (1) upon which is carried the hearth (15) and the columns (4) which support the upper brick work constituting the shaft of the furnace. The hearth (11 ft. diam. by 9.5 ft. high) to contain the molten iron and slag, extends from the foundation to just above the tuyeres (22). It has a bottom and sides of fire-brick, and, at its lowest interior point, an iron tap (27) whence the molten pig iron is withdrawn when a quantity has accumulated. At (24) is shown the cinder notch by which the slag or cinder is tapped off. The crucible is surrounded by a hearth-jacket (26) of steel, cooled on the outside by sprays of water playing against it, and thus withstanding the corrosive action of the molten slag upon the brickwork. Air, under a pressure of 5 to 14 lb. to the square inch, enters at the tuyeres (21), and care must be taken to withdraw the slag before it can rise to this level. This air is supplied by the tuyere-stock (33) from the bustle-pipe (13), which surrounds the furnace and connects with the main supply pipe, which brings the air to the furnace. Proceeding upward from the hearth, the furnace widens out for 22 ft. at the level of the mantel (5), the top of the supporting columns, where it is 23 ft. diam., this expanding portion being called the bosh. In this region or zone occurs the formation of slag, so that the brickwork of the bosh is subject to a slagging or scouring action. To prevent this, water-cooled bosh-plates (14) are laid into the brickwork all around the furnace at every 18 in. to 2 ft. apart vertically. Beginning from the top of the bosh and extending to the throat of the furnace (9) we

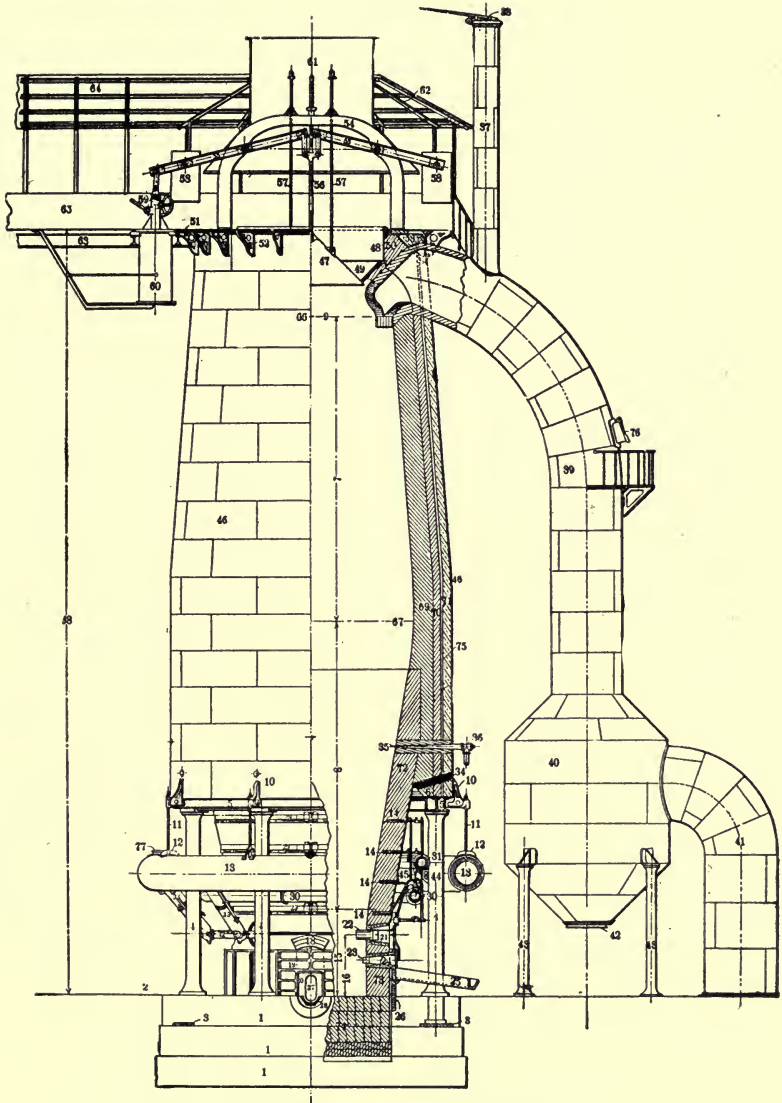

FIG. 96. IRON BLAST-FURNACE.

have the shaft. This is supported by the mantel beams which rest on the columns (4).

The upper part of the furnace is closed by a bell (47), and has at the side an outlet for the escape of the smoke. The inwall (69) of the stack is of fire-brick, while the main portion of it is built of common brick. It is sheathed with a steel shell (46). When in operation, the furnace is filled to just below the outlet part of this level, it being known as the stock-line, and here the furnace is 15 ft. diam. As the stock sinks charges are put in, to keep the stock-line at this level. The total height of the furnace is 80 feet.

Ordinarily the top of the furnace is kept closed by the conical bell (47), which is suspended from the ends of the counter-weighted beams (55). The bell closes the bottom of a circular hopper (48) into which the charge is dumped. At the moment of charging, the outer end of the lever is raised by a piston working in an air cylinder (60), the bell is lowered, and the charge slides into the furnace, and the bell is again closed. In this interval gas and flame escape from the furnace, but, in general, the gas passes off by the down-comer (39) to the dust-catcher (40) and thence by the goose neck (41) to the underground flue which leads to the stoves and boilers, where the gas is burned. On top of the down-comer stands the bleeder (37), by which the gas may be let off when it is desired to relieve the top pressure due to the escaping gases. It is occasionally used.

At many furnaces, the stock or materials of the charge is raised in hand-barrows or buggies to the furnace top or tunnel-head (51) by means of vertical platform hoists. A more recent arrangement consists in the use of a mechanical charging apparatus shown in Fig. 97. A double bell is here used, by which the escape of the gases is avoided. The charge is dropped from the skip into the upper oval-shaped hopper where it is retained until the lower hopper is empty. The smaller upper bell is now emptied into the lower hopper, and is closed to receive another charge. The charge in the lower hopper is dropped when needed by lowering the large lower bell. It slides largely to the walls, the stock at the middle being a little lower and coarser than at the sides. The charging of the skip (of which there are two, run in

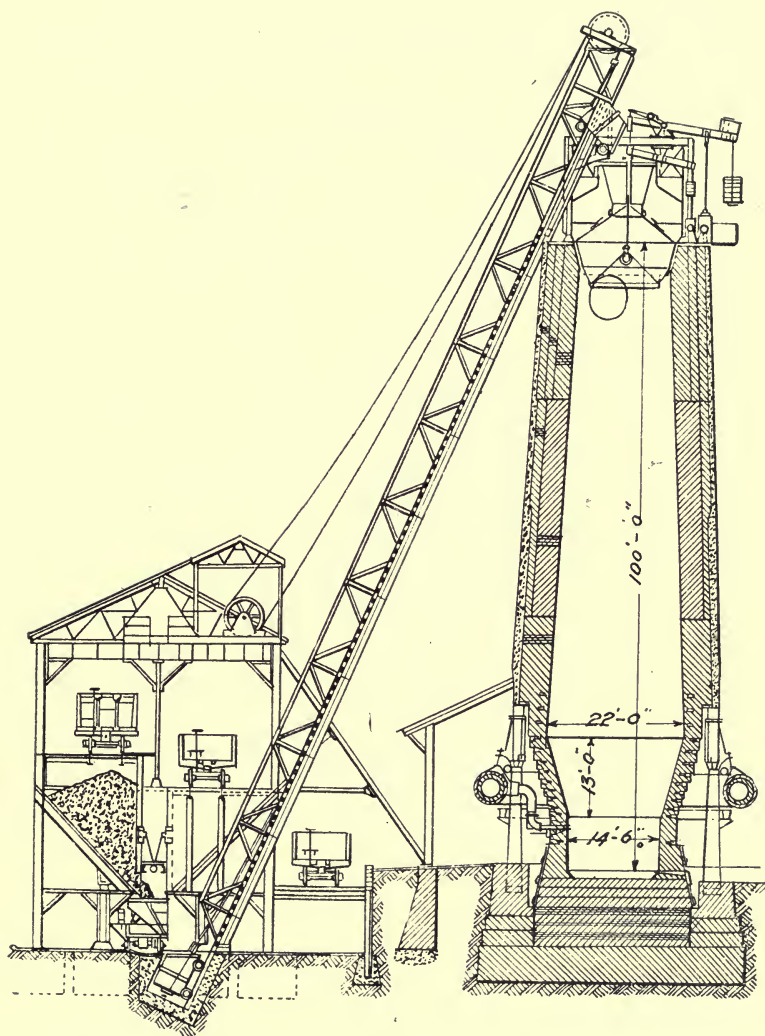

FIG. 97. IRON BLAST-FURNACE WITH AUTOMATIC CHARGING.

balance) is thus performed. Iron ore, limestone and coke come in by an overhead track and are delivered to sloping-bottom storage bins. A charge-car, electrically driven and with a weighing attachment, can be brought to any bin and there receive a weighed amount of ore or coke. The loaded car is then trans-

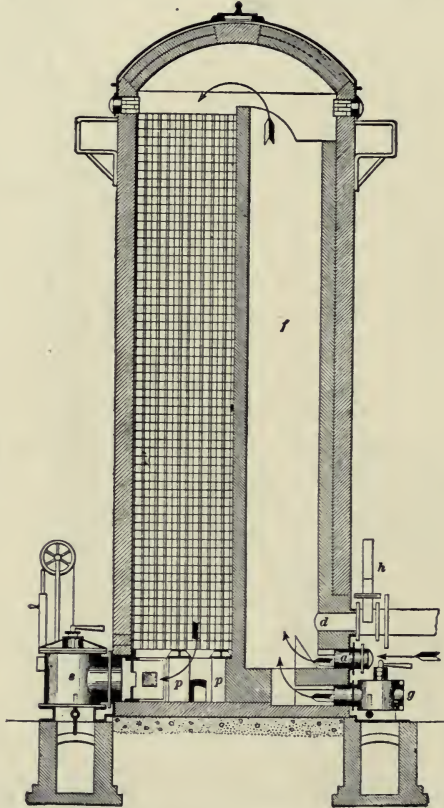

FIG. 98. COWPER HOT-BLAST STOVE (ELEVATION).

ferred to, and discharged into, the skip. In case of accident to the charge-car, or any other trouble at these bins, the furnace can still be kept going by the use of hand-barrows or buggies, taking the stock from piles which have been made beneath the track at the right. Hoisting is effected by a hoisting engine set well out of the way at the top of the stock-house.

51. THE STOVES.

For the most efficient operation of an iron blast-furnace it is necessary that the air blown into it should be heated, generally from 500 to 750° C. To accomplish this, a furnace is equipped with three or four regenerative fire-brick stoves, say 80 ft. high and 14 ft. diam., of which Fig. 98 and 99, called the Cowper stove, is an example. It consists of a tight steel shell, lined with fire-brick and containing a checkerwork of specially shaped brick, having frequent openings or passages from top to bottom of the stove. The gases from the blast-furnace, containing, say 24%

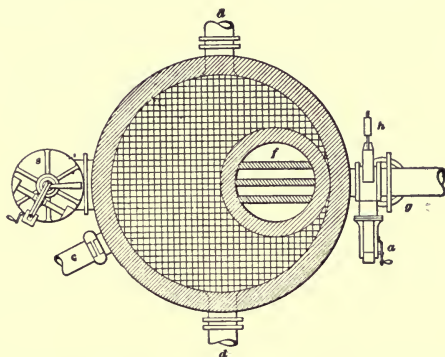

FIG. 99. COWPER HOT-BLAST STOVE (PLAN).

CO, flowing along an underground flue from the goose-neck of the dust-catcher enter at *g*, while air is admitted at *a*, the two burning in the flue *f*, and heating it and the checkerwork in their passage downward to the valve *s*, and thence, by an underground-flue to a tall stack 200 ft. high. The stove, having been heated, the valves at *g*, *a* and *s* are closed and the cold-air valve *C* admits air under pressure from the blowing engine, the hot air valve *d*, at the bottom of the combustion chamber, being at the same time opened. The air, flowing through the checkerwork, becomes highly heated. Meanwhile the gas has been turned into the other stoves, and is heating them up in the same way. When the first stove has received the blast for half an hour, it is turned into the next just-heated stove and so on. The extended surface of the checkerwork serves to absorb a large amount of heat from

the burning gases, and to give it up subsequently to the blast. It will be noticed that the air enters at the coolest and leaves at the hottest part of the stove, thus insuring the maximum rise in temperature. In the course of the half hour the hot air has dropped 100° C in temperature, at least.

52. BLAST-FURNACE PLANT.

Fig. 100 represents a modern blast-furnace in process of construction, showing the forked down-comer with its bleeder, and the upper portion of the dust-catcher; also the inclined hoist. There are four stoves, each as high as the furnace itself. Immediately back of the stoves is to be seen their stack. At the right of the picture may be seen the steel frame of the double vertical hoist or elevator of an older and lower furnace, together with two of the stoves belonging to it.

53. OPERATION OF THE FURNACE.

The ore is dumped into the furnace with 50 to 65% of its weight of coke, and the limestone needed to form a predetermined slag. The furnace should be at least 65 ft. high, and is now commonly built 80 to 100 ft. high. It is kept full of stock, and the combustion of the coke is kept up by the introduction of the blast at a high pressure at the tuyeres. The constant tapping off of the liquid products (slag and iron), and the constant addition of fresh stock, prevent the heat from spreading upward as it might otherwise do.

The actual melting zone extends several feet above the tuyeres. At about 4 ft. from the tuyere opening, where it enters the furnace, the most intense combustion occurs, and here with abundant access of air, the coke gets first burned to CO_2 while in the immediately adjacent zone the CO_2 may be regarded as being changed to CO . This latter operation dissolves carbon out of the coke, thus lessening its quantity; and the reaction, being endothermic, lessens the intensity of the heat. The upward-passing gases are CO and N . Now, we must remember that the FeO , reduced above from Fe_2O_3 , and even unreduced ore where it has run the



FIG. 100. IRON BLAST-FURNACE.

gauntlet of the CO, are brought directly in contact with the glowing coke, and reduction is completed.

The CO, rising through the furnace, reduces FeO to Fe or spongy iron. On reaching the lower part of the furnace, the spongy iron with carbon becomes pig iron, the carbon forming a carbide of iron containing 3 to 4% C. The iron also absorbs silica, phosphorus and sulphur from the earthy ingredients of the charge.

From the point of view of the ideal metallurgical process we thus have, in the blast-furnace:

Zone of Preparation. CO₂ and moisture driven off.

Zone of Reduction. The iron reduced to FeO and then to Fe.

Zone of Fusion. Slag formed; the iron, as a carrier or collector, taking up C; Si; P; and S.

In addition to the coke and the ore there is limestone. In the upper third of the furnace the CO₂ of the limestone is expelled, leaving CaO. The action is endothermic and has its advantage in lowering the temperature of the upper part of the furnace. The quantity of limestone to make a proper slag, and lime enough to remove S, is calculated in advance.

The gases from the furnace are about as follows:

$$\text{Temperature } 260^{\circ} \text{ C.} \dots \left\{ \begin{array}{l} \text{CO} = 24\% \\ \text{CO}_2 = 16\% \\ \text{N} = 60\% \end{array} \right.$$

and are used for burning in stoves and under the boilers. Formerly the air was heated in iron pipe stoves, but today the regenerative stoves of brick are used.

In the foregoing descriptions it has been assumed that coke is the fuel employed, and this is true in the majority of cases. Anthracite coal has been used for economic reasons, but even then more satisfactory practice is attained when coke forms part of the charge. Such furnaces are called anthracite furnaces, but such a name is somewhat misleading. Some furnaces use charcoal exclusively, since this fuel is supposed to give an iron of great toughness, particularly valuable in making cast-iron car wheels, and other articles where toughness is required. Its superiority over other irons of similar chemical constitution has

been widely disputed, but there is much testimony in favor of charcoal-iron.

Twenty-five years ago the practice of blast-furnaces was regulated by rule-of-thumb methods, "born of a bigoted belief on the part of ignorant furnace-men that particular ores and fuel could be worked in a furnace only on certain special lines, and that it was impious to drive a furnace faster than a certain rate established by time-worn tradition." In 1879 certain experimental work, instituted at the Edgar Thompson steel works, Pittsburg, showed that it was possible to increase the output of a furnace enormously by increasing the air supply. It was also found that the amount of air, not the pressure, determined the speed.

Under this new system it was thought necessary to make a steep angle bosh of 80° , but, with the more rapid driving, reduction fell off; or rather, to get reduction, the fuel had to be kept high (one ton of coke to one ton of pig iron) and, where coke was expensive, this was a serious matter. Mr. E. C. Potter, of Chicago, however, showed that by reducing the bosh angle to 75° and by using somewhat less blast, it was possible to cut the coke consumption considerably (from 2,240 down to 1,800 or to 1,750 lb.). Larger furnaces were then built with a larger hearth, which also increased capacity.

54. MANAGEMENT OF THE IRON BLAST-FURNACE.

Blowing in.—The furnace is first dried out by a wood fire in the crucible for several days. The lower part, half way up the bosh, is filled with cord-wood, then follows a heavy bed of coke with some limestone to flux the coke ash. This is followed by successive layers of the normal charge of coke with charges of gradually increasing amounts of ore and limestone and decreasing amounts of slag, until, at last, the normal charge of ore and flux has been reached. The furnace is then lit at the tuyeres, and a weak blast put on, the pressure being gradually increased for 24 hours until the regular pressure is reached.

Regular running.—Ore flux and fuel (called collectively 'stock') is brought in buggies from the stock-house to the scales,

weighed, hoisted to the top of the furnace and dumped automatically into the hopper, or wheeled by 'top-fillers' to the bell and dumped. Fuel is dropped by itself, the ore and stone (flux) together. The level of the charge is kept just below the outlet for the down-corner. The temperature of the blast (550 to 750° C) is kept constant, as well as the volume of the blast, by regulating the revolutions of the engine. The slag is tapped, say every two hours, the iron every four to six hours. If the metal flows from the runner into the molds or depressions of the sand-bed, it is cooled down by water, and while hot broken by sledges, transferred to cars or trucks and stacked in the pig-metal yard until cold. Here it is broken and assorted according to fracture or by analysis. If the metal is collected in ladles, a switching engine takes it to the casting machine.

Blowing down.—When a furnace is to be put out of blast, charges are stopped and a layer of coke put in. The materials gradually descend, and this is kept up as long as the iron and cinder will flow out, the blast being gradually diminished, until finally it is stopped altogether and the remaining contents of the furnace withdrawn by a hole broken through the brick work at the bottom.

55. IRON SMELTING.

The air entering the tuyeres need be sufficient to burn the fuel only to CO, according to the reaction:

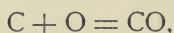

giving 29,000 lb. calories or 2,415 per lb. of carbon and using up $\frac{O \times 12.38}{0.23 \times C} = 72$ cu. ft. air, or per pound of coke of 85% carbon, 61 cu. ft. of air. The usual way of measuring the amount of air that enters the furnace is to calculate the cubic displacement of the pistons of the blowing engines, but this is not accurate, since it makes no allowance for leakage and imperfect action of the valves, or for clearance. With this allowance we find 65 to 70 cu. ft. of free air needed per pound of fuel. On Lake ores, where 1,600 to 2,000 lb. of coke are needed per long ton of pig iron, this will be 112,000 to 140,000 cu. ft. of air, or, for a furnace of 400 tons

capacity, 31,000 to 39,000 cu. ft. per minute. In rising through the furnace, part of the CO is oxidized to CO₂ by reaction on the ore; and the limestone evolves more, so that the tunnel-head gases, with a consumption of 1,900 lb. per ton of pig may have a composition 14.5% CO₂, 27.0% CO and 58.5% N, or a ratio of

$$\frac{\text{CO}}{\text{CO}_2} = 1.88$$

Of this gas, one-third is used to heat the stoves, the remainder being mostly utilized for producing steam at the boiler for the blowing engines. Since the efficiency of the engine is no more than 10% of the total heat delivered to it, the gas-engine, using the furnace gas, and having an efficiency of 30%, has been proposed in place of the steam-engine. This would leave a surplus of gas available for giving power for other purposes about the works, but the initial cost of installing such a power plant, and mechanical difficulties in its operation, have heretofore stood in the way of introducing it to any great extent.

56. THE CHEMICAL REACTIONS OF THE IRON BLAST-FURNACE.

A blast-furnace may be regarded as an immense gas-producer, in which there is a column of coke (mixed with the iron ore and limestone) 70 ft. high, varying in temperature from a white-heat at the tuyeres to a black heat at the tunnel-head. As soon as the hot air of the blast, entering at the tuyeres, strikes the white-hot coke there is an immediate formation of CO₂, followed by its instantaneous reduction to CO. Fig. 101 shows graphically the amount and progress of the reactions, while the temperatures and heights, at which the reactions take place, are shown at the section of the furnace at the extreme left of the diagram. To produce a ton of pig iron (2,240 lb.) there is to be used 3,520 lb. of 60% iron-ore containing 3,020 lb. Fe₂O₃, 1,388 lb. of coke and 1,010 lb. limestone. At the tunnel-head, the ore (Fe₂O₃) is plunged into an atmosphere containing 24% CO, 16% CO₂ and 60% N at a temperature of 260° C; and there is immediately a reduction of part of the ore Fe₂O₃ according to the slightly exothermic reaction.

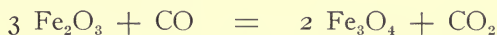

$3 \times 199,400$ $29,000$ $2 \times 265,800$ $97,000 = + 11,400$ Cal.; this reaction increasing, and being completed by the time the ore has reached a depth of 10 ft. and at a temperature of 450° C (see section 2). During this period begins that peculiar reaction of carbon-deposition, by which the gases react on the ore and deposit carbon throughout its pores. This mixture descends through the furnace and appears in the pig iron to the extent of say 4% of its weight.

Continuing its descent, by the time it has reached a depth of 19 ft. and a temperature of 580° C, the just formed Fe_3O_4 becomes changed to FeO (see column 3) as follows:

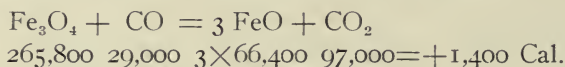

The FeO , thus formed, impregnated with carbon, descends with little change until, at a temperature of 700° C, the CO gas reacts upon it and spongy iron begins to form, the reaction being complete when the temperature has reached 800° C and at a depth of 32 ft.

The reaction is thus expressed:

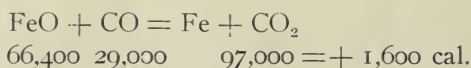

At this same temperature, the limestone, accompanying the iron ore, by the expulsion of its combined CO_2 , has been converted into quicklime, and this latter, at the zone of fusion, will unite with and flux the silicious portion of the charge. From this depth of 29 ft. just mentioned and to the depth of 19 ft. or 550° C, the CO_2 evolved from the limestone, reacting on the coke, dissolves some of it according to the reaction



absorbing heat from the charge and consuming coke. However, the coke remains but little changed until it reaches the region of the tuyeres, as is shown in column (6) of the diagram Fig. 101.

From the point of 32 ft. and of 800° C reactions have practically ceased, the chief one now being a reduction of a small

amount of FeO, left decomposed by the CO. This is gradually reduced as follows:

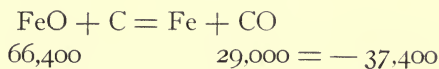

The temperature now rises gradually and uniformly until the intense combustion at the tuyeres brings it to a maximum of at least 1,500° C. Of the two gases which enter the furnace, nitrogen comprising 77% of the whole is by far the largest constitu-

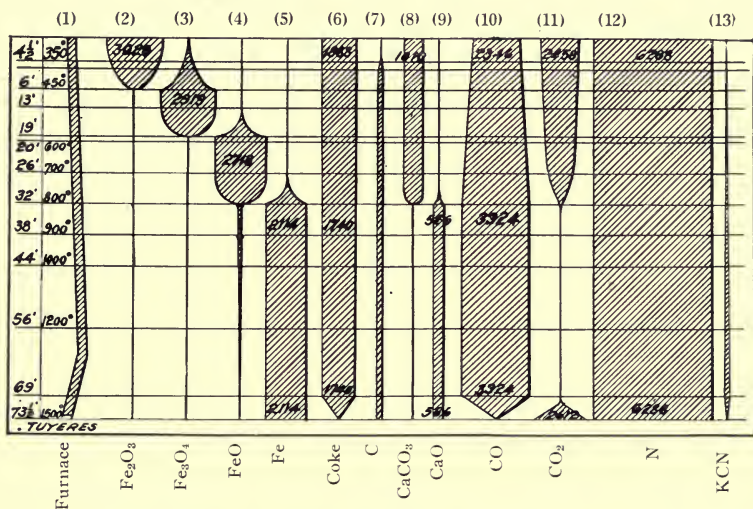

FIG. 101. CHEMICAL REACTIONS OF BLAST-FURNACE.

ent, or indeed the largest single ingredient column as shown by 12 of the diagram.

Studying closely columns 10 and 11, we may note that the CO₂, formed so freely at the tuyeres, is at once changed to CO, the glowing coke being dissolved by the CO₂. The carbon monoxide rises unchanged, until it begins to act on the iron oxides at the 32-ft. level with the formation of CO₂. This, united to that evolved from the limestone, forms the total of escaping CO₂ gas.

It must be observed that the temperatures and heights are here given as a definite problem, but the quantities vary with every furnace, and even in the same furnace.

57. CALCULATION OF IRON-BLAST FURNACE CHARGE.

The accompanying charge-sheet illustrates the method of estimating a charge for an iron blast-furnace, producing a pig iron and a slag of a certain assumed composition. It is desired to smelt lumpy Maxwell ore with the fine Mesaba, which, alone, would give too compact a charge for smelting. The pure Mesaba would make too little slag to absorb the sulphur; hence it is better to mix with the Mesaba a certain amount of the silicious

CHARGE SHEET

Name of Ore	Weight				SiO ₂		Fe		CaO & MgO		S.		Al ₂ O ₃		
	H ₂ O	Wet	Dry	%	Wt.	%	Wt.	%	Wt.	%	Wt.	%	Wt.	%	
Mesaba No. 1552	6.0	1060	1000			4.0	40	60.0	600			*		1.0	10
Maxwell No. 27	3.0	1030	1000			18.0	180	50.0	500	1.0	10	0.8	8	2.8	28
Limestone	"	600	600			3.0	18			53.0	318			0.8	5
Coke	"	1000				4.4	44	1.0		1.0	10	1.2	12	3.5	35
							282		1100		338		20		78
						For pig =	65				327				
						" slag =	217				11				

SLAG

SiO₂ = 34.0%
 Al₂O₃ = 14.0
 FeO = 0.3
 CaO = 45.0
 MgO = 4.0
 S = 1.4

PIG

Fe = 92.3%
 C = 3.4
 S = 2.5 or SiO₂ = 5.4
 P = 1.0
 S = 0.2

Maxwell ore. The high content of lime here prescribed also ensures elimination of the sulphur. We therefore specify equal weights of each ore, and note down their percentage values in the appropriate columns. Assuming that we are to count on 2,000 lb. coke per ton of pig, we will need for the 1,100 lb. of iron ore shown in the column (Fe) about 1,000 pounds of coke, which we accordingly specify. This coke carries 11% of ash analyzing 40% SiO₂, 9% CaO and 32% Al₂O₃.

The corresponding SiO₂ in the coke will therefore be 11% of 40%, or 4.4%, and the percentages for Fe and CaO, found in the same way, are written in. The sulphur is reported as a percentage of the coke itself. The limestone or dolomite (magnesia be-

ing calculated as below specified) is the variable which must be made to conform to the rest of the charge, and its amount is found by a cut-and-try method as follows: We put down what we judge to be the proper amount, say 600 lb. Write down now all percentage amounts and carry out the weights of each constituent in pounds, summing them up as shown. Referring to the analysis of the pig iron we will have 1,100 lb. of Fe, or nearly 1,200 lb. of pig containing 5.4% SiO_2 , or (neglecting fractions) 65 lb., and this, deducted from the total, leaves 217 lb. to enter the slag. Magnesia is a stronger base than lime in the ratio of their atomic weights, or as 40 to 56, so that the percentage of MgO multiplied by 1.4 will give us the equivalent lime, in this case 5.6%. This, together with the 45%, also given, makes a total of 50.6%, or, in ratio to the silica of the slag, as 34 to 50.6 or as 1 to 1.49. For 217 lb. of SiO_2 on the charge sheet we therefore require 327 lb. of CaO (too much by 11 lb.), or, since limestone is half CaO , we will reduce the quantity by 22 lb., or, in round numbers, 20 lb. Erase the 600 and the corresponding figures in the other columns, writing in the amended amounts, when it will be found that the calculation will be correct to within the limits of error in weighing. Indeed, variations of 20 lb. in the constituents may easily occur, due to this cause. Summing up we have for the slag:

$$\begin{array}{r}
 \text{SiO}_2 = 217 \text{ lb.} = 34.0\% \\
 \text{Al}_2\text{O}_3 = 78 \text{ " } = 14.0 \text{ (12.4\% actual)} \\
 \text{CaO} + \text{MgO} = \frac{327}{625} \text{ " } = \frac{50.6}{98.6}
 \end{array}$$

Referring to the slag desired, three constituents, namely, SiO_2 , Al_2O_3 and CaO (MgO) will amount to 98.6%. The actual amount of Al_2O_3 is, however, 78×98.6

$$\frac{\quad}{625} = 12.4\%$$

Since alumina is indifferent, being in solution in the slag rather than an active base, we will find that the slag will readjust itself, so that the percentages of SiO_2 and CaO will increase enough to make up for the deficiency, *i.e.* from 97.0 to 98.6%, or by 1.7% gives

$\text{SiO}_2 =$	34.0	34.6
$\text{Al}_2\text{O}_3 =$	12.4	12.6
$\text{CaO} =$	50.6	51.4
	97.0	98.6

In deciding on what slag to use, we may choose from the following table one which will give most nearly the proportion suited to the composition of the iron ores used.

	SiO_2	FeO	CaO	MgO	Al_2O_3	CaS
Middlesborough, England	30.0	0.7	32.8	5.3	28.0	1.9
Saulines, France	31.6	0.6	47.2	1.4	17.0	...
Cuban ore.....	33.2	...	40.7	11.1	13.7	...
Lake ore.....	35.5	...	40.5	8.9	12.0	...
" ".....	34.7	1.3	40.1	10.9	11.3	...
Cuban ore.....	34.5	...	46.5	7.9	10.5	...

From this table we may select a slag which shall approximate the most nearly in Al_2O_3 to that produced by the ores of the charge.

58. CASTING THE PIG IRON.

Every four to six hours the iron is tapped from the furnace, being say 50 tons at a time. The floor of the cast-house, 40 ft. wide and 80 to 150 ft. long, is a sand-bed into which depressions are molded, connected by a main channel or 'runner,' which receives the stream of molten iron flowing from the furnace. These molds are successively filled, forming the pigs of iron weighing 100 lb. each.

To reduce the cost of handling the pig metal, casting machines have been introduced at modern plants. Fig. 102 is a Uehling casting machine consisting of two parallel endless-chain conveyors, composed of molds, each capable of holding 120 lb. of iron. The iron is tapped from the blast-furnace into a large ladle, shown at the right of the picture and thence into the near end of the conveyors, and as it passes along, is partly cooled by water-sprays so that, by the time it has reached the end of the conveyor, it is solid and can be dumped on another conveyor having a flat top. Here it is further cooled by the conveyor dipping into a water trough, so that the pigs fall into cars quite cool.

59. DISPOSAL OF CINDER.

When operating a charcoal furnace, having an output of 100 tons of pig per day, so little cinder is made that it is often customary to permit it to flow out after the iron as the latter is tapped, setting a plate across the stream to skim off the slag, and throwing it into sand beds, from which, when cooled, it is carted away.

A large coke blast-furnace, yielding 500 tons of pig daily, is quite different. It produces in that time some 300 tons of cinder,

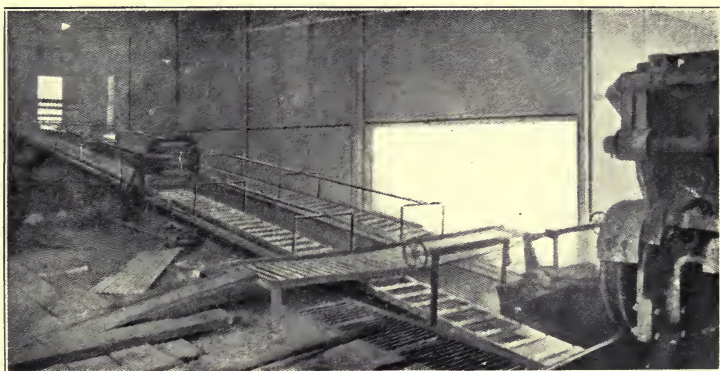

FIG. 102. UEHLING CASTING MACHINE.

which is taken off at the cinder-tap and carried by launder to an adjoining sunken track, where stands a 14-ton cinder car to receive it. This car is hauled out by a locomotive to the dump, sometimes a mile away, where the contents of the ladle are poured out at the side of the track. The track is gradually raised as the dump grows.

60. PIG IRON.

The iron produced in the blast-furnace is not pure, but contains 3.5 to 4.0% of carbon. Some of this carbon is chemically combined, and some held in suspension as graphite. If a large proportion is combined, the fracture of the iron looks white and the metal is hard and brittle. If a large proportion is in the free state, the fracture will be gray or black, with scales of graphite,

and the iron is soft and tough. Iron also contains silica, taken up in the furnace from the ash of the coke. It varies in quantity from 0.5% to sometimes as much as 3%, but is usually of 1 to 2%. A small proportion of sulphur will also be present, seldom less than 0.02%, and often 0.25%, or even more. With over 0.10%, the iron is apt to be hard and brittle. The percentage of silicon and sulphur depends, in large measure, upon furnace conditions, and hence can be controlled, but there is one element which cannot be controlled when present, and which goes onto the pig, namely phosphorus. In irons, used in making steel, according to the usual or acid bessemer process, the phosphorus is not allowed to exceed 0.10%, or, in the ore, no more than 0.5%. This ensures toughness in castings made from it. On the other hand, phosphorus confers great fluidity on cast iron, and such irons, containing as high as 3.0 % P, are in demand where intricate castings are to be made, or where brittleness is of less importance.

Cast iron has the following physical characteristics: (1) It is more fusible than wrought iron. (2) It is brittle. (3) It cannot be forged either hot or cold.

Pig iron is graded according to its appearance into several classes or grades, ranging from the soft gray or No. 1 iron to the hard white or No. 6 grade as follows:

Alabama Pig Iron.

Grade	Graphite Carbon	Combined Carbon	Silica
Silver gray	3.13	0.02	5.5
No. 2 soft	3.48	0.03	3.5
No. 1 soft	3.53	0.03	3.5 to 4.0
No. 1 foundry	3.49	0.07	2.8 to 3.5
No. 2 foundry	3.55	0.07	2.2 to 2.6
No. 3 foundry	3.48	0.10	2.0 to 2.4
Gray forge	3.00	0.57	1.3 to 1.7
Mottled	2.11	1.22	1.1 to 1.6
White	0.10	2.92	0.7 to 1.2

The table shows the increase of combined carbon and the decrease of silicon as the grade progresses toward white iron.

61. IRON BLAST-FURNACE SLAGS.

The gangue contained in the ore, as well as the ash of the fuel added to the blast-furnace charge, must be fluxed by the addition of a cheap base, such as lime or magnesia, to produce a fluid slag. Now the ores used in the large iron districts contain little sulphur, but coke may carry from 0.25%, which is low, to 2%, which is high, or on an average, 1%. This sulphur cannot be permitted to enter the iron, while by using a slag containing plenty of lime and a hot furnace, it may be forced into the slag. Thus, on Lake Superior iron ore, and using coke, a suitable slag had the composition 35.1% SiO_2 , 14.2% Al_2O_3 , 22.5% CaO , 22.4% MgO , while the iron produced contained 1.4% Si and 0.05% S. In another instance, in a fairly hot furnace, a slag of 36.1% SiO_2 , 12.9% Al_2O_3 , 41.7% CaO , and 7.3% MgO , took up, principally from the coke, 1.6% S, and produced an iron containing 2.15% Si and only 0.02% S. The slag was quite clean, retaining but 0.54% Fe.

PART VI. COPPER

PART VI. COPPER.

62. ORES OF COPPER.

In describing the ores of copper, it must not be forgotten that we are to think of them as mineral aggregates (mixed ores), containing often less than 10 to 15% Cu, and consequently, carrying a proportion of associated mineral in large excess. In treating such ores the question of disposing of the gangue is of as much importance as obtaining the copper. Though there are many kinds of copper ores, those of commercial importance are few in number. We may divide them into three classes: the sulphides (and especially chalcopyrite), being the most common; the oxides, including the carbonates, and finally rocks containing native copper.

Copper sulphides.

Chalcopyrite.— Cu Fe S_2 contains 34.4% Cu, 30.5% Fe, and 35.1% S. This is by far the most widely distributed and the most abundant of the ores of copper and furnishes the world's principal supply of the metal. It is frequently accompanied by an excess of iron pyrite with, even in the massive sulphide, a certain amount of silicious gangue. In consequence, such ores ordinarily carry but a small amount of copper, and are particularly suited to pyrite or semi-pyrite smelting. Silver and gold are also to be found in these ores in small quantity. Thus, at the deposits of Mt. Lyell, Tasmania, which have been so successfully worked by pyritic smelting, the ore, chiefly a massive iron pyrite containing some chalcopyrite, carries 4.5 to 5% Cu; 15 oz. Au and 3 oz. Ag per ton.

Chalcocite (Copper glance).— Cu_2S contains 79.7% Cu and 20.3% S when pure. Even the crystals are seldom pure, the copper having been replaced by iron and other metals, but still showing the characteristics of the mineral when carrying as little as 55% Cu. When pure, however, it resembles the artificial product of the furnace, 'white metal,' a high-grade matte.

Bornite (Peacock ore).— $3\text{Cu}_2\text{S}$, Fe_2S_3 containing 55.6% Cu, 16.3% Fe, and 28.1% S. Like copper glance, this mineral is far from uniform in composition, varying in richness from 42 to 70% Cu, without losing its characteristic varied colors.

Tetrahedrite (Gray copper, fahlerz).— Cu_2S , FeS , ZnS , AgS , PbS ($\text{Sb S}_3\text{As}_2\text{S}_3$) containing 30.4% Cu. This ore, because of its obnoxious contents, antimony and arsenic, is an unfavorable ore of copper; and it is only its silver contents, when high, which justify its being smelted at all.

Copper oxides and carbonates (Oxidized ores of copper).—These ores are the products of decomposition of sulphides by the elements. As a result we find such ores at or near the surface, accompanied by iron in oxidized form (gossan), which changes in depth to the sulphide, both of iron and copper. Being in oxidized form, they are often, when of low grade, suitable ores for the extraction of their values by leaching methods.

Cuprite (Red oxide of copper).— Cu_2O containing 88.8% Cu, 11.2% O. This mineral, a product of decomposition, often permeates large masses of iron oxide. Large lumps of it sometimes occur which are evidently the result of oxidization of native copper, the centre still remaining unaltered.

Melaconite.—(Black oxide of copper) CuO , containing 79.8% Cu_2 , 20.2% O. This ore, with its copper replaced in part by oxides of iron and manganese, is sometimes found in masses large enough to pay for extraction, and containing 20 to 50% of the metal. The so-called black oxide of the Blue Ridge region, on the border between Tennessee, North Carolina and Virginia, seems to be an intimate mixture of copper glance, copper oxide, copper carbonate, native copper and iron oxide and sulphide. Such ore is readily pile-roasted.

Malachite.— CuCO_3 , $\text{Cu}(\text{H}_2\text{O})$ will carry, when pure, 57.3% Cu. This ore occurs widely distributed, ordinarily in non-paying quantities as a decomposition product in surface deposits, but sometimes rich enough for a workable ore. It is found mixed with lime, dolomite, oxides of iron and manganese, and silica in its various forms. It is very difficult to judge from external appearance of the content of the ore in copper.



FIG. 104. BLAST-FURNACE FOR OXIDIZED COPPER ORES.

Azurite.— $2 \text{ Cu CO}_3 + \text{Cu } 2 \text{ H}_2\text{O}$ has 55.2% Cu when pure. This striking looking ore occurs much the same as malachite, but less abundantly, coloring other oxides.

Native copper.—Cu.—It is found very extensively in the copper region of Lake Superior. Elsewhere it is found too sparingly to have commercial value. In the Lake Superior country it is found in wide lodes or veins disseminated through the rock, in such a way that it forms from only 0.5 to 4% of the whole mass and consequently all the vein matter must be concentrated to obtain the copper. The concentrate, or 'mineral,' as it is locally named, will carry from 30 to 95% copper, the lower grades still holding considerable gangue.

63. SMELTING THE OXIDIZED ORES OF COPPER.

In the southwest of the United States (New Mexico and Arizona) are to be found many oxidized ores, containing copper as cuprite and malachite, accompanied sometimes by small amounts of sulphides, as copper glance. These ores have been treated for the winning of their copper in one operation in blast-furnaces, by a reduction smelting for metallic copper. The same method is followed in the Lake Superior copper country for the smelting of copper-bearing reverberatory slags made in the smelting of the native copper 'mineral' of that country. These slags contain some copper as copper oxide, together with shot and scrap copper, removed during the skimming.

Fig. 104 and 105 represent an exterior and a vertical sectional elevation of the blast-furnace or cupola used for these operations.

The water-jacket (often made in sections) is of flange steel. It is surrounded by a 'wind box' connected to the blower by means of a blast pipe, shown in the exterior view. The tuyeres are within the water space of the jacket, and have, opposite them, mica-covered peep-holes for observation of their condition. The curb, extending from the base plate to the jackets, forms the sheet-iron covering of the crucible. The base plate rests upon four iron columns, which are supported by a solid foundation. The base plate, together with two hinged drop-doors, forms the

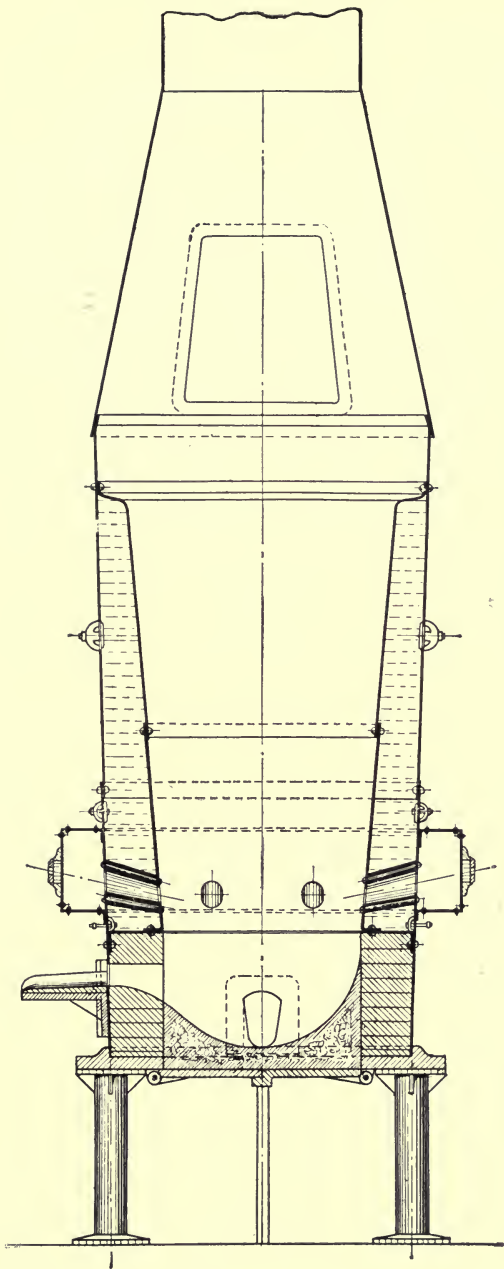

FIG. 105. BLAST-FURNACE FOR OXIDIZED COPPER ORES (SECTION).

bottom of the crucible. The crucible is a receptacle, lined on the sides with fire-brick, and on the bottom with a mixture called 'steep,' made of coke dust, ground fire-brick and clay, or with fire-brick only. It forms an infusible lining to protect the iron exterior, and to hold or retain the heat of its contents. It is this crucible which holds the molten portion of the charge, the slag separating out and floating above the molten copper, which has been reduced from the ore. There are two tap holes to the crucible, the lower, close to its bottom, for the removal of the molten 'blister' copper, and the upper one for removal of the supernatant slag. From time to time, as either of these products accumulates in the crucible, it is tapped out by punching a hole through the clay stopping of the tap-hole with a pointed tapping-bar. The flow is stopped again by means of a plug of clay stuck on the end of a button-ended stopper-rod or dolly. The slag is received into a slag pot, shown in Fig. 106, and pushed out to the dump by a man who pours out its contents over the edge of the dump.

The blister copper is received in a copper-bullion pot or mold, like the slag pot, mounted on wheels. As shown (Fig. 107) the water-jacket forms the wall of the shaft of the furnace, and within this space, the fusion of the charge takes place. Formerly, this wall was of fire-brick, but it was found that it was soon eaten through, or corroded, by the action of the molten slag upon it. The water-jacket shown as a double annular shell, within which water freely circulates, prevents such corrosion, permitting uninterrupted operation. Cold water enters the jacket in a regulated stream to replace heated water flowing out at a temperature of 70 to 80° C. It will be noticed that the shaft of the furnace widens out as it goes upward, forming a bosh. Above the shaft rises the stack or hood to carry off the fumes from the charge. A feed door, shown in the hood, is provided to introduce the charge. It is to be understood, that when in operation, the furnace is kept full to the feed door with charge and fuel. These are placed in layers, first a layer of fuel and upon it a layer of charge, and so alternately. The blast rises through this mass of materials called 'smelting column,' under a pressure of 12 oz. to the square inch. The entering air causes an intense combustion of the coke and fuses the charge. In contact with the glowing coke, reduc-



FIG. 106. SLAG POT.

tion is also effected, by which the copper separates out in drops, and finds its way to the bottom of the crucible. In the oxidized ores of copper may often be found copper glance or other sulphide. This sulphur, quite small in amount, is often dissipated by the blast, but otherwise, uniting itself to some of the copper, it may make a small amount of matte of about 70% copper. This matte is to be found as a thin coating or shell upon the upper surface of the blister copper when it cools in the copper-bullion mold.

The separation between slag and copper in the crucible is not perfect, but drops of copper are liable to escape with the slag. To save this a forehearth or brick-lined iron box is placed to catch the flow from the slag spout. The slag flows into the forehearth (which is full of molten slag) on one side, leaving by a spout on the opposite one. Any drops of copper, in the gradual passage of the slag across the forehearth, settle out to the bottom. When the copper has accumulated in sufficient quantity in the forehearth, it may be tapped off by a lower spout shown on the side.

As a result of the exterior cooling influences, the crust of slag, which forms upon the borders of the forehearth, becomes thicker, and, after several days, may result in the central molten pool of slag becoming too small for effecting a good separation of copper from slag. When this happens, the forehearth may be pried out of the way on its wheels and another one run into position. For a small round blister copper furnace, such as already illustrated, a settling pot may be used in place of a forehearth. As shown in Fig. 109, it resembles a large slag pot, but has spouts for the removal of the slag, and when copper accumulates in the bottom this settling pot may be readily replaced by another. The copper in the former settler can be removed when the contents have stood and solidified.

The cost of treatment of these ores in the Southwestern United States may be given at \$8 per ton. The slag generally runs from 1.5 to 2.5% in copper, so that, under the best conditions, we may rely on a recovery of but 82% of the copper, while the extraction of the silver in the ore will go to 91%. This considerable loss of the copper in the slag is one of the drawbacks of the process. It would appear that, as has already been demonstrated, the use of

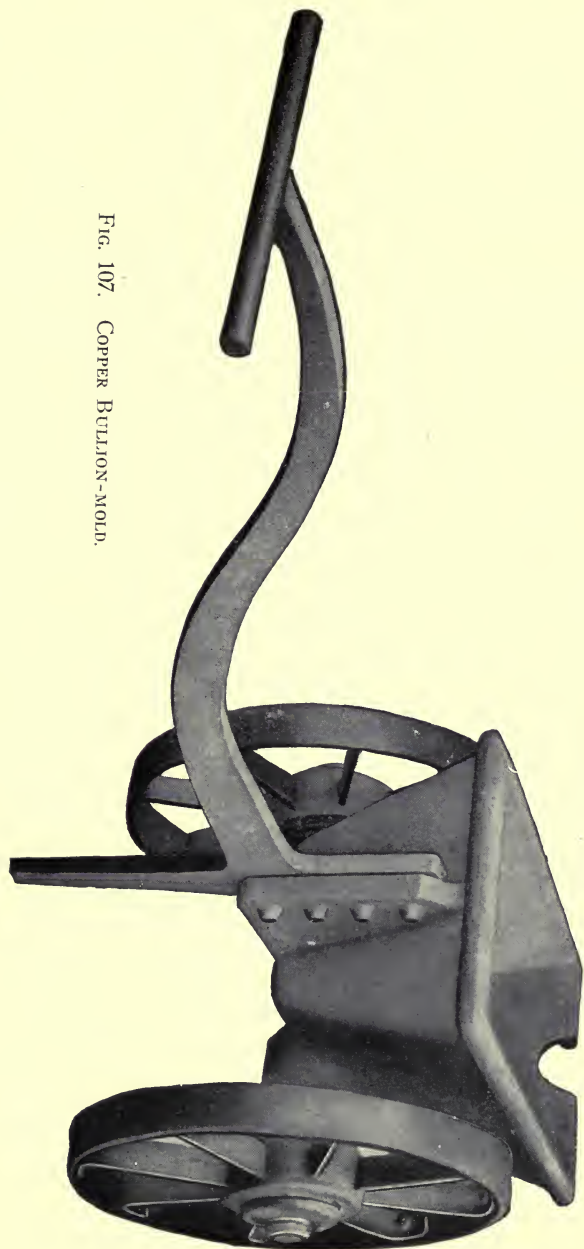

FIG. 107. COPPER BULLION-MOLD.

hard coal would give much better reduction—to as low as 0.6 to 1% Cu as in the Lake Superior copper country.

64. STORAGE OF MATERIALS OF THE CHARGE.

Sometimes the arrangements for storing the supplies are very simple, they being put in heaps or in simple bins. However, it is



FIG. 108. FOREHEARTH.

becoming customary to put the most used of such material in hopper-bottomed storage bins whence they may be drawn off to the charge-cars or buggies by means of gates and chutes. The disadvantage of the method is that the ore, if lumpy, varies greatly, being sometimes coarse and sometimes fine, and making corresponding variation in the operations of the furnace. Coke is generally

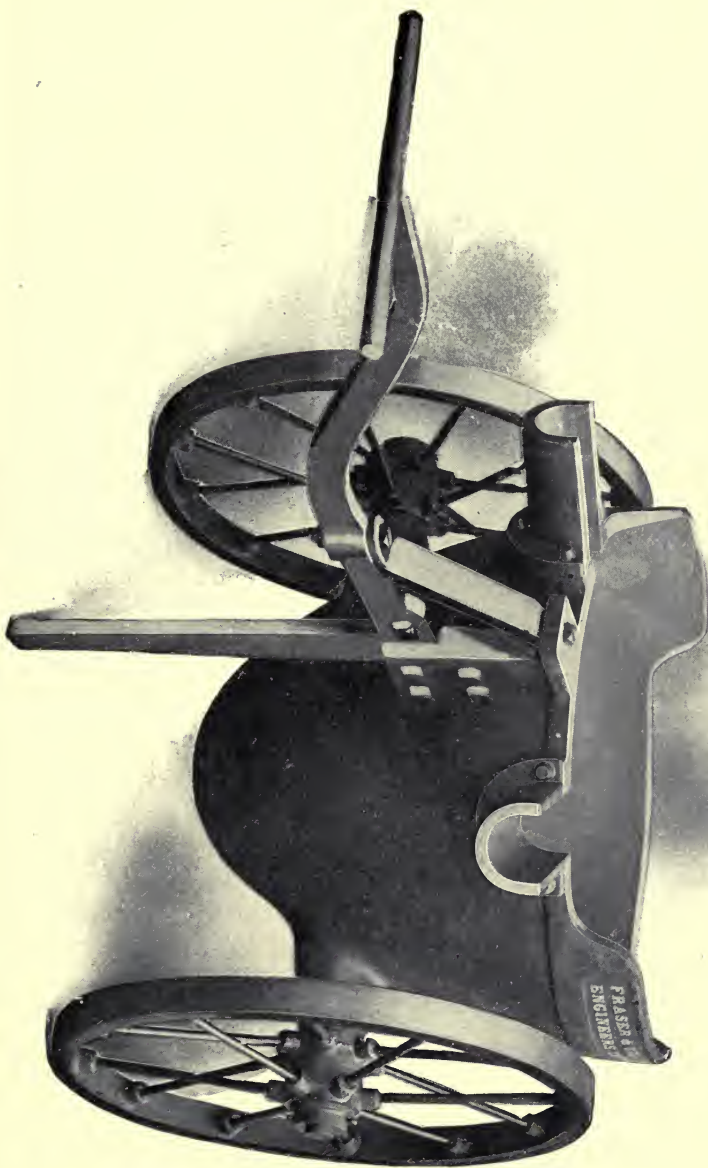

FIG. 109. SETTLING POT.

stored in heaps. There should be a good supply, both of it and of the fluxes kept in storage, so that in case of short supply or failure in delivery, the storage can be drawn on. Such a reserve stock need not cost much, and will well repay the outlay in the increased certainty of running.

While in copper smelting it is possible to estimate the needed ingredients by the shovelful, it is better to weigh everything which goes to the furnace, except the fowl slag or old charge returned in the regular running. The latter has been charged once to the furnace, and should not be again reckoned in. The number of charges is recorded by keeping tally of them on a board pierced with 100 holes, set in ten rows. The weighing of the charge is done by the charge-wheelers, and the metallurgist should constantly see that weights and charges are correctly and properly registered. These data form an important feature of the question of costs. The roasted ore, when made at reverberatory roasting furnaces, is dumped out on a cooling floor and from it is shoveled directly into the charge-buggies. The fuel is put on the charge-plate at one side of the furnace and the charge on the other, and this arrangement is alternated, the following charge being dumped where the coke had just lain. It is to be understood that the fuel and charge are delivered into the furnace in alternate layers. The coke is spread evenly over the surface of the materials in the furnace and the charge itself fed in so as to get lumps to the centre and fine to the sides, taking care, however, to feed so that the blast comes through evenly. The slag from an exhausted forehearth—that which runs out with matte, or from cleaning out a spout, etc., all contains drops of matte, and is called fowl slag. It is to be returned to the furnace as a welcome addition to the charge.

65. RELATIVE ADVANTAGES OF BLAST-FURNACE AND REVERBERATORY SMELTING.

The output of the blast-furnace is larger than that of the reverberatory.

The blast-furnace slag is generally cleaner. The blast-furnace takes its charges continuously, and the removal of slag is practically continuous. Matte is removed periodically.

The blast-furnace takes less fuel than the reverberatory, though that fuel is more costly per ton than reverberatory coal. In pyritic-smelting but little coke is used.

The reverberatory can smelt finely ground ore which would create much flue-dust in the blast-furnace.

Where coal is cheap the fuel cost may be lower in reverberatory than in regular blast-furnace work.

Slags in the reverberatory may be more infusible, in fact such slags may contain pieces of unfused silicious ore, which nevertheless have been freed from gold and silver values.

Repairs to the reverberatory are greater than in blast-furnaces. Both kinds of furnaces have their troubles, the blast-furnace in freezing up, the reverberatory, through difficulty in reaching fusion temperature.

The slag and matte are removed periodically from the reverberatory, which occasions delay and consequent cooling of the furnace.

The grade of matte is increased in the reverberatory owing to the removal of sulphur by the following reactions which take place when the charge is fused down.

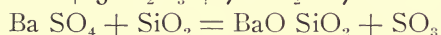
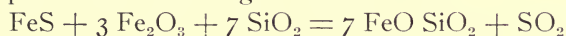

That is, where ferric iron or barium sulphate (heavy spar) is present, sulphur is eliminated.

66. CALCULATION OF CHARGE IN REGULAR COPPER BLAST-FURNACE MATTING.

A charge, suited to such smelting, would consist of roasted ore with, or without, the addition of oxidized copper ores, and of silicious ores, in case it should be desirable to obtain the gold and silver from them. The products of the furnace are slag and matte, the former being the result of the union of the silica in the charge with various bases, namely iron and lime; the latter being that complex artificial sulphide due to the sulphur in the charge, taking up, first copper, and then, if it needs it, a portion of the iron present. The remainder of the iron enters the slag. A copper furnace slag may be quite variable in composition, the

main requirement being that it shall be fusible. Slags varying from 25 to 40% in silica are found in copper practice, the latter limit being somewhat exceeded where bases for fluxing add much to the cost of smelting. In lead-silver smelting this is not the case, and it is necessary to proportion the charge so as to have slags of a type, such that they shall be lead-and-silver-free.

As a simple case, let us take, for example, 1,000 lb. of a roasted ore having the composition 5% Cu, 25% SiO_2 , 30% Fe and roasted to leave in it 10% S. This is to be smelted with limestone to produce a slag to contain 35% SiO_2 , the bases FeO and CaO amounting together to 55%, which will leave 10% for all other elements. The limestone contains 4% SiO_2 and 52% CaO, while the coke has 12% ash, this ash having 60% SiO_2 , 10% Fe and 15% CaO. These figures in the ash correspond to 7.2% SiO_2 , 1.2% Fe and 1.8% CaO in the coke. A metallurgist, accustomed to running certain ores, knows, with some degree of approximation, how much flux he needs, but even if not, he makes a guess as to the quantity needed, and puts the figure down in the column of dry weights of the charge sheet on the line for limestone. Say this is 300 lb., and that he has decided upon 10% coke as the fuel needed for this charge of 1,300 lb. or 130 lb., which is also set down. The percentages are then written in their proper columns, and the multiplications for the weights in pounds carried out, neglecting fractions. At the left of the charge-sheet write in the slag composition. Obtain now the ratio of the bases to silica, as shown, giving a factor of 1.57 in this particular case. On the right of the charge-sheet write the matte composition which, in the case of mattes such as are produced in blast-furnaces, is of the average composition there given. Also work out the ratio of bases to sulphur giving the factor 3. Let us take up the sulphur. On well-roasted ore we may reckon on a loss, by volatilization, of 25%, leaving 75% to go to the formation of matte. The 75 lb. found, multiplied by the factor 3, gives 225 lb. of copper and iron needed for the matte. There is, however, 4 lb. copper lost in the slag, to be deducted from the 100 lb. given on the charge-sheet. The total slag equals the 271 lb. SiO_2 of the charge-sheet, divided by 35% SiO_2 or 770 lb. Allowing

0.5% Cu in the slag, this makes 4 lb. copper so lost, leaving 96 lb. copper for the matte. Then $225 - 96 = 129$ lb. of Fe to be taken from the total of 302, leaving 173 lb. to enter the slag. But the iron in the slag exists as FeO or as 56 Fe to 72 FeO, or as 7 to 9, giving us 222 lb. FeO. To this add the CaO (158 lb.), making 380 lb. of both bases. Multiplying the silica, 271 lb., by the factor 1.57, we find that we need 425 lb. of the bases FeO and CaO, so that we have 45 lb. too little. Now, since limestone is approximately one-half CaO, this will mean the addition of about 90 lb. to the charge, making 390 lb. as the proper figure. Erase the original figure (300) and replace with the amended amount (390), erase where needed, and recalculate the charge throughout. This time we will come to within a few pounds of the correct amount. The amount may be again amended without recalculating, or, when within 5 or 10 lb. of the exact figure, may be accepted as being close enough. Variations in the ores in the weighing and in the sulphur volatilized may far exceed such minor differences.

Charge Sheet.

Name of Ore	Weight		Cu		SiO ₂		Fe & Mn		CaO & MgO		S.			
	H ₂ O	Wet	Dry	%	Wt.	%	Wt.	%	Wt.	%	Wt.	%	Wt.	
Roasted Ore			1000	5.0	100	25.0	250	30.0	300				10.0	100
Limestone			300			4.0	12			52.0	156			
Coke			130			7.2	9	1.2	2	1.8	2			
					100		271		302		158			100
			Cu in Slag =		4		For Matte =		129					75
			Cu in Matte =		96		For Slag =		173		S in Matte =		75	
					225									3
			Fe in Matte =		129		Cu and Fe in Matte =		225					

SLAG	173 Fe = 222 = FeO	MATTE
SiO ₂ = 35.0%	158 = CaO	S = 23.0 %
FeO & CaO = 55.0%	Actual FeO & CaO = 380	Cu & Fe = 69.0 %
FeO & CaO	Needed " " = 425	Cu & Fe
SiO ₂ = 1.57 (factor)	CaO too little = 45	S = 3.0 (factor)

Dividing the 225 lb. Cu and Fe by their percentage 69, we get a factor 3.3. The pounds of Cu and Fe, divided by this factor,

give Cu 29% and Fe 40% as the proportions of those metals in the matte. In a similar manner we may find the amount of FeO and CaO in the slag.

The metallurgist can seldom count upon the charge coming down as calculated; and as soon as it is down he should take a sample of the slag for analysis. It should be determined for Cu, SiO₂, Fe and CaO. These determinations will take upward of two hours, and from them the furnace charge can be corrected as desired, or, if the slag appears satisfactory, and is low in copper, it may be left unchanged.

67. MATTE AND SLAG.

Matte is a complex artificial sulphide formed in smelting operations as the result of the union of sulphur with bases. Iron sulphide (FeS), such as is used in the generation of H₂S in the laboratory is its simplest form. When part of the iron is substituted by copper, copper matte Cu,FeS is formed. If lead enters this compound, as is the case in lead smelting, we will have a leady copper-matte Cu,Pb,FeS. In smelting copper-nickel ores a matte Ni,Cu,FeS is produced. It must be understood, however, that these combinations are not in relation to the atomic weights. Thus, in copper mattes we may find the copper in any proportion from little up to 75%. Normal mattes carry 20 to 26% sulphur, the remainder being made up of the metals. It will be noticed that where there is copper present in a smelting charge, it will be taken up by the sulphur first; and, then if the sulphur needs other base, it will take up iron. In other words the affinity of sulphur for copper is greater than for iron.

As compared with ore, when roasted, matte retains its sulphur more firmly, and needs longer time and more heat in roasting. Thus, a matte, when well roasted, may still hold 5 to 6% S, while the correspondingly roasted ore would retain but 3 or 4% S. Mattes vary in specific gravity. A matte high in copper is heavy as compared with a normal 50% copper matte, which latter would have the specific gravity of 5. Mattes often take up zinc from the charge, becoming lighter in so doing. On the other hand we may have the case of slags high in iron of a specific

gravity of 3, which, with light mattes, result in a poor separation because of the less difference in specific gravity. On the other hand, silicious limy slags of low specific gravity promote separation.

Copper furnace slags.—Very considerable variations in slag composition are permissible in copper-smelting blast-furnace practice, the requirement being that the slag should be fusible, and fluid enough to flow from the tap-hole of the furnace. Slags having the minimum and maximum contents in silica and bases shown herewith, can be successfully used in the blast-furnace. Of course, when they are at a minimum in one element, they are at a maximum in others.

	SiO ₂	FeO	Al ₂ O ₂	CaO	MgO	ZnO	Ba
Minimum	20	2	2	2	0	0	0
Maximum	57	70	18	40	8	20	42

68. COMPOSITION OF COPPER MATTE.

In the following is given the composition of five grades of copper matte.

- I 28% Cu 35% Fe, 23% S (coarse metal)
- II 35% “ 30% “ 23% “ “ “
- III 51% “ 18% “ 23% “ (shipping, or converter matte)
- IV 60% “ 13% “ 23% “ blue metal
- V 70% “ 5% “ 20% “ “

It will be noticed that in the higher-grade mattes, because of the small amount of Fe present, the heat in converting is not so well kept up. However, the Cu₂S becomes in part oxidized to Cu₂O and, reacting on the remaining cuprous sulphide, gives copper, and, the reaction being exothermic, keeps the molten contents of the converter liquid.

We have

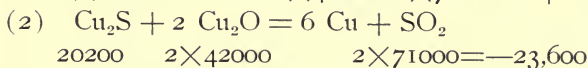
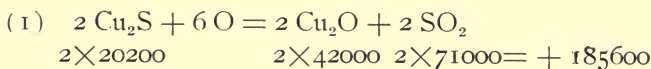

Or, as the result of the two reactions, 185600—23600=162000, or per pound of copper 638 pound calories.

69. THE COPPER-MATTING BLAST-FURNACE.

For producing matte from copper-bearing ores, whether roasted or raw, a furnace having a simple hearth but no crucible is used,

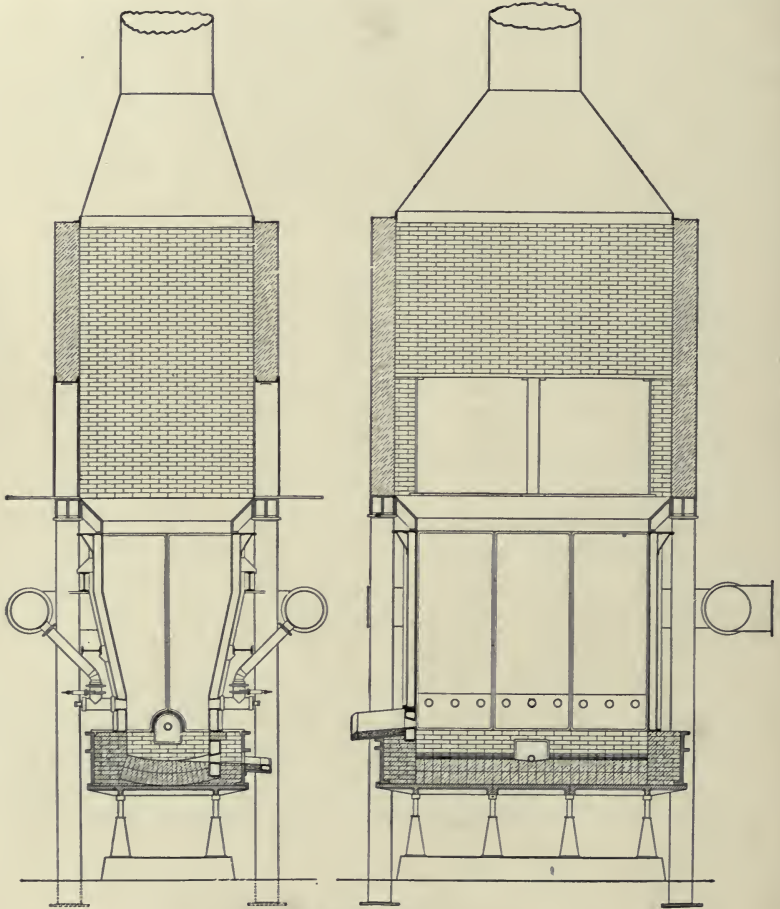

FIG. 110. COPPER MATTING FURNACE.

as shown in the illustration, Fig. 110, *a* being a transverse and *b* a longitudinal elevation of a furnace 42 by 120 in. hearth dimensions. Fig. 111 is a perspective view of the lower part or iron-work of the same furnace. The sole-plate of the hearth is sus-

tained by jack-screws which stand upon the foundations, and, when desired, it can be lowered and removed altogether for repairs. The sole-plate is protected from the action of molten materials by a layer of fire-brick 8 in. thick, forming an inverted arch abutting on the side water-jackets, and upon it stands the

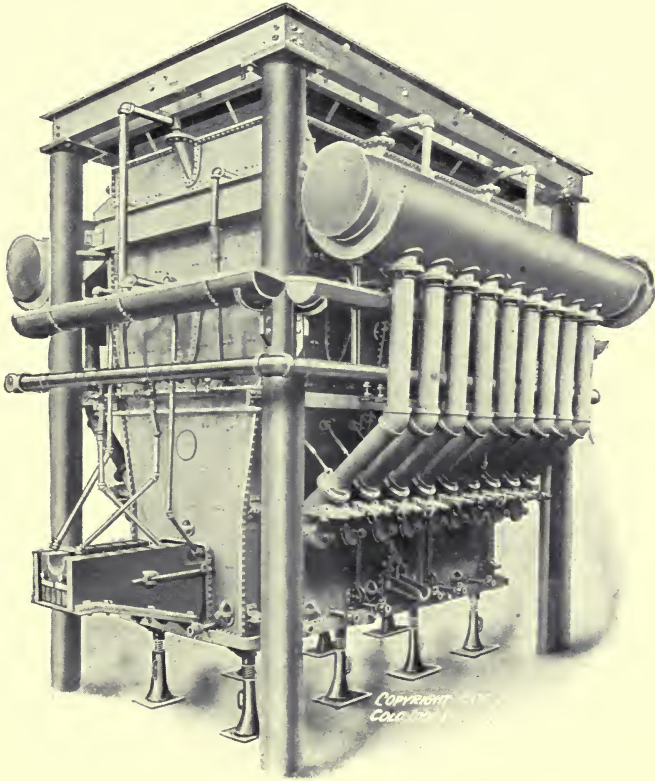

FIG. 111. PERSPECTIVE VIEW OF COPPER MATTING FURNACE.

lower tier of water-jackets, more particularly shown in Fig. 112. These jackets, 9 ft. high, are pierced for the tuyeres, have inlet openings at half the height of the bosh for water supply, and outlets at their highest point, so that they may be kept completely filled with water. They are clamped, or tied together with heavy angle-irons. In section *b* Fig. 113 is shown a water-cooled spout,

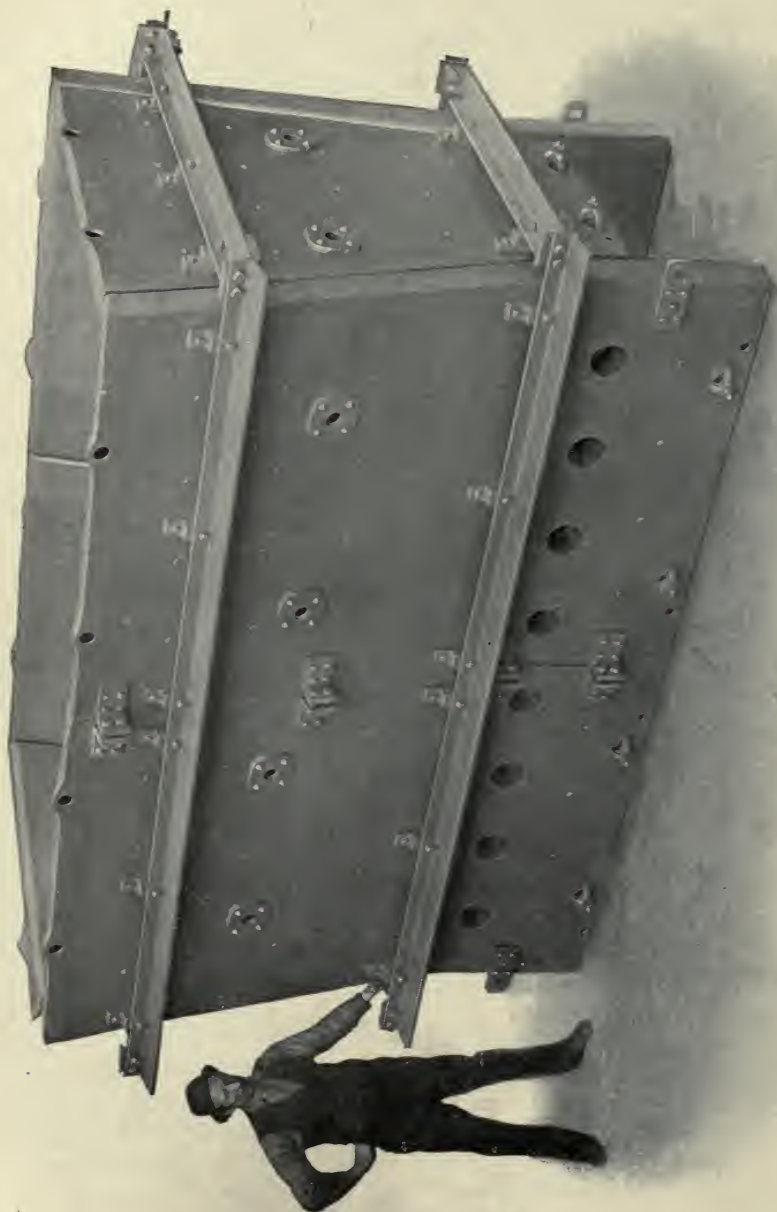

FIG. 112. STEEL WATER JACKETS.

by which the slag and matte together flow from the furnace. The slag before overflowing fills the spout and covers its outlet from the furnace, thus preventing the escape of the blast; and as fast as it forms it escapes in a regular stream. On the side, at the middle jacket, is to be seen another outlet furnished with a spout, generally kept closed, but which is opened when it is desired to empty the hearth of its contained matte and slag. Both these apertures are closed, except for the tap-hole openings, by a

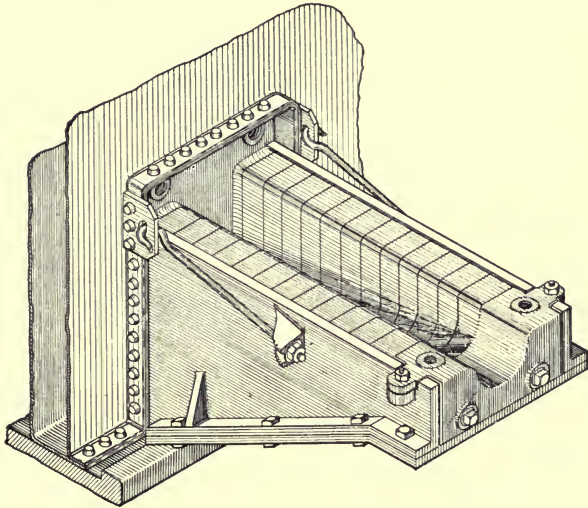

FIG. 113. TRAPPED SPOUT.

water-cooled tap-jacket. The lower jackets are suspended from I-beams, so that the hearth may be removed without disturbing them. Above the tuyeres the side-jackets widen out forming a 14-in. bosh or enlargement of the furnace, so that, at their top, they are 5 ft. 6 in. wide. Above the lower jackets is another tier, above which comes the cast-iron distributing-plates forming the sill of the feed-doors. It will be noticed that the feed-doors extend the whole length of the furnace and on both sides, thus making the whole interior accessible, not only to the feeding and trimming of the charges, but also for cutting off whatever accretions may form upon the interior surfaces of the jackets. The

upper portion, being the stack or closed top of the furnace, is of brick, carried upon a deck or mantel-plate of I-beams, these again resting on the columns which are firmly fixed in the foundation. The upper portion of the stack is of sheet-steel, and is completed by a circular pipe extending through the roof of the furnace building. The bustle-pipe, by which the blast is brought to the tuyeres, extends around three sides of the furnace, and connects by sheet-metal blow-pipes to the tuyeres shown more in detail in Fig. 114. In this figure will be noticed the method of holding the tuyere against the jacket by a tie-bolt on each side. The front of the tuyere has a cap, which may be removed for access to the interior, and a mica-covered peep-hole through which the condition of the furnace can be observed. Each tuyere has its own shut-off valve.

Just below the bustle-pipe will be seen a waste-laundry or trough, which receives the overflow from the jackets, and below that again comes a 3-in. water-supply pipe branching to each jacket, both lower and upper, and to the water-cooled spout at the front, more particularly shown in Fig. 113.

70. BLAST-FURNACE MATTE SMELTING OF COPPER.

The smelting of copper-bearing ores for the production of matte may be divided into regular smelting and pyrite smelting. The former method is used when the quantity of sulphur present in the charge is small, as for instance when using partly oxidized, roasted or silicious ores. Pyrite smelting applies with a charge having a high content in sulphur, and, in which the sulphur is incidentally burned, furnishing heat in so doing:

71. REGULAR MATTE SMELTING.

This method has an advantage in that its operation is much more certain and regular than is the case with pyrite smelting. Ores, carrying much sulphur must, however, be roasted, and since blast-furnace smelting is not suited to fine ores, either heap or stall-roasted ores should be used. With these ores there can also be used silicious and oxidized ores. The amount of matte made (matte fall) depends upon the percentage of sulphur in the

charge, so that to get a good concentration (ratio of ore to matte produced) the sulphur should be kept low. To the ores just specified should be added limestone or iron ore for flux, together with 10 to 15% of fuel, generally coke.

Starting and operation of the blast-furnace. Since a modern blast-furnace is water-jacketed, the operation of warming it up is a simple one. The crucible being lined with fire-brick can be soon dried out and warmed by several hours' heating with a wood fire. The tap-openings are left open to permit entrance of the air to

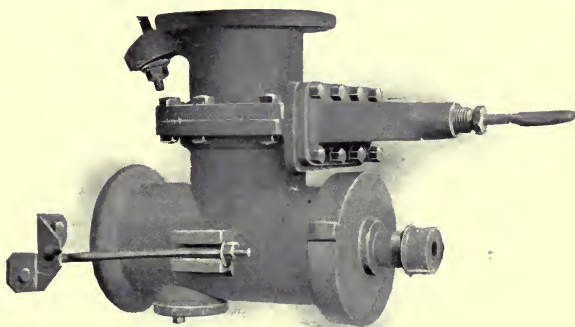

FIG. 114. TUYERE.

the fuel. The hearth, being hot, the ashes are scraped out and a fresh fire of wood is put in, filling the interior about half way up to the tuyeres (12 in. deep). Be careful to have the wood uniform in size, so that it may burn away uniformly. Upon the wood is scattered some charcoal, if you have it, to just cover the wood. Upon this is put a layer of coke coming to, say $1\frac{1}{2}$ to 2 feet above the tuyeres. Care must be taken to get this bed of fuel burning uniformly by checking the draft at the front and promoting it at the rear, if necessary. We can now begin charging. Supposing that the charge is to be 2,000 lb., and that we are to use 12% of coke, or 240 lb. per charge. We put in the 240 lb., and upon it 500 lb. fusible slag, then several more charges each consisting of 240 lb. coke with 1,000 lb. slag. Following we should put in a number of charges more, each of 240 lb. fuel and 2,000

lb. slag. The charges of slag should be of weight sufficient entirely and promptly to fill the forehearth. We may now begin putting in the regular charges which have already been calculated. At this time, the fuel being fully ignited, the blast may be turned on, gently at first, and gradually increasing for half an hour, when the furnace should be in full blast. An extra force of men should be busy charging, so as to get the furnace filled as rapidly as possible. At the slag floor before the blast has been turned on, the slag-spout should have been put up and the tap-opening closed with balls of the plugging material. This stopper-clay is sometimes to be obtained from a neighboring clay-bank, and is sometimes made of a mixture of coarsely ground fine brick and clay. The brick-lined forehearth has been warmed up at the same time as the furnace. It would be well to have openings low down on the sides to permit the entrance of air, which may be plugged at the last moment. Thus the fire does not get sluggish. Again, the fuel on the forehearth should be set round against the walls, and not at the middle of the hearth. Use the wood moderately, and as it burns away and as charcoal and ashes accumulate, shovel them out, as they are non-conductors of heat which effectually prevent warming up. The slag-spout should be plugged with clay so as to hold the slag back in the furnace. When, by looking in at the tuyeres, we see the slag about at their level, tap off the slag, which should quickly fill the forehearth. The matte, arising from the ore charge, now begins to accumulate in the forehearth, and whenever there is enough for a tapping, it is removed, generally into suitable pots. The slag, as it flows from the forehearth, may be caught in slag-pots or it may be granulated. In charging, care should be taken to have an even distribution of the charge, not coarse ore in one place and fine in another. Unless particular care is taken in this respect, we may have irregular running, blast and flame coming up in one place, and the furnace apparently dead in another. Two methods of removing the slag and matte from the furnace prevail, intermittent or continuous flow. In the first method the slag is allowed to accumulate on the furnace hearth and, before it rises as high as the tuyeres, is tapped off by piercing the clay plug with which the tap-hole has been closed. This tap-hole, on account of the corrosive nature of the matte, is

water-cooled, being then called a tap-jacket. This jacket is secured to the front of the furnace, and is about 10 in. square. By the other method of continuous flow, or 'open breast,' the slag and matte continuously flow from the furnace, as it forms, through a trapped spout, as shown in the description of the matting furnace. This method needs less attention and gives less trouble than that of intermittent tapping.

Blast-furnace copper-matte smelting of roasted ore.

Roasted ore, together with oxidized or silicious ores, and fuel, may be smelted with such fluxes as may be necessary to produce a suitable slag. Taking the case of a furnace in full operation, we find it filled with charges to the feed door, or to the depth of say, 7 ft. As the molten materials are drawn off below, the surface of the charge imperceptibly sinks, making room for more material. The coke is spread out in a layer over this surface, and upon that is spread the calculated and weighed charge, the furnace being kept full. The air from the blowers blown into the furnace under the pressure of 12 oz. to the sq. in. burns the coke mostly at the tuyeres. The gases resulting, together with the fumes from the volatilization of a portion of the sulphur present, come up through the charge as a whitish smoke which passes off at the stack. Most of the sulphur present, uniting itself to the copper and to a part of the iron, forms a matte of copper-iron sulphide. This matte, when forming, will also take up the contained gold and silver existing in the ore. The glowing coke of the charge reduces the iron oxide (unused by the matte) to the ferrous form, and this, together with the CaO , Al_2O_3 and other bases, fuses with the silica to form a slag, fluid at the high temperature at the tuyeres. This molten material, both slag and matte, flows from the furnace into a forehearth, a box or tank in which, owing to the difference in specific gravity, the matte settles out to the bottom. The supernatant slag thus freed from the matte, escapes by an overflow spout on the opposite or front-side of the forehearth. Here it may be received into slag pots to be drawn away to the dump, or the falling stream of slag may be granulated by a jet of water which sweeps it away, carrying it by an iron-lined launder to the dump. The matte is tapped off from the forehearth from time to time, as it accumulates, into

pots. Otherwise it may be tapped into a sand-bed in which are molded the depressions for the pigs, these depressions being joined by a notch from one to another, so that the overflow of the first molds goes into the succeeding ones.

72. PYRITIC MATTE SMELTING.

This operation is performed upon iron-sulphide ores more or less silicious, containing some copper and also values in gold and silver, which are to be recovered. It consists of smelting these ores in a blast-furnace with a small amount of coke, burning off, say, 70 to 80% of the sulphur by means of the air-blast, while the remainder, uniting itself to the copper and iron present, forms a matte which takes up the contained precious metals of the ores. A slag is formed from the silica of the ore gangue and unites itself to the bases present, including those which have been added as flux. The matte and the slag, as they flow from the furnace, separate in the forehearth according to specific gravity, the slag then flowing away, while the separated matte is retained.

Much of the ore contains pyrite (FeS_2), and its first equivalent of sulphur is easily driven off by the heat of the upper part of the charge, leaving FeS . This is acted on by the rising air blast with the development of heat thus

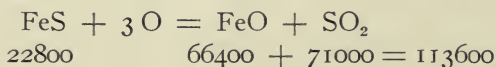

We have heat developed by the burning of the iron and sulphur equal to 137,000 calories, while that used up in the decomposition of the FeS equals 22,800. The difference, 113,000 calories, is the resultant heat of the reaction. Dividing 113,000 cal. by 88, the equivalent of FeS , we obtain 1,300 lb. calories as the heat developed by the burning of one pound of FeS .

It will be noticed that the slow and expensive preliminary roasting of the sulphide ores is dispensed with and that the amount of fuel is small (2 to 6%), because of the heat developed by the burning of the pyrite of the charge. On the other hand, it has been found to be an advantage to use hot blast, which increases

the intensity of combustion at the tuyere-zone, where it is needed for the complete and thorough fusion of the slag, and for vigorous action on the sulphides of the charge. The expense for fuel, to be used in a hot-blast stove, is, however, small compared with the saving of coke made in pyritic smelting over that in regular matte-smelting. Pyrite ore furnishes a considerable amount of iron, which is available for fluxing the silica in iron-free ores that have been added to the charge for the sake of recovering their contained gold and silver values. Where necessary limestone and iron ore, generally the former, are added as flux. An iron matte alone will not remove all the metals from the ore, and it has been found that copper to the extent of 0.5%, and preferably more, should be present in the charge to ensure the collection of the values in the matte. The slag from such an operation will then be nearly free from silver and gold. Copper therefore acts incidentally as a collector of values of gold and silver in the charge. The result of burning off so much sulphur from the ore to the extent of 70 to 80% of its total weight means that only the 30 to 20% left is available to form matte, first with the copper and then the iron, in accordance with its needs. It is this removal, in the furnace, of such large amounts of sulphur which enables one to dispense with roasting and to diminish the quantity of matte (matte fall), so that the concentration, or ratio of charge to matte, is large. Thus, suppose a pyrite charge contains 30% S, and that its volatilization is 80%. The remaining 6% of the original sulphur would make 24% of matte, the matte containing 25% of sulphur. This would mean a concentration of 100% ore into 24% matte, or of about 4 into 1. Again suppose we have a roasted charge, containing 10% sulphur only, but in which, as is the case in a well roasted charge, the sulphur loss is only 20%. Then there will be again 8% of sulphur left for the formation of matte, or as before, 24% on the charge, which is the same degree of concentration as before. So it may be seen that the percentage of volatilization of the sulphur varies with the nature of the charge, being low when using only roasted and oxidized ores, and high where raw ores are used, especially pyrite, where the first equivalent of sulphur is loosely held.

73. PYRITE SMELTING AT LEADVILLE, COLORADO.

The practice at the Bimetallic smelting works was as follows: The object was to collect values of gold and silver in a matte, low grade because of the small amount of copper present in the charge. This matte was again put through another furnace in order to concentrate it and to raise its grade.

At the first smelting there was a concentration of 4 into 1. The furnace produced slag which was thrown away, and matte which was sent to the concentrating furnace. Here the matte, together with silicious ore, was again concentrated, so that the proportion of charge to the matte produced was as 4 to 1, or of low-grade matte to concentrated matte, as 3 to 1. The slag from this furnace was returned to the ore furnace for re-smelting, since it contained enough values to warrant doing so.

74. MATTE CONCENTRATION.

The matte from the blast-furnace smelting of pyrite ore may be as low as 10% in copper, or even lower. In this lies one of the unconsidered drawbacks to pyrite smelting. The matte is too low grade in copper to ship away at once, or to treat for copper; it must be concentrated to a higher grade.

Now if we were to heap-roast this matte, and then run it in a blast-furnace with sulphur-free silicious ores, we would certainly get the copper in a much lessened quantity of matte. There is, however, the expense and delay of this roasting to consider, and it has been sought to smelt the matte raw, together with silicious ore, with the idea of burning the sulphur from the matte so as to produce a concentration. In regular matte smelting, if this were attempted, the matte would run through undiminished in quantity; but, by the newer method, having a limited fuel and an abundant blast, some concentration has been obtained, as mentioned in the description of pyrite smelting as practised at Leadville, Colo. The grade of shipping matte should be at least 50% in copper, when it may be at once converted to blister copper by bessemerizing. However, where this is difficult to attain, lower grade mattes are often made and shipped.

Slag disposal in copper blast-furnace smelting.—The slag from a blast-furnace, being a waste material, is gotten rid of in the cheapest manner possible. In the case of the smaller furnaces, as it flows from the forehearth, it is caught in wheeled slag-pots (called slag-carts). These are taken by men to the edge of the dump and there poured out. As the dump increases in length, however, this becomes an increasing expense,

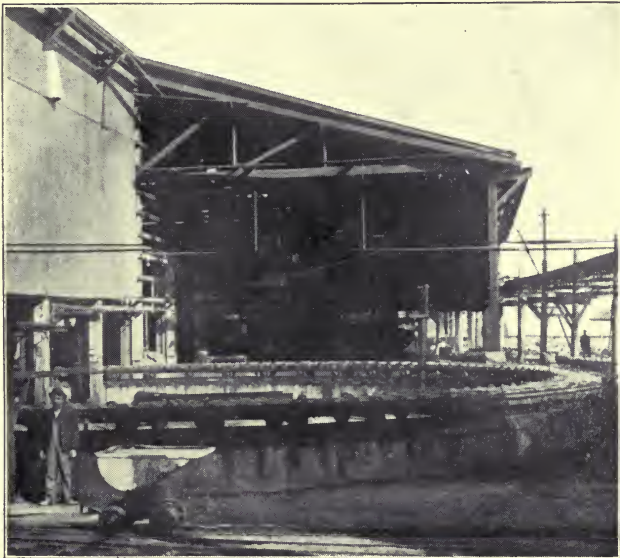
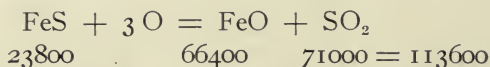

FIG. 122. BENNETT'S SLAG-CASTING MACHINE.

and then large slag cars are used, which run on a track from the furnace to the edge of the dump. These cars are operated, either by horsepower or by an industrial electric locomotive. Another favorite way is to granulate the slag. For this a cast-iron launder is arranged to receive it, and in the launder is a good flow of water. In addition a horizontal flattened jet of water is arranged to strike the falling slag, cooling and breaking it up, when it is swept away in the launder to the dump. The launder should have a grade of one inch to the foot.

75. HEAT EQUATIONS OF THE COPPER-MATTING FURNACE.

In smelting raw sulphide ores containing iron pyrite (FeS_2) or pyrrhotite (FeS), together with copper sulphides (CuS), they are acted on by the heat to drive off the first equivalent of sulphur from the FeS_2 , leaving FeS . The air of the blast acting on this then oxidizes it according to the equation



Now it is to be noticed that where copper is present in the charge it retains sulphur which also takes up iron as FeS to form a mixed sulphide or matte CuFeS . Analyses of matte show that the sulphur varies from 20 to 26% (average 23%), and that the iron and copper together varies from 65 to 72% (average 68%). These approximate figures are useful in calculating a charge.

76. THE REVERBERATORY MATTING FURNACE.

Fig. 115 represents in elevation and Fig. 116 in sectional plan, a large reverberatory matting-furnace, having a hearth 37.5 ft. long by 15 ft. wide, with a fire-box 7 by 8 ft., or 56 sq. ft. area. There are six hoppers for charging ore and one double hopper by which coal can be charged, as needed, to the fire-box. The fire is 'grated' from time to time, when the doors of the closed ash-pit are opened, and men enter to remove the ashes and clinkers from between the grate bars by means of a long-handled pointed bar. This material falls into cars set on a track shown as entering the ash-pit (see Fig. 116). The fire having been cleaned, the ash-pit doors are closed and air is forced into it under low pressure by a pipe (shown on the plan) next to the fire-box. There are four side-doors, two for skimming at the near side, and one front door where the slag is also skimmed. The stack is separate from the furnace, the smoke escaping to it by means of a sloping flue from the outlet-port in the roof of the furnace. On the far side, between the two side doors, may be seen the matte tap-hole set at the level of the bottom of the hearth, from which the matte is withdrawn as it accumulates.

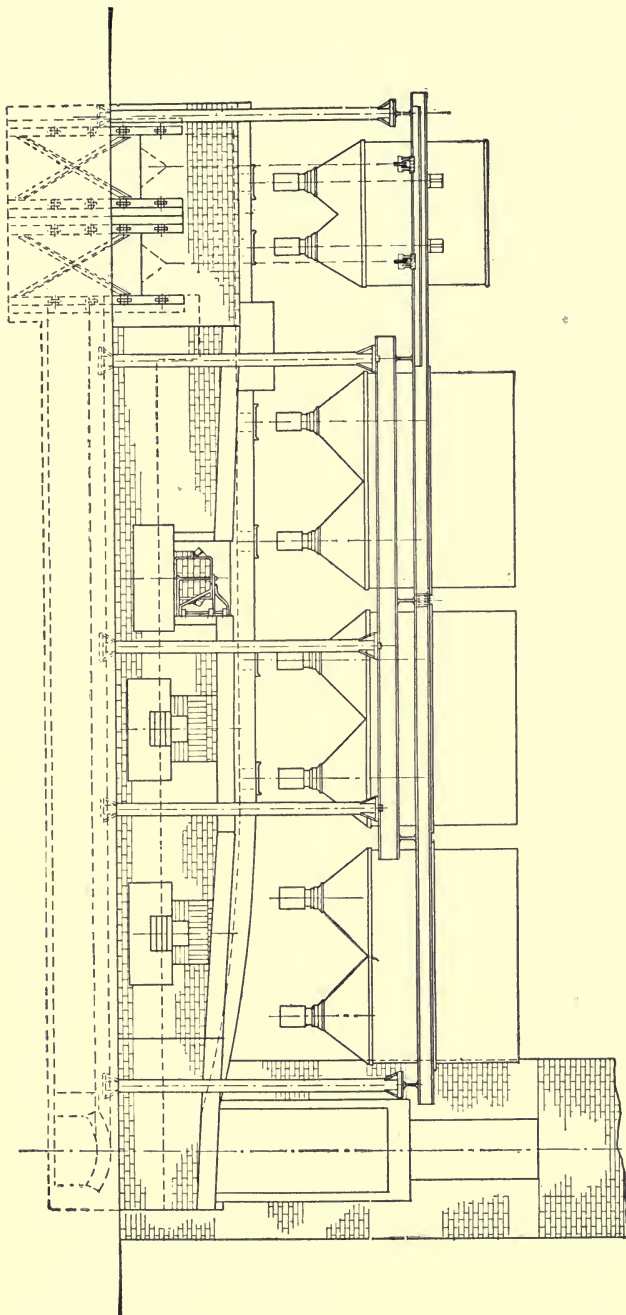

FIG. 115. REVERBERATORY SMELTING FURNACE (ELEVATION).

77. REVERBERATORY MATTE SMELTING.

While the blast-furnace in general affords the cheapest means of smelting copper-bearing ores in lump or coarse form, one objection to it is that the strong blast which must be used sweeps away a good deal of the fine and dusty ore, forming flue-dust. It is true that such flue-dust may be in large part caught in flues, and made into briquettes and re-smelted, but it is always an additional expense which is to be avoided. In fact, fine ore and concentrate are better treated in reverberatory furnaces. At the time of dropping such a charge, the stack damper may be closed, and when the dust has settled again opened, so that the ore is not disturbed until it is melted. Less sulphur is volatilized than in the blast-furnace, and the ore must, therefore, first be roasted. The output of a reverberatory is much less than that of a blast-furnace, and there is much more fuel used, though of a cheaper kind. Thus one would use in reverberatory smelting 21 to 33% of coal as against 10% coke in regular blast-furnace smelting, or as low as 2 to 6% in pyrite smelting. We might say that the 25% of coal at \$3 per ton would just balance the 10% coke at \$7.50 per ton so far as the item of fuel is concerned.

Operation of the furnace.—While in blast-furnace work the charges are put into the furnace continuously, in the reverberatory, a charge of many tons is put into the furnace at once. The ore is stored in hoppers situated above the furnace, into which it falls when the hopper slide is withdrawn. Were the ore to drop directly upon the floor of the furnace, the cold charge would tend to stick there and be heated with difficulty. It is customary, therefore, to retain a pool or layer of matte on the hearth upon which the ore drops and spreads out. At the same time the fire has been cleaned or 'grated' by removing clinkers and ashes. The firing now proceeds vigorously until the charge has been melted down. The sulphur of the charge unites itself to the copper and to the iron to satisfy its needs, and the matte thus formed, separating out in drops, takes up any precious metals that exist. Then by its greater specific gravity as compared with the slag, it finds its way to the hearth. The gangue of the ore yields SiO_2 to unite with FeO , CaO , Al_2O_3 , and with minor bases, to form a fusible

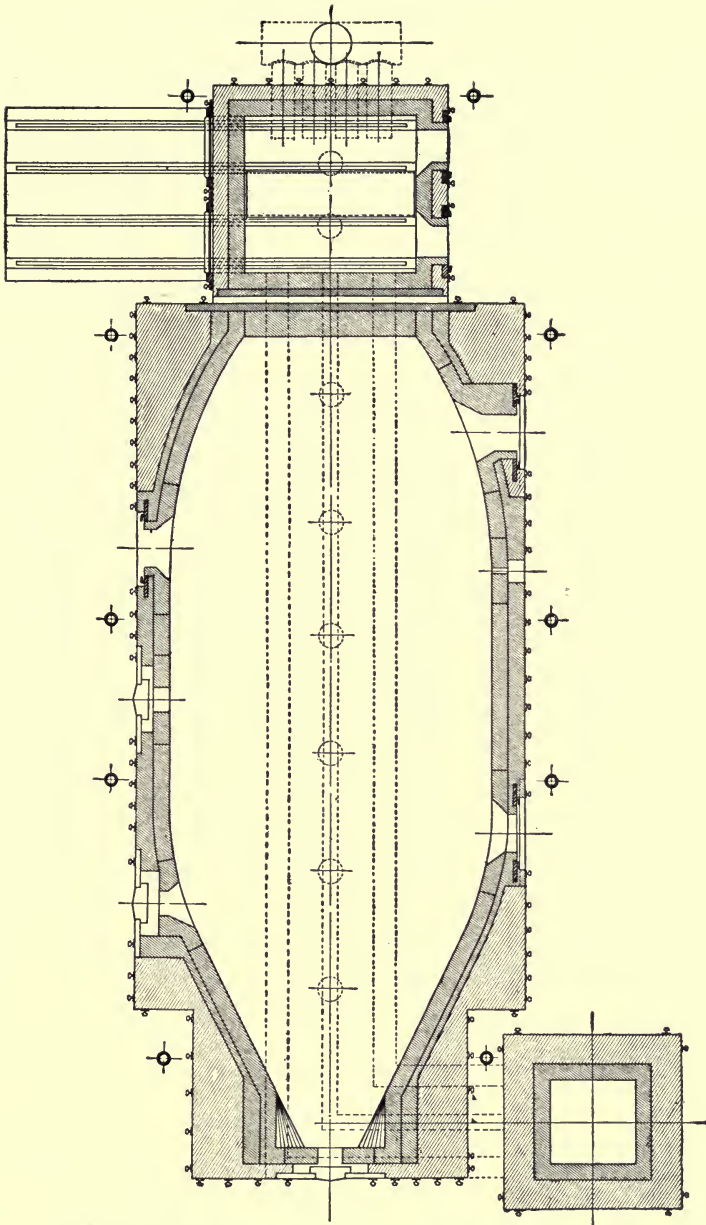

FIG. 116. REVERBERATORY SMELTING FURNACE (PLAN).

slag, which floats upon the matte as a separate layer. The side doors of the furnaces are then opened, and the slag skimmed by means of long-handled rabblers. As the slag is removed it falls either into wheeled slag-carts or into pots which are wheeled away to the dump. The sides of the interior of the furnace, where they appear to have been eaten out or eroded by the action of the molten charge upon them, are now repaired or fettled by sand, placed at the eroded surface with a long-handled paddle, or by balls of ganister, pressed against the side with the same tool. The side doors are now closed and luted tight with a stiff clay mortar, and the charge, already in the hopper, is dropped in. From time to time, as it is needed or as it accumulates, the matte is tapped off at a tap-hole situated at the lowest point of the hearth. The matte runs either into sand molds (depressions made by means of a shovel in the sand floor of the furnace-house) or into ladles, operated by an overhead traveling crane, where it is to be transferred to a converter.

78. REVERBERATORY SMELTING OF COPPER. (WELSH COPPER PROCESS.)

The process consists in treating copper ores by a series of roastings and fusions, which bring up the grade of copper contained in the charge to blister copper, which is subsequently refined. We may divide the process into six operations:

1. *Roasting*.—Sulphide ores, containing copper of from 5 to 15%, are roasted in a hand roaster, until only 5% of sulphur is left.

2. *Fusion*.—These roasted ores are charged into a reverberatory furnace together with such oxidized ores as are available, and are melted down. The sulphur contained in the roasted ore unites itself to whatever copper is present (taking up also some iron) and forms a matte of perhaps 35% copper called 'coarse metal.' The silica, uniting itself to the remainder of the ferrous or ferric oxide and to alumina and other bases, forms a slag, fusible at the high heat of the furnace. The slag is then skimmed off into slag-pots with a rabble, which is inserted at the front-end door. The remaining matte is tapped off at the front-

side of the furnace into a channel or runner arranged in the sand floor, and from this into cavities in the sand to form pigs. This operation resembles that performed at an iron blast-furnace in casting pig iron. The flow of matte is stopped before the furnace is quite empty, some slag and matte still remaining, and another charge is dropped in from the hoppers. Such a charge takes six hours to work through.

3. The coarse metal (matte) from the sand beds is crushed to 5-mesh and passed on to another roasting furnace. Whatever rich sulphides of from 20 to 70% Cu are on hand are also charged in, and with the matte roasted to 5% sulphur.

4. This roasted material is charged to a reverberatory fusion furnace, together with oxidized ores containing from 20 to 70% copper. When the charge has been melted there results a matte called 'white metal,' containing 75% copper and little else than copper and sulphur. As before, the silica from the oxidized ore unites with the ferrous iron and other bases to form a slag. This slag, however, having been made from such rich materials, contains too much copper to be rejected, and is turned back to the fusion furnace described in operation 2.

5. The white metal in pigs is charged into a reverberatory fusion furnace where the pigs are piled up in open order. The fire is gradually increased so that it takes several hours to melt them down. This operation is called 'roasting.' The highly heated air admitted at the fire-box acts on the surfaces of the pigs and upon the drops of matte trickling down from them, converting a portion into cuprous oxide. We thus get copper present both as oxide and as sulphide. Finally, the heat is increased until the whole is melted down. Now occurs the endothermic reaction,

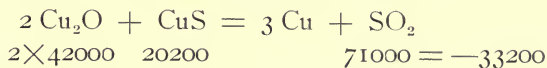

in which copious fumes, boiling up from the surface of the molten charge, are given off. Some slag, rich in copper, is also produced, getting its silica partly from the borders of the furnace and partly from some silicious but perfectly oxidized ore which has been added to the charge. This slag is returned to operation 4. Finally, there is tapped off blister copper, so called because when

cooling, occluded gas seeking to escape forms blisters on the surface of the pigs of metal.

6. The blister copper now contains 98% copper, but also impurities, which must be removed before it is fit for market. This refining process is elsewhere described. In case the copper contains gold and silver, taken up from the ores from which it has been made, it is customary to re-melt it, to pole it to remove copper oxide, and to cast it into anodes for electrolytic refining.

Where copper ores are impure, or where it is desired to obtain a superior grade of copper (called 'best selected'), the process is varied as follows: A portion of the 75% white metal produced in operation 4 is ground up and roasted, thus producing Cu_2O , together with some Cu_2S , due to sulphur still unremoved. This roasted matte is put in a fusion furnace and promptly melted and stirred in, together with lump white metal. A reaction sets in, such as was described in operation 5, a small portion of the copper reducing out from the Cu_2O , and in so doing picking up the impurities present, such as As, Sb, Te, and also contained gold. On the other hand the white metal which remains is quite pure and is capable of giving a pure grade of copper when passed on to operation 5. After skimming the charge, the matte is tapped out as usual into sand molds. In the first few molds will be found the copper which has been reduced, lying at the bottom beneath the matte which forms the body of the pig—whence the name, 'bottoms.' These bottoms can be re-melted and cast into anodes for the electrolytic refinery, where the precious metals can be conveniently extracted.

79. DIRECT TREATMENT OF COPPER MATTE FOR BLISTER COPPER.

In this modification of the Welsh method of producing blister copper, instead of 'roasting' the matte in lump form in the blister furnace, that operation is performed in a separate roasting furnace either of the automatic or of the reverberatory type. The charge for the blister furnace will then consist of 14,000 lb. of 75% roasted 'white metal' or matte, still retaining 4 to 6% of sulphur, 3,500 lb. raw white metal or matte, 4,000 to 8,000 lb. of fowl slag from a former charge and 600 lb. of silicious ore to take

up the FeO and other bases present. When this has been melted down, 6,000 lb. more of roasted matte is added, making the total of matte charged 23,500 lb. and, when fused, the reaction begins. The surface of the charge is seen to be seething with escaping bubbles of gas which are set free according to the reaction:

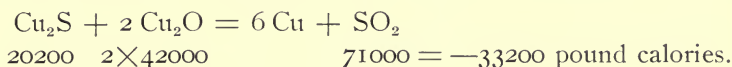

The reaction is endothermic requiring 87 calories per pound of copper produced. The bath is then skimmed to remove the slag, which contains considerable copper oxide, and the blister copper is ready to be ladled into pigs. The method has the advantage that the output is greater than by the old method, and the quality of the copper quite as good. From the above charge there is produced 75 pigs of 230 lb. each, or 17,250 lb. of blister copper, and 23 pots slag of 400 lb. or 9,200 lb. containing 12 to 15% Cu. Where 'best selected copper' is made there is left behind a quantity of bottoms containing impurities. These bottoms may be worked up as follows: A charge is put in the blister furnace consisting of 14,000 lb. of roasted 75% matte, 21,000 lb. of raw matte of the same grade, 8,000 lb. of bottoms and 1,000 lb. of silicious ore. When melted this is followed by 6,000 lb. of 75% roasted matte, the whole charge being 50,000 lb. This is treated precisely like the former charge, but it gives a much higher yield of copper.

80. REVERBERATORY MATTE-SMELTING AT ANACONDA, MONTANA.

Fig. 117 and 118 represent in elevation and plan the No. 1 furnace at the Washoe plant of the Anaconda Copper Mining Co., with two Sterling boilers heated by the waste gases from the furnace and developing 600 h. p. The furnace will treat on an average 275 tons in 24 hours, producing a 40% matte with a concentration of 4 into 1. The charge, consisting of hot calcines from the McDougal roasters, has by analysis 9% Cu, 24.4% FeO, 2.9% CaO, 8.1% S, and 26% SiO₂. Every 80 minutes a charge of 15 tons is dropped into the furnace from the two hoppers nearest the fire-bridge (shown in full lines in the elevation). This falls upon the bath of molten matte and slag. Being hot, it spreads out in all

directions and floats slowly down the furnace toward the front. It is readily melted by contact with the molten slag and matte bath below, and the flame above it. In this great reservoir of heat there is but little variation of temperature, and the flame is transparent. Because of the width of the furnace, the sides are less corroded than in a narrower one. The fuel is soft coal, 56 tons or 21% of the charge being burned daily upon 110.7 sq. ft. or grate area, or 40 lb. per sq. ft. hourly. Every four hours 45 to 50 tons of slag is in 15 minutes removed from the furnace, it being allowed to flow off by the front door in a thick stream, which, as it falls toward the waste launder, is granulated by a strong horizontal stream of water, which also sweeps it away to the dump, situated at some distance from the furnace. The matte is kept at nearly the same level, some 10 tons being tapped out at a time, while the total amount of it in the furnace may be one or two hundred tons. The action of the slag upon the furnace is to corrode or scour it, especially at the fire-bridge. It must therefore be repaired. This is done monthly by drawing off the slag and matte completely and throwing in sand or silicious ore against the corroded sides until they have been effectually banked up. One of these furnaces will run for six or eight months before it has to be shut down for renewal of the corroded parts and repair of the roof and sides. The exposed inner surfaces of the furnace are composed of silica brick which is practically infusible but which expands in heating so that an allowance has to be made for it by leaving transverse slits in the roof. These close up when the brickwork is at its full temperature. An important point in effectual working is the outlet flue or neck, 60 by 38 in. in dimensions or 16 sq. ft. area, which must be large enough to produce the draft and yet hold back the flame through the furnace. At the fire-box the ash and cinder, as they fall, drop into a stream of water which carries them away. Hence this place is always cool and accessible, and the fire is kept constantly clean and properly 'grated.' A good deal of coke or cinder from the coal falls down, and this is later concentrated to remove the ashes and clinkers. This residue, still having a good deal of heat value, is used to mix in with the flue-dust in the making of briquettes for the blast-furnace.

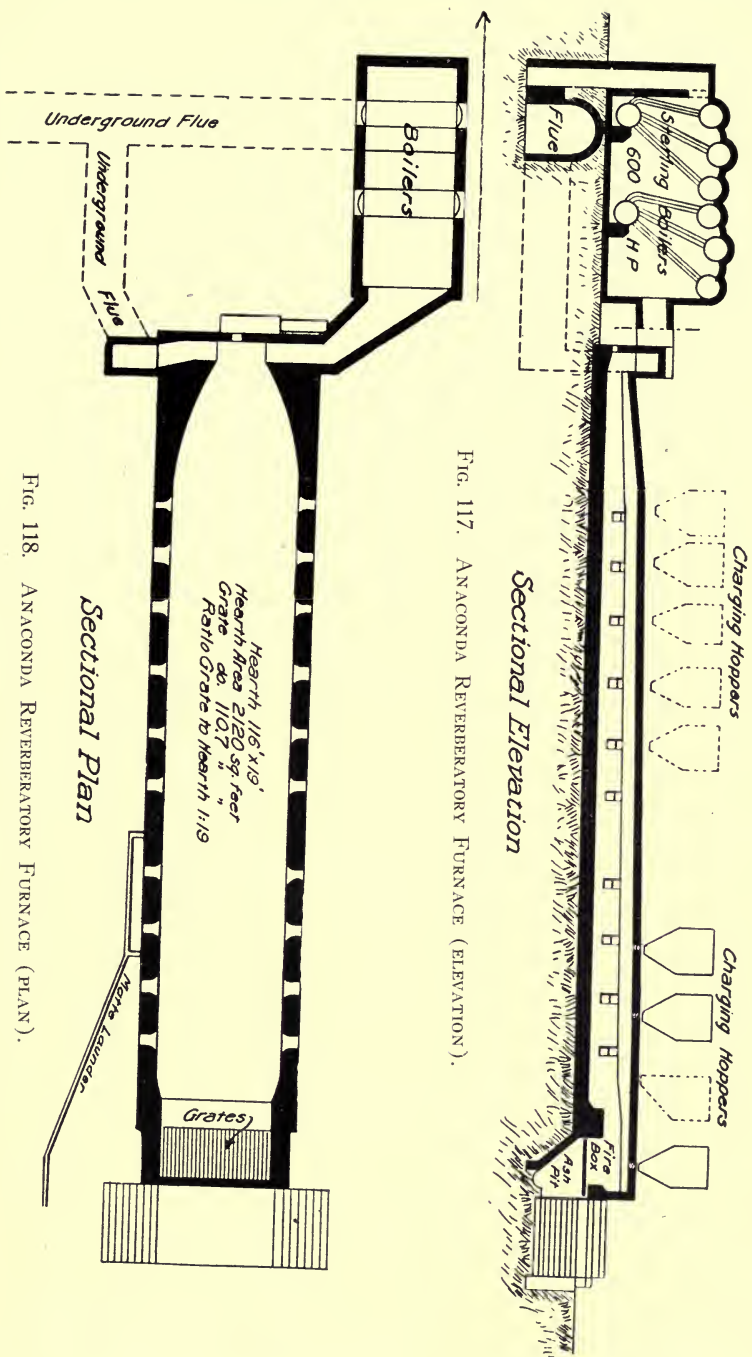

FIG. 117. ANACONDA REVERBERATORY FURNACE (ELEVATION).

FIG. 118. ANACONDA REVERBERATORY FURNACE (PLAN).

81. HENDERSON PROCESS FOR EXTRACTION OF COPPER FROM BURNT PYRITE.

The residue or cinder left from pyrite used in sulphuric acid making may contain from 2 to 4% Cu, together with some silver and gold; and all these metals can be extracted from it by a chloridizing roast, followed by a leaching with water and a precipitation with scrap-iron.

Fig. 119 gives a plan and transverse sectional elevation of a 200-ton plant of the Pennsylvania Salt Manufacturing Co., Natrona, Pa. It is operated as follows.

The cinders (roasted ore) are ground dry in a pan-mill, similar to a Chilean mill, to 20-mesh, and mixed, during the operation, with 12% of their weight of salt. The mixture goes by belt-elevator to storage bins commanding the charge-floor, *k*, of the roasting furnaces, *b*. It is weighted in charges of 5 tons to the charge-tubes or hoppers of the roasters, represented in the longitudinal sectional elevation in Fig. 120. The four 20-in. charge-tubes are clearly shown.

The gases from the fire pass along the 14-in. space above the main furnace or muffle, and going down the flue at the end, return under the 8 by 35 ft. hearth of the muffle. Finally, they pass by a main underground flue, 2 ft. by 2 ft. in size, to a common stack. The gases from the roasting ore pass by an 18-in. pipe to the condensing towers, *a*, where they pass upward through coke in lumps. Water trickles down through this coke from above, absorbing the chlorine and the hydrochloric acid developed from the gases. For such a chloridizing roast, muffle furnaces have superseded the reverberatory, since the former kind has the advantage of needing but one-half of the condensing capacity, and better results are obtained, due to the separate control of the fire and of the gases of the reaction.

Enough raw pyrite is charged with the ground cinder to bring the proportion of sulphur to 1.5 times the contained copper. The whole is brought to a just-visible red heat (525° C) and kept well stirred. The total time for a charge is 8 hours. The finished charge is drawn upon the floor, allowed to cool, shoveled into charge-cars, elevated to the charge-floor level, and delivered to

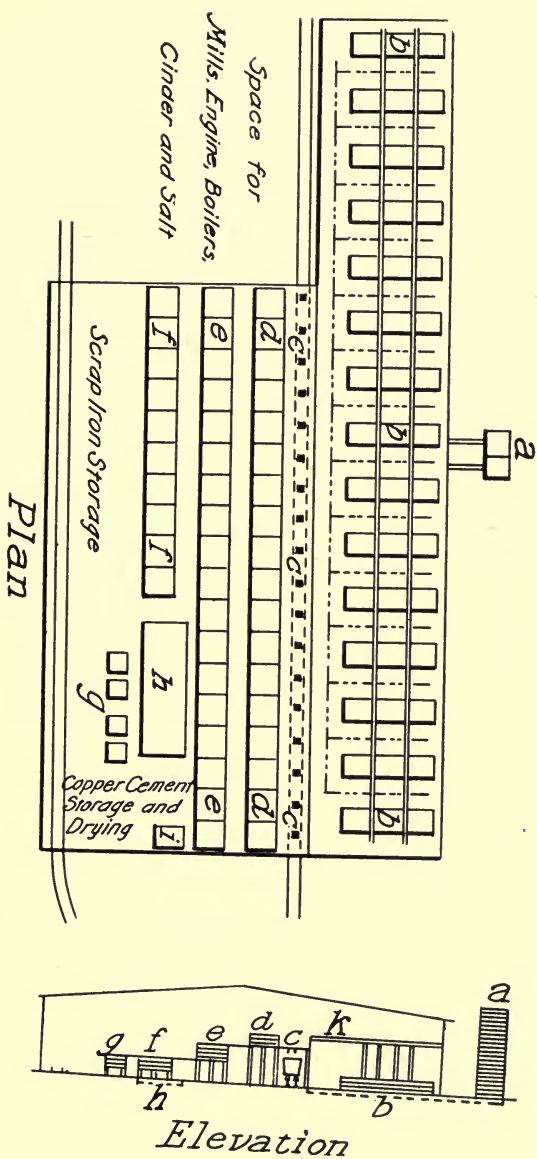

FIG. 119. HENDERSON-PROCESS PLANT.

the leaching tanks, *d*, 12 by 12 by 4 ft. in size. These tanks are made of three-inch plank filled in the 3-in. space between the inner lining and the outer shell with a mixture of 1 to 1 sand and tar. The false bottom of the leaching tank is made of a paving of brick covered with small pieces of refuse coke. The calcined ore is first lixiviated by weak liquor from a previous operation, then by water, and finally by the weak hydrochloric acid from the condensing towers, all being run to the settling tanks, *e*, 12 by 12 by 6 ft. in size. The first removes the bulk of the copper, becoming a strong solution, the second becomes the weak solution for the succeeding operation, and the third dissolves cupric oxide and cuprous chloride otherwise insoluble. The residue (purple ore) from the leaching vats is shoveled out upon the floor *c*, thence to be loaded upon railroad cars set below. The weak liquors are pumped back to the lixiviation tanks, and the strong, when they have reached 18° Beaumé, are drawn off to the tanks, *f* (12 by 12 by 6 ft.), where the contained copper is precipitated by means of thin scrap-iron. The tanks have open-slat false bottoms about 2 ft. above the real bottom. Live steam, blown into the solution, agitates it, and the copper precipitate works down between the slats upon the real bottom, and is removed to the tanks, *g*, 10 by 10 by 5 ft. The chloride solutions from this tank flow over scrap-iron placed in the small vats, *h*, containing scrap-iron, which catches any escaping particles of precipitate. The latter contains 90% Cu, 35 oz. Ag and 0.15 oz. Au per ton.

Before precipitating the copper it would be possible to remove the silver by the Claudet process, precipitating it by means of zinc iodide. It has been found, however, more profitable to sell it direct to the blue vitriol makers, who pay for 95% of the silver and for the full value of the contained copper and gold.

The cost of treatment by the Henderson process, with common labor at \$1.50 per day, is \$1.87 per ton.

82. THE HYDROMETALLURGY OF COPPER.

Extraction of copper by wet methods.—This consists in getting the copper into aqueous solution, with or without the aid of solvents, the copper being in combinations suitable for solution. It

is then precipitated by metallic iron (iron scrap) or other precipitant, the precipitate, contaminated by small pieces of scrap-iron and iron rust (iron salts) being melted down and refined in a reverberatory furnace. In order to extract copper from the ore, the latter must be put in form to be acted upon, either by crushing or by roasting.

Copper can be profitably extracted from suitable low-grade copper-bearing ores of as low as 0.5 to 1% Cu, especially where labor is cheap.

Ores containing quantities of lime, magnesia, ferrous oxide or manganese are, however, not suited for wet processes. Ores containing poor oxides, carbonates, or sulphates, and having a quartz gangue, are the best. Copper sulphides should, however, be added to this list, since they may be converted into sulphates, either (1) by natural decomposition, or (2) by a slow roasting of the ore. Copper sulphides can also be converted into cuprous or cupric chlorides which, again, are soluble in common salt. If the ore contains limestone, then by roasting in a kiln, caustic lime can be produced, capable of being leached out by water. Afterward the ore can be treated for the extraction of the copper.

Extraction of copper, rendered soluble by natural decomposition.—In mines, a gradual oxidation, due to the action of air and moisture goes on, so that mine water becomes impregnated with copper sulphate which gives it a blue tint. Such water, run through boxes or launders containing scrap-iron, precipitates out its contained copper, which replaces the iron of the scrap. Thus we have a source of revenue. At Jerome, Arizona, such waters are run through extended troughs or launders containing scrap-iron.

Pyrite leaching at Rio Tinto, Spain.

This well-known method, adopted for the extraction of copper, consists in allowing huge heaps of the mineral to oxidize under the influence of air and moisture, and, subsequently washing out the copper sulphate as it is formed by running water through the heap. The copper is precipitated from this solution by pig iron. When the copper occurs as chalcopyrite, CuFeS_2 , or as covellite, CuS , oxidation proceeds slowly. The best form

is chalcocite or copper glance, Cu_2S , which, with pyrite, FeS_2 , constitutes the bulk of Rio Tinto sulphide. When the mineral is subjected to the combined influence of air, heat, and moisture in the heaps, the following reactions take place:

1. $\text{FeS}_2 + 7\text{O} + \text{H}_2\text{O} = \text{FeSO}_4 + \text{H}_2\text{SO}_4$, and this ferrous sulphate easily oxidizes to ferric sulphate.

2. $2\text{FeSO}_4 + \text{H}_2\text{SO}_4 + \text{O} = \text{Fe}_2(\text{SO}_4)_3 + \text{H}_2\text{O}$.

This ferric sulphate now acts on the copper glance, and the contained copper is rendered soluble thus:

3. $\text{Fe}_2(\text{SO}_4)_3 + \text{Cu}_2\text{S} = \text{CuSO}_4 + 2\text{FeSO}_4 + \text{CuS}$

and the cupric sulphide is changed as follows:

4. $\text{Fe}_2(\text{SO}_4)_3 + \text{CuS} + 3\text{O} + \text{H}_2\text{O} = \text{CuSO}_4 + 2\text{FeSO}_4 + \text{H}_2\text{SO}_4$.

Reaction 3 is fairly rapid, causing about half the copper to go into solution in a few months, reaction 4 is much slower, and yields, under favorable conditions, 80% of the remaining half of the copper.

The method of working is as follows: A site is chosen where the ground is sufficiently sloping and concave to enable the copper solution to collect and to run out at one side of the heap, which may contain 100,000 tons. On the ground is first arranged a network of air flues 12 in. square, made of rough stones. At 50 ft. distant from one another vertical chimneys, also of rough stones, connecting with the flues, are built up as the heap rises. The ore is crushed to not more than 3 or 4 in., and the lump and fine are separated. Lump ore and fine are alternately dumped until the height of the level-topped pile is 30 ft. The surface of the pile is formed into squares by ridges of fines. The squares are to ensure more even distribution of the water to the heaps. Launderers are also provided to conduct water to all parts of the top surface of the heap. As the heap is being formed water is run on to extract any already existing copper sulphate. Oxidation also starts as the result of the wetting. The completed and wetted heap begins to oxidize pretty rapidly, as shown by the heat produced, the temperature in the chimneys rising to 80°C . As the temperature rises, the lower surface openings should be closed to control oxidation and spread it through the heap. The surface assumes a brown color due to dehydration of the basic ferric salt

which forms, and the gradual heating up may be noted by this drying action. The greatest care must be taken to prevent the heap from firing. When oxidation has proceeded as far as safe, water is run on at the rate of 220 gal. per minute until soluble copper salts are leached out. The heap is again allowed to oxidize and the washing out repeated. After a year the top surface needs 're-tilling,' the ridges are arranged where the squares formerly were and the launders are also shifted. At the edge of the heap, for a distance of some yards, the ore, which has become cemented, hold much copper salts, and is here dug down into terraces in order that this copper may also be extracted by washing. When there remains but 0.3% copper, the ore may be called leached.

The copper liquor which runs from the heap contains ferric oxide, and this must be reduced by running it over a filter-bed of fresh mineral. This bed is placed within a reservoir formed by a masonry dam across a small ravine. The liquor, after percolating the bed, remains in contact with it until drawn off to the precipitating tanks. The solution contains 0.4% Cu, 0.1% Fe_2O_3 , 2% FeO, 1% H_2SO_4 and 0.03% As. The large quantity of FeO and of H_2SO_4 is due to the fact that a part of the waste liquor from the precipitation tanks is pumped back and used for watering the heaps, so that the solutions tend to concentrate. The liquor at the reservoirs is run through precipitation tanks over pig iron piled up in open order therein, to precipitate the copper in the form of 'cement' copper or 'copper precipitate.' These tanks are arranged on the slope of a hill, the liquor passing back and forth through the tanks until discharged from the lowest tanks free from copper. Some of the tanks are cut out of the system, or by-passed daily, the liquor meantime going through the remaining tanks. All iron is removed from these cut-out tanks and piled up, the copper on the iron being meanwhile knocked off and thrown back in the tank. The dirty-looking precipitate is now removed to the cleaning and concentrating plant, while the iron is piled back in the tank and the liquor again turned through it.

The crude precipitate, containing 70% copper, is by means of a strong jet of water gradually worked over and through a perforated copper plate placed at the head of a launder. The over-size of the screen, made up of leaf-copper and small pieces of

iron, is thrown into a heap and picked over by girls, who remove the scrap-iron. The fine, which passes through the screen, is turned over against a stream of water which washes out the dirt and lighter particles, leaving the copper behind. For a few yards at the head of the launder is to be found No. 1 precipitate of 94% Cu, 0.3% As, then comes No. 2 precipitate of 92% Cu, followed by No. 3 precipitate, quite fine and containing 50% Cu, 5% As, the graphite of the pig iron, and the bulk of the bismuth and antimony coming from the liquors. No. 1 and 2 precipitate are sacked for shipment and No. 3 precipitate is added to a blast-furnace matting-charge.

The old Hunt-and-Douglas process for the extraction of copper.

This method depends upon the fact that copper oxide is decomposed by ferrous chloride solutions, forming insoluble ferric oxide, while the copper goes into solution as cuprous and cupric chlorides. The copper is then precipitated by iron, the ferrous chloride solution being regenerated, and needing only a little salt to fit it for use again. As the copper must be in oxidized form to go into solution, the ore must be crushed and then roasted to convert most of the copper into oxide or sulphate.

The ore is dry-crushed through rolls, to about 4-mesh, fine enough for roasting. It may then be roasted, preferably in one of the automatic roasters already described. The roasted ore is placed in tanks, which have been carefully coated with asphalt paint to resist the action of the solutions. The percolating solution is made by dissolving 120 parts of ferrous chloride in 1,000 parts of water and adding 280 parts of green vitriol ($\text{FeSO}_4, 6 \text{H}_2\text{O}$). To this solution common salt is added, and, by standing, sodium sulphate crystallizes out, leaving a mother liquor, which is used for the percolation. The reaction by which the copper oxides in the ore go into solution is as follows:

1. $3 \text{CuO} + 2 \text{FeCl}_2 = \text{Cu}_2\text{Cl}_2 + \text{CuCl}_2 + \text{Fe}_2\text{O}_3$. While the Cu_2Cl_2 is not soluble in water, it is taken up in presence of the common salt in the liquor.

2. $3 \text{Cu}_2\text{O} + 2 \text{FeCl}_2 = 2 \text{Cu}_2\text{Cl}_2 + \text{Fe}_2\text{O}_3 + 2 \text{Cu}$ and

3. $2 \text{Cu} + 2 \text{CuCl}_2 = 2 \text{Cu}_2\text{Cl}_2$, which again is soluble in the salt liquor.

The copper-containing solution passes to precipitating tanks or launders containing scrap-iron or pig iron, and the copper is precipitated. The consumption of iron by this method is small as compared with the amount needed in precipitating copper sulphate, since much of the copper is present as cuprous chloride. In precipitating copper sulphate 2.5 to 3.5 lb. iron is needed to precipitate a pound of copper.

New Hunt-and-Douglas process for the extraction of copper.

Referring to the old Hunt-and-Douglas process we find that the copper has been removed from the roasted ore in a specially prepared ferrous chloride solution. In the new process instead of using scrap-iron for precipitation, the copper is obtained by passing a current of sulphurous acid gas through the solution. A white heavy cuprous chloride is precipitated which can be readily decanted and washed. Sulphuric and hydrochloric acids are generated in the solution, which only needs the addition of some common salt to make them ready for further use. One great advantage of the method consists in the rapid dissolving of the oxidized copper present by the strongly acid solution, which attacks even sulphides with considerable energy. And lead and silver present remain undissolved.

Neill process for the extraction of copper.

The process depends upon the use of sulphurous acid for the leaching out of the copper. It is preferably used on oxidized ores such as native carbonates and oxides, which are readily soluble in sulphurous acid with the formation of cuprous sulphite Cu_2SO_3 . The salt is soluble in water containing sulphurous acid, but not in water alone. The process is suitable also for sulphide ores which have been roasted. Lime and magnesia are objectionable because they use up some of the sulphurous acid.

For the oxidized ore, crushing is performed by means of rolls, which reduce it to 20-mesh size. It is then charged into leaching tanks, and is mixed with water containing SO_2 gas. The sulphurous acid is generated, preferably by roasting sulphide ores in a pyrite-roaster, together with a sufficient supply of air. The gases thus produced and containing 3 to 5% SO_2 , are driven through the pulp in the tank by means of an air-compressor, thoroughly satu-

rating the whole. From the tank the ore passes to filter-presses where the solution is removed, the residual tailing being then sent to waste. The solution passes now to precipitating tanks, where it is heated by steam to the boiling point, thus driving off the SO_2 gas. In consequence, the copper is precipitated as cupro-cupric sulphite ($\text{CuSO}_3, \text{Cu}_2\text{SO}_3 + \text{H}_2\text{O}$) a heavy crystalline compound of a dark red color and containing 49.1% Cu. The solution from the precipitating tank is now run to vats containing scrap-iron, as a precaution to ensure the removal of the last traces of copper. The precipitate readily settles out of the solution, is washed by decantation, dried and reduced and melted to metallic copper in a reverberatory furnace. The process has the advantage that a unit of copper converted into cuprous sulphide needs but one-half the sulphur required to convert it into cuprous sulphate. Cuprous sulphite is here precipitated from its solution without the use of scrap-iron, a great advantage in remote districts where transportation would be high. Sulphurous acid acts but little on other metals, and thus furnishes a purer copper.

83. THE COPPER CONVERTER.

In the making of steel by the bessemer process the upright converter is used, but in performing the same operation upon copper, the trough or barrel converter is preferred, called also the Leghorn converter, from the city in Italy where it was first used.

Fig. 121 represents such a converter with the mechanism for revolving or tilting it. It is made of heavy steel-plate in two sections, so that the top can be lifted off leaving the interior accessible for relining. To one side of the shell is bolted a cast-iron wind-box fitted with tuyeres. To one head, concentric with the axis, is bolted a cast-steel open gear, which engages with a steel rack connected to the piston of a hydraulic cylinder carrying a pressure of 300 lb. to the square inch, and, by means of this rack, the converter is tilted. 'Carrying rings' made of heavy T-rail are bolted to the shell and rest upon four friction-rollers carried by heavy cast-iron base-frames. Two inclined tie links will be noticed at the front of Fig. 121 which hold the rack meshed into the gear. When the converter is to be removed it is lifted off its

rollers by a 40-ton overhead traveling-crane. The rack, which is jointed at the head of the piston, is then swung forward into gear by turning an eccentric pin at the foot of the tie-links. A four-way valve, adjoining the cylinder and controlled by a hand wheel (seen next to the rack, Fig. 121), serves to operate the converter. There are four eyes riveted both to the converter and to its top by which the four-fold lifting chain is attached.

This illustration shows a two-stand converter-plant. In the foreground, at the left, are the matte ladles which are handled by the crane. Above and back of the converters is the outlet flue where the fumes from the converters escape. Hoods attached to the front side of the flue receive the fumes.

84. CONVERTING COPPER MATTE TO BLISTER COPPER.

Before a converter receives its first charge of molten matte, it has been dried out and heated to a low red by a fire of wood, followed by coke, urged by a blast introduced at the tuyeres. A newly lined converter of the trough type, 7 ft. in diam. by 10 ft. 6 in. long, will take as its initial double-charge 5 tons, and a final double-charge, just before relining, of 12 tons. A charge for a converter is tapped from a furnace forehearth or from a reverberatory furnace into a steel ladle managed by an electric traveling-crane. The charge is then brought to the converter and poured into its spout. (The ladles are 5 ft. diam. by 3 ft. 10 in. high, are lined with ordinary loam plastered on by hand and dried by a wood fire.) The converter is turned into its normal position, a full pressure of blast being, at the same time, let on.

Now begins the first, or slag-forming, stage of the process. The end of this stage is determined by the appearance of the issuing flame, the greenish border of the flame having given place to a pale, permanent blue as all the iron becomes oxidized. Supposing that we are treating a 50% matte it would be in composition much as follows, 50% Cu, 20% Fe and 24% S, and corresponding to the formula or Cu_2S , FeS , together with a little Fe_3O_4 . As the blowing proceeds the following reactions occur. The FeS is changed to FeO as follows:

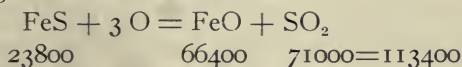

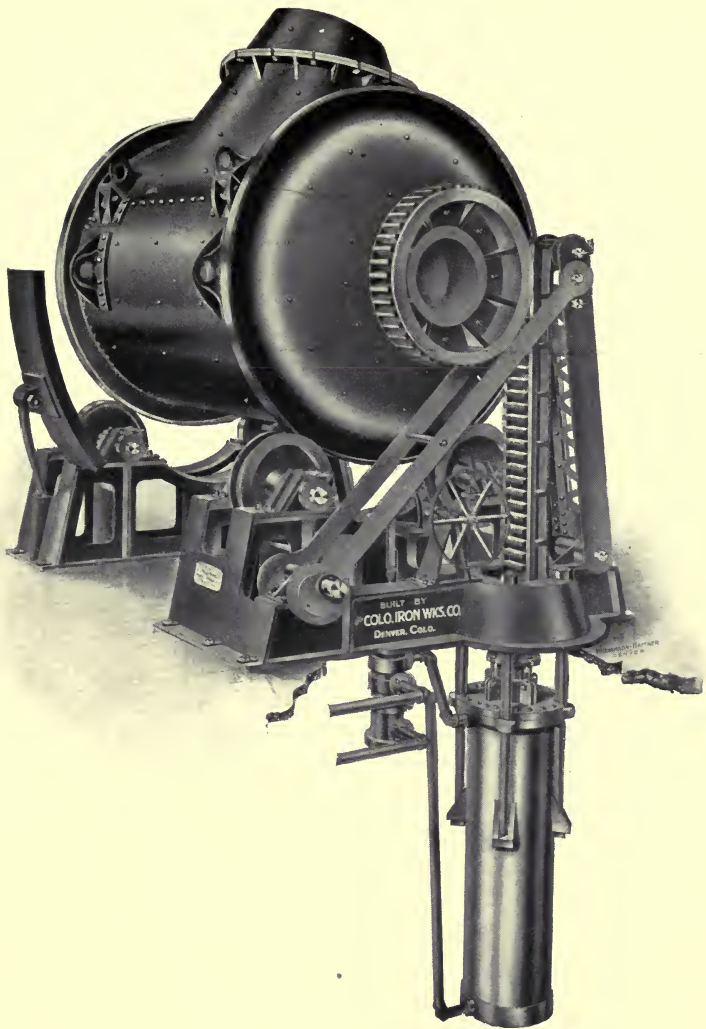
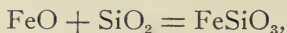

FIG. 121. COPPER CONVERTER.

This FeO takes up silica from the lining thus :



and forms a slag, into which also goes the alumina of the lining. The slag, thus formed, is poured from the converter into a ladle by turning it down. As the slag flows out, the converter man passes a rabble through it from time to time. He can tell when the matte is beginning to escape, whereupon he signals for the converter to be returned to its normal position, and the blast pressure to be turned on, in order to continue the blow. At this stage the copper has been brought up to white metal of 76% copper. The slag, still containing 1.5 to 2% of copper, and, say, 0.5 to 1.0 oz. silver per ton, is sent back to the furnaces to be re-treated to recover the copper and silver. Some pieces of cold matte may be thrown into the converter to help, by oxidation, to make the charge hotter, and with the slag not wholly poured out, to make a covering for the metal. Under normal conditions the escaping flame is of a bluish white, gradually changing to a rose red, and finally to a brownish red. It lessens in length and volume until, at last, there is only a brick red flicker in the escaping gases. The determination of the completion of the operation requires care and experience, since, if carried too far, over-blown copper may result. In this second stage of blowing, the oxidation of the sulphur still retained by the copper, proceeds, so that we have $\text{Cu}_2\text{S} + 3 \text{O} = \text{Cu}_2\text{O} + \text{SO}_2$, and the Cu_2O thus formed, reacting on other Cu_2S , produces copper with an evolution of sulphur dioxide as follows: $\text{Cu}_2\text{S} + 2 \text{Cu}_2\text{O} = 4 \text{Cu} + \text{SO}_2$. So far as the agitation by the air will permit it, the molten material in the converter tends to separate into layers as follows: An increasing layer of copper at the bottom, a decreasing layer of matte above it, and a cover of slag. The blast entering at the side tends to blow through the matte floating above the forming copper.

So soon as the contents of the converter have been changed to copper, the converter is turned down, the blast shut off, and the copper poured into molds, which have been mounted on a carriage running on a track beneath the converter. The resulting pigs weigh 250 to 300 lb. each. The converter is now turned back into the receiving position and the next charge promptly poured in.

The first charge for a newly lined converter is necessarily small, but, as the eating out of the lining proceeds, and more room is given, it is greatly increased, as has already been stated.

In converting the higher grade matte, the process as above outlined is simple, but for lower grade mattes of 35 to 45% copper, the methods are modified by 'doubling,' as it is called. Thus, in a newly lined converter, a charge of 2 tons is introduced, and this is blown, through the first stage, to white metal. The converter is turned down, the slag poured off and, upon its return to the receiving position, 3 tons more of matte is added, making a double charge of 5 tons in all. This is blown, the slag removed and then finished to blister copper. The advantage of this procedure lies in the fact that there is an increased output, and that there is enough white metal produced and blister copper formed to properly fill the converter and to make a sufficient pouring of blister copper.

The final charge is given at 12 tons, and since large charges are the most profitable, there is a temptation to press operations to the limit. The lining becomes dangerously thin, showing a red hot spot on the shell. Sometimes this spot can be kept cool by a stream of water from a hose, and the charge finished, but if not, the charge must be poured out and transferred to another converter.

The time taken for converting copper matte will average 40 to 45 minutes for the first and 50 minutes for the second blow; 20 to 30 minutes are needed for the charging, skimming, and poling, or we may say that a blow will last 2 hours in all. On a new charge, it may be as little as an hour, and for a final charge, as high as two hours. A converter will last from 5 to 9 charges, according to the grade of matte and the durability of the lining. Low-grade matte, of course, corrodes the lining most rapidly. The blast pressure may average 13 lb. per square inch.

85. RE-LINING THE CONVERTER VESSELS OR SHELLS.

The old way of cooling, after removing the top, was to cool the interior of the vessel by means of a stream of water from a hose, and then re-line. The objection to this is that the water,

taking up copper salts, would have a corrosive action on the shell, eventually weakening it; consequently it has been abandoned. One may see the effect of such corrosive action upon the rails beneath the converter where they have been frequently wet from spilled or escaping water.

The lower section, being set on its side by means of the crane, is cleaned from adhering matte and slag by cutter bars so that the new lining may have a new and clean surface of attachment. The body is then set upright and the bottom lining tamped in to within 6 in. of the tuyeres. A sectional rectangular tapering iron shell or form is now put in to make the interior cavity. Around this the lining mixture or ganister is firmly tamped by means of heated iron tampers or rammers to the top of the form. The form is removed and the tuyere openings are now punched through. The top section is put on and bolted fast. The workman then enters the converter and completes the lining with balls of ganister composed of 72% quartz and 28% clay. The shell is dried out by putting in a fire of a little wood, followed by coke, a light fan blast being also admitted at the tuyere openings. It is important to have enough converters, that they may be thoroughly dried out and heated before using, since, otherwise, the life of the lining is much lessened. The shell is now ready to place upon the stand.

Re-melting copper matte.

The older way of preparing copper matte for converting was to re-melt the matte, which had been tapped off into molds at the reverberatory or blast-furnace. This was done in a circular blast-furnace or cupola, such as is used for melting pig iron at the iron foundry. The furnace was driven at a rate such as would give the needed supply of matte to the converters, a somewhat deep crucible being used. The matte was tapped in sufficient volume to fill the converter, and if there was not enough to do this at one tapping, more was drawn off as fast as it could be melted. Meanwhile the converter would be blowing the first portion. The matte flowed from the cupola by means of a clay-lined launder to the converter.

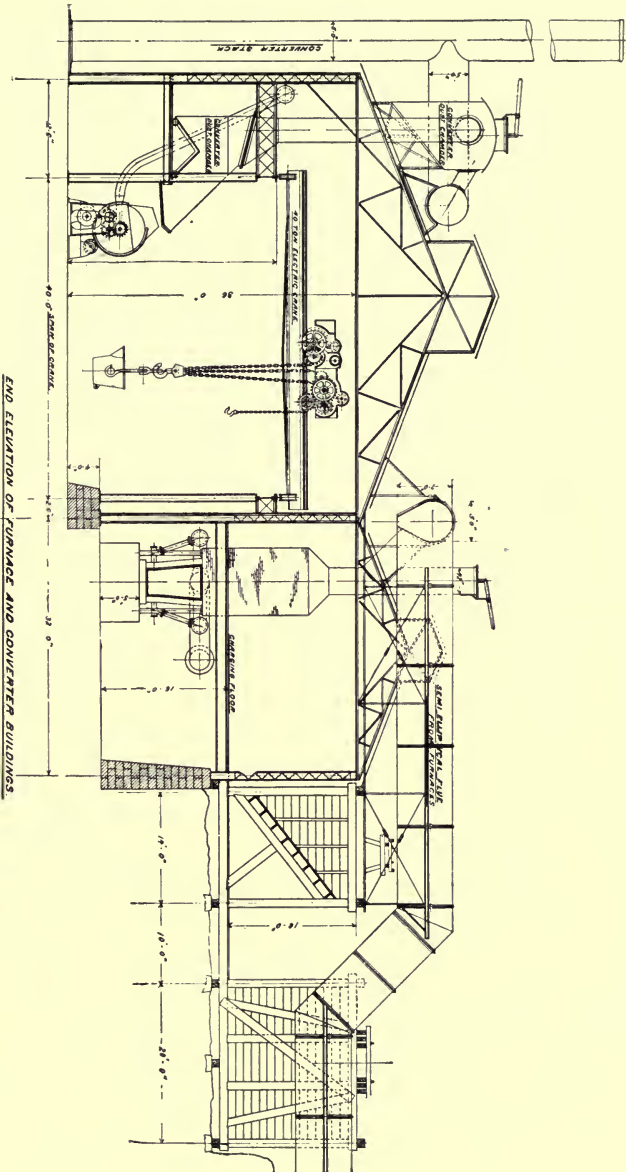

FIG. 123. TWO-STAND CONVERTER PLANT (ELEVATION).

Necessity of a silicious lining.

For the reason that FeO is developed as the result of the blow, it must have silica with which to combine. Were it not for its presence, an infusible mass of iron oxide would soon accumulate within the converter. It would not be possible to run with a basic-lined or water-jacketed shell. This has been several times undertaken, since it would save the very considerable expense and time lost in re-lining, but such experiments have always failed. The life of the lining is less as the grade of matte is lower because, with so much FeO coming from it, a more basic slag is formed. The lining also falls off in lumps owing to this higher corrosive action. When converting 60% Cu matte, the slag will contain 40% SiO₂, while with 35% Cu matte, the resultant slag will be found to contain but 25% SiO₂.

86. ACCESSORIES OF A CONVERTER PLANT.

The size of a converter plant is indicated by the number of stands or stalls at which copper can be blown. Fig. 123 and 124 are illustrations of a two-stand plant. In addition, there should be at least two extra shells for each stand. Thus, while one shell is in place and being used, the two others are being taken apart, cleaned out, re-lined and dried, ready to take the place of an exhausted shell from the stand. To handle these shells, to bring matte to the converters, and to take away slag (and copper also where a re-melting furnace is used) the steady service of a 40-ton electric crane is needed. This crane (see Fig. 123 and 124) having a span of 40 ft. travels from end to end of the converter-house. Both matte and slag are transferred from the forehearth of the blast-furnace, or from the reverberatory, by means of cast-steel ladles (Fig. 125), which have been lined with a clayey loam. The ladle should be large enough to take a charge of 5,000 to 12,000 lb. of the matte which is to be poured into the converter. The ganister for lining may be a mixture of quartz rock, coarsely ground in a Chilean mill or wet pan (Fig. 126), together with 15% of clay, or it may consist of a silicious gold or silver-bearing quartz ore mixed with clay. The advantage of the use of the ore is, that its contained values in

gold or silver go into the copper as the lining is consumed. To blow the air at a pressure of 8 to 15 lb. per square inch, a horizontal blowing engine is generally used, capable of delivering 300 cu. ft. of free air per tuyere of the converter or for a converter as shown in Fig. 127, 2,500 to 3,000 cu. ft. of air per minute.

Beside the Chilean mill (or wet pan), already mentioned, there is a rock-breaker for coarsely crushing the quartz rock, and a fan for supplying air under low pressure to the fires in the converter shells, which have been lined and are being dried out. The converters are operated by a hydraulic cylinder supplied by water



FIG. 125. CAST-STEEL LADLE.

under a pressure of 175 to 500 lb. per square inch. To regulate this pressure a hydraulic accumulator (Fig. 128) is employed. This consists of a fixed vertical cylinder in which slides a weighted plunger. When the water is quickly used the plunger falls, thus regulating the supply according to needs and keeping up the required pressure. The water is supplied by a duplex pump, as shown in the figure, pumping against the weighted plunger.

Where it has been attempted to cast copper from the converters into molds for the formation of anodes, the molten metal is in such an agitated condition, owing to the occluded gases, that the

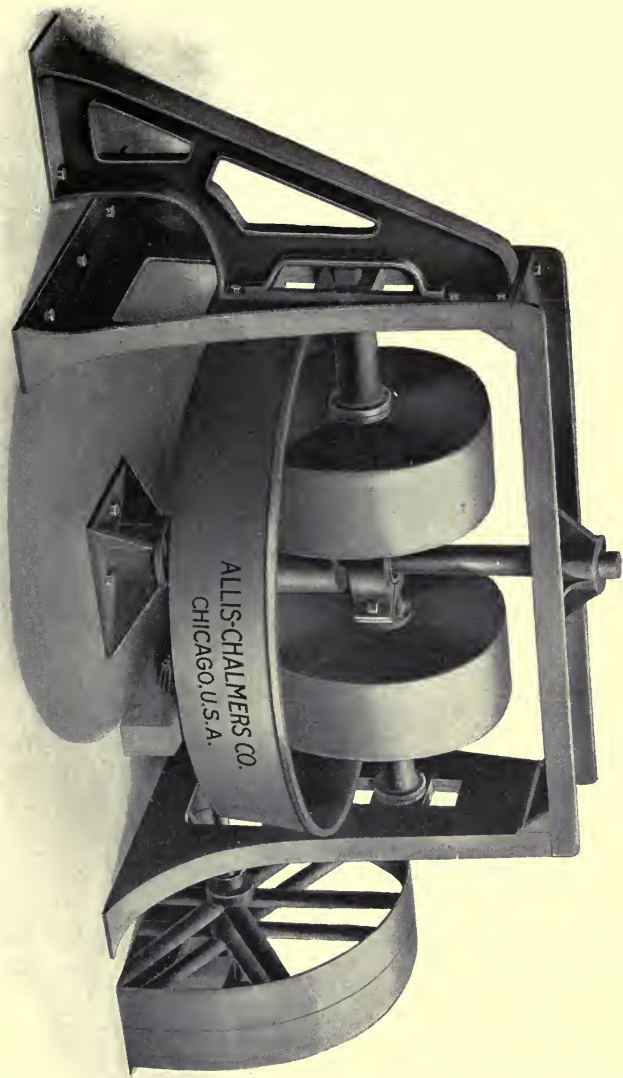

Fig. 126. CHISLEAU MILL.

anodes are quite rough, and liable, through irregularities both in form and in composition, to tend to short circuiting and to poor working in the electrolytic bath. To obtain smoother anodes a reverberatory furnace has been used. Into this reverberatory the converter copper is transferred as it is made, and every morning the accumulated copper is poled to reduce the contained copper oxide, and molded into anodes as in ordinary copper refining. While this operation is going on, of course no copper can be put in the reverberatory. Consequently it is poured into ingot molds, as in the older way of casting. When the anode casting is completed, and the furnace empty, the ingots, thus just cast, are added in the reverberatory to the next charge.

87. LOSSES IN BESSEMERIZING OR CONVERTING COPPER MATTE.

The fumes from the converter consist mainly of nitrogen, sulphurous acid and traces of volatilized metals (As, Sb, Te, Pb, Zn, also Cu and Ag). The loss of gold, as in pyritic smelting is, however, exceedingly small, while the loss of silver depends upon the amount of volatile metals present, as just given. A portion of the values in copper and silver are recovered in the flues. Thus the silver in the flue-dust was found to be as follows: At the branch from the converter hood, 28 to 64 oz.; at the first part of flue-chambers, 22 to 65 oz.; further along the flue, 19 to 46 oz.; and near the stack, 17.5 oz. per ton. Thus the larger the chamber the better the recovery of values. The losses in treatment as the result of extended runs amount to 1 to 1.5% of the copper and 2 to 2.5% of the silver treated. In attempting to treat concentration matte coming from lead-silver blast-furnaces, and containing 40% Cu and 10.2% Pb, the silver losses were very serious, amounting to 33 to 40%, due to the volatilization loss of the lead, which would be all practically driven off, as is the case when lead is present in a copper-matting charge of a blast-furnace.

88. COST OF CONVERTING.

Hixon, in his 'Notes on Lead and Copper Smelting and Refining,' gives the following as the cost of converting matte per pound of copper:

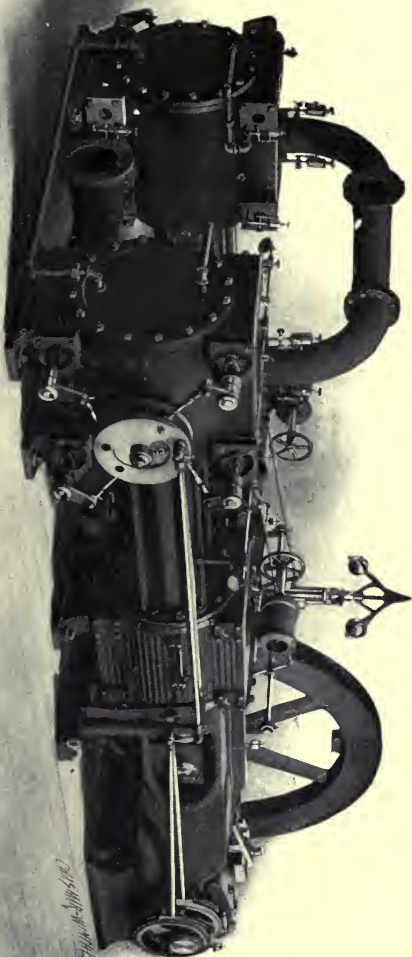

FIG. 127. HORIZONTAL BLOWING ENGINE.

Re-melting matte	0.20c
Labor and re-lining converters	0.25
Labor on converter	0.10
Re-smelting converter slag	0.05
Supplies	0.05
	0.65c

or for a plant, using direct matte, 0.45 to 0.40c.

Fig. 127 is a duplex compound blowing engine for supplying air. Such an engine would have steam cylinders 17 and 32 in. diam. respectively, and air cylinders 36 in. diam., all having a stroke of 30 in. and delivering 5,600 cu. ft. of air per minute at a pressure of 10 lb. per sq. in. and be capable of supplying the converter plant (Fig. 123).

89. A 300-TON COPPER SMELTING AND REFINING PLANT.

Fig. 123 is a sectional elevation, and Fig. 124 a plan of a plant (already referred to) where copper-bearing ore is treated in two furnaces, each 42 by 144 in. section at the tuyeres, and the matte, as fast as it accumulates, is transferred to one or other of the converters in the converter building.

Referring to Fig. 123 the ore, coming in by car on an elevated track, discharges into inclined-bottom bins. Another overhead track at the right receives the coke. These materials are drawn off, weighed and discharged to the blast-furnaces. The furnace-top has two outlets, one discharging directly to the outside above the roof, the other entering a horizontal flue 5 ft. wide by 7 ft. deep where the flue-dust, as it accumulates, may be drawn off. This flue crosses the roof, and passing under the coke-track, terminates in a high sheet-iron brick-lined stack. The settlers of the blast-furnace, 10 ft. diam. by 5 ft. high (shown also in Fig. 124) receive the flow of the blast-furnaces, the slag being then taken from the settler into a slag car, which comes by track close to the settler, while the matte is tapped from its lower part to a matte-ladle handled by the crane.



FIG. 128. HYDRAULIC ACCUMULATOR.



PART VII. LEAD

PART VII. LEAD.

90. THE ORES OF LEAD.

Lead ores are those in which lead is the principal constituent, though the term is also applied to those mineral aggregates in which there is over 10% lead. The ores of lead may be divided into two classes, sulphide ores and oxidized ores, but it must be understood as a term applied to the constituent which is in excess, since, in many lead ores, both sulphides and oxides are to be found mingled. Ores containing no lead are called dry, and those with lead, leady. This latter term is the converse of dry, so that one would never call a leady ore a 'wet' one.

Galena, when pure, contains 86.6% Pb, 13.4% S. It comes, mixed with more or less vein matter or gangue, and, in preparation for the smelter, this may be largely removed by ore-dressing methods. The table herewith gives an idea of such ores, both before and after dressing.

Galena Ores.

	Raw Ore	Concentrate	
	Pb %	Pb %	Ag Oz. per ton
Rockville, Wis.			0.3
St. Joseph, Mo.	7.0	70.0	
Kellogg, Idaho.	11.0	60.0	30.0

Kansas and Missouri galena contains but little silver, but in the Rocky Mountain region it is not only argentiferous, but contains a little gold, the precious metals determining its value as much as the lead. Metallic sulphides are often associated with

galena and, (with the gangue,) may carry precious-metal values. This may interfere with concentrating the ore, and, hence that operation may have to be omitted, but an ore of 35 to 40% Pb is a very acceptable one at the smelter. If of this tenor in lead, and with no associated sulphides, it would contain no more than 5% sulphur, so little, in fact, as to warrant its direct treatment in the blast-furnace without preliminary roasting.

Oxidized, also called carbonate ores. They include anglesite $PbSO_4$, containing, when pure, 73.6% Pb, and cerussite, $PbCO_3$, containing also, when pure, 83.5% Pb. When in sandy or earthy form, these are called sand or soft lead carbonates, but when in hard lumps or in stony form, they are known as hard lead carbonates. Lumps of ore, originally galena, may be found more or less profoundly altered into anglesite or cerussite. The following table gives the constitution of various carbonates. Silver occurs in oxidized ores in the form of chloride, the gold probably in the native state. There are various other lead minerals, but so small in quantity as not to constitute ores.

Carbonate Ores.

	Pb %	SiO ₂ %	Fe %	CaO %	S %	Ag Oz. per ton
Southwest Missouri	72.0					
Leadville, Colo.	38.0					25.0
Leadville, Colo.	21.0					65.0
Red Mountain, Colo.	17.0					128.0
Eureka, Nev.	33.2	3.0	24.1	1.1		128.0

91. BEDDING ORES.

In a custom-works ores of many kinds are received, often in small lots. Such ores are 'bedded' in large bins, holding several hundred tons each, and when so bedded are treated as one ore. Each kind of ore is unloaded into the bin and is then spread out in an even layer upon its predecessor, which has been treated in

the same manner. The ore, when used, is shoveled up from the floor, the upper portion falling down and mixing with the lower layers. Thus a uniform mixture of all the ore of the bed is obtained for use at the furnace. The advantages are that a charge can be calculated and adjusted, after which it remains the same, often for several days, and again, the values are as one ore upon the books of the company.

In the laboratory the aggregate analysis is made as follows: A list of ores and of their dry weights is prepared. The chemist weighs out on his balance from the reserved samples of each of the ores an amount proportionate to the quantity of that ore in the bin. The total, amounting to one or two ounces, is thoroughly mixed, and from it the portions are taken for the determination of SiO_2 , Fe, CaO and S.

It may also be determined for Ag, Au or Pb, though these quantities are more often estimated from the assay of the individual ores. The determinations thus made are used in calculating the charge. Besides ores bedded in this way, lots which would fill a large bin remain unmixed and are treated as a separate item of the charge. The same is true of smaller lots of which a moderate amount is taken for each charge, and these are called 'side ores.' Roasting ores are also preferably bedded because, when uniform, they are better known and handled in the roaster, and are more accurately smelted. Such beds may be prepared to contain the proper amounts of pyrite, silica and lead which work best when roasted.

Crushing and bedding of lead-bearing ores for roasting.— This is often performed in two stages. The coarse crushing of lumpy ore is best done through ore-breakers, either of the jaw or gyratory type, the ore being reduced to 0.75 in. It is then passed through rolls 36 in. diam. by 14 in. face, where it is crushed to pass a No. 3 to a No. 10 mesh screen, according to its nature. A pyritiferous ore need be crushed no finer than No. 3 mesh, many ores and matte to No. 5, while galenas and zinciferous ores need finer crushing to No. 10 mesh.

Ores are not to be roasted indiscriminately, but are preferably bedded or placed in a large bin in layers so that the roasting may be the same for a considerable time, in order that the men may

know how to roast it to the best advantage. Also, by so doing, ores of different constitutions may be combined. For instance, a leady ore is better roasted mixed with a silicious sulphide, pyrite assists a leady or zinky ore, zinc makes the mixture more infusible, so that it will not so soon soften at the finish of the roast. A bed formed to contain 10 to 15% SiO_2 , 20 to 28% Fe and 20 to 28% Pb works quite well. Mixtures, containing less lead than this, roast more readily, but are quite pulverulent when roasted, and make much flue-dust, while with the above specified proportion of lead, they sinter together somewhat and thus give a better product for the blast-furnace.

92. REVERBERATORY LEAD SMELTING.

The treatment of lead ores in the reverberatory furnace has not made headway in the United States for two reasons. In the silver-lead districts the ores have not been sufficiently high grade

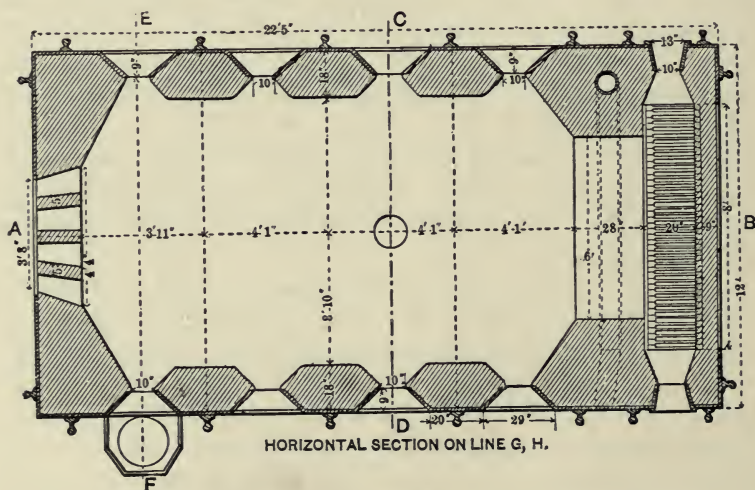

FIG. 129. LEAD-SMELTING REVERBERATORY FURNACE (PLAN).

in lead to warrant such treatment, and lead ore has been much in demand as a collector to mix with other ores. Second, in the Mississippi valley, where silver-free high-grade ores occur, the

question of skilled labor has had some influence, perhaps unjustly so.

The roast reaction method.—High-grade, pure, non-silicious ores are best treated by this method. Fig. 129 and 130 represent one of the larger and more recent of these furnaces, 16 by 9 ft. hearth dimension and having a fire-box 8 ft. by 1 ft. 8 in., or of

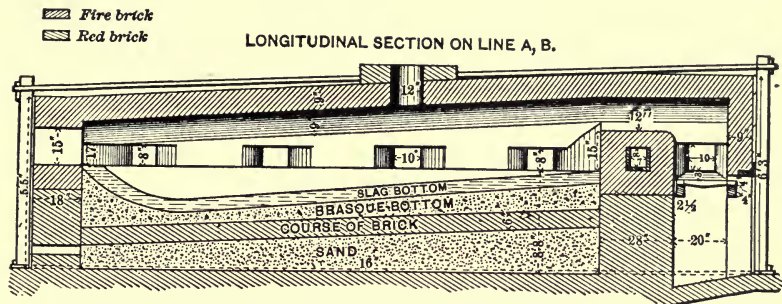
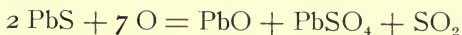

FIG. 130. LEAD-SMELTING REVERBERATORY FURNACE (ELEVATION).

14 sq. ft. area. The bottom of the hearth has a slope from the fire-bridge to the external well or basin *F*, located at the cooler end of the furnace. The flame passes to the stack by the ports at *A*. The charge is dropped into the furnace from a hopper and through a hole at the middle of the roof. There are four working-doors on each side, where the charge can be spread out, raked and withdrawn. The lead from it drains to the basin, *F*, from which it is dipped out from time to time as it accumulates, and is molded into ingots or bars.

Operation.—The working of the furnace may be divided into two stages, namely, oxidation and reduction.

Oxidation.—Four tons of ore, crushed to 5-mesh, are spread out in a layer 3 in. thick upon the hearth, and heated gradually to just-visible red (500 to 600° C). The roasting which takes three to four hours is carried on until partly completed, according to the reaction



The temperature is kept low, and the charge is frequently raked to expose new surfaces to the action of the air and to prevent agglomeration.

Reduction.—The grate is filled with coal to give a neutral flame, and the temperature is raised to 700° C so that the oxygen compounds may react on the unchanged galena thus:

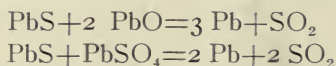

The charge gradually softens, but not to melting, white fumes are given off and the lead begins to flow. To stiffen the charge, making it less fusible and more spongy, slacked lime is added and stirred in. Rabbling the charge is also performed at intervals to promote the reaction. By this time the flow of lead ceases, but the pastry residue still contains about half of the original lead.

To extract more lead a second roasting takes place, followed by a second re-acting. It takes several repetitions of the process to extract the bulk of the lead. Toward the end there will be no sulphide left to re-act on the oxides and sulphates. To reduce these, coal or charcoal is mixed in, and a further portion of lead obtained. Each successive operation will be shorter than the last, and the temperature will be carried a little higher. The lead, as it flows away from the charge, is received into the outer basin *F*, and, after skimming, is molded into bars or ingots. The residue, after the extraction of all the lead possible, is a gray slag, still containing 12 to 30% Pb, and amounting to 25% of the charge. It is generally sent to a blast-furnace where the lead can be thoroughly removed.

It takes upward of 12 hours to work through a charge with a consumption of 45% of its weight of coal.

The process is only suited to concentrate and to ores rich in lead, not containing over 4 or 5% SiO_2 , which ingredient forms a silicate with the lead oxides. Small amounts of the metallic sulphides are not harmful; indeed pyrite is beneficial at the first stage, while limestone, dolomite, blende and ferric iron rather stiffen the charge, thus preventing premature melting.

93. THE ORE HEARTH.

The ore hearth cannot, as regards capacity or cost, compete with the reverberatory, nor is it used in silver-lead smelting.

As compared with the reverberatory it can be quickly started or stopped with but little consumption of fuel, so that it serves well the purpose of extracting the lead from time to time from small amounts of non-argentiferous ore by the men who have mined it themselves.

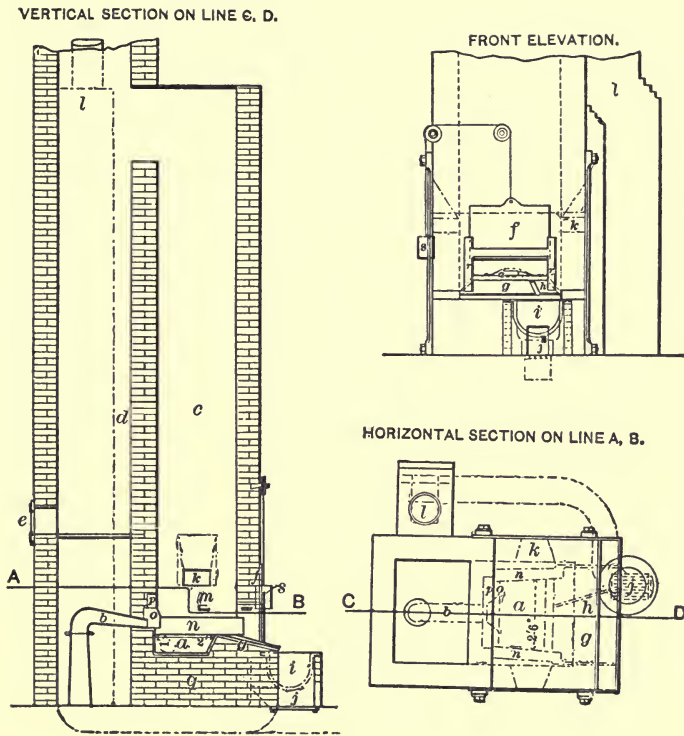

FIG. 131. AMERICAN ORE-HEARTH.

Fig. 131 represents a sectional elevation of an American water-back ore-hearth. It consists of a crucible *e*, to contain the lead, built into brickwork *n*. The three sides of the hearth above the crucible are formed by a cast-iron water-cooled jacket. The blast enters at *a*, and then, through nozzles *d*, to the hearth; *g* is the work-stone and *h* a kettle or pot, placed to receive the lead, and

kept hot by a wood fire. The structure is surmounted by a sheet iron hood or stack to remove the fumes.

Method of working the hearth.—With the aid of the blast a glowing coal fire is made, filling the hearth. Some residue from the previous run, together with 15 to 20 lb. of high-grade galena, not less than pea-size, is spread over the fire. This soon becomes red hot, collecting at the bottom of the crucible. More ore is added. Then the materials of the hearth are gently pried up with a bar to keep the mass open and hot throughout. Lumps form which are drawn out on the work-stone, the gray slag being separated, and the rich residue returned to the hearth. Ore and fuel are again added, and these operations continue until the lead fills the hearth, while on top of it floats the fuel and unreduced ore. Ore and fuel are added, the former 20 to 30 lb. at a time, sprinkled over the charge. One man at intervals with a bar loosens and stirs the charge, raising it slowly, while another withdraws upon the work-stone the semi-fused mass floating next to the lead. Here he separates the gray slag, rejecting it, and returns the broken-up rich residue to the surface of the charge. A fresh charge is then added, and so the work progresses. The lead as it accumulates in the crucible overflows, running down a groove made in the work-stone or plate to the kettle, whence it is drawn off by a spout into molds.

Lead is obtained, as in the reverberatory, by roasting and reaction; and PbO , when formed, is reduced at once to lead by the fuel.

The ore-hearth needs power and a blower, and much lead is volatilized, so that it is not suited to argentiferous ores. The gray slag which is obtained still contains 35 to 40% Pb, which is sold to the blast-furnace smelting works. The direct recovery of lead is no more than 75%.

94. SILVER-LEAD SMELTING.

This is a blast-furnace method of treatment, applicable to the greatest variety of ores containing lead, gold, silver and even copper. By this method, ores containing the precious metals, but no lead, are treated with lead-bearing ores, thus using lead as the

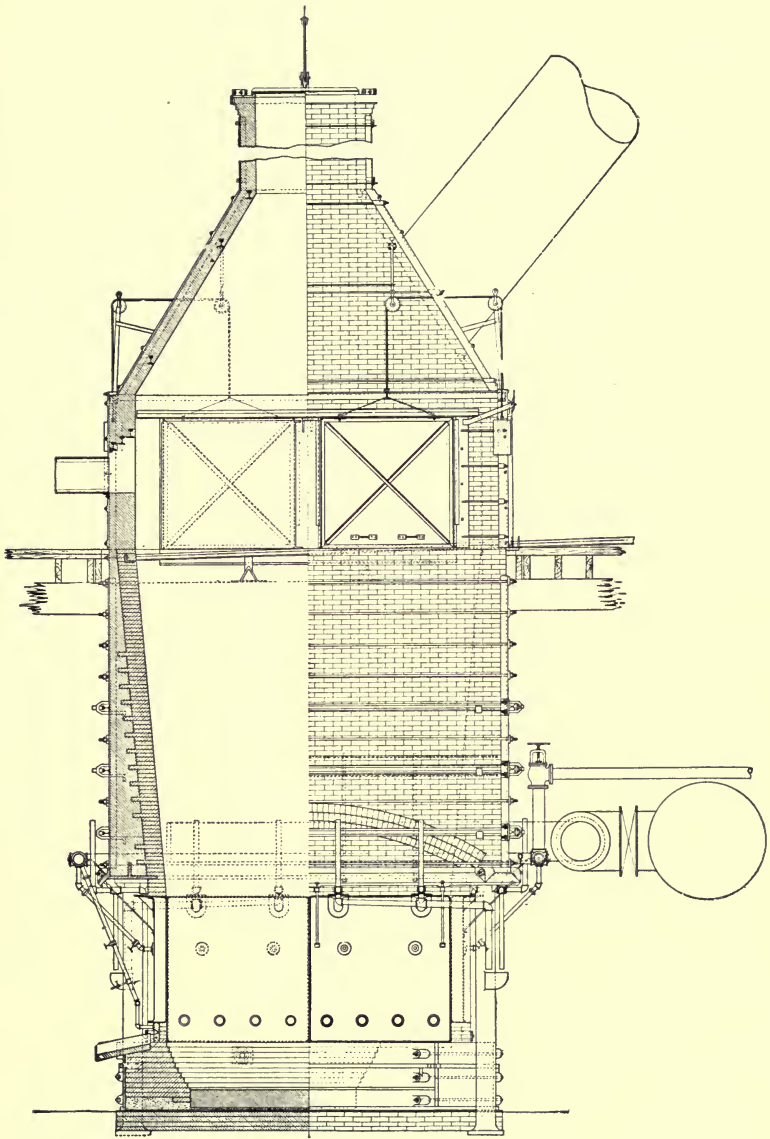

FIG. 132. SILVER-LEAD BLAST-FURNACE (LONGITUDINAL ELEVATION).

collector of the values. It is the most effective method known for recovering these values, they being extracted from the ore by a reduction blast-furnace treatment with carbonaceous fuel and fluxes. Oxidized ores (oxides and carbonates) are treated directly in the blast-furnace, but sulphides are first roasted, as is more fully described in the chapter on roasting. This has become an important preliminary operation in smelting.

The ores, which are to be treated, are put into the furnace together with a predetermined quantity of fluxes, taking the precaution of using enough lead-bearing ore so that the lead shall constitute upward of 10% of the charge. It has been found that if much less than this proportion is used, the precious-metal contents of the ores are not well collected into the base-bullion or work-lead, which is the result of the smelting. To the charge thus constituted is added upward of 15% of coke, which not only does the melting, but also reduces the lead to the metallic form and the iron oxides to a lower state of oxidation.

95. THE SILVER-LEAD BLAST-FURNACE.

Fig. 132 represents, half in section, half in side elevation, a view of a water-jacketed lead blast-furnace, rectangular in plan and in size 144 by 44 in. at the tuyeres. Fig. 133 is a half section and half end elevation of the same furnace. It consists of three parts, the first being the shaft, extending from the feed-floor to the second part or crucible, and surmounted by the third part, a stack or closed top. Fig. 134 is a perspective view of such a furnace.

Beginning with the foundation, we find it made of rubble-masonry or of concrete, extending from the solid ground to the slag-floor level as a single mass, large enough to sustain the corner posts also. Where there is another furnace close by, the slag produced in this may with little expense be employed for making the foundation of this furnace.

Upon it rests the crucible shown in section in Fig. 132 and 133, and in perspective in Fig. 134. In Fig. 134 the crucible is bound by steel plate. The bottom of the crucible consists of a pan extending over the whole area and including the exterior binding

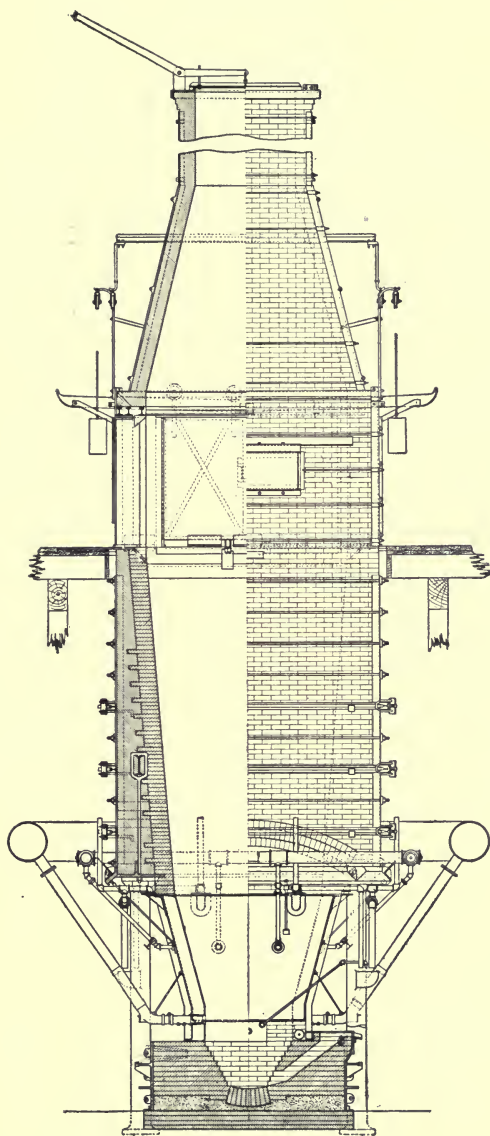

FIG. 133. SILVER-LEAD BLAST-FURNACE (TRANSVERSE ELEVATION).

crucible-plates. The crucible, 144 by 44 in. in size at the top, has heavy walls and a bottom of fire-brick, and at one side a channel or lead-well is built, as may be seen in Fig. 133. In operation, the crucible and lead-well are full of lead, and as fast as more is made, the excess is removed at the lead-well, whose opening will be noticed in Fig. 134. The jackets form the lower part or bosh of the shaft and may be made of cast iron or of steel, as in Fig. 132, 133 and 134. The side jackets have openings for the tuyeres. It will be noticed that the bosh begins above the tuyeres, making a bend or knee in the jacket, as shown in the cut of the steel side-jacket, Fig. 135, as well as in Fig. 133. At the top of the jacket will be seen a spout where the water enters, and, at the front of the spout, the hole for the exit water-pipe. Fig. 136 is a steel end-jacket which is made shorter than the side-jackets so as to leave an opening below for the breast.

Jackets are also made of cast iron, but narrower than when of steel; a side-jacket, for example, taking in but a single tuyere and being, therefore, but 18 to 20 in. wide. Each jacket has its own spout for the inlet and outlet of water. Hand-holes near the bottom are put in so that accumulated scale may be removed. Fig. 138 is a left-hand end-jacket. In Fig. 132 it will be seen that there is no bosh in the end-jackets, but often, as in Fig. 134, such a bosh is provided. Fig. 138 shows such a bosh, and indicates the method by which it is connected to the side-bosh, by a rounded corner.

Air is supplied to the tuyeres from the bustle-pipe, shown in Fig. 133 and 134, and in the latter figure are shown the canvas sleeves by which the connection is made. This makes a flexible connection so that tuyeres may be readily removed, as when the furnace has to be stopped for a short time. A system of water-pipes supplies the jackets.

The main shaft of the furnace, extending from the top of the jackets to the feed-door, is of brick lined with fire-brick, the whole being firmly tied with rods and angle-irons at the corners. This brick structure is supported by a deck-plate resting upon the cast-iron corner-posts or columns of the furnace.

Above the feed-floor is the stack or closed top, which collects the smoke and gases arising from the charge and delivers them

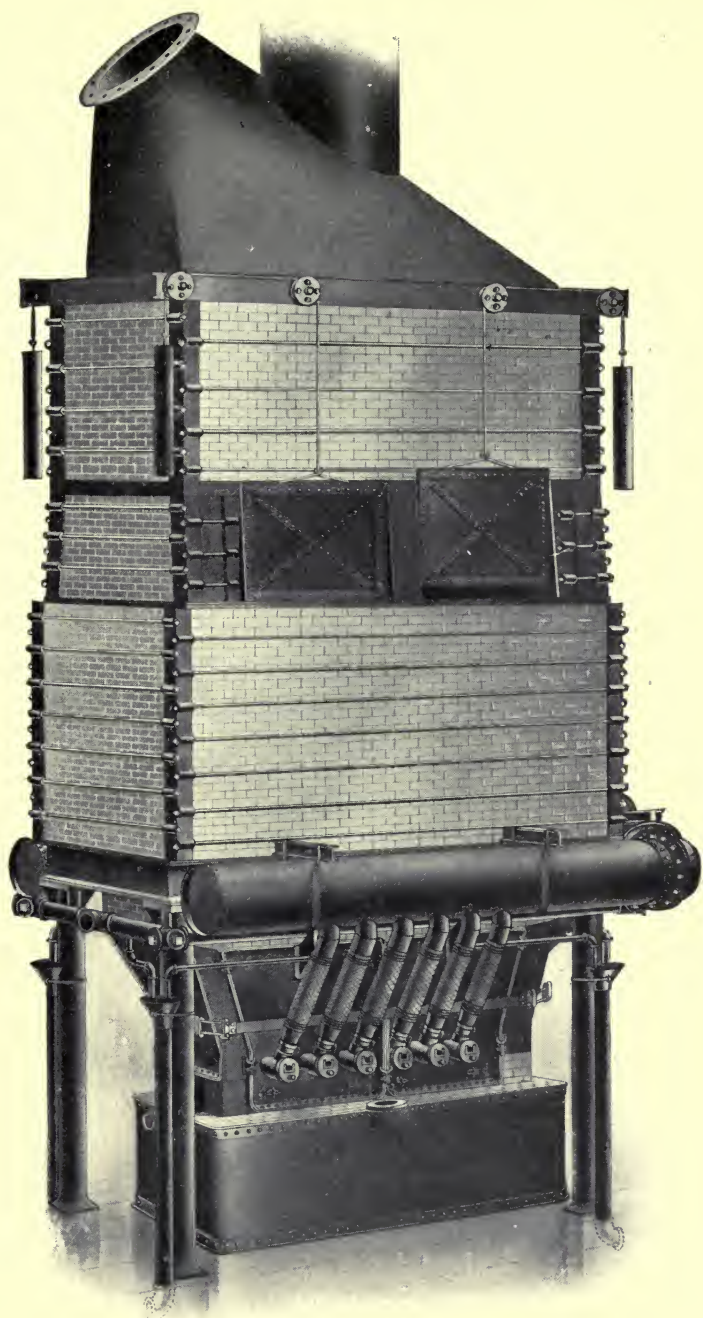

FIG. 134. PERSPECTIVE VIEW OF SILVER-LEAD BLAST-FURNACE.

to the down-take, a circular pipe of 5 ft. diam. This pipe rises at an angle of 45° , then returns at the same angle to the flue-



FIG. 135. SIDE-JACKET WITH KNEE-BOSH.



FIG. 136. STRAIGHT END-JACKET.

chamber. The stack is carried up in brick and is closed with a damper, which in ordinary operation is closed, but which is opened when running down or emptying the furnace.

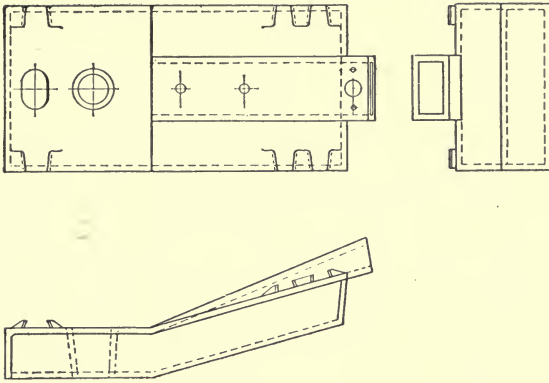

FIG. 137. CAST-IRON SIDE-JACKET.

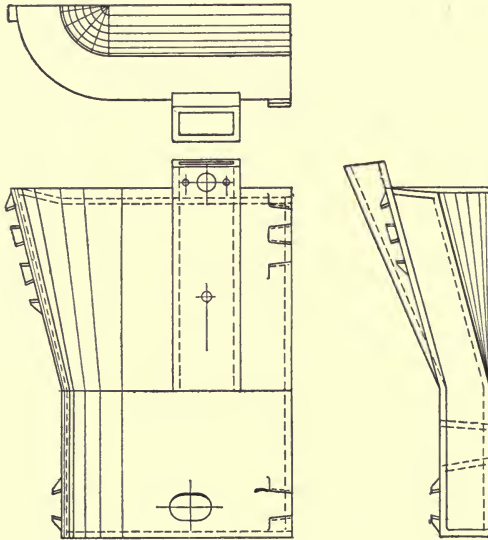

FIG. 138. CAST-IRON END-JACKET.

96. BLOWING-IN THE SILVER-LEAD BLAST-FURNACE.

This may be divided into four operations, namely: warming the crucible, melting in the lead, filling the furnace, and starting the smelting.

Warming the crucible.—This is done gradually. A small wood fire with lighter wood is started so as to drive off the moisture. This may take 24 hours. The fire should be regular, the wood being placed at the walls, leaving the middle of the crucible clear. When the fire has been kept up some hours the charcoal and ash, both non-conductors of heat, seem to accumulate. Remove these and the glowing coals with a long iron-handled shovel, and then put in a new fire. When the brick-work seems dry, increase the firing to warm it up. To do this tie up all the tuyere sacks and attach to the last tuyere connection of the bustle-pipe a length of tuyere sacking long enough to supply air to a 6 ft. piece of $2\frac{1}{2}$ in. pipe. The blower being slowly rotated, the end of the pipe, placed well down in the crucible, supplies air to vigorously consume the wood. The lead-well, having a down-draft toward the crucible, is warmed at the same time with wood and charcoal. Particular attention should be given to heating this part of the crucible, and the heating is kept up until the outer brick-work of the crucible is hot to the hand.

Melting in the lead.—The crucible is cleaned out and some fresh sticks put in, which soon take fire. Upon the wood is charged in with a paddle a dozen bars of lead which are melted down speedily with the blast pipe. More wood is added, and other bars, and thus progressively the wood is burned and the lead melted. When the crucible is half full, the fuel, charcoal and ashes are best removed, fresh fire put in, and the melting concluded. It takes upward of 30,000 lb. of lead to fill the crucible of a 42 by 120 in. furnace. The melting begun in the evening should be completed and the lead skimmed clean by 6 A. M., when the day shift comes on.

Filling the furnace.—Dry wood, preferably in long sticks about 4 in. through, are put upon the lead, as much as can be put in at the breast. The tap-jacket is set in and the breast bricked up, while at the same time more wood is dropped from the charge

door to fill the jacket space to just above the tuyeres. Sound lump-charcoal is then put in up to one-half the height of the jackets, followed by coke to the depth of 12 to 18 in. The first charges of an easy-melting slag follow, with fuel and flux enough to take care of the excess silica of the slag. Ore charge gradually replaces the slag charge, and the high percentage of fuel is gradually cut until the normal charge is reached. Care must be taken that the furnace is evenly and quickly filled, extra labor being used to assist in so doing.

Starting the smelting.—The furnace being half full, including some ore charges, fire is started at several of the tuyeres on either side by putting in a little greasy waste at each and lighting it. The tuyeres are at once put in place and the blower started with a light blast of 1 or 2 oz. pressure. The wood soon takes fire and the smoke rises through the charge. The blast is gradually increased during one or two hours, and the furnace as gradually gets into operation. As the slag accumulates, it is tapped off, while the lead, accumulating in the crucible and lead-well, is either removed by ladles or tapped off by the lead tap situated near the top of the lead-well. The amount of lead removed at a time should be limited to from 1,000 to 1,500 lb., and the lead-well should be kept full. The operation of filling and starting takes about 7 hours.

Regular work on the charge-floor.—This consists in bringing ore, flux and fuel from the bins to the charge scales, weighing out the required amounts, dumping and feeding them into the furnace. Everything, except the foul slag, should be weighed at the furnace, even putting in the latter in regular quantity. The materials of the charge weighed in a charge-car or buggy, are dumped on the charge plate at one side of the furnace, the coke for it being dumped on the other side. The coke is fed in an even layer, and the plate, thus cleared, receives an ore charge. The ore charge on the other side is then shoveled in, taking care that the larger ore goes to the middle portion of the furnace, the finer to the walls and corners. The blast tends to creep up the walls, more than at the middle, but by this arrangement is compelled to come up evenly both at the centre and at the sides. The plate

just cleared of the ore charge now receives coke, which is the next to go in. The furnace is maintained at the level of the charge-floor, the charges being put in as the surface sinks.

Regular work on the furnace floor.—This consists in regulating the water supply to the jackets, seeing that the tuyeres are clean and open, tapping the slag, and when slag and matte are caught in a forehearth, tapping off the matte, placing the slag pots and removing them to the dump; also tapping or ladling the lead (base bullion) into molds and removing and piling the bars or ingots to be sampled. The matte is removed in pots or molds, and when solidified is broken up and sent to be crushed for roasting. The slag, as in copper practice, may be granulated and swept away in a launder by means of a stream of water. There is an objection to this, however, that by reason of irregular working losses of values may occur which are never recovered when once the slag is granulated; hence removal by slag-carts or pots is preferred.

When a slag-pot has stood for a few minutes at the edge of the dump, its contents are carefully poured out. There is left behind a shell of solidified slag of half an inch or more in thickness. This shell is returned to the furnace for re-smelting. It will be found to have within it drops of matte which have settled out of the molten slag. Slag is also conveniently removed in large slag-pots, mounted on trucks, which are handled by a horse or by an industrial locomotive. At some large silver-lead smelting works, the slag and matte together are taken to a reverberatory separating furnace where the matte becomes thoroughly settled from the slag and is tapped off at the bottom level of the furnace-hearths. The slag is kept to the depth of 18 to 24 in. in this furnace, and is tapped off near the surface, when full, and is delivered to a string of slag-cars handled by a locomotive. A fire, with a smoky reducing flame, is maintained in this settler. It gives excellent results but needs the output of several furnaces to keep it hot and in good working condition.

97. REACTIONS OF THE BLAST-FURNACE.

The surface of the charge in a lead furnace should look dead, not showing any overfire. In fact, with much

overfire, there is loss due to the volatilizing of the lead. The moisture in the charge is soon dried out by the heated currents of rising gases. The heat thus used is but small, amounting to about one-thirtieth of the total fuel, with 5% moisture in the charge. As the charge descends, CO_2 begins to come off from the limestone, and iron is reduced from the ferric to the ferrous form. The lead, in the oxidized portion of the ore, is reduced by the CO of the gases and especially by the red-hot coke. It falls down in drops through the charge, and comes in contact with the ore and molten slag, taking up the gold and silver values of the ores. The sulphur in the charge takes up copper, iron, and even 10 to 20% of lead, forming matte. The iron left after the matte is satisfied goes to the slag as FeO and, together with the CaO , forms a fusible silicate. The molten products separate at the hearth according to their specific gravity, that of lead being 11.5, that of matte averaging 5.2, and that of slag 3.6. The lead collects in the crucible and is withdrawn at the lead-well. The other products, matte and slag, are drawn off at the slag-tap, situated just above the level of the lead. The separation of the matte from the slag is generally effected in a forehearth outside the furnace.

98. LEAD SLAGS.

The object of silver-lead smelting is to separate the contained lead from the ore; the sulphur present forming, with copper and iron, some matte; while the remaining available bases, united to the silica, form a slag. If there are not bases enough to form a suitable slag, they must be added in the form of fluxes to the charge.

Various authors, in describing the composition of slags, have divided them, according to the chemical composition, into:

Singulo-silicates ($2 \text{RO} + \text{SiO}_2$), in which the ratio of oxygen in the bases to oxygen in the silica is as 1 to 1;

Sesqui-silicates ($4 \text{RO} + 3 \text{SiO}_2$), with an oxygen ratio of 2 to 3;

Bi-silicates ($\text{RO} + \text{SiO}_2$), having an oxygen ratio of 1 to 2.

Let us make the RO bases to be in the proportion of their equivalents, namely: 72 parts $\text{Fe}(\text{Mn})\text{O}$ to 56 parts $\text{Ca}(\text{Mg},\text{Ba})$

O, then, with the total of three elements forming 90% of the slag (the other bases are assumed to be 10%) we have:

Singulo-silicates 28.7% SiO_2 , 34.5% $\text{Fe}(\text{Mn})\text{O}$, and 26.8% $\text{Ca}(\text{Mg}, \text{Ba})\text{O}=90\%$.

Sesqui-silicates, 37.2% SiO_2 , 29.8% $\text{Fe}(\text{Mn})\text{O}$, and 23.0% $\text{Ca}(\text{Mg}, \text{Ba})\text{O}=90\%$;

Bi-silicates, 43.6% SiO_2 , 26.1% $\text{Fe}(\text{Mn})\text{O}$, and 20.3% $\text{Ca}(\text{Mg}, \text{Ba})\text{O}=90\%$.

However, in practice, this way of looking at the constitution of slags is seldom followed since slags are silicates of considerable complexity, but the percentages of them are what is generally given.

Typical slags, as those which have proportions of SiO_2 , $\text{Fe}(\text{Mn})\text{O}$ and $\text{Ca}(\text{Ba}, \text{Mg})\text{O}$, such as are suited for successful use in the blast-furnace. To fulfill the requirements of a good slag, they should, in the normal operation of the furnace, con-

Table of Typical Slags.

Type		SiO_2 %	$\text{Fe}(\text{Mn})\text{O}$ %	$\text{Ca}(\text{Ba}, \text{Mg})\text{O}$ %
Quarter-slag	C	28	50	12
Silicious quarter-slag	H	32	47	11
Half-slag	E	30	40	20
Half-slag	J	31	38	21
Silicious half-slag	I	35	38	17
Three-quarter-slag	F	33	33	23
Silicious three-quarter-slag	M	36	31	23
Whole, or 1 to 1 slag	G	35	27	28

tain not more than 0.7% Pb, nor should the Ag be more than 0.5 oz. when the charge is producing base bullion not higher than 300 oz. per ton; neither should they have a density greater than 3.6, nor permit accretions at the hearth or the creeping up of overfire.

According to the ratio of FeO to CaO, so slags are called a quarter, a half, a one to one, etc., slag. Thus slag *E* of the sub-joined table is called a half-slag, the CaO being but one-half the percentage of the FeO. Slag *C* is a quarter slag, the CaO being approximately one-fourth of the FeO. In this table of typical well-tested slags the three elements are reckoned at 90%. If the sum should vary from this, the ratio may be still preserved.

Action of elements of the slag.

Iron.—Iron ore is soon reduced to the ferrous form under the action of carbon, thus, $\text{Fe}_2\text{O}_3 + \text{C} = 2 \text{FeO} + \text{CO}$, when, being the stronger base, it replaces lead oxide in silicious combination, the lead oxide then being reduced to metallic form, and finding its way as base bullion or work-lead to the crucible, while the iron serves as a base for the silica, thus:

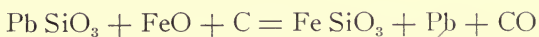

Galena is also reduced to metallic lead in presence of ferrous iron and carbon as follows:

$\text{PbS} + \text{FeO} + \text{C} = \text{FeS} + \text{Pb} + \text{CO}$. This reduction is by no means perfect. A little PbS with whatever copper may be in the charge, and the needed iron and sulphur, forms that complex copper-lead-iron sulphide called 'matte.'

Manganese. The equivalent for manganese is 55, that of iron 56, so that we may reckon them as having equal values for fluxing.

Lime, magnesia and baryta. These alkaline earths act in inverse ratio of their atomic weights in fluxing silica. Hence, to obtain the equivalent lime, their percentages are multiplied by 1.4 for magnesia and by 0.4 for baryta. Lime, replacing FeO, tends to make a slag of less specific gravity, this property causing a better separation of slag from matte. Being a stronger base than iron, and generally a cheaper flux, the tendency is to substitute it for iron. It will be noticed that the higher the slags of the table are in silica, the higher they are in lime, or that a high silica needs a high lime. Accordingly, where the making of silicious slags is the most profitable, there will the slags be limy. Dolomite is avoided for use in silver-lead smelting, since it makes the slag pasty and streaky, and its unfavorable effect is shown, especially

in presence of zinc. The analyses of limestone and of dolomite, given below, show the composition of those fluxes in actual practice.

Canyon City, Colo., Limestone.—49.8% CaO, 3% MgO, 3.1% SiO₂, 0.8 % Fe.

Iron County, Mo., Dolomite.—26.6% CaO, 17.6% MgO, 5.1% SiO₂, 3.3% Fe.

Fluorspar has no unfavorable effect on the slag; still, when present, the fluorine uses up CaO, and hence the slag must have more CaO than the type-slag calls for.

Alumina. It is a question whether alumina acts as an acid or as a base. It will be sufficient for the purposes of silver-lead smelting to regard it as a constituent, dissolving in the slag, and acting in neither way.

Copper. Where copper exists in the ores, it enters the matte and generally such matte is to be provided for it to enter. However, in smelting carbonate or oxidized ores without the formation of matte, the copper becomes reduced, and enters the base bullion giving a drossy lead, sometimes so much so that it tends to clog and stop up the lead-well and to accumulate and solidify in the crucible. The remedy is to add sulphides in quantity sufficient to form some matte.

Zinc. Blende and zinc oxide cause difficulties in the blast-furnace. Blende is in part decomposed into zinc oxide, but in either form stiffens the slag and tends to make it infusible. It may be regarded as being, like alumina, dissolved in the slag. It goes both into the slag and into the matte, thus lessening their difference in specific gravity and causing a less perfect separation of the two. Where there is much zinc in the charge, it has been customary to modify the type-slag by figuring one-half of the zinc as replacing lime. Thus, in the half slag *J* of the table, and where there is 8% zinc oxide, we should have for a correct slag 31% SiO₂, 38% FeO, 17% CaO, and 8% ZnO, making in all 94%. Reducing these percentages proportionately to a total of 90%, we have approximately 29.5% SiO₂, 36.0% FeO, 16.0% CaO and 7.5% ZnO.

Antimony. As a sulphide, this is reduced like lead, going into the base bullion and making it hard. It has to be removed later in refining.

Arsenic occurs frequently in silver-lead smelting. It takes up iron and flows from the furnace as a 'speiss.' Where present, iron must be calculated for it. In the fire assay of lead ores for lead it will be found attached to the lead button. If, from the data thus obtained, we know the weight of speiss, we may figure that 70% of it is iron. When a direct determination of the arsenic is made, its weight, multiplied by 2.3, will express the quantity of Fe which must be provided for in the charge calculation.

Fuels used in the blast-furnace. The fuels used in silver-lead smelting are coke, charcoal, or a mixture of the two.

Coke. Coke of all kinds is used, the ash varying from 10 up to 22%, and the fixed carbon from 89 to 77%. In the high-ash coke not only is more waste material to be smelted, but the carbon is lower, so that such cokes are less efficient. Perhaps, however, the greatest trouble with these high-ash cokes is that they are often friable, making fines and dust, and obstructing the passage of the blast.

Analyses of two such cokes give:

Connellsville coke, 87.5% fixed carbon, 11.3% ash, 0.7% S.

El Moro coke, 77.0% fixed carbon, 22.0% ash, 0.9% S, when made from unwashed coal.

In computing a charge the coke-ash is taken into account, analyses being as follows:

Ash of Connellsville coke, 44.6% SiO_2 , 15.9% Fe, 7.0% CaO, 1.9% MgO.

Ash of El Moro coke, 84.5% SiO_2 , 5.0% Fe.

Charcoal. This fuel is used where the cost of coke would be too high. It is a good fuel for oxidized ores, but is friable, making undesirable fines. It makes a more open charge than coke, and contains but little ash—less than 2%. Coke may be taken at 40 lb. and charcoal at 13 lb. to the cu. ft.; the weight of charcoal is from 14 to 16 lb. to the bushel. Where charcoal is the cheaper fuel, it often helps the operation of the furnace to use a proportion of coke, which, fed at the walls, and burning more slowly than the charcoal, makes the zone at the tuyeres hotter, and gives better fused slags.

Quantity of coke. This varies according to the nature of the charge from 12 to 16%, or even more. Charges which make con-

siderable matte need less than oxidized ores. So much must be used as will give good reduction and a hot slag, and the metallurgist is guided by these factors in adding coke.

99. CALCULATION OF A SILVER-LEAD BLAST-FURNACE CHARGE.

First example: To determine the weight of fluxes to add to the charge, it is necessary to have the analyses of the ores, fluxes and fuel to be used, and to specify the composition of the desired slag and matte. Below is given an example of a charge-sheet for a charge, containing no roasted ore, and to weigh approximately 1,000 lb. Lead ore must be added in quantity sufficient to make the lead equal to 10% of the charge or 100 lb. To this may be added silicious ore, smelted to obtain its contained gold and silver. The quantities of the fluxes, as experience suggests, is now written in. Let us estimate, that of the sulphur, 20% is volatilized, 80% goes into the matte and some enters the slag to the extent of 1% of its weight. The weight of slag will be $203 \div 0.30$ or 677 lb. Neglecting fractions, we have sulphur entering the slag 7 lb., sulphur volatilized (20% of 23 lb.) 5 lb., or a total of 12 lb., leaving 11 lb. to enter the matte. Multiplying this quantity by 2.75, gives us 30 lb. of Fe needed for the matte. This leaves $201 - 30 = 171$ lb. to enter the slag. Multiplying the SiO_2 203 lb. by 1.04 gives 211 lb. of Fe needed. We have, however, only 171 lb. and the difference must be made up by increasing the Fe by 40 lb. or the iron ore by 80 lb. since the iron in the iron ore is approximately one-half the ore. Multiplying the silica, 203 lb., by 0.67 gives us 131 lb. of CaO needed, or we have 36 lb. CaO too much. Since the limestone is approximately half CaO, this will diminish the limestone by about 70 lb. Erasing the old values and substituting the new ones we carry through all the calculations again. The results should be correct to within a few pounds, and are again corrected if needed. Fractions of pounds are to be neglected, and the weights of fluxes need not be written in nearer than the nearest 10 lb., since variations in the charge, due to variations of the ores and of the weighing, would be greater than this. It must be remembered that the slag actually produced will generally vary from the calculated

proportions. When a charge has been put on, and after several hours the slag comes down or begins to flow from the furnace, it should be quickly analyzed and the charge corrected by a suitable change in the fluxes. The total weight of the charge can be varied by varying the silicious ore while at the same time retaining the lead unchanged.

Charge Sheet.

Name of Ore	Weight		Pb		SiO ₂		Fe & Mn		CaO & MgO		S		Ag		
	H ₂ O	Wet	Dry	%	Wt.	%	Wt.	%	Wt.	%	Wt.	%	Wt.	Oz.	
Chrysolite No. 28	3.0		500	21.0	105	32.0	160	15.0	75	10.0	50	4.4	22.0	75	18.7
Ontario	5.0		50			60.0	30	2.0	1	2.0	1	0.5		75	1.9
Iron Ore	2.0		200			4.0	1	57.0	114	3.0	6				
Limestone			200			3.0	6	3.5	7	54.0	108				
Coke		150				4.0	6	2.6	4	1.5	2	0.7	1.1		
			950		105		203		201		167		23.1		20.6
									30	For Matte			12.0	For Slag and Volatilized	
									171	For Slag			11.0	For Matte	

$\frac{1}{2}$ Slag SiO₂ = 30.0 = 1.00 factor
 FeO = 40.0 = 31.1 Fe = 1.04 "
 CaO = 20.0 = 0.67 "
 90.0

Matte S = 20.0
 Fe = 55.0
 Cu = 9.0

$\frac{\text{FeO}}{\text{S}} = \frac{55}{20} = 2.75$ factor

Second example: Where sulphur-bearing oxidized and silicious ores are to be used, we have to consider not only these constituents, but also the out-products of the furnace.

Ores containing less than 10 to 12% sulphur are generally smelted without roasting. It is cheaper to do this since in roasting the sulphur would be removed only down to 3 or 4% anyway. Such unroasted ore would make 40% of its weight in matte, but that matte, on roasting, would again yield 20% of matte or 8% figured on the original ore, or equivalent to the amount which would be produced by a thoroughly roasted ore. Again, many ores below the above specified limit (pure galena has 13.4% S), are leady ores and accordingly quite difficult to roast because of their fusible nature. Ores intended for roasting may be *simple*, consisting of iron sulphide; and *complex*, as shown by the following analysis of a roasted ore: 10.0% SiO₂; 27.0% Fe and Mn;

2.0% CaO, MgO and BaO; 8.8% Zn; 0.4% Cu, 6.0% S; 35.0% Pb, and having 50 oz. Ag per ton, the various bases having been present as sulphides.

The so-called 'oxidized' ores are those consisting of oxides and carbonates of lead, with a gangue of iron oxide, limestone, dolomite and silica. The lime, magnesia and iron are useful for fluxing the silica of the charge. Such ores, though called oxidized, often carry a little sulphur, both as sulphides (galena and pyrite), and also as sulphates.

Silicious ores are added to a charge, in spite of the large excess of silica which they carry, because they have values in gold and silver which must be obtained from them. The lead of the charge will take up this contained gold and silver from such ores, while their silicious gangue, fluxed into a barren slag, is sent to waste.

Both iron ore and limestone are added to a charge for fluxing the silica with the formation of a slag of a predetermined composition or type. If these fluxes carry any silver and gold such values can be recovered, they going into the base bullion or work-lead. Otherwise, they are what is called 'barren' or 'dead' flux. Ores carrying an excess of iron or of lime over silica (called iron or lime excess) are in the same category, since that excess is useful as flux and is allowed and paid for in the purchase of the ores.

Not all the slag which issues from the furnace is quite clean. At the spout, where the matte runs over it, and in the shell forming the cavity of a forehearth, slag containing drops of lead is to be found. When a slag-pot is poured out at the edge of the dump, there remains a shell or coating of the solidified slag. This shell, half an inch thick, will be found to contain drops of matte or of lead which has not entirely settled out in the forehearth. All this value-containing slag, called 'foul' slag is an acceptable addition to the charge, because of its easy fusibility and its coarse condition permitting freer passage of the air of the blast.

Finally we have the fuel constituting say 15% of the total charge, the word 'charge' meaning the ores, fluxes and the foul slag going once more through the furnace.

In computing a charge, we use the subjoined charge sheet as follows: The size of the charge to be approximately 1,000 lb. Let

us say that we are supplied with ore in the ratio of the quantities specified in the first three items of the charge sheet: roasted ore 300 lb., lead ore 200 lb., and silicious ore 200 lb. Write in with a lead pencil the quantity of fluxes necessary, as near as may be judged by experience. First find if there is about 10% of lead on the charge, the quantity preferably used for ensuring a good collection of the values in the ore. The ores containing it must be varied to accomplish this. We here find 104 lb. lead which meets the requirements. Next write in 150 lb. coke, or 15% of the charge, estimating its percentage composition from the following data, for example, of Connellsville coke: with 11% ash containing 44.6% SiO₂, 22.7% Fe₂O₃, 7% CaO, 1.9% MgO. Estimating this for the coke, we have 4.9% SiO₂, 1.7% Fe, 1.1% CaO and MgO. Since the iron is in ferric form, we have to obtain 0.7 of the quantity given to reduce it to the equivalent iron. Since magnesia is a stronger base than lime, we multiply its quantity by 1.4 or in the ratio of MgO to CaO, adding it then to the CaO. Write in all the other percentages and carry them out

Charge Sheet.

Name of Ore	Weight		Pb.		SiO ₂		Fe & Mn		CaO & MgO		S		
	H ₂ O	Wet	Dry	%	Wt.	%	Wt.	%	Wt.	%	Wt.	%	Wt.
Roasted Ore		300	12.0	36	12.0	48	32.0	96	2.0	6	5.0	15	
Lead Ore		200	25.8	52	22.6	45	18.1	36	5.4	11	2.0	4	
Silicious Ore		200	8.0	16	63.3	127	16.0	32			3.0	6	
Iron Ore		100			5.0	10	54.0	54					
Limestone		200			3.5	3			52.0	104			
Coke		250			4.9	7	1.7	3	1.1	2	0.7	1	
		1000			104	240		221		123		26	
					Fe for Matte = 37		S volati-				lized 15.0		
					Fe for Slag = 183		S in Slag 16.0				11		
											15	For Matte	

Slag
 SiO₂ = 33%
 FeO = 33%
 CaO = 24%
 Other Bases = 10%
 100%

Fe = 25.7 = 0.77 x SiO₂
 = 0.73 x SiO₂

Matte
 S = 20%
 20% S x 2.5 = Fe = 50%
 Cu = 5%
 Pb = 15%

Slag = 730 lb.
 S in Slag = (730 x 0.8%) = 6 lb.

in pounds, footing up the columns to obtain the totals of each constituent. All fractions are to be neglected. Put down at the left side of the charge sheet a type of slag such as will be found in the list of type-slags, section 99. The type to be chosen will depend upon what ores it pays best to treat, and upon the cost of fluxes. When it pays best to treat silicious ores, one would use a silicious slag; but when there is more profit in an iron ore, then use a basic slag. For this calculation we will use a three-quarter slag of 33% SiO_2 , 33% FeO and MnO , 24% CaO and MgO , while the other bases, Al_2O_3 , ZnO , alkalis, and S will make up the remaining 10%. The FeO (33%) is calculated to Fe, making it 25.7%. Find the ratio of SiO_2 to Fe, which will give us the factor 0.77. For CaO we will in the same way get the factor 0.73. On the other side of the sheet put down the matte analysis and calculate the factor expressing the ratio of S to Fe, or 2.5.

Let us first consider the sulphur. Experience shows that 25% or one-fourth of it is volatilized, also that the slag contains 0.8% S. The slag itself is obtained by dividing the 240 lb. of SiO_2 by its percentage (33) and equals 730 lb. Hence there remains 15 lb. sulphur to enter the matte, which needs 15×2.5 or 37 lb. Fe. This, subtracted from the total Fe, will leave 183 lb. for the slag. But, by calculation, for the 240 lb. of SiO_2 we shall need (240×0.77) or 185 lb. Fe, which is near enough. Were it desirable to correct this small amount, we proceed thus. The Fe being approximately one-half of the iron ore, then for 2 lb. lacking of Fe we shall need 4 lb. iron ore and this would be the new corrected quantity. Again, calculating the lime needed (240 by 0.73) or 175 lb., we find, by comparing with the actual amount, that we are short (175—123) 52 lb., equivalent to, say, 110 lb. of limestone of about 50% CaO . Neatly amend the figure needing change in the limestone column, using the new figure of 310 lb. for that item of the charge. This will alter the footings of the columns, and the older calculations, all of which must be neatly erased and changed as required. The amended calculation will be nearly correct, but if not so, make a new correction with the older figures erased, and the new ones put in. The final sheet should be a fair copy.

In conclusion we will note that since the equivalents of Fe and Mn are so near one another, we may add their respective percentages for the equivalent Fe. For magnesia multiply by 1.4 and for baryta by 0.4 to obtain the equivalent CaO.

100. HANDLING BASE BULLION.

The practice in large works is to remelt all the work-lead or base bullion from the blast-furnace. The skimings from this operation are returned to the furnace, while the cleaned base bullion is molded into bars. While molding, samples are taken from the melting kettle, from which the assay results are obtained. The bars (400 to 500 in the carload) are stamped with the number of the lot and are carefully weighed, 20 at a time. A careful assay is made upon each lot, both by the shipper and by the refinery. In smaller works the punch sample, already described, is taken.

101. FLUE-DUST FROM THE SILVER-LEAD BLAST-FURNACE.

A standard size blast-furnace, 42 by 120 in. may take 5,000 cu. ft. of air when in full operation. This is expanded by the heat of the furnace at least twice this volume, and by taking up the fuel in gaseous form, so that, in escaping through the interstices of the charge, strong upward currents result. Thus, fine particles of ore are carried by the down-take to the flues. These flues, of large cross section, may be hundreds of feet in length for the purpose of thoroughly settling out and collecting these particles, which are subsequently made into briquettes and re-smelted. Besides this, a portion of the lead, silver, and zinc contained in the ore, may be volatilized, and this, when cooled in the flue, may deposit, at least in part. Thus, flue-dust may be considered as composed of

Dust, carried along by the draft.

Lead-fume, condensed on cooled surfaces.

All this material is not saved, but the finest part may escape together with sulphur dioxide and arsenic. The latter, however,

condenses much like the lead, and where, as in some out-lying place, the lead has a lower value, there may be a point where, in order to get rid of arsenic, it may be profitable to permit such loss. There is a great difference in the dust-loss according to the way the furnace runs. A furnace having much shaft accretions, one driven with much volume of blast, or, where the feeding is carelessly performed, all gives an increased flue-dust loss. To catch as much as possible of the dust, the method which has proved most satisfactory is to have flues of large sectional area, in which the velocity of the gases is made low. In this quiet place the dust settles to the best advantage. Flues have also been made of sheet metal, but they corrode under the influence of the sulphuric acid and sulphates formed in the furnace and condensed on the metal. Reinforced concrete has been used, but is also somewhat attacked, so that brick remains the favorite material for such construction. A flue built on the Monier system consists of a framework of arched angle-iron tied by longitudinal bars and covered by wire netting or expanded metal and the whole plastered over inside and out with a cement concrete. The bottom of brick flues is, however, frequently made of metal in hopper form. Since these surfaces are covered by the flue-dust they are protected from corrosion and last well. A cross-section of such a flue shows a hopper-bottom under which runs a track. A covered tramcar can then be set under any hopper and its contents drawn into the car through a canvas sleeve fitted upon the outlet spout, thus avoiding dusting. Other methods, such as water sprayed upon the dust-laden air, plates or wires hung in the flue (Freudenberg plates, Rösing wires) have been tried with some degree of success, but have been given up in favor of plain flues without baffle-walls or other obstructions in the flue. The two points to consider are first, a slow and gentle movement of the gases to settle out the dust, and, second, large cooling surfaces for the condensation of the lead fumes.

102. PREPARATION OF FLUE-DUST FOR RE-SMELTING.

Flue-dust can be wet down and fed back to the blast-furnace. If returned, a little at a time, it is simply blown back into the flue,

but it may be fed while wet in occasional large charges, so that most of it is smelted. The proper way, however, is to make it into briquettes, with milk-of-lime for binder. Fig. 139 represents a plant containing a White briquetting press for making such briquettes (composed of flue-dust and milk-of-lime to which is often added

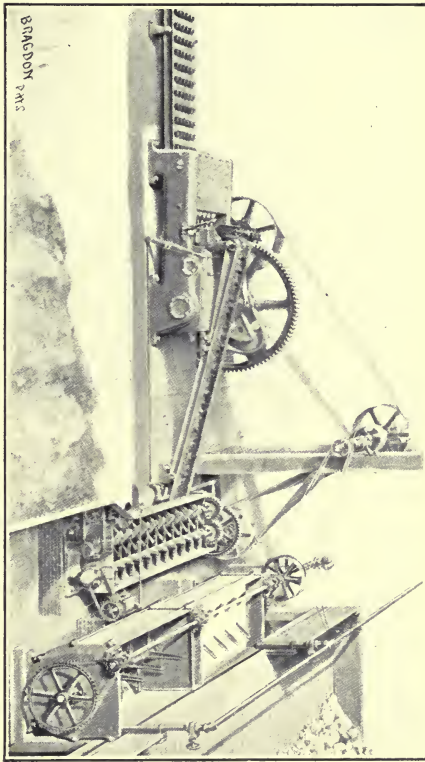

FIG. 139. WHITE BRIQUETTING PRESS.

fine roasted ore). At the right, on the higher platform, is to be seen a pile of burned lime. This is fed, together with water, into the mixer, and there slacked into a thin paste, which is allowed to constantly run into the near end of the pug-mill *O*. Flue-dust, from the pile at the front of the lower platform, is shoveled into *O*

and becomes thoroughly mixed by the revolving knives of the pug-mill which, set at an angle, screw it along to the discharge opening immediately over the troughed conveying belt. It drops into the hopper of a six-mold briquetting-press, where it is made into briquettes under strong pressure, and then comes upon the belt *i*, which delivers it into a heap. The briquettes may be used up at the blast-furnace as made, or may be allowed to dry and harden before use.

103. TREATMENT OF LEAD-COPPER MATTE

The shipping matte from the treatment of lead-silver ores runs as high as 45 to 50% in copper. This matte may be crushed to 4-mesh, and roasted in the ordinary long-bedded reverberatory furnace. It is then smelted in a blast-furnace together with some silicious and oxidized copper ore. There results a matte of 65% Cu, together with a considerable proportion of bottoms, the result of the reduction of part of the copper from the matte. These bottoms contain the gold, lead and the impurities, such as As, Bi and Sb.

The bottoms are now charged into a reverberatory furnace through the side doors. The coarsely broken matte is then put in on top, the doors are closed, and the charge is slowly roasted, as in the Welsh process of producing blister copper. The charge having been melted down, the reaction of the cuprous oxide on the cuprous sulphide sets in until the charge is reduced to copper. It is then poled, to free it from copper oxide, and is ladled into anodes.

104. LEAD ORES—COST OF TREATMENT.

To illustrate the method of calculating the actual cost of treating an ore in Western silver-lead practice, we may take a so-called neutral ore (Fe equals SiO_2) as follows: It is assumed to contain less than 5% sulphur and to carry 10% lead, and to be treated at a works having an output of 400 tons of ore daily. The cost per ton of materials and of ore are:

	Materials of charge.	Ore.
Labor	\$1.10	\$1.40
General expense, assaying and management	0.20	0.27
Fuel for power	0.07	0.10
Coke (15% of the charge)	0.97	1.36
Limestone 0.37 tons @ \$1	...	0.37
Interest, improvement fund and repairs	0.26	0.50
Iron ore 0.1 ton @ \$5	...	0.50
	<hr/>	<hr/>
Total	\$2.60	\$4.50

We thus have the cost per ton of ore \$4.50 and per ton of materials \$2.60. The above may be stated as follows:

1.4 tons materials (1 ton ore, 0.3 ton limerock, and 0.1 ton iron ore) at \$2.60 per ton for smelting	\$3.63
Cost of fluxes 0.37 ton limerock @ \$1	0.37
0.10 ton iron ore @ \$5	0.50
	<hr/>
	\$4.50

which corresponds to the first calculation. In case the ore contains sulphur in quantity to need roasting, \$2 should be added to this actual cost.

The application of this method of figuring costs may be illustrated for a silicious ore. Let us suppose by calculation we have found that for one ton of such ore there is needed 1,800 lb. iron ore and 1,450 lb. of limestone. Then we have:

5,250 lb. or 2.625 tons of materials to be smelted at \$2.60	\$6.82
1,800 " " 0.9 " of iron ore @ \$5	4.50
1,450 " " 0.725 " of limestone @ \$1	0.72
	<hr/>
	\$12.04

This \$12.04, therefore, represents the actual cost of reducing a ton of silicious ore, where fluxes are paid for outright, when run in a furnace having suitable lead-bearing ores. In general, however, the lacking iron for the charge is made up, at least in part,

by the iron excess of roasted iron sulphides or other irony ores. Such an ore would make much slag, which would carry away values according to its quantity; 38% of this charge is silicious ore, and the room thus taken up by fluxes is called 'displacement,' to be allowed for in calculating profits because of the smaller tonnage of paying ore put through.

PART VIII. ZINC

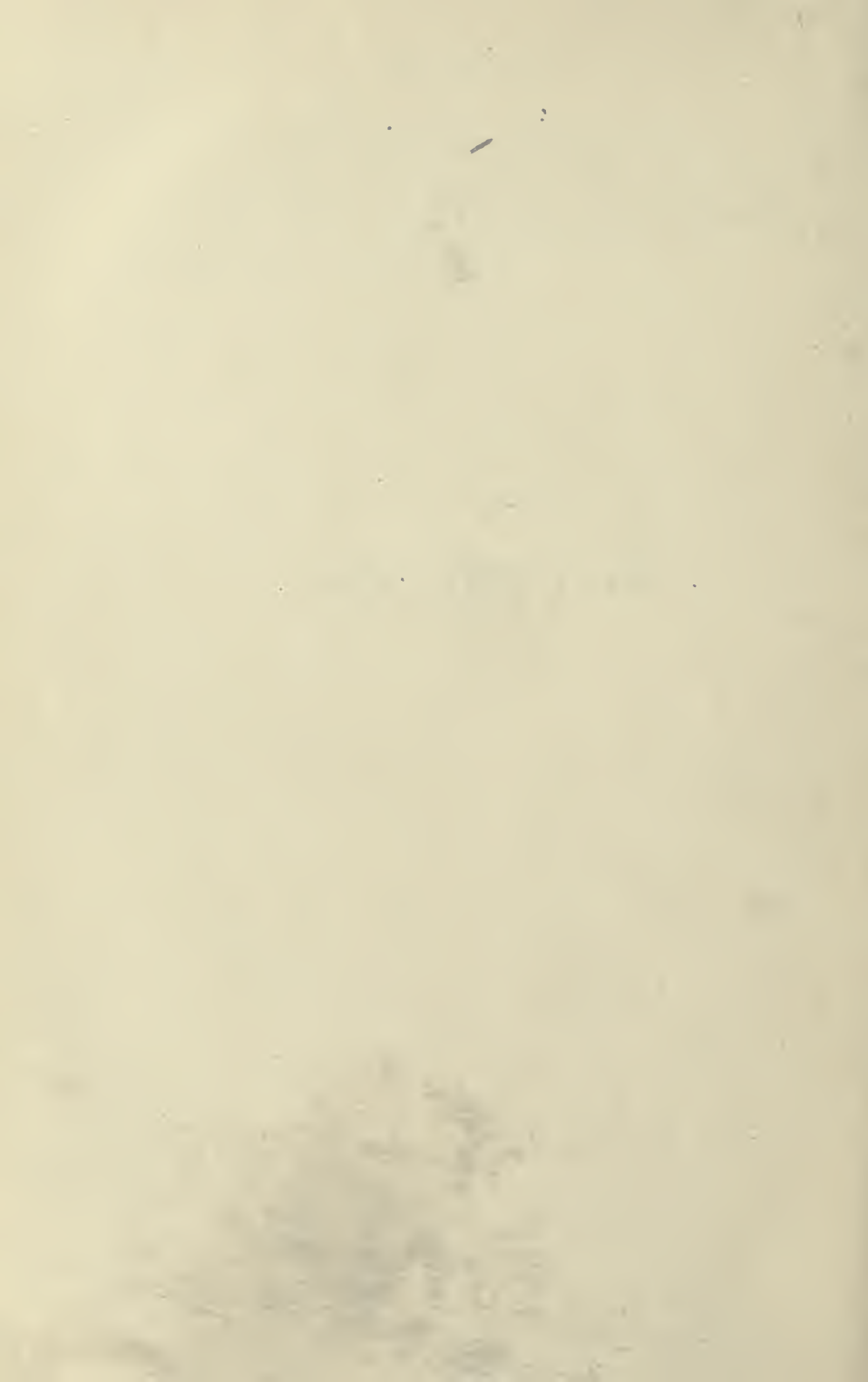

PART VIII. ZINC.

105. PROPERTIES OF ZINC.

Zinc is a white and brittle metal of 7.4 specific gravity. In commercial form it is called 'spelter.' It boils at 920° C, and the fumes condense between 415° and 550° C. If the vapor encounters the air a white smoke of ZnO forms.

106. ORES OF ZINC.

The common ores of zinc are:

Sphalerite.—The rosin-colored sphalerite is called rosin-blende. When dark in color (due to the presence of a little iron) it is termed black jack.

Willemite is a zinc silicate, which receives the common name of calamine. At a high temperature in the retort it is completely reduced by carbon.

Smithsonite or zinc carbonate is decomposed on heating, the CO_2 being driven off. The name calamine is also applied to this ore.

The largest market for zinc ores is at Joplin, Mo., and here ores are bought on a basis of 60% contained zinc, and with less than 1% iron and 2% lead. This basis price used to be reckoned as being 7 times the St. Louis quotations of the price of spelter. Thus, when spelter was quoted at \$5.20 per hundred pounds, the price of zinc ore would be \$36.40 per ton of 2,000 lb. This is an arbitrary calculation, and when zinc ores are in much demand they command a better price than this. For zinc ores, which fall short of the above-named requirements, deductions are made as follows: For all zinc less than 60% deduct \$1 per unit of 1%. All lead in excess of 2% takes a penalty of 60 cents per unit. For example let us take the case of an ore containing 58.5% Zn and 3.3% Pb and 0.7% Fe; thus we have

Basis price on zinc ore of 60 Zn	\$36.40
Deductions for zinc $60 - 58.5 = 1.5 \times \$1 = \1.50	
Deductions for lead $3.3 - 2 = 1.3 \times 0.60 = 0.78$	2.28
Net price paid	<u>=\$34.12</u>

107. METALLURGY OF ZINC.

Roasting.—For the successful roasting of zinc ores a higher temperature is needed than for the roasting of lead or copper ores. Zinc sulphate is formed in the roasting, which is only decomposed at the highest heat of the roaster. We have, in the roasting of blende, the following reactions:

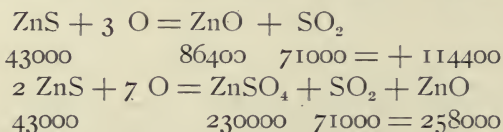

and at the highest heat of the roaster

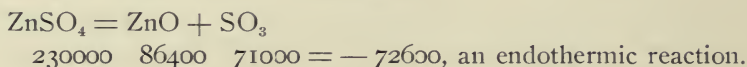

In roasting blende, however, it is difficult to reduce the sulphur contents to below 1% and this means a loss of 2% of zinc. ZnS contains 33% S to 67% Zn.

Reactions in the retort.—When the zinc ore is charged into the retort, together with 40 to 50% of its weight of coal, the following reactions occur:

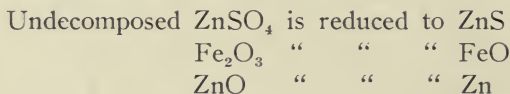
*The zinc furnace.*

The only method of recovering zinc from its ores is by distillation performed in retorts, the zinc ore at white heat giving off its vapor to be condensed into molten form in the cooler condenser.

Fig. 140 and 141 represent, in transverse section and in front elevation, a Western zinc furnace containing 256 retorts. As

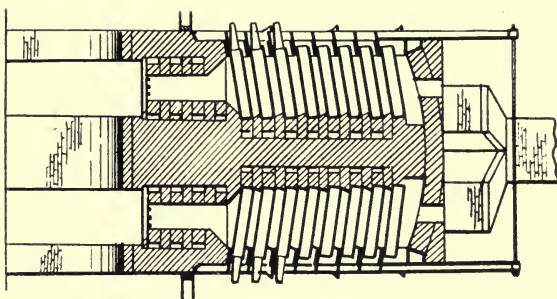

Fig. 140.
ZINC-SMELTING FURNACE (SECTION).

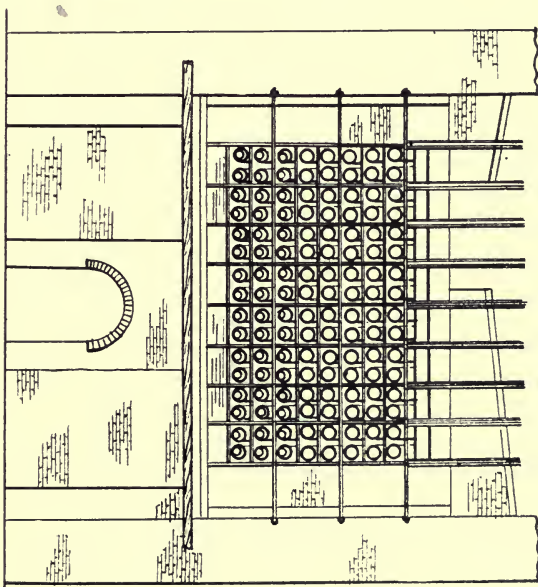

Fig. 141.
ZINC-SMELTING FURNACE (ELEVATION).

shown in 140 there is a middle wall which supports the rear end of the retorts. The front end of these retorts passes through the front walls of the furnace. There are four deep fireplaces extending beneath the retorts and fired by the four end-doors with a soft coal fire, four feet deep, which makes them in reality gas producers. The flame from the fire fills the whole space around these retorts, then passing off by outlet ports in the roof of the furnace, and finally, by flues, to the two stacks, one at each end of the 'block', as it is called. In the figures the three

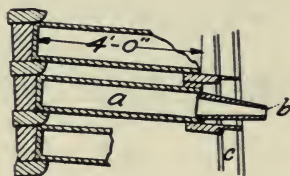

FIG. 142. ZINC-SMELTING RETORTS.

lower rows of the retorts are seen provided with condensers in which the zinc collects. Beneath the grates is ample room for a man to walk, and with a long cutter bar, to 'grate' or clean the fires, removing clinkers and ashes. The working floor, 2 ft. below the lowest retorts, is at the ground level. The block proper which contains the retorts is 14 ft. high, 24 ft. long and 12 ft. from face to face. The single retort with its condenser and the surrounding brickwork of the front and back walls of the furnace are shown in Fig. 142. The retort is 4 ft. long and 8.5 in. internal diameter.

Retorts to withstand the high heat and corrosive action of the charge have to be made of the most compact and durable of fire-clay. The material is composed of a mixture of chamotte 'cement' or 'grog', being burned fire-clay or old broken retorts, brick and tile coarsely ground to 3 or 4 mesh and mixed with an equal amount of raw clay. This is mixed in a pug-mill with about 10% of water to form a stiff mud or 'adobe,' and is allowed to stand for two to four weeks covered with wet sacking to develop the plasticity of the clay. It is then again molded, and finally made into retorts by a hydraulic retort-making ma-

chine under a pressure of 3,000 lb. per square inch. A machine of this kind will make 8 retorts per hour. In Kansas a retort costs 50c. A clay commonly used for retorts contains 30% Al_2O_3 ; 50% SiO_2 ; 15.0% combined water; and 5% of bases.

ZnO is reduced to Zn and is volatilized, and later condensed to spelter. We have

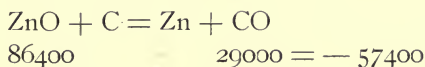

the CO escaping at the end of the condenser and there burning, its characteristic flame, however, being masked by a small amount of zinc vapor escaping and burning at the same time. The reaction, as may be seen, is quite endothermic.

PbO is reduced to metallic lead which, in the small quantity present remains in the retort. CdO is reduced to Cd and being, like the zinc, volatilized, comes away with it, alloying the zinc sometimes to the extent of 0.5%, but most frequently only to a trace. It has not been found to be injurious.

Silver and gold remain in the residues. In Missouri, where there is little or none, the residues are thrown away, but Colorado ores, carrying considerable silver and a little gold, yield residues well suited to further treatment in the blast-furnace, for the extraction of these precious metals.

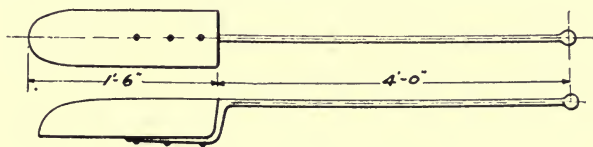

FIG. 143. CHARGE SCOOP.

Retorting.—The ore, together with 40% of fine coal, is mixed thoroughly in a horizontal pug-mill, or upon the floor of the retort house with shovels. The charge for a retort amounts to say 60 lb. of the ore and 40 lb. of coal, and is skilfully and rapidly thrown into the retort with a special scoop shovel (Fig. 143) lifting it clear to the back.

An iron rod is now run along the top of the charge to form a channel for the escape of gases, and the condenser is adjusted

in position and luted with a loamy clay. To make the joint tight a crescent-shaped 'stamper' is used, by which the clay is compressed around the condenser. The stamper (Fig. 144) is of the form herewith shown and before using, is heated to a low red heat in one of the lower rows of retorts, called cannons. These cannons are not used for retorting, being left there to modify the direct heat from the fierce fire below.

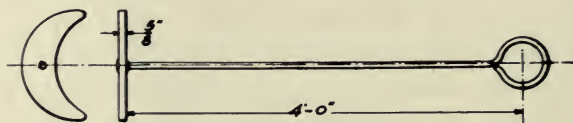

FIG. 144. STAMPER.

A charge of 60 lb. of 60% zinc ore, if dead roasted, would contain of zinc oxide 45 lb. or of zinc 36 lb. and would yield at the best 95% of the contained zinc. The residues from a zinc charge of 100 lb. (60 lb. zinc and 40 lb. coal) would consist of

ZnO and ZnS, the former still persistently remaining in the residues, and the latter being unacted on by the coal	2.5 lb.
Gangue and ash from both ore and coal.....	25.0 lb.
Unburned coal (two-thirds having been consumed in the reduction operation.....)	13.0 lb.

Making a total of40.5 lb.
or a decrease in weight of the original 100 lb. of 59.5%.

To continue: The retorts are fired on and brought up to a white heat of 1,300° C. As the charge becomes heated, moisture, volatile gases (as the result of the distillation of the coal) are given off and the reactions, already specified, are begun between the ore and carbon. The zinc vapor, as it distills, enters the cooler condenser and condenses into a liquid form. The end of the condenser is loosely plastered over with a little of the charge mixture, and from time to time, the accumulating zinc is removed with a ladle, the aperture of the condenser being at once plastered over again. Toward the end of the distillation firing is the most vigorous in order to remove the last

traces of metal from the charge. As the charge is put in early every morning, the ore is nearly 24 hours in the retort.

Replacing retorts.—The average life of a retort is 40 charges; some break after a charge or two, and some have a long life. Where the ore contains iron it has a corrosive action on the retort, eventually eating it through. Again, a retort may crack, when it must be removed and replaced by a fresh one. Any such accident is indicated by the failure of the slight flame or smoke, which generally issues from the condenser, there being on the contrary an inward current due to the chimney draft sucking the air through the crack of the broken retort. Retorts are not set in place when cold, but are heated in a small coal-fired annealing-furnace, are brought to the bank of the retorts red-hot, and at once put in place. Room has first to be made by breaking out the old retort and its surrounding brick of the furnace front.

Manufacture of retorts.—The success of the retorting operation depends upon the durability of the retorts, and this, again, upon their composition and manufacture. Since the bases of the charge attack the retorts, a silicious mixture would be more corroded than a neutral one, and hence, the endeavor would be to increase the percentage of clay. On the other hand, much clay would make the retort more fusible and more liable to shrink and crack.

Costs of retorting.—Bituminous coal is used to an amount varying from 2 to 4 tons per ton of ore, according to the character of the coal.

Herewith we give the cost of smelting blende concentrate per ton of raw ore, using coal for fuel. This includes the cost of roasting in the hand-stirred reverberatory roaster.

Labor (except for repairs and renewals).....	\$6.62
Fuel, 3 tons at \$0.75.....	2.25
Fine coal or coke for reduction $\frac{1}{2}$ ton per ton of ore at \$0.84.....	0.47
Clay for retorts 0.1 ton per ton of ore at \$2.60....	0.26
Repairs, renewals and sundry supplies also putting repaired furnaces in operation (heating up)...	0.75

\$10.35

Recovery or extraction.—This depends upon the grade of the ore, and while on an ore (such as is worked in Germany) containing 25% zinc the recovery would be 75 to 85% ; in the Joplin, Mo., district, on basis 60% Zn, an extraction of from 85 to 95% has been attained.

Losses of zinc.—They occur both in roasting and in retorting. In roasting there is a volatilization and a dust-loss and also a loss due to the undecomposed ZnS, one per cent of sulphur locking up 2% of zinc. In retorting there is an evident loss at the mouth of the condenser due to the escaping zinc flame. Then, since the walls of the clay retort are porous, the zinc vapor filters through under the suction of the furnace draft. This is lessened, however, by dampering at the stack and by making a forced undergrate pressure. Zinc is also to be found in the residues, especially near the mouth of the retort, where the heat is less. It may amount to from 1 to 4%. These various losses account for the extractions already given.

Impurities in the ore.

Iron exists in many ores. In the Joplin district anything over 2% iron is considered a detriment to the ore, lessening the price in consequence. Iron has a corrosive action on retorts, uniting itself to the silica of the retort and slagging and softening it and eventually eating through. A remedy for this is the use of retorts lower in silica and higher in alumina. Nevertheless, at the Vieille Montaigne works in Belgium, ores containing as high as 20% Fe are worked. At Pueblo, Colo., Leadville ores, high in iron, are also treated, the iron in this case being a chemical constituent of the blende.

At both Vieille Montaigne and at Pueblo, ores containing lead are treated. The lead becomes reduced, and either remains mixed with residue, or accumulates near the mouth of the retort. Since, at the high heat of the retort, it is somewhat volatilized, it contaminates the zinc, and must be later removed by a refining operation.

Sadtler process.—To counteract the corrosive action of bases, Prof. B. Sadtler has patented a process which consists in lining the retort with a basic lining 0.125 in. thick. The lining is suffi-

ciently effective to double the life of the retort, so that it fails by cracking rather than by corrosion. The process is in use at the works of the Cherokee-Lanyon Spelter Co. near Joplin, where Colorado ores containing considerable iron and lead are successfully treated.

PART IX. REFINING

PART IX. REFINING.

108. REFINING OF METALS.

General phenomena underlying the refining of metals.—

It will be noticed that in the separation of metals from one another and from the contained impurities it is extremely difficult to complete the separations. Thus, in spite of the pains taken to so do, the commercial metals contain traces of these impurities. Metals thus prepared are therefore graded according to quality and take different prices in market according to those grades. Thus, Lake copper commands the highest price because of its purity and toughness, while casting copper is reserved for making copper castings or for brass-making.

This is exemplified in chemistry in the precipitation of BaSO_4 from a BaCl_2 solution, by means of H_2SO_4 . For all that the reaction is so perfect, we find a little BaSO_4 still remaining in solution. On the other hand, the precipitate is not perfectly freed from BaCl_2 , even after thorough washing. In silver-lead blast-furnace smelting the slag, no matter how perfectly separated, still contains 0.2 to 0.3 oz. silver and 0.3 to 0.4% of lead. In copper refining arsenic, antimony and bismuth, occurring in the crude or blister copper, is retained in traces, even after refining, and, where the original blister copper is impure, no high-grade product can be expected. In the separation and deposition of copper by electrolysis the same conditions hold. At low current densities, even in presence of impurities in solution, the copper is of the highest grade; still traces of the impurities do find their way into the cathode copper, less so, however, than in any other system of refining.

109. PARKE'S PROCESS FOR THE REFINING OF BASE-BULLION.

To get a clear idea of refining of base-bullion or work-lead it is necessary to know what is its composition of which we give an unusually base example as follows:

Lead		96.59%
Impurities: Cu.....	0.82	
As.....	0.38	
Sb.....	0.71	
Fe.....	0.02	
S.....	0.14	
	—	2.07
Precious metals Ag..	1.07 (322.0 oz. per ton)	
Au..	0.0007 (0.20 oz. per ton)	1.07
	—	99.73

In refining, the problem is to soften the base bullion by removing the impurities and from the softened lead taking out the precious metals. In studying the process the student should often refer to Fig. 157.

Softening.—This is performed in a reverberatory furnace (Fig. 145).

The hearth of the furnace is surrounded by a water-jacket *a* to assist the brickwork in resisting the action of the molten litharge, and is heated by a fire-box *f*. The base bullion, in charges of say 30 tons, is charged into the furnace by means of a long-handled paddle or peel. The charge is melted down, filling the furnace with lead, the dross rising to the top. After two hours the dross, which has had the lead sweated out of it, is skimmed off with a long-handled perforated paddle. This dross, residue or skimming, called the 'copper skim' contains the iron, sulphur and especially much of the copper of the base-bullion. The heat is now raised to a bright red, and, with an oxidizing flame sweeping over it, litharge keeps forming and the arsenic and antimony oxidize and enter the litharge slag. This action is kept up for 12 hours, or until, by inspecting a sample taken

from the furnace, the lead shows itself free from arsenic or antimony. The furnace is allowed to cool, and when the litharge crust is set or become solid, it is skimmed off. For impure bullion, this operation of heating up, oxidizing and again cooling may have to be repeated in order to remove the last traces of arsenic and antimony.

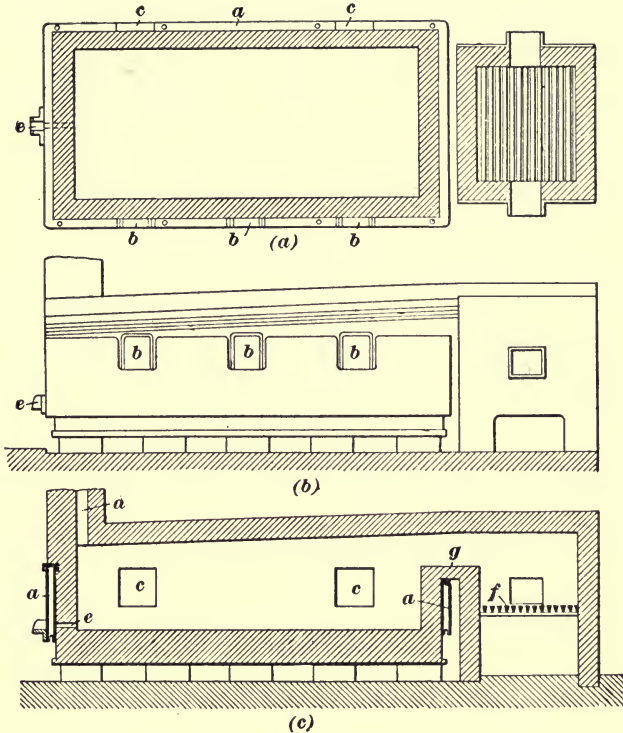

FIG. 145. SOFTENING FURNACE.

The softened lead is tapped into a hemispherical de-silverizing kettle, 8 ft. diam., capable of holding readily 30 tons of lead, and set in brickwork with a fire-box below. It is heated well above the melting point of zinc, and about 1.2% zinc (but varying with the richness in silver) added to the lead. Using the Howard apparatus for de-silverizing the process is then as fol-

low. Fig. 146 represents the kettle and the apparatus used for mixing the molten zinc intimately with the lead. The machine is lowered into the kettle in the position shown at *a* and the propeller *b* set in motion by a steam-driven mechanism, so as to produce a downward flow in the cylinder *a*, lead at the same time flowing in from above. Thus a thorough mixing of the contents of the kettle is assured, the mixing being kept up for about 10 minutes. The stirrer is then raised and moved to one

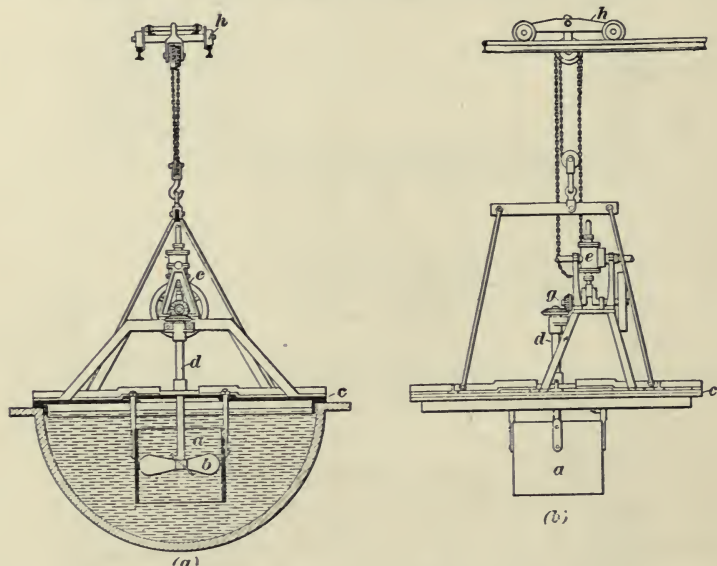

FIG. 146. HOWARD MIXER.

side, traveling on the crawl *h*. The contents of the kettle are allowed to cool down for about two hours, by which time the 'zinc crust,' a lead-zinc-silver alloy, lighter and more infusible than the lead, rises to the surface. In other words, the zinc, having a greater affinity for gold, silver and copper than lead, removes it from the latter as a crust or alloy. Such a crust may contain 70% Pb, 15% Zn and 8% Ag.

Fig. 147 represents the press by which the solidified crust is removed from the surface of the molten lead. It consists of a cylinder *a* which is partly lowered into the lead. The follower *c*

is raised, and the zinc crust skimmed into it by means of a perforated flat skimmer. Fig. 148. When full, the press is raised

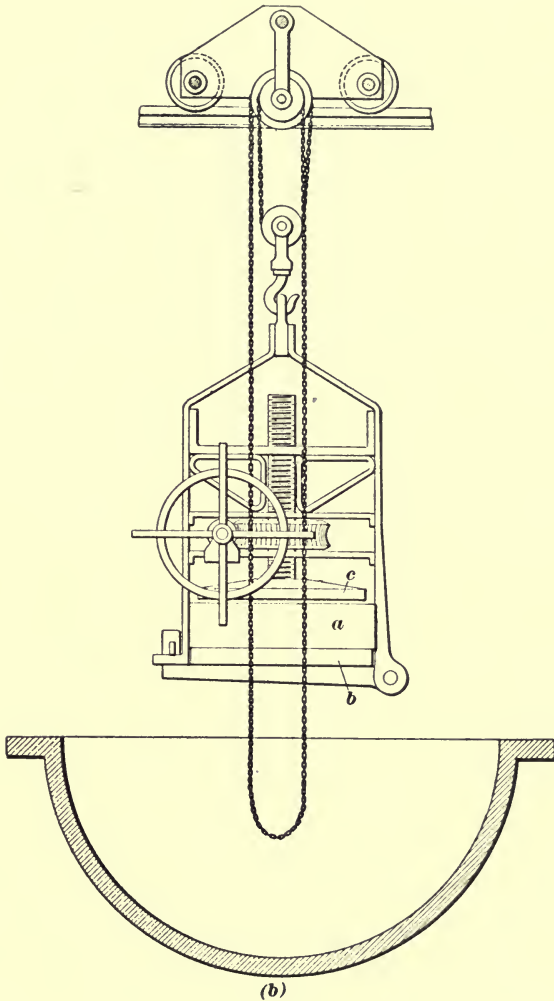
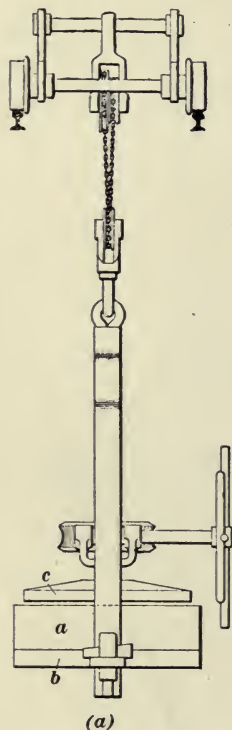

FIG. 147. HOWARD PRESS.

and the plunger brought down in the cylinder, squeezing out the surplus lead, which escapes through the perforated bottom *b*. The press is moved to one side, the hinged bottom *b* is dropped

and the zinc crust pushed out, falling upon the cast-iron floor-plates, where it is broken up in pieces of fist-size. The operation of skimming and pressing is then repeated until the lead is well skimmed. This crust may amount to 3,000 lb. and contain 90% of the silver originally in the softened lead. This first zincing



has not removed all the silver and the operation must be gone through with once or twice more before the contents are brought down to a fraction of an ounce per ton. The second and later crusts, thus obtained, contain comparatively little silver and are returned to a following charge where their contained zinc becomes effective in removing other silver.

The de-silverized lead in the kettle still retains about half of the zinc originally put in it, which must be removed. This is done by tapping it to a calcining furnace, a reverberatory like the softening furnace already described. Here the charge is brought to a bright-red heat, which results in volatilizing and burning off the zinc, some litharge being, at the same time, formed by the scorification of the lead.

Finally the lead goes to a market kettle similar to the de-silverizing kettle. This is the reservoir from which it is drawn to be cast into molds. The molds, standing in a semi-circle, hold 100 lb. of lead each, and

when full of lead, they are transferred to an adjoining place to be tilted out of the molds. The lead is withdrawn from the kettle by means of a syphon and descends into a small cast-iron pot into which is screwed the 2-in. pipe which delivers the lead to the molds, this pipe being quickly moved from mold to mold as each is filled. These pigs or bars are the de-silverized lead of commerce.

Dry steam is sometimes blown into the lead in the market-

kettle to refine it, the steam being introduced by means of a pipe inserted deep beneath the surface. In this way the last traces of impurities are removed. It is softer than ordinary de-silverized lead and more easily corroded by acetic acid in the process of making white lead and accordingly it is called 'corroding lead.'

Referring to Fig. 157, let us see what becomes of the crust or skimmings, the result of the first zincing. The material, in lumps and containing $12\frac{1}{2}$ to 15% zinc, is charged into the bottle-shaped retorts *f* (Fig. 150) each capable of holding 1,200 lb. of the crust. Here it is heated to a yellow heat



FIG. 148. SKIMMER.

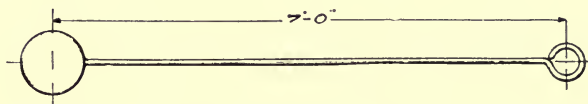

FIG. 149. STIRRING PADDLE.

($1,000^{\circ}\text{C}$), the retort being surrounded by a coke fire, the products of combustion passing off by the outlet-port seen to the left. A condenser, made by cutting off the end of an old retort, as shown in *c*, serves to collect the zinc vapors arising from the charge, the condensed zinc being drawn off into molds *X* through a one-inch hole bored at the bottom corner of the condenser. When distillation is complete, the condenser and its supporting truck are removed, and the furnace is tilted, the remaining 'rich lead' pouring out into molds like those used for market-lead.

To remove the lead from this alloy the English cupelling furnace shown in Fig. 152 and 153 is used. The principle of its action is much the same as in cupelling for assay, except that the litharge instead of merely saturating the cupel, flows off as it is formed. Fig. 153 is a sectional elevation, showing a

fire-box (*a*) where a long-flaming coal is burned, the products of combustion passing to the chimney under the floor by the down-flue marked *b*. In so doing the flame plays over a movable hearth called a test, not shown in Fig. 153, but shown mounted

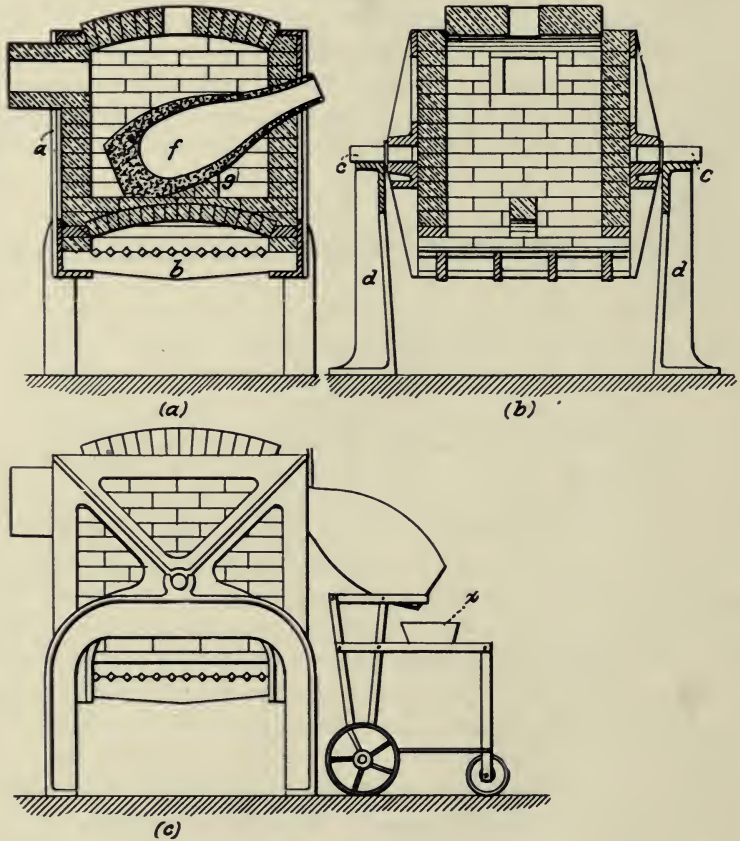

FIG. 150. FABER DU FAUR RETORT.

on a carriage in Fig. 152. This test is hollowed out like a cupel sufficiently to hold a shallow bath of molten lead to the depth of 3 in. Fig. 155 and 156 show two views of the oval test and its supporting truck, Fig. 156, being an inverted view of the truck and test. On the elevation (Fig. 152) will be seen a pipe

which brings in air to a tuyere set into the back opening just above the hearth. This plays upon and oxidizes the lead to

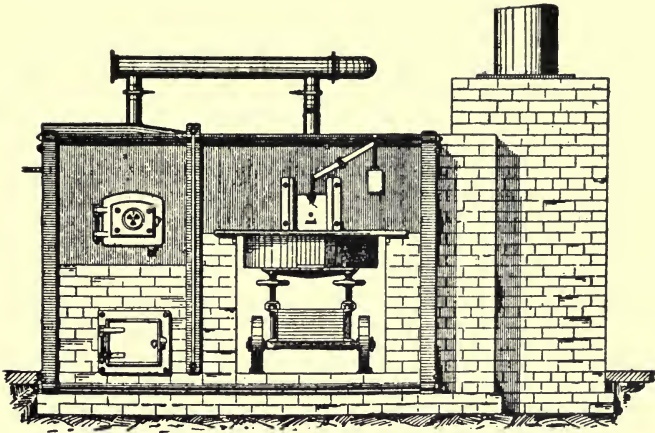

FIG. 152. ENGLISH CUPELLING FURNACE.

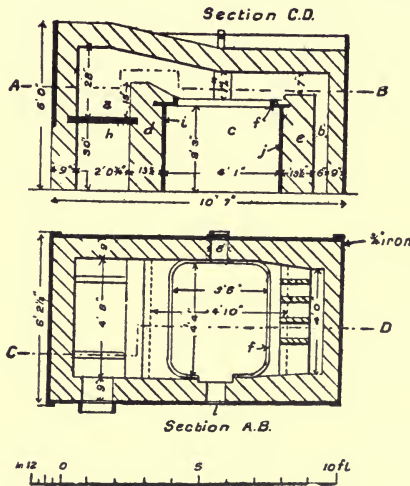

FIG. 153. ENGLISH CUPELLING FURNACE.

litharge, which as it forms runs off by a shallow groove or gutter made at the front edge of the test. To keep the test full rich lead is fed in at the rate of one to two tons daily until the bath

has become rich in silver, when the feeding is stopped, the remaining lead being oxidized off leaving the molten silver, which is tapped into molds each holding upward of 1,000 oz. This silver is then subjected to the acid-parting operation described in the chapter on refining.

The first and third skimmings (if any) of the softening furnace, as well as the silver-bearing litharge from the cupelling

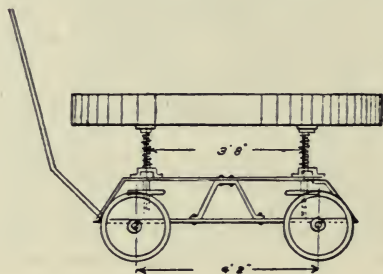

FIG. 155. TEST FOR ENGLISH CUPELLING FURNACE.

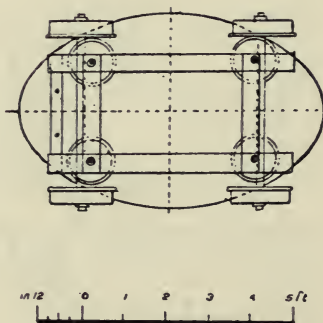

FIG. 156. TEST FOR ENGLISH CUPELLING FURNACE (INVERTED VIEW).

furnace are returned to the silver-lead blast-furnace where the sulphur of the charge unites itself with the copper, especially that of the first softening-furnace skimming, removing it as matte; while the rest, reduced to lead, again returns to the refinery.

The second softening-furnace skimming goes to a small reverberatory, in shape like the softening-furnace, and

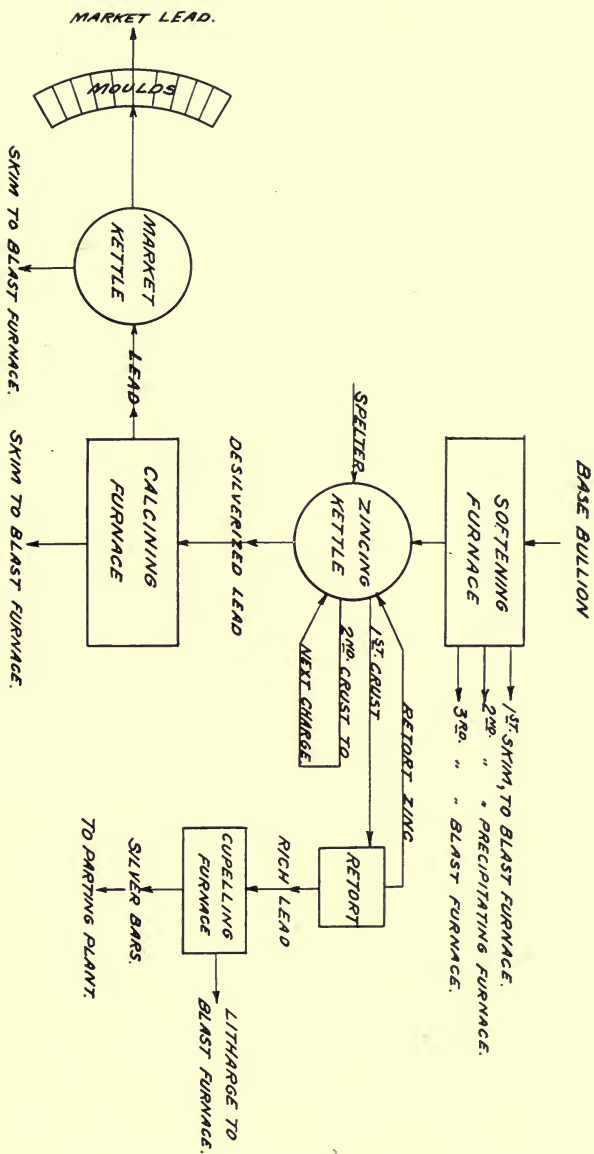

FIG. 157. FLOW-SHEET FOR LEAD REFINING.

called a precipitating furnace. Here it is melted down at a good heat into a slag, some charcoal added and stirred in so as to precipitate or reduce a portion of the lead. This, falling to the bottom of the bath, accumulates there, while the supernatant slag, containing the antimony, is tapped off. The precipitated lead bullion later goes to the refinery to be softened and de-silverized. The antimony slag (nearly free from silver) when a sufficient quantity has accumulated, is melted in a small blast-furnace, reducing an antimonial lead which is sold to type foundry, while the slag produced is thrown away.

110. VARIATIONS IN METHODS OF LEAD REFINING.

Variations on the regular method, already given, are as follows:

Instead of removing the gold and silver together in the first crust, it is possible to take out the gold (with some of the silver) by a separate zincing in which a moderate amount of zinc is used. This is due to the fact that zinc has a greater affinity for gold than for silver. Since zinc has even a greater affinity for copper, the little still remaining in the base bullion is taken up also. We thus get a crust containing all the copper, all the gold and some silver, and from this crust is produced a doré silver bar. The next zincing removes practically all the silver; and the crust yields a silver bar free from gold, which needs no parting, and which brings the full price of commercial silver.

In the earlier practice of lead refining on clean base-bullion, softening was performed in the kettle, the metal was heated to just melting temperature, and the lead was sweated from the copper crust, which latter was skimmed. The skimmed lead was then heated to a red heat by vigorous firing, was stirred and subjected to the action of the air. Since the quantity of arsenic and antimony was limited they could be removed in this way. For ordinary base-bullion this method would, however, be inadequate, and therefore the softening furnace is used.

With regard to the lead just de-silverized, the contained zinc may be removed in the de-silverizing kettle without the use of a reverberatory furnace. This is accomplished by heating the

lead in the kettle to a high degree and poling or rabbling it by means of dry steam or compressed air. The zinc is thus in part volatilized, in part oxidized, together with a little of the lead, forming a powdery litharge which is skimmed off, leaving market-lead.

In the older way of stirring the zinc into the charge of the de-silverizing kettle, the work was done by means of paddles. The paddle shown at Fig. 149 had a handle about 7 ft. long. Two men, on opposite sides of the kettle, worked these, making strokes as follows: The paddle-blades were moved downward to near the bottom; then, by pressing down on the handles, and prying upward, the molten zinc was stirred into the lead, the stirring taking about 15 minutes to complete.

Where machine methods were not used, the first, or silver crust from the de-silverizing kettle was transferred to another kettle, and there kept at a just visible red-heat. In consequence, segregation occurred by which the liquid portion was separated and returned to the next charge, the dry crusts, rich in silver, going to the retorts.

Besides the regulation method of obtaining the copper crust by removing it from the softening furnace, another effective way has been used. This consists in charging the base-bullion into an inclined-bottom reverberatory, where the lead, as fast as it sweated or liquated out, would drain off to be collected in a small kettle or sump outside the furnace. From here it was molded into bars. The dry residue was the copper crust.

III. CHARGES FOR REFINING BASE-BULLION.

In general, the metallurgist who operates a smelting works has nothing to do with the refining of his product, which is sold to the refinery. If a smelting works is distant from market, a month or six weeks might elapse before returns would be available from the refining and sale of its product. The smelting works may obtain advances on the product thus locked up, by arrangement with a local bank. The bank may agree to honor a draft made upon it to the extent of 80% of the value of the shipment of the base-bullion, when the draft is accompanied by

a signed shipping receipt for it, as consigned to their account, together with the smelter certificate of assay. The refinery pays the bank for the full value of the product when refined, and the 20% balance due is then credited by the bank to the reduction works. This is often of great assistance to a works, which thus procures the money needed for operating expenses as soon as it has loaded out the base-bullion. By arrangement with a refinery, a reduction works may obtain the following credits and charges for refining per fine ounce at the reduction works:

For *silver*: the New York quotation per fine ounce less one cent per oz. (this deduction is to meet the expense of parting).

For *lead*: the New York quotation less 12½c per 100 lb. or \$2.50 per ton of contained lead. The deduction is made to meet the cost of freighting the lead from the refinery to New York City.

For *gold*: \$20 per ounce. The mint value is \$20.67 per oz., so that the refinery obtains a profit on the difference.

From these values must be deducted the treatment charges of \$12 per ton, and the freight (advanced by the refinery) of, say, \$8 per ton.

Compare these charges with actual costs of refining as per the following estimate:

Prime cost of softening and refining....	\$5.00 to \$6.00
General expense.....	3.00 to 3.00
Loss in metals and incidental expenses...	1.70 to 3.00
	—————
	\$9.70 to \$12.00

112. ELECTROLYTIC REFINING OF COPPER.

The blister-copper as it comes in from the reduction works in the West, is sampled* by taking drillings from each bar. These drillings, mixed together, represent the bars of a given lot. The copper is now sent to the re-melting furnaces, each capable of holding 150,000 lb. copper. Here it is somewhat refined by rab-

* This description of a copper refinery is based on the practice at the Raritan Copper Co., Perth Amboy, N. J.

bling and poling and it is then cast into anodes by Walker casting-machines. As the anodes come from the machine they are trimmed from any fins of copper and racked on trucks, 22 together.

The trucks thus loaded are moved into the tank-house where the anodes are picked up, the group of 22 together, and placed in the tank. There are 420 tanks in all, each tank being in electrical series with the next. The current goes through each of the 22 plates or anodes to the cathodes opposite and placed about 2 in. apart. Assuming that the anodes are 2 by 3 ft., the current leaving both faces, we have a total area through which the current is passing of 264 sq. ft. with a density of current of 15 amperes per square foot. We thus have a total of 3,960 amperes. These plates are immersed in a solution or electrolyte of CuSO_4 in dilute H_2SO_4 , the CuSO_4 being 15% (4% Cu), and the sulphuric acid 10% of the solution. The resistance in passing through this space of about 2 inches to the cathode is 0.25 of a volt. The tanks in series would therefore give a resistance of 105 volts.

For the cathodes, so-called 'stripping plates' are prepared as follows: In a portion of the tanks insoluble anodes of lead are used, opposite to which are set greased copper plates, upon which is precipitated a layer of copper. When this layer becomes $\frac{1}{32}$ inch thick, the greased plates are removed from the tank, and these coatings or sheets of copper are stripped off, the greased surface having prevented adhesion. Loops of similar copper are riveted to these plates, which, suspended in the regular tanks, form the beginning of the cathodes.

One ampere will deposit an ounce avoirdupois of copper in 24 hr., so that, at this plant, each plate increases in weight nearly 12 lb. daily. At the end of two weeks the completed cathode, weighing 160 lb., is removed, and another one, replacing it, will receive what has been left of the anode. Of course, not all the copper is dissolved, since the part above the solution and the skeleton of the plate, at least, must be there to transmit the current. Even then, shreds and pieces of copper drop to the bottom of the tank, and the fragmentary anode is removed, still having 15% of its original weight. They are re-melted and re-cast into new anodes.

113. COSTS OF ELECTROLYTIC REFINING OF COPPER.

In the earlier experiences of refining costs were high, as much as \$20 per ton, and refiners charged \$40 per ton. At present the cost of refining 98% copper anodes has been lowered to \$4 and \$5, and contracts have been closed at as low as \$7.50 per ton of anodes. This is due to economy of power and in handling material.

Current density.—The greater the density of the electric current through the electrodes the faster the deposition; and hence the smaller stock of metals which needs to be carried for a given output. Thus at Great Falls, Mont., the current density is 40 amperes per square foot of anode-surface, while at Perth Amboy, N. J., the density is 15 to 17 amperes. At high density there is the chance of short-circuiting, and moreover, the cathode plates take on more impurities, as antimony and arsenic, from the bath. It takes a month for an anode to dissolve; hence, in a large refinery, from half a million to a million dollars may be tied up in copper and in the precious metals.

Treatment of the slime or anode mud.—From time to time the thin mud which accumulates in the bottom of the tanks is removed by decanting off the clear electrolyte, and then washing the mud into a tight car placed below the outlet-plug of the tank. The mud contains fragments of copper of all sizes, dropped from the anodes when nearly dissolved and which are mostly removed in passing through a 40-mesh screen. The mud is transferred to a settling tank. From here it is drawn to a pressure tank and thence to a filter press, dried by steam to 2% moisture, and broken up. It is then ready for treatment on an English cupelling-hearth. Here it is brought in the furnace upon a lead bath into which it is melted, the lead taking up the silver and gold. The impurities, as copper, arsenic, antimony and tellurium, are scorified, going into the air and into the litharge, which forms under the action of the air-blast commonly used in this kind of furnace. The lead, having been cupelled away, the doré silver left, is removed and molded into bars. The scrap copper, which was removed from the anode-mud, as above referred to, is re-melted and re-cast into anodes. Such scrap, together with the rest of the un-

dissolved anode, amounts to 15 to 20% of the total. Another method of treatment consists in treating the anode-mud with dilute sulphuric acid which will remove the copper.

Purifying the Electrolyte.—The electrolyte commonly contains 16% H_2SO_4 and 4% copper. When the copper exceeds this quantity the resistance increases, and hence the copper should be removed from the system. The solution also contains iron, arsenic and antimony. Antimony may, however, be kept low by the daily addition of a small amount of salt, which precipitates it as an oxychloride. To purify the electrolyte the following method is used. A portion of the electrolyte is diverted to tanks having lead anodes and using a strong current. The impurities, together with some copper, are deposited loosely upon copper cathodes. Every two months the accumulated mud, containing 40 to 60% copper, is cleaned out and reduced to impure bars at a refining furnace. The electrolyte, thus purified, is standardized to the proper strength and returned to the circulation.

Circulation of the electrolyte.—To avoid short-circuiting and to increase the activity of deposition, the electrolyte is made to flow through the tanks entering near the top at one end, and rising through an overflow pipe at the other. After it has flowed through two tanks in this way, it enters a launder which returns it to a collecting or sump tank. Here it is brought up to a temperature of $40^\circ C$ by the use of a steam-coil and is then pumped to the distributing tank for re-circulating.

Capital in plant.—Not only is there capital invested in the buildings and machinery of the plant, but there has to be capital provided for

- (1) The stock of anodes in process of treatment.
- (2) The stock on hand for one month.
- (3) The copper locked up and permanently in the electrolyte or solution.
- (4) The copper locked up in heavy conductors.

Testing the current.—Besides the recording instruments to be found on the switch-board of the generators in the power-house it is customary to use others constantly in testing the drop of potential between plates. To do this a forked rod is used which touches adjoining plates and which transmits the current through

a volt-meter. Any variation due to short-circuiting is thus known and at once rectified.

114. COPPER REFINING FURNACE.

Fig. 158 represents, in sectional plan and Fig. 159 in sectional elevation, a copper-refining furnace, 12 by 18 ft. in size, suited to the treatment of blister copper, and of a capacity of 30,000 to 40,000 lb. to the charge. The stack or chimney (not shown) is close to the furnace, with a communicating outlet-flue indicated in the elevation. For the admission of air there are air-ports at the sides as seen in the plan, also a row of air-holes over the bridge. An arched space is left below the hearth for ventilation, and a pit is provided next to the ash pit where stands the fireman when grating or cleaning the fire. The bridge, as shown in the elevation, is provided with a hollow casting called the conker-plate in which circulates air for cooling it. At the front end of the hearth, next to the front door, will be noticed a bowl-shaped depression or sump, whence the metal may be dipped or ladled out.

We may add that in recent practice much larger and deeper furnaces are used than here specified, and having a hearth dimension 14 by 26 ft. and holding over 200,000 lb. of copper. So large a quantity of copper could hardly be handled by the slower methods of molding, and, for so doing, copper casting-machines are used, capable of molding 50,000 lb. of copper per hour.

115. COPPER REFINING.

Blister copper, whether produced by the converter, the reverberatory furnace, or by melting down concentrate (mineral) from the native copper ores of the Lake Superior region, still contains impurities, principally arsenic with some sulphur and iron, which must be removed by refining.

This is performed in the furnace Fig. 158. The charge of 30,000 to 40,000 lb. in pigs is put in at the side doors of the furnace. Where it is fine enough, as in nearly pure 'mineral', it may be dropped through the roof from an overhead hopper. In the

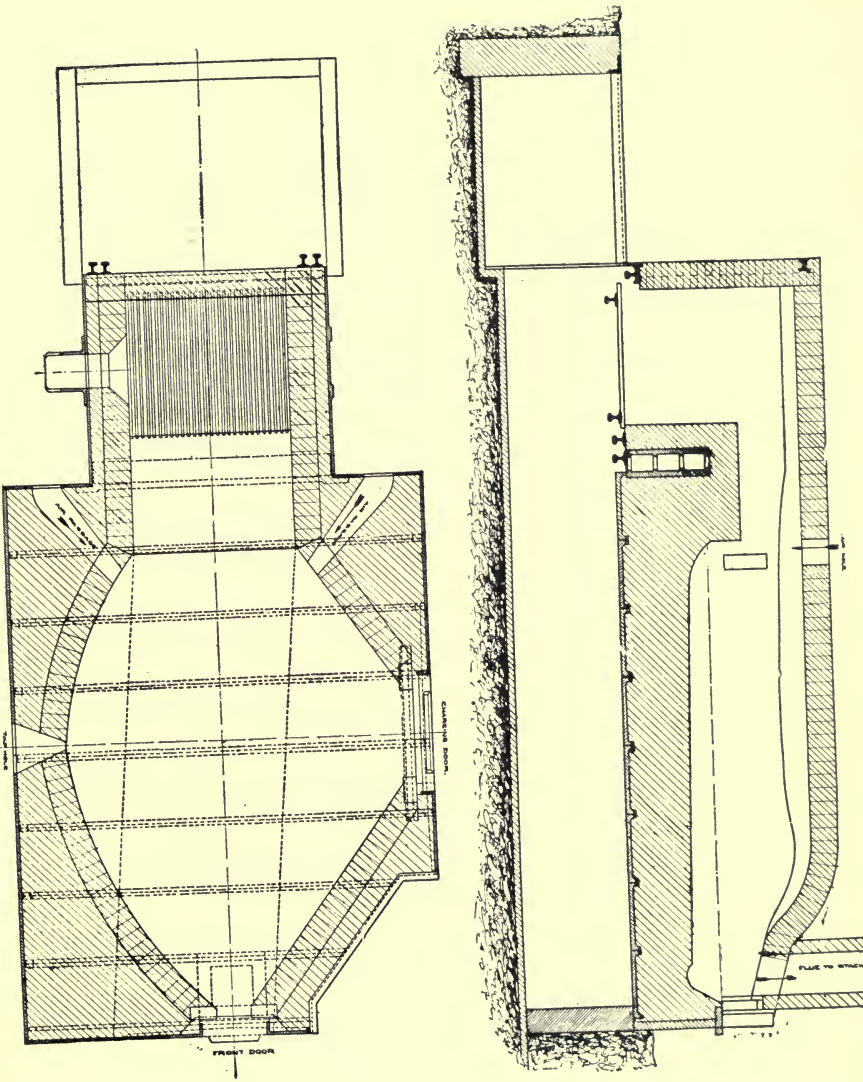

FIG. 159. COPPER REFINING FURNACE. (Sectional Elevation.)
FIG. 158. COPPER REFINING FURNACE. (Plan.)

Lake Superior country large pieces of copper, sometimes tons in weight and called 'mass copper,' are put in through a hatch or large opening in the roof, this hole being then covered by a lid or cover of brick bound in an iron frame. The furnace is now vigorously fired and the charge melted down, this taking several hours. The front door is then opened and the rabbling or flapping of the charge takes place. This consisted formerly in striking the surface of the copper with a rabble in such a way as to splash it up exposing it to the action of the air. The present practice is, however, to insert a 0.75-in. pipe in the molten metal by which compressed air is driven into it, agitating and at the same time oxidizing it. This action proceeds to the stage of set-copper, the arsenic being oxidized and driven into the slag as well as volatilized, and the copper having absorbed an excess of oxygen. The slag, formed during the operation, is then skimmed off. The oxygen must next be removed by poling, which is done by inserting into the front door spruce or poplar poles, the butt ends of the poles being forced into the metal. At the same time a wheelbarrow-load of charcoal is thrown in to assist reduction. This work takes an hour or two, a sample of the copper being taken from time to time until the copper has gotten to "tough pitch", which is shown by the appearance of its fracture. The contents of the furnace are now ready for dipping out into molds by means of ladles. These are either hand ladles, or so called "bull"-ladles capable of holding 200 lb. of copper each, carried by an overhead trolley, and by which the copper is readily handled. The molds are of different forms or shapes called for by the trade; forming cakes for rolling into sheets, ingots for melting into brass, and wire-bars for making into wire. Where the copper contains silver enough to justify so doing, the copper for electrolytic refining is cast into anodes.

116. PARTING GOLD-SILVER BARS.

Nitric acid parting:—This method, still practised at the United States Mint, Philadelphia, is a very efficient way of parting, especially when working on a small scale. Commercially, however, parting with sulphuric acid is cheaper, and is generally used.

In any case the bars, when containing too great a proportion of gold are inquartated by melting them with silver so as to bring

down the proportion of gold to one-fourth of the whole. In parting by sulphuric acid, the amount of copper in the bars should be less than 10%, but in nitric acid parting more than 10% is allowable. The melt is granulated by pouring the metal into water. It is now treated with strong nitric acid of 1.20 sp.gr. in porcelain, glass, or platinum vessels. When action of the acid has ceased, the solution is decanted and fresh acid added which dissolves the remaining traces of silver. This is again decanted, and the gold residue washed thoroughly with hot water. It is then withdrawn, mixed with a little flux, and melted in a graphite crucible. From the nitric acid solution the silver is precipitated by the addition of common salt. The silver chloride thus formed is washed thoroughly, zinc added in quantity sufficient to reduce the silver to metallic form, and the zinc chloride is washed out from the precipitated silver. The silver is pressed into cakes and melted down in crucibles into bars for sale.

Sulphuric acid parting.—Since in this method of parting there must be less than 10% copper, it is necessary to correctly proportion a melt, hence an unlimited number of mill bars high in copper would be inadmissible. The bars or ingots of the metal are put into a cast-iron kettle covered with a hood and treated with a quantity of sulphuric acid of 66° B. When action has ceased, the acid is allowed to settle and the clear supernatant acid is drawn off by means of a syphon to a lead-lined precipitating tank, while the residue in the tank is treated six or seven times to fresh acid. In this way the silver is completely dissolved, the clear acid being removed after each treatment. The gold residue is then boiled with water, heated and agitated by live steam from a pipe inserted in the water. In this way the gold is sweetened. It is removed from the kettle, dried and melted in crucibles with a little borax for flux. The acid solution from the kettle containing the silver is now diluted with some water, and the silver is precipitated by hanging copper plates about one inch in thickness in the solution, which becomes of a blue color from the presence of the copper. When precipitation is complete the clear solution is decanted and the cement silver at the bottom of the tank is washed with hot water to remove all acid and the copper in solution. The cement silver is then removed to a hydraulic press since it is too

bulky to melt directly in crucibles. When thus compressed it can be readily melted down in plumbago crucibles with a little nitre. In large establishments the melting down is performed in an English cupelling furnace where it can be conveniently fluxed, toughened and skimmed. It is made into bars of about 500 oz. each. On refining each bar is marked with its number, exact weight and fineness, and with the name of the refinery.

PART X. COMMERCIAL

PART X. COMMERCIAL.

117. LOCATION OF REDUCTION WORKS.

The location of a reduction plant will depend much upon whether it is a mine or a custom works. In the former case it has been usual to place a stamp-mill as near the mine as a suitable site and water supply will permit. In case of a reduction works, where fuel and fluxes are to be brought in and products shipped out, then in addition, location in reference to the railroad must be reckoned on. For custom works, using ores from different mines and localities, a point central to them, and also a railroad center must be considered.

The respective advantages of the side hill (terraced site) and the level site have been much discussed, it having been claimed that the former permits the ore to proceed by gravity from point to point as it is reduced without having again to elevate it. The advantages of the flat site are as follows:

1. The first cost of the works is smaller, since grading and retaining walls are reduced to a minimum.

2. The arrangement is more convenient since one is not compelled to place the different parts of the plant in a certain pre-destined order to obtain the fall required. Also, when one wishes to expand the works, it is possible to do so in any direction.

3. Every square foot of the ground may be at will the equivalent of a lower or upper terrace to every other, and hence parts of the plant, which must be far apart on a terrace site, can be set side by side on a level one. Ventilation is much better and the plant more accessible to supervision.

4. Of course on a level site one must use elevators, but it is seldom that we find a terrace site where elevators are not used. A part of the product of a reduction works has often to be sent back for re-treatment. The cost of elevating may be set at 0.5c

per ton only. Finally we find the iron and steel plants, the largest reduction works in the world, situated on level sites.

Mill-sites.—In the United States title can be secured from the general government for a mill-site for reduction works upon the non-mineral unclaimed public lands to the extent of five acres, either in connection with a mineral claim (on the theory that each lode is entitled to a mill-site) or by an independent reduction company, and it is located much like a mineral claim.

A reduction company must take care of its own tailing and water, must not permit them to flow upon the property of other persons, and is responsible for all such damages. Neither must it flow tailing into a stream when at a small cost it can be impounded, nor can it be run into waters where it is liable to interfere with navigation.

A reduction company may also take up land for a ditch or flume, or unappropriated public land, which cannot be interfered with by later locators; but the owner of such ditches is responsible for damage arising from their breaks or overflow. The same rules hold in respect to trails and roads. In Colorado all claims are subject to the right-of-way of parties hauling ore over them; but elsewhere the location gives exclusive claim except by a water, electric or railroad company under the law of eminent domain, and even then with fair compensation.

The right or custom of dumping across the valueless land of lower mineral claims is general, except that it must not do damage to the owners below.

118. HANDLING OF MATERIALS.

For the horizontal handling of a hundred tons or less of material daily, especially when it is to be distributed to various places, one and two-wheeled wheelbarrows and two-wheeled buggies have been found economical, elastic, and involving but little first cost. For larger quantities the same appliances are used, as well as hand-propelled tram-cars as in mine work. For larger quantities power-propelled cars are used, which permit of being handled on up-grades, such as would be disadvantageous in the case of hand-moved appliances.

The application of machinery to the handling of materials has, of late years, received great attention, and has been rapidly developed, because of the economies in labor brought about by its use.

The methods may be divided into:

(1) Appliances for moving materials continuously, as belt elevators and conveyors.

(2) Appliances for handling materials intermittently, as light railways, ropeways and cranes.

(1) *Continuous-type machines* carry a distributed load, permitting of lighter construction. They also have the advantage that the delivery is continuous, no time being lost in the operations of charging and discharging. Intermittent work, on the contrary, if we increase the load of the skip or bucket, becomes awkward and slow in handling, whereas in a continuous conveyor, it is possible, for example, to quadruple capacity by increasing the width of the conveyor, provided that the feed be correspondingly increased. Continuous machines may be divided into:

(a) Elevators for vertical lifting.

(b) Conveyors for horizontal conveying.

(c) Appliances which perform both duties at the same time.

(a) Elevators.—The well-known belt-elevator is of this type, consisting of an endless leather or rubber belt, having sheet-steel buckets attached to it at intervals of say 18 in. Fig. 160 represents such an elevator. To allow for the stretching of the belt the upper pulley is carried in take-up boxes. The lower pulley is inclosed in a boot, the ore delivering into it on the rising side of the belt at the left. The boot has a hinged drop-bottom for cleaning out. As the ore accumulates in the boot it is scooped up by the buckets, so that, provided the feed is not excessive, it is self-cleaning. Fig. 161 shows a pressed-steel bucket, which is attached to the belt by flat-headed elevator-bolts. The speed must be such as to ensure by centrifugal action the delivery of the ore to the discharge spout as shown by the arrow.

With a belt-speed of 275 to 300 ft. per min. the capacity of an elevator, having a bucket 8 in. wide, will be 7 tons per hour, and, for a 10-in. bucket, 18 tons per hour. The head and boot pulleys are 30 in. diam., and 1 in. wider than the width of the bucket.

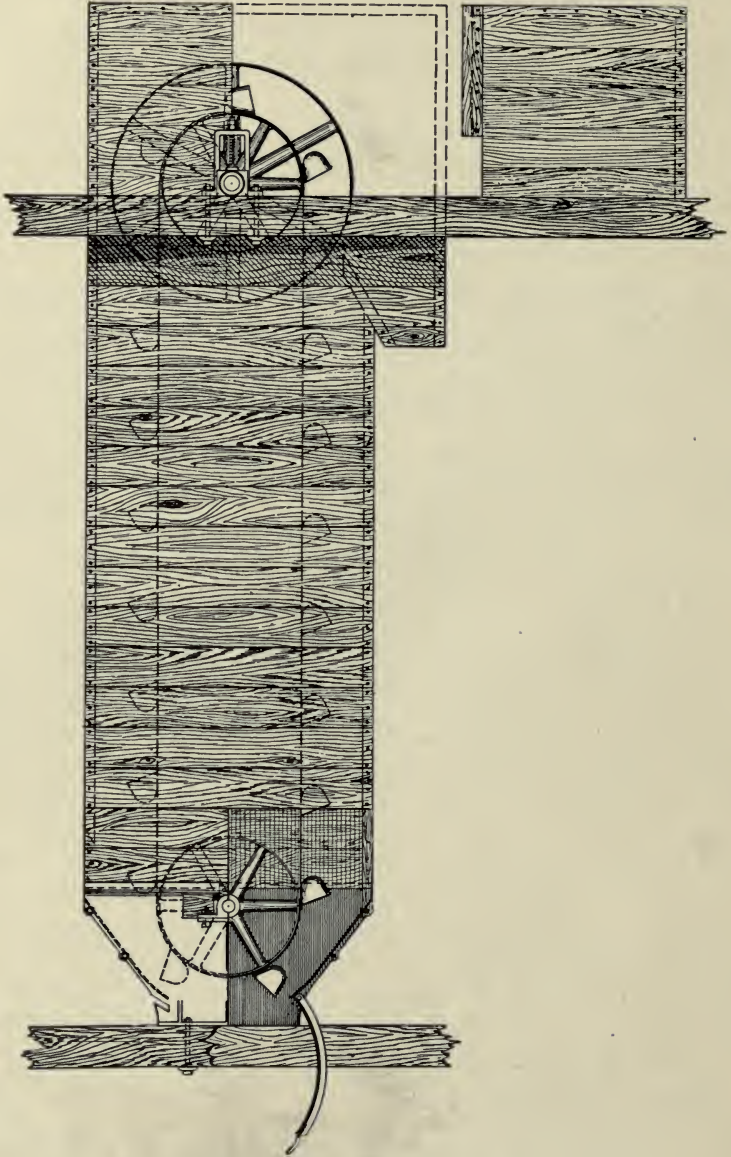

FIG. 160. VERTICAL BELT ELEVATOR.

Fig. 162 is a single strand endless-chain elevator. The head and foot are carried by sprocket wheels with teeth spaced to suit the chain. In this case the take-ups are carried by the boot. Fig. 164 represents either of these elevators encased in wood.



FIG. 161. STEEL ELEVATOR BUCKET.



FIG. 162. SINGLE-STRAND
ENDLESS-CHAIN ELEVATOR.

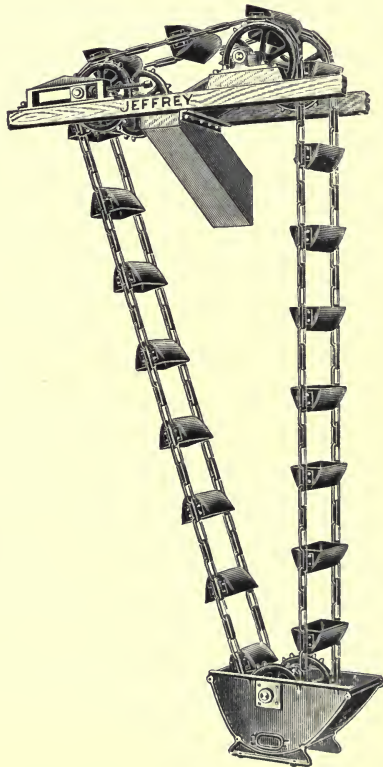

FIG. 164. ENDLESS-CHAIN ELEVATOR.

Conveyors.—The spiral-worm conveyor is convenient for the delivery of crushed ore for short distances; it thoroughly mixes the ore in transit. Its disadvantages are the power required, the grinding action on the ore, and the wear and tear of the apparatus.

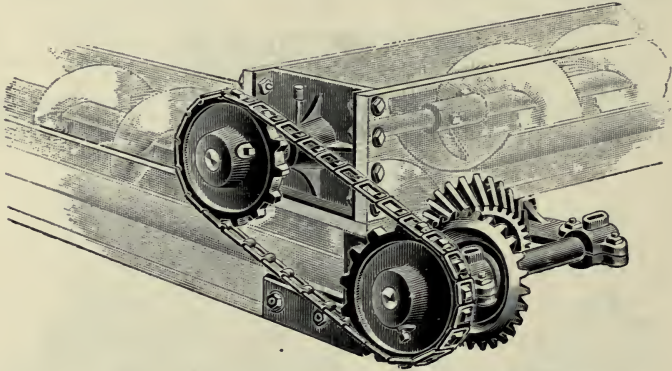

FIG. 165. SCREW CONVEYOR. (QUARTER TURN.)

Fig. 165 represents such a conveyor, delivering ore from one box to another at right angles, the ore dropping from the first box upon the spiral conveyor in the second one.

Fig. 167 shows such a conveyor fitted with a tripper by which the ore is delivered to any desired bin. It will be noticed in regard

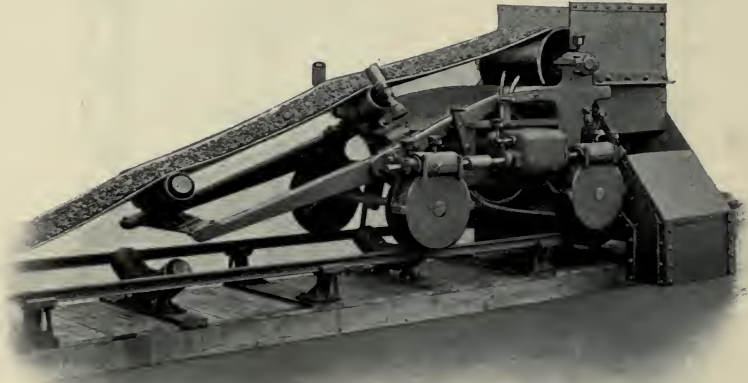

FIG. 167. CONVEYING BELT WITH TRIPPER.

to these conveyors, that they can carry ore not only on a level but at as steep an angle as 24° . Their capacity is large; thus a 12-in. belt, traveling at the rate of 150 to 350 ft. per minute, will deliver from 10 to 35 tons per hour. A 24-in. belt, traveling 600 ft. per minute, would have a maximum capacity of 250 tons per hour on crushed ore, and would take 6 h.p. for a conveyor 100 ft. long. If the ore goes up an incline, the power needed is much greater. These conveyors are simple and durable.

Fig. 168 represents an endless chain 'push' conveyor, a series of 'flights' being attached to the double chain by which the ma-

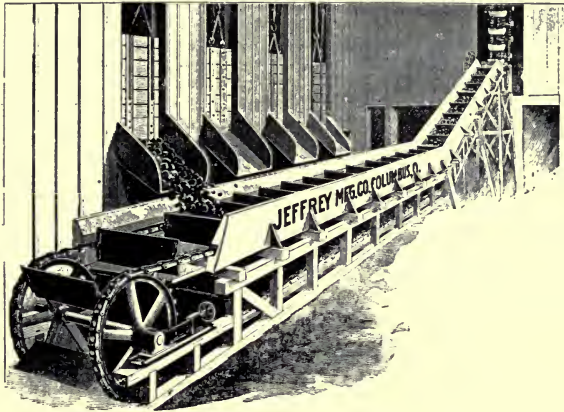

FIG. 168. ENDLESS-CHAIN PUSH CONVEYOR.

terial, drawn from storage bins, is scraped along a fixed sheet-iron lined trough, and even up an incline, where, in this case, it is delivered to an endless chain elevator. The drawback to these conveyors is the wear of the numerous joints and of the trough and flights, and the limited velocity as compared with the belt-conveyor.

Vibrating-trough conveyors. This conveyor, see Fig. 169, consists of a sheet-steel flat-bottomed trough, say 50 ft. long by 2 ft. wide, held up by spring-legs set at an angle and receiving from an eccentric a throw of 1 in. at the rate of 300 rev. per minute.

These conveyors, in series, may be made to carry to a distance of 500 ft. Besides the horizontal they have, owing to the slope of the spring legs, a vertical movement, as given in the diagram (Fig. 170), where E E_1 E_2 and E_3 show the successive position of particles of the ore being conveyed. The full lines show the conveyor at one end of its stroke, the dotted lines the other, the vertical motion being 0.125 in. These conveyors are simple, inexpensive and require but little repairs. A 24-in. conveyor has

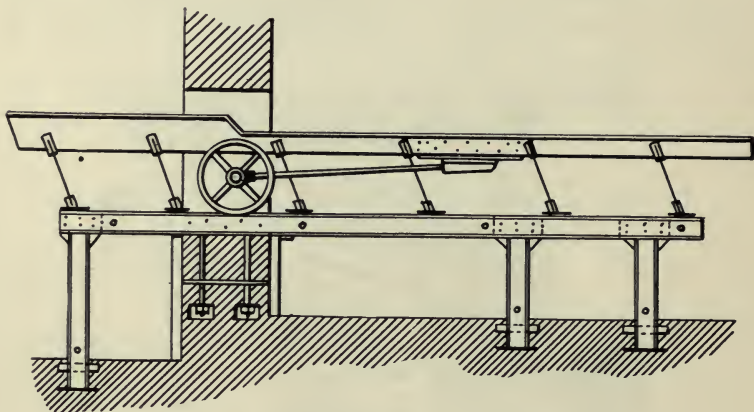

FIG. 169. VIBRATING TROUGH CONVEYOR.

a capacity of 20 to 25 tons per hour. These conveyors are well suited also for screening ore.

(2) *Appliances for handling materials intermittently.*

(a) Hoists. Of these, the most common about reduction works is the vertical platform-elevator which takes buggies, cars or wheelbarrows from floor to floor. It has a platform, large enough to take two wheelbarrows, say, 6 ft. by 6 ft. area. These elevators raise a load of one ton at 60 ft. per minute, and are often run in balance, though it is more certain to have two, each platform being counterweighted. Necessarily, time is lost in loading and unloading, so that one can figure on no more than 15 tons capacity hourly.

We have in Fig. 96 the iron blast-furnace-hoist, showing the method of loading and of dumping. The capacity of the skips is

generally two tons of ore and one of coke, and they are run in balance. It takes 34 seconds actual time for raising, dumping and returning, but the time for each turn, including the waits for loading, is about 4 minutes, making trips enough for a capacity of 350 to 400 tons of pig-iron daily.

(b) Conveying appliances.

Industrial railroads or tram tracks. These are used about large reduction works for delivering materials, not only for points on the same level, but also to move them up-grade, taking advantage either of a side-hill or of trestles in so doing. Steam, electricity and compressed air have all been used, the latter being

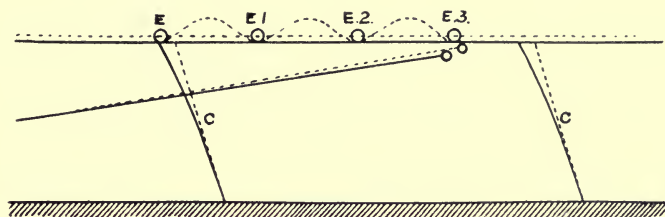

FIG. 170. DIAGRAM SHOWING ACTION OF SWINGING CONVEYOR.

successful because of its simplicity, and because the short runs that are made permit frequent charging.

Fig. 171 shows an electric trolley system with motor for handling a 31 cu. ft. slag-car, as used at the United Verde mine, Jerome, Arizona.

119. ORGANIZATION OF A METALLURGICAL COMPANY.

To perform metallurgical operations on a commercial scale requires generally the organization of a company, or, if a mining company is already organized, the addition of a department which will take care of such additional functions.

In the first case, the promoters or organizers of the company obtain from the State a charter. They then have a formal meeting, at which they adopt a set of laws for the guidance of the company, and elect directors, who are to manage the company. The directors then proceed to the election, from their number, of

corporate officers of the company. These officers are the president, vice-president, secretary and treasurer. The directors also appoint a manager, who has direct active charge of the affairs of the company. Either he, or the directors, then appoint a superintendent who attends to the technical affairs of the plant, while the manager gives his chief attention to commercial or business matters.

The organization of the technical force, at the head of which is the superintendent (sometimes chief engineer), may include; (1) the supply or purchasing department; (2) labor force; (3) accounting.

(1) The *supply department* attends to the purchase, care and issuing of ores, fuel, supplies of all sorts, fluxes and chemicals; also to the disposal of the products of the works.

(2) The *labor force* includes the general foreman, under-foremen, labor for repairs and improvements, force of the laboratory and assay-office.

(3) The *accounting department* attends to the accounting, payroll, cost-keeping and distribution of costs.

Referring to the question of costs, they may be divided into (x) *prime cost* or direct treatment and (y) *general expense* or fixed charges. The prime cost varies almost directly as the tonnage, while general expense is a charge which remains much the same whatever the speed of operation, as for instance, office expenses, taxes, insurance, etc. Costs vary as follows:

The cost of fuel, per ton of ore, diminishes as the output increases.

The percentage of labor to the total cost is at a minimum in years of average activity. It increases in dull and in prosperous years. At a prosperous time, to meet the increased demand, extra men must be hired who do not work to the same advantage as the force just sufficient for effective operation.

Fixed charges or *general expense* includes:

(a). General expense of the works, salaries of technical men in charge.

(b). General expense of operating, management, insurance, office force, customs duties, indemnities and damages, hospital and sickness.

(c). General expense of the company. Dividends and interest on bonds, general administration, general accounts and sales expenses. (This item (c) is often estimated at 10% of the working costs).

In connection with this matter of costs, there are yet two considerations, which have a bearing on the returns on capital invested. These are depreciation of plant, and interest on invested capital. A plant will depreciate in value at the rate of 10 to 15% annually, so that even if kept in repair, by the end of 10 years it

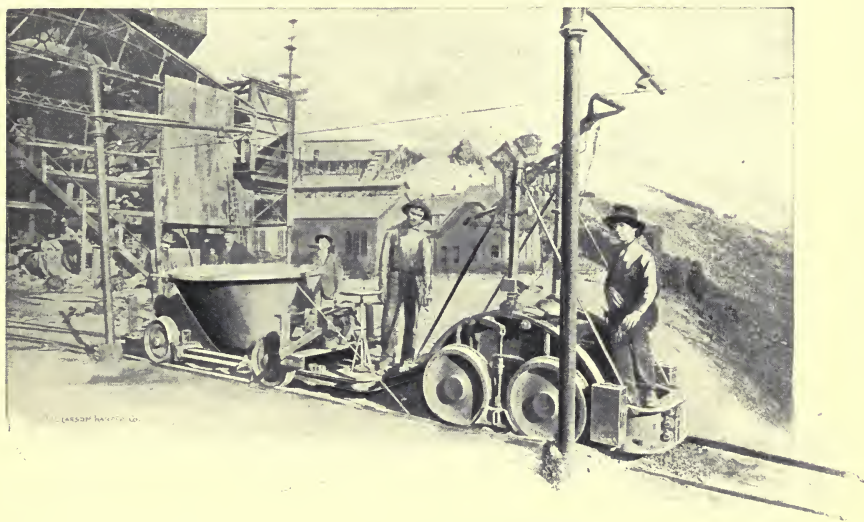

FIG. 171. ELECTRIC TROLLEY SYSTEM.

may be regarded as having no value. If, however, a company sets aside from its earnings an amount sufficient to put in needed improvements and so keep the plant up to date, then depreciation may be neglected. In case this is not done then dividends must be sufficient, not only to pay interest on the capital invested, but also to meet depreciation. Otherwise the investor will never recover his principal.

There are two kinds of metallurgical works, mines and custom.

A mines works gets its supplies from a mine of the same company and treats the ore which is delivered to it. In such a case it does not have to pay outright for the value of the ore, but performs the duty of reducing or winning it ready for market.

On the other hand, a custom works finds the buying of ores the most serious item of expense, especially in the case of precious-metal ores. Its necessary supply depends upon its distance from the mines and also upon the certainty of supply. In the case of the Lake iron-ore supply, for example, a stock must be accumulated by the beginning of winter to keep the furnaces going until the opening of navigation, that is for a period of six months. The smelting works in the Western Rocky Mountain States carry a supply of from two to six weeks. In milling, where a mine is close by, the supply may be replenished as fast as used, so that only enough for one or two days' running is needed.

Besides ore, fuel is an important consideration, both for smelting and for power. Where it is hard to get, water is one of the most important items in milling. Supplies, such as mercury, chemicals, oil, grease, waste, tools, castings and miscellaneous supplies, cut more or less of a figure, as for example, in cyaniding ore, the potassium cyanide may be the largest single item.

120. INVESTMENT REQUIRED ON ORIGINAL PLANT.

1. As a preliminary to undertaking metallurgical operations, an investigation must be made, not only of the process and plant, but of all the limiting conditions. This includes supplies, markets, railroad facilities and statistics, labor and reliable civil conditions, and an estimate of profits which can be expected.

2. Next comes the promoting of the enterprise, or interesting capital to erect and operate the required plant. This work goes on concurrently with the organization of the operating company.

3. Often the promoters acquire the necessary real estate and the rights which go with it. Provision is made for access by the railroads, and the necessary trackage, and for common roads. Not only must water and power be obtained, but also rights of way for them to the property. Quarry rights are to be acquired, and a proper supply of fluxes provided.

4. Then come hydraulic works if needed, and the building of dam, canal, reservoir, water power, transmission line, and the putting in of telegraph, telephone and mail facilities. For a long transmission line there are substations and the distributing system, including engineers for designing and supervision.

5. There must not be forgotten the salaries of officers of the company who are to receive pay during construction, nor that all money must be accounted for and the costs reckoned up by a skilled accountant. We may also include the interest on money expended in the preliminary construction stage, or until the plant is completed and earning money to defray running expenses. When in full operation, any further money needed should come out of the gross profits.

Construction.—In beginning this the costs should be worked out in great detail, good materials must be obtained, and, as above stated, working capital must be enough to keep things going until returns come in. In the design of the plant there should be duplication of parts, so that, in case of break-downs, there is no interruption of operations.

Operating expense.—This may be divided into two:

Fixed charges or general expense, including insurance, taxes, improvement fund, office and miscellaneous charges.

Prime costs, into which comes labor, supplies and repairs. Fixed charges remain much the same, whether the plant is in full operation or not; but prime cost varies according to the tonnage treated.

On the business side of the enterprise come, often the disposal or sale of the products, the accounting and estimating of costs.

121. PROFITS.

Profits arising from the operation of a plant, whether independent (custom), or connected to a mine, may be defined as the difference between the total gross costs and the returns on the metal product sales. These costs may be improved, either by better extraction or recovery from the ore, or by lower costs of treatment, due to methods involving a saving in labor, supplies or fuel.

The profits of customs works are:

1. *Profits on treatment.*—A definite treatment charge is made by the works for the ore. The difference between this charge and the actual gross cost represents the treatment profit. In the early days of smelting in Leadville charges of \$60 per ton were made when the actual cost was \$20. The difference represented the profits per ton. Nowadays \$1 to \$2 per ton, because of competition, must satisfy such custom works.

2. *Profit on extraction.*—A charge is made against the ore by which a guaranteed extraction is made, which is deducted from the gross values in the contained metals. This is supposed to meet the loss incurred in treatment, but as a matter of fact, the extraction may be better than this, and thus a profit is made by the reduction works. For example we have on a number of different lots of ores the following estimate:

Average treatment charges per ton....	\$6.25
Actual cost of treatment.....	4.50

Leaving a profit on treatment of.....	\$1.75

Gain in extraction over the prescribed amount:

Gain in silver per ton.....	\$0.25	
“ gold “	0.10	
“ lead “	0.35	
	_____	0.70

Total gain or profit.....	\$2.45	

In milling, this calculation remains true whatever the character of the ore; in smelting, however, a silicious ore, which would need much flux, would yield less profit, because fluxes would be taking the place of profit-bearing ore. The slag of such ore, being considerable in amount, carries off values according to its weight.

The following figures represent profits yielded by an ore of a company owning its own mine, the Robinson Co., on the Rand, South Africa.

Gold recovered at the stamps.....	\$20.50
“ “ by cyanide	5.70
	<hr/>
	\$26.20
Cost of mining.....	\$6.55
“ of milling	0.98
“ of cyaniding	0.97
Net profits per ton.....	17.90
	<hr/>
	\$26.40

Besides the costs of operation, as above given, we have to consider the following costs, which are often not considered in estimates:

Expressage on gold and silver bars to the mint or to market.

Costs of selling, generally a percentage on the gross amount of the sale.

Interest on bonds, where the company has issued them. This comes out of the profits before stockholders can expect any dividends.

Sinking-fund reserved to repay bonds. This is an annual deduction, which, with interest obtained by investing the accruing amounts, will be enough at maturity to meet the obligation.

General office expense. This has reference to the home office, where there is one, generally in some large city. The object of such an office is that the stockholders may be in touch with the property in which they have invested.

Salaries of officials, such as corporation officers.

Insurance upon the plant, and on the metals in transit.

Taxes, including both general and local taxes.

Royalty, where an amount must be paid out for the use of a patented metallurgical process.

122. ORGANIZATION.

Mines in a given country have value only when the ore has been extracted and reduced. This means the employment of labor. For example: A new camp has been prospected, and

upon promise of a future, works are erected to treat the ores of that camp. A century or more ago the methods of reduction were very simple, needing but little capital, and labor, and with a small output, requiring only the simpler methods of transportation. Upon the skill of the workmen depended the success of the operation.

Now, however, this is profoundly changed. Small furnaces are replaced by large ones, and in place of operations dependent on the skill of the workmen, the metallurgist computes his charge. To manual skill has been added intellectual skill, in order to insure the certain and exact operations of the furnace. Where, at first by hard labor the puddler worked up his charge of iron, today he operates levers while watching operations. In place of muscular effort he must apply intelligent direction.

The superintendent, the assistant or the foreman must not only be informed as to the actual technical operations, but he must also know how to arrange and to organize. And in addition, he must be able to handle men effectively. He must possess tact, discretion and firmness. He must be strict but just, able to encourage as well to drive.

The choice of men, who are to run a plant, is often the important point in the success of an enterprise. In certain cases it has been the custom to put in men who have the "pull" because their relatives or friends are on the directorate. Thus success is dampened at the start. We train men at mining schools in preparation for technical duties. Not that they can assume responsibility without practice, but that, knowing principles and having the mental training, they are fitted to acquire, to advance, and finally to be given responsibility.

The pay of intellectual work, as for the office force, superintendent, assayer, chemist, and foremen, is monthly. In certain cases an annual premium has been paid. However, in those plants where the exhaustion of a mine or a camp may cause the closing of a work, such premiums can hardly be assured. These methods, however, often give good results, especially where this premium depends on tonnage, or, in the case of the superintendent, on the lessening of costs. There is a big difference between the man who will draw his salary anyhow, and one who knows he is to get more

when he exerts himself to get to work promptly in the morning, or who stops some leaks which otherwise he would let go.

The quality, as well as the quantity of work, has to be seriously considered. In zinc plants, for example, success is largely dependent on a high extraction, due to skill in retorting. This extraction may easily drop from 3 to 5% through carelessness, or even by lack of determination to get the best possible quantities out of the ore. In roasting and in puddling, skill in firing means a saving of fuel out of all proportions to the pay of the fireman, a fact which we better know in connection with firing a boiler. Again, about a silver-lead works, good feeding and good furnacing counts, and, more than all, skillfully compounded charges of uniform composition. There is this much about the charging of such a furnace, that, if it is correct, it will not only give the best reduction, but also the smoothest running.

Let us here consider the matter of cleanliness and neatness about the plants, especially where, as in refineries, high-grade materials are treated. Since these materials are treated on a close margin of profit, and since a small percentage loss will turn a profit into a loss, it is all-important to look closely into the matter of preventing small losses. Valuable materials such as drosses, skimmings, spillings from retorts, and from cupel furnaces, flue-dust and sweepings, should be carefully and anxiously gathered up and preserved to go back for recovery or re-treatment. One may find in accumulations of ashes valuable concentrate, containing several hundred dollars per ton, these ashes being accumulated from the retorts of a refinery. About mints and jewelers establishments several hundred dollars at a time have been obtained by sweeps and from the ashes of old carpets, which, after having been for some years upon the floor, have been burned.

In general, the modern practice has been to give more and more attention to dust-losses, especially in connection with blast-furnaces which produce strong air currents. This means, however, large investments in flues and stacks. It is well to remember, that for low-grade materials the same rule would not apply, since sometimes the flue-dust recovered from a low-grade ore will hardly pay the cost of re-treatment plus the interest on the flue-chamber needed.

In certain respects the labor about a metallurgical works differs from that about other industries. The work is carried on by a crew who work together, each man having a part of the operation dependent on him alone, all being directed by a foreman, who sees to the regular operation of the apparatus. Thus, about a silver-lead blast-furnace we have the feeder and assistant, the weigher, the wheelers or trammers who bring in the fuel and charges—all men who work on the feed-floor. Below there is the furnace-man, the tapper, the pot-pushers, each having a particular duty. These are called inside men. They work in shifts of 12 hours, and one crew replaces the other, while, if there is a little delay in the arrival of any man, his partner must await his coming or until he is relieved. These men are by no means paid the same; for example, the furnace-man or the feeder is paid more than the other men, and the wage varies according to the skill and knowledge required of the men.

122. GENERAL REMARKS ON MANAGEMENT AND LABOR.

Engineering is the art of doing with one dollar what any bungler after a fashion can do with two. In other words, a competent man is necessary to the best results, and with a small margin of profits to count on, he is absolutely essential.

The capacity and efficiency of a plant depend on the intelligence and reliability of men in its different departments. You must choose your men with this in view. That is, the lower grade labor is to be used where routine and hard work come in; the higher, where judgment is needed. While lower grade labor is faithful it is stupid and may make blunders. However, if a man has been supervised and trained, then he can be trusted if his nature is trustworthy. So cheap labor, as in supervising machines, may be offset by losses or actual disaster. In employing men it is best to mix the nationalities to avoid the clannishness which may result in the men of the same nation combining against their employers or bosses.

Though the men are generally left to shift for themselves, certain sanitary precautions regarding them are well repaid.

The manager or superintendent at a works should give orders through the foreman, otherwise discipline is injured, and the foreman's well-laid plans may be disarranged. If prompt change is imperative you may make it but you should at once hunt up the foreman and tell him of it.

Beginning with *the manager*, who takes from the company the responsibility of operations, we find that he must be a man especially informed in a business way, and in the business of that branch of metallurgy of which he has charge. He appoints a superintendent, who has direct charge of the technical operations, while the manager gives himself to the care of the business matters.

The superintendent, often also the metallurgist, has direct contact with the furnaces and metallurgical machinery. When matters go wrong it is he who is called on to make them right at no matter what hour of the day or night. Is a furnace in bad condition, or has a machine broken down, he is responsible. When all is going smoothly his duties may be light, but, when troubles occur and the works is losing money, then is the time when he must work hard. If he fails in adjusting matters satisfactorily, no excuses can be accepted; he must succeed or resign. Much of his success depends upon his subordinates, among whom we must first place the foreman.

While the foreman is not expected in lead-silver smelting operations to make changes in the charge, or, in any case, to devise new schemes of operation, his suggestions are apt to be valuable, and upon the basis laid down, he has considerable liberty of action. His skill comes in particularly in the handling of the men, whom he must not only distribute properly to do the work, but must also see that they keep busy and working efficiently.

Qualities of a good foreman. In quizzing an applicant for such a position make a note of his former employers, ask him if he gets on well with his men, if he scolds them, if he has been threatened by them, or on the contrary if he treats them "white," or if he shows them how to work by doing it himself instead of working all of them. A foreman must not be thought a good fellow by his men. On some jobs a good foreman must watch and foresee everything to be sure that nothing is neglected, and, in such

a case, he has less need to be a strict disciplinarian. On other work, and in order to drive, especially when he has many men to handle, he must be stern but just. He cannot hobnob or be familiar with the men, but must have reserve of manner though looking after their welfare. Men work, not to please the foreman, but because they need the money; in general, money talks.

The chemist and assayer is called on principally to give results with promptness and accuracy. Besides his routine work his skill can be shown to advantage in investigation under the direction and advice of the metallurgist.

The office force has to attend to the purchase and issuing of supplies, to the accounting, and to the questions of costs and profits.

The various mechanics — as blacksmith, carpenter, engineer, machinist—have not only the repairs, but also the improvements of the plant to attend to, under the personal direction of the superintendent, who may, where the work requires it, employ a draftsman and engineer to attend to construction. It is a rule that when in an emergency the foreman calls for work to be done in a hurry, then such work has precedence.

Skilled and unskilled labor. The 10-hour labor about reduction works can be performed largely by unskilled men, called outside laborers or roustabouts. They perform work involving the use of pick and shovel, such as unloading cars, handling the products of the works and assisting in construction and repairs.

The skilled labor, in shifts of 8 to 12 hours, called also inside men, receive extra pay according to the skill needed, and the longer hours. They differ, also, in the fact that they are responsible for the successful performance of the duties given them, and they are expected to work until they are relieved by their partners, or until the foreman has provided someone to take their place.

For keeping up discipline, and to prevent slackness in the work, certain rules, the result of experience, have been laid down for the guidance of the men. These are:

Rules of shifts.—The men must be promptly at work, and work full time. Ten hours runs from 7 A. M. to 12 M. and from 1 P. M. to 6 P. M. in summer, while in winter, the noon hour is shortened to thirty minutes.

Inside or twelve-hour men must be on hand all the time and eat their luncheon when they get the chance. They must always be on watch where they are needed. Charge-wheelers must keep up the supply, but otherwise they may rest at intervals, and are not to be called on to do other work than to sweep up before going off shift. The inside man may go off when relieved by his partner and must wait for his partner to come. If the latter does not come the foreman provides another man, who then takes first place, the absent man losing his place unless he has a good excuse for his absence. When such a man is to be unavoidably detained, or is sick, he is to notify the foreman by message, who will supply his place. When the man wishes to return to work he must notify the foreman one shift in advance, so that his substitute is not put out of a job for which he had prepared.

When men get sick on shift, try to hold them to the end of the shift under the idea that it is hard to fill their places at such short notice.

Labor troubles. Men must obey orders, and, if not, must be discharged, irrespective of whom they may be.

Be strict and just. Some employers find it well to occasionally let out a man. If you run on for a while without doing so, begin to be anxious for yourself. Do not trust a man to do work without supervision, since he may do it wrong, or may get careless.

Provision for the care of the men in case of sickness, such as a hospital or medical attendance, is often made. The men pay for hospital dues one dollar per month, and are entitled to the privileges thus paid for. When a man has worked to exceed five days in any given month this one dollar is taken from his pay for hospital fee. While accidents will occur, yet particular care must be given by the foreman to the safety of the men, who are apt to get careless, and must be warned. Any carelessness on the part of the foreman in this regard renders the company liable for damages.

American as compared with Mexican or similar labor.

American labor is characterized by great intelligence, energy and responsibility as compared with Mexican. Mexicans who have been trained to such duties often make excellent inside men.

When well bossed or directed, Mexicans do pretty well, though often, from being insufficiently fed, their physical endurance is low. They need watching, also, to prevent their idling. They must be directed, as they are apt to work to disadvantage on account of their thoughtlessness. It is well to treat them as grown children, and to have patience with them, but, at the same time, judicious strictness is required.

In fixing upon a rate of wages, especially in a new camp, it is well to have the pay low to begin with. It is always easy to raise the wages of the men, but hard to reduce them once they have been fixed. Among Mexicans, whose tastes are simple and whose wants are easily supplied, the tendency of high wages is to give more laying-off time, to the great inconvenience of the works. This is also the trouble of monthly payments by which, when wages have been paid, the men are disposed to take a rest to the great detriment of steady running. To overcome these troubles two methods have been tried. One is of daily payments by which a Mexican, who would naturally spend all his money as fast as he gets it, has thus but little to spend, and who would come round the next day to earn more ready cash. The other system is to pay him a wage, to which is added a premium which increases with the time worked, and is paid at the end of the month if he works the month through, otherwise not. This reward is a bait which holds a man to steady work.

If an employer of Mexican labor finds a man, who excels in his work, let him avoid the danger arising from advancing his wages, which often has the effect of spoiling him. In speaking to and directing a Mexican laborer the familiar style, not the formal or polite one of the books, is to be used. The formal address would be a mistake.

The yellow streak.

Mexican and, in a lesser degree, other labor is liable to show its weakness and lack of common honesty by pilfering. So much so is this the case in Mexico that a tool, or other portable object, can hardly be laid down but that it will be stolen. Men must be held responsible for their tools, and such property kept under lock and

key. It is also well to brand tools. In the spring, when the prospector is about to get out to the hills, he finds it convenient to draw on the company in this way for tools without expense to himself.

In dealing with Mexicans, however, the American metallurgist or engineer cannot afford to practise sharp tricks. Whatever they are themselves, they expect integrity of him. Any other procedure would soon be known to his vital disadvantage. Of course, some Americans have inherited the yellow streak from their ancestors, and their training may have also contributed to the same result. Even they should be wise enough to see that they must put restraint on themselves, and realize the degradation arising from such meanness. The mining engineer is trusted with the control of enterprises, and with the care of the precious metals which he produces. His success depends, not only on good resolutions, but also in keeping them.

Mines have a practical value, only when they have been developed so that it is possible to know what the future has to offer in erecting reduction works. Where the value of the ore justifies it, the beginnings of metallurgical operations should be simple, depending upon the skill of the workman and not upon a complicated plant. As, however, knowledge has been obtained, the erection of an efficient plant should be undertaken.

It is not sufficient that the superintendent shall simply know how technical work should be done; he must also be able to organize his force and to handle it efficiently. To do this he must have tact as well as knowledge. The right men make the success of the enterprise. For all this, influence or pull often decides who is to control, and may result in the choice of an incompetent, untrained, or inexperienced man, thus inviting disaster.

The tendency at modern mills and metallurgical works is to reduce the labor per ton needed by means of mechanical conveniences, so that the labor of the individual becomes less strenuous, less trying on his strength and endurance, and yet he is better paid. As a result he is better able and more anxious to retain his job, and his services are more to be relied on than is the case with cheaper labor.

1. With respect to the labor needed, a large mill is run with proportionately less labor than a small one.
2. An easily treated ore needs proportionately less labor, since there are fewer operations and the care needed is less.
3. Eight-hour shifts need one-half more men than 12-hour shifts.
4. Again, steam power needs more labor than water power where often it is but the question of an occasional adjustment of a valve.
5. Labor-saving machinery, provided it is reliable, makes a difference in costs, but it must not be forgotten that the saving of labor must not be at the expense of efficiency, and, also the question of "how much" often comes in, so that in certain cases it is not worth while to put in the labor-saving appliance.
6. Cost and quality of labor. Cheap labor is needed in larger quantity, and Mexican labor needs much supervision by gang bosses. Cheapness of living also effects labor.

Men at an amalgamating silver mill (100 stamps).

Foreman	Head amalgamator
Millwright	Four amalgamators
Pipe fitter	Two crusher men
Two engineers	Two oilers
Two firemen	Two feeders
Night foreman	Two laborers

In starting a new metallurgical works a list of men and their places or occupations should be arranged, and as men are engaged they are assigned on the list. On the day of starting, others apply who must be assigned rather hastily. All these men must be questioned as to their qualifications, and given places they can fill. About the time a new works is to be started, men skilled in the operation of the plant are often willing to accept common labor while waiting for the start.

The men needed and the cost of labor for a single blast-furnace lead-smelting plant per shift of 12 hours is:

Inside men :

1 feeder	\$2.50
1 feeder's helper	1.80
3 charge-wheelers @ \$1.80.....	5.40
1 weigher	2.40
1 furnace-man	2.50
1 tapper	1.80
2 pot pushers @ \$1.80	3.60
1 engineer	3.50
1 foreman	4.25

$\$27.75 \times 2 = \55.50

This is based upon common labor being \$1.50 per day of 10 hours. When labor is more expensive these prices increase proportionately.

Ten-hour men :

1 dump man	\$1.50
4 sampling mill men @ \$1.50.....	6.00
1 sampling foreman	2.50
1 carpenter	3.00
1 blacksmith	3.50

\$16.50

Total cost for labor.....\$72.00

This is a minimum of labor, since improvements and emergency work calls for other labor. It is well to have such extra men, who can be called on to supply places caused by sickness, etc.

In gold stamp-milling the duties of the mill men in a large mill are :

Foreman.—He has general supervision of the mill and looks after the handling and cleaning of all the amalgam collected.

Amalgamators.—They dress the chuck-blocks and plates and keep them in good condition. They set tappets, regulate water-supply and make all renewals.

Feeders.—Attend to the uniform feeding of the batteries and assist the amalgamators in renewals and on the clean-up. A good feeder is a valuable man about the mill.

Vanner-men.—They attend to the vanners or tables. They must be men with a good deal of experience. In fact they must first serve as helpers about the tables as sulphide-pullers.

Crusher-men operate the crushers for the coarse ore entering the mill.

Oilers oil all the machinery.

Sulphide-pullers remove the concentrate or sulphides from the vanner boxes, and store them ready for shipment.

Engineers run the power plant and have charge of

Firemen, who fire the boilers and remove ashes.

Coal-passers, who bring in coal to the boilers.

On repairs there are carpenters, and laborers who assist them on the vanners. This repair force gets the help of a special vanner-man.

At the Treadwell 240 stamp-mill at Douglas Island, Alaska, the following men are needed each 24 hours.

1 foreman (12 hours), \$150 per month.....	\$ 5.00
4 amalgamators (12 hours), \$90 per month....	12.00
8 feeders (12 hours), \$70 per month.....	18.64
4 vanner-men (12 hours), \$65 per month.....	8.68
2 oilers (12 hours), \$65 per month.....	4.34
2 sulphide-pullers (10 hours), \$2 per day.....	4.00
2 sulphide-shovelers (10 hours), \$2 per day....	4.00
2 engineers (12 hours), \$2.50 per day.....	5.00
2 firemen (12 hours), \$2.50 per day.....	5.00
2 coal-passers (10 hours), \$2 per day.....	4.00
4 crusher-men (10 hours), \$2.25 per day.....	9.00

Making a daily cost for operating labor of.....\$79.66

Repairs.—

1 carpenter (10 hours), \$4 per day.....	\$4.00
1 vanner-man (12 hours), \$100 per month....	3.33
1 laborer (10 hours), \$2 per day.....	2.00

Total labor cost for repairs \$9.33

To these costs must be added that for board and lodging furnished by the company.

In a 40-stamp silver amalgamation mill, having 24 pans, and with a capacity of 150 tons daily, the labor in 24 hours would be:

4 pan-men (12 hours) @ \$4.....	\$16
2 helpers (12 hours) @ \$3.....	6
10 tankmen (12 hours) @ \$3.....	30

Making an inside labor-cost of\$52

These prices prevail in California and in other higher-priced camps in the Rocky Mountain region.

124. THE PURCHASING OF ORES IN THE ROCKY MOUNTAIN STATES.

Smelting works purchase ores of every kind according to their requirements, provided the ores have value enough in them to pay for smelting. They are purchased according to their constitution and upon a pre-arranged schedule, an example of which is here given.

Schedule

For Dry Ores, Concentrate and Tailing, Lead Ores and Lead Concentrate, Clear Creek and Gilpin Counties, Colorado.

February 1, 1905.

All Rates F. O. B. Cars Denver.

Dry Tailing and Concentrate.

Gold, \$19 per oz., if 0.05 oz. or over per ton.

Silver, 95% of N. Y. quotation day of assay, if 1 oz. or over per ton.

Copper, dry assay (wet less 1.5 units).

5% or less	\$1.25 per unit
Over 5 and incl. 10%	1.50 " "
Over 10%	1.75 " "

10% silica basis, 10c up.

5% zinc basis, 30c up.

When gross value is:

Not over \$35 per ton	\$3.50 treatment
Over \$35 and incl. \$80 per ton.....	4.00 "
Over \$80 per ton.....	5.00 "
Upon lots of less than seven (7) tons.....	5.00 "

Dry Silicious and Copper Ores.

Gold, \$19 per oz., if 0.05 or over per ton.

Silver, 95% of N. Y. quotations, day of assay.

Copper, as in schedule of concentrates.

\$8 treatment charges.

40% silica basis, 5c. down, and 10c. up to a maximum charge of \$11 on ores not exceeding \$25 gross value; and \$12.50 on ore exceeding \$25 gross value.

5% zinc limit, 30c. up.

Oxidized Irony Ores.

Gold, \$19 per oz., if 0.04 oz. or over per ton.

Silver, 95% of N. Y. quotation, date of assay.

Lead, 25c per unit for 5% or over.

\$2 treatment charges.

Neutral basis, 10c. a unit up.

Gold, \$19.50 per oz., if 0.05 oz. or over per ton.

Silver, 95% of N. Y. quotation, date of assay.

Lead, prices flat.

Copper, \$1 per unit dry (1.5% off wet) when ore assays 2% wet.

Zinc, limit 10%, 50c. up.

Neutral Schedule.

	5 to 10% Pb. incl.,	25c. per unit, \$8.00 w. c.	
Over 10	" 15 "	25 " "	7.00 "
" 15	" 20 "	25 " "	5.00 "
" 20	" 25 "	25 " "	4.00 "
" 25	" 30 "	30 " "	4.00 "
" 30	" 35 "	30 " "	3.00 "
" 35	" 40 "	30 " "	2.50 "
" 40	" 45 "	32 " "	2.00 "
" 45	" 50 "	35 " "	2.00 "
" 50	" "	40 " "	2.00 "

Neutral basis, 10c. up or down.

Flat Schedule.

	5 to 10%	Pb. incl.,	25c. per unit, \$12.00 w. c.
Over	10	15	25 " " 10.50 "
"	15	20	25 " " 8.50 "
"	20	25	25 " " 6.50 "
"	25	30	30 " " 6.00 "
"	30	35	30 " " 4.50 "
"	35	40	30 " " 3.00 "
"	40	45	32 " " 2.00 "
"	45	50	35 " " 2.00 "
"	50	"	40 " " 2.00 "

Neutral Schedule to be used when it figures better for the shipper.

Lead Concentrate.

Gold, \$19 per oz. if 0.05 oz. or over per ton.

Silver and *Copper* as in lead ores.

Lead, prices flat.

Silica, limit 10%, 10c up.

Zinc, limit 5%, 30c. up.

	5 to 10%	Pb. incl.,	25c. per unit, \$4.75 w. c.
Over	10	15	24 " " 4.00 "
"	15	20	30 " " 3.50 "
"	20	25	32 " " 3.25 "
"	25	30	35 " " 3.25 "

Upon Concentrate assaying over 30% lead, apply "Neutral Schedule" or "Flat Schedule," whichever figures the better for the shipper. \$19 for gold.

Schedule

For Ore and Concentrate, Boulder County and Cripple Creek, Colorado.

February, 1905.

All Rates F. O. B. Cars, Denver.

Gold, \$19 per oz., 0.05 to 2 oz. incl. per ton.

" 19.50 per oz., if over 2 oz. per ton.

<i>Silver</i> , 90% of N. Y. quotations, if ore assays from 1 to 10 oz. per ton.	
“ 95% of N. Y. quotation, if ore assays over 10 oz. per ton.	
Up to \$10 gross value	\$4.00 treatment
Over 10 to 20 gross value	5.00 “
“ 20 “ 30 “	5.50 “
“ 30 “ 40 “	6.00 “
“ 40 “ 50 “	6.50 “
“ 50 “ 75 “	7.00 “
“ 75 “ 100 “	8.00 “
“ 100 “	9.00 “

When ore does not exceed \$10 gross value, 3% sulphur limit, 25c. up to a maximum charge of \$2.50 per ton, zinc limit 5%, then 30c. up.

When ore is over \$10 gross values, no sulphur limit, zinc limit 5%, 30c. up.

Lead Ores.

Apply Schedule for lead ores for Clear Creek and Gilpin Counties.

Concentrates, Lead or Dry.

Apply corresponding Schedule for Clear Creek and Gilpin Counties.

As an example of the use of the above table let us take an ore containing 14% SiO_2 ; 6% Fe; 11% Zn; 4% Mn; 10% S; 21% Pb; 60 oz. Ag and 0.2 oz. Au per ton. The ore is evidently a lead ore and we will figure the cost per ton on both the neutral and on the flat schedules.

The silica excess will be 14SiO_2 less $(6\text{Fe} + 4\text{Mn}) = 4\%$ SiO_2 excess.

The zinc being 11%, its excess of 1% over the limit, makes a penalty of 50c to be added to the cost of treatment.

On the neutral schedule

Gold 0.2 oz. @ \$19.50	\$ 3.90
Silver 60 oz. @ 95% of, say, 62c (N. Y. quotation)	35.34
Lead 21% (or units) @ 25c.....	5.25

Gross metal values\$44.49

Deducting treatment, \$4 + (4SiO ₂ excess by 10c)	
+ 50c zinc penalty	4.90
	<hr/>
Net returns to the shipper f. o. b. Denver.....	\$39.59
On the flat schedule	
Gold 0.2 oz. @ \$19.50	\$ 3.90
Silver 60 oz. @ 95% of 62c.....	35.34
Lead 21% @ 25c.....	5.25
	<hr/>
Gross metal values	\$44.49
Deducting treatment \$6.50+50c zinc penalty.....	7.00
	<hr/>
Net returns to the shipper f. o. b. Denver.....	\$37.49

Therefore, the neutral basis figures better for the shipper, and is the one used. Had both silica and lead been somewhat more, the flat schedule would have proved more profitable for the shipper.

125. THE MARKETING OF ORES AND METALS.

The metallurgist must pay particular attention to the kind of ton used in weighing ores and the common metals, and not take the value for granted without a clear understanding of conditions. The short ton of 2,000 lb. is used in the Western States for ores and metals. In the Eastern States the long ton of 2,240 lb. is used for coal, iron ore and pig iron. In England, copper, spelter and tin are weighed by this ton. We may also note that the metric ton of 1,000 kilos or 2,204 lb. approaches the long ton in weight.

New York is a chief market for metals, and the sales of ores and metals are based upon these prices. The quotations of other markets as San Francisco and London are also often given. Referring to a technical periodical, as for example the *Mining and Scientific Press* of San Francisco or the *Engineering and Mining Journal* of New York, we find the following:

Silver. At New York the quotations are per troy ounce of fine silver, 1000 fine. It takes 14.58 ounces troy to make a pound avoirdupois. London prices are for sterling silver 925 fine.

The exchange value of English or sterling money is also given. Thus it is possible to reckon the foreign price of metals in dollars and cents.

Copper. At New York the value of this metal is expressed in cents per pound, quotations being given for Lake copper in cakes for rolling into sheets, ingots for re-melting to make castings and brass, and wire bars for drawing into wire. Cathodes or cathode plates are of copper in rough sheets, the product of electrolytic refining. When these cathodes have been re-melted and cast into cakes, ingots or wire bars, the metal is called electrolytic. It sells at about $\frac{1}{8}$ cent per pound less than Lake copper. Cathodes cost $\frac{1}{4}$ cent per pound less than electrolytic copper because it nominally costs that much to re-melt them. Casting-copper is a lower grade, not so pure, but well suited for making brass castings.

At London, copper is sold by the long ton in English money, and is of various grades, which, with a sample set of prices, is as follows:

English tough copper	£70. 10s @	£71. 0s
Best selected	£71. 15s @	£72. 5s
G. m. b's (Good merchantable bars) or stand-		
ard	£66 15s spot	
		£66 17s 6d., 3 mos

This latter quotation has reference to whether the copper is for immediate delivery or whether the customer will be ready to take it at the expiration of three months, by which time the reduction works may have produced it.

Strong sheets (rolled copper).....	£79 10s
India sheets (for sheeting vessels).....	£75 10s
Yellow metal (a grade of brass).....	6 $\frac{1}{2}$ d per lb.

It is the business of dealers, and others interested in copper, to keep statistics of the copper on hand, which is called the visible supply. When there is but little copper on hand the price naturally goes up and vice versa.

Tin.—Like copper, tin may be quoted for immediate or for future delivery at a specified time. A sample of a quotation would be $30\frac{3}{4}$ c for spot, $29\frac{3}{4}$ @ 30 c for futures. The prices are

the same whether the metal is from the Burmah near the Straits of Malacca (Straits tin) from Bolivia, from Australia, or from other countries.

Zinc is called commercially spelter. Quotations in the United States are given in cents per pound thus:

New York 5.80 @ 5.85c.

St. Louis 5.65 @ 5.70c.

St. Louis is close to the zinc-producing district of Kansas and Missouri, and hence, the lower price for spelter as compared with New York. In the London market, spelter is quoted by the long ton. Thus we have a sample quotation £24 for good ordinaries (ordinary grades), and £24 5s for special brands or makes. Prices for the ore are often given in tons of 2000 lb. at Joplin, Mo. They make a basis price for zinc ore assaying 60% zinc and vary this according to the zinc contents. It used to be the custom to figure the price of basis ore per ton in dollars by multiplying the price of the zinc per pound by 7.5 but this proportion is only an approximation, buyers often advancing their prices to secure ore when it is scarce.

Mercury or quicksilver.—A sample quotation may be given thus: Quicksilver is easy at \$38 @ \$35.50 per flask in large lots, and \$40 on smaller orders. The London price is £7. 12s. 6d. at second hand, that is, sold by jobbers and not by the reduction works. A flask used to weigh $86\frac{1}{4}$ lb. but this has been changed so that a flask must contain 75 lb. of mercury.

Precious metals.—Gold is sold to the mints at a steady price of \$20.67 per troy ounce. This price is, however, subject to a deduction of about 2c per ounce for melting and assaying. Platinum though a commercial metal is of about the same value as gold say \$20.50 per ounce. Silver has already been mentioned.

MINING AND SCIENTIFIC PRESS

ESTABLISHED MAY 24, 1860.

T. A. RICKARD, *Editor*

EDGAR RICKARD, *Bus. Mgr.*

The Mining and Scientific Press offers every Saturday
THE LATEST ACCURATE MINING NEWS, written
by paid correspondents in every mining centre of the
world.

VALUABLE AND TIMELY DISCUSSIONS on
problems daily facing the man in charge of the mine,
mill, and smelter.

ORIGINAL ARTICLES on the most recent practice
by leading members of the mining profession.

\$3 per annum.

Add \$1 for postage to Canada.

Add \$2 for foreign postage.

667 Howard Street, San Francisco

New York : 42 Broadway

Chicago : 934 Monadnock Block

Denver : 420 McPhee Building

London : Leathwait & Simmons

5 Birchin Lane

