

# The Open Court

A MONTHLY MAGAZINE

Devoted to the Science of Religion, the Religion of Science, and the  
Extension of the Religious Parliament Idea

Editor: DR. PAUL CARUS

Associates: { E. C. HEGELER.  
MARY CARUS.

VOL. XIX. (NO. 1)

JANUARY, 1905.

NO. 584

## CONTENTS:

	PAGE
<i>Frontispiece. The Temptation.</i> EDUARD BIEDERMANN.	
<i>Excavations and the Bible.</i> CHAUNCEY J. HAWKINS.....	1
<i>In the Magic Circle.</i> (Illustrated.) HENRY RIDGELY EVANS.....	8
<i>Image Worship.</i> EDITOR. ....	21
<i>Parsifal.</i> THE REV. ADOLF ROEDER.....	26
<i>The Queen of Sheba According to the Tradition of Axum.</i> EDITOR.....	31
<i>The Fall of the Temple.</i> CHARLES KASSEL.....	35
<i>Finland.</i> .....	41
<i>Book Notices</i> .....	44
<i>The Temptation of Buddha.</i> .....	46
<i>The Buddha's Hymn of Victory.</i> .....	46
<i>Karma, Another Buddhist Song.</i> .....	49
<i>Two Buddhist Songs.</i> .....	49
<i>Our Frontispiece.</i> .....	50
<i>The Spread of Civilisation.</i> .....	53
<i>The Behaist Movement.</i> .....	54
<i>Book Reviews.</i> .....	63

CHICAGO

The Open Court Publishing Company

LONDON: Kegan Paul, Trench, Trübner & Co., Ltd.

Per copy, 10 cents (sixpence). Yearly, \$1.00 (in the U. P. U., 5s. 6d.).



# The Open Court

A MONTHLY MAGAZINE

Devoted to the Science of Religion, the Religion of Science, and the  
Extension of the Religious Parliament Idea

Editor: DR. PAUL CARUS

Associates: { E. C. HEGELER.  
MARY CARUS.

VOL. XIX. (NO. 1)

JANUARY, 1905.

NO. 584

## CONTENTS:

	PAGE
<i>Frontispiece. The Temptation.</i> EDUARD BIEDERMANN.	
<i>Excavations and the Bible.</i> CHAUNCEY J. HAWKINS.....	1
<i>In the Magic Circle.</i> (Illustrated.) HENRY RIDGELY EVANS.....	8
<i>Image Worship.</i> EDITOR. ....	21
<i>Parsifal.</i> THE REV. ADOLF ROEDER.....	26
<i>The Queen of Sheba According to the Tradition of Axum.</i> EDITOR.....	31
<i>The Fall of the Temple.</i> CHARLES KASSEL.....	35
<i>Finland.</i> .....	41
<i>Book Notices</i> .....	44
<i>The Temptation of Buddha.</i> .....	46
<i>The Buddha's Hymn of Victory.</i> .....	46
<i>Karma, Another Buddhist Song.</i> .....	49
<i>Two Buddhist Songs.</i> .....	49
<i>Our Frontispiece.</i> .....	50
<i>The Spread of Civilisation.</i> .....	53
<i>The Behaist Movement.</i> .....	54
<i>Book Reviews.</i> .....	63

CHICAGO

The Open Court Publishing Company

LONDON: Kegan Paul, Trench, Trübner & Co., Ltd.

Per copy, 10 cents (sixpence). Yearly, \$1.00 (in the U. P. U., 5s. 6d.).

# The Mysteries of Mithra

JUST PUBLISHED.

*History of Their Origin, Their Dissemination and Influence in the Roman Empire, Their Doctrines and Liturgy, Their Struggle with Christianity, Mithraic Art, etc.* By FRANZ CUMONT, Professor in the University of Ghent, Belgium. Translated by THOMAS J. McCORMACK. With 50 illustrations and a map of the Roman Empire. Pp., circa 250. Price, \$1.50 net (6s. 6d.). This work is a sketch of one of the most important but historically most neglected religious movements of the Roman Empire. Mithraism was the rival of Christianity, and greatly resembled the latter religion. The story of the struggle between the two creeds, here told in its entirety for the first time, is unmatched in its thrilling interest.

Professor Cumont went to great expense and trouble in the preparation of the researches of which this work is a summary. It represents years of labor and travel and throws an entirely new light on the interesting life of the Roman world in the first centuries of the Christian era.

*The Open Court Publishing Company, Chicago*

*1322 Wabash Ave.*

*LONDON: Kegan Paul, Trench, Trübner & Co.*

\$2.50  
PER YEAR

# BUDDHISM

75 CENTS  
PER COPY

AN ILLUSTRATED QUARTERLY REVIEW

EDITED BY

BHIKKHU ANANDA METTEYA

The first number, which appeared in September, 1903, contains contributions from such world-famous Buddhist scholars and sympathisers as Sir Edwin Arnold, Dr. Giuseppe de Lorenzo, Prof. Rhys Davids, and Dr. Karl E. Neumann, together with articles by noted native Oriental savants.

Address inquiries to ALBERT J. EDMUNDS, honorary member, 3231 Sansome Street, Philadelphia Pa. For subscriptions, address the society at Rangoon, as given below.

*Buddhism* is the official organ of

THE INTERNATIONAL BUDDHIST SOCIETY

HEADQUARTERS, 1 PAGODA ROAD, RANGOON, BURMA





COPYRIGHT, 1905, BY THE OPEN COURT PUBLISHING CO.

## THE TEMPTATION.

BY EDUARD BIEDERMANN.

*Frontispiece to The Open Court.*

# THE OPEN COURT

A MONTHLY MAGAZINE

**Devoted to the Science of Religion, the Religion of Science, and  
the Extension of the Religious Parliament Idea.**

---

VOL. XIX. (NO. 1.)

JANUARY, 1905.

NO. 584

---

Copyright by The Open Court Publishing Company, 1904.

---

## EXCAVATIONS AND THE BIBLE.

BY CHAUNCEY J. HAWKINS.

IN recent years great interest has been taken in the excavations in the Orient. The University of Pennsylvania has within the last ten years spent \$100,000 in excavations at Nippur, and only this year the University of Chicago has sent out other parties with pick and shovel. Before America was interested, England, France and Germany had spent vast sums on the ruins of Nineveh, Babylon and Egypt. For centuries nothing has remained of the once glorious Babylon and Nineveh but "formless heaps and conical mounds. Peasants have drawn their plows through their ruins, the Bedouins have pastured their flocks upon their grass-covered slopes, and the wild Arab tribes have fought their unrecorded battles over long buried temples. But patient toil has uncovered these ruins and discovered galleries of art and volumes of history, song and legend which have opened to us anew the story of these once glorious civilisations.

These monuments have clearly revealed the fact that Israel was not an isolated nation as we have so long supposed. Her institutions, her laws, her literature, while all passing through the mould of the Hebrew mind, were directly or indirectly influenced by the nations which surrounded her. Because the libraries of Babylon were buried under the ruins of centuries and the Old Testament was our only record, it was natural for us to think of Israel as receiving all of her rich heritage direct from heaven, but since the finding of these old libraries it has become clear that the Old Testament is the product of an historical evolution. True that it is Hebrew, but the old civilisation of Babylon is its background, and many

things which we once thought of as coming to Israel in a moment are now seen to be the product of a long growth.

This fact becomes clear by a comparative study of Hebrew and Babylonian literatures. We cannot fail to see the influence of those old nations upon Israel in such comparisons as these. When we read in the Babylonian literature that before Esarhaddon set out on his journey he received this prophetic message: "I, Istar of Arbela, will cause to rise upon thy right hand smoke, and upon thy left fire," we must think of the pillar of cloud by day and the pillar of fire by night which followed the people of Israel through the desert. And when we read from the Babylonian legend that Eabani was created out of mud and became a living being only through the breath of God we are strongly reminded of Genesis, which tells us that "God created man out of the dust of the earth and breathed into his nostrils the breath of life and man became a living soul."

Naram-Sin, the son of Sargon, is the oldest of known monarchs. We have preserved this legend, which is recorded above a tablet over his own name, which bears a striking resemblance to the early life of Moses. This is a portion of it: "My mother, of noble race, conceived me and bore me in secret. She put me in a basket of reeds and closed up the opening with pitch. She cast me upon the river. The river carried me along to Akki, the water-carrier. Akki, in the kindness of his heart, made me gardner. Thus Istar showed me favor and made me ruler over the black-haired race." I need not call attention to the strong resemblance to the story about the early life of Moses.

One of the best comparisons is found in the account of the flood which each nation gives. In 1872 George Smith translated the Chaldean account of the deluge. After a careful study of the deluge tablet, this scholar reached the conclusion that the date of its composition could not be placed later than the seventeenth century B. C. and it might belong to a time much earlier. This is at least a thousand years before the writing of the Hebrew account which has been handed down to us. The greatest difference between this and the Biblical narrative is in the religious sentiment. While in the Jewish account only one God is mentioned, in the cuneiform inscription all the gods of the Babylonian pantheon are engaged in bringing about the flood. One points toward monotheism; the other towards polytheism. (This is only an argument in favor of the modern view of the Bible, which holds that the Hexateuch reflects not the religious conception of the pre-Mosaic times, but of the time in which it was compiled—the tenth to the eighth century B. C. The Babylonian



account reflects the polytheism of early Babylon, while the Hebrew account reflects the purer religious ideas of a later period.)

Other minor differences occur which show that the myth has passed through the molds of distinct and independent nations. But the main events of the flood narrated in the Bible and the Inscriptions are the same. The flood, a divine punishment for the sins of men, the building of an ark, the coming of the waters which covered the earth, the taking into the ark representatives of all animals, the sending out of the dove, the falling of the water and the new beginning of life on earth, these are common to both. This seems to indicate that this Biblical story is but one of the legends found in the folk-lore and early literature of the Babylonians; that it has its origin in the plains of Chaldea.

The early date of this tablet makes it certain that the Hebrew derived the story from the Babylonians, and not vice versa. Smith placed the date of the tablet in the seventeenth century B. C., and many regard its earliest possible date to be 3000 B. C. This makes it certain that it was borrowed by the Hebrews from the Babylonians. This position is strengthened by another tablet which shows that the Babylonian language had been naturalised in Palestine before the Exodus, that it was the court language between the Babylonian and Canaanitish tribes. This being true, we can easily conceive how these traditions could be carried to Palestine and gradually become the property of the Jews.

Had we space to compare the traditions of the two nations about creation, the fall of man, and many others, it would only strengthen our belief that the roots of the Old Testament go far back into the thought and life of earlier people.

The question has been raised and must be answered: How much in these early stories is history and how much is legend? What is the historical value of these early portions of the Bible?

First, we must answer that they were not written with a historical or scientific, but a religious purpose. The lack of any clear information in regard to the progress of events, as seen, for instance, in the faulty chronology of the Book of Kings, shows clearly that these Old Testament writers had no great interest in history as such. They were not advocates of a system of science. They used what knowledge of history they possessed, they used the only scientific conceptions then known, for the purpose of teaching religion. They told the story of the creation of the world and mankind, not with a scientific but a religious purpose. In the words of Ryle, "the old-world myths and tales of Semitic folk-lore, were em-

ployed for setting forth in their true light the unchanging verities respecting the nature of God, of man, and of the created universe." They exercised no care in the mingling of history and legend, because it was not legend or history in which they were interested, but religion. For this reason in these earlier narratives it is impossible for us to tell where legend stops and history begins. Only this we know, that here is that intermingling of legend and history where legend is the golden link which connects the unknown time with the first events of actual history. The evidence at hand seems to justify the conclusion that the general outline of the narrative is historical, but we are not able with our present state of knowledge to separate the historical nucleus from the idealized picture.

The excavations do more than to throw light upon the origin of this legendary literature. They have thrown light upon the question of the origin of the so-called Mosaic legislation. It has been the contention of some scholars that there was nothing original about the laws of the Hexateuch but all of them were borrowed from the literature of older nations. That position is not held by many scholars and is not supported by the evidence of the monuments. But that the early laws of Babylon and Egypt and surrounding people exerted much influence over this legislation seems quite probable. For illustration, turn to that ancient funeral ritual of Egypt, the *Book of the Dead*, the earliest piece of Egyptian literature we possess, with possibly one exception. In it we find no account of the soul making its voyage in the spirit world. It came into the judgment hall of Osiris, in the presence of a council of forty-two gods and was compelled to make a declaration of its innocence. Among other things it said: "I have not told falsehoods. I have not made the laboring man do more than his daily task. I have not murdered. I have not slandered anyone." These are positive statements of a soul on trial, telling what it has not done. The declaration implies that there must have existed principles which should read: "Thou shalt not lie. Thou shalt not kill. Thou shalt not bear false witness against thy neighbor. Thou shalt not covet." In other words, these are some of the great laws of the Decalogue. They were so well known in Egypt when Moses was a youth, receiving his education in the school of the Pharaohs, as the Ten Commandments are today, and we can well suppose that Moses, when he started with the Children of Israel on that long journey, was well acquainted with them and they must have exerted a great influence over his legislation for Israel. If Moses was not the author of the Decalogue

it would not affect the force of the argument. The Hebrews were in Egypt and must have been acquainted with this funeral ritual.

One of the most important discoveries of recent times is the code of Hammurabi. It was found by the French expedition which during the years 1897-99 excavated the great ruin of ancient Susa. It is a code of 280 laws inscribed upon a large stone monument and is of great value not only because of the material which it contains, but also because it can be definitely dated at about 2250 B. C. A comparison of this code with the Old Testament laws will reveal the much higher standard reflected in the latter, its much higher moral development, but it also "makes highly probable and practically demonstrable the fact that the laws of Hammurabi," as Professor Kent of Yale says, "in some cases exerted a direct and in others a powerful indirect influence upon the laws and institutions of the Hebrews."

We can give only two or three illustrations. This is a law from the code of Hammurabi: "If any one brings an accusation of any crime before the elders and has not proved what he has charged, he shall, if it be a capital offense charged, be put to death." Comp. Dent. 19:16-21. Both codes makes kidnapping a capital offense, inflict capital punishment upon both parties to an act of adultery, and exact the same fine if an ox kill a man's slave. The code of Hammurabi said shepherds should "pay to the owner of a field of specified sum for the injury done to his crops by their flocks as a result of their careless or deliberate action." Comp. Ex. 22:5. These illustrations could be multiplied. Enough has been given to illustrate how this early code from the father of jurisprudence exerted a large influence over the Hebrew legislation. True that all of these legal and moral principles from Egypt and Babylonia were not adopted by the Hebrews in any out and out fashion. They were all assimilated by the Hebrew consciousness and adapted to the conditions of Hebrew life. But as we go back for many of our fundamental principles to England and the English back to Rome, so the Hebrew went back to Egypt and Babylon for many of their civil laws and moral principles.

To suppose that man never observed a Sabbath until the writing of the Ten Commandments would be as absurd as to suppose that the Declaration of Independence created the love of human liberty. The law to observe the Sabbath was only a formulation of a principle which had been long in practise among many people. We find among the Babylonians the custom of resting upon the 7th, 14th, 21st, 28th, days of each month. It was a law that upon these days

no work should be done, not even the king was permitted to change his clothes or mount his chariot. It matters not what motive prompted them to keep these days. Enough for us to know that in the early times a rest day was kept and the time and manner of keeping it reminds us strongly of the later Hebrew Sabbath.

True, this involves us in a difficulty. We have not been in the habit of thinking that any of the Hebrew legislation came in this way, especially the Decalogue. We have thought of the Hebrews as gathered at the feet of Sinai to receive a revelation. Amid thunder and lightnings and with the sound of a trumpet the Lord descended upon the smoking Mount and from there proclaimed the words of the law in the ears of a terrified people. The words uttered by the very voice of God were graven by the finger of God upon two tablets of stone.

Now it is significant that in the code of Hammurabi the divine origin of law is as definitely taught as in the chapters of Deuteronomy or Exodus. In the introductory words of these laws Hammurabi says: "The great gods have called me. I am the salvation-bearing ruler." And he closes by saying, "Hammurabi, the king of righteousness, to whom Shamash (that is the sun-god) has presented the law am I." Other traditions exist where the gods are represented as the author of law and civilisation. Are we not justified, as we read this poetic symbolism of the Bible, in believing that the writer of this record spoke of Moses as it was customary to speak of the great moral and political leaders of his time, as men sent from God, and of their law as having a divine origin? As Hammurabi believed that his laws were from God, so did Moses believe, and the writer clothed this faith in the terrible symbolism of Sinai. The proof of their divine origin was not in their symbolism, but in their moral purity and power for the history of mankind.

Space will not permit us to bring more evidence, but enough, I believe, has been used to prove beyond a doubt that Israel was not the isolated nation we have so long supposed her to have been, but the roots of her history extend far back into the history of the past. If every history of the civilised world could be destroyed except a brief account of the laws and institutions of the United States, people a century hence might well think that America was an isolated nation, that our laws and institutions were given directly from heaven. But we know better. Our common laws go back to England and our fundamental political ideas have their roots in soil even back of the mother country. Yet we believe none the less that God has guided us and has used this method of blessing the world. So

with nothing but the Bible we thought of Israel as isolated, but now with our wider literature we see that here has been a greater providence. Through a long process of education which extends back to periods of which we have no records, God has been preparing Israel for the leadership of the world and the final coming of Jesus Christ. So far as we can discover, God's method has always been that of evolution and not revolution, and Israel is no exception to the rule. As our national development has depended somewhat upon other people, so did Israel's. Absorbing much from that vast old-world civilisation and having the best advantages for a religious training, she has made all the world indebted to her.

## IN THE MAGIC CIRCLE.

BY HENRY RIDGELY EVANS.

### I.

WHEN the citizen-king, Louis Philippe, ruled over the destinies of *la belle* France, there resided in Paris an old man by the name of M. Roujol, familiarly known among his confreres as "Father" Roujol. He kept a modest shop in the Rue Richelieu for the manufacture and sale of magical apparatus. The professional and amateur conjurers of the French capital made Roujol's their meeting place. "The Duc de M.—," says Robert-Houdin, "did not disdain to visit the humble emporium of the mystic art, and remain for hours conversing with Roujol and his associates." It was here that Houdin became acquainted with Jules de Rovère, of noble birth, a conjurer who abandoned the title of *escamoteur*, as beneath his aristocratic dignity, and coined for himself the pompous cognomen, *prestidigitateur*, from *presti digiti* (activity of the fingers). The French Academy sanctioned the formation of this word, thus handing it down to posterity. Jules de Rovère also called himself *Physicien du Roi*. Old Father Roujol is dust long ago; he has no successor in France. But we have a replica of his quaint place in New York City. On Sixth Avenue, not far from Thirtieth Street, is the shop of the Martinka Brothers. It is located on the ground floor of a dingy old building. In front is a tiny window, with a variety of magical apparatus displayed therein. Above the door in tarnished gold letters is the sign "Palace of Magic." The second floor is occupied by a Chinese restaurant. The Occident and Orient exist here cheek-by-jowl. The Chinaman concocts mysterious dishes to tickle the jaded palates of the *boulevardiers*; the proprietors of the Aladdin Palace of Up-to-Date Enchantments invent ingenious tricks and illusions to astound the eyes of their patrons. Here you may meet everybody in the magic line, from Kellar the Great to the humblest amateur, provided you are a member of the Society of American

Magicians. This society owes its foundation to two practising physicians of New York, Dr. W. Golden Mortimer, an ex-conjurer, and Dr. Saram R. Ellison, a great collector of magic literature. Ellison suggested the name, Mortimer wrote the ritual of the order, and the two of them called the meeting for the formation of the society. The first idea of such a fraternity of magicians was formulated by the writer of this paper, who endeavored to found a society called the *Sphinx*, but it proved abortive. The leading conjurers of the United States and Europe are enrolled among the members of the S. A. M. The meetings are held once a month at Martinka's,

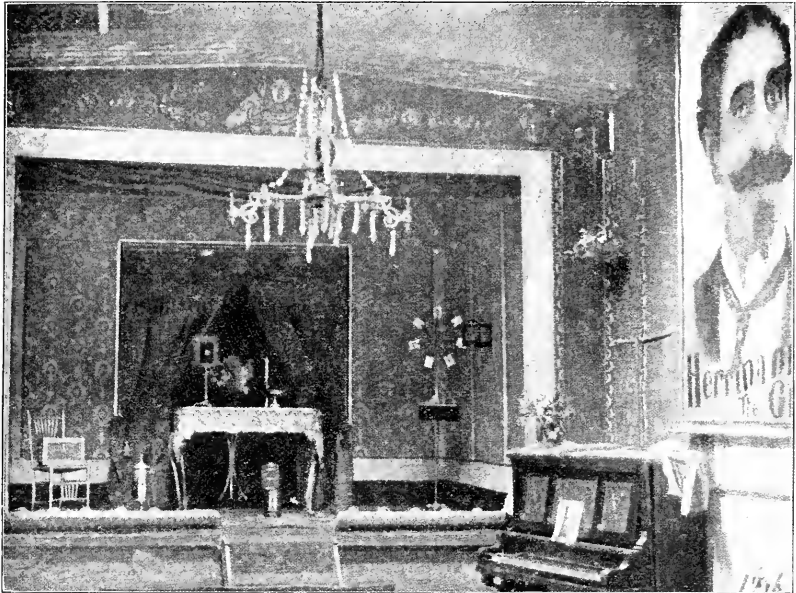

BIJOU THEATRE OF THE MARTINKA BROS., NEW YORK.

usually followed by exhibitions of skill on the stage of the Bijou Theatre, attached to the place. Robert-Houdin, in the closing chapter of his "Secrets of Conjuring and Magic," remarks that it would be a superb sight to witness a performance by magicians, where each would show his *chef d'oeuvre* in the art. At Martinka's this is realized. Here you may see the very perfection of digital dexterity, mental magic, and the like. Mr. Martinka possesses many interesting relics of celebrated performers: Alexander Herrmann's wand. Robert Heller's orange tree, and photographs galore of magicians, living and dead. The electrical sofa, used by Heller in his second-

sight trick, is owned by Mr. Francis J. Martinka, and graces his



X-RAY PHOTOGRAPH OF KELLAR'S HAND.  
(In the possession of Mr. Francis J. Martinka, New York.)

dining room. Some of the most important illusions of the day have been built in the shop of the Martinka Brothers.



It was here that I first became acquainted with Alexander Herrmann and Harry Keller, whose careers I will briefly sketch.

Alexander Herrmann, who was of Jewish origin, was born in Paris, February 11, 1844. Information concerning his family is very meagre indeed. His father, Samuel Herrmann, a physician, was an accomplished conjurer, but did not give professional performances, and was against his son taking up magic. The eldest brother, Carl, despite the parental opposition became famous as a sleight-of-hand artist, and was known as the "First Professor of Magic in the



HERRMANN I, II, III.

World." The father was ambitious to have Alexander follow the profession of medicine, but fate willed otherwise. Alexander, when quite a boy, ran away and joined Carl, acting as his assistant. He remained with his brother six years, when his parents placed him in college at Vienna. He did not complete his scholastic studies, but went to Spain in 1859 and began his career as a magician. He appeared in America in 1861, but returned a year later to Europe, and made an extended tour. He played an engagement of 1,000 consecutive nights at Egyptian Hall, London. In 1875 he married Adelaide Scarsez, a beautiful and clever danseuse, who assisted him

in his *soirées magique*. Herrmann became a naturalized citizen of the United States in 1876. He died of heart failure in his private car, December 11, 1896, while traveling from Rochester, N. Y., to Bradford, Penn. He was buried with Masonic honors in New York City. He made and lost several fortunes. Unsuccessful theatrical speculations were largely responsible for his losses. He aspired in vain to be the manager and proprietor of a chain of theatres. He introduced the celebrated Trewey, the French fantaisiste, to the American public. Herrmann was an extraordinary linguist, a *raconteur* and wit. Several chivalric orders were conferred upon him by European potentates. He usually billed himself as the Chevalier



TREWEY.



ALEXANDER HERRMANN.

Alexander Herrmann. His mephistophelean aspect, his foreign accent, and histrionic powers, coupled with his wonderful sleight-of-hand made him indeed the king of conjurers. He had a wrist of steel and a palm of velvet. He performed tricks wherever he went, in the street cars, cafés, clubs, hotels, newspaper offices, and markets, imitating in this respect the renowned Bosco. These impromptu entertainments widely advertised his art. He rarely changed his *repertoire*, but old tricks in his hands were invested with the charm of newness. I can remember as a boy with what emotion I beheld the rising of the curtain, in his fantastic soirées, and saw

him appear, in full court costume, smiling and bowing. Hey, presto! I expected every moment to see him metamorphosed into the Mephisto of Goethe's "Faust," habited in the traditional red costume, with red cock's feather in his pointed cap, and clanking rapier by his side; sardonic, and full of subtleties. He looked the part to perfection. He was Mephisto in evening dress. When he performed the trick of the inexhaustable bottle, which gave forth any liquor called for by the spectators, I thought of him as Mephisto in that famous drinking scene in Auerbach's cellar, boring holes into an old table, and extracting from them various sparkling liquors as well as flames. In his nervous hands articles vanished and reappeared with surprising rapidity. Everything material, under the spell of his flexible fingers, seemed to be resolved into a fluidic state; as elusive as pellets of quicksilver. He was indeed the Alexander the Great of Magic, who had conquered all worlds with his necromancer's wand—theatrical worlds; and he sighed because there were no more to dominate with his legerdemain. One of his posters always fascinated my boyish imagination. It was night in the desert. The Sphinx loomed up majestically under the black canopy of the Egyptian sky. In front of the giant figure stood Herrmann, in the center of a magic circle of skulls and cabalistic figures. Incense from a brazier ascended and circled about the head of the Sphinx. Herrmann was depicted in the act of producing rabbits and bowls of gold fish from a shawl, while Mephisto, the guardian of the weird scene, stood near by, dressed all in red, and pointing approvingly at his disciple in the black art. In this picture were symbolized Egyptian mystery and necromancy; mediæval magic; and the sorcery of science and prestidigitation.

After Herrmann's death, he was succeeded by his nephew, Leon Herrmann—Herrmann III, who is a successful performer.

His widow exhibits in vaudeville and gives a very clever entertainment of magic, entitled "An Evening in Japan."

## II.

Let us now pass in review some of the great Herrmann's tricks. His gun illusion was perhaps his most sensational feat. I am indebted to the late Frederick Bancroft for a correct explanation of the startling trick.

A squad of soldiers under the command of a sergeant, comprised the firing party. The guns were apparently loaded with genuine cartridges, the bullets of which had been previously marked for identification by various spectators. The soldiers stood upon

a platform erected in the centre of the theatre, and Herrmann stationed himself upon the stage. The guns were fired at him, and he caught the balls upon a plate. Upon examination the balls were found to be still warm from the effects of the explosion, and the marks were identified upon them. The substitution of the sham cartridges, which were loaded into the guns, for the genuine ones was very subtly executed by means of a trick salver having a small well let into its centre to hold the cartridges. Into this well the marked cartridges were deposited by the spectators. In the interior of the salver was a second compartment loaded with the blank cartridges. The sergeant who collected the bullets shifted the com-

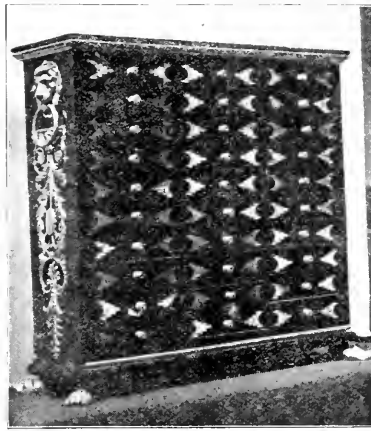

MAGICAL CABINET CONSTRUCTED BY CARL HERRMANN.

The magician places a card in any of the little drawers of the cabinet, and it will reappear in any other drawer the onlooker may suggest. (Now in the possession of Mr. Martinka, New York City.)

partments by means of a peg underneath the salver, as he walked from the audience to the stage. The sham cartridges were now brought to view and the real were hidden in the body of the salver. While the soldiers were engaged in loading their rifles with the blank cartridges, the sergeant went behind a side scene to get his gun, and deposit the salver. A couple of assistants extracted the genuine bullets and heated them. Herrmann went to the wing to get the plate, and secretly secured the marked bullets. The rest of the trick consisted in working up the dramatic effects.

One of Herrmann's best illusions, though not invented by him,

was his vanishing lady, known as "Vanity Fair" and "After the Ball." A large pier glass, which was elevated some two feet above the stage, was brought forward by the magician, and the glass shown to be solid, back and front. Mme. Herrmann, dressed in a

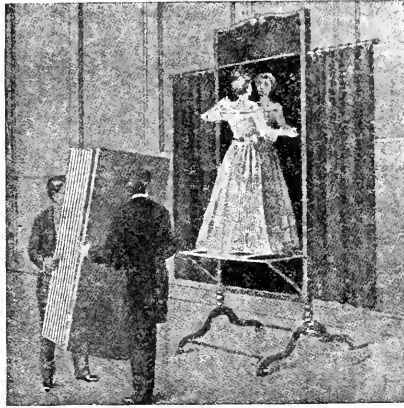

"AFTER THE BALL"—I. SCREENING THE LADY.

handsome ball costume, was now introduced to the audience. By the aid of a small ladder, she climbed up and stood upon a glass shelf immediately in front of the mirror. A narrow screen was

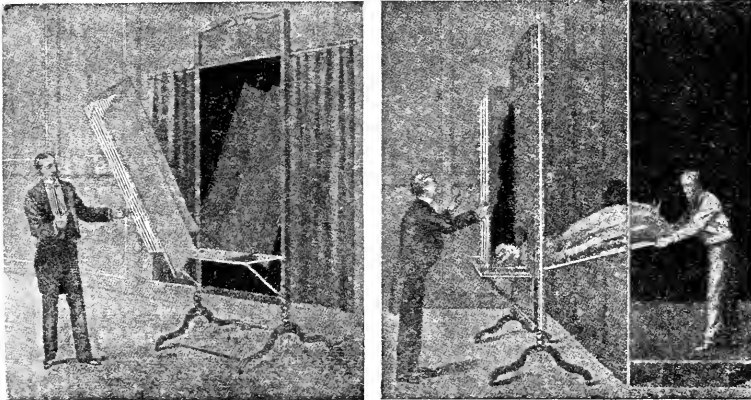

"AFTER THE BALL"—2. THE ESCAPE.

then placed about her, so as not to hide from the spectators the sides of the mirror.

"Ladies and gentlemen," said Herrmann, "Madame Vanity Fair, who is now gazing at her pretty features in the mirror, has

only to pronounce a certain mystic formula known to the Cabalists, and she will be instantly transported to the grand ball at the Opera House. This is a decided improvement on horses and carriages." He fired a pistol, and the screen was pulled away. The lady was found to have completely vanished. But how? Not into the mirror, into that land of adumbration, celebrated in "Alice's Adventures in a Looking Glass." No, the glass was apparently of solid crystal, and too thin to conceal anyone. This is the *modus operandi* of the trick: The mirror in reality was composed of two sections. The glass shelf upon which the lady stood, concealed the top of the lower section. The upper section was placed to the rear of the lower mirror, so that its lower end slid down behind it. This upper glass worked like a window sash. When it was pushed up, its upper end was hidden in the wide panel of the frame. The lower part of this large glass had a piece cut out. Through this opening the lady was drawn by an assistant. When she had escaped through the back scene, the counterpoised mirror was again pushed down into its proper place. The fact that some of the mirror was in view during the exhibition allayed suspicion on the part of the audience. It was one of the most novel and effective illusions of Herrmann's repertoire, particularly because of the fact that he was assisted by his pretty and graceful wife, who looked charming in her elegant ball dress, and acted her part to perfection.

### III.

The dean of American magicians is the famous Harry Kellar, who was born in Erie, Penn. He went on the stage when a boy, as assistant to the Fakir of Ava. Subsequently he served an apprenticeship with the notorious Brothers Davenport, spirit mediums, and from them learned the mysteries of rope-tying feats. Kellar is today the leading exponent of the *art magique* in the United States. He makes a specialty of pseudo-clairvoyance, second-sight, spirit cabinets, feats of levitation, and mechanical illusions. He has traveled extensively in the Orient, and visited the courts of Indian Rajahs. Seizing upon the modern craze for Hindoo necromancy, mahatma miracles, and the like, he presents many of his tricks and illusion as examples of Eastern thaumaturgy. Unlike Herrmann the Great, who bubbled over with wit and humor, and acted the comedian, Kellar assumes a Sphinx-like demeanor and surrounds himself with an air of Egyptian mystery. His entertainments appeal to the scholarly and refined. They are conducted with great solemnity and dignity. One almost imagines himself to be

in an Egyptian Temple, witnessing the magic feats of the hierophants. Kellar has written several monographs on his art—mainly contributions to magazines; all highly suggestive and entertaining. He says: “There are six qualifications which are of the essence of the successful magician, prestidigitateur, necromancer—call him what you may. They are: The will, manual dexterity, physical strength, the capacity to perform things automatically, an accurate, perfectly ordered and practically automatic memory, and a knowledge of a number of languages, the more the better.”

Speaking of his experiences as stage helper, or *chela* to the so-called Fakir of Ava, he says (*Independent*, May 28, 1903): “The ‘face’ of many a prestidigitateur has been saved and his defeat turned into a glorious victory by the merest chance. One of my first adventures with the Fakir of Ava affords a capital illustration. We were doing the watch trick—taking a timepiece from some one in the audience, passing it upon the stage in a platter, destroying both platter and timepiece in plain view of the spectators, loading the fragments into a pistol, firing the weapon at a target and bringing the watch—whole and sound—to life again upon the face of the mark, in plain sight of the audience. But on that particular day the target concluded not to do its share of the performance. No watch would it produce; the machinery was out of order. We had to work hard to ‘save face.’

“Disguised as an usher of the house, I went down into the audience with the timepiece, hoping to be able to slip it unobserved into the pocket of the owner. He was sitting at a distance from the aisle; I found it impossible. I did the next best thing—slipped the watch into the waistcoat pocket of the man who sat next to the aisle on the same row with the owner. Then I returned to the stage.

“The Fakir in the meantime was discussing learnedly upon some other subject. When I returned, the question of the whereabouts of the watch was called up and a bell on the stage was summoned to answer questions; one ring for ‘yes,’ two for ‘no.’

“‘Is the watch on the stage?’

“‘No,’ replied the obedient bell.

“‘Is it in the audience?’

“‘Yes.’

“‘Is it on the first row?’

“‘No.’

“‘The second—the third, the fourth, the fifth?’

“‘To each question came a ‘no.’

“‘Is it on the sixth row?’

“‘Yes.’

“‘Is it the first man on the row?’

“‘Yes.’

“The eyes of the audience focused upon the unfortunate occupant of the seat.

“‘Look in your pocket, sir,’ said the Fakir of Ava, in his politest, most persuasive tones.

“‘Go on with your show there and let me alone,’ shouted the enraged seat holder.

“‘But I pray you, look in your pocket,’ said the Fakir.

“The man obeyed and produced the watch! The trick, called

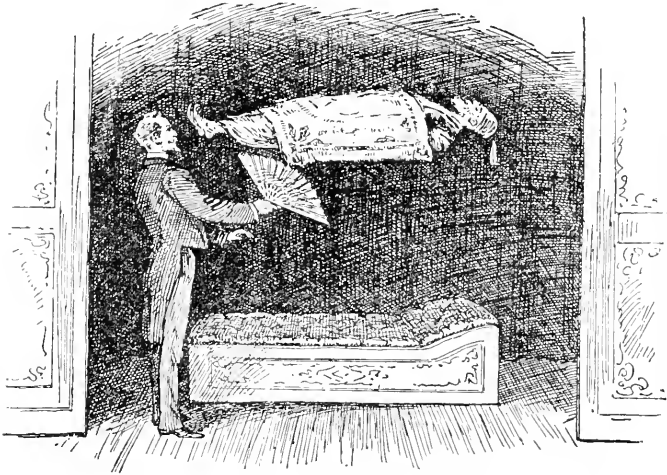

FIG. 5. THE CELEBRATED “LEVITATION” MYSTERY.

in stage vernacular a ‘life saver,’ made a hit vastly more impressive than the one originally planned but spoiled by the perverseness of the target.”

Kellar’s greatest and most sensational illusion is his “levitation”—raising a person and leaving him suspended in mid-air without any apparent means of support, seemingly defying the law of gravitation. The explanation of this surprising feat is thus described by a writer in the *Strand Magazine* (London):

“An assistant is introduced, laid upon an ottoman, and then sent off into a hypnotic trance (?). The performer takes an ordinary fan and fans the body while it rises slowly about four feet in the air, where it mysteriously remains for any length of time desired (Fig. 5). A large solid steel hoop is given for examina-



tion, and after the audience is satisfied as to its genuineness it is passed over the body from head to feet, behind the body and over it again, at once dispelling the idea of wires or any other tangible support being used, the body, as it were journeying through the hoop each time. The suspended assistant is now fanned from above and gently descends to the ottoman as slowly and gracefully as he rose from it. He is then brought back to his normal state out of the trance, and walks off none the worse for his aerial pose.

“This seeming impossibility is performed by the aid of a cranked bar (Fig. 6 and A, Fig. 7) and a pulley to raise it, the bar being pushed through from the back at the moment when the performer

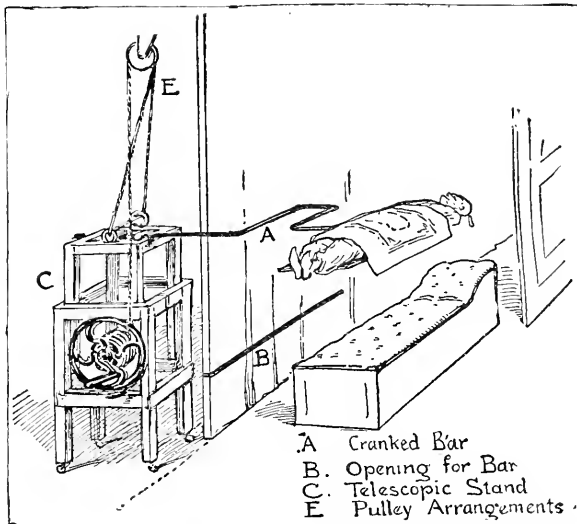

FIG. 6. “LEVITATION”—HYPNOTISM OR MECHANISM?—WHICH?

is ‘hypnotizing’ the subject, and in the act of placing a light covering over him he guides a clamp (B, Fig. 7) and fixes it to the top of the ottoman upon which the subject rests, and which rises, unseen, with him, the edges being obscured by the covering. The bar being the same color as the back scene cannot be noticed, and resting upon a stand (C, Figs. 6 and 7) behind the scenes the same height as the ottoman it is kept firm by the aid of strong supports. Being also double the width (D, Fig. 7) at this part greater leverage is obtained to hold the board upon which the subject rests secure from tilting either way. By means of a pulley arrangement (E, Fig. 6) the assistant behind raises and lowers the body, looking through a small hole in the scenes and timing the

performer's movements with exactness. Fig. 5 shows the illusion as it appears. Fig. 6—a side view—shows the means of suspension and the pulley for raising the bar and telescopic stand. Fig. 7 almost explains itself. It shows the method of passing the ring over the body. By putting it on at (1) and passing it as far as the centre of the bar (A) it can be brought around and off the body at (2), apparently having passed right over it, although not free from the crank; it is then passed behind the body as far as (3), when it can be again placed over the end (1) and drawn across

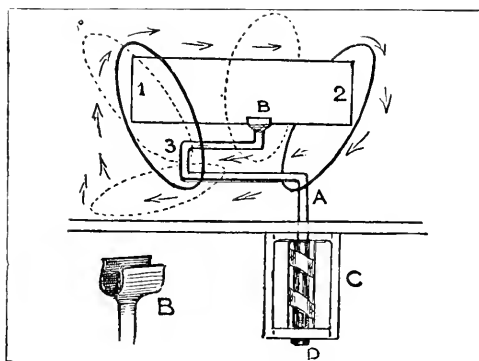

FIG. 7. "LEVITATION"—HOW THE HOOP IS PASSED OVER THE BODY.

once more, this time being, of course, quite free, having made an apparent circle right around and across the body. It seems evident to the audience that the subject is so raised and suspended by the performer's magic power alone. The sleeping subject is now lowered, and in the act of being 'dehypnotized' the performer slips the crank off, which is immediately drawn in from behind, the subject and performer sharing the applause. It is almost needless to explain that the 'hypnotism' is mere sham to heighten the effect and admit of an excuse to stoop in order to fix the cranked bar."

## IMAGE-WORSHIP.

BY THE EDITOR.

ONE objection which is constantly repeated by Greek philosophers and Roman magistrates against the early Christians is their alleged impiety or lack of reverence. As a matter of fact, we know that the early Christians were iconoclasts who lost no opportunity to revile image-worship in any form as idolatry, and later on when they grew in power Christian mobs took special delight in smashing the statues of the gods, the old and venerable ones as well as the latest and most beautiful productions of Greek art. The result is that we have not one statue left of any of the ancient gods that is not in some way injured, broken, or desecrated.

The early Christian repudiated image-worship to such an extent as to regard artists as idol-makers and to exclude them from their communion, and the craft of sculptors was regarded as a disreputable profession.<sup>1</sup>

With the spread of Christianity among the more refined classes the original aversion to art gave way to more tolerant views; but the change took place slowly and can be traced step by step.

Clement of Alexandria tells us that in the use of seal-rings the strictness of the rule to avoid all ornaments may be relaxed. But the symbols that can be tolerated are limited in number. He says :<sup>2</sup>

“ Let our seals be either a dove, or a fish, or a ship scudding before the wind, or a musical lyre, which Polycrates used, or a ship's anchor, which Seleucus had engraved as a device, and if there be one fishing, he will remember the apostle and the children drawn out of the water. For we are not to delineate faces of idols, we who are prohibited to cleave to them ; nor a sword, nor a bow, following as we do peace ; nor drinking cups, being temperate.”

Christians in their hostility to art did not invent pictorial illustrations, but only tolerated such symbols as could be interpreted in a Christian way. The fish was the symbol of Ea the Chaldæan

<sup>1</sup> *Constitutiones Apostolorum*, VIII., 32, and Tertullian *De Idolatria*, ii.

<sup>2</sup> *Pædagogus*, III., 11, near the end of the chapter on finger-rings.

fish-deity who being God the Son, the saviour and mediator, resembles Christ in more than one respect. The lyre was an Orphic emblem and represented the power of the divine music that could force the gates of Tartarus and lead the dead back to life. The fisherman reminds us of the Babylonian Adapa, the wise man who is found fishing before he ascends to Anus's throne in heaven.

Tertullian's limitation was soon obliterated and we find the number of Christian emblems rapidly increasing. Though the ideal of the early Christians remained a worship of God in spirit and in truth, the instinct that yearns for visible symbols and pictures gradually asserted itself, and in the sixth century image-worship with incense-burning and knee-bending to pictures and statues was firmly established in Christian churches.

When the statues of the old gods were broken to pieces, so that scarcely one of them was left un mutilated, when the temples lay waste and in ruins, victorious Christianity adopted the pagan methods of worship, formerly scorned as idolatrous. The old gods returned under the name of saints, and the inveterate habit of idolatry reasserted itself. The old symbols were retained, though they had to submit to the new *régime* and acquire a new interpretation.

Even the most orthodox Christian archæologists are aware of the fact that the whole Christian symbology is due to pagan influence and pagan traditions. Thus the dove was the symbol of As taroth and it is a mistake to regard all gems with doves on them as Christian. Bishop Münter protests against the claims of the dove as an exclusively Christian symbol, and adds :

"Probably we cannot even for the olive branch and olive leaf on any one of these intaglios on which they appear, claim a Christian origin, for on every gem published by Clarke, the dove stands on something that resembles a branch terminating in a leaf."<sup>1</sup>

Many of the birds which are commonly taken to be doves and on that account have been regarded as Christian are, according to Bishop Münter, not doves but ravens. The raven was a Mithraic symbol of great importance and in one of the Mithraic degrees (called the Raven degree *κορακικά*) the initiated were called the Ravens (*κόρακες*).

While the palm leaf, the dove, the ship, the anchor, the vine, the  $\omega$  were frequently employed by the Christians of the second century as symbols of their faith, they still abstained rigorously from having any images. Even portraits of Christ (the latter per-

<sup>1</sup> See Dr. Friedrich Münter, *Bischof von Seeland, etc., Sinnbilder und Kunstvorstellungen der alten Christen*, I., p. 109.

haps more so than other pictures), were repudiated as savoring of pagan idolatry, and thus it happened that non-Christians, gnostics, and even broad-minded pagans were the first to have the Christ-ideal represented by the chisel of sculptors and the brush of painters.

Epiphanius indignantly censures the Carpocratians because "they kept painted portraits and even images of gold and silver and other materials which they pretended to be portraits of Jesus and made by Pilate after the likeness of Christ at what time he sojourned amongst men."<sup>1</sup>

Similar cases are mentioned by other Christian writers. St. Augustine condemns Marcellina for setting up a statue of Christ together with those of St. Paul, Homer and Pythagoras;<sup>2</sup> and Alexander Severus, a broad-minded pagan, is reported to have kept in a sanctuary at his home the statues of Christ, Abraham, Orpheus, and Apollonius of Tyana.<sup>3</sup>

The council of Eliberis in Spain (A. D. 305) prohibited the use of images; it decreed "that pictures or likenesses ought not to be allowed in the churches." But the fact that a motion of this kind was made and carried proves that there was a minority among the Christians who saw no idolatry in having pictures, and we may assume that at this period a tendency began to make itself felt toward a toleration of image-worship, which the church authorities, however, still branded as inadmissible, "lest the images on the wall themselves be adored."<sup>4</sup>

The foundation of the State Church denotes a great victory of Christianity over traditional paganism. Christianity was established in name, but the methods of worship and the dominant conceptions of the ancient religious faith became now officially established as an integral part of the new religion. The original Christian faith as it had found shape in the writings of the New Testament remained the dominant factor, but it was modified through an amalgamation of the doctrines of the Church with pagan traditions and a reception of the old deities under the name of saints. The ancient heroes, the Medusa killers, and the conqueror of the Chimera, Bellerophon, etc., were worshipped under the name of St. George (the Christian saint of that name has never met a dragon of any kind); and Diana as well as Juno and Venus were trans-

<sup>1</sup> *Epiphanius Her.*, XXVII.

<sup>2</sup> *De Hæres.* VII.

<sup>3</sup> Mentioned by Lampridius in *Alexandrum Severum*, XXIX.

<sup>4</sup> See Rock's *Hier.*, p. 374, cf. H. Diward, *Hist. of the Cr.*, p. 38.

formed into Mary, the mother of God, sometimes into Mary Magdalene, sometimes into some other female saint, while various deities of classical antiquity were mostly changed into minor saints, all being regarded as subject to the great Son of God, the Redeemer Jesus Christ.

The strangest thing is that there are a great number of black Marys, and there can be scarcely any doubt that the color of these several black Marys is a pagan tradition which points back to a cult in most ancient times. Many black Marys are found in Southern Italy; there is one, the Madonna di Porto Salvo, in Naples; there is another dark Madonna in Cotrone, Calabria, and another in Loretto, which latter was supposed to have been made by St. Luke, the Gospel writer.

The worship of black Marys has reached even more northern countries, especially Southern France and Spain, where one is mentioned in the life of Ignatius Loyola as being in Monserrato. Even Switzerland possesses a black Mary at Einsiedell, and Bavaria in Altötting. Of the pre-Christian goddesses of black color, Trede<sup>1</sup> mentions a black Artemis Ephesia which is preserved in the National Museum at Naples. Pausanius also speaks of the dark-colored Artemis (Book 2, Chap. II). The same author mentions a black Aphrodite, who on that account was called *Melainis*, i. e., the Dusky One (Book 8, Chap. VI., and Book 9, Chap. XXVII.), and of a Dark Demeter (Book 8, Chaps. V. and XLII.). The Egyptian Isis was always cut from black granite.

The black color of the Christian Mary is generally explained by Christian authors on the ground of the *Song of Songs*, where we read of Shulamite, "I am black but comely" (Chap. I, v. 5), which passage is commonly referred by Protestants to the Church, and by Roman Catholics to Mary; but this explanation is apparently an after-thought.

Christianity, no doubt, exercised a beneficial influence upon the large masses of the poor and degraded, thus leavening the dough of the Roman Empire from its lowest classes upwards, but the State Church did little or nothing for the moral progress of mankind; on the contrary, it rather brutalised the upper classes by making the sentiments of the lower classes predominant.

The age of Constantine is one of the saddest times in history, and the result of the foundation of a State Church was an alliance between the pagan elements of Christianity and the popular superstitions of paganism. The persecutions of pagan philoso-

<sup>1</sup> See Trede, *Das Heidenthum in der römischen Kirche*, Vol. II., p. 381.

phers and sympathisers has been palliated on the plea that it was a reaction against the oppressions which the early Christians had to suffer, but such events as the assassination of Hypatia and similar crimes cannot be extenuated, and the crusade against classic art and the destruction of many beautiful statues of antiquity is a barbarism which finds few, if any, parallels in history. Mobs were let loose on the idols so called, that is, the images of pagan gods in pagan temples, but the barbaric gladiator shows and other cruel spectacles of fights with wild beasts in the arena continued for several centuries under Christian emperors, and are preserved even to this day in the shape of bull fights in Catholic Spain,—a country which in its religious zeal for pagan forms of worship has surpassed even Italy, being, as has been said, the most Roman Catholic country in the world.

The establishment of the State Church is characterised by an official sanction on the one hand of a general destruction of the ancient productions of art, and on the other hand a rehabilitation of idolatry in the shape of image-worship. The culture of classic antiquity was ruthlessly destroyed, but the belief that had produced these noble statues of the Greek deities survived in its rudest and most superstitious form. Image-worship, so much abhorred by the early Christians, became soon the most essential feature of Roman State Christianity.

Roman Catholic archæologists find it hard to understand that church doctrines are subject to change. They refuse therefore to believe that the Catholic Church was ever opposed to image-worship. Prof. Franz Xavier Kraus says (*Geschichte der christlichen Kunst*, p. 58):

“This theory of the hatred of art among the early Christians is the worst fable, to remove which is the first duty of modern criticism.”

Professor Kraus succeeds in the task only by repudiating on this point the authority of Tertullian, Eusebius, Epiphanius, Asterius, Nilus, Augustine, Clement of Alexandria, and the Council of Elvira; but he fails to produce a single quotation of any Church-father who endorses image-worship; nay, rather, there is no one who regards it as even permissible. We might as well deny that the Church ever believed in the divinity of Christ, by branding all statements as unauthorised and forgetting to mention that there is nothing to back the contrary view.

## PARSIFAL.

BY THE REV. ADOLF ROEDER.

**A**MID the wealth of Parsifal literature there are two factors which have thus far not received the attention they deserve. In one sense these two factors are separate and separable—in another they are sequences of the same mental process on the part of the giant unit called the “Maximus Homo” or the Race-Man. And it is this mental process itself in its two aspects to which attention is here called.

We all understand that there is a certain law or rather a steadfastness of relationship in physics and in physical things called “the complementary.” Certain colors being given in nature and in art, certain other colors called complementary colors are immediately implied. Certain tones in the musical scale being given there is instantly created a tonal or harmonic relationship. Certain fractions being given in mathematics their “reciprocals” are implied. Certain angles being given in geometry there arise certain others complementary and supplemental. This series of fixed relationships transferred to the realm of physical forces, becomes yet more “rigidly relational,” if such an apparent contradiction of terms may be used. A positive force involves its negative; a direct force, a lateral, absence of resilience in muscle means compensatory hypertrophe of that muscle, and so on to the end of the chapter—and rather an extensive chapter it is.

This being true in the realm of matter and nature, there is no reason for conceiving of it as being anything but true in the domain of mental and spiritual things. By the side of every impulse there runs a restraint to give it direction; and behind each restraint lies an impulse or there could be no restraint. In the same way, beside every deprivation runs a compensation. And this series of activities and passivities runs a gamut, as extensive as that indicated along physical lines.

Now look into the story of Parsifal, or Perceval, and you have the story of the compensatory Christ. The reason for it is readily



intelligible. The Christian Church has passed through several easily recognizable stages. There was a time when the personal factor of the Christ was a very present factor, either a tangible, actual thing, as it must have been to the Apostolic Church, or as a recent and sharp impression upon the plastic substance of Race-Memory, such as was the case in the early Christian and Ante-Nicene Church. And gradually, as decade upon decade and age upon age throbbed backward into the unfathomable depths of the past, this impress grew more and more feeble—the vista, at the end of which stood the Christ lengthened historically, geographically. The Turk possessed the Holy Land and the Christian looked across vast reaches of space toward the Sea of Galilee, and across interminable ages of time toward the Star of Bethlehem. Social, civic, religious conditions all had changed. Feudalism and serfdom upreared barriers between man and man; the Church and State dug deep trenches between men and men; theology relegated the faint reality of the Christ to the unmeasured depths of mental space, to the great white Throne which stood apart from the turmoil, the discontent, the imperfection of life. The World, the Flesh and the Devil grew more and more real and present, while the Christ grew equivalently less and less near, distinct and present, by the very law of which we are here thinking. For “Much devil, little God” is but a simple statement of fact, of the fundamental fact of the law of compensation which sways the Cosmos. Add to this, that the story of Christ or the Bible was removed from the people, hidden away from the people both by their own illiteracy and by the literary ability of the clergy, which naturally took the book out of palace and hovel and made it a cherished thing in monastery and chapel. Out of the hand of king and serf, the Wonderbook which spoke of the real Christ drifted naturally and normally into the hand of cleric and monk.

Thus were the people deprived of the real Christ. What was the result? They built for themselves a compensatory Christ.

Trace this peculiar element a little farther into any one of the other departments of human activity. What, for instance, is the meaning of dialect? Dialect is the method of speech of the man who is deprived of the correcter forms of language. However and for whatever reason deprived he will build himself a language, which will be dialect. He will construct for himself a language cruder and less beautiful than that which his more favored, more cultured and more learned brother was able to rear into an edifice of etymology, of grammar, and of syntax,—a hardy, sturdy, coarse, serviceable thing, called dialect, because the more elaborate thing conceived of

culture and born of refinement was too fragile a ware for his clumsy fingers. The lips of the man who handles the pen frame language; the lips of the man who swings the pick, frame dialect. Not only is this true of High German and Low German; the French of Paris and the French of Gascogne and the Bretagne; of the Spanish of Madrid and the Castilian (what an odd inversion) of the sailor of the Armada; of the Irish of the Ancient Gael and its Normanesque mockery, the Basque dialect. But it is true, as Diez and Canu show, of the "lingua Romana," the Latin "Romany"—the Latin of the common folk who quarried and carried the stone of the Capitol which differed from the Latin of the man who sat and ruled in the finished Capitol, as differs "Pennsylvania Dutch" from the language of a cultured denizen of Hanover. Side by side with the reality of language attained by culture runs the compensatory language dialect, which those must build for themselves who are deprived of the opportunities of learning.

Exactly so arose within the obscured and chaotic depths of the Race-Mind, in which the image of the real Christ grew daily and yearly, more remote and dim, another, a compensatory image, a Parsifal—the Holy Grail—the whole cycle of the Arthurian legends. It was the need of a heroic figure adopted to the semi-barbarism of mediæval days when hair-splitting theologians had deprived the masses of the real figure which pervades the New Testament with wondrous sweetness and persistency, and dangled before their unseeing eyes a theological question mark, a Son born from Eternity, whose relation to the Father of Eternity was either homoousian or homoiousian when the devotee was a Supralapsarian, a transubstantianist, a solifidian. We know that nothing so thoroughly crows the illiterate masses as these formidable marshallings of long words. Hence while the theologian of Byzanz hurled Greek anathemata at the devoted head of the Latins from behind battlements of grammar and exegesis-syllogisms, the common people strayed afield and built themacrudegospel out of neglected material and thus did Herzeleide give birth to Parsifal. Deep was their sorrow because of the deprivation and out of their own heart's sorrows (Herzeleide is German for "heart's sorrow") was the heroic figure born, which was to attain Mont Salvat—the Mount of Salvation—to go in quest of the cup.

Why the cup? Because the church gave the masses the bread, but deprived them of the cup. The people ate the bread, and the priest drank the wine. It was the cup, the cratella, the crael, the grail, of which they had been deprived, and by the weird law of compensation it was the cup they sought. And Parsifal seeking the

sacred cup on the Mount of Salvation became the compensatory Christ for a people from whom the real Christ had been removed by theological profundity and overzeal. The real Christ had become unlovable, so the people created a shadowy hero, a colossal figure, crude, fierce, hard, yet tender as were the people and the minds who conceived him. A simple man a "pure fool." Why? Why did the people build for themselves a stupid hero? For the same reason for which they constructed for themselves a stupid devil. For the devil of the monk was fierce; the devil of the masses a fool—feared by both but fierce for one, a fool for the other. Again, why? Because there is innate modesty in the mass mind, which recognizes keenly its own unwisdom, and therefore realizes that every figure it creates must be "a fool." But within that lay also the dim, almost subconscious recognition of that same mind of its own purity of motive, hence a "pure fool" is the outcome. And below the depth of these two confused consciousnesses lie the dormant abysses of race-subconsciousness; as inerrant and self assertive as individual subconsciousness; a wisdom too self-assertive to be gainsaid or concealed, hence a "pure fool born to wisdom."

And now to glance at the second feature of the process, the collecting of the symbolic data. Whether these be of Celtic or of purely Anglo-Saxon or of Germanic or of Norman origin, I would not venture to say; in fact, I should scarcely venture to deny any one of these possible sources the privilege of contribution. If Wolfram von Eschenbach, and Chrestien de Troyes, and Robert de Borran, and Sir Thomas Malory furnish the crude material for Tennyson and Wagner to work upon, why limit the symposium to these men? Why not admit an equally probable and equally interesting symposium of nations and of national origin? But aside from this comparatively secondary question of literary values, take the symbolic values themselves. As the uncultured man in the habitations of culture sits on the edge of the chair, fears to touch the fragile pottery and statuary, hesitates to use the glittering glass and burnished silver, so the unlettered man fears to boldly reach into the Gospel picture and take the central figure thence. That central figure, the real Christ, in his estimation the property of the Church, of the clergy, of monk and priest, of chancel and altar. Him he can not, dare not touch. Yet such a figure he must have. His heart is Christian at the core,—a figure in touch with the Christ he must have. And what he has been taught of the Christ is this: "We preach you Jesus and Him crucified." From every pulpit under which he sat devoutly was the crucified one preached to him; at

every solemn festival, when with bowed head and trembling heart he listened and looked, the stations of the cross were measured out before him; above every cathedral doorway and in every rockhewn niche, where his own piety had reached, hung the figure of the Crucified One. It was the Crucified Christ, and the figure he craved must be one near that Crucified Christ, hence "Joseph of Arimathaea." And again, he needed a "side pierced by the spear," he fears to locate it too near the compensatory sacred figure of Parsifal, and lo, it is the side of Amfortas which is wounded by the spear. Dimly he realizes that just before the end, just at the dusk edge of the picture of the crucifixion stands the dual picture of the cup, the cup of the Holy Supper, and the cup for the passing of which Jesus prays in Gethsemane. And the shadows of a sacred cup or vessel or grail flits into the picture. And against the same faint background of natural theology looms the idea that this cup-struggle, the "quest of the Grail," the "struggle for the Grail," is a fulfilment of something ordained of old. That it involves a fall from heaven and a return to heaven, and lo, the stone of which the Grail is chiseled "fell from heaven in the dim days of the first fall of the angels." And with the idea of the struggle for the cup he must needs combine the idea of food, for in the feebly-illuminated recesses of his soul the cup of the Holy Supper hovers and the element of food spontaneously introduces itself.

Further detail seems unnecessary. Back of each of the wonderful typical figures of the Parsifal legend shines reality; back of the Temple of the Round Table glows the dim vista of the Temple of Solomon; back of Klingsor a suspicion of Judas Iscariot, back of Kundry the fatal dualism of man's inner and outer self, his love of God, the woman who is sweet and pure, and his love of self, the woman who is impure. Back of the Garden of Klingsor, two other gardens, the Garden of Eden where man was lost, and the Garden of Gethsemane where he was saved. So back of each of these candidly compensatory shadows lies the reality, the substance of the Wonderbook, readily seen, readily understood and very lovable withal.

And towering into bold relief in the compensatory Christ-Parsifal, we behold and feel the intense desires of the great mass of the people for a deified man, for a wonderful humanity which shall in some unfathomed and unfathomable way stand very close to Deity. And through the story of Parsifal weaves and throbs the deep and reverent love of God's untutored children for the God-Man, the Deus-Homo, Jehovah-Jesus.

# THE QUEEN OF SHEBA ACCORDING TO THE TRADITION OF AXUM.

BY THE EDITOR.

DR. E. Littmann has started the publication of an Abyssinian library called *Bibliotheca Abessinica*, in which he proposes to publish studies concerning the languages, literature and history of Abyssinia. The first volume before us contains the legend of the Queen of Sheba, which of all Abyssinian traditions will prove especially interesting on account of its connection with the Solomon and Old Testament traditions, also mentioned by Jesus in the New Testament;\* and it is interesting to notice that the title "The Queen of the South," which is the exact name used by Jesus, literally agrees with the Abyssinian term *Etiyē Azēb*.

Dr. Littmann publishes the text of an Abyssinian manuscript together with an English translation and dedicates his work to "R. Sundtröm, Missionary and Scholar," who is living in the Colonia Eritrea. To him he owes not only the manuscript, but also much help in the translation.

The legend exists, as stated by Dr. Littmann, in two other versions, one published in French by M. E. Amélineau, the other by Dr. Conti Rossini. In all essential points the three translations agree. The story as published by Dr. Littmann is the Tigrē version of the legend and apparently a local tradition of Axum, for one part of the story refers to the ark that is preserved in the Axum church.

Briefly told the legend is as follows:

King Menelik was the son of Etiyē Azēb, e. g., "the Queen of the South," a Tigrē girl who was destined to be sacrificed to the dragon that in the age of fable infested the country. She was tied to a tree, but while she awaited her fate seven saints came and

\*Matt. xii. 42, Luke xi. 31. Jesus calls her ἡ βασιλίσσα τῶν νότου.

seated themselves in its shade. The girl began to weep and one of the tears fell on them. Upon inquiry who she was, whether Mary or a mortal woman, and why she was bound, they heard of her fate and decided to rescue her. The seven saints fought the dragon, and one of them smote him with the cross so that he died. The girl returned to the village, but the villagers expelled her because they thought she had merely escaped, but when she showed them the dead monster they made her queen and she chose a girl like herself as prime minister. Now it happened that some blood of the dragon had trickled on her foot, and her foot had turned into an ass's heel. Having heard much of the wisdom of Solomon, she decided to visit him to be cured of her infirmity; and so she went with her companion to Jerusalem in male guise, announcing herself as the King of Abyssinia and his Prime Minister. King Solomon suspected his visitors to be women, but invited them to stay and made them sleep in his own bedroom. He put some honey in a skin, hung it up in the room and placed a bowl under it. The queen and the prime minister tasted of the honey, and now he knew that they were women. He at once married them and on their departure he gave each of them a staff of silver and a ring, saying, that if their children should be boys, they should give them the ring, if they were girls, the staff. When the boys grew up the Tigrê people called them "fatherless children," but the Queen of Sheba said to her son: "Your father is King Solomon, and he lives in Jerusalem." She gave him a mirror and said: "The man who looks in color like you is King Solomon." When the boys reached Jerusalem, King Solomon hid himself in the stable and placed another man on the throne. The prime minister's son greeted the man on the throne as King, but Menelik looked into his mirror and saw that his color was not like his own. Finally he discovered the King in the stable and greeted him as his father. Solomon said: "Thou art my true son," and seated him on the throne.

The people complained saying: "We cannot have two chiefs. Send away your son." Solomon at the request of Menelik answered: "Is he not my first-born son? Send ye your first-born sons with him." When Menelik was ready to depart Solomon said: "Take the ark of Michael with thee." But Menelik took the cover of Michael's ark and put it on Mary's ark and departed with Mary's ark, which his father thought to be only the ark of Michael. A few days afterwards a storm arose, and it appeared that the ark of Michael was not strong enough to avert the evil,

so Solomon discovered that under the cover of Mary's ark had been left the ark of Michael. Thus the ark of Mary reached Axum where it is still standing.

The legend is interesting for many reasons. Not only do we have here a dragon story, such as is given in fairy tales all over the world, but we learn also that the ark of Axum, which contains stones, was supposed to have been stolen from Jerusalem by trickery in a similar way as Rachel, the daughter of Laban, stole "the images," the gods of her fathers.\* It is characteristic of a certain age to regard theft, fraud, and lies, on the sole condition that they are successful, as virtues. We only mention the Greek *Odyssey* where the hero is constantly lying even where there is no need of it, and the German *Reynard the Fox*.

It is well known that stories of folk-lore are never consistent either in chronology, names, or in other historical data. Thus, in the times of King Solomon we meet saints and the Virgin Mary, and the cross as a magic charm, but we need not doubt that the saints are only substituted for ancient pagan heroes, the cross for magic weapons, and Mary for "the Queen of Heaven," the mother goddess of the pagan world. It is characteristic of pre-Christian paganism that the ark of Mary, whom we might as well call Ishtar, is tacitly assumed to be more powerful than the ark of Michael. It is quite in keeping with the ancient pagan beliefs. The stones which are preserved in the ark of Mary at Axum are undoubtedly of pagan origin, and we may very well assume that Yahveh's ark of the Covenant originally also contained a stone. It is characteristic of ancient times that the ark, or rather the sacred stones preserved in the ark, are not only the representatives of the deity but are assumed to be the deity itself. Thus we read in the Bible (1 Sam. iv. 7) that the Philistines said when the ark of Yahveh reached the camp of Israel, "God is come to the camp." The same words are used of the ark of Mary. When the ark reaches Axum, we read that Satan was just building a house in order to fight God, and the people said: "Mary has come to thee." Thus Satan was obliged to retire from Axum and leave the field to Mary.†

We might add that the legend of the Queen of Sheba is al-

\*Genesis xxxi. 19 ff.

† As to the details we refer the reader to Dr. Littmann's first fascicle of the *Bibliotheca Abessinica*.

luded to in the Koran, Sutra 33, 38. As to different versions of the same legend Dr. Littmann says:

“The reason why the Queen of Sheba travels to Solomon is in almost all the other forms of the legend her desire to test or at least to experience his wisdom, of which she has heard so much spoken. The healing of the Queen from her hairiness is known to the Arabs also, but in the Ethiopian version it is only an episode and of minor importance. Now in the Tigrē legend this is made the main reason: the Queen of Sheba goes to Solomon only to be cured of her ass’s heel. To the minds of a very large class of people all over the world, wisdom, healing-power, and sorcery are nearly synonymous, and driving out the devil of disease—for the diseases are caused by or identical with the demons—is the most palpable proof of wisdom. We need not wonder, therefore, that the simple Abyssinian who told our legend probably considered Solomon only as a great sorcerer, and that the healing-power of this ‘king of all demons’ impressed itself more deeply on the mind of the common people than his intellectual wisdom.”



## THE FALL OF THE TEMPLE.

BY CHARLES KASSEL.

THERE seems deeply rooted in human nature a proneness for ascribing to the wrath of Heaven the misfortunes which befall our enemies,—nay, we even attribute to the avenging lash of Deity the ills which afflict those who merely differ from us in religion. If an angry tide sweeps a city into the sea thousands are ready to deplore the calamity as a visitation of Providence; and if one who has scouted their creed be drowned or mangled, these devout souls, who see the finger of God in every one's woes except their own, readily trace a connection between the scoffer's death and his impiety.

In no historic occurrence, perhaps, has the Christian world discovered so plainly the hand of Providence as in that tragic spectacle which has appealed so strongly to the imaginations of theologians,—the destruction of Jerusalem and the burning of the Temple: a spectacle well calculated to inspire awe, in view of its appalling proportions, its dire consequences to the Israelitish people and its nearness in time to the event which has cast so deep a shadow over the whole field of theologic thought,—the Crucifixion!

It would tax the deftest pen to conjure up before the mind a faithful picture of the Holy City, gleaming with the stately piles which went down in that pageant of blood and fire. Even the proud capital of the Romans—the boast of their poets and orators—shone with a luster less bright. “The whole city,” observes the Reverend Charles Merivale in his *Romans Under the Empire* (Vol. 7, Chapter 59, pp. 229-230, Longmans, Green & Company's edition, 1896), “upon which mighty despots had lavished their wealth, as far surpassed Rome, at least before Nero's restoration, in grandeur, as it fell short of it in size and population.” In the death-grapple between monotheistic Judea and polytheistic Rome all this splendor became a memory and a tale! “The most soul-stirring strug-

gle in all ancient history," exclaims the historian just quoted in describing that mighty conflict; a conflict direr than any of those in which the older temples on Moriah had fallen—direr than any which, during the great Crusades of the Middle Ages, reddened the historic soil of Jerusalem. During five months the remnant of the Jewish nation, gathered from every quarter within the walls, held out against the legions of Titus. All the horrors of sword and flame were let loose upon the city and upon the people. Daily, the corpses of the dead were crimsoned with the blood of the living, while about both fell ruins smouldering from the deadly brands of the besieger. At last, driven inch by inch from the outer precincts, those whom sword and fire and famine had spared took station within the courts of the Temple, resolved that the ancient kingdom should witness its last hour upon the hill which for more than a thousand years had been the seat of its religion and the worshipping place of its priesthood and its people! Here the final scenes of the great siege took place and the souls of thousands rose with the flames which levelled the noble pile to a mass of ruins. The last dread sacrifice had been enacted before the Golden Altar! Tongue and pen and brush have vied with one another in painting the mingled grandeur and horror of the spectacle!

The number of those who fell martyrs to the faith and to the traditions of their people will never be known. The imagination of Josephus, sickened by so much blood and so much suffering, raises the number to more than a million—a figure too vast for belief; but even the conjecture of the most modest historians, who place the number of the dead at far beyond a hundred thousand, makes that disaster one of the awfulest hecatombs in all the annals of war! Even after resistance was wholly at an end, eleven thousand perished from starvation, and of those who remained the old, the sickly and the infirm were put to death and ninety thousand were sent as slaves to labor in the imperial mines or to battle with the wild beasts in the amphitheatres. "The overthrow of Judea, with all the monuments of ancient but still living civilization, was the greatest crime of the conquering republic. It was commenced in wanton aggression and was effected with a barbarity of which no other example occurs in the records of civilization." (Merivale, *Romans Under the Empire*, Vol. 7, Chapter 59, p. 251.)

Thus, as the theologians insist, went out in gloom as a punishment from on high the nation which had held aloft for centuries the torch of religious truth! Even Schaff, in his monumental *History of the Christian Church*, though observing that "history records no

other instance of such obstinate resistance, such desperate bravery and contempt of death," (Vol. I, p. 397) can not refrain the opinion that the fall of the City and of the Temple, and the extinction of the Jewish nation, was but the revenge of an angry God for the rejection of the Christian faith and its founder. "Thus, therefore," he says, "must one of the best Roman emperors execute the long-threatened judgment of God, and the most learned Jew of his time describe it and thereby, without willing or knowing it, bear testimony to the truth of the prophecy and the divinity of Jesus Christ, the rejection of whom brought all this and the subsequent misfortunes upon the apostate race." (Vol. I, p. 379.)

It is as pleasing to fancy that the afflictions of our enemies spring from the judgments of God as it is disagreeable to reflect that our own may flow from the same cause; and the pious theologian may easily fall into the thought that so grave a catastrophe as the destruction of Jerusalem was but a mark of Heaven's anger at the rejection by the Jews of their noblest teacher, even though to reach this conclusion he be forced to assume that the Almighty wrought through a nation which scarcely six years before was regaling its populace with the spectacle of Christian martyrs pitch-smeared and burned by scores to light the gardens of Nero! From the view point, however, of the less sectarian thinker who strives to trace in that epoch the finger of Providence, the events following the holocaust at Jerusalem, far from lending strength to the dogma of the theologians, might well be construed as startling indications of Divine displeasure at the razing of the Holy City and the desecration of the Temple—unless, indeed, we indulge the belief that God punished the Jews through the Romans and then visited dire penalties upon the Romans for punishing the Jews!

For ten years following the destruction of Jerusalem, during which Vespasian wielded the rod of state, Rome enjoyed a period of almost unbroken quiet. "The reign of Vespasian, extending over one decade, passed away in uneventful tranquillity, ruffled only for a moment at the termination of the Jewish war, by one or two arbitrary attempts at usurpation, which were firmly quelled but with no excessive or feverish violence." (Merivale, Vol. 7, Chapter 60, p. 289.) Providence—it might be urged with no mean show of truth—was reserving its wrath until the imperial mantle should fall upon him whose barbarity had drenched Jerusalem in an ocean of blood and whose vandal hand had laid in ruins the majestic Temple of the Jews. It is a remarkable circumstance that during a scant reign

of two years and two months the empire of Titus was visited by a succession of disasters graver than ever befell a people before or since in so brief a period—one of these, at least, without a parallel in all previous history. Vesuvius had slept since the dawn of recorded time. Cities had gathered at its foot, and the people, if they suspected the volcanic nature of the mountain towering near them, deemed its fires long since spent. On the 24th day of August, however, A. D. 79,—but one month and eleven days after the sceptre of Rome had passed into the hands of Titus,—the great catastrophe occurred which buried three Roman cities under a deluge of fire. From out the grim crater, during the eruption, vast columns of lava belched forth, and, spreading fan-like across the sky, fell in deadly showers upon the heads of the fleeing thousands, already maddened with the terror of the spectacle. The awful roar of the angry mountain, the fearful rocking of the earth, the seething and hissing of the sea as the burning skies poured themselves into its depths, must have smitten the doomed multitude with the belief that universal conflagration was at hand! For three days darkness hung like a pall over the desolated cities, broken only by the fierce lightnings that still played about the cone from which all that death and ruin had poured, and the fine volcanic dust which accompanied the eruption and spread over the hemisphere in each direction reddened for months the sun-sets of the world.

This huge disaster, which fills so sombre a page in history, would alone have made the brief reign of Titus the gloomiest in all the chronicles of Rome: but others little less terrible and even more deadly were yet to come. At the capitol a fire burst forth which raged for three days, and, spreading from quarter to quarter, destroyed the fairest structures of the city,—a fire rivaling that of Nero in its proportions. Upon the heels of the fire a pestilence broke out which took off almost as great a number as had the flame and sword of Titus at Jerusalem. But still the anger of God was unappeased. The unfortunate emperor had been preserved through all these calamities that no jot or tittle of their horrors should be lost upon him. Now, fate flung its last curse! A malady, mysterious as it was fatal, began to undermine the health and strength of Titus. “He had tried in vain all the remedies suggested by physicians and afterwards by priests. With superstitious feelings kindled at the Eastern altars he sought to propitiate Heaven by strange rites and sacrifices.” (Merivale, Vol. 7, Chapter 60, p. 300.) But to no avail. He died on the 13th of September, A. D. 81.

Remembering the dire afflictions which Rome suffered during

the interval between the elevation of Titus and his death we can scarcely wonder that the Roman people should have asked one another what crimes their nation had committed that such calamities were visited upon them. The troubled character of that short reign has been the comment of every historian. Even Schaff, but a few lines beyond the passage already quoted, mentions the circumstance. "He ascended the throne," this writer observes, "in 79, the year when the towns of Herculaneum, Stabiae and Pompeii were destroyed. His reign was marked by a series of terrible calamities, among which was a conflagration in Rome which lasted three days, and a plague which destroyed thousands of victims daily." (*History of the Christian Church*, Vol. 1, p. 396, note 1). It did not occur to this complacent theologian, however, to even remotely attribute the "terrible calamities" of Titus' reign to the wrath of Heaven for the saturnalia of butchery and vandalism in the Jewish capital, though so ready to ascribe the fate of Jerusalem to the anger of God with the "apostate race." Merivale, however, though himself an eminent Christian divine, was more fair. "The conqueror of Jerusalem," he says in the fine narrative to which we have so often referred, "learned, perhaps from his intercourse with the Eastern spiritualists, to regard with religious awe the great events in which he had borne a part and to conceive of himself as a special minister of the Divine Judgment. As such he was hailed without hesitation by Orosius, who expounds the course of Providence in Roman affairs from the point of view of the Christians. The closing of Janus on the fall of the Jewish city appears to this writer a counterpart of the announcement of universal peace at the birth of Jesus. He passes lightly over the calamities of Titus' reign, the fire, pestilence and the volcanic eruption, as well as his own premature decease, all of which, had he lifted a hand against the Christians, would have been branded as manifest tokens of Divine vengeance." (*History of the Romans Under the Empire*, Vol. 7, Chapter 60, p. 302.)

All who mingle largely with their kind know how deeply religious faith colors every thought. Few, however, appreciate the powerful influence upon the mind exercised by the belief, when fanatically entertained, that a race or an individual is one against whom the hand of the Eternal is lifted. The outcast from Divine favor becomes in the eyes of the blind zealot an object of hatred and one against whom any crime may be justified; precisely as in the centuries gone, the wild rabble which gathered about the blazing pyre of the heretic thought it no wrong to add to the tortures of the vic-

tim. The psychological importance, therefore, of such a belief is immeasurable.

It would be beside our aim, however, either to deny that Deity hovered with arm outstretched across Jerusalem beckoning Titus onward to his work of death and ruin, or to assert that the Central Power of the Universe stirred the fires of Vesuvius or let loose upon the Romans the genii of fire and pestilence. It has been our purpose merely to show how much broader a basis history affords for the latter than for the former theory, leaving the reader to determine whether either is in truth worthy a large and generous mind. Those whose views have been molded by theology may still cling to the belief that the Maker of all, to revenge the kindly and forgiving Galilean for the fate suffered at the hands of a corrupt priesthood whose prestige and privileges He threatened, brought low with sword and flame the great common people of Judea who "heard Him gladly." The partisans of ancient Israel, on the other hand, who deem the acts of Titus mere wanton ruin and murder, may still see in the catastrophes of his reign unmistakable evidences of divine displeasure. The more thoughtful, however, who refuse to believe that the Creator contrives afflictions to scourge His erring children, will decline to attribute to the anger of God either the horrors that Titus wrought or the horrors that Titus suffered.

## MISCELLANEOUS.

### FINLAND.

Finland is, properly speaking, not a part of the Russian Empire for it is connected with Russia by a personal union only, which means that the Emperor of Russia is the Grand Duke of Finland, and by a special concession which, however, is persistently ignored, the Viceroy of Finland, appointed by the Crown to represent the Emperor, should always be a Finlander, and not a Russian. The inhabitants are a conservative, law-abiding people, but owing to the tyranny of the Russian government there has always been much restlessness in the country and it is natural that at the present time the world takes a greater interest than usual in its destiny.

Prof. N. C. Frederiksen, formerly professor of political economy and finance in the University of Copenhagen, is perhaps the best authority on Finland, its history and present conditions, and we extract here from a book which he has published on the subject, those passages of the first chapter which refer to the population of the country. In another place of the present number we will give a brief synopsis of the book with special reference to the present condition of the Finnish people.

The civilisation of Finland has been mainly under the influence of Scandinavians at the time when they played a prominent part in the history of the world.

"In the latter part of the ninth century, when the other Teutonic races were becoming to some extent less hardy under the influence of the Christian religion and of a more or less centralised Roman government, the Scandinavians conquered and occupied more than half of England, the islands and part of the coast of Scotland, and the harbors and adjacent country in Ireland. They founded a remarkable colony in Iceland, whence, later, Greenland and certain coasts of America ("Vinland the good," as it is called in Icelandic books) were discovered. From Sweden, Scandinavian warriors founded and ruled the states which later developed into the Russian Empire, whence their fleets went down to Constantinople and the Caspian Sea; while at the same time other fleets were descending on the Spanish peninsula, Morocco, and other Mediterranean countries. Indeed the Scandinavian race, always strong in its freedom, became almost irresistible when it had learned the arts of modern warfare from the nations with whom it came into contact. Their most remarkable contribution to mediæval civilisation was Normandy, the colony which they finally formed, after much devastation, and some other more short-lived settlements, on the coast of France. The Franco-Norman

descendants of these colonists not only conquered England, crossed over to Ireland, and organised Scotland, but also, after founding highly-civilised kingdoms in Southern Italy and Sicily, and thence making further conquests in the Balkan peninsula, in Africa, and even in Asia Minor, were the leaders in the greatest and most wonderful movement of mediæval times, the Crusades.

"About a hundred years before the first Scandinavians spread westwards, the Finns had moved into what is now known as Finland. They came from the heart of Russia, where they had been settled north of the central Volga. There were two tribes, differing in physical appearance and mental qualities; one, the slightly darker and more vivacious Carelians of Eastern Finland and of the adjoining parts of Russia as far north as the Gulf of Bothnia; the other the lighter-haired and square-set Tavasts of the West. Living in the south-west corner of Finland were the Finns proper (*egentliga Finnar*), who were closely connected with the Tavasts. More or less related to these tribes were some other Ural-Altaiic tribes, who remained in the interior of Russia, and also some tribes who advanced simultaneously with these others towards the Baltic—the Coures and the Lives (who were related to the Carelians), and the Esthoniens (who were related to the Tavasts and the Finns proper). It has been suggested that the Kajans (*Kainulaiset* in Finnish, *Kvoens* in Norwegian; they are described by Othere, the Norwegian skipper sent northward to explore by Alfred the Great) were another Finnish tribe living in the country, according to the commonly accepted view, before the coming of the Carelians and Tavasts. The name of these Kvæns, which resembles the Swedish *kvinn*a, the Danish-Norwegian *kvinde* or *kvind*, and the English 'queen,' has given rise to numerous myths about a northern nation consisting of Amazons, or at least always governed by a woman. We certainly find this tale several hundreds of years earlier in Tacitus. These Kvæns are now generally supposed to be identical with the Biarmians (the modern Permiens), familiar in the old sagas, and either Carelians, or related to the Carelians.

"Long before these migrations took place, it is certain that southern Finland was inhabited. On the coast and on the navigable rivers, and on that part of the Bothnian coast which is now inhabited by Swedes, we find numerous antiquities of the same kind as are found in western Europe, especially in Scandinavian countries. Many belong to the Later Stone Age, a few belong to the Bronze Age, and a large number to the successive Iron Ages. The most eminent antiquarian authorities have now to some extent modified their old theory of successive immigrations, in which an entire people, using stone implements, was replaced by a population using bronze; or they believe at least that for some thousands of years before Christ a Teutonic race inhabited Germany and the greater part of Scandinavia. It is probable that antiquities, found chiefly in south-western Finland and on the chain of islands which connected Finland with Sweden, really belong to an old Scandinavian race.... Moreover, while a large number of words of Teutonic origin, found in varying numbers in the different Western-Finnish languages, are to some extent borrowed from the Goths (so that it is obvious that somewhere the Finns have been in close relation with the Goths), yet the greater part have been adopted into the Finnish language from the Scandinavian, before the latter was divided into separate languages.

"While the Tavasts and Carelians did not differ greatly at first, and soon



amalgamated in certain parts of the country, the Lapps, or Lapplanders remained an entirely separate race. Their language resembles Finnish, as it does other Ural-Altaic languages; but they themselves are totally different in physical appearance, mental development, and manner of life. They seem to have got their language from their more civilised neighbors. They are Arctic nomads; while the Finns, even when they first came into the country, had domestic animals and some knowledge of agriculture, as may be seen in their old national epics, the Kalevala.

"The Gypsies of Finland are more numerous than the Lapps, but less amenable to control; they came from Sweden in the sixteenth century, and now number nearly two thousand.

"It was the last period of the Crusades which introduced Swedish culture into Finland. In 1006, Olaf Haraldson—St. Olaf, later on a king and popular Saint of Norway—was in southern Finland; and St. Olaf's Saga speaks of old Swedish kings who had power in Finland and Carelia ('Kyrialand'). The 'law-man' Thorgny tells Oluf Stötikonung that the men of Sweden would gladly accompany him to the East, if he would follow the example of his ancestors and go there instead of harrying the Norwegians. Oluf's daughter Ingegerd is finally married to Jaroslav of Russia, and obtains as a dowry Ingermanland, which is governed in her name by her foster-father, Jarl Ragnvald of Westgötland, the friend of the Norwegians.

"The conversion of the Finns, like all other conversions in those days, was chiefly effected by the sword; but there was one great difference between this conquest and those made by the Crusaders in the East, or in north-eastern Germany, or in the Baltic provinces of Russia. This difference lay in the fact that the Swedes were a nation composed of freemen only; like the Danes in northern England three centuries earlier, they were all free cultivators of the soil, and the freedom of the peasants or agricultural population was from the first the basis of the social system in Finland, as it was in all Scandinavian countries.

"Another peculiarity of the conversion of Finland was due to the differences in language. Not only does the upper class generally speak two languages, Swedish and Finnish, but an entirely distinct Swedish population is settled on the coast of the Gulf of Finland in Southern Nyland, from the Kymmene River westwards, and in Finland proper as far as where the mountain-chain separates the southern coast from the west, and on the groups of islands known as the 'skärgård.' On the other hand the western coast of Finland proper has a population chiefly Finnish; while again on the lower and more fertile coasts of Southern Ostrobothnia, as far north as Gamla-Karleby, there is a large Swedish population. The total number of Swedish inhabitants of Finland amounts nearly to one-seventh of the whole population.

"The preservation of the Swedish tongue among the upper classes (who, however, also speak Finnish) has certain disadvantages; but it has this enormous advantage that the Finnish nation, unlike all other Ural-Altaic people except the Hungarians, has thereby participated in Western culture. Not only did the Finns share in Swedish freedom, but together with the Swedes they adopted the religious reformation of the sixteenth century, receiving the education of the Reformed Church, whose schooling has brought about a better understanding of personal responsibility, individual rights, jus-

tice, and humanity. It cannot be denied that the nations which did not accept this change, but remained part of the Roman Catholic Church, or the Greek Orthodox Church with its dead Byzantine forms, have lagged behind in this respect. The upper classes in Finland, like the relatively cosmopolitan Swedes, were also greatly influenced by the period of free-thought and the zeal for national reform and development which marked the close of the eighteenth century.

"Notwithstanding the frequent frosts, the climate of Finland cannot be called unfavorable to agriculture. This is due to the Gulf Stream, which mitigates the rigor of the climate, though not to the same extent as on the Norwegian coast. Finland is also surrounded by the Gulf of Bothnia, the Gulf of Finland, and the Lake of Ladoga, three great reservoirs which retain the warmth of the summer far on into the autumn. The whole country slopes to the south-west, which leaves it exposed mainly to the warmer winds.

"Finland cannot be compared with America. It is still a poor country and backward in many respects. Also its progress is not quite on American lines. Still it reminds us in many ways of the great country which is progressing more rapidly than any other of modern times. Scandinavian emigrants of the peasant class very seldom return to their country with the intention of remaining there; or if they do, they nearly always change their mind and go back to the United States. With the Finlanders it is different, perhaps partly on account of the difference in their language, which makes it less easy for them to amalgamate with the Americans. In the case of the Scandinavians it must be remembered that half the language of America is nearly the same as their own. We are told, however, that the case is the same with the Swedes from Finland; and the reason for the more frequent return of the latter to their native country may very well be that in Finland there are the same opportunities for improvement, cheap land, etc., as in the United States. Even the poverty of Finland reminds us of what has been said about Western America: 'It is not poverty but incipient wealth.' At all events we find in Finland an admirable capacity for improvement. The question still remains whether this will be hampered by unnecessary difficulties coming from political sources."

---

#### BOOK NOTICES.

Mr. Robert Rexdale has published under the title *Rhymes* (Fleming H. Revell Company. Chicago, New York, etc. Price, \$1.00.) a little volume of poetry which shows him to be a thoughtful man with deep poetical sentiments, Lillian Whiting calls him "one of the spontaneous singers," and says, "his work is marked by brilliant and sympathetic power." He inscribes the volume to his child Phyllis, to whom the first poem is dedicated under the title "Where the Green Cicada Sings."

"In your fond eyes, Phyllis dear,  
Shines the June light of the year.

Life's today a garden-close,  
Where the tree of pleasure grows,

And its branches cool and sweet,  
Drop the rich fruit at your feet."

Another poem inscribed "Lines to a Little Boy" reads as follows:

"I wish for thee, my little, prattling boy,  
Life's bravest battle and its fewest scars;  
Such love as shineth in thy mother's joy,  
Lit by the gleam that glorifies the stars!  
E'en all that Heaven can send to make thee great,  
Youth's aspirations and man's grand estate."

Among our Japanese exchanges we have a semi-monthly magazine called *The Student*, which is devoted to the English language and literature. The magazine, as its name indicates, is primarily for the interest of Japanese students who are struggling to master the intricacies of the English tongue. Each number has as a frontispiece the portrait of an English or American man of letters or of some one who has distinguished himself in the promotion of friendly intercourse between the East and the West. Most of the current numbers contain some notes or short articles on the war, which is naturally of the most absorbing interest at present to readers of the paper. Considering all the difficulties under which its Japanese editors are working, *The Student* must be said to be a very creditable magazine. The chief editor is Mr. Inazo Nitobe, author of the *Bushido*, a book published a few years ago in this country, and well known to those who take interest in things Japanese. It depicts the Japanese religio-ethical life which is closely akin to that of knighthood in the Middle Ages of Europe, and explains the inner motive of Japanese soldiers and sailors, whose intense patriotism and reckless bravery in the present war have astonished the world.

The magazine is published by The Student Company, Gobancho, Tokyo, Japan.

T. S.

Hinds, Noble & Eldredge, 31-35 West 15th St., New York City, have published a collection of patriotic songs under the title *Songs of the Flag and Nation*. Like the *Standard Hymnal* of Mr. Converse this collection contains the old classical hymns as well as many modern productions, and the editor, Mr. Walter Howe Jones, says: "We call special attention to this book's large percentage of new and sterling material,—effective solos, inspiring unison songs, stirring odes, massive choruses, selections for special holidays, with its sprinkling of male-voice selections of not too ambitious character. The nucleus of the new material consists of the prize-winners in a competition which we inaugurated in 1903."—It may be interesting to the readers of *The Open Court* to know that two of the songs of the editor, viz., "Unfurl the Flag," composed by Oliver H. P. Smith, and the "American War Song," composed by Robert Goldbeck, have been included in this collection.

Dr. Edward Anthony Spitzka made a special study of Major Powell's brain, and, having enumerated the different points in which it may claim special pre-eminence, says: "Major Powell, geologist, ethnologist, explorer,

philosopher and soldier, was endowed with a superior brain and, what is more, he used it well." Those interested in the details of the investigation will find it published in the *American Anthropologist*, New Series, vol. 5, No. 4, pp. 585-642.

---

*My Little Book of Prayer* by Muriel Strode (published by The Open Court Publishing Co.) is original in its directness and simplicity. It is religious, though neither dogmatic nor orthodox, and its most characteristic feature is the strength which pervades its sentiment. Rarely has there been written a book more wholesome and invigorating than this unpretentious little volume.

---

### THE TEMPTATION OF BUDDHA.

According to the ancient Buddhist traditions Siddhartha Gautama was tempted three times before he attained to Buddhahood. When he left his house, Mara, the Evil One, to whom power is given over the whole material creation, stayed him at the gate, counseling not to resign the world and extending a promise to make him *Chakravarti*, a wheel king, i. e., a monarch to whom dominion is given over the whole earth. But Bodhisattva, the Seeker of Enlightenment, refused the tempter's offer. He went into homelessness to lead a religious life, bent on finding the cause of suffering and a solution of the problem of life.

Following the custom of the day Bodhisattva sought salvation in severe self-mortifications and fasts. His body became emaciated like a withered branch, and when he was on the verge of starvation, the wicked Mara again approached him, saying: "What good is thy exertion? Deign to live, and thou wilt be able to do good works." Bodhisattva answered: "Death in battle is better than to live defeated."

Having attained an insight into the nature of being, and having grasped the concatenation of cause and effect, Bodhisattva was attacked by the Evil One, who sent out against him his army of demons in order to overawe the Blessed One, seated in contemplation under the bodhi-tree, but their arrows were changed into fragrant flowers. Thereupon the three daughters of Mara Lust, Folly, and Envy, came to entice him back to a wordly life by attempts at flattering his vanity and appealing to egotistic satisfaction. But the Buddha remained firm, and his heart could not be moved either by terror or passion. Thus the Bodhisattva, the Seeker for Enlightenment, remained victor, and while Mara with his wicked spirits fled, the earth quaked and the gods shouted for joy.

---

### THE BUDDHA'S HYMN OF VICTORY.

When Buddha had attained enlightenment he uttered the following stanza:

"How many births in transmigration  
Have passed I through but did not find

This house's builder whom I sought,  
And so life's sufferings are renewed.

"But now, house-builder, thou art seen,  
Nor shalt another house thou build me!  
Thy rafters broke, low lies thy gable.  
The transient fades; my heart is free.

The Pāli original reads as follows :

अनेकजातिसंसारं सन्धाविस्सं अनिब्बिसं ।  
गहकारकं गवेसन्तो दुक्खा जाति पुनप्पुनं ॥८॥  
गहकारक ! दिट्ठोऽसि पुन गेहं न काहसि ।  
सब्बा ते फासुका भग्गा गहकूटं विमच्चित्तं ।  
विमच्चारगतं चित्तं तएहानं खयमञ्जगा ॥९॥

Anekajātisamsāram sandhāvissam anibbisam,  
Gahakārka didvo 'si puna geham na kāhasi,

Gahakārakam gavesanto dukkhā jāti punappunam.  
Sabbā te phāsukā bhaggā gahakūtam visankhitam.  
Visankhāragatam cittam tanhānam khayamañjagā.

There is perhaps no Pāli verse which has been more frequently translated. Mr. A. J. Edmunds (*Hymns of the Faith*, p. 38) publishes a literal version.

"Manifold-birth-transmigration  
Have I run through, not finding  
House-maker seeking:  
Painful birth again-again.

"O house-maker! seen art thou,  
Again [a] house not shalt thou make:  
All thy rafters broken, house-peak destroyed;  
Dissolution-gone heart, of thirsts destruction has reached."

The word "dissolution-gone" means literally "apart from Samkhara," and Samkhara is commonly translated by "constituents of being," "compounds of existence," or "confections," the latter being a poor translation of Professor Oldenberg's *Gestaltung*. The term denotes the nature of material, bodily or corporeal things, such as originate by combination and are therefore necessarily subject to dissolution. All that is compound will be dissolved again. Thus the term involves the idea of "transiency," and the word "Samkhara-gone" means an escape from the domain of transiency. The condition of unstability has been abandoned, and eternal peace is gained.

The term translated "thirst" by Mr. Edmunds is the Pāli *Tanha* which means all clinging to existence, desire, egotism, passion, etc.

Mr. Edmunds translates the stanza in verse as follows:

“Many a life to transmigrate,  
 Long quest, no rest, hath been my fate,  
 Tent-designer inquisitive for;  
 Painful birth from state to state.

“Tent-designer! I know thee now;  
 Never again to build art thou:  
 Quite out are all thy joyful fires,  
 Rafter broken and roof-tree gone;  
 Into the Vast my heart goes on,  
 Gains Eternity—dead desires.”

Versions which are frequently quoted have been made by Prof. Rhys Davids in his *Buddhist Birth Stories* and by Henry Warren in his *Buddhism in Translations*. Another version which is little known because the original is still kept in the author's desk and has only been quoted by Mr. Edmunds (*l. c. p. 38*), is Professor Lanman's versification which reads as follows:

“Thro' birth and rebirth's endless round  
 I ran and sought, but never found  
 Who framed and built this house of clay.  
 What misery!—birth for ay and ay!

“O builder! thee at last I see!  
 Ne'er shalt thou build again for me.

“Thy rafters all are broken now,  
 Demolished lies thy ridge-pole, low.

“My heart, demolished too, I ween,  
 An end of all desire has seen.”

We have also attempted to reduce these famous lines to English verses in the following stanza, which, according to the spirit of it, we have set to music in a minor key utilising and adapting for this special purpose a German choral:

“Through many births I sought in vain,  
 The builder of this house of pain;  
 Now, builder, thee I plainly see,  
 This is the last abode for me.  
 Thy gable's yoke, thy rafters broke,  
 My heart has peace, all lust will cease.”

The meaning of the stanza is obvious to those familiar with Buddhist views. Suffering is an indispensable accompaniment of bodily life, and salvation becomes possible only by resigning all attachment to the pleasures of existence and to our own very self. The Buddha's sympathy goes out to all living beings; his interest is no longer centered in himself, for he lives in the whole. So he ceases to be an individual ego and will as such no longer be reborn in this world of suffering. He has entered into Nirvana and when he quits the tabernacle which constitutes his earthly abode, his disciples will not see him again. Forthwith his life will be in the spiritual omnipresence of the Dharma, the good law, the truth, religion.

## KARMA, ANOTHER BUDDHIST SONG.

In addition to the music of "The Hymn of Victory" we publish in the present number a Buddhist song which suggested itself to the author on revising his story *Karma* for a new edition.

The Buddhist theory of ethics is based on Karma, i. e., the law of deeds, which declares that the law of cause and effect holds good in the moral domain as in the physical, we reap what we sow, good deeds do not produce evil, and evil deeds will produce nothing good. The same idea versified reads thus:

"Plain is the law of deeds  
Yet deep, it makes us pause.  
The harvest's like the seeds,  
Results are like their cause,  
Apply thy will  
To noble use.  
Good deeds bring forth no ill,  
Bad deeds naught good produce."

## TWO BUDDHIST SONGS.

## THE HYMN OF VICTORY.

Words by Paul Carus.

After a German choral; adapted by Paul Carus.

*Rit.*

Through many birth's I sought in vain, The builder of this house of pain; Now,  
builder, thee I plainly see, This is the last abode for me. Thy  
gable's yoke, thy rafters broke, My heart has peace, all lust will cease.

The musical score consists of three systems of music. Each system has a vocal line on a treble clef staff and a piano accompaniment on a bass clef staff. The key signature is one flat (B-flat major or D minor), and the time signature is common time (C). The tempo marking 'Rit.' is placed above the first system. The lyrics are written below the vocal line.

## THE LAW OF DEEDS.

Words and Music by Paul Carus.

Plain is the law of deeds, Yet deep it makes us pause; The

har-vest's like the seeds, Re-sults are like the cause; Ap-ply thy will to

no-ble use. Good deeds bring forth no ill, Bad deeds no good pro-duce.

## OUR FRONTISPIECE.

Ednard Biedermann, a German American artist, the same who illustrated *The Chief's Daughter* and *The Crown of Thorns*, has been engaged by The Open Court Publishing Co. to paint a series of Buddhist illustrations in which the typical figure of the Buddha should be presented with due consideration to both, the ancient Buddhist traditions and to the spirit of modern taste so as to create an ideal of the Buddha type that would conform not only with our historical knowledge but also with modern art conceptions.

Mr. Biedermann, who has been educated in Europe and has gone through the most rigorous school of artistic technique, being at the same time well acquainted with the more progressive American thought, seems to be especially adapted for the execution of such work. We present for the present number one of his illustrations, "The Temptation," and shall have it followed by several other pictures of the same kind.

A student of Buddhist art will see at once that Mr. Biedermann has studied and utilised ancient Buddhist art, especially the pictures of "The Temptation" which we find among the frescoes of the Ajanta Caves, and we hope that our readers will appreciate the way in which he has accomplished his task.





THE GANDHARA STATUE. (SECOND CENTURY B. C.)  
Perhaps the most ancient statue of Buddha still in existence.

We have seen the pictures grow under the hands of the artist. When completed, we have kept them for some time and exhibited them to art connoisseurs for criticism, but we must say that the more we and the

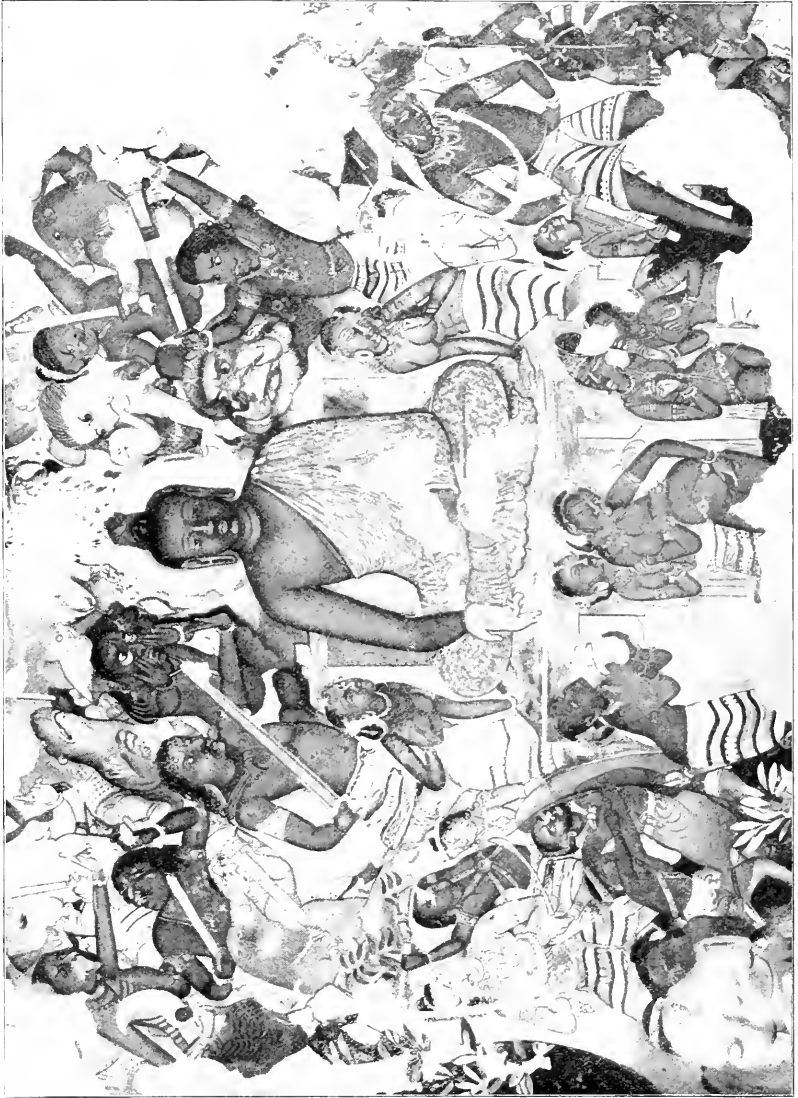

THE TEMPTATION SCENE. (AJANTA FRESCO.)

critics whom we consulted have looked at the originals, the more they have grown upon us, and we feel confident that our readers will go through the same experience and share our views.

## THE SPREAD OF CIVILISATION.

The adjoining pictures, made after photographs taken especially for the purpose of publication by Mrs. Jessie T. Beals, press photographer at the



THE SPREAD OF CIVILISATION—THE TYPEWRITER.

World's Fair in St. Louis, show the spread of civilisation among the Igorotes. They explain themselves, and we have no doubt that the humor displayed in

them will be appreciated by our readers. We intend to publish a short article on the subject with additional pictures in the February number of *The Open Court*.

### THE BEHAIST MOVEMENT.

#### EDITORIAL INTRODUCTION.

We take pleasure in publishing a criticism of our article on the new religious movements of the followers of Beha Ullah by Mr. Arthur Pillsbury



THE SPREAD OF CIVILISATION—THE CAMERA.

Dodge, who is obviously an adherent of Abdul Beha Abbas, also called Abbas Effendi, of Acca. For the benefit of those not familiar with the transcription of Arabic names, we add that "Beha" and "Baha" are the same word, meaning "manifestation" (or "glory"). Further, Beha Ullah is commonly trans-

cribed "Beha 'Ullah," and an adherent of Beha, who according to English custom is called a "Behaist," is frequently styled (after the Arabic mode of speech) a "Behai." We have throughout preferred the simpler English form "Behaist" and avoided any spelling that might be puzzling to the reader.

In reply to my comments on the spelling of "Beha" and "Behaist," Mr. Dodge writes:



THE SPREAD OF CIVILISATION—THE UMBRELLA.

"Originally I employed the spelling 'Beha,' but now always 'Baha,' which I believe to be correct. Count Gobineau's spelling, where the 'e' sound is equivalent to our 'a' is evidently the source of Professor Browne's former practice, but the latter now declares that were he now commencing he should

certainly spell it 'Baha.' This has the same numerical value, of course, as 'Abha,' which forms a part of 'The Greatest Name,' as I will explain in a future treatment. Strictly speaking, I understand that the best English form is 'B'haa,' but practically I prefer 'Baha.' I also prefer 'Bahai' to 'Bahaist,' but recognize your point and do not object in this instance."

Mr. Dodge feels that a historian or literateur is unable to understand the significance of Behaism. He writes:

"I have been an earnest seeker after the truth for many years, dating far back of my first knowledge of this great Bahai Revelation.

"It appears that about all writers have approached the subject with scarcely an adequate apprehension of the vast inner significance and potential value of the proclamation or manifestation of this movement. It was so with Professor Browne, whom, however, I esteem most highly. I passed a few days with him, and a more delightful gentleman I believe I have never met. He writes charmingly of the cause, approaching the matter as he does, and as most writers and historians thus far have, from the view-point of literature-history. Notwithstanding all this, it is apparent that greater justice is being done by current historians than was done in former centuries, when, for instance, such noted historians as Tacitus and others denied Christianity and declared it should be abolished!"

#### THE BAHAI REVELATION.

BY ARTHUR PILLSBURY DODGE.

The interesting article entitled "A New Religion—Babism," by Dr. Paul Carus, the editor, in *The Open Court* of June, 1904, furnishes evidence that the data of information was, as usual, based largely upon the almost universal misconception concerning certain features of this most important subject.

When, however, we consider the fact that Christianity was misapprehended and erroneously represented by the early historians, it is not strange that in this day the reality of the Revelation of Baha 'Ullah should be misconstrued.

Let us start aright. First, the treatment of religion *per se* is usually very unfortunate. From every source we hear of this, or that religion, as though there were *several* religions, when, truly speaking, there never was, and never will be, more than one religion! Let the reader pause and consider before denying this assertion. Religion, in a word, is the truth and knowledge of God. There being One Unchangeable God. His truth must of necessity be and is One and Unchangeable; hence it is impossible that the world has known or can know other than One religion! But it is true that there have been many *revelations* of religion.

The statement that the Bahais "Believe in a personal God and positive revelations" is true, though the words are scarcely adequate. The idea of the human relation of parent and child, as a reflection, is a reasonable indication, in miniature if you please, of the far grander relation. The human being is the *effect* of a *cause*. The "cause" must be greater, but possess all the qualities manifest in the "effect." The human being is the child of God, the Father. The offspring of the human being has to be educated from infancy to maturity. Who can say that the race of mankind, in the broadest sense, does not require education from its infancy to a mature condition?

This being the case, is it not natural and logically correct that the world we inhabit is a vast schoolhouse; the scholars, mankind; the principal, God; and the educators or teachers, the prophets or messengers sent by God during the ages of creation still in process?

In the rise and progress of this great Bahai movement, there was a time when it was properly designated by the word Babism, but that was during the early days of the cause, and prior to 1852. The word Babism was derived from Bab, pronounced as though spelled "Barb" or "Bahb," signifying "gate" or "door."

Mirza Ali Mohammed, signifying Elijah the Prophet, was born at Shiraz, Persia, in the year 1235, A. H., on the first day of Muharram, corresponding to our year 1819, A. D. He arose on the 23d of May, 1844, announcing himself as the one promised by Christ, who would come to herald the appearance of the day of God, and the coming of "Him Whom God shall Manifest" (Baha 'Ullah), to establish the Kingdom of God on earth. He, Ali Mohammed, became known as The Bab, and as such will be referred to hereinafter. It is apparent that Elijah the Prophet, John the Baptist, and The Bab were each, in turn, the recipients and manifestations of the Announcer Spirit to go before the face of the Lord. (See Mal. iv. 5-6; Luke i. 76-7 Rotherham; Matt. xi. 11-14.) Thus it will be seen that The Bab was the mere herald or precursor of the dawning of this great revelation, bearing precisely the same relation to Baha 'Ullah as John the Baptist bore to Jesus Christ 1900 years ago.

Comparatively few fully understand that the Bab literally fulfilled Biblical prophecy, nor do many seem to recognize the logical sequence and inseparableness of all the great prophetic revelations. He came to prepare the way for the coming of the "Great and dreadful day of the Lord" on earth and his appearance was rapidly followed by tens of thousands of believers, drawn from all parts of Persia and elsewhere. The mission of The Bab was concluded on the ninth day of July, A. D., 1850, when he suffered martyrdom, being shot by a company of soldiers. His work was accomplished in a little less than seven years with remarkable humility, patience, love, heroism, and fortitude. The manner of his being murdered was prophesied twelve hundred years before, and prior to the invention of guns and gunpowder! The prophecy was by Mohammed and to the effect that The Bab (Imam Mahdi) would be executed by a pestle issuing forth from a mortar with a loud noise! Considering that this prophecy was made several centuries before the invention of firearms, it was most remarkable.

#### THE PERIOD BETWEEN THE BAB AND BAHÁ 'ULLÁH.

It is true that Subh-i-Ezel, now an exile on the island of Cyprus, was the duly authorized head of the Babis for the short period of time from the martyrdom of The Bab to the appearance and announcement of Baha 'Ullah in 1852. Subh-i-Ezel was a half brother of Baha 'Ullah and was born at Nur, in Mazandaran, Persia.

Baha 'Ullah and The Bab never met. While they were confined in separate prisons, however, they were in communication with each other through the mediumship of Mirza Abdul Karim, known as Mirza Ahmad, the amanuensis of The Bab, and in this way it was arranged that Subh-i-Ezel should be appointed as the temporary successor of The Bab to care for the "friends."

This was done because the time was not then ripe for the Manifestation to declare Himself.

The Bab declared that "He Whom God shall Manifest" was upon the earth and would declare Himself and enter upon His great mission at the proper time, and that this event would occur *within* nineteen years. In his great work, the Beyan, originally regarded as the Babi Bible, The Bab declared that under no circumstances was Subh-i-Ezel to be regarded as the Great One, his mission being only a temporary one and as that of a "blind" and protection of the true One. In the Beyan it is also stated that all of the writings and utterances of its author would not equal in importance one verse of Him that was to come after, that is, "He Whom God shall Manifest."

#### BAHA 'ULLAH, THE MANIFESTATION OF GOD.

The father of Baha 'Ullah, of a house of Persian statesmen, was born in Nur, near Teheran. His illustrious son, Mirza Huseyn Ali, later to be known, in the days of The Bab, as Baha 'Ullah, signifying "The Splendor of God," was born at Teheran, Persia, on November 12, 1817. Before His declaration of His mission He was known as one of the humblest followers of The Bab.

The Bab was uneducated of the world, and Baha 'Ullah was not accounted a learned man, but he was wealthy, possessing an estate valued at more than a million dollars.

In 1852 Baha 'Ullah and His family and the believers were exiled as prisoners to Baghdad, His property first being confiscated by the Persian government. On what ground? Simply this: that His pure Godly life and utterances were too marked in contrast with and offensive to the mullahs or priests and their practices.

But let us quote a few of His own words from *A Traveller's Narrative* by Edward G. Browne, M. A., M. B.:

"We desire but the good of the world and the happiness of the nations yet they, accusing us of stirring up strife, deem us worthy of bondage and banishment.... That all nations should become one in faith and all men as brothers; that the bonds of affection and unity between the sons of men should be strengthened; that diversity of religion should cease, and differences of race be annulled—what harm is there in this?... Yet so it shall be; these fruitless strifes, these ruinous wars shall pass away, and the "Most Great Peace" shall come.... Do not you in Europe need this also? Is not this that which Christ foretold?... Yet do we see your kings and rulers lavishing their treasures more freely on means for the destruction of the human race than on that which would conduce to the happiness of mankind.... These strifes and this bloodshed and discord must cease, and all men be as one kindred and one family.... Let not a man glory in this, that he loves his country; let him rather glory in this that he loves his kind...."

On his arrival at Baghdad in 1852 Baha 'Ullah first made a partial declaration to the believers only, of His mission. Again at Baghdad, in the eleventh or twelfth year of His remaining there, He made the announcement, this time to the believers fully. The second announcement was made in the garden of Najib Pasha, where He tarried about twelve days, just before departing for Constantinople. On His declaration as "He Whom God shall Manifest" the great majority of the believers at once acknowledged Him,



notwithstanding the fact that Subh-i-Ezel had become selfishly and jealously ambitious, seeking with desperation to maintain his claim that he was the one prophesied of to come. Subh-i-Ezel, however, only succeeded in gathering around his standard a comparatively small number of followers, but they gradually became enlightened and left him. At the present time he has but a mere handful of misguided devotees.

When Baha 'Ullah's possessions were confiscated by the Persian government He is reported to have raised His hands and exclaimed: "Praise be to God! I am now free!" It is a noteworthy fact that when Baha 'Ullah took up His Divine Mission there were many times "Ten Thousand Saints or Angels," meaning true and faithful believers, on earth, ready to receive and follow Him. This was fulfilment of the passages in Deut. xxxiii. 2, Isaiah ix. 6-7; Dan. vii. 18, Matt. xxv. 31. 1 Tim. iii. 16, Rev. i. 20, and other prophesies.

The believers in the Orient usually refer to Baha 'Ullah as "The Blessed Perfection."

With His party He remained in Baghdad about twelve years. They were then taken to Constantinople, and from thence to Adrianople, and shortly afterwards to the ancient prison city of Acca (Acre, Akka, Accho, etc.), jutting out into "the tideless sea" at the base of Carmel, the famous "Mountain of God" in Northern Palestine. The evil design since the exile was to rid the world of these saintly, peaceful characters, and in this last move it was the confident belief of the wicked captors that the holy people would suffer speedy death from contact with this old pestilential place, of which it was an old saying, "the foulness was so great that if a bird flew over the city it would fall to earth dead."

The officials were disappointed, for, ever since this imprisonment, conditions have steadily improved, not only in Akka, but in all that region. In this lapse of time it is readily seen that the long suffering holy land desolation has ended, and the promised new order of things in actual restoration is in process.

From this New Holy City in 1867-9 there went forth from Baha 'Ullah those famous "Letters to the Kings" inviting them to a Spiritual Banquet. This was fulfilling the Christ parable of the Great Supper, and though the Manifestation and followers were taken to Akka wholly on the motion of the enemies of God's Cause, the latter were thereby unwittingly fulfilling prophecy of many centuries!

Governors, princes, and other notables learned to humbly bow before Baha 'Ullah, often waiting patiently for an audience.

Some might ask why did He submit to such indignities, persecutions, and sufferings? He was no more obliged to do so than was Jesus Christ compelled to endure outrage, persecution, torture, and crucifixion; save that in both instances these things had to be done, not only to teach the world lessons of humility, patience, meekness, love, courage, and obedience, but that The God Plan should be fulfilled to the very letter as prophesied!

From the foregoing it is clearly erroneous to say: "This Mirza Huseyn Ali (Baha 'Ullah) suddenly came to the conclusion during his stay at Adrianople that he himself was Baha 'Ullah, 'The Glory of God.'" It will be remembered that the announcement was made before Adrianople, or even Constantinople, was reached.

The Mission of this saintly Baha 'Ullah lasted forty years, until His departure on May 28, 1892. He appointed His eldest son, Abbas Effendi, who is now known as Abdul Baha Abbas, to be His successor in charge of the spiritual Kingdom of God on earth.

#### ABDUL BAHÁ ABBAS.

This beautiful, saintly soul, now residing in Akka, Syria, a prisoner through the injustice and fanaticism of the Oriental "divines," in much the same way as was Jesus Christ in his time, is setting the world an example in magnificent love, patience, humility, power, and grandeur of life without a parallel.

Abdul Baha Abbas was born in Teheran, Persia, on May 23, 1844, the very day of the announcement by the Bab of his mission. In this circumstance the future will recognize a remarkable significance.

Abdul Baha signifies "Servant of God," and this he truly is, and is known by his "works." He lives the life, utters the teachings, and is doing the work of the Father where Christ left off nineteen hundred years ago. He is the servant of mankind as well as the servant of God. He was recognized as "The Greatest Branch" by Baha Ullah, who appointed him The Center of The Covenant of God's Religion on Earth; the Commentator of the Books and the one whom all should look up to, emulate and obey in the service of the Kingdom. All of these and other names and titles were *given* to Abdul Baha. He claims literally nothing for himself save being the humble servant of all. In him is fulfilled the Biblical definition of the true *minister*—the servant of all, particularly the needy.

The devotion of Abdul Baha to Baha 'Ullah, the Manifestation of God, the Father, is sublimely indicated in the following few words from his pen: "I swear by the One God, and there is but one, that, had each of us one hundred mouths, and each mouth one hundred tongues, we could not praise God as He should be praised for the great blessing and privilege of being on earth in these days, the greatest days in all the history of the ages. But the world does not realize it. You must not consider the present day, for the blessings are not yet manifest. In the days of Christ, He was despised, cursed and rejected, but after 1900 years people come from half around the world to visit some stones upon which tradition says He once sat! How much greater will these days be when they are once known!"

Abdul Baha is known and often spoken of as "The Master." To enter his presence is to love him and desire to follow his example—providing we really love God. While Baha 'Ullah is the promised "Spirit of Truth," who was to come and furnish the key of explanation of all mysteries in revealed utterances, The Master is giving forth the explanations to the world in lessons of incomparable beauty and value. By carefully reading Daniel xii, Revelation v, Isaiah ix. 6-7 and xxxv, and the Christ parable of the Lord and the vineyard in connection with this article, some idea may be had of the importance of these things.

The year 1844 will be recognized in all time to come as of vast importance. Then was begun the mission of The Bab; then Abdul Baha, the Master, was born, and this year dates the beginning of the remarkable "New Heaven and new earth," the Divine promise of the Christ or Word of God manifested through Saint John, and recorded in the twenty-first chapter of

Revelation. Should any one feel disposed to make light of this matter, such are advised to pause and reflect. It is a most serious matter, the importance of which to all in the world was never before equaled. Regarding the new earth, many changes have occurred within the past sixty years; changes incidental to the marking of a new era.

On the morning of May 24, 1844, Professor Morse took his seat at the telegraphic instrument placed in the Supreme Court room in the Capitol. Many of the chief officers of the Government were present. The Professor pressed the key of the instrument with his finger. In an instant this message was flashed along the wire to Baltimore and back, a distance of eighty miles: "What hath God wrought!" (Numbers xxiii. 23.—Montgomery.) This remarkable incident took place a few hours after the birth of Abdul Baha and the proclamation by The Bab.

In 1843 Professor Morse prophesied the certainty of telegraphic communication across the Atlantic Ocean. This, as well as many other achievements, discoveries, and inventions, has been realized, marking complete revolution in methods of communication, locomotion, in the manner of living generally, etc., all tending to prove the fact of our now having a "New Earth."

Regarding the "New Heaven" it is likewise true that such is rapidly becoming a reality, for the truth of religion is already supplanting the colossal error of past superstition and imagination. Heaven indicates the religion or truth of God. Christ said, "Behold, the Kingdom of God is within you!" (Luke xvii 21.)

Another great work of importance was inaugurated in 1844, when Layard commenced explorations which have, from that time to the present, revealed in antique remains such wonderful corroborative proof of Biblical record.

There are many mistaken ideas concerning the Revelation of Baha and of other Revelations. While true, of course, it is not sufficient to state that Bahaism is the reformation of Mohammedanism. All Revelation has been successively greater in extent of promulgation than was formerly manifested. Judaism, Christianity, and Mohammedanism, each prophesied of and led up to the Revelation of Baha 'Ullah for the reformation of the entire world. All former manifestations were much less in broadness of scope and effectiveness, and quite naturally when we grasp, for instance the marvellous significance of the parabolic utterances of Jesus Christ. Although this last revelation is the greatest, all the prior revelations, as has been truly said, are practically the same—as far as they go. The essence of all is, "Love the good God and be good."

The Bahai Revelation, as before stated, is the grand culmination, the sum total of all that has gone before. It is the sublime climax of all that Christ stood for. It is the veritable inauguration of the "Day of Most Great Peace," realizing the "Unity and solidarity of mankind." It is the first in the world history to unite the people of every race, of every nation, into one belief and faith, one brotherhood of man under the Fatherhood of the One God.

How do we know this? Because, first: The Manifestation has so declared, and in every time of Revelation the word of the prophet or messenger has invariably been found to be the greatest power of truth and authority in the world. Second: The character of the life, works, and teachings of

Baha 'Ullah and Abdul Baha proclaim their divine origin and authority Third: "Ye shall be known by your works," and the irrefutable fact is that there are now more than nine millions of united believers gathered from Buddhists, Zoroastrians, Jews, Christians, Mohammedans, and other faiths, presenting to the world a spectacle as new as grand.

At each time respectively when Moses, Christ, and Mohammed appeared, the vast majority of mankind were doubters and deniers, but from this distant view-point it is readily seen that the prophets were right and the world wrong. The people could not then see it, but we now realize that those and other prophets or messengers carried with them the stamp of genuineness, and represented the Invincible Truth and Power of God. Shall we profit by the blunders of former ages?

All great epoch-making teachings have been departed from as time has elapsed. If Mohammedanism is, as observed, wholly unlike the precepts enunciated by its founder, can anything better be said respecting "Christianity" in its present deplorable state of departure from the Christ standard? The Jews erred greatly in denying Christ, but have not the Christians offended even more seriously in rejecting a later prophet—Mohammed, whom Christ foretold? By what right do the descendents of certain races ascribe to themselves the lordship of the earth, ignoring the fact that all human beings, in every part of the world, are children of One Father? By what right have the creatures of God decided whom of His teachers to accept and whom to reject?

"Do you know why We created you from one clay? That no one should glorify himself over the other. Always be mindful of how you were created, for as We created you from one substance, you must be as one soul, walking on the same feet, eating with one mouth, and living in one land, that you may be able to show from your being and your deeds and actions the signs of the unity and the essence of abstraction..." (Baha 'Ullah.)

At the present time there are several false Christs in the world—people who are vain or misguided enough to claim the divine station of Messiahship. It is understood that there are six or seven of these claimants, and it is self-evident that if any one of them were genuine, the others must be false.

The significant point of the matter, however, is this: that no one can put forth such a claim without at the same time and thereby proclaiming himself an impostor! This is apparent from the words of Christ, for He said He would come like a thief in the night (Rev. xvi. 15), that is to say, in a manner unexpected and surprising. He also declared: "Beware of false prophets which come to you in sheep's clothing, but inwardly they are ravening wolves. Ye shall know them *by their fruits.*" (Matt. vii. 15-16.) Read His warning (Matt. xxiv) against those who would falsely come in His Name.

When Christ propounded this question to his disciples: "But whom do you say that I am?" Simon Peter replied: "Thou art Christ, the Son of the of the living God!" Jesus Christ answered: "Blessed art thou, Simon Bar-Jona: because flesh and blood hath not revealed it to thee, but My Father who is in heaven." (Matt. xvi. 16.)

The world now has before it, nearly twenty centuries after Christ, the magnificent spectacle of one residing in the New Holy City, who claims absolutely nothing for himself other than being the humble servant of God

and of humanity, but who is doing the works and living that sort of life that has alone impelled millions of people of every nation, religious faith, and belief of the world to arise and declare, as did Peter of old, "Thou art Christ (the Word or Spirit of Truth from God), the Son of the living God!"

While most people who go into the presence of Abdul Baha, the Master, feel in their hearts the sentiments Peter expressed, still there are some who do not, but this is certain that all, so far as the knowledge of the writer extends, admit that He continually urges everybody to love and serve God and all mankind, and that he, himself, lives a humble, merciful, sacrificing, loving serving life of incomparable devotion.

In conclusion let us quote a few of his words: "I have sacrificed my soul, spirit, life, mention, honor, attributes, my comfort and my name in the Path of God, and I have chosen no dignity or possession save the obedience of Baha, and no name or title save Abdul Baha—servant of Baha. Therefore be content with this and follow me in my words and wishes, because in so doing the Blessed Trees of life, springing up in the Paradise of God, will grow and become verdant.

"If you desire to speak in praise, praise the beauty of El Abha; if you desire to commend, commend the Name of your Supreme Lord; for if you exalt the 'Tree' you also exalt the 'Branch'! If you mention the sea you also mention its gulfs and bays (for they belong to it), therefore mention the Beauty of Abha!" (Part of a Tablet to an American believer from Abdul Baha Abbas.)

---

#### BOOK REVIEWS.

FINLAND. Its Public and Private Economy. By *N. C. Frederiksen*, formerly Professor of Political Economy and Finance in the University of Copenhagen. London: Edward Arnold. 1902. Pages, xi, 306.

Professor Frederiksen reviews here in the short space of three hundred pages the conditions of Finland. The Table of Contents is as follows: (I) Peculiarities of Finnish Civilisation; (II) The Agricultural Classes; (III) The Land Laws of Finland; (IV) Methods and Conditions of Agriculture; (V) Forestry; (VI) Mining and Manufacture; (VII) Commerce, Navigation, and Fisheries; (VIII) Money and Banking; (IX) Means of Communication; (X) Exchequer and Civic Duties; (XI) The Government of Finland and Its Future.

To us the last chapter is of special importance. Professor Frederiksen explains the constitution of Finland which in spite of several anomalies works relatively well: "The Senate has two sections, the Economic Department, which coincides with the Cabinet or Ministry of other countries; and the Judicial Department, which is mainly a Supreme Court. Only in a few affairs, such as when laws are prepared, do the two sections take counsel together. This peculiar arrangement is no great disadvantage to the country."

Professor Frederiksen continues: "The greatest practical defect in the organisation of the government is its connection with the Emperor, the medium between whom and his Finnish Cabinet is the Governor-General, and more particularly the Minister-Secretary of State in St. Petersburg—the latter of whom no longer has a committee for Finnish affairs at his side as

formerly, and for the moment is not even as formerly, and as he ought to be according to the law, a Finlander."

The large mass of the people are Lutherans, and the Lutheran Church has a great influence upon public opinion. The Greek orthodox church is very limited, but the contribution paid to it by the government is very considerable and far too much in proportion to the small number of its adherents. Public education is not enforced by law, one reason for which consists in the fact that the estates of Finland hesitate to put education and with it national life into the hands of the public authorities. However, since in the Finnish Lutheran Church no one can be confirmed unless he is able to read and write, and consequently no Lutheran can marry if he remains illiterate, the standard is not noticeably lower than in other Protestant countries. The result, however, is that in some few cases young Lutherans who did not acquire the art of reading, are said to have joined the Greek orthodox Church because the latter does not make the educational test a condition for marriage.

Professor Frederiksen resents mainly the efforts of the government to Russianise the country. He says: "To make the Russian the official language for the higher administration, as has now been ordered, is, on the other hand, not only against the present law, but is unnecessary, unjust, and a hurtful and detrimental burden on the people. In reality there is no Russian population in Finland. Of a total of 2,700,000 persons there are 8,000 of whom Russian is the native tongue. To Russianise a people who are so advanced in civilisation and education as the Finns is of course an utter impossibility in our times; but that a part of the people, and especially of the educated classes, should be obliged to use the Russian language without any necessity, and without thereby obtaining the least good, is intolerable and so much the less tolerable because the country has already two languages (and languages so fundamentally different as Finnish and Swedish) which all educated persons must learn and use.

"As regards the present situation, we are compelled to ask, not only what good the government might do, but also what power of resistance the people have against its evil acts. In some respects the people had no need of modern arts to be able to resist. This is the case where it is a question of the conservation of nationality, and especially of language. It has been well said that the Finns, who for more than seven hundred years have not been made Swedish, during centuries when progress was much slower, and when the liberal character of the Swedish government did not provoke any great resistance, have no need to fear being Russianised. Much intellectual national life will continue, notwithstanding all that may be done by the rulers. And to quell a national life, intellectual and economic, such as is now found in Finland, is an utter impossibility."

Professor Frederiksen concludes his book with these remarks: "The people may suffer but they will not submit, and it seems impossible that the proceedings taken by some of the rulers in St. Petersburg can be continued, and that the Russian bureaucracy can be allowed to destroy its weaker but more successful neighbor. We would rather suppose that the supreme rulers will at last listen to the demand of law, justice, and wisdom; since it is evident that nobody, least of all the Russian people, would gain profit or honor by breaking the law and oppressing the honest Finnish nation."

# Important Publications

For the Study of

## RELIGION

---

---

**The Gods of the Egyptians; or Studies in Egyptian Mythology.**

By E. A. Wallis Budge. Two vols. Royal 8vo. Cloth, \$20.00 net.

**The Book of the Dead.** By E. A. Wallis Budge. Three vols. \$3.75 net.

**The Gathas of Zarathushtra (Zoroaster) in Metre and Rhythm.**

Second edition of the author's version of 1892-4. With important additions by Lawrence H. Mills. 8vo., Cloth \$2.00.

**Babel and Bible.** Two lectures on the Significance of Assyriological Research for Religion; embodying the Most Important Criticisms and the Author's Replies. By Dr. Friedrich Delitzsch. Complete Edition, bound, 75 cents.

**The Age of Christ.** A Brief Review of the Conditions Under which Christianity Originated. By Dr. Paul Carus. Pp. 34. Price, paper, 15 cents net.

**The Canon of Reason and Virtue (Lao-Tze's Tao Teh King).** Translated into English from the Chinese by Dr. Paul Carus. Separate reprint from the translator's larger work. Pp. 47. Paper, 25 cents.

**Lao-Tze's Tao-Teh-King, Chinese-English.** With Introduction, Transliteration and Notes. By Dr. Paul Carus. Pp. 345, Price \$3.00 (15s).

**The Creation Story of Genesis I.** By Dr. Hugo Radau. 75 cents (3s. 6d.).

**Biblical Love-Ditties.** A Critical Interpretation, and Translation, of the Song of Solomon. By Paul Haupt. Price 5 cents (3d.).

**The Mysteries of Mithra.** History of their Origin, their Dissemination and Influence in the Roman Empire. Illustrated. By Franz Cumont. Cloth, \$1.50.

**The Prophets of Israel.** By Prof. Carl Heinrich Cornill. Fifth edition, Cloth, \$1.00 net (5s.). Paper 25c.

**History of the People of Israel.** By Prof. Carl Heinrich Cornill, of the University of Breslau, Germany. Cloth, \$1.50 (7s 6d.). German Edition \$2.00.

**The Legends of Genesis.** By Dr. Hermann Gunkel. Cloth, \$1.00 net (4s 6d net.)

**Thoughts on Religion.** By G. J. Romanes. Cloth, net, \$1.25.

*For further particulars write for Catalogue.*

**The Open Court Publishing Co.**

1322-1328 Wabash Ave., CHICAGO.

# THE BOOK OF THE DEAD

By E. A. WALLIS BUDGE. Three Vols. Price, \$3.75 net.

"Very timely and will be received with delight in many quarters. . . . We congratulate all interested in Egyptian literature upon the opportunity of securing at least this intensely interesting and valuable memorial of the religious beliefs of a great and a vanished people."—*Seminary Magazine*.

"A reprint in handy form of the third volume of Dr. Budge's elaborate edition of the Book of the Dead. The learned world is by this time pretty well agreed as to the value of this translation, and one can only express gratitude to the publishers for bringing it within the reach of many whom the high price of the former volume would have prevented from possessing it."—*American Journal of Theology*.

"Everything has been done here to present to the English reader the Egyptian funeral texts in a complete and thoroughly intelligible form: and all but specialists on Egyptian studies will find it to their profit to procure the present admirable edition"—*Presbyterian and Reformed Review*.

THE OPEN COURT PUBLISHING CO., CHICAGO, 1322 Wabash Ave.

LONDON: Kegan Paul, Trench, Trübner & Co.

## A History of Egypt

From the End of the Neolithic Period to the Death of Cleopatra VII., B. C. 30. By E. A. WALLIS BUDGE, M.A., Litt.D., D.Litt. Keeper of the Egyptian and Assyrian Antiquities in the British Museum. Richly Illustrated. In 8 volumes, cloth, \$1.25 each.

**Vol. I. Egypt in the Neolithic and Archaic Period.**

**Vol. II. Egypt under the Great Pyramid Builders.**

**Vol. III. Egypt under the Amenembats and Hyksos.**

**Vol. IV. Egypt and Her Asiatic Empire.**

**Vol. V. Egypt under Rameses the Great.**

**Vol. VI. Egypt under the Priest Kings and Tanites and Nubians.**

**Vol. VII. Egypt under the Saites, Persians and Ptolemies.**

**Vol. VIII. Egypt under the Ptolemies and Cleopatra VII.**

"The publication of this work, certainly the most complete and exhaustive English history of the Egyptian Kingdom from the earliest times which we possess, may be said without undue eulogy to mark an epoch in Egyptological studies in this country."—*Glasgow Herald*.

"In these volumes we have a graphic history of the period written from a careful study of their monumental records that have survived the downfall of the nation. They are indispensable to the student of those ancient times, and will make the history of the Old Testament seem more real."—*Syracuse Messenger*.

THE OPEN COURT PUBLISHING CO., CHICAGO, 1322 Wabash Ave.



# THE JAPANESE FLORAL CALENDAR

By ERNEST W. CLEMENT, M. A.



BLOOMING CHERRY TREES AT ASUKAYAMA, TOKYO

Printed on Best Paper. Profusely Illustrated. Sixty Pages. Board  
Cover with Cloth Back. Octavo. Price 50 Cents (2s. 6d.)

---

Chicago  
The Open Court Publishing Company  
1322 Wabash Avenue

---

London Agents  
Kegan Paul, Trench, Trubner & Co., Ltd.  
1905

# The Open Court

An Illustrated Monthly Magazine

Devoted to the Science of Religion, The Religion of Science  
and the Extension of the Religious Parliament Idea.

Science is slowly but surely transforming the world.

Science is knowledge verified; it is Truth proved; and Truth will always conquer in the end.

The power of Science is irresistible.

Science is the still small voice; it is not profane, it is sacred; it is not human, it is superhuman; Science is a divine revelation.

Convinced of the religious significance of Science, *The Open Court* believes that there is a holiness in scientific truth which is not as yet recognised in its full significance either by scientists or religious leaders. The scientific spirit, if it but be a genuine devotion to Truth, contains a remedy for many ills; it leads the way of conservative progress and comes not to destroy but to fulfil.

*The Open Court* on the one hand is devoted to the *Science of Religion*; it investigates the religious problems in the domain of philosophy, psychology, and history; and on the other hand advocates the *Religion of Science*. It believes that Science can work out a reform within the Churches that will preserve of religion all that is true, and good, and wholesome.

**Illustrated Catalogue and sample copies free.**

---

---

## SUBSCRIPTION FORM

To *THE OPEN COURT PUBLISHING CO.*

*1322-1328 Wabash Ave., Chicago, Ill.*

Gentlemen,—

Please send *THE OPEN COURT* for.....year....

beginning with.....190...to the address given below.

I enclose.....for \$.....

Signature.....

Address.....

Date.....

# THE MONIST

*The Monist* is a Quarterly Magazine, devoted to the Philosophy of Science. Each copy contains 160 pages; original articles, correspondence from foreign countries, discussions, and book reviews.

## **The Monist Advocates the Philosophy of Science**

which is an application of the scientific method to philosophy.

The old philosophical systems were mere air-castles (constructions of abstract theories,) built in the realm of pure thought. The Philosophy of Science is a systematisation of positive facts; it takes experience as its foundation, and uses the systematised formal relations of experience (mathematics, logic, etc.) as its method. It is opposed on the one hand to the dogmatism of groundless *a priori* assumptions, and on the other hand to the scepticism of negation which finds expression in the agnostic tendencies of to-day.

### **Monism Means a Unitary World-Conception**

There may be different aspects and even contrasts, diverse views and opposite standpoints, but there can never be contradiction in truth.

Monism is not a one-substance theory, be it materialistic or spiritualistic or agnostic; it means simply and solely *consistency*.

All truths form one consistent system, and any dualism of irreconcilable statements indicates that there is a problem to be solved; there must be fault somewhere either in our reasoning or in our knowledge of facts. Science always implies Monism, i. e., a unitary world conception.

*Illustrated Catalogue and sample copies free.*

## SUBSCRIPTION FORM

To THE OPEN COURT PUBLISHING CO.

1322-1328 Wabash Ave., Chicago, Ill.

Gentlemen,—

Please send THE MONIST for.....year...., beginning with..... to the address given below.

I enclose..... for \$.....

Signature.....

Address.....

Date.....

# Two New Books by Prof. Starr

---

## Readings From Modern Mexican Authors

By Frederick Starr, of the University of Chicago. Pages 122, profusely illustrated, cloth, price \$1.25 net.

"The scheme of this book is unique and the range extensive. The author enters every field of Mexican literary work, introducing us to writers on geographical, historical, biographical, literary, and dramatic subjects; in fact, covering the whole field of literary life in Mexico. The excerpts from the works of the various authors discussed are such that the idea gained is exact and comprehensive."

—*Public Opinion*, New York.

"It is Mexico in life, thought and coloring."—*Boston Herald*.

"Perhaps nothing is more noticeable in these selections than the power of vivid description and graphic, not to say sensational, narrative."

—*Chicago Evening Post*.

"It is a volume that will introduce most American readers into a new and interesting field."—*Boston Courier*.

"It is a strange fact that the mass of our people know less of our next door neighbors than of almost any one of the European peoples and know next to nothing of their men of letters."—*Chicago Chronicle*.

## The Ainu Group at the St. Louis Exposition

By Frederick Starr of the University of Chicago. Pages iv-118, many illustrations, boards. Price 75c net (3s. 6d. net)

"The Ainu are the aboriginal population of Japan, standing to the Japanese as our Indians do to us. They differ from the Japanese in physical type, in character in language, in life profoundly. The "Hairy Ainu" as they are often called, are people of light skin, wavy hair, hairy bodies, heavy beards, horizontal eyes, Caucasian features—in other words they are whites. Here we have an ancient white race of Eastern Asia, losing ground and failing in life's struggle before a more aggressive, active and vital yellow race. The thought is one of startling interest and significance. The customs and life of this curious people, unlike anything else that is generally known—their houses, dress, customs, bear feast, religious practices, are all touched upon in Prof. Starr's book. While apparently a book of the moment, it has permanent value and interest."

"Altho the book is neither large nor profound, anything is of interest concerning the obscure family of the white race which has fallen a victim to the "Yellow Peril."—*The Independent*.

"For one thing he has the courage to impeach the reliability of A. Henry Savage-Landor whose romancing is swallowed by so many Americans without even the saving grain of salt. The book is profusely illustrated, text and pictures being in strict accord, which does not always happen."—*The Advance*, Chicago.

"His experience in such work and his trained scientific powers make it of more value than might be imagined from its small compass and the short time devoted to gathering the material. He hazards no generalizations and confines himself almost entirely to a record of actual observations."—*Public Opinion*, New York.

"A valuable contribution to the literature of comparative ethnology, well illustrated from many photographs."—*The Outlook*.

"It is of inestimable value that the story has been so well told, and is so beautifully illustrated."—*Journal of Education*.

---

The Open Court Publishing Company, 1322 Wabash Avenue, Chicago

# New Publications

---

## St. Anselm's Proslogium, Monologium, An Appendix in Behalf of the Fool, by Gaunilon, and Cur Deus Homo

Translated from the Latin by Sidney Norton Deane. Pp. xxxv, 288, cloth \$1.00 net; paper 50c.

"The publishers of this volume have done a useful thing in giving us a modern English version of Anselm's most important philosophical writings; it is singular the thing has not been done long since. The Ontological argument is so much talked about, even in elementary philosophical teaching, that the text of it should be made accessible to all students and to the general reader."—*Philosophical Review*.

"This book is the ninth of the series of Philosophical Classics published by the Open Court Publishing Company. Among the previous publications are such epoch-making works as the 'Discourse on Method,' by Descartes; the 'Inquiry Concerning Human Understanding,' by Hume; Leibnitz's 'Metaphysics' and Kant's 'Prolegomena.' For the study of philosophy from the sources by the college student or the graduate we know of no more helpful publications than these. They are well translated, prepared in a cheap yet attractive form. In the work before us we have a translation of Anselm's greatest writings. A study of them is indispensable for the understanding of Medieval theology and philosophy. \* \* \* No one has a right to accept or reject with authority the Anselmic theory of the Atonement if he has not read Anselm's own exposition of it. Otherwise we would fall into blind traditionalism or into irrational radicalism. The spirit of the age demands a consultation of the sources. These publications make the leading sources easily accessible to all English readers. For the college, for the theological seminary, and the student in general, this volume will throw more light on a particular period in the history of philosophy than many histories of philosophy."—*Princeton Theological Review*.

## Ants and Some Other Insects

By Dr. August Forel, late Professor of Psychiatry, at the University of Zurich. Pages 49. Paper, price 50 cents.

\* \* \* "discusses learnedly yet clearly many complicated questions about the absorbing subject of the ant-mind."—*Boston Courier*.

## Hadley Ballads

By Julia Taft Bayne, 51 pages, boards, price, \$0.75 net.

"'Hadley Ballads,' by Julia Taft Bayne, consists of a dainty little collection of poems that have appeared at different times in the Springfield Republican, St. Nicholas, Youth's Companion, and the Independent. The first one in the book, 'The Hadley Weathercock,' is a real poem possessing a rare merit that does not often appear in the verse written nowadays."—*Advance*, Chicago.

# NEW EDITIONS IN THE Religion of Science Library

---

## The Nature of the State

By Dr. Paul Carus, second edition, 104 pages, price 20 cents.

"Dr. Paul Carus has issued a second edition of his pamphlet on 'The Nature of the State.' In the various chapters he treats of sociological and statecraft problems, such as 'The State a Product of Natural Growth,' 'The Modern State,' 'The Right to Revolution,' 'Treason and Reform.' This is a thoughtful little work, one that will be read with interest by the philosophically inclined. The author's dictum on treason and revolution is interesting. He says treason exists for the purpose of tearing down without any high aim in view; revolution he defines as overturning the existing order of things for the purpose of putting into effect a higher moral concept. Much that the world calls treason the writer classifies as revolution and he defends the right of the people to revolt."—*Los Angeles Express*.

"Dr. Paul Carus has also reprinted his 'Nature of the State,' which originally appeared in 1894, at the time that various strikes drew attention to the fundamental principles challenged both by the union and by anarchy. It is an application of Bluntchli's view of the state and embalms the inaccurate story in regard to Bendetti's insult to the Emperor William, then King of Prussia, which Bismarck set afloat for his own purposes, but which survives in spite of repeated contradictions by Bendetti and everyone else concerned. Until Bismarck's statement of the affair appeared the old King never knew he had been insulted."—*Philadelphia Press*.

"'The Nature of the State,' by Dr. Paul Carus, is a publication, No. 7, in the Religion of Science Library, that aims to describe the nature and the development of the State; and a correct comprehension of many leading problems is herewith offered in this author's well known introspective and masterly style."—*Boston Courier*.

"The purpose of the little work is to explain the nature of the state and also of corporations and their relations to each other."—*Boston Herald*.

"The matter is of vital interest at the present moment."—*The Toledo Blade*.

## Kant and Spencer

By Dr. Paul Carus, paper, second edition, 104 pages, price 20 cents.

"It is one of the many analyses of Spencer's failure ever to understand some of the subjects to which he devoted his life."—*Philadelphia Press*.

## Fundamental Problems

By Dr. Paul Carus, third edition, pages 373, cloth, price \$1.50.

"Dr. Paul Carus has done a useful service, both to his many readers and those that are interested, not merely in systematic thought but in systematic discussion, by gathering into a single volume 'Fundamental Problems.'"

"The work deserves the second edition which it has just received, and will furnish any one with summer reading of an agreeable and stimulating character."—*Philadelphia Press*.

"This celebrated book, whose sub-title is a 'Method of Philosophy as a Systematic Arrangement of Knowledge,' has passed into a third edition. It is too well known to students of Philosophy to call for further mention."—*Cumberland Presbyterian*.

The  
**Blickensderfer**  
**Typewriter**

Sold all over the world  
 Price low, but quality  
 high

See "The Spread of Civilization"  
 page 53 of this issue

**Blickensderfer Manufg. Co.**  
 O. T. Owen, Manager  
 227 Dearborn Street Chicago, Illinois

**The Soul of Man**

An Investigation of the  
 Facts of Physiological  
 and Experimental Psy-  
 chology. By DR. PAUL  
 CARUS . . . . .

**Second, Revised Edition.**

With an Appendix on  
 the latest researches in  
 Physiology. 182 Dia-  
 grams. Pp., 482. Price,  
 Cloth, \$1.50 (6s.) net.

**The Open Court Pub. Co., Chicago**

**Come for Health**

rest, recuperation — for pleas-  
 ure, pure air and the world's  
 best medicinal waters to

**French Lick**  
**West Baden**  
**Springs**

The ideal health resorts for the  
 tired and ailing. A short stay  
 at one of their superb hotels  
 and the use of the waters will  
 renew your health, fortify you  
 against disease. These health  
 waters are unequaled in the  
 treatment of liver, kidney, and  
 stomach disorders.

The twin resorts are delight-  
 fully situated in Southern In-  
 diana, on the



*Write for Illustrated Booklet, giv-  
 ing full particulars, hotel rates, etc.*

CHAS. H. ROCKWELL  
 Traffic Manager

FRANK J. REED  
 Gen'l Pass. Agent

CHICAGO



**A GOOD GUIDE**

FOR THE PURCHASE OF A FIREARM is our elaborately  
 illustrated 120 page STEVENS BOOK. This manual of  
 ready reference describes the most complete and varied  
 line of single shot

**Rifles      Pistols      Shotguns**  
 etc., the output of one manufacturer.

From the STEVENS-Maynard, Jr. rifle of the boy shoot-  
 er, to the heavy, fancy Stevens target rifles of the world's  
 champion shots, the identical high standard of excellence  
 is rigidly maintained.

**STEVENS FIREARMS**

are sold by all sporting goods and hardware dealers.  
 Ask them for our make—instant on getting it. Don't be  
 put off with something "just as good." The fact that  
 Stevens Arms are **GUARANTEED FOR QUALITY**  
 should prompt you to be sure to specify this time-  
 honored brand.

Send two 2c. stamps for Stevens Book and Rifle Puzzle.

**J. STEVENS ARMS & TOOL CO.**  
 P. O. Box 4091  
 Chicopee Falls, Mass., U. S. A.

# THE TRAVELS IN Tartary, Thibet and China

of MM. HUC AND GABET

100 Illustrations. 688 Pages.

CLOTH, 2 Vols., \$2.00 (10s.)—Same, 1 Vol., \$1.25, Net (5s. net.)

READ THE FOLLOWING COMMENDATORY NOTICES:

"For forty years it has been one of the world's greatest books."—*Western Christian Advocate*.

"A treasury of information for the student of comparative religion, ethnology, geography and natural history."—*The Outlook*.

"The work made a profound sensation. Although China and the other countries of the Orient have been opened to foreigners in larger measure in recent years, few observers as keen and as well qualified to put their observations in finished form have appeared, and M. Huc's story remains among the best sources of information concerning the Thibetans and Mongolians."—*The Watchman*.

"These reprints ought to have a large sale. It would be a good time for the Catholic libraries to add them to their stock of works on travel. They will find that few books will have more readers than the missionary adventures of Abbe Huc and his no less daring companion."—*The Catholic News*

"Our readers will remember the attempt of Mr. A. Henry Savage Landor, the explorer, to explore the mysteries of the holy city of L'hassa, in Thibet. The narrative of the frightful tortures he suffered when the Thibetans penetrated his disguise, has been told by Mr. Landor himself. But where Mr. Landor failed, two very clever French missionaries succeeded. Father Huc and Father Gabet, disguised as Lamas, entered the sacred city, and for the first time the eyes of civilized men beheld the shocking religious ceremonies of L'hassa."—*New York Journal*.

"Fools, it is known, dash in where angels fear to tread, and there are also instances of missionaries dashing in where intrepid and experienced travelers fail. Such was the case with MM. Huc and Gabet, the two mild and modest French priests who, fifty years ago, without fuss, steadily made their untortured way from China across Thibet and entered L'hassa with the message of Christianity on their lips. It is true that they were not allowed to stay there as long as they had hoped, but they were in the Forbidden Land and the Sacred City for a sufficient time to gather enough facts to make an interesting and very valuable book, which on its appearance in the forties (both in France and England) fascinated our fathers much in the way that the writings of Nansen and Stanley have fascinated us. To all readers of Mr. Landor's new book who wish to supplement the information concerning the Forbidden Land there given, we can recommend the work of M. Huc. Time cannot mar the interest of his and M. Gabet's daring and successful enterprise."—*The Academy London*.

**THE OPEN COURT PUBLISHING CO.**

1322-1328 Wabash Ave., CHICAGO, ILL.

London: Kegan Paul, Trench, Trübner & Co.



# A Missionary Move

---

**S**END us your subscription within two weeks after you receive this offer, and we will present you, gratis, a leather-bound, silk-lined Roycroft book, the price of which is Two Dollars.

This is the offer:—Remit us Two Dollars and we will send you the *Philistine* magazine for a year, *Little Journeys* for 1905, beginning with the January number, also one Two-Dollar Roycroft book—all for Two Dollars. The *Little Journeys*, for 1905, by Elbert Hubbard will be “To the Homes of Great Scientists,” and the Subjects are as follows:

COPERNICUS  
GALILEO  
SIR ISAAC NEWTON  
HUMBOLDT

SIR WM. H. HERSCHEL  
CHARLES R. DARWIN  
ERNST H. HAECKEL  
CARL VON LINNÆUS

THOMAS H. HUXLEY  
JOHN TYNDALL  
ALFRED R. WALLACE  
JOHN FISKE

## EXTRA SPECIAL!

<b>The Regular Rates</b>	{	The <i>Philistine</i> , a year	\$1.00
		<i>Little Journeys</i> , a year	3.00
		One Roycroft Book	2.00
		TOTAL	<u>\$6.00</u>

*Two Dollars For All! If Subscription Is Sent Soon*

(CUT THIS ORDER OUT)

*The Philistine*, EAST AURORA, N. Y.

Enclosed find Two Dollars, and I request you to send me *The Philistine* magazine for one year, and *Little Journeys* for 1905, also the gratis Two-Dollar Roycroft Book, all as per your special offer.

Date \_\_\_\_\_

THE KEY TO BUDDHISM

# HYMNS OF THE FAITH

## (DHAMMAPADA)

Being an Ancient Anthology Preserved in the Short Collection of the Sacred Scriptures of the Buddhists. Translated from the Páli by ALBERT J. EDMUNDS. Cloth binding, gilt top. Printed on India tint paper. Pages, xiv, 110. Price, \$1.00.

"This celebrated ancient anthology of Buddhist devotional poetry was compiled from the utterances of Gotamo and his disciples; from early hymns by monks; and from the popular poetic proverbs of India. . . .

"If ever an immortal classic was produced upon the continent of Asia, it is this. Its sonorous rolls of rhythm are nothing short of inspired. No trite ephemeral songs are here, but red-hot lava from the abysses of the human soul, in one out of the two of its most historic eruptions."—*Translator's Preface.*

THE OPEN COURT PUBLISHING CO., CHICAGO, ILL.

LONDON: KEGAN PAUL, TRENCH, TRÜBNER & Co., LTD.

OSCAR L. TRIGGS  
EDITOR

MURRAY S. SCHLOSS  
MANAGING EDITOR

PARKER H. SERCOMBE  
BUSINESS MANAGER

Then slowly answered Arthur from the barge:  
The old order changeth, yielding place to new,  
And God fulfills Himself in many ways  
Lest one good custom should corrupt the world.

*Tennyson.*

## A New Monthly Magazine

# "TO-MORROW"

A monthly hand-book of the changing order  
Devoted to Educational, Political and Social Progress  
One dollar a year                      Ten cents a copy

---

Address 1926 Indiana Ave., Chicago, Ill.

### Colonial Furniture in Demand

¶Old Boston and old Gotham, as represented by several spirited individuals, had an interesting contest in bidding for old Colonial furniture at an afternoon sale of the Gilbert collection yesterday at the American Art Galleries.

¶Boston, in the person of J. J. Higginson, was the victor in every contest, and won the chief prizes of the day. But the prizes cost him a good round sum to take to his new home outside the modern Athens.

¶He gave his check calling for \$1540 for a set of 12 Heppelwhite chairs, \$255 for a drop-front desk, \$440 for a Hogarth chair settee, \$265 for a Chippendale lowboy, \$260 for a Colonial sofa and \$300 for six Colonial chairs. New England was represented also by Gov. Bulkeley of Connecticut, who gave \$2400 for a pair of Jefferson tables and \$740 for a pair of Sheraton knife urns. James Breese paid \$1020 for six Chippendale chairs originally owned by Lord Fairfax of Virginia, \$285 for six mahogany chairs, \$410 for a snap table and \$105 for a high-post bed. The total for the session was \$27,867.00.

Dec. 20, 1904

*Boston Transcript*

ALL the furniture here mentioned was made a hundred years ago by men who had the time, talent and inclination to make it well. We think that we are making by far the best

## Furniture

in America to-day. We make furniture that is an endowment investment for you—you use it and can pass it on to your heirs. It does not wear out, and like true friendship, grows better with the passing years. We have the plant, the people, the material, and the time. If you are interested, write us for cuts of our

# Aurora Colonial Designs

## THE ROYCROFTERS

*At their shop which is in East  
Aurora, Erie County, York State*

# SOME ATTRACTIVE COMBINED OFFERS

---

---

The Ice Age in North America, postpaid.....	\$ 5.30
Records of the Past.....	2.00
Bibliotheca Sacra.....	3.00
	<hr/>
	\$10.30

**All Three For \$8.00**

The Ice Age in North America, postpaid.....	\$ 5.30
Bibliotheca Sacra.....	3.00
	<hr/>
	\$ 8.30

**Both For \$6.50**

Records of the Past.....	\$ 2.00
Bibliotheca Sacra.....	3.00
	<hr/>
	\$ 5.00

**Both For \$4.00**

**The Ice Age in North America.** "This is without doubt one of the most important contributions made of late years to the literature of post-Tertiary geology." *The Athenæum* (London).

**Records of the Past.** A monthly periodical published at Washington, D. C., under the editorship of Prof. G. Frederick Wright, LL. D., F. G. S. A., with Mr. Frederick Bennett Wright as assistant, and a number of eminent consulting editors. Each number contains thirty-two quarto pages, accompanied with numerous elegant illustrations.

---

---

Remittances, strictly in advance, may be made by Money Order, New York Draft, or Registered Letter, to

**BIBLIOTHECA SACRA COMPANY**  
OBERLIN, OHIO, U. S. A.

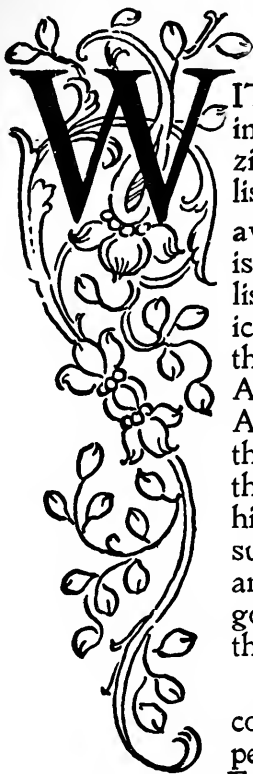

WITHIN the present year many articles of unusual importance have appeared in the English magazines. The best of these have been freshly republished in the LIVING AGE and thus made readily available to American readers. As this magazine is issued weekly, it is possible to present the English contributions almost as soon as their periodicals are received in this country. It was to meet this demand that Mr. Littell began the LIVING AGE in 1844, and today, as then, it is the only American periodical giving the leading features of the foreign press in their entirety. For this reason the magazine (still often called "Littell's") is so highly prized by those who know it best. Its subscription list includes names eminent in world and national affairs, and of plain, quiet lovers of good reading;— people everywhere who appreciate the intrinsically fine in magazine literature.

Recent numbers of the LIVING AGE have contained very important articles relating to European and American politics and affairs in the far East, accounts of recent discoveries in science, notable essays, delightful sketches of travel; the fiction has been remarkably fine—both serial and short stories; the best of the new English poetry has also been given.

In fact the weekly reader of the LIVING AGE has been able to enjoy the very best things contributed to the great English periodicals—the *Edinburgh Review* and the *Quarterly*; the *Contemporary*, *Fortnightly*, *Monthly*, and *Nineteenth Century Reviews*; *Blackwood's*, *Cornhill*, *Temple Bar*, *Longman's*, *Macmillan's* and *Pall Mall Magazines*; the *Spectator*, the *Saturday Review* and others.

If you have not availed yourself of the LIVING AGE this past year *why not subscribe for it now?* It is \$6 a year—fifty-two numbers—more than three thousand pages. With all its splendid record for over sixty years never has it been more valuable than it will be for **1905**.

Special offer: A trial subscription three months, thirteen numbers, for one dollar.

Address

**THE LIVING AGE CO., 13½ Bromfield Street, Boston,**

# The Gods of the Egyptians

OR

## Studies in Egyptian Mythology

BY

E. A. WALLIS BUDGE, M. A., Litt. D., D. Lit.

KEEPER OF THE EGYPTIAN AND ASSYRIAN ANTIQUITIES  
IN THE BRITISH MUSEUM

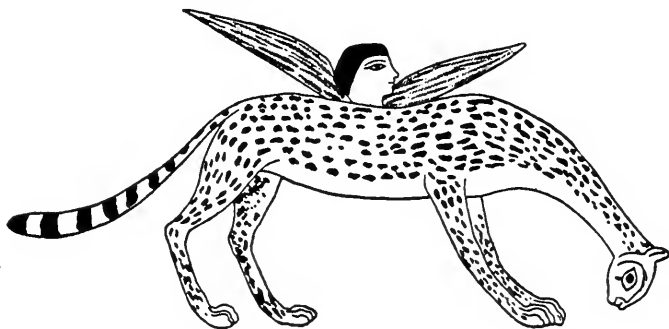

A Description of the Egyptian Pantheon based upon original research; methodical, thorough, and up-to-date in every respect.

It is unique, and the probability is that the work will soon become rare.

The original edition consisted of 1500 copies, but a disastrous fire in the bindery destroyed 500 of them, thus limiting the edition to 1000 copies. As the color plates were printed at great cost by lithographic process, and the drawings on the stones immediately after destroyed, there is scarcely any probability of replacing the lost copies by a new edition.

It is published in two volumes, containing, 988 pages, (Volume I, 548 pages; Volume II, 440 pages), and is richly illustrated with 98 colored plates, averaging eight impressions each, and 131 specially prepared illustrations in the text.

**Two Volumes, Royal Octavo, Library Binding, Price \$20.00 Net.**

The author discusses the worship of spirits, demons, gods and other supernatural beings in Egypt from the Predynastic Period to the time of the introduction of Christianity into the country. Full use has been made of the results of recent investigations and discoveries, whereby it has been found possible to elucidate a large number of fundamental facts connected with the various stages of religious thought in ancient Egypt, and to assign to them their true position chronologically. The ancient Libyan cult of the man-god Osiris, with its doctrines of resurrection and immortality, is described at length, and the solar cults, i. e., those of Rā, Āmen, Āten, etc., are fully treated; an interesting feature of the book will be the Chapters on the Egyptian Underworld and its inhabitants.

---

---

## The Open Court Publishing Co.

324 Dearborn Street, Chicago

ARTICLES BY  
**MONCURE D. CONWAY**

Published in **THE OPEN COURT**

---

---

Chats with a Chimpanzee, in 6 parts, at  
25 cents each.

Jephthah's Daughter at Honolulu

Unitarianism and its Grandchildren

Agnosticism

The International Council of Women

The Nineteenth Century Club and its  
Founder

The Founding of Our Religious Freedom

The Spiritualists' Confession

The Recantation of Councillor Carter, of  
Virginia

A Dragon Hunt in the Riviera

Some American Thoughts on the French  
Exposition

A Festival of Faith at Plymouth

The Transient and the Permanent in  
Theodore Parker

The Teachings of Theodore Parker

Theodore Parker's Optimism

The Religion of George Washington

Adventures of Two Hymns: "Nearer My  
God to Thee" and "Lead, Kindly  
Light"

The Mythical and Mystical Shrine of  
Agnes

St. Anthony's Day

Charles Bradlaugh

Bambino-Worship at Rome

Cardinal Newman

From My Roman Note-Book

The Samaritan on Change

Thomas Paine

Communal Ethics

The Story of the Declaration of Inde-  
pendence

The Prince of Wales

Teeth Set on Edge in "The Atlantic  
Monthly"

Civilising the Sabbath

Our St. George of the Theatre

Oracles of Reason and Revolutions

Ethan Allen's Oracles of Reason

Paine-Condorcet Declaration of Rights

Tennyson's Pilgrimage

The Saint of New York

Walt Whitman

The Mother of Washington

Mothers and Sons of Gods

Liberty. A Historical Study

Story of an Old London Society

An Early Society for Political Inquiries

The Parisian Buddha

Christening in Cyprus

Huxley, a Discourse

James Martineau

Adventures of a Parable

A Sermon that Made History

The First French Socialist

The Evolution of Evolution

The Centenary of Theophilanthropy

The Idol and the Ideal of the French  
Republic

The International Arbitration Alliance

An Address Read Before The Peace Con-  
gress, Paris, 1900

Ethical Culture Versus Ethical Cult

Our Golden-Rule Treaty with China, and  
our Missionaries

---

---

The numbers of The Open Court containing these articles will  
be supplied at 25 cents each.

---

---

**THE OPEN COURT PUBLISHING CO.**  
P. O. DRAWER F, CHICAGO

A BOOK ON COMPARATIVE FOLK-LORE

BY

MONCURE D. CONWAY

---

---

SOLOMON and SOLOMONIC LITERATURE. By Moncure D. Conway

Pp. VIII, 243. Bound in red cloth. Price \$1.50 (6s). Portrays the entire evolution of the Solomonic legend in the history of Judaism, Christianity, Hinduism, Buddhism and Parseeism, and also in ancient and modern folk-lore, taking up for example the legend of Solomon's ring, Solomon's seal, etc., etc.

---

---

In the development and spread of that vast body of universal folk-lore known as the Solomonic legends, Mr. Conway believes that there are two distinct streams of evolution; one issuing from the wisdom books of the Bible, the other from law books. These two streams "are clearly traceable in their collisions, their periods of parallelism, and their convergence,—where, however, their respective inspirations continue distinguishable, like the waters of the Missouri and the Mississippi after they flow between the same banks." He continues: "The present essays by no means claim to have fully traced these lines of evolution, but aim at their indication. The only critique to which it pretends is literary. The studies and experiences of many years have left me without any bias concerning the contents of the Bible, or any belief, ethical or religious, that that can be affected by the fate of any scripture under the higher or other criticism. But my interest in Biblical literature has increased with the preception of its composite character ethnically. I believe that I have made a few discoveries in it; and a volume adopted as an educational textbook requires every ray of light which any man feels able to contribute to its interpretation."

---

---

"A thoughtful, interesting and scholarly study."—Pittsburgh Times.

"Full of curious lore."—Manchester Guardian.

"Mr. Conway's book on Solomonic literature is precisely such a work as we should expect from the author of 'Sacred Anthology.' The logic is everywhere blazed with the poetry of Mr. Conway's nature. There are frequent passages of great eloquence.—Unity

---

---

THE OPEN COURT PUBLISHING CO.

P. O. DRAWER F, CHICAGO